



U  
S

# OWNER'S/OPERATOR'S MANUAL

## HEDGE TRIMMER

**HTZ2460  
HTZ2460L  
CHTZ2460  
CHTZ2460L**

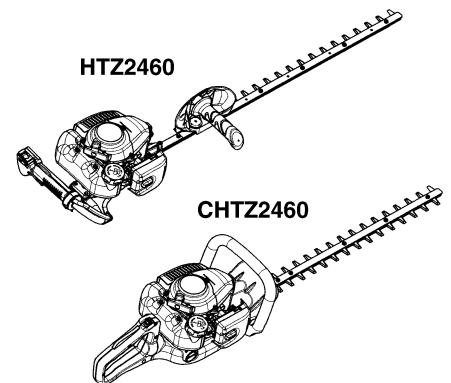

### **! WARNING !**

The engine exhaust from this product contains chemicals known to the State of California to cause cancer, birth defects or other reproductive harm.

### **! WARNING !**

Before using our products, please read this manual carefully to understand the proper use of your unit.

This spark ignition system complies with the Canadian standard ICES-002.

## SAFETY FIRST

Instructions contained in warnings within this manual marked with a  symbol concern critical points which must be taken into consideration to prevent possible serious bodily injury, and for this reason you are requested to read all such instructions carefully and follow them without fail.

### ■ WARNINGS IN THE MANUAL



#### WARNING

This mark indicates instructions which must be followed in order to prevent accidents which could lead to serious bodily injury or death.

#### IMPORTANT

This mark indicates instructions which must be followed, or it leads to mechanical failure, breakdown, or damage.

#### NOTE

This mark indicates hints or directions useful in the use of the product.

## **Contents**

---

1. Parts location .....	3
2. Specifications .....	3
3. Warning labels on the machine .....	4
4. Symbols on the machine .....	4
5. For safe operation .....	5
6. Fuel.....	8
7. Operation.....	10
8. Maintenance .....	12
9. Storage .....	15
10. Disposal.....	15
11. Troubleshooting guide .....	15

## 1. Parts location

HTZ2460  
HTZ2460L

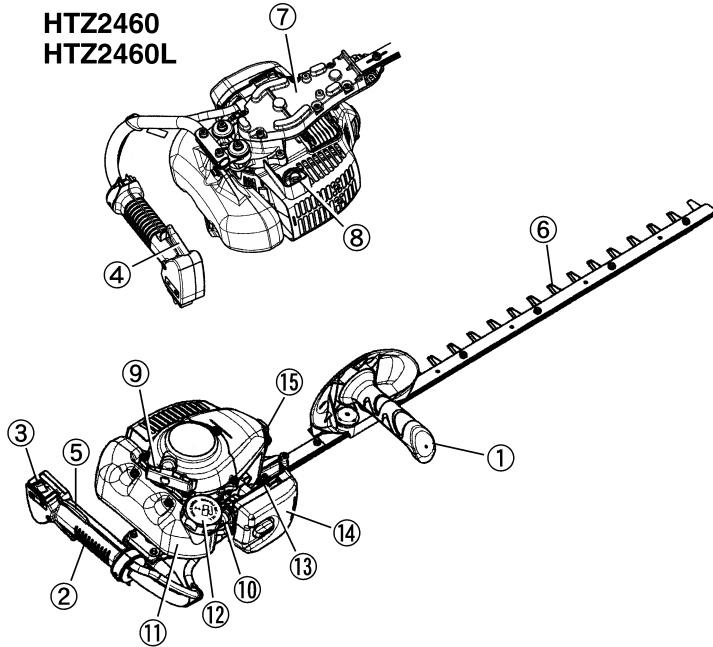

CHTZ2460  
CHTZ2460L

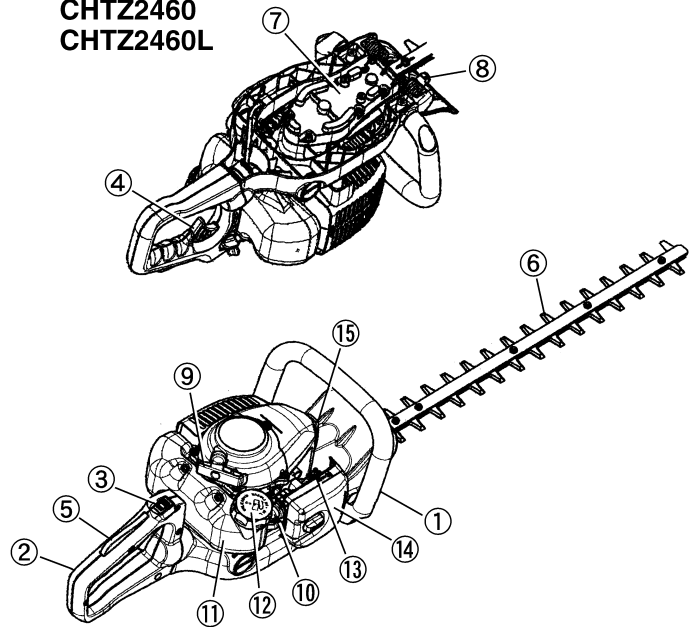

- |                    |                       |
|--------------------|-----------------------|
| 1. Front handle    | 9. Starter knob       |
| 2. Rear handle     | 10. Primer pump       |
| 3. Ignition switch | 11. Fuel tank         |
| 4. Throttle lever  | 12. Fuel tank cap     |
| 5. Safety lock     | 13. Choke lever       |
| 6. Blade           | 14. Air cleaner cover |
| 7. Gear case       | 15. Spark plug cap    |
| 8. Spark arrester  |                       |

## 2. Specifications

Model	HTZ2460	HTZ2460L	CHTZ2460	CHTZ2460L
Type	Reciprocating single-sided dual blades		Reciprocating double-sided dual blades	
Dry weight	5.8(kg)/12.6(lbs)	6.4(kg)/14.1(lbs)	5.8(kg)/12.8(lbs)	6.0(kg)/13.2(lbs)
Blade size	750(mm)/30(in)	1080(mm)/42.5(in)	600(mm)/24(in)	750(mm)/30(in)
Blade pitch	35(mm)/1.38(in)	34(mm)/1.34(in)	35(mm)/1.38(in)	
Transmission	Centrifugal clutch, Cam-crank			
Reduction ratio	4.5			
Engine	Type	Air-cooled 2-stroke gasoline		
	Mode	GZ23N		
	Displacement	23.6(cm <sup>3</sup> )/1.44(cu-in)		
	Max. output	1.15Hp(0.85kW)/8000min <sup>-1</sup> (rpm)		
	Idle speed	3000±200/min <sup>-1</sup> (rpm)		
	Fuel	mixture(Gasoline 50 : Oil 1)(when using RedMax genuine oil)		
Carburetor	Walbro Diaphragm type			
Spark plug	NGK CMR7H			
Fuel tank capacity	0.47(litter)/15.9(fl.oz)			
Durability period	300(hrs.)			

Specifications are subject to change without notice.

### 3. Warning labels on the machine

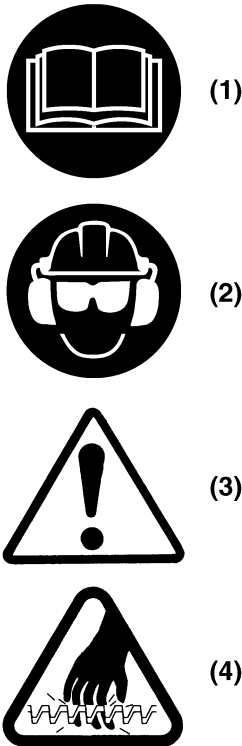

- (1) Read owner's manual before operating this machine.
- (2) Wear head, eye and ear protection.
- (3) Handling this machine improperly could result in accidents causing serious injury or death. Read this manual carefully and practice using the hedge-trimmer until you are fully acquainted with all operations and have learned to use it correctly.
- (4) This is extremely sharp and can easily cause cuts.

**! IMPORTANT**

If warning label peel off or become soiled and impossible to read, you should contact the dealer from which you purchased the product to order new labels and affix them in the required location(s).

**! WARNING**

Never modify your machine.  
We won't warrant the machine, if you use the remodeled hedge-trimmer or you don't observe the proper usage written in the manual.

### 4. Symbols on the machine

For safe operation and maintenance, symbols are carved in relief on the machine. According to these indications, please be careful not to take a mistake.



(a)

(a) The port to refuel the "MIX GASOLINE"  
**Position:**  
FUEL TANK CAP



(b)

(b) The direction to close the choke  
**Position:**  
AIR CLEANER COVER



(c)

(c) The direction to open the choke  
**Position:**  
AIR CLEANER COVER

**■ EMISSION CONTROL**

An emission control label is located on the engine.



\*1: The year will be changed every year of manufacturing.  
\*2: The initial will be changed every year of manufacturing.  
\*3: SP : Sealed tank made of HDPE or PE.

## ▲ 5. For safe operation



1. THIS MACHINE CAN CAUSE SERIOUS INJURIES. Read this manual carefully until you completely understand and follow all safety and operating instructions. Also, know how to stop the machine quickly in an emergency.
2. Keep this manual handy so that you may refer to it later whenever any questions arise. Also note, if you have any questions which cannot be answered herein, contact the dealer from whom you purchased the product.
3. Always be sure to include this manual when selling, lending, or otherwise transferring the ownership of this product.
4. Never allow children or anyone unable to fully understand the directions given in the manual to use the machine.



### ■ WORKING CONDITION

1. When using the product, you should wear proper clothing and protective equipment.

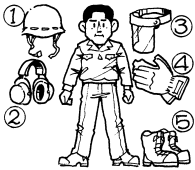

- (1) Helmet
- (2) Ear protectors
- (3) Protection goggles or face protector
- (4) Thick work gloves
- (5) Non-slip-sole work boots

2. And you should carry with you.

- (1) Attached tools
- (2) Properly reserved fuel
- (3) Spare blade
- (4) Things to notify your working area (rope, warning signs)
- (5) Whistle (for collaboration or emergency)
- (6) Hatchet or saw (for removal of obstacles)
- (7) First-aid kit



3. Do not wear loose clothing, jewelry, short trousers, sandals, or go barefoot. Do not wear anything which might be caught by a moving part of the unit. Secure hair so it is above shoulder length.

### ■ WORKING CIRCUMSTANCE

1. Never start the engine inside a closed room or building. Exhaust gases contain dangerous carbon monoxide.
2. Never use the product,
  - a. when the ground is slippery or when you can't maintain a steady posture.
  - b. At night, at times of heavy fog, or at any

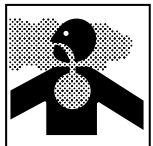

- other times when your field of vision might be limited and it would be difficult to gain a clear view of the working area.
- c. During rain, during storms at times of strong or gale-force winds, or at any other times when weather conditions might make it unsafe to use the product.

### ■ WORKING PLAN

1. You should never use the product when under the influence of alcohol, when suffering from exhaustion or lack of sleep, when suffering from drowsiness as a result of having taken cold medicine or at any other time when a possibility exists that your judgment might be impaired or that you might not be able to operate the product properly and in a safe manner.
2. When planning your work schedule, allow plenty of time to rest. Limit the amount of time over which the product is to be used continuously to somewhere around 30 ~ 40 minutes per session, and take 10 ~ 20 minutes of rest between work sessions. Also try to keep the total amount of work performed in a single day under 2 hours or less.



### ▲ WARNING

1. If you don't observe the working time, or working manner (See "USING THE PRODUCT"), Repetitive Stress Injury (RSI) could occur.

If you feel discomfort, redness and swelling of your fingers or any other part of your body, see a doctor before getting worse.

2. To avoid noise complaints, in general, operate product between 8 a.m. and 5 p.m. on weekdays and 9 a.m. to 5 p.m. on weekends.



### NOTE

Check and follow the local regulations as to sound level and hours of operations for the product.

### ■ BEFORE STARTING THE ENGINE

1. The area within a perimeter of 15 m (50 ft) of the person using the product should be considered a hazardous area into which no one should enter. If necessary, yellow warning rope, warning signs should be placed around the perimeter of the area. When work is to be performed simultaneously by two or more persons,



## **▲ 5. For safe operation**

care should also be taken to constantly look around or otherwise check for the presence and locations of other people working so as to maintain a distance between each person sufficient to ensure safety.

2. Check the condition of working area to avoid any accident by hitting hidden obstacles such as stumps, stones, cans, or broken glass.

### **! IMPORTANT**

Remove any obstacle before beginning work.

3. Inspect the entire unit for loose fasteners and fuel leakage. Make sure that the cutting attachment is properly installed and securely fastened.

### **■ STARTING THE ENGINE**

1. Keep bystanders especially children, and animals at least 15 m (50 ft) away from the operating point. If you are approached, immediately stop the engine.
2. The product is equipped with a centrifugal clutch mechanism, so the cutting attachment begins to move as soon as the engine is started by putting the throttle into the start position. When starting the engine, place the product onto the ground in a flat clear area and hold it firmly in place so as to ensure that neither the cutting part nor the throttle come into contact with any obstacle when the engine starts.

### **▲ WARNING**

- **Never place the throttle into the high-speed position when starting the engine.**
- **Never start the engine at the cutting attachment side.**

3. After starting the engine, check to make sure that the cutting attachment stops moving when the throttle is moved fully back to its original position. If it continues to move even after the throttle has been moved fully back, turn off the engine and take the unit to your authorized RedMax servicing dealer for repair.

### **■ USING THE PRODUCT**

### **! IMPORTANT**

Cut only materials recommended by the

**manufacturer. And use only for tasks explained in the manual.**

1. Grip the handles firmly with both hands using your whole hand. Place your feet slightly apart (slightly further apart than the width of your shoulders) so that your weight is distributed evenly across both legs, and always be sure to maintain a steady, even posture while working.
2. Maintain the speed of the engine at the level required to perform cutting work, and never raise the speed of the engine above the level necessary.
3. If the unit starts to shake or vibrate, turn off the engine and check the whole unit. Do not use it until the trouble has been properly corrected.
4. Keep all parts of your body away from moving cutting attachment and hot surfaces.
5. Never touch the muffler, spark plug, or other metallic parts of the engine while the engine is in operation or immediately after shutting down the engine. Doing so could result in serious burns or electrical shock.
6. While operating the machine be always sure of a safe and secure operating position especially when using steps or a ladder.



### **• IF SOMEONE COMES**

1. Guard against hazardous situations at all times. Warn adults to keep pets and children away from the area. Be careful if you are approached. Injury may result from flying debris.
2. If someone calls out or otherwise interrupts you while working, always be sure to turn off the engine before turning around.

### **■ MAINTENANCE**

1. In order to maintain your product in proper working order, perform the maintenance and checking operations described in the manual at regular intervals.
2. Always be sure to turn off the engine before performing any maintenance, checking procedures or working on the machine.

### **(1) Check ok!**

### **▲ WARNING**

**The metallic parts reach high temperatures immediately after stopping the engine.**



## **▲ 5. For safe operation**

3. When replacing the cutting attachment or any other part, or when replacing the oil or any lubricant, always be sure to **use only RedMax products or products which have been certified by RedMax for use with the RedMax product.**
4. In the event that any part must be replaced or any maintenance or repair work not described in this manual must be performed, please contact a representative from the store nearest RedMax authorized servicing dealer for assistance.
5. Do not use any accessory or attachment other than those bearing the RedMax mark and recommended for the unit.
6. Under no circumstances should you ever take apart the product or alter it in any way. Doing so might result in the product becoming damaged during operation or the product becoming unable to operate properly.

If doing so, fuel might leak from the tank during transport.

### **■ HANDLING FUEL**

1. The engine of the RedMax product is designed to run on a mixed fuel, which contains highly flammable gasoline. Never store cans of fuel or refill the tank of the unit in any place where there is a boiler, stove, wood fire, electrical sparks, welding sparks, or any other source of heat or fire which might ignite the fuel.
2. Never smoke while operating the unit or refilling its fuel tank.
3. When refilling the tank, always turn off the engine and allow it to cool down. Take a careful look around to make sure that there are no sparks or open flames anywhere nearby before refueling.

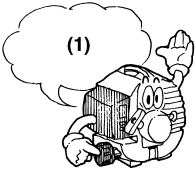

#### **(1) Refill after cooling the engine.**

4. Wipe spilled fuel completely using a dry rag if any fuel spillage occurs during refueling.
5. After refueling, screw the fuel cap back tightly onto the fuel tank and then carry the unit to a spot 3 m or more away from where it was refueled before turning on the engine.
6. Do not inhale fuel fumes as they are toxic.

### **■ TRANSPORTATION**

1. When hand-carrying the product, cover over the cutting part if necessary, lift up the product and carry it paying attention to the blade.
2. Never transport the product over rough roads over long distances by vehicle without removing all fuel from the fuel tank.

## 6. Fuel

### FUEL

#### ⚠ WARNING

- Gasoline is very flammable. Avoid smoking or bringing any flame or sparks near fuel. Make sure to stop the engine and allow it cool before refueling the unit. Select outdoor bare ground for fueling and move at least 10 ft (3 m) away from the fueling point before starting the engine.



#### ■ GASOLINE REQUIREMENTS

- All 2-Stroke RedMax Products are powered by RedMax Professional-Commercial Duty, Hi-Performance, Hi-RPM, Air Cooled 2-Stroke engines. RedMax – Hi-Performance 2-stroke engines produce higher HP outputs as compared to standard Home Owner Duty or Light Commercial Duty production engines offered by most manufacturers.
- Exhaust emission are controlled by the fundamental engine parameters and components (eq., carburation, ignition timing and port timing) without addition of any major hardware or the introduction of an inert material during combustion.
- The RedMax Engines are registered and certified with CARB (California Air Resources Board) and EPA (Environmental Protection Agency) to operate on CLEAN Mid-grade 89 octane or Premium, unleaded (lead-free) gasoline and RedMax Air-Cooled "Max Life", Synthetic blend Premium two-stroke engine oil mixed at 50:1 ratio.
- Unleaded gasoline is recommended to reduce the contamination of the air for the sake of your health and the environment.
- This Hi-Performance Air Cooled 2-stroke Engine requires the use of **Minimum** 89 Octane  $\left[ \frac{R+M}{2} \right]$  (Mid grade or Premium) clean gasoline. Gasoline may contain maximum of 10% Ethanol (grain alcohol) or up to 15% MTBE (Methyl tertiary-butyl ether). Gasoline containing Methanol (Wood Alcohol) is **NOT** approved.

#### 📖 NOTE

- If octane rating of the Mid Grade gasoline in your area is lower than 89 Octane use Premium Unleaded Gasoline. The majority of all 2-stroke engine manufacturers in the USA and Canada recommend using gasoline with 89 Octane or higher.

#### ⚠ WARNING

- Gasoline with an octane rating lower than 89 will greatly increase the engines operating temperature. Low octane gasoline will cause detonation (knock) resulting in piston seizures and major internal engine components damage.
- Poor quality gasolines or oils may damage sealing rings, fuel

lines or fuel tank of the engine.

#### 📖 NOTE

- Failures caused by operating engines on gasoline with octane rating lower than 89 are not covered by the RedMax Two-Stroke engine warranty.

#### ⚠ WARNING

- Alternative Fuels (Not Gasoline)**  
Alternative fuels, such as E-15 (15% ethanol), E-20 (20% ethanol), E-85 (85% ethanol) are **NOT** classified as gasoline and are **NOT** approved for use in RedMax 2-stroke gasoline engines. Use of alternative fuels will cause major engine performance and durability problems such as: improper clutch engagements, overheating, vapor lock, power loss, lubrication deficiency, deterioration of fuel lines, gaskets and internal carburetor components, etc... Alternative fuels cause high moisture absorption into the fuel/oil mixture leading to oil and fuel separation.

#### ■ OIL REQUIREMENTS

- Use only RedMax "Max Life", Synthetic blend Premium Air-Cooled two-stroke engine oil or oil certified to ISO-L-**EGD** (ISO/CD1378) standard AND one that is JASO-FD registered. RedMax Air-Cooled "Max Life", Synthetic blend Premium two stroke engine oil and ISO-L-**EGD** (ISO/CD1378) AND JASO-**FD** oils are fully compatible with gasoline's containing 10% Ethanol. RedMax Air-Cooled "Max Life", Synthetic blend Premium two stroke engine oil and ISO-L-**EGD** (ISO/CD1378) AND JASO-**FD** oils are **Universal** and should be mixed at 50:1 ratio for all 2 stroke air cooled engines sold in the past regardless of mixing ratios specified in those manuals.
- If the oil is registered with JASO, the JASO Logo with **FD** and registration number will be displayed on the container. The highest JASO rating is "FD", which equals the ISO-L-**EGD** rating. Lower ratings are "FC", "FB", and "FA".



- Engine problems due to inadequate lubrication caused by failure to use ISO-L-**EGD** certified and JASO **FD** registered oil such as "MaxLife", RedMax Synthetic blend Premium 2-stroke oil **WILL VOID THE REDMAX TWO-STROKE ENGINE WARRANTY.**

#### ⚠ WARNING

- Do not use NMMA (National Marine Manufacturers Association), BIA (Boating Industry Association), and TCW (two cycle water cooled) oils designed for MoPeds or Outboard, water cooled Marine Engines. Do not use API (American Petroleum Institute), TC (Two Cycle) labeled oils. The API-TC



## 6. Fuel

test standard has been discontinued by API in 1995 and it no longer exists.

### IMPORTANT

#### Gasoline/Oil mixture Storage Recommendations

Store your gasoline or gasoline/oil mixture in a cool dry area in a tightly sealed approved container to limit the entry of moisture and additional air (oxygen). Moisture and air cause the development of varnish and gum, making the fuel stale. Stored gasoline and gasoline/oil mixture ages and loses its octane rating and volatility. Do not mix more gasoline/oil than you intend to use in 30 days, and 60 days when fuel stabilizer is added. RedMax Air-Cooled "Max Life" Synthetic blend Premium two-stroke engine oil "**Contains fuel stabilizer**" and will automatically extend your gasoline/oil mixture life up to 60 days.

#### HOW TO MIX FUEL

##### RECOMMENDED MIXING RATIO

##### GASOLINE 50 : OIL 1

(when using RedMax Air-Cooled "Max Life")

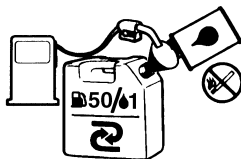

50:1 MIXING CHART

GASOLINE	gal.	1	2	3	4	5
2-CYCLE OIL	fl.oz	2.6	5.2	7.8	10.4	13

GASOLINE	liter	1	2	3	4	5
2-CYCLE OIL	ml	20	40	60	80	100

### WARNING

#### Pay attention to agitation.

1. Measure out the quantities of gasoline and oil to be mixed.
2. Put some of the gasoline into a clean, approved fuel container.
3. Pour in all of the oil and agitate well for 10seconds.
4. Pour in the rest of gasoline and agitate again for at least one minute. As some oils may be difficult to agitate depending on oil ingredients, sufficient agitation is necessary. Be careful that, if the agitation is insufficient, there is an increased danger of early piston seizure due to abnormally lean mixture.
5. Place a clear indication on the outside of the container to avoid mixing up with gasoline or other containers that dont contain oil.
6. Indicate the contents on outside of container for easy identification.

#### FUELING THE UNIT

1. Untwist and remove the fuel cap. Rest the cap on a clean surface.
2. Put fuel into the fuel tank to 80% of the full capacity.
3. Fasten the fuel cap securely and wipe up any fuel spillage around the unit.

### WARNING

1. Select flat and bare ground for fueling.
2. Move at least 10 feet (3 meters) away from the fueling point before starting the engine.
3. Stop the engine before refueling the unit. At that time, be sure to sufficiently agitate the mixed gasoline in the container.

#### FOR YOUR ENGINE LIFE, AVOID

1. FUEL WITH NO OIL (RAW GASOLINE) – It will cause severe damage to the internal engine parts very quickly.
2. GASOHOL – It can cause deterioration of rubber and/or plastic parts and disruption of engine lubrication.
3. OIL FOR 4-CYCLE ENGINE USE – It can cause spark plug fouling, exhaust port blocking, or piston ring seizure.
4. **Mixed fuels which have been left unused for a period of one month or more** may clog the carburetor and result in the engine failing to operate properly.
5. In the case of storing the product for a long period of time, clean the fuel tank after rendering it empty. Next, Start the engine and run the carburetor dry residual fuel.
6. In the case of scrapping the used mixed oil container, scrap it only at an authorized depository site.

### NOTE

- As for details of quality assurance, read the description in the section Limited Warranty carefully. Moreover, normal wear and change in product with no functional influence are not covered by the warranty. Also, be careful that, if the usage in the instruction manual is not observed as to the mixed gasoline, type of oil or fuel to be used. described therein, it may not be covered by the warranty.

## 7. Operation

### ■ STARTING ENGINE

#### ⚠ WARNING

- The cutting head will start moving upon the engine starts.

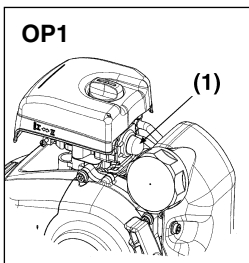

1. Feed fuel into the fuel tank and tighten the cap securely.
2. Rest the unit on a flat, firm place. Keep the cutting head off the ground and clear of surrounding objects as it will start moving upon starting of the engine.
3. Push the primer pump several times until overflow fuel flows out in the clear tube. (OP1)

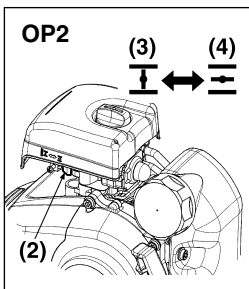

4. When the engine is cool, move the choke lever to the closed position. (OP2)

- (1) primer pump  
(2) choke lever  
(3) close  
(4) open  
(5) ignition switch  
(6) RUN  
(7) STOP  
(8) throttle lever

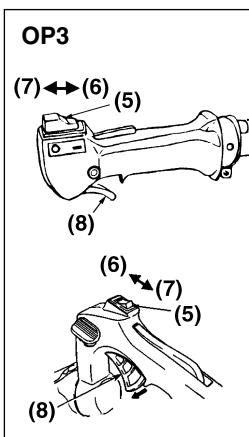

5. Set the ignition switch to the "RUN" position. Release the throttle lever and make sure it is fully back. (OP3)
6. While holding the unit firmly, pull out the starter rope quickly until engine fires. (OP4)

#### ⚠ IMPORTANT

- Avoid pulling the rope to its end or returning it by releasing the knob. Such actions can cause starter failures.

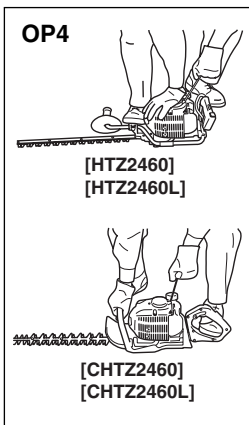

7. Move the choke lever to the open position. And pull out the starter rope quickly to restart engine.
8. Allow the engine to warm up for a several minutes before starting operation.

#### 📖 NOTE

1. When restarting the engine immediately after stopping it, leave the choke open.
2. Overchoking can make the engine hard to start due to excess fuel. When the engine failed to start after several attempts, open the choke and repeat

pulling the rope, or remove the spark plug and dry it.

### ■ STOPPING ENGINE (OP3)

1. Release the throttle lever and run the engine for a half minute.
2. Shift the ignition switch to the "STOP" position.

#### ⚠ IMPORTANT

- Except for an emergency, avoid stopping the engine while pulling the throttle lever.

#### 📖 NOTE

- If the engine won't stop when setting the ignition switch to the stop position, close the choke lever and stop the engine.  
In this case, please repair the machine at your nearest servicing dealer.

### ■ RUNNING IN THE ENGINE

#### ⚠ IMPORTANT

- During the first 20 working hours, do not use the hedge-trimmer at maximum power for long periods.

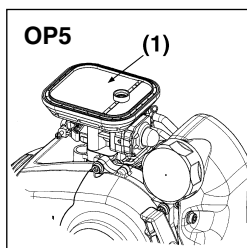

### ■ ADJUSTING IDLING SPEED

- Before adjusting the carburetor, clean the air filter and warm up the engine. (OP5)

- (1) air filter

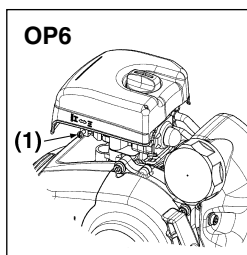

- Idle screw is adjusted in order to ensure a good safety margin between idle running and clutch engagement. (OP6)

- (1) Idle screw

#### ⚠ WARNING

- With the engine idling (3000 rpm), the blade should not move. We recommend that you have the dealer or an authorised mechanic carry out any carburetor adjustments.

#### ⚠ WARNING

- Weather conditions and altitude may effect carburation.

## 7. Operation

- Do not allow anyone to stay close to the hedge-trimmer while working or while adjusting the carburetor.

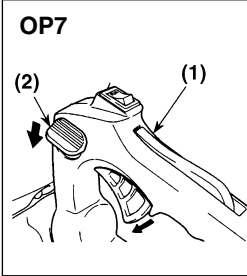

### ■ HOW TO USE

#### HANDLE (CHTZ2460/CHTZ2460L only)

To reduce fatigue when trimming hedges, the handle can be swivelled through 90° to the left or right. (OP7, OP8).

**Do not press the throttle during this operation !**

#### Proceed as follows:

- Free the handle by pressing the locking lever; (OP7)
- Turn the handle until the locking lever clicks into place;
- When the handle is locked in its new position, you can apply the throttle again.

(1) handle

(2) locking lever

You can swivel the handle even with the engine idling because the hedge-trimmer is equipped with a blade brake that maintains the blades at a standstill.

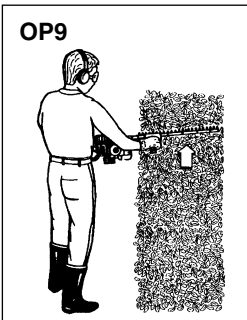
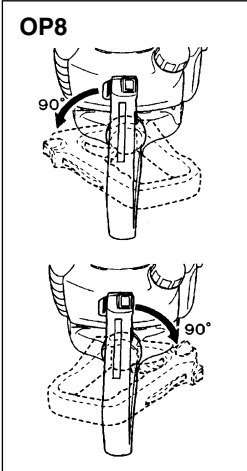

### ■ HEDGE TRIMMING TECHNIQUES

Trim sides of a hedge first, and then the top.

#### Vertical cut:

- With the single-sided blade hedge-trimmer, model HTZ2460/HTZ2460L always cut from the bottom up (OP9).



- With the 2-sided blade model CHTZ2460/CHTZ2460L use an arcing cut from the bottom upwards, then downwards to use both sides of the blades (OP10).

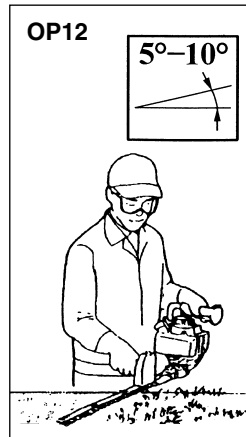
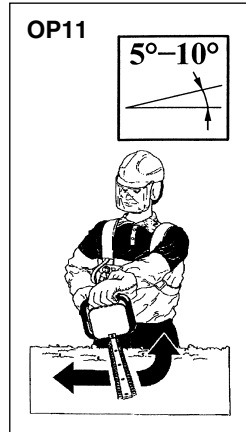

#### Horizontal cut:

- In order to get the best cutting results, slightly tilt the blade (5°–10°) towards the cutting direction (OP11, OP12). Cut slowly, specially with thick hedges.

### ⚠ WARNING

Always follow the safety precautions.

- The hedge-trimmer must only be used to trim hedges or small bushes. It is forbidden to cut other types of material. Do not use the hedge-trimmer as a lever to lift, move or break objects, nor lock it on fixed supports. It is forbidden to apply tools or applications that are not the ones indicated by the manufacturer onto the hedge-trimmer's power take-off. Do not use it for pruning trees or cutting grass.
- Use only as much throttle as is needed to do the job. Excessive engine speed is unnecessary.
- Avoid cutting thick branches, for which will damage the blades and shorten the life of drive systems.
- Always keep your body to the carburetor side of your trimmer, never on the muffler side.
- When a new machine is first operated, in the first few minutes grease may come out of the gear case. But, since this is excess grease, there is no cause for alarm. Just wipe it off with the engine stopped for next use.
- Always remember that the TIP of the line does cutting. You will achieve better results by not crowding the line into the cutting area. Allow the unit to trim at its own pace.

## 8. Maintenance

Maintenance, replacement, or repair of the emission control device and systems may be performed by any non-road engine repair establishment or individual.

### ■ MAINTENANCE CHART

	System/components	Procedure	Before use	Every 25 hours after	Every 50 hours after	Every 100 hours after	Note
ENGINE	fuel leaks, fuel spillage	wipe out	✓				
	fuel tank, air filter, fuel filter	inspect/clean	✓	✓			replace, if necessary
	idle adjusting screw	see adjusting idling speed	✓				replace carburetor if necessary
	spark plug	clean and readjust plug gap			✓		GAP : .026 in (0.65 mm) replace, if necessary
	cylinder fins, intake air cooling vent	clean		✓			
	muffler, spark arrester, cylinder exhaust port	clean				✓	
TRIMMER	throttle lever, ignition switch	check operation	✓				
	cutting parts	replace if something's wrong	✓				
	gear case	grease			✓		
	screws/nuts/bolts	tighten/replace	✓			✓	not adjusting screws
	debris guard	make sure to attach	✓				

### ⚠ WARNING

- Make sure that the engine has stopped and is cool before performing any service to the machine. Contact with moving cutting head or hot muffler may result in a personal injury.

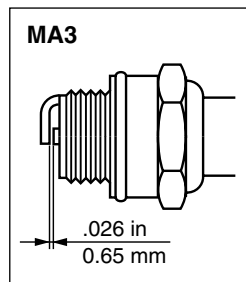

- REPLACEMENT PLUG IS NGK CMR7H OR CHAMPION RZ7C.

### ⚠ IMPORTANT

- Note that using any spark plug other than those designated may result in the engine failing to operate properly or in the engine becoming overheated and damaged.
- To install the spark plug, first turn the plug until it is finger tight, then tighten it a quarter turn more with a socket wrench.

### TIGHTENING TORQUE:

**87~121 in-lbs**  
**(9.8~13.7 N.m.)**

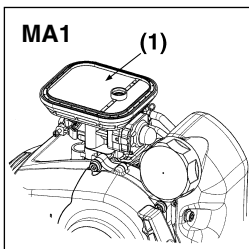

### ■ AIR FILTER

- The air filter, if clogged, will reduce the engine performance. Check and clean the filter element. If the element is broken or clogged, replace with a new one. (MA1)

(1) air filter

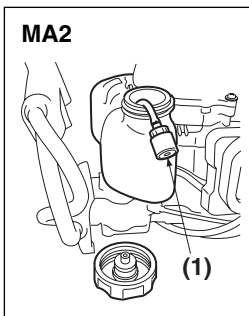

### ■ FUEL FILTER

- When the engine runs short of fuel supply, check the fuel cap and the fuel filter for blockage. (MA2)

(1) fuel filter

### ■ SPARK PLUG

- Starting failure and mis-firing are often caused by a fouled spark plug. Clean the spark plug and check that the plug gap is in the correct range. For a replacement plug, use the correct type specified by RedMax. (MA3)

### ■ INTAKE AIR COOLING VENT

### ⚠ WARNING

- Never touch the cylinder, muffler, or spark plugs with your bare hands immediately after stopping the engine. The engine can become very hot when in operation, and doing so could result in severe burns.

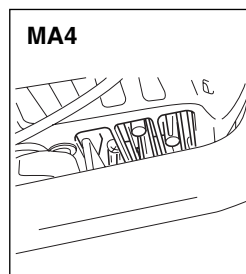

- Clean the cylinder fins with compressed air or a brush. (MA4)

## 8. Maintenance

### ! IMPORTANT

- If waste gets stuck and causes blockage around the intake air cooling vent or between the cylinder fins, it may cause the engine to overheat, and that in turn may cause mechanical failure on the part of the hedge-trimmer.

### ■ BLADES

Oil blades each gas tank filling (MA5).

### ! WARNING

- **Make sure that the blade bolts are well tightened.**
- **The blade assembly is designed to automatically compensate for any play between the blades.**

Check the cutting edges and reform with a flat file. (MA6)

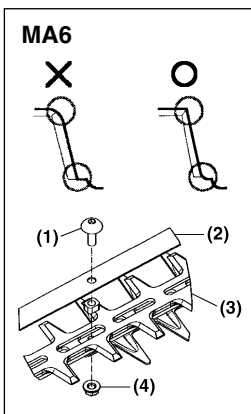
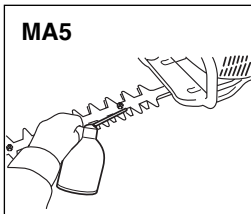

### Point :

1. Keep the end corner sharp.
2. Round the root of the edge.
3. Do not use water when using a grinder.

### ! IMPORTANT

- When mounting the blade, make sure to fasten the spacer, washer and bolt, then fasten the nut.

- (1) Bolt  
(2) Plate  
(3) Spacer  
(4) Nut

### ■ SHARPENING (MA7)

Always keep the file or sharpener at an angle of 45° to the blade, and:

- Always grind in the direction of the cutting edge;
- Note: files cut only in one direction; lift the file from the blade when returning to start a new pass;
- Remove all burr from the edge of the blade with a slip stone;
- Remove as little material as possible;
- Before refitting the sharpened blades, remove filings and then apply grease.

Do not try to sharpen a damaged blade: change it or take it to a Service dealer.

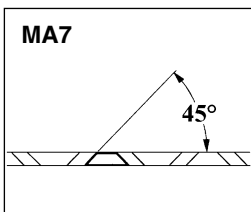

### ■ SAFETY LOCK (MA8)

### ! WARNING

- **Stop operation when the safety lock is defective.**
  - Safety lock is the device not to accelerate the throttle lever without intention. While pushing the safety lock, you can accelerate the throttle lever.
1. Check if the throttle lever does not move when you do not push the safety lock.
  2. Check if the throttle lever moves when you grasp or release it while pushing the safety lock.
  3. Check if the safety lock returns to its original position when you release your hand from safety lock.
- If you find any defects at the checks above, contact your nearest servicing dealer for repair.

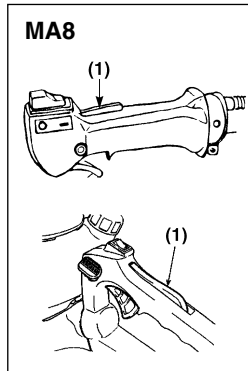

### (1) Safety lock

### ■ REDUCTION GEARBOX

Refill gear housing every 50 working hours (MA9). Use grease pump. Feed grease until it comes out of the base of blades.

Grease nipple: A type

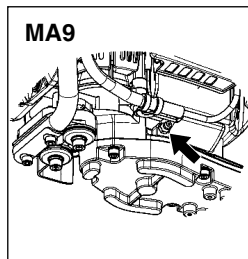

### ■ ANTI-VIBRATION SYSTEM

### ! WARNING

- **The deformed or damaged anti-vibration system may cause of the breakages like getting rickety or falling off of engine and/or blade.**
- [HTZ2460/HTZ2460L] Check periodically if the rubber cushions are not deformed or damaged.
- [CHTZ2460/CHTZ2460L] Check periodically if the springs are not deformed or damaged.

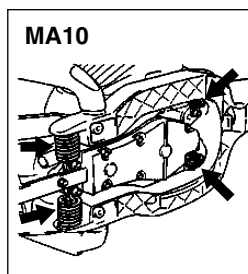

## 8. Maintenance

### ■ PROCEDURES TO BE PERFORMED AFTER EVERY 100 HOURS OF USE

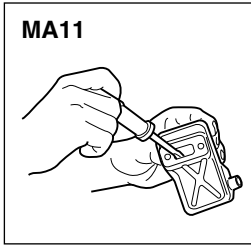

1. Remove the muffler, insert a screwdriver into the vent, and wipe away any carbon buildup. Wipe away any carbon buildup on the muffler exhaust vent and cylinder exhaust port at the same time.
2. Tighten all screws, bolts, and fittings.
3. Check to see if any oil or grease has worked its way in between the clutch lining and drum, and if it has, wipe it away using oil-free, lead-free gasoline.

### ■ MUFFLER

#### ▲ WARNING

- **Inspect periodically, the muffler for loose fasteners, any damage or corrosion. If any sign of exhaust leakage is found, stop using the machine and have it repaired immediately.**
- **Note that failing to do so may result in the engine catching on fire.**

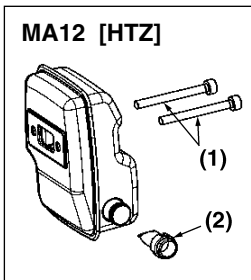

### ■ SPARK ARRESTER

- The muffler is equipped with a spark arrester to prevent red hot carbon from flying out of the exhaust outlet. Periodically inspect and clean as necessary with a wire brush. In the State of California it is required by law (Section 4442 of the California Public Resources Code) to equip a spark arrester when a gas powered tool is used in any forest covered, brush covered, or grass covered unimproved land. (MA12)(MA13)

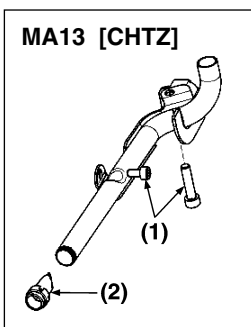

- (1) Bolt  
(2) Spark arrester

## 9. Storage

1. Oil the blade to prevent rust.
2. Empty the fuel tank and put the cap back on.
3. Remove the spark plug, pour a small amount of oil into the cylinder.
4. Rotate the crankshaft several times using the starting rope in order to distribute the oil. Put the spark plug back in.
5. Wrap the engine with a plastic sheet.
6. Store the trimmer in a dry place, preferably not in direct contact with the floor and away from heat sources.

## 10. Disposal

- When disposing your machine, fuel or oil for the machine, be sure to allow your local regulations.

## 11. Troubleshooting guide

### Case 1. Starting failure

CHECK	PROBABLE CAUSES	ACTION
fuel tank	→ incorrect fuel	→ drain it and with correct fuel
fuel filter	→ fuel filter is clogged	→ clean
carburetor adjustment screw	→ out of normal range	→ adjust to normal range
spark plug (no spark)	→ spark plug is fouled/wet	→ clean/dry
	→ plug gap is incorrect	→ correct (GAP: .026 in (0.65 mm))
spark plug	→ disconnected	→ retighten

### Case 2. Engine starts but does not keep running/Hard re-starting.

CHECK	PROBABLE CAUSES	ACTION
fuel tank	→ incorrect fuel or staled fuel	→ drain it and with correct fuel
carburetor adjustment screw	→ out of normal range	→ adjust to normal range
muffler,cylinder (exhaust port)	→ carbon is built-up	→ wipe away
air cleaner	→ clogged with dust	→ replace
cylinder fin, fan cover	→ clogged with dust	→ clean

When your unit seems to need further service, please consult with our service shop in your area.

**FEDERAL AND CALIFORNIA EMISSIONS CONTROL WARRANTY**  
**STATEMENT YOUR WARRANTY RIGHTS AND OBLIGATIONS**

The EPA (U.S. Environmental Protection Agency), CARB (California Air Resources Board), Environment Canada and RedMax are pleased to explain the emissions control system's warranty on your 2009 and later small off-road engine. In U.S. and Canada, new equipment that use small off-road engines must be designed, built, and equipped to meet the applicable Federal or Californian stringent anti-smog standards. RedMax must warrant the emissions control system on your small off-road engine for the period listed below provided there has been no abuse, neglect or improper maintenance of your equipment. Your emissions control system may include parts such as carburetor, ignition system, catalytic converter, fuel tank, filters and other associated components. Also, included may be hoses, belts, connectors, sensors, and other emission-related assemblies. Where a warrantable condition exists, RedMax will repair your small off-road engine at no cost to you including diagnosis, parts and labor.

**MANUFACTURER'S WARRANTY COVERAGE**

This emissions control system is warranted for two years or if the product qualifies for a longer warranty period resulting from the type of use, that period shall prevail. If any emissions-related part on your equipment is defective, the part will be repaired or replaced by RedMax.

**OWNER'S WARRANTY RESPONSIBILITIES**

As the small off-road engine owner, you are responsible for performance of the required maintenance listed in your Owner's Manual. RedMax recommends that you retain all receipts covering maintenance on your small off-road engine, but RedMax cannot deny warranty solely for the lack of receipts or your failure to ensure the performance of all scheduled maintenance. As the small off-road engine owner, you should however be aware that the RedMax may deny you warranty coverage if your small off-road engine or a part has failed due to abuse, neglect, or improper maintenance or unapproved modifications.

You are responsible for presenting your small off-road engine to a RedMax distribution center or service center as soon as the problem exists. The warranty repairs should be completed in a reasonable amount of time, not to exceed 30 days. If you have any questions regarding your warranty coverage, you should contact RedMax at 1-800-291-8251 or via e-mail at [service@redmax.com](mailto:service@redmax.com).

**WARRANTY COMMENCEMENT DATE**

The warranty period begins on the date the engine or equipment is delivered to an ultimate purchaser.

**LENGTH OF COVERAGE**

RedMax warrants to the ultimate purchaser and each subsequent owner that the engine or equipment is designed, built, and equipped so as to conform with all applicable regulations adopted by EPA and CARB, and is free from defects in materials and workmanship that causes the failure of a warranted part for a period of two years.

**WHAT IS COVERED**

**REPAIR OR REPLACEMENT OF PARTS** Repair or replacement of any warranted part under the warranty must be performed at no charge to the owner at a warranty station. Warranty services or repairs will be provided at all RedMax distribution centers that are franchised to service the subject engines. Throughout the emissions warranty period of two years, RedMax must maintain a supply of warranted parts sufficient to meet the expected demand for such parts.

**WARRANTY PERIOD** Any warranted part that is scheduled for replacement as required in the maintenance schedule, is warranted for the period of time prior to the first scheduled replacement point for that part. If the part fails prior to the first scheduled replacement, the part will be repaired or replaced by RedMax at no cost. Any such part repaired or replaced under warranty is warranted for the remainder of the period prior to the first scheduled replacement point for the part. Any warranted part that is not scheduled for replacement as required in the maintenance schedule, is warranted for two years or if the product qualifies for a longer warranty period resulting from the type of use, that period shall prevail. If any such part fails during the period of warranty coverage, it will be repaired and replaced by RedMax at no cost. Any such part repaired or replaced under the



warranty is warranted for the remaining warranty period. Any warranted part that is scheduled only for regular inspection in the maintenance schedule will be warranted for a period of two years. A statement in such written instructions to the effect of "repair or replace as necessary" will not reduce the period of warranty coverage. Any such part repaired or replaced under warranty will be warranted for the remaining warranty period.

**DIAGNOSIS** The owner must not be charged for diagnostic labor that leads to the determination that a warranted part is in fact defective, provided that such diagnostic work is performed at a warranty station.

**CONSEQUENTIAL DAMAGES** RedMax is liable for damages to other engine components proximately caused by a failure under warranty of any warranted part.

#### **EMISSION WARRANTY PARTS LIST**

1. Air-induction system\*
2. Fuel system\*
3. Ignition system\*
4. Fuel tank, cap and lines as applicable\*

\*some components only covered up to point specified by maintenance schedule

#### **WHAT IS NOT COVERED**

All failures caused by abuse, neglect or improper maintenance are not covered.

#### **ADD-ON OR MODIFIED PARTS**

Add-on or modified parts that are not exempted by CARB or EPA may not be used. The use of any non-exempted add-on or modified parts will be grounds for disallowing a warranty claim. RedMax will not be liable to warrant failures of warranted parts caused by the use of a non-exempted add-on or modified part.

#### **HOW TO FILE A CLAIM**

If you have any questions regarding your warranty rights and responsibilities, you should contact your nearest authorized servicing dealer or contact RedMax at 1-800-291-8251 or via e-mail at [service@redmax.com](mailto:service@redmax.com).

#### **WHERE TO GET WARRANTY SERVICE**

Warranty services or repairs are provided through all RedMax authorized servicing dealers.

#### **MAINTENANCE, REPLACEMENT AND REPAIR OF EMISSION-RELATED PARTS**

Any replacement part may be used in the performance of any warranty maintenance or repairs and must be provided without charge to the owner. Such use will not reduce the warranty obligations of the manufacturer.

#### **MAINTENANCE STATEMENT**

The owner is responsible for the performance of all required maintenance, as defined in the operator's manual.

## Free Manuals Download Website

<http://myh66.com>

<http://usermanuals.us>

<http://www.somanuals.com>

<http://www.4manuals.cc>

<http://www.manual-lib.com>

<http://www.404manual.com>

<http://www.luxmanual.com>

<http://aubethermostatmanual.com>

Golf course search by state

<http://golfingnear.com>

Email search by domain

<http://emailbydomain.com>

Auto manuals search

<http://auto.somanuals.com>

TV manuals search

<http://tv.somanuals.com>