



SAMSUNG

User Manual

High Definition Digital Camcorder

www.samsung.com/register

For video recording, use a memory card that supports faster write speeds.





- Memory Card: A Class 6 SDHC card or above.

HMX-T10WN
HMX-T10BN
HMX-T10ON

before reading this user manual

SAFETY WARNINGS

What the icons and signs in this user manual mean;

Safety Icon	Meaning
 WARNING	There is a potential risk of death or serious injury.
 CAUTION	There is a potential risk of personal injury or damage to the product.
 CAUTION	To reduce the risk of fire, explosion, electric shock, or personal injury when using your camcorder, follow these basic safety precautions.
	Here are hints or page number references you will find helpful when you operate the camcorder.
PRECHECK!	Settings required before using a function.

These warning signs are here to prevent injury to you and others. Please follow them explicitly. After reading this section, keep it in a safe place for future reference.

PRECAUTIONS

Warning!

- When using the AC power adapter with your camcorder, connect the adapter to an outlet with protective grounding.
- Do not expose the camcorder battery to direct sunlight, heaters, radiators, fire, or any other source of excessive heat.

Caution

If you replace the battery with the wrong battery, you can cause an explosion. Replace only with the same battery or an equivalent type.

If you plug the AC adapter into a 240V AC outlet, be sure to use a suitable plug adapter.

IMPORTANT INFORMATION ON USE

About this user manual

Thank you for purchasing this Samsung Camcorder. Please read this user manual carefully before you use the camcorder and keep it handy for future reference. Should your camcorder fail to operate correctly, refer to Troubleshooting.

This User Manual covers HMX-T10WN, HMX-T10BN, HMX-T10ON models.

- Illustrations of model HMX-T10BN are used in this user manual.
- The displays in this user manual may not be exactly the same as those you see on the LCD screen.
- Designs and specifications of the camcorder and other accessories are subject to change without any notice.
- In this user manual, the icon or symbol in the parenthesis appearing in a description of a submenu item indicates it will appear on the screen when setting the corresponding item.
Ex) Submenu item of **"Video Quality"**
 - ↳ page 50
 - **"Super Fine"** (📷): Records in the Super Fine quality. (If set, the corresponding icon (📷) will appear on the screen.)

The following terms are used in this manual:

- 'Scene' refers to the point where you press the **Record Start/Stop** button to start recording until you press again to pause the recording.
- The terms 'photo' and 'still image' are used interchangeably and have the same meaning.

Before using this camcorder

- **This camcorder records video in H.264 (MPEG4 part10/AVC) format and in High Definition Video (HD-VIDEO) or Standard Definition Video (SD-VIDEO).**
- **You can play back and edit the video recorded by the camcorder on a personal computer using the internal software of this camcorder.**
- **Please note that this camcorder is not compatible with other digital video formats.**
- **Before recording important video, make a trial recording.**
Play back your trial recording to make sure the video and audio have been recorded properly.
- Recorded contents may be lost due to a mistake when handling this camcorder or memory card, etc. Samsung will not provide compensation for damages due to the loss of recorded contents.
- **Make a backup of important recorded data.**
Protect your important recorded data by copying the files to a PC. We also recommend you copy it from your PC to other recording media for storage. Refer to the software installation and USB connection guide.



before reading this user manual

- **Copyrights: Please note that this camcorder is intended for individual use only.**
Data recorded on the storage media in this camcorder using other digital/analog media or devices is protected by the Copyright Act and cannot be used without permission of the owner of the copyright, except for personal enjoyment. Even if you record an event such as a show, performance, or exhibition for personal enjoyment, we strongly recommend that you obtain permission beforehand.
- We recommend you use the camcorder at least once a month to maintain its performance and operating life.
- Check the image resolution before developing photos.
- Make sure to check all functions of the camcorder before recording to prevent recording failure.
- For Open Source licenses information, refer to the “OpenSource-T10.pdf” in the provided CD-ROM

Notes regarding trademarks

- All the trade names and registered trademarks mentioned in this manual or other documentation provided with your Samsung product are trademarks or registered trademarks of their respective holders. Furthermore, “™” and “®” are not mentioned in each case in this manual.
- The SD logo is a trademark. The SDHC logo is a trademark.
- Microsoft®, Windows®, Windows Vista®, Windows® 7, and DirectX® are either registered trademarks or trademarks of the Microsoft Corporation in the United States and/or other countries.
- Intel®, Core™, Core 2 Duo®, and Pentium® are the registered trademarks or trademarks of the Intel Corporation in the United States and other countries.
- AMD and Athlon™ are either registered trademarks or trademarks of AMD in the United States and other countries.
- Macintosh, Mac OS are either registered trademarks or trademarks of Apple Inc. in the United States and/or other countries.
- YouTube is a trademark of Google Inc.
- Flickr is a trademark of Yahoo.
- Facebook is a trademark of Facebook Inc.
- HDMI, the HDMI logo and High-Definition Multimedia Interface are trademarks or registered trademarks of HDMI Licensing LLC.
- Adobe, the Adobe logo, and Adobe Acrobat are either registered trademarks or trademarks of Adobe Systems Incorporated in the United States and/or other countries.

important safety instructions

	CAUTION RISK OF ELECTRIC SHOCK DO NOT OPEN	
CAUTION: TO REDUCE THE RISK OF ELECTRIC SHOCK, DO NOT REMOVE COVER (OR BACK). NO USER-SERVICEABLE PARTS INSIDE REFER SERVICING TO QUALIFIED SERVICE PERSONNEL.		



This symbol indicates that dangerous voltage consisting a risk of electric shock is present within this unit.



This symbol indicates that there are important operating and maintenance instructions in the literature accompanying this unit.

Warning

To Reduce The Risk Of Fire Or Electric Shock, Do Not Expose This Apparatus To Rain Or Moisture.

Caution

Apparatus shall not be exposed to dripping or splashing and no objects filled with liquids, such as vases, shall be placed on the apparatus.

To disconnect the apparatus from the mains, the plug must be pulled out from the mains socket, therefore the mains plug shall be readily operable.

1. Read these instructions.
2. Keep these instructions.
3. Heed all warnings.
4. Follow all instructions.
5. Do not use this apparatus near water.
6. Clean only with dry cloth.
7. Do not block any ventilation openings. Install in accordance with the manufacturer's instructions.
8. Do not install near any heat sources such as radiators, heat registers, stoves, or other apparatus (including amplifiers) that produce heat.
9. Do not defeat the safety purpose of the polarized or grounding-type plug. A polarized plug has two blades with one wider than the other. A grounding type plug has two blades and a third grounding prong. The wide blade or the third prong are provided for your safety. If the provided plug does not fit into your outlet, consult an electrician for replacement of the obsolete outlet.
10. Protect the power cord from being walked on or pinched particularly at plugs, convenience receptacles, and the point where they exit from the apparatus.
11. Only use attachment/accessories specified by the manufacturer.
12. Use only with the cart, stand, tripod, bracket, or table specified by the manufacturer, or sold with the apparatus. When a cart is used, use caution when moving the cart/apparatus combination to avoid injury from tip-over.
13. Unplug this apparatus during lightning storms or when unused for long periods of time.
14. Refer all servicing to qualified service personnel. Servicing is required when the apparatus has been damaged in any way, such as power-supply cord or plug is damaged, liquid has been spilled or objects have fallen into the apparatus, the apparatus has been exposed to rain or moisture, does not operate normally, or has been dropped.



important safety instructions

15. Apparatus shall not be exposed to dripping or splashing and no objects filled with liquids, such as vases, shall be placed on the apparatus.
16. VENTILATION:
Slots and openings in the cabinet are provided for ventilation to ensure reliable operation of the CAMCORDER and to protect it from overheating. These openings must not be blocked or covered. Never place your CAMCORDER on a bed, sofa, rug, or other similar surface: on or near a radiator or heat register. This CAMCORDER should not be placed in a built-in installation such as a bookcase or rack unless proper ventilation is provided or the manufacturer's instructions have been adhered to.
17. POWER SOURCES:
The CAMCORDER should be operated only from the type of power source indicated on the label. If you are not sure of the type of power supply at your home, consult your appliance dealer or local power company. A CAMCORDER is intended to be operated from battery power, or other sources, refer to the operating instructions.
18. GROUNDING OR POLARIZATION:
This CAMCORDER may be equipped with either a polarized 2-wire AC line plug (a plug having one blade wider than the other) or a 3-wire grounding type plug, a plug having a third (grounding) pin. If you are unable to insert the plug fully into the outlet, try reversing the plug. If the plug still fails to fit, contact your electrician to replace your outlet. Do not defeat the safety purpose of the polarized plug.
19. POWER-CORD PROTECTION:
Power-supply cords should be routed so that they are not likely to be walked on or pinched by items placed upon or against them, paying particular attention to cords or plugs, convenient receptacles, and the point where they exit from the unit.

20. OUTDOOR ANTENNA GROUNDING:
CAMCORDER, be sure the antenna or cable system is grounded to provide some protection against voltage surges and built-up static charges. Section 810 of the National Electrical Code, ANSI/NFPA No. 70-1984, provides information with respect to proper grounding of the mast and supporting structure, grounding of the lead-in wire and supporting structure, grounding of the mast and supporting structure, grounding of the lead-in wire to an antenna discharge unit, size of grounding to conductors, location of antenna-discharge unit, connection to grounding electrodes and requirements for the grounding electrode. See figure below.

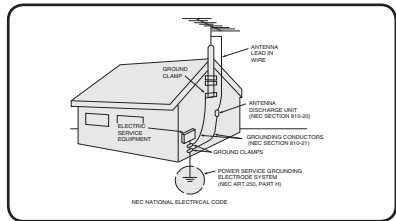

21. LIGHTNING:
For added protection of this CAMCORDER during a lightning storm or when it is left unattended and unused for long periods of time, unplug it from the wall outlet and disconnect the antenna or cable system. This will prevent damage to the CAMCORDER due to lightning and powerline surges.
22. POWER LINES:
An outside antenna system should not be located in the vicinity of overhead power lines or other electric light or power circuits where it can fall into such power lines or circuits. When installing an outside antenna system, extreme care should be taken to keep from touching such power lines or circuits as contact with them might be fatal.

23. OVERLOADING:

Do not overload wall outlets and extension cords as this can result in a risk of fire or electric shock.

24. OBJECTS AND LIQUIDS:

Never push objects of any kind into this CAMCORDER through openings as they may touch dangerous voltage points or short out a part that could result in a fire or electric shock. Never spill liquids of any kind onto the CAMCORDER. Should spillage occur, unplug unit and have it checked by a technician before use.

25. SERVICING:

Do not attempt to service this CAMCORDER yourself. Opening or removing covers may expose you to dangerous voltage or other hazards. Refer all servicing to qualified service personnel.

26. DAMAGE REQUIRING SERVICE:

Unplug this CAMCORDER from the wall outlet and refer servicing to qualified service personnel under the following conditions:

- a. When the power-supply cord or plug is damaged.
- b. If any liquid has been spilled onto, or objects have fallen into the CAMCORDER.
- c. If the CAMCORDER has been exposed to rain or water.
- d. If the CAMCORDER does not operate normally by following the operating instructions, adjust only those controls that are covered by the operating instructions. Improper adjustment of other controls may result in damage and will often require extensive work by a qualified technician to restore the CAMCORDER to its normal operation.
- e. If the CAMCORDER has been dropped or the cabinet has been damaged.
- f. When the CAMCORDER exhibits a distinct change in performance, this indicates a need for service.

27. REPLACEMENT PARTS:

When replacement parts are required, be sure the service technician has used replacement parts specified by the manufacturer and having the same characteristics as the original part. Unauthorized substitutions may result in fire, electric shock or other hazards.

28. SAFETY CHECK:

Upon completion of any service or repairs to this CAMCORDER, ask the service technician to perform safety checks to determine that the CAMCORDER is in safe operating order.

29. To prevent damage which may result in fire or shock hazard, do not expose this appliance to rain or moisture.

30. If this power supply is used at 240V ac, a suitable plug adaptor should be used.

important safety instructions

USER INSTALLER CAUTION:

Your authority to operate this FCC certified equipment could be voided if you make changes or modifications not expressly approved by this party responsible for compliance to part 15 FCC rules.

NOTE:

(Hg) LAMP(S) INSIDE THIS PRODUCT CONTAIN MERCURY AND MUST BE RECYCLED OR DISPOSED OF ACCORDING TO LOCAL, STATE OR FEDERAL LAWS. For details see lamprecycle.org, eiae.org, or call 1-800-Samsung (7267864)

CALIFORNIA USA ONLY

This Perchlorate warning applies only to primary CR (Manganese Dioxide) Lithium coin cells in the product sold or distributed ONLY in California USA
" Perchlorate Material - special handling may apply, See www.dtsc.ca.gov/hazardouswaste/perchlorate."

NOTE:

This equipment has been tested and found to comply with the limits for a Class B digital device, pursuant to part 15 of the FCC Rules.

These limits are designed to provide reasonable protection against harmful interference in a residential installation.

This equipment generates, uses and can radiate radio frequency energy and, if not installed and used in accordance with the instructions, may cause harmful interference to radio communications.

However, there is no guarantee that interference will not occur in a particular installation.

If this equipment does cause harmful interference to radio or television reception, which can be determined by turning the equipment off and on, the user is encouraged to try to correct the interference by one or more of the following measures:

- Reorient or relocate the receiving antenna.
 - Increase the separation between the equipment and receiver.
 - Connect the equipment into an outlet on a circuit different from that to which the receiver is connected.
 - Consult the dealer or an experienced radio/TV technician for help and for additional suggestions.
- The user may find the following booklet prepared by the Federal Communications Commission helpful: "How to Identify and Resolve Radio-TV Interference Problems." This Booklet is available from the U.S. Government Printing Office, Washington, D.C. 20402, Stock No. 004-000-00345-4.

FCC Warning

The user is cautioned that changes or modifications not expressly approved by the manufacturer could void the user's authority to operate the equipment.

This device complies with Part 15 of FCC Rules.

Operation is subject to the following two conditions;

- (1) This device may not cause harmful interference, and
- (2) This device must accept any interference received, including interference that may cause undesired operation.

safety information

The safety precautions illustrated below are to prevent personal injury or material damages. Heed all instructions carefully.

⚠ WARNING
Means that there is a potential risk of serious personal injury.

⚠ CAUTION
Means that there is a potential risk of personal injury or damage to the product.

⊘ Prohibited action.

⊘ Do not disassemble the product.

⊘ Unplug from the power supply.

⊘ Do not touch the product.

⚠ This precaution must be followed.

⚠ WARNING



Do not overload outlets or extension cords as this may result in abnormal heat or fire.



Using the camcorder at temperatures over 60°C (140°F) may result in fire. Keeping the battery at a high temperature may cause an explosion.

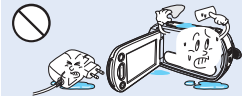

Do not allow water or metal and inflammable matter to enter the camcorder or AC power adaptor. Doing so may pose a fire hazard.

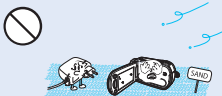

No sand or dust! Fine sand or dust entering the camcorder or AC power adaptor could cause malfunctions or defects.

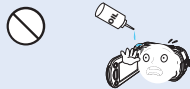

No oil! Oil entering the camcorder or AC power adaptor could cause electric shock, malfunctions or defects.



Do not aim the camcorder directly into the sun. Doing so could cause eye injuries, as well as lead to malfunctioning of internal parts of the product.



Do not bend the power cord or damage the AC power adaptor by pressing on it with a heavy object. There may be a risk of fire or electric shock.



Do not disconnect the AC adaptor by pulling on its power-cord, as this could damage the power-cord.



Do not use the AC adaptor if it has damaged, split or broken cords or wires. Doing so may cause fire or electric shock.

safety information

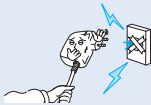

Do not connect the AC adaptor unless the plug can be fully inserted with no part of the blades exposed.



Do not dispose of the battery in a fire as it may explode.

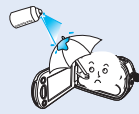

Never use cleaning fluid or similar chemicals to clean the camcorder. Do not spray cleaners directly on the camcorder.



Keep the camcorder away from water when using it near the beach or pool or when it rains. There is a risk of malfunction or electric shock.



Keep the used lithium battery or memory card out of the reach of children. If the lithium battery or memory card is swallowed by a child, consult physician immediately.

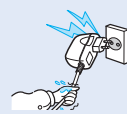

Do not plug or unplug the power cord with wet hands. There is a risk of electric shock.



Keep the power-cord unplugged when not in use or during lightning storms. There is a risk of fire.

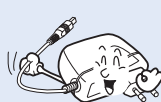

When cleaning the AC adaptor, unplug the power-cord. There is a risk of malfunction or electric shock.

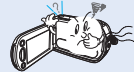

If the camcorder emits an abnormal sound, or smell or smokes, unplug the power-cord immediately and request service from a Samsung service center. There is a risk of fire or personal injury.

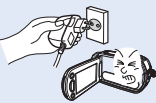

If the camcorder malfunctions, immediately detach the AC adaptor or battery from the camcorder. There is a risk of fire or injury.



Do not attempt to disassemble, repair, or modify the camcorder or the AC adaptor to avoid a risk of fire or electric shock.

! CAUTION

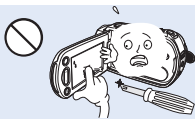

Do not press the surface of the LCD with force, or hit it with a sharp object. If you push the LCD surface, display unevenness may occur.

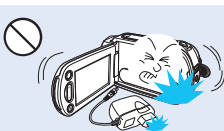

Do not drop or expose the camcorder, battery, AC adaptor, or other accessories to severe vibrations or impact. This may cause a malfunction or injury.

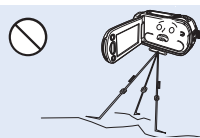

Do not use the camcorder on a tripod (not supplied) in a place where it is subject to severe vibrations or impact.

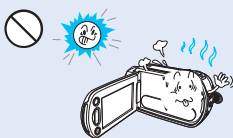

Do not use the camcorder in direct sunlight or near heating equipment. This may cause a malfunction or injury.



Do not leave the camcorder in a closed vehicle for a long time, where the temperature is very high.

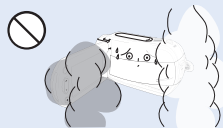

Do not expose the camcorder to soot or steam. Thick soot or steam could damage the camcorder case or cause a malfunction.

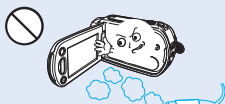

Do not use the camcorder near dense exhaust gas generated by gasoline or diesel engines, or near a corrosive gas such as hydrogen sulphide. Doing so may corrode the external or internal terminals, disabling normal operation.



Do not expose the camcorder to insecticide. Insecticide entering the camcorder could cause the product to operate abnormally. Turn the camcorder off and cover it with vinyl sheet, etc. before using insecticide.

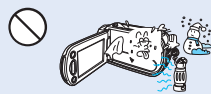

Do not expose the camcorder to sudden changes in temperature or high humidity. There is also a risk of defect or electric shock when using outdoors during lightning storms.



Do not place the camcorder with the open LCD screen down.

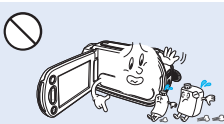

Do not wipe the camcorder body with benzene or thinner. The exterior coating could peel off or the surface could deteriorate.

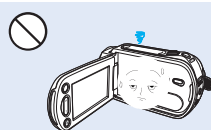

Do not leave the LCD screen open when not using the camcorder.

safety information



Do not hold the camcorder by the LCD monitor when lifting it. The LCD screen could detach and the camcorder may fall.

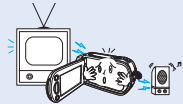

Do not use the camcorder near a TV or radio: This could cause distortion on the TV screen or interference in the radio broadcasts.



Do not use the camcorder near sources of strong radio waves or magnetism such as speakers or large motors. Noise from these sources could distort the video or audio you are recording.

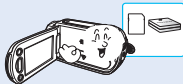

Use Samsung-approved accessories only. Using products from other manufacturers may cause overheating, fire, explosion, electric shock or personal injuries caused by abnormal operation.



Place the camcorder on a stable surface that is well ventilated.

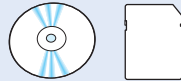

Keep important data separately. Samsung is not responsible for data loss.

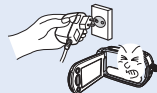

Only plug the adaptor plug into a socket that is easily accessible. If any problem occurs with the product, you must pull the plug out of the socket to disconnect the power completely. Turning off the power button on the product does not completely disconnect the power.

contents

QUICK START GUIDE

07

07 You can record videos in H.264 format!

GETTING TO KNOW THE CAMCORDER

11

11 What's included with your camcorder
12 Location of controls
14 Identifying the screen displays

GETTING STARTED

17

17 Inserting/ejecting the battery
18 Charging the battery
19 Checking the battery state

BASIC OPERATION OF THE CAMCORDER

22

22 Turning your camcorder on/off
23 Switching to the power saving mode
24 Setting the operation modes
24 Using the Display(□) button
25 Using the touch panel

FIRST TIME SETTINGS

26

26 Setting the time zone and date/time for the first time
27 Selecting the languages

GETTING READY TO START RECORDING

28

28 Inserting / ejecting a memory card (not supplied)
29 Selecting a suitable memory card (not supplied)
31 Recordable time and capacity
32 Using the hand strap
32 Adjusting the LCD screen
33 Basic camcorder positioning

contents

BASIC RECORDING

34

- 34 Recording videos
- 36 Capturing photos during video recording
- 37 Recording photos
- 38 Recording with ease for beginners (smart auto)
- 39 Zooming

BASIC PLAYBACK

40

- 40 Changing the playback mode
- 41 Playing back videos
- 43 Viewing photos

USING THE MENU ITEMS

45

- 45 Handling menus and quick menus
- 46 Menu items
- 48 Quick menu items

ADVANCED RECORDING

49

- 49 **SCENE**
- 50 Video Resolution
- 50 Video Quality
- 51 Photo Resolution
- 51 Photo Sharpness
- 52 White Balance
- 53 Aperture
- 54 Shutter
- 55 EV
- 55 Super C.Nite
- 56 Back Light
- 57 Focus
- 58 Anti-Shake (OIS: Optical Image Stabilizer)
- 59 Digital Effect
- 60 Fader
- 61 Tele Macro
- 62 Cont. Shot
- 62 Wind Cut
- 63 Digital Zoom
- 63 Self Timer
- 64 Quick View
- 65 Guideline

ADVANCED PLAYBACK

66

- 66 Play Option
- 67 Highlight
- 68 Slide Show Option
- 68 File Info

EDITING FILES

69

- 69 Deleting files
- 70 Protection from accidental erasure
- 71 Dividing a video
- 72 Combining videos

SYSTEM SETTING

73

- 73 Setting menu items
- 74 Card Info
- 74 Format
- 75 File No.
- 75 Time Zone
- 76 Date/Time Set
- 76 Date Type
- 76 Time Type
- 77 Date/Time Display
- 77 LCD Brightness
- 78 Auto LCD Off
- 79 Beep Sound
- 79 Shutter Sound
- 80 Auto Power Off
- 81 Quick On STBY
- 82 PC Software
- 82 USB Connect
- 83 HDMI TV Out
- 83 TV Connect Guide
- 84 TV Display
- 84 Default Set
- 85 Language
- 85 Demo
- 86 Anynet+ (HDMI-CEC)

contents

CONNECTING TO A TV	87	Connecting to a high definition TV with HDMI
87	89	Connecting to a regular TV
	90	Viewing on a TV screen
DUBBING VIDEOS	91	Dubbing to a VCR or DVD/HDD recorder
91		
PRINTING PHOTOS	92	Direct printing with a PictBridge printer
92		
USING WITH A WINDOWS COMPUTER	94	What you can do with a windows computer
	95	Using the Intelli-studio program
	100	Using as a removable storage device
94		
TROUBLESHOOTING	102	Warning indicators and messages
	107	Symptoms and solutions
MAINTENANCE & ADDITIONAL INFORMATION	113	Maintenance
	114	Using your camcorder abroad
SPECIFICATIONS	115	Specifications

quick start guide

This quick start guide introduces the basic operation and features of your camcorder. See the reference pages for more information.

You can record videos in H.264 format!

You can record videos in H.264 format that is convenient to email and share with your friends and family. You can also take photos with your camcorder.

STEP 1: Get ready

1. Insert the battery to the camcorder. ↪page 17
 - Make sure that the SAMSUNG logo is facing up and the battery is placed as shown in the figure.
2. Charge the battery fully. ↪page 18
 - The battery is fully charged when the CHG (charging) indicator light turns green.
3. Insert a memory card. ↪page 28
 - You can use commercially available SDHC (SD High Capacity) or SD memory cards with this camcorder.

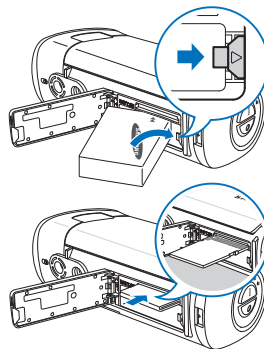

STEP 2: Record with your camcorder

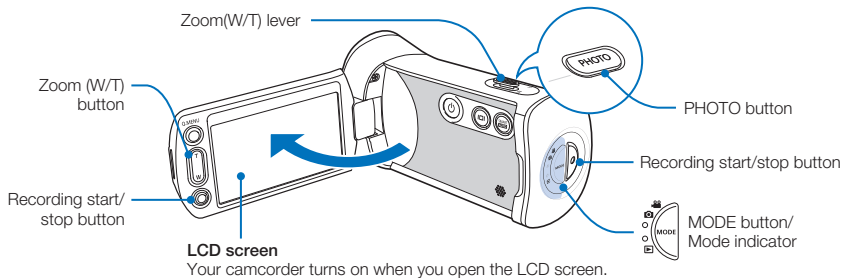

quick start guide

Recording videos

Your camcorder uses advanced H.264 compression technology to give you the clearest video quality.

1. Open the LCD screen.
2. Press the **Recording start/stop** button.
 - To stop recording, press the **Recording start/stop** button.



Recording photos

1. Open the LCD screen.
2. Press the **PHOTO** button lightly to adjust the focus.
3. Fully press the **PHOTO** button when the subject is in focus.

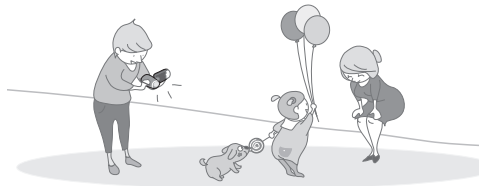

Using 'Quick On STBY' by opening/closing the LCD screen.

When you close the LCD screen during standby, your camcorder goes to Quick On STBY mode (power saving mode). You can start recording quickly when you open the LCD screen.

➔page 81





- The default video resolution setting is "1080/60i." You can also record in SD (standard definition) video quality.
- You can also take photos while recording videos. ➔page 36

STEP 3: Play back videos or photos

Viewing videos or photos on the LCD screen

You can find recordings quickly by using the thumbnail index view.

1. Touch the Play () tab on the screen in STBY mode.
2. Touch the thumbnail ( / ) tab, then touch the desired image.



Viewing on a high definition TV

You can enjoy HD (high definition) videos on an HDTV.

↳page 87



You can also play back videos on an SD (standard definition) image quality TV. ↳page 89

STEP 4: Save recorded videos or photos

Simple and fun! Enjoy the various features of the internal Intelli-studio program on your Windows computer.

Using the Intelli-studio program built into your camcorder, you can import videos/photos into your computer and edit or share the videos/photos with your friends and family. For details, see pages 94-101



quick start guide

Importing and viewing videos/photos from the camcorder to your PC

1. Launch the Intelli-studio program by connecting the camcorder to your PC with a USB cable.
 - A new file saving screen appears with the Intelli-studio main window. Click **“Yes”**, and the uploading procedure starts.
2. The new files are saved to your PC and registered to **“Contents Manager”** on the Intelli-studio program.
 - You can arrange the files by different criteria such as Face, Date, etc.
3. Double-click on the file you would like to playback.

Contents Manager Saved files into your PC

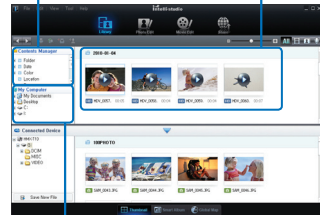

Folders directory on your PC

Sharing videos/photos on YouTube/Flickr/FaceBook

Share your contents with the world by uploading videos and photos directly to a web site with one click.

Click **“Share”** → **“Upload”** tab on the browser. ↪ page 99



Intelli-studio runs automatically after you connect your camcorder to a Windows computer if you have set **“PC Software: On”** in the Settings menu. ↪ page 82

STEP 5: Delete videos or photos

If the storage media is full, you cannot record new videos or photos. Delete videos or photos that you have saved to a computer from the camcorder's storage media. Then you can record new videos or photos on newly freed up space.

Touch the **Play** (▶) tab → **Menu** (☰) tab → **“Delete”** on the LCD screen. ↪ page 69

getting to know the camcorder

WHAT'S INCLUDED WITH YOUR CAMCORDER

Your new camcorder comes with the following accessories. If any of these items is missing from your box, call Samsung's Customer Care Center.

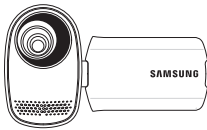

Model name	Color	Memory card slot	LCD screen	Lens
HMX-T10WN	White	Yes	Color /Touch panel	10x (Optical) 100x (Digital)
HMX-T10BN	Black			
HMX-T10ON	Orange			

- Although some features of the models are different, they operate in the same way.

Checking your accessories

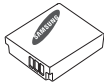

Battery
(BP125A)
(AD43-00197A)



AC power adaptor
(AA-MA9 type)
(AD44-00151A)

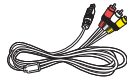

Audio/Video cable
(AD39-00184A)



USB cable
(AD39-00169A)

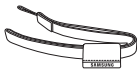

Hand strap
(AD63-04924A)



User manual CD
(AD46-00355A)

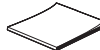

Quick start guide
(AD68-05486A)

Optional accessories



Mini HDMI cable
(AD39-00159A)



- The exact appearance of each item may vary by model.
- The contents may vary depending on the sales region.
- Parts and accessories can be purchased after consulting with your local Samsung dealer. SAMSUNG is not responsible for reduced battery life time or malfunctions caused by any unauthorized use of accessories such as the AC power adaptor or the batteries.
- A memory card is not included. See page 29 for memory cards compatible with your camcorder.
- Your camcorder includes the user manual CD and the printed quick start guide.

getting to know the camcorder

LOCATION OF CONTROLS

Front/Left

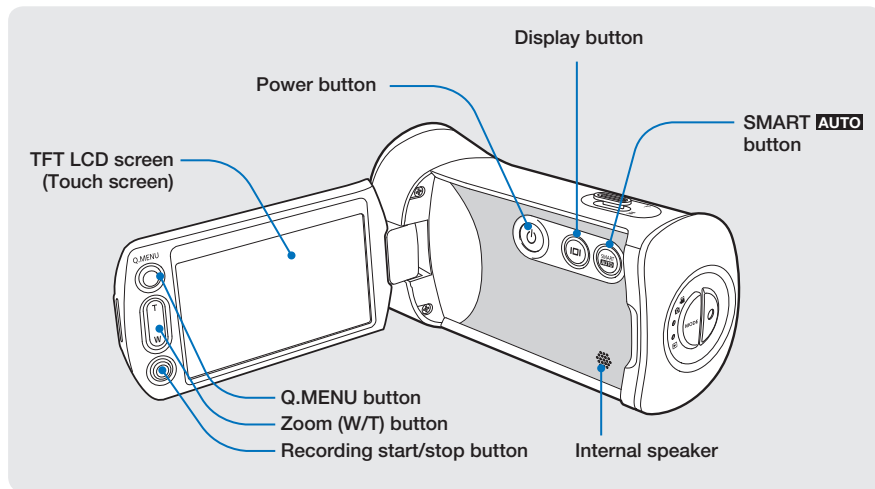
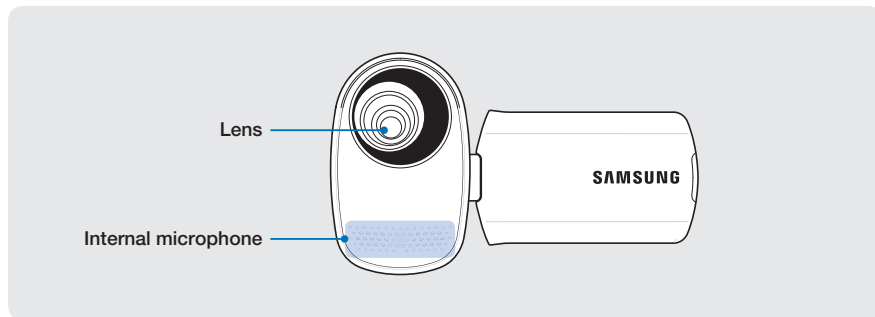

During a recording, be careful not to block the internal microphone and lens.

Rear/Right/Top/Bottom

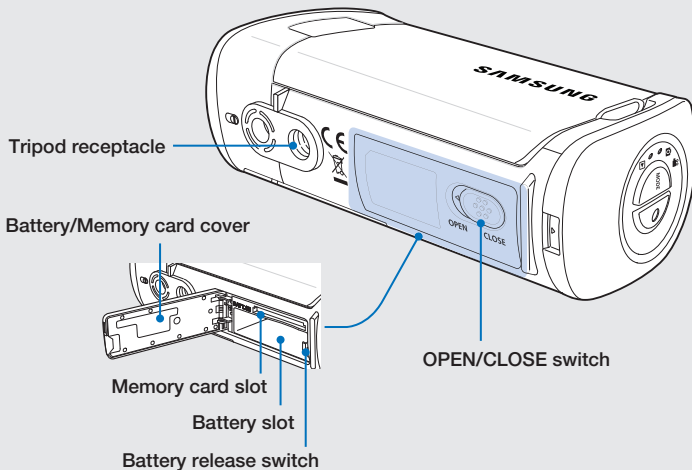
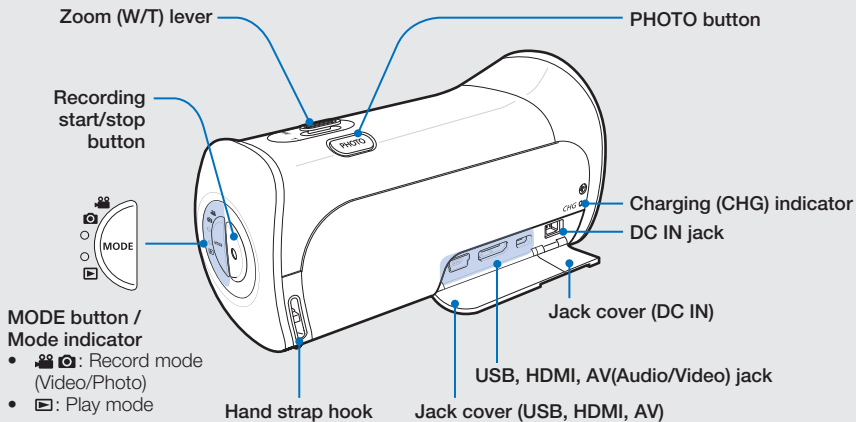

getting to know the camcorder

IDENTIFYING THE SCREEN DISPLAYS

The available functions vary depending on the operation mode you've selected. Different indicators appear depending on the setting values.

PRECHECK!

- This On Screen Display (OSD) is shown in the record (📹📷) mode only.
- Select the record mode by pressing the **MODE** button. → page 24

Record mode

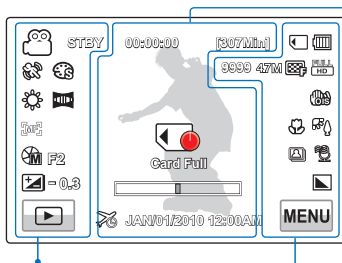

Left of the LCD screen

Indicator	Meaning
	Record mode (Video/Photo)
STBY /	Operating status (standby/recording) / Self Timer*
	SCENE / Smart Auto / Digital Effect
	White Balance, Fader*
	Manual focus*, Touch Point*
	Manual aperture* / Manual shutter* / Super C.Nite
	EV (Exposure Value)*
	Play tab

Center of the LCD screen

Indicator	Meaning
00:00:00	Time counter (video recording time)
	Warning indicators and messages
[307Min.]	Remaining recordable time
	Optical zoom / Digital zoom bar
	Time Zone (visit)
JAN012010 12:00AM	Date/Time

Right of the LCD screen

Indicator	Meaning
	Storage media (Memory card)
	Battery info. (remaining charge level)
9999 47M.	Image counter (total number of recordable photo images), Photo Resolution, Video Quality, Video Resolution
	Anti-shake(OIS)
	Tele Macro*, Back Light
	Cont. Shot, Wind Cut
	Photo Sharpness
MENU	Menu tab



- Settings of functions marked with * are not retained when the camcorder is turned off.
- The on-screen indicators are based on a 32GB SDHC memory card capacity.
- The screen above is an example and may differ from the actual display.
- For warning indicators and messages, see pages 102–106
- The illustrated items above and their positions can be changed without notice to improve performance.
- The total number of recordable photos is based on available space on the storage media.
- The largest number the OSD Image Counter can display is "9,999."
- This camcorder provides one record mode which combines the video and photo record modes. You can easily record videos or photos in the

PRECHECK!

- This On Screen Display (OSD) is shown in video play (HD/SD) mode only.
- Select the Play (Play) tab on the LCD screen to select the video play (HD/SD) mode. → page 40

Video play mode



Top of the LCD screen

Indicator	Meaning
	Video play mode
	Operating status (play/pause)
	Playback time/recorded time
	Storage media (Memory card)
	Battery info. (remaining charge level)
	Play Option
	File name (file number)
	Video Quality, Video Resolution
	Protect
	Date/Time

Bottom of the LCD screen

Indicator	Meaning
	Volume control
	Volume tab / Play related function tab (frame advance)
	Return tab
	Play related function tab (skip/search/pause/playback/slow playback)
	Menu tab



- The play related tab, the volume control, and the return tab appear briefly on the screen. They reappear when you touch the screen anywhere.
- For warning indicators and messages, see pages 102~106

getting to know the camcorder

PRECHECK!

- This On Screen Display (OSD) is shown in photo play (🖼️) mode only.
- Select the Play (🎬) tab on the LCD screen to select the photo play (🖼️) mode. ↪️page 40

Photo play mode

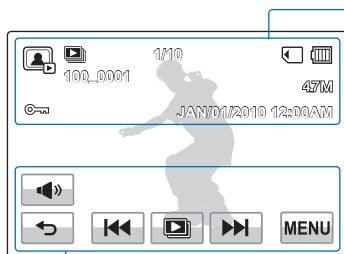

Top of the LCD screen

Indicator	Meaning
	Photo play mode
	Slide show / Playback zoom (X1.1~X8.0)
100_0001	File name (file number)
1/10	Photo image counter (current image / total number of recorded images)
	Storage media (memory card)
	Battery info.
	Erase protection
4.7M	Photo resolution
JAN 01 2010 12:00AM	Date/Time

Bottom of the LCD screen

Indicator	Meaning
	Volume tab (when activating slide show)
	Return tab
	Previous image/Next image tab
	Slide show start tab
	Menu tab

getting started

INSERTING/EJECTING THE BATTERY

Purchase extra batteries to allow continuous use of your camcorder.

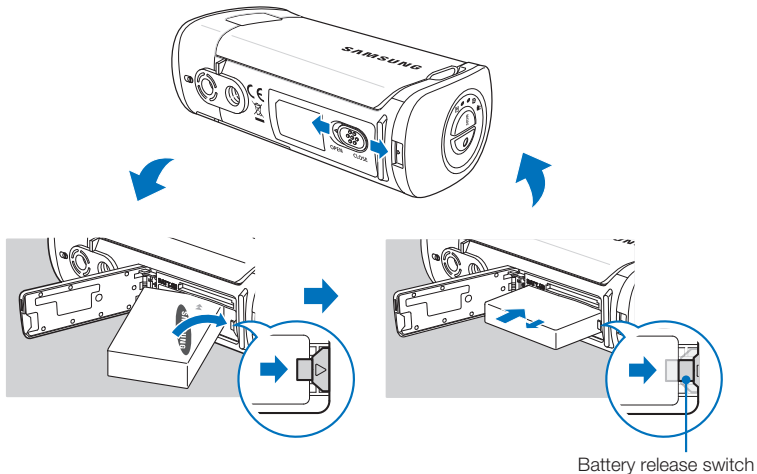

To insert the battery

1. Open the battery cover by sliding the **OPEN/CLOSE** switch toward **OPEN**.
2. Insert the battery into the battery slot until it locks.
 - Make sure that the **SAMSUNG** logo is facing up and the battery is placed as shown in the figure.
3. Close the battery cover by sliding the **OPEN/CLOSE** switch toward **CLOSE**.

To eject the battery

1. Open the battery cover by sliding the **OPEN/CLOSE** switch toward **OPEN**.
2. Slide the Battery release switch in the direction as shown in the figure.
3. Close the battery cover by sliding the **OPEN/CLOSE** switch toward **CLOSE**.



Samsung is not responsible for problems that are caused by using unapproved batteries. If you use batteries from other manufacturers, there is a danger of overheating, fire, or explosion.

getting started

CHARGING THE BATTERY

You can charge the battery using the AC power adaptor or the USB cable.

PRECHECK!

- Insert the battery into the camcorder. ↪ page 17
- To charge, use the supplied AC power adaptor or the USB cable.

To charge the battery

Charge the battery using the AC power adaptor or the USB cable.

- The charging (CHG) indicator lights up and charging starts. After the battery is fully charged, the charging (CHG) indicator turns green.

Using the AC power adaptor

Connect the AC power adaptor to the camcorder properly, and then plug the AC Power adaptor in the wall outlet.

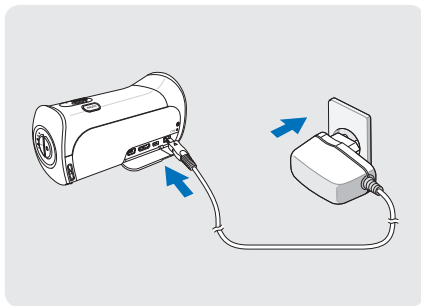

Using the USB cable

Connect the USB cable to the camcorder properly, and then connect the other end to a USB port of a PC.

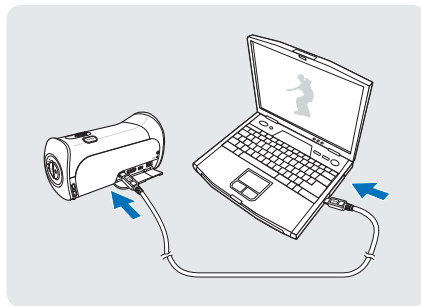

Please make sure that there are no foreign substances in the plug and socket when you connect the AC power supply to the camcorder.



- When charging, if both the USB cable and AC power adaptor are connected, the AC power adaptor will override the USB.
- You cannot operate the camcorder using USB power only. Use the power adaptor or battery to power the camcorder.
- USB charging time may depend on the type of USB host on your PC.
- If you use the camcorder while you are charging the battery, charging may take longer.



CHECKING THE BATTERY STATE

You can check the charging state and remaining battery capacity.

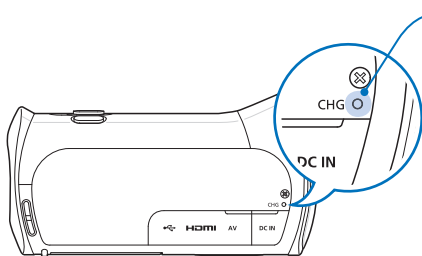
To check the charging state









The color of the LED indicates the power or charging state.

 (Orange)	Charging
 (Green)	Fully charged
 (Off)	Error

Battery level display

The battery level display shows the amount of battery power remaining in the battery.

Battery level indicator	State	Message
	Fully charged	-
	25~50% used	-
	50~75% used	-
	75~95% used	-
	95~98% used	-
	Exhausted (flickers): The device will soon turn off. Change the battery as soon as possible.	-
-	The device will be forced to turn off after 3 seconds.	“Low Battery”



The figures above are based on a fully charged battery at a normal temperature. Low ambient temperature may affect the use time.

getting started

Available running time for the battery

Battery type	BP125A	
Charging time	Using the AC power adaptor: approx. 120 min. Using the USB cable: approx. 270 min.	
Video resolution	HD	SD
Continuous recording time	Approx. 110 min.	Approx. 120 min.
Playback time	Approx. 140 min.	Approx. 160 min.

- Charging time: Approximate time in minutes required to fully charge a completely exhausted battery.
- Recording/Playback time: Approximate time available when you have fully charged the battery.
'HD' stands for high definition image quality and 'SD' stands for standard image quality.
- The time is only for reference. Times shown above are measured under Samsung's test conditions. Your times may differ, depending on your usage and conditions.
- The recording and playback times will be shorter when you use your camcorder in low temperatures.

Continuous Recording (without zoom)

The continuous recording time above shows the available recording time when you record without using any other function after recording starts. The battery may discharge 2-3 times faster than this reference if you use the record start/stop, the zoom, and the play functions. Prepare additional batteries with the expectation that the actual recording time is about 1/3 to 1/2 of the times listed above.

Using an AC power source

We recommend that you use the AC power adaptor to power the camcorder from a household AC outlet when recording and playing the camcorder indoors. The connection is the same as that for battery charging. ➤page 18

About the battery

• Battery Properties

A lithium-ion battery is small-sized and has a high capacity. Low ambient temperature (below 50°F (10C°)) may shorten its usage time and affect its function. Before recording in low temperatures, put the battery into your pocket to warm it, then install it in the camcorder.

• Make sure to store the battery separately after use.

- A small amount of battery power is consumed when the battery is stored in the camcorder even if the camcorder power is off.
- The battery may be completely discharged, if it has been installed and left in the camcorder for a long period of time. If this occurs, the battery may not fully operate even if you charge it.
- If the battery is not used for a long time, fully charge the battery and then, using your camcorder, drain the charge completely once every 3 months to keep the battery functioning properly. To store the battery, remove it from your camcorder and put it in a cool, dry place.

• Charge an extra battery before using the camcorder outdoors in cold temperatures.

- The cold temperature may shorten the length of time you can use the battery before needing to recharge it.
- Carry the supplied AC power adaptor to charge the battery while travelling.

• Check whether the battery terminal is damaged if the battery falls or is dropped.

- If you install a battery with the damaged terminal into the camcorder, you can damage the camcorder.

• Remove the battery and the memory card from the camcorder and disconnect the AC power adaptor after use.

- Store the battery in a stable, cool and dry place.
(Recommended temperature : 59°F ~ 77°F (15C°~ 25C°), recommended humidity: 40%~ 60%)
- Temperatures that are too high or too low shorten the battery lifetime.
- The battery terminals can become rusty or malfunction if the battery is stored in a smoky or dusty location.

• Recycle or dispose of your dead batteries properly.

• The battery lifetime is limited.

- Battery capacity decreases over time and through repeated use. If decreased usage time between charges becomes significant, it is probably time to replace the battery with a new one.
- Each battery's life is affected by storage, operating, and environmental conditions.



- Make sure to turn off the camcorder before disconnecting the AC power adaptor. Otherwise, you can damage the storage media or data.
- Use a nearby wall outlet when using the AC power adaptor. Disconnect the AC power adaptor from the wall outlet immediately if any malfunction occurs while using your camcorder.
- Do not place the AC Adaptor in a confined space when you use it, such as between a wall and a piece of furniture.



- Be sure to use the included AC power adaptor to power the camcorder. Using other AC power adaptors could cause electric shock or result in fire.
- You can use the AC power adaptor around the world. An AC plug adaptor is required in some foreign countries. If you need one, purchase it from your distributor.
- The charging time will vary depending on the charge remaining in the battery.
- The battery is charged over 95% after about 2 hours, and the indicator color changes to green. It takes about 2 hours and 40 minutes for the battery to charge 100%.

basic operation of the camcorder

TURNING YOUR CAMCORDER ON/OFF

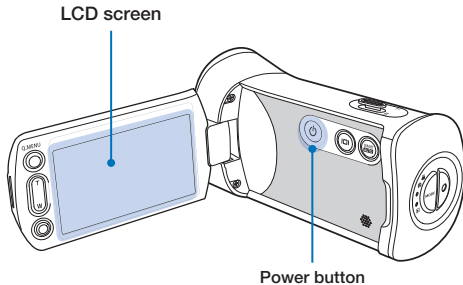

1. Open the LCD screen to turn on the camcorder.
 - Your camcorder turns on automatically when you open the LCD screen.
2. To turn off the camcorder, press the **Power** (⏻) button for about one second.



- The camcorder operates the self-diagnosis function when powered on. If a warning message appears, refer to 'warning indicators and messages' (pages 102-106) and take corrective actions.
- If you close the LCD screen when the power is on, the power saving mode activates. ↪ page 23
- The camcorder turns on automatically if connecting the AC power adaptor or inserting the battery to the camcorder with the LCD screen open.

🔍 When using this camcorder for the first time

When you use your camcorder for the first time or reset it, the time zone screen appears at start-up.

Select your geographical location, and then set the date and time. ↪ page 26

If you do not set the date and time, the time zone screen appears every time you turn on the camcorder.

SWITCHING TO THE POWER SAVING MODE

If you need to use the camcorder for an extended time, the following functions enable you to prevent unnecessary energy consumption.

Quick On STBY Mode in the STBY mode

The camcorder switches to "Quick On STBY" mode when you close the LCD screen. ↪ page 81

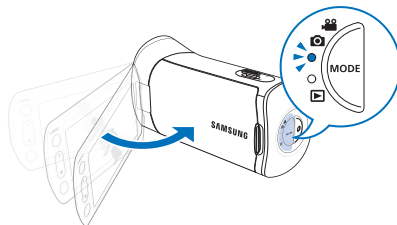

Sleep mode in the Play mode (includes the thumbnail index view)

- The camcorder switches to the sleep mode when you close the LCD screen and then, if idle for more than 20 minutes, the camcorder turns off. However, if "Auto Power Off: 5 Min" is set, the camcorder turns off in 5 minutes.
- If you open the LCD screen or connect a cable to the camcorder when the camcorder is in sleep mode, the camcorder returns to the last active operation mode.

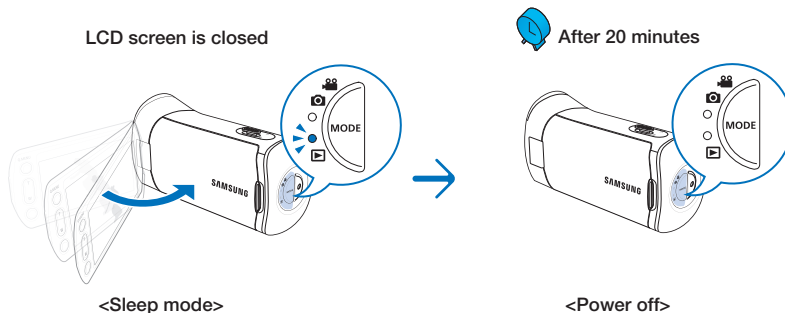

- The power saving mode does not work in the following situations:
 - When the camcorder has a cable connection. (Audio/Video cable, Mini HDMI, or USB, etc.)
 - While recording, playing back, or while running a slideshow.
 - When the LCD screen is opened.
- The camcorder consumes less battery power in the power saving mode. However, if you plan to use the camcorder for an extended time, we recommend you turn off the camcorder by pressing the **Power** (⏻) button when not using it.

basic operation of the camcorder

SETTING THE OPERATION MODES

You switch the operating mode in the following order each time you press the **MODE** button. Record mode (📹📷) ↔ Play mode (▶).

- Each time the operation mode changes, the respective mode indicator lights turn on.
- Touching the Play (▶) tab in the record mode switches the operation mode to the play mode.

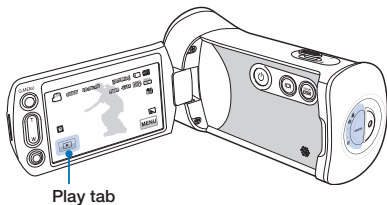

MODE button / Mode indicators

- 📹📷 (Record mode):
To record videos or photos.
- ▶ (Play mode):
To play videos or photos, or edit them.



This camcorder provides one record mode which combines the video and photo record modes. You can easily record videos or photos in the same mode without having to change modes.

USING THE DISPLAY(▶) BUTTON

When the power is on, press the **Display** (▶) button to display or hide the on-screen information or not.

Switching the information display mode

Press the **Display**(▶) button.

The full and minimum display modes alternate.

Full display mode



Minimum display mode



- Warning indicators and messages may appear depending on the recording conditions.
- The **Display** (▶) button does not work when the menu or quick menu screen is being displayed.

USING THE TOUCH PANEL

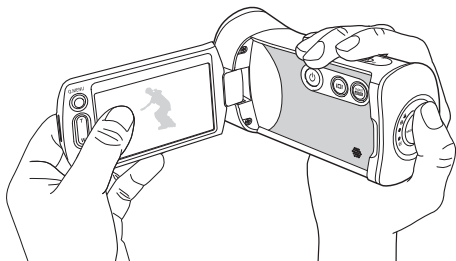

The touch panel lets you playback and record with a simple touch of your finger. Place your hand on the rear side of the LCD screen, then touch the items displayed on the screen.

Touch

Slightly touch items with your finger to select them or to execute functions.

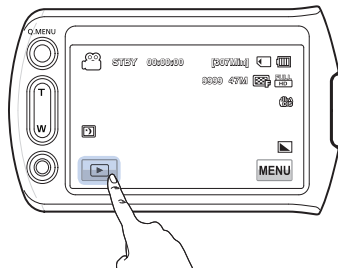

- Do not place a protective film on the LCD screen.
- If you leave a film attached to the LCD screen for a long time, strong adhesion between the film and the surface of the screen may cause a malfunction of the touch panel.



- Be careful not to accidentally press the buttons near the LCD panel while using the touch panel.
- The tabs and indicators that appear on the LCD screen depend on the current recording/playback status of your camcorder.
- The camcorder does not recognize touches if you touch more than two points on the screen at the same time. Touch one point at a time.

first time settings

SETTING THE TIME ZONE AND DATE/TIME FOR THE FIRST TIME

Set the date and time of your local area when you turn on the camcorder for the first time.

1. Open the LCD screen to turn on the camcorder.
 - The time zone ("**Home**") screen appears displaying settings for Lisbon and London (Greenwich Mean Time).
2. Select your local area on the map by touching the left (←) or right (→) tab on the LCD screen, and then press the (OK) tab.
 - The "**Date/Time Set**" screen appears.
3. Touch the date and time information, and then change the setting values by using the up (▲) or down (▼) tabs.
 - The message "**Date/Time Set**" appears.
4. Make sure the clock is correctly set, and then touch the (OK) tab.
 - The message "**Date/Time Set**" appears.

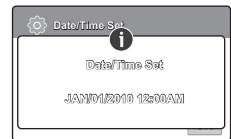
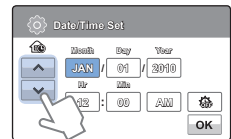

- You can set the year up to 2037, based on the "**Home**" item.
- Set "**Date/Time Display**" to On. ↪ page 77
- Activating the (⚙) icon moves the time forward by 1 hour.

🔍 Internal rechargeable battery

- Your camcorder includes a internal rechargeable battery that retains the date and time settings even after the power is turned off.
- If the battery is depleted, the current date/time values are reset to the default values. If this occurs, you need to recharge the internal rechargeable battery (see below), and then re-set the current date and time.

🔍 Charging the internal rechargeable battery

- The internal battery is always recharged while your camcorder is connected to the AC power or while the battery is attached.
- If you have not used the camcorder for about 2 weeks and you have not connected the AC power or the battery to it, the internal battery fully discharges. If this occurs, charge the internal battery by connecting the camcorder to the supplied AC adaptor for 24 hours.

SELECTING THE LANGUAGES

You can select the language of the menu or messages displayed on the LCD screen. The camcorder retains the language setting even when you turn it off.

1. Touch the Menu (MENU) → Setting (⚙️) tab.
2. Touch the up (▲)/down (▼) tab until “Language” appears.
3. Touch “Language,” and then touch the desired OSD language.
4. Touch the Exit (✕) or Return (↩️) tab to complete the setting.
 - The camcorder displays the menus and messages in the language you selected.



Supported languages

English	Português	Polski	Ελληνικά	日本語
한국어	Nederlands	Čeština	Srpski	ไทย
Français	Svenska	Slovensky	Hrvatski	Türkçe
Deutsch	Suomi	Magyar	Українська	ایرانی
Italiano	Norsk	Română	Русский	العربية
Español	Dansk	Български	中文	עברית



- “Language” options may be changed without a prior notice.
- The camcorder retains the language you select even when not connected to the battery or AC power.
- The date and time format may change depending on the language you selected.

getting ready to start recording

INSERTING / EJECTING A MEMORY CARD (NOT SUPPLIED)

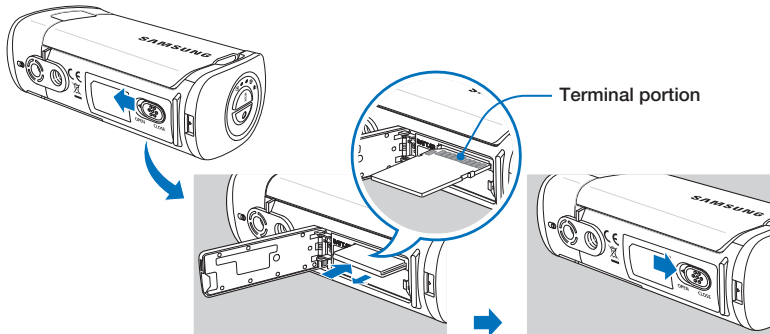

To insert a memory card

1. Open the memory card cover by sliding the **OPEN/CLOSE** switch toward **OPEN**.
2. Insert the memory card into the card slot until it softly clicks.
 - Make sure that the camcorder is placed as shown above and the terminal portion of the card is facing up.
3. Close the memory card cover by sliding the **OPEN/CLOSE** switch toward **CLOSE**.

To eject a memory card

1. Open the memory card cover by sliding the **OPEN/CLOSE** switch toward **OPEN**.
2. Gently push the memory card to eject it.
3. Close the memory card cover by sliding the **OPEN/CLOSE** switch toward **CLOSE**.



- To avoid data loss, turn off the camcorder by pressing the **Power** (⏻) button for one second before inserting or ejecting the memory card.
- Be careful not to push the memory card too hard. The memory card may suddenly pop out.



Your camcorder supports only SD (Secure Digital) and SDHC (Secure Digital High Capacity) cards. Card compatibility may vary depending on the manufacturer and the type of memory card.

SELECTING A SUITABLE MEMORY CARD (NOT SUPPLIED)

Compatible memory cards

- You can use SD (Secure Digital) and SDHC (Secure Digital High Capacity) cards with this camcorder. We recommend you use an SDHC (Secure Digital High Capacity) card. This camcorder supports SD cards up to 2GB. We cannot guarantee normal operation with SD cards bigger than 2GB.
- MMC (Multi Media Card) and MMC Plus are not supported.
- Compatible memory card capacity:
SD: 1GB ~ 2GB
SDHC: 4GB ~ 32GB
- Use compatible memory card brands. Others are not guaranteed to work. A list of compatible brands is below:
 - SDHC/SD cards: Panasonic, SanDisk, TOSHIBA
- For video recording, use a memory card that supports faster write speeds (above SDHC Class 6 card).
- SD/SDHC memory cards have a mechanical write-protection switch. Setting the switch prevents accidental erasure of files recorded on the card. To enable writing, move the switch up in the direction of the terminals. To set write protection, move the switch down.

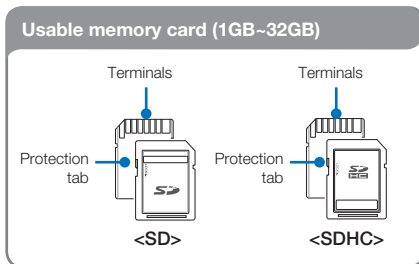

SDHC (Secure Digital High Capacity) cards

- An SDHC card is a higher version (Ver. 2.00) of the SD card and supports capacities above 2GB.
- SDHC cards cannot be used with current SD enabled host devices.

Common cautions for memory cards

- Damaged data may not be recoverable. We recommend you make a back-up of important data separately on the hard disk of your PC.
- Turning the power off or removing a memory card during an operation such as formatting, deleting, recording, and playback may cause data loss.
- If you modify the name of a file or folder stored in the memory card with your PC, your camcorder may not recognize the modified file.

getting ready to start recording

Handling a memory card

- We recommend that you power off before inserting or removing the memory card to avoid data loss.
- We can not guarantee that you can use memory cards formatted by other devices. When you format a card, be sure to format the memory card using this camcorder.
- You must format newly-purchased memory cards, memory cards with data that your camcorder cannot recognize, and cards with data saved by other devices. Note that formatting erases all data on the memory card.
- If you cannot use a memory card that has been used with another device, format it with your camcorder. Note that formatting erases all information on the memory card.
- A memory card has a certain life span. If you cannot record new data, you have to purchase a new memory card.
- Do not bend, drop, or subject the card to strong impacts.
- Do not place foreign substances on the memory card terminals. Use a soft dry cloth to clean the terminals if required.
- Do not paste anything other than the label provided with the card on the label pasting area of the card.
- Do not use a damaged memory card.
- Be careful to keep the memory card out of the reach of children, who might swallow it.

The camcorder supports SD and SDHC memory cards, giving you a wider choice of cards to choose from!

The data storage speed may differ, depending on the manufacturer and production system.

- SLC (single level cell) system: faster write speed enabled.
- MLC (multi level cell) system: only lower write speed is supported.

For best results, we recommend using a memory card that supports a faster write speed.

Using a lower write speed memory card for recording video may cause difficulties when storing.

You may even lose your video data during the recording.

In an attempt to preserve every bit of the recorded video, the camcorder forcibly stores the video on the memory card and displays a warning:

“Low speed card. Please record at a lower resolution.”

If you are unavoidably using a low speed memory card, the resolution and quality of the recording may be lower than the value you set. ↪page 50

The higher the video resolution and quality, the more memory the camcorder uses.



- Samsung is not responsible for data loss due to misuse, including loss caused by any PC virus.
- We recommend using a memory card case to avoid data loss that can be caused by moving the card or by static electricity.
- After a period of use, the memory card may get warm. This is normal and is not a malfunction.

RECORDABLE TIME AND CAPACITY

Listed below are the available video recording times and the number of photos the camcorder can take, by card memory size and resolution. Refer to the recordable video time and the number of photos when recording videos or taking photos.

Recording time available for video in minutes

Resolution	Quality	Storage media (Capacity)					
		1GB	2GB	4GB	8GB	16GB	32GB
1080/60i	Super Fine	8	15	30	61	125	253
	Fine	9	18	36	74	152	307
	Normal	12	23	46	94	193	390
720/60p	Super Fine	11	21	42	86	177	357
	Fine	14	28	57	115	235	475
	Normal	21	42	84	171	351	708
480/60p	Super Fine	32	63	126	254	521	1051
	Fine	42	83	166	336	688	1387
	Normal	62	123	244	494	1011	2039

(Unit: Approximate minutes of recording)

Recordable number of photos

Resolution	Storage media (Capacity)					
	1GB	2GB	4GB	8GB	16GB	32GB
2880x1620	656	1251	2482	5014	9999	9999
1920x1080	1173	2346	4654	9402	9999	9999

(Unit: Approximate number of images)

1GB \approx 1,000,000,000 bytes : Actual formatted capacity may be less as the internal firmware uses a portion of the memory.



- Actual recording times may differ depending on the recording conditions and the subject.
- The higher the quality and resolution, the more memory is used.
- Lower resolution and quality increases the recording time, but the image quality may suffer.
- The bit rate automatically adjusts to the recording image. Accordingly, the recording time may vary.
- Memory cards bigger than 32GB may not operate normally.
- When a video file exceeds 1.8GB, a new video file is created automatically.
- The maximum number of recordable photo and video files is 9999 respectively.

getting ready to start recording

USING THE HAND STRAP

Attach the strap and place your hand through the loop to prevent the camcorder from being dropped.

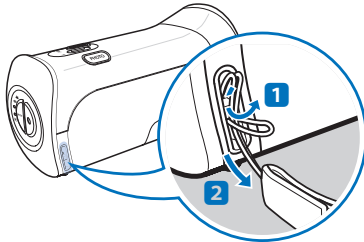

Insert the end of the hand strap into the hook of the camcorder as shown in the illustration.

ADJUSTING THE LCD SCREEN

The wide LCD screen on your camcorder offers high quality image viewing.

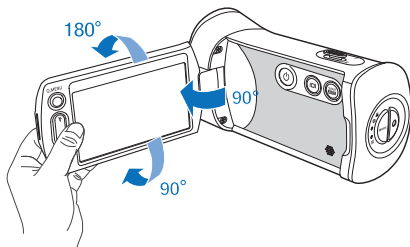

1. Open the LCD screen with your finger.
 - The screen opens up to 90°.
2. With the LCD screen open 90°, rotate it forwards (towards the lens) or backwards.
 - You can rotate it up to 180° towards the lens and up to 90° backward. To view recordings more conveniently, rotate the screen by 180° towards the lens, and then fold it back to the body.



Excessive rotation may damage the connective hinge between the screen and the camcorder.



Clean fingerprints or dust on the screen with a soft cloth.

BASIC CAMCORDER POSITIONING

Use both hands while taking a video or photo to prevent the camcorder from shaking. Try to avoid any slight movement while shooting.



Aim the camcorder as shown in the illustration.

1. Loop the hand strap around your wrist.
2. Hold the camcorder with both your hands.
3. Make sure your footing is stable and there is no danger of colliding with another person or object.
4. Aim and focus as shown in the illustration.

Adjusting the shooting angle

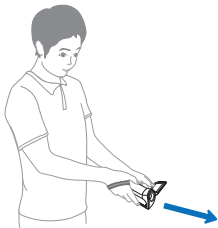

<Low angle>



<High angle>

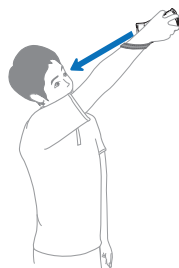

<Self-recording>



- This camcorder's lens angle is approx. 20° higher than the rest of the camcorder body. When you record, this prevents strain on the wrist and allows you to record videos in a comfortable position with a clear view of your subjects while you record.
- Make sure the camcorder lens is angled for proper shooting.
- We recommend you keep the sun behind you while shooting.

basic recording

RECORDING VIDEOS

This camcorder supports both High Definition (HD) and Standard Definition (SD) image resolutions. Set the resolution you want before recording. ↪page 50

PRECHECK!

- Insert a memory card. ↪page 28
- Select the record mode by pressing the **MODE** button. ↪page 24

Two recording start/stop buttons to suit your preference!

This camcorder features two **Recording start/stop** buttons. One is on the rear side of the camcorder, the other is on the LCD screen. Select the one that works best for you.

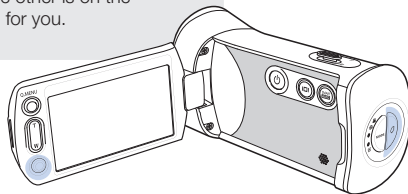

1. Select a subject to record.
 - Adjust the LCD panel to the best angle for recording.
 - Use the **Zoom** lever or **Zoom** button to adjust the size of the subject. ↪page 39
2. Press the **Recording start/stop** button.
 - The recording (●) indicator appears, and recording starts.
3. To stop recording, press the **Recording start/stop** button again.
4. Touch the Quick View (▶) icon to view the most recently recorded video.
 - After the Quick View is complete, your camcorder returns to the standby mode.

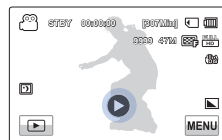



- If power is interrupted or an error occurs during recording, the video may not be recorded/edited.
 - Samsung is not responsible for any damage caused by a failure of normal recording or playback operations because of a memory card error.
 - Note that damaged data cannot be recovered.
 - Do not turn off the camcorder or remove the memory card while the camcorder is accessing the memory card. Doing so may damage the memory card or the data in the memory card.
-



- Videos are compressed in the H.264 (MPEG-4.AVC) format.
 - Eject the battery when you have finished recording to prevent unnecessary battery power consumption.
 - For the on-screen information display, see page 14
 - For approximate recording time, see page 31.
 - Sound is recorded by the internal stereo microphone located on the front of the camcorder. Make sure that the microphone is not blocked.
 - Before recording an important video, make sure to test the recording function to see if there are any problems with the audio or video recording.
 - For various functions available during recording, see pages 49–65
 - If the power cable/battery is disconnected or recording is interrupted, the camcorder switches to the data recovery mode. While data is being recovered, no other function is enabled.
 - You can adjust the brightness of the LCD screen in the menu options. Adjusting the LCD screen does not affect the image being recorded. ↪ page 77
 - In the record mode, you can set the Quick View menu option. The Quick View icon appears when you have set the Quick View menu option to On.
 - The menu setting tabs shown on the LCD screen do not affect the image the camcorder is recording.
-

basic recording

CAPTURING PHOTOS DURING VIDEO RECORDING

Your camcorder can capture photos without interrupting video recording.

PRECHECK!

- Insert a memory card. ↪page 28
- Select the record mode by pressing the **MODE** button.
↪page 24

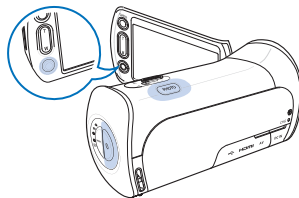

1. Press the **Recording start/stop** button.
 - The recording (●) indicator appears, and recording starts.
2. While recording the video, frame the scene you want to photograph, and then press the **PHOTO** button.
 - When the (▶▶▶) indicator disappears, the camcorder has recorded the photo image without a shutter sound.
 - Video keeps recording, even while you take photos.
3. To stop recording, press the **Recording start/stop** button again.



- Photos are captured in 1920x1080 resolution regardless of the resolution of the video recording.
 - When the HDMI cable is connected to the camcorder, you cannot capture a photo while recording a video.
-

RECORDING PHOTOS

You can take photos and store them in the storage media. Set the desired resolution before recording. ↪ page 51

PRECHECK!

- Insert a memory card. ↪ page 28
- Select the record mode by pressing the **MODE** button. ↪ page 24

1. Select a subject to record.
 - Adjust the LCD panel to the best angle for recording.
 - Use the **Zoom** lever or **Zoom** button to adjust the size of the subject. ↪ page 39
2. Frame the subject in the LCD screen, and then half-press the **PHOTO** button.
 - When the subject is in focus, (●) indicator appears green. If it appears red, readjust the focus.
3. Fully press the **PHOTO** button.
4. Touch the Quick View (▶) icon to view the most recently recorded photo.
 - To return to the standby mode, touch the Return (◀) tab.

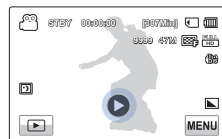
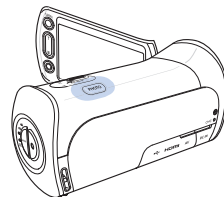

Do not turn off the camcorder or remove the memory card when taking photos as it may damage the storage media or data.



- The recordable number of photos varies depending on the recording conditions and the photo resolution. ↪ page 31
- The camcorder does not record audio when you take photos.
- If focusing is difficult, use the manual focus function. ↪ page 57
- For the on-screen display information, see page 14.
- Adjust the brightness of the LCD screen using menu items. Adjusting the brightness does not affect the recorded image. ↪ page 77
- For various functions available during recording, see pages 49–65
- Photo files conform to the DCF (Design rule for Camera File system) standard, established by JEITA (Japan Electronics and Information Technology Industries Association).





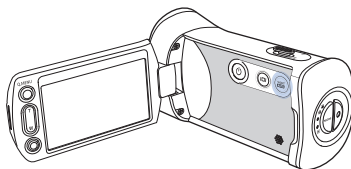

basic recording

RECORDING WITH EASE FOR BEGINNERS (SMART AUTO)

In Smart Auto mode, your camcorder automatically chooses the appropriate settings based on the type of scene it detects (Indoor, Night, etc.). Smart Auto mode is helpful if you are not familiar with the best camcorder settings for various scenes.

1. Press the **SMART AUTO** button.
 - The Smart Auto (SMART AUTO) and Anti-shake(OIS) (OIS) icon appear on the LCD screen.
2. Align your subject in the frame.
 - The camcorder automatically detects the scene when you align the subject.
 - The appropriate scene icon appears on the LCD screen.



	Appears when recording a very bright scene. (White)
	Appears when recording an outdoor scene. (Landscape)
	Appears when recording indoors. (Indoor)
	Appears when recording at night. (Night)
	Appears when recording a close-up. (Macro)
	Appears when recording images of landscapes with backlighting. (Backlight)



<When recording a close-up>

3. Press the **Recording start/stop** button or **PHOTO** button. → pages 34, 37
4. To cancel Smart Auto mode, press the **SMART AUTO** button again.



- **Buttons unavailable during Smart Auto operation:** Menu (MENU) tab / Q.MENU button/ etc. Most settings are automatically adjusted in Smart Auto mode. To set or adjust functions on your own, release the Smart Auto mode first.
- You can not access Smart Auto mode while recording. You must set this function before recording.
- When the camcorder fails to recognize the recording situation, it records in the basic settings (SMART AUTO).
- The camcorder may not select the correct scene depending on shooting conditions, such as camcorder shake, lighting, and distance to the subject.
- If the camcorder detects more than one scene at the same time, Smart Auto prioritizes as follows: Backlight → Macro → White → Landscape → Night → Indoor
For example, a) If White and Indoor can be applied at the same time, then White is selected and the corresponding icon appears.
b) If White and Landscape can be applied at the same time, then White is selected and the corresponding icon appears.

ZOOMING

This camcorder allows you to record using optical 10x power zoom and digital zoom by sliding the **Zoom** lever or pressing the **Zoom** button on the LCD panel.

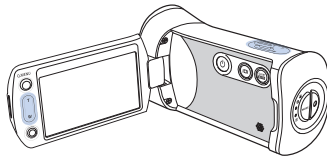

To zoom in

Press the **T** (zoom) button on the LCD panel or slide the zoom lever towards **T** (telephoto).

- The distant subject is gradually magnified.
- The highest zoom magnification ratio is 10x in the normal zoom-in.

To zoom out

Press the **W** (zoom) button on the LCD panel or slide the zoom lever towards **W** (wide angle).

- The subject gets smaller and further away.
- The smallest optical zoom ratio is the subject's original size when zoomed-out.

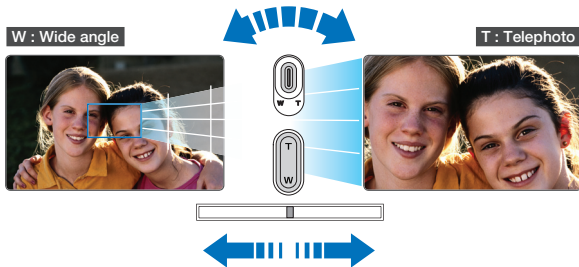

Zoom speed

When using the zoom function, you can decrease zoom speed by slowly moving the Zoom (W/T) lever. Moving it faster increases the zoom speed. However, you cannot adjust the zoom speed when using the Zoom (W/T) button on the LCD panel.



- Using the optical zoom does not degrade the image quality and clarity.
- Use the digital zoom when you want to zoom more than the optical zoom range. ↪ page 63
- Focusing may become unstable when you record with a fast zoom or zoom into a subject standing too far away. If this occurs, use the manual focus function. ↪ page 57
- The minimum distance you can have between the camcorder and subject while maintaining sharp focus is about 1cm (about 0.4 inches) for wide angle and about 50cm (about 19.7 inches) for telephoto. If you want to shoot the subject close to the lens at a wide angle, use the Tele Macro function. ↪ page 61
- When using the zoom function and holding the camcorder with your hand, use Anti-shake(OIS) for stable recording. ↪ page 58
- Frequent use of the zoom function consumes more power.
- The camcorder can record the sound of the zoom mechanism.

basic playback

CHANGING THE PLAYBACK MODE

- You can set the record mode and the play mode in turn with the **MODE** button. You can also switch the operation mode directly into the playback thumbnail display by touching the Play (▶) tab on the LCD screen.
- The most recently created file is highlighted in the thumbnail view.
- The camcorder selects the thumbnail display options based on the standby mode that was last used. However, you can choose the video (HD or SD) or photo (A) thumbnail view display options by touching the HD (▶HD), SD (▶SD), or photo (▶A) tab on the LCD screen.



Understanding how to change the operation modes

You can easily change the operation modes by touching the LCD screen or using the buttons as shown in the following figures:

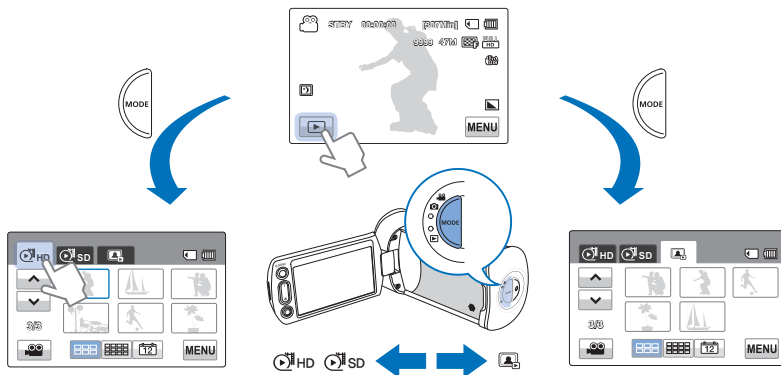

To change thumbnail display type

You can choose from these thumbnail display options: 3x2 (▶▶▶), 4x3 (▶▶▶▶), and Date (▶▶▶▶).

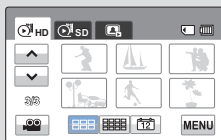

<3X2 type>

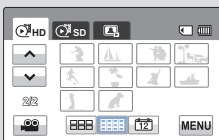

<4X3 type>

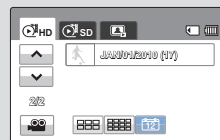

<Sorted by date>

PLAYING BACK VIDEOS

You can preview recorded videos in the thumbnail index view, find the video you want quickly, and playback directly.

PRECHECK!

- Insert a memory card. ↪page 28
- Touch the Play (▶) tab on the LCD screen to select the play mode. ↪page 40

1. Touch the HD (HD) or SD (SD) tab.
 - Video thumbnails corresponding to the video resolution you selected appear on the screen.
 - To change the current thumbnail page, touch the up (▲) or down (▼) tab.
2. Touch the thumbnail of the desired video clip.
 - The camcorder plays the video you selected and playback control tabs appear briefly. They reappear when you touch anywhere on the screen.
 - To stop playback and return to the thumbnails, touch the Return (◀) tab.

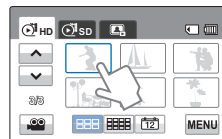

Do not power off the camcorder or eject the memory card during video playback. Doing so may damage the recorded data.



- It may take some time to start playback, depending on the size and quality of the selected video.
- The camcorder may not play the following video files:
 - A video recorded on another device.
 - A video whose file format is not supported by the camcorder.
- You can use various play options during the video playback. ↪page 42
- You can set playback settings using the "Play Option" menu. ↪page 66
- You can play the recorded videos on a TV or PC. ↪pages 87, 98
- If you touch the Menu (MENU) tab or **Q.MENU** button during playback, play is paused and the menu screen appears.

basic playback

Various playback operations

Playback / Pause / Stop

- Playback and pause alternate when you touch the Pause (⏸) / Play (▶) tab during playback.
- Touch the Return (⏮) tab to stop playback.

Search playback

During playback, each touch of the Reverse search (⏮) / Forward search (⏭) tab increases the play speed:

- RPS (Reverse Playback Search)/FPS (Forward Playback Search) rate:
x2 → x4 → x8 → x2

Skip playback

Touch the Reverse skip (⏮) / Forward skip (⏭) tab during playback.

- Touching the Forward skip (⏭) tab plays the next video.
- Touching the Reverse skip (⏮) plays the beginning of the scene. If you touch the Reverse skip (⏮) for three seconds or less after a video starts, the camcorder plays the previous video.
- Place and hold your finger on the Reverse skip (⏮) / Forward skip (⏭) tab to search for a video number quickly. When you lift off your finger, the camcorder plays the video you selected.

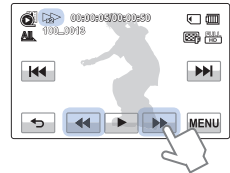

Slow playback

When playback is paused, touching the Reverse slow (◀) / Forward slow (▶) tab reduces the playback speed:

- Reverse/forward playback slow rate: x1/2 → x1/4 → x1/8 → x1/2

Frame by frame playback

When playback is paused, touch the Reverse frame advance (◀) / Forward frame advance (▶) to make the video go in reverse or forward one frame at a time.

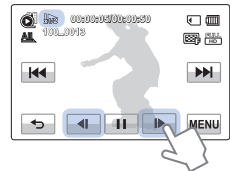

To adjust the volume

You can hear the recorded sound from the internal speaker.

1. Touch the Volume (🔊) tab on the LCD screen.
2. Touch the (–)/(+) tab to increase or decrease audio volume.
 - You can adjust the sound level between "0~19." When the level is at "0," you cannot hear sound.

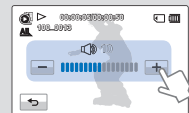

- Touch the Play (▶) tab to play back in normal speed.
- You can hear the recorded sound only when you playback at normal speed.

VIEWING PHOTOS

You can view recorded photos using various playback functions.

PRECHECK!

- Insert a memory card. ↪page 28
- Touch the Play (▶) tab on the LCD screen to select the play mode. ↪page 40

1. Touch the Photo (🖼️) tab.
 - The thumbnail view appears.
 - To change the current thumbnail page, touch the up (⬆️) or down (⬇️) tab.
2. Touch the photo you want to display.
 - The camcorder displays the photo you selected in full screen and playback control tabs appear briefly. They reappear when you touch anywhere on the screen.
3. To return to the thumbnails, touch the Return (⏪) tab.

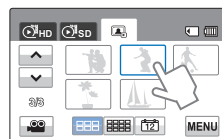
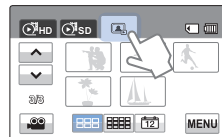

Do not power off the camcorder or eject the memory card during photo playback. Doing so may damage the recorded data.





- Loading time may vary depending on the size and quality of the photo you selected.
- Your camcorder may not play back the following photo files normally:
 - A photo recorded on another device.
 - A photo with a file format not supported by this camcorder. (One that does not conform to DCF standards.)
- Touch previous image (⏪) / next image (⏩) tab to view the previous and next photo.

basic playback

Viewing a slide show

You can view a photo slide show with background music.



Touch the Slide Show () tab during photo playback.

- The () indicator appears. The slide show starts from the current selected photo.
- To stop the slide show, touch the Return () tab.

To start a slide show in the menu screen

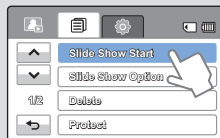



Touch the Menu () tab →
"Slide Show Start."



- All photos are played back depending on the slide show options. →page 68
- If you select the thumbnail display by date (), the camcorder plays back only photos taken on the corresponding date in the slide show.
- You can adjust the background music's volume level using the Volume () tab while playing back the slide show with music.

Zooming during photo playback

You can magnify a playback image. Touch up/down/left/right to select the area to magnify.

1. Touch the photo you want to magnify.
 - The camcorder displays the selected photo on the full screen.
2. Adjust the magnification with the **Zoom (W/T)** button or **Zoom (W/T)** lever.
 - Magnification starts from the center of the photo.
 - You can zoom in from x1.1 to x8.0.
3. Touch the up ()/down ()/left ()/right () tab to view the area you want on the magnified photo.
4. To cancel, touch the Return () tab.



- Photos recorded on other devices or those edited on a PC cannot be magnified.
- While the playback zoom is in use, other images cannot be selected.

using the menu items

HANDLING MENUS AND QUICK MENUS

The instructions below are examples of how to access and use menu items using the Menu Tab and the **Q.MENU** Button. When you access and use other menu items, use these examples as guides.

PRECHECK!

- Insert a memory card. ↗page 28
- Select the record mode by pressing the **MODE** button. ↗page 24

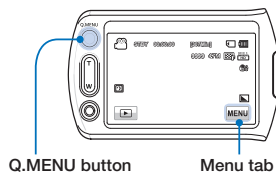

Using the Menu (MENU) tab

1. Touch the Menu (MENU) tab on the touch panel.
 - The menu screen appears.
 - To change the current page, touch the up (▲)/down (▼) tab.
2. Touch “iSCENE.” (The iSCENE function is used here as an example.)
3. Touch the desired option.
 - Adjust the setting values accordingly.
 - To exit the menu, touch the Exit (X) or Return (↶) tab.

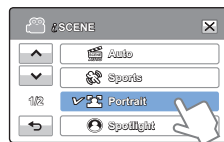

Using the Q.MENU button

Quick menu enables you to access your favorite functions quickly. You can easily select the desired menu with one-touch.

1. Press the **Q.MENU** button on your camcorder to see the available menu options.
 - The quick menu screen appears.
2. Touch “Focus.” (The Focus function is used here as an example.)
3. Touch the desired option.
 - Adjust the setting values accordingly.
 - To exit the menu, touch the Exit (X) or Return (↶) tab.

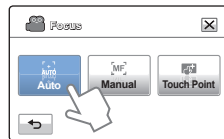
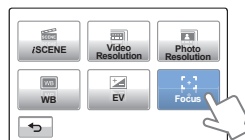

- When using Menu or Quick menu items, some menu items can not be used at the same time, or may be grayed out. For more information, see Troubleshooting on page 112.
- For easy understanding, the menu setting procedures on this page are explained using the simplest methods. Menu setting methods can differ depending on the menu options you choose.

using the menu items

MENU ITEMS

- The items available in each menu vary depending on the operating mode.
- For item operation details, see the page number listed under Page in the table.

Recording menu items

Items	Default value	Page
SCENE	Auto	49
Video Resolution	1080/60i	50
Video Quality	Fine	50
Photo Resolution	2880x1620	51
Photo Sharpness	Normal	51
White Balance	Auto	52
Aperture	Auto	53
Shutter	Auto	54
EV	0	55
Super C.Nite	Normal	55
Back Light	Off	56
Focus	Auto	57
Anti-Shake(OIS)	On	58
Digital Effect	Off	59
Fader	Off	60
Tele Macro	Off	61
Cont. Shot	Off	62
Wind Cut	Off	62
Digital Zoom	Off	63
Self Timer	Off	63
Quick View	On	64
Guideline	Off	65

Playback menu items

Operation mode Items		Video		Photo		Default value	Page
		Thumbnail	Single	Thumbnail	Single		
Play Option		●	●	X	X	Play All	66
Highlight		●	●	X	X	-	67
Delete		●	●	●	●	-	69
Protect		●	●	●	●	Off (Single)	70
Edit	Divide	●	●	X	X	-	71
	Combine	●	X	X	X	-	72
File Info		●	●	●	●	-	68
Slide Show Start		X	X	●	●	-	44
Slide Show Option		X	X	●	●	-	68

● : available, X : not available



- Menu options and default values may be changed without prior notice.
- Some grey colored menu options cannot be selected. ➔page 112

using the menu items

QUICK MENU ITEMS

- The items available in each menu vary depending on the operating mode.
- For item operation details, see the page number listed under Page in the table.

Recording menu items

Items	Default value	Page
iSCENE	Auto	49
Video Resolution	1080/60i	50
Photo Resolution	2880x1620	51
WB	Auto	52
EV	0	55
Focus	Auto	57

Playback menu items

Item	Operation mode	Video		Photo		Page
		Thumbnail	Single	Thumbnail	Single	
	Highlight	●	●	X	X	67
	Delete	●	●	●	●	69
	Protect	●	●	●	●	70
Edit	Divide	●	●	X	X	71
	Combine	●	X	X	X	72
	File Info	●	●	●	●	68

● : available, x : not available



Menu options and default values may be changed without a prior notice.

advanced recording

iSCENE

Using the iScene function, you can select a setting that matches the scene you are shooting (Sports, Portrait, etc.). Based on your selection, the camcorder sets the appropriate shutter speed and aperture automatically for optimal recording.

PRECHECK!

Select the record mode by pressing the **MODE** button. ↪ page 24

1. Touch the Menu (MENU) tab → “iSCENE.”
2. Touch the desired submenu item.
 - To change the current page, touch the up (▲)/down (▼) tab.
3. To exit the menu, touch the Exit (X) or Return (↩) tab.



Submenu items

- **Auto**: For recording under normal conditions.
- **Sports** (♾): For recording people or objects in motion.
- **Portrait** (♀): For recording portraits. Captures natural skin tones.
- **Spotlight** (☀): When strong light strikes the subject. On stage, for example.
- **Beach/Snow** (☑): Where the reflection of light is intense such as a snowfield or beach.
- **Food** (🍴): To make food more colorful.
- **Candle Light** (🕯): For recording in the soft glow of candlelight.
- **Indoor** (🏠): For recording indoors with artificial light.



When you specify “Aperture: Manual” or “Shutter: Manual,” the iSCENE mode is cancelled.

advanced recording

Video Resolution

You can select the resolution of the video to be recorded.

PRECHECK!

Select the record mode by pressing the **MODE** button. ↪ page 24

1. Touch the Menu (MENU) tab → **“Video Resolution.”**
2. Touch the desired submenu item.
3. To exit the menu, touch the Exit (X) or Return (↩) tab.

Submenu items

- **1080/60i** (1080/60i): Records in the HD (1920x1080/60i) format.
- **720/60p** (720/60p): Records in the HD (1280x720/60p) format.
- **480/60p** (480/60p): Records in the SD (720x480/60p) format.



- “60i” indicates the camcorder will record in interlaced scan mode at 60 fields per second.
- “60p” indicates the camcorder will record in progressive scan mode at 60 frames per second.
- Recorded files are encoded using Variable Bit Rate (VBR). VBR is an encoding system that automatically adjusts the bit rate in response to the image being recorded.
- The available video recording time differs according to the video resolution you select. ↪ page 31

Video Quality

You can select the quality of the video to be recorded.

PRECHECK!

Select the record mode by pressing the **MODE** button. ↪ page 24

1. Touch the Menu (MENU) tab → **“Video Quality.”**
2. Touch the desired submenu item.
3. To exit the menu, touch the Exit (X) or Return (↩) tab.

Submenu items

- **Super Fine** (Super Fine): Records videos in super fine image quality.
- **Fine** (Fine): Records videos in fine image quality.
- **Normal** (Normal): Records videos in normal image quality.



The higher the resolution is, the shorter the available recording time. On the other hand, the lower the resolution, the longer the available recording time.

Photo Resolution

You can select the resolution of the photo to be recorded.

PRECHECK!

Select the record mode by pressing the **MODE** button. ↪ page 24

1. Touch the Menu (MENU) tab → “**Photo Resolution.**”
2. Touch the desired submenu item.
3. To exit the menu, touch the Exit (X) or Return (↵) tab.



Submenu items

- **2880x1620 (47M)**: Records in the 2880x1620 resolution.
- **1920x1080 (24M)**: Records in the 1920x1080 resolution.



- The number of recordable images differs according to the photo resolution you select. ↪ page 31
- Photos that are recorded on your camcorder may not playback properly on other digital devices that do not support these photo sizes.

Photo Sharpness

This function lets you create more sharper or softer image by processing the captured image when you take a photo.

PRECHECK!

Select the record mode by pressing the **MODE** button. ↪ page 24

1. Touch the Menu (MENU) tab → “**Photo Sharpness.**”
2. Touch the desired submenu item.
3. To exit the menu, touch the Exit (X) or Return (↵) tab.

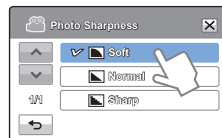

Submenu items

- **Soft** (☹): Smooths the edges of photo images. Makes image softer.
- **Normal** (☺): The photo images appear with sharp edges and are suitable for printing.
- **Sharp** (☹): Sharpens the edges in photo images further.

advanced recording

White Balance

Using the White Balance function, you can select a setting that matches the light illuminating the subject you are shooting (Daylight, Fluorescent, etc.). Based on your selection, the camcorder automatically adjusts the color of the subject so the whites and colors in your recording or photo look natural.

PRECHECK!

Select the record mode by pressing the **MODE** button. → page 24

1. Touch the Menu (MENU) tab → “White Balance.”
2. Touch the desired submenu item.
3. To exit the menu, touch the Exit (X) or Return (RETURN) tab.

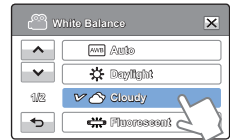

Submenu items

- **Auto:** Controls the white balance automatically in response to lighting conditions.
- **Daylight (☀):** For recording outdoors in clear, natural light.
- **Cloudy (☁):** For recording in the shade or cloudy weather.
- **Fluorescent (💡):** For recording under white fluorescent lights.
- **Tungsten (💡):** For recording under halogen lamps and incandescent lights.
- **Custom WB (🔧):** Lets you adjust the white balance manually to match the light source or situation.

Understanding White Balance

The White Balance (WB) process removes unrealistic color casts, so that white objects are rendered white in your image and all other colors look natural. Proper white balance has to take into account the “color temperature” of a light source, which refers to the relative warmth or coolness of white light.

To set the white balance manually

1. Touch the Menu (MENU) tab → “White Balance” → “Custom WB.”
 - The “(🔧) Set White Balance” indicator appears.
2. Fill the screen with a white subject, and then touch the (OK) tab.
 - The camcorder stores the white balance setting.
3. To exit the menu, touch the Exit (X) or Return (RETURN) tab.
 - The camcorder applies the stored white balance the next time you record.

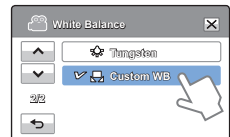

- When setting the white balance manually, the subject must be white, otherwise, your camcorder may not detect an appropriate setting value.
- The adjusted setting remains until you set the white balance again.
- During normal outdoor recording, setting White Balance to “Auto” may provide better results.
- Cancel the digital zoom function for clear and precise white balance setting. → page 63
- Reset the white balance if light conditions change.

Aperture

The camcorder adjusts the aperture (lens opening) automatically depending on the subject and recording conditions. You can also manually adjust the aperture.

PRECHECK!

Select the record mode by pressing the **MODE** button. → page 24

1. Touch the Menu (MENU) tab → “Aperture.”
2. Touch the desired submenu item.
3. To exit the menu, touch the Exit (X) or Return (↵) tab.

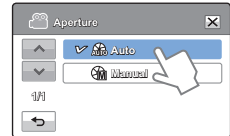

Submenu items

- **Auto:** Sets the aperture value automatically.
- **Manual (M):** Touch the decrease (←) or increase (→) tab to adjust the aperture. You can choose from the following settings:
F1.8, F2, F2.8, F4, F5.6, F8, F11, F16

Understanding Aperture

You can adjust the aperture value to control the amount of light reaching the image sensor. The smaller the aperture value, the greater the amount of light. For example, F1.8 lets in more light than F2.8. You need to adjust the aperture value in the following cases:

- When you are shooting against the light or when the background is too bright.
- When you are shooting on a reflective natural background such as at the beach or when skiing.
- When the background is overly dark (for example, scenery at night).



- When you specify “Aperture: Manual,” the **tSCENE** mode is cancelled, “Super C.Nite” is set to “Off,” and “Shutter” is set to “Auto” automatically.
- If the aperture is set to manual, the aperture value changes depending on the zoom level you change.

advanced recording

Shutter

The camcorder automatically sets the shutter speed depending on the scene's brightness. User high shutter speeds to record fast moving objects and low shutter speeds to record slow or stationary objects or objects in dimmer light.

PRECHECK!

Select the record mode by pressing the **MODE** button. ↪ page 24

1. Touch the Menu (MENU) tab → “Shutter.”
2. Touch the desired submenu item.
3. To exit the menu, touch the Exit (X) or Return (↩) tab.

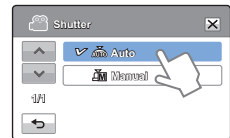

Submenu items

- **Auto:** The camcorder automatically sets the appropriate shutter speed value.
- **Manual (M):** Touch the decrease (←) or increase (→) tab to adjust the setting values. You can choose from the following settings: 1/60, 1/100, 1/250, 1/500, 1/1000, 1/2000, 1/4000, or 1/10000.



- The image may not seem smooth when you set a high shutter speed.
 - When recording at a shutter speed of 1/1000 or lower, make sure the sun is not shining directly into the lens. As the shutter speed gets slower, the camcorder can be harmed by too much light.
 - When you specify “Shutter: Manual,” the **iSCENE** mode is cancelled, “Super C.Nite” is set to “Off,” and “Aperture” is set to “Auto” automatically.
 - Even if the shutter speed is set to 1/10000, the camcorder supports only up to 1/2000 while recording photos.
-

EV

Depending on the intensity of the ambient light, your videos and photos may be too bright or dark. Using the EV function, you can manually adjust video and photo image brightness.

PRECHECK!

Select the record mode by pressing the **MODE** button. → page 24

1. Touch the Menu (MENU) tab → “EV.”
2. Touch the decrease (−) or increase (+) tab to adjust the setting values. You can choose from the following settings:
 - EV values (☑): -2.0, -1.6, -1.3, -1.0, -0.6, -0.3, 0, +0.3, +0.6, +1.0, +1.3, +1.6, +2.0
3. To exit the menu, touch the Exit (X) or Return (↩) tab.

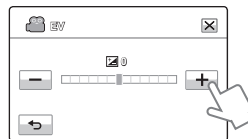

Understanding EV (Exposure Value)

Exposure value is the total amount of light allowed to fall on the photographic medium (Image sensor) during the process of taking photos or videos. The higher the number, the greater the exposure. For example, + 0.3 lets in more light than -0.3.



Super C.Nite

Use to get better images of slowly moving subjects or subjects in dark places. When you turn the Super C.Nite function on, the camcorder adjusts the shutter speed so that the images are brighter without compromising color.

PRECHECK!

Select the record mode by pressing the **MODE** button. → page 24

1. Touch the Menu (MENU) tab → “Super C.Nite.”
2. Touch the desired submenu item.
3. To exit the menu, touch the Exit (X) or Return (↩) tab.

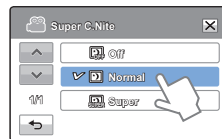

Submenu items

- **Off:** Disables the function.
- **Normal (☑):** The shutter opens for 1/60 of a second in the normal mode and automatically switches to open for 1/30 of a second in a dark place. Use this function to get bright images in a dark place.
- **Super (☑):** The shutter opens for 1/15 of a second regardless of surrounding conditions. Use this function to get bright images in a darker place.

advanced recording

Back Light

When a subject is lit from behind, this function compensates for back lighting so that the subject does not appear too dark.

PRECHECK!

Select the record mode by pressing the **MODE** button. → page 24

1. Touch the Menu (MENU) tab → “Back Light.”
2. Touch the desired submenu item.
3. To exit the menu, touch the Exit (X) or Return (↩) tab.

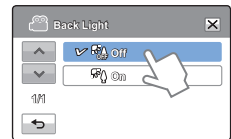

Submenu items

- **Off:** Disables the function.
- **On (☀️):** Backlight compensation brightens the subject.

🔍 Back lighting causes the subject to be darker than the background

It typically occurs when:

- The subject is in front of a window.
- The person you want to record is wearing white or shiny clothes and is placed against a bright background. The person's face is too dark to distinguish his/her features.
- The subject is outdoors and the background is overcast.
- The light sources are too bright.
- The subject is in front of a snowy background.



Focus

The camcorder usually focuses on a subject automatically (auto focus). When you turn the camcorder on, focus is always set to automatic. You can also set the focus manually.

PRECHECK!

Select the record mode by pressing the **MODE** button. → page 24

1. Touch the Menu (MENU) tab → "Focus."
2. Touch the desired submenu item.
3. To exit the menu, touch the Exit (X) or Return (↩) tab.

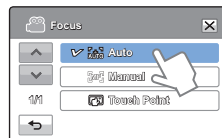

Submenu items

- **Auto:** In most situations, it is better to use the automatic focus feature, as it lets you concentrate on the creative side of your recording.
- **Manual (∞):** You may need to focus manually under conditions in which automatic focusing is difficult or unreliable. Touch (←∞) or (∞→) tab to adjust the focus.
- **Touch Point (TP):** To focus on a subject shown on the LCD screen, simply touch the subject on the screen.

Focusing manually during recording

Your camcorder automatically focuses a subject from close-up to infinity. However, the camcorder may not focus correctly, depending on the recording conditions. If it does not focus correctly, use the manual focus mode. To adjust the focus, place and hold your finger on the (←∞) for a nearer subject, and on the (∞→) tab for a farther subject.

- The nearer or farther icon (∞ / ∞) appears in the center when focus adjustment reaches the end.
- The camcorder applies the adjusted value right after you touch the (←∞) or (∞→) tab.

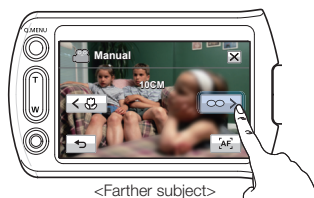

Scenes to set focus manually for

- Scenes containing several objects, some close to the camcorder, others farther away.
- Scenes with a person enveloped in fog or surrounded by snow.
- Scenes which contain very shiny or glossy surfaces such as that of a car.
- Scenes with people or objects moving constantly or quickly such as athletic events or crowd scenes.

advanced recording

Using the touch point function

Using the Touch Point function, you can have the camcorder focus on a small section of the picture. You get the camcorder to focus on a particular point by touching the desired point on the LCD screen.

To activate the touch point with a long touch

You can activate touch point by lightly pressing a particular point on the LCD screen for about 2 seconds.

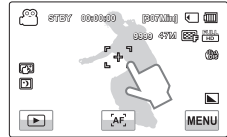

- The Auto Focus (AF) setting is useful when you operate the zoom function because you might not be able to keep accurate focus after the zoom ratio has been changed.
- In the manual focus setting menu screen, you can access auto focus by touching the AF (AF) tab on the screen. You can return to manual focus by touching the manual focusing tabs.
- If you have enabled the Touch Point function, you can reset the focus to **Auto** by touching the AF (AF) tab on the LCD screen.

Anti-Shake (OIS: Optical Image Stabilizer)

Smart OIS improves on existing Optical Image Stabilization by allowing the camcorder lens to shift over wider range of motion in wide/tele zoom position. This allows the camcorder to compensate for greater degrees of camcorder shake and delivers a stunning level of image smoothness.

PRECHECK!

Select the record mode by pressing the **MODE** button. → page 24

1. Touch the Menu (MENU) tab → “Anti-Shake(OIS).”
2. Touch the desired submenu item.
3. To exit the menu, touch the Exit (X) or Return (RETURN) tab.



Submenu items

- **Off**: Disables the function.
- **On (On)**: The Anti-Shake(OIS) function is enabled to compensate for shaking.

Use the Anti-Shake(OIS) function in the following cases

- When recording while walking or riding in a moving car.
- When recording with the zoom function.
- When recording subjects of a small size.





- When you turn on Smart Auto mode, it automatically sets Anti-shake (OIS) to On.
- The Anti-Shake (OIS) function may not correct gross camcorder shake entirely. To decrease shake, hold the camcorder firmly with both hands.
- When this function is On, the actual movement of the subject and the movement displayed on the screen may be slightly different.
- When you record in dark or dim light at high magnification while this function is On, after-images may stand out. If this occurs, we recommend using a tripod (not supplied) and turning Anti-shake (OIS) to Off.

Digital Effect

Using the Digital Effect function gives your recording a creative look.

PRECHECK!

Select the record mode by pressing the **MODE** button. →page 24

1. Touch the Menu (MENU) tab → “Digital Effect.”
2. Touch the desired submenu item.
3. To exit the menu, touch the Exit (X) or Return (↩) tab.

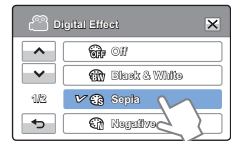

Examples of 5 Digital Effect options



Off
Without any Digital Effect, the image retains a normal, natural look.



Negative (☹)
This mode reverses the colors, creating a negative image.



Black & White (☺)
This mode changes the image to black and white.



Art (☺)
This mode helps adjust for facial imperfections.



Sepia (☺)
This mode gives the image an old-time, reddish brown look.

advanced recording

Fader

You can give your recording a professional look by using special effects such as fade in at the beginning of a sequence or fade out at the end of a sequence.

PRECHECK!

Select the record mode by pressing the **MODE** button. →page 24

1. Touch the Menu (MENU) tab → “Fader.”
2. Touch the desired submenu item.
3. To exit the menu, touch the Exit (X) or Return (↩) tab.

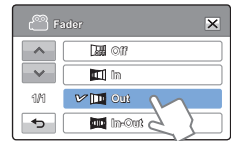

Submenu items

- **Off**: Disables the function
- **In (In)**: As soon as you start recording, the recording fades in.
- **Out (Out)**: When the recording is done, it fades out.
- **In-Out (In-Out)**: When you start or stop recording, the recording fades in or fades out accordingly.

Recording a video with Fade effect

Fade in

With “Fader” set to “In,” press the **Recording start/stop** button. The recording starts with a dark screen, and then the image and sound fade in.

Fade out

With “Fader” set to “Out,” press the **Recording start/stop** button to stop recording. The image and sound fade out, the screen goes black, and then the recording stops.

Fade in-out

With “Fader” set to “In-Out,” press the **Recording start/stop** button. The recording starts with a dark screen, and then the image and sound fade in. To stop recording, press the **Recording start/stop** button. The image and sound fade out, the screen goes black, and then the recording stops.

Fade In (Approx.3 seconds)

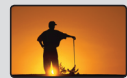
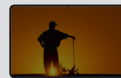
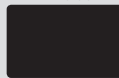

Fade Out (Approx. 3 seconds)



Tele Macro

Using the Tele Macro function, you can get close up images which are created by focusing on a small portion of a large object at a wide angle. It is useful to get close up images of flowers or insects etc.

PRECHECK!

Select the record mode by pressing the **MODE** button. ↪ page 24

1. Touch the Menu (MENU) tab → “Tele Macro.”
2. Touch the desired submenu item.
3. To exit the menu, touch the Exit (X) or Return (↵) tab.



Submenu items

- **Off:** Disables the function.
- **On (📷):** You can focus on a small portion of a large object at a wide angle.



- When recording in Tele Macro mode, the focus speed may be lowered.
 - Use a tripod (not supplied) to prevent camcorder shake in the Tele Macro mode.
 - Avoid shadows when recording in the Tele Macro mode.
 - As the distance to the subject decreases, focusing area narrows.
 - If you can not get proper focus, move the **Zoom** button or **Zoom** lever to adjust the focus.
 - The effective focal distance in the Tele Macro mode is between 1 to 50 cm. (0.4 to 19.7 inches).
-

advanced recording

Cont. Shot

The Continuous Shot function lets you capture up to eight photos in rapid succession to give you more photo-taking opportunities when recording moving subjects.

PRECHECK!

Select the record mode by pressing the **MODE** button. ↪ page 24

1. Touch the Menu (MENU) tab → “Cont. Shot.”
2. Touch the desired submenu item.
3. To exit the menu, touch the Exit (X) or Return (RETURN) tab.

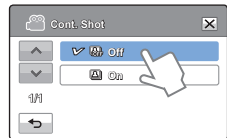

Submenu items

- **Off:** The camcorder records only one photo image.
- **On (ON):** When you press the **PHOTO** button, the camcorder can take up to 8 photos in one second.



- If an error occurs (Card full, etc.) during continuous shot, the recording stops and an error message appears.
- When “Cont. Shot” is “On,” the camcorder fixes the photo resolution at 1920x1080.

Wind Cut

Using the Wind Cut function, you can reduce wind noise when recording sound using the internal microphone.

PRECHECK!

Select the record mode by pressing the **MODE** button. ↪ page 24

1. Touch the Menu (MENU) tab → “Wind Cut.”
2. Touch the desired submenu item.
3. To exit the menu, touch the Exit (X) or Return (RETURN) tab.



Submenu items

- **Off:** Disables the function.
- **On (ON):** Reduces wind noise when recording sound using the internal microphone.



Using the Wind Cut function also removes some low frequency sound with the wind noise.

Digital Zoom

The digital zoom enables higher zoom magnification than the optical zoom. Digital zoom can electronically magnify an image created by the optical lens up to 1000 times.

PRECHECK!

Select the record mode by pressing the **MODE** button. → page 24

1. Touch the Menu (MENU) tab → “Digital Zoom.”
2. Touch the desired submenu item.
3. To exit the menu, touch the Exit (X) or Return (↩) tab.

Submenu items

- **Off** : Disables Digital Zoom.
- **On** : Enables higher digital zoom magnification.



When you use the digital zoom, the camcorder processes the image digitally more than in the optical zoom mode. As a result, the image resolution may deteriorate.

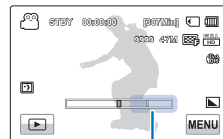

The right side of the bar shows the digital zooming zone. The zooming zone appears when you move the zoom lever.

Self Timer

When you enable the self-timer, there is a time delay of 10 seconds before recording starts. You can record videos or take photos of yourself.

PRECHECK!

Select the record mode by pressing the **MODE** button. → page 24

1. Touch the Menu (MENU) tab → “Self Timer.”
2. Touch the desired submenu item.
3. To exit the menu, touch the Exit (X) or Return (↩) tab.

Submenu items

- **Off**: Disables the Self Timer.
- **10 Sec** (⏱): There is a time delay of 10 seconds after you press the **Record Start/Stop** or **PHOTO** button.



The camcorder automatically turns the Self Timer function off after it has been used once. You must turn it on each time you want to use it.

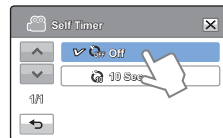

advanced recording

Quick View

Using the Quick View function, you can view the most recently recorded video or photo images immediately after you have recorded them.

PRECHECK!

Select the record mode by pressing the **MODE** button. →page 24

1. Touch the Menu (MENU) tab → “Quick View.”
2. Touch the desired submenu item.
3. To exit the menu, touch the Exit (X) or Return (↩) tab.



Submenu items

- **Off:** Quick View (▶) icon does not appear on the screen after you finish the recording.
- **On:** Quick View (▶) icon appears on the screen as soon as you finish the recording. Touch the Quick View icon to view the most recent video or photo you have recorded. After the Quick View is completed, your camcorder switches back to the standby mode.

Deleting files after Quick View

If you touch the delete (🗑) tab during Quick View, the file you are viewing is deleted.



- The Quick View function is not available under the following conditions:
 - If the mode has been changed after the recording
 - If the USB cable is connected to the camcorder.
 - If the camcorder has been restarted after the recording
 - After playing Quick View
- For photos recorded with “**Cont. Shot,**” only the last file in the sequence is displayed.

Guideline

Guideline displays straight line patterns on the LCD screen that can help you set the image composition when recording images. The camcorder provides 3 types of guidelines.



PRECHECK!

Select the record mode by pressing the **MODE** button. →page 24

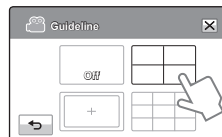
1. Touch the Menu (MENU) tab → “Guideline.”
2. Touch the desired guideline according to the subject.
 - The selected guideline appears on the screen.
3. To exit the menu, touch the Exit (X) or Return (←) tab.



Submenu items

- **Off**: Disables the function.
- : Placing the subject at the center cross point puts the subject in the middle of the frame.
- : Positioning subjects within the Safety Zone rectangle ensures they will be recorded.
- : For recording multiple subjects. Putting subjects at or near the grid cross points creates a balanced composition.

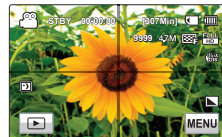

- Positioning a subject at the cross point of a guideline provides a balanced composition.
- Guidelines are not recorded.

advanced playback

Play Option

You can select a specific video playback option.

PRECHECK!

Select the Play (▶) tab on the LCD screen to select the Video play (▶/▶) mode. →page 40

1. Touch the Menu (MENU) tab → “Play Option.”
2. Touch the desired submenu item.
3. To exit the menu, touch the Exit (X) or Return (↩) tab.



Submenu items

- **Play All** (▶▶): Plays video clips in succession starting from a video you select and ending at the last video you recorded, then returns to the thumbnail index view.
- **Play One** (▶): Plays the selected video once, and then returns to the thumbnail view.
- **Repeat All** (▶▶): Plays all the video clips repeatedly until you touch the Return (↩) tab.
- **Repeat One** (▶▶): Plays one selected video repeatedly until you touch the Return (↩) tab.

Highlight

The Highlight function plays a portion of each recorded video at random.

PRECHECK!

Select the Play (▶) tab on the LCD screen to select the Video play (C/HD / C/SD) mode. → page 40

1. Touch the Menu (MENU) tab. → “Highlight.”
2. Touch the desired submenu item.
3. To exit the menu, touch the Exit (X) or Return (↵) tab.



Submenu items

- **Recent (R):** Plays a portion of all videos created within the last 24 hours.
- **All (A):** Plays a portion of all video files.

Highlight playback time to the duration of a video

Video Duration	Highlight playback time
Less than 5 sec.	Full playback
5 to 30 sec.	Plays 5 seconds at random.
30 sec. to 5 min.	Plays 5 seconds of each 30 second section at random.
5 min. to 10 min.	Plays 11 seconds of each 2 minute section at random.
Over 10 min.	Plays 15 seconds of each 3 minute section at random.



- If you run the Highlight function in the date thumbnail display, Highlight plays random portions of all the files in the selected date set.
- In the Highlight play mode, you can adjust the volume by touching the screen. You can also cancel the playback.

advanced playback

Slide Show Option

You can set the play options for the slide show with the slide show setting menus.

PRECHECK!

Select the Play (📺) tab on the LCD screen to select the photo (📷) mode. ↪ page 40

1. Touch the Menu (MENU) tab. → “Slide Show Option.”
2. Touch the desired submenu item and touch the (⬆️)/(⬇️) tab to set the value you want.
3. To exit the menu, touch the Exit (✖️) or Return (⬅️) tab.

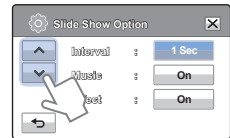

Submenu items

- **Interval:** Continuously plays back photos at the interval you select. You can choose 1 sec. or 3 sec.
- **Music:** You can turn the internal background music on or off. This camcorder has 7 default background melodies stored in the boot-up flash memory. When music is On, starting a slide show starts the play back of the 7 melodies in shuffle mode.
- **Effect:** Continuously plays back photos using the fade in / out effect to transition between images.

File Info

You can see the image information for all images.

PRECHECK!

Select the Play (📺) tab on the LCD screen to select the Video play (📺HD / 📺SD) or Photo play (📷) mode. ↪ page 40

1. Touch the Menu (MENU) tab → “File Info.”
2. Select the file you want to view the file information for.
 - The information of the selected file appears.
3. To exit the menu, touch the Return (⬅️) tab.

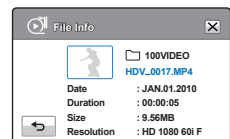

editing files

DELETING FILES

You can erase your recordings one by one or all at once.

PRECHECK!

- Insert a memory card. ↪page 28
- Touch the Play (▶) tab on the LCD screen to select the play mode. ↪page 40

1. Touch the HD (HD), SD (SD), or Photo (Photo) tab.
 - Videos or photos appear as thumbnails.
2. Touch the Menu (MENU) tab → “Delete” → touch the desired submenu item.
 - If you touch “Select Files,” you will see image thumbnails. Go to Step 3.
 - If you touch “All Files,” you will see the message that corresponds to that option. Go to Step 4.
3. Touch the files you want to delete. After you have selected all the files you want to delete, touch the (OK) tab. Go to Step 4.
 - See Submenu items below for additional details.

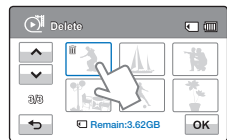
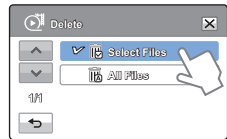

4. Touch “Yes.”
 - If you selected “All Files,” the camcorder deletes all the files in the storage media, except for those that are protected.
 - If you selected “Select Files,” the camcorder deletes the files you selected.

Submenu items

- **Select Files:** Deletes individual images.
 - ① Touch the images you want to delete. The indicator (■) is displayed on the selected images. Touching the thumbnail image toggles the image between being selected for deletion (■) or not selected.
 - ② Touch the (OK) tab.
- **All Files:** Deletes all images.



- Deleted images cannot be recovered.
- Do not eject a memory card or power off the camcorder while deleting videos or photos recorded on the storage media. Doing so may damage the storage media or data.



- You can also operate this function in the full and single image display modes.
- To protect important images from accidental erasure, activate the image protection function in advance. ↪page 70
- You can not delete protected files. Cancel the protect function first. ↪page 70
- If the write protection tab on the memory card is set to lock, you cannot delete images.
- The delete function does not work if the battery charge is insufficient. We recommend you use the AC adapter to ensure the camera has continuous power when deleting.

PROTECTION FROM ACCIDENTAL ERASURE

You can protect important recordings from accidental erasure. The protected videos and photos can not be deleted unless you format the memory card or cancel the protection.

PRECHECK!

- Insert a memory card. ↪ page 28
- Touch the Play (▶) tab on the LCD screen to select the play mode. ↪ page 40

1. Touch the HD (HD), SD (SD), or Photo (Photo) tab.
 - Videos or photos appear as thumbnails.
2. Touch the Menu (MENU) tab → **“Protect”** → touch the desired submenu item.
 - If you touch **“Select Files,”** you will see image thumbnails. Go to Step 3.
 - If you touch **“All Files,”** you will see the message that corresponds to that option. Go to Step 4.
3. Touch the files you want to protect. After you have selected all the files you want to protect, touch the (OK) tab. Go to Step 4.
 - See Submenu items below for additional details.
4. Touch **“Yes.”**
 - If you selected **“All On,”** the (☑) indicator appears on all files.
 - If you selected **“All Off,”** the (☑) indicator disappears from all protected files.
 - If you selected **“Select Files,”** the indicator appears on the files you selected for protection and disappears from the files you removed protection from.

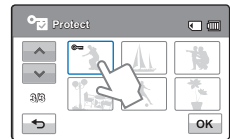
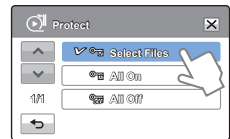

Submenu items

- **Select Files:** Protects individual images.
 - ① Touch the images to protect from erasure. The (☑) indicator appears on the selected images. Touching the thumbnail image toggles the image between being selected (☑) or not selected.
 - ② Touch the (OK) tab.
- **All On:** Protects all images.
- **All Off:** Turns off protection on all protected images all at once.



- You can also operate this function in the full and single image display modes.
- If the write protection tab on the memory card is set to lock, you cannot set this function. ↪ page 29

DIVIDING A VIDEO

You can divide a video into two, and easily delete a section you no longer need. As this function edits the original file, make sure to back up the original before dividing it.

PRECHECK!

- Insert a memory card. ↪page 28
- Select the Play (📺) tab on the LCD screen to select the Video play (📺HD /📺SD) mode. ↪page 40

1. Touch the Menu (MENU) tab → “Edit” → “Divide.”
2. Touch the video you want to edit.
 - The selected video is displayed as paused.
3. Search for the point of division by touching the playback control tabs.
 - Playback control tabs: ▶ / ⏸ / ⏪ / ⏩ / ⏴ / ⏵
4. Touch the pause (⏸) tab at the point of division, and then touch the Cutting (✂) tab.
 - A message appears asking for your confirmation.
5. Touch “Yes.”
 - The video you selected is divided into two video clips.
 - The second clip of the divided video is displayed as the last thumbnail.
 - After the division, you can partially delete an unnecessary section or combine it with other videos.

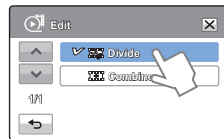

Do not eject a memory card or power off the camcorder while editing a video recorded on the storage media. Doing so may damage the storage media or data.



- You can also operate this function in the full and single image display modes.
- You can not divide files that are protected (🔒). Cancel the protect function first. ↪page 70
- The divided video may drift before or after the division point by approximately 2 seconds.
- The Divide function is not available under the following conditions:
 - If the total recorded time of the video is less than 6 seconds.
 - If you try to divide sections without leaving 3 seconds at the beginning and the end.
 - If the remaining memory space on your memory card is less than 15MB.
 - When the number of files on the card reaches 9999.
- You can not divide photos.

COMBINING VIDEOS

You can combine two different videos. As this function edits the original files, make sure to back up the original files before combining them.

PRECHECK!

- Insert a memory card. ↪ page 28
- Select the Play (▶) tab on the LCD screen to select the Video play (▶HD /▶SD) mode. ↪ page 40

1. Touch the Menu (MENU) tab → “Edit” → “Combine.”
2. Touch the video thumbnails of the videos you want to combine in the order you want them combined.
 - The (☑) indicator and the order number appear on the selected videos. Touching the video thumbnail toggles a video between being selected (☑) or not selected.
 - The (☑) indicator does not appear if the video files have different resolutions.
3. Touch the (OK) tab.
 - A message appears asking for your confirmation.
4. Touch “Yes.”
 - The camcorder combines the video files you selected in the order you designated, and then stores the combined videos as a single video file.

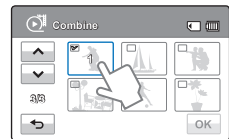

Do not eject a memory card or power off the camcorder while editing a video recorded on the memory card. Doing so may damage the storage media or data.



- You can not combine files that are protected (Ⓢ). Cancel the protect function first. ↪ page 70
- The original videos are not preserved.
- The Combine function is not available under the following conditions:
 - If the Videos are in different resolution formats. For example, videos recorded at “**Video Resolution: 1080/60i**” and “**Video Resolution: 720/60p**” cannot be combined.
 - If the file size of the combined videos exceeds 1.8 GB.
 - If the remaining memory space on your memory card is less than 15MB.
 - If a video's file format is not supported by the camcorder.
 - When the camcorder is playing a video file.

system setting

SETTING MENU ITEMS

- Refer to page 45 for setting menus.
- For item operation details, go to the page number listed in the table under Page.

Items	Default value	Page
Card Info	-	74
File No.	Series	75
Time Zone	Home	75
Date/Time Set	JAN/01/2010 12:00 AM (Summer Time : Off)	76
Date Type	JAN/01/2010	76
Time Type	12 Hr	76
Date/Time Display	Off	77
LCD Brightness	18	77
Auto LCD Off	On	78
Beep Sound	On	79
Shutter Sound	On	79
Auto Power Off	5 Min	80
Quick On STBY	5 Min	81
PC Software	On	82
USB Connect	Mass Storage	82
HDMI TV Out	Auto	83
TV Connect Guide	-	83
TV Display	On	84
Format	-	74
Default Set	-	84
Language	English	85
Demo	On	85
Anynet+(HDMI-CEC)	On	86



- Menu options and default values may be changed without prior notice.
- The time type may change depending on the language you selected.

system setting

Card Info

This function shows you the storage information of the memory card, such as used memory space, available memory space, etc.

PRECHECK!

Insert a memory card. ↪page 28

1. Touch the Menu (MENU) → Setting (⚙️) tab → **“Card Info.”**
 - Used memory space, available memory space, and recordable time appear. Available space and recordable time depend on the video resolution you've selected.
2. To exit the menu, touch the Return (↩️) tab.

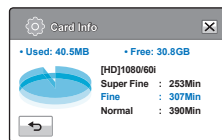

Format

Use this function if you want to delete all files completely or to correct problems on the storage media.

PRECHECK!

Insert a memory card. ↪page 28

1. Touch the Menu (MENU) → Setting (⚙️) tab → **“Format.”**
2. Touch **“Yes”** → **“Yes.”**
 - The format is executed and the formatting message appears.

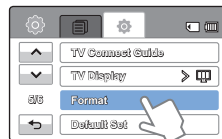

- Do not remove the storage media or perform any other operation (such as turning off the power) during formatting. Also, be sure to use the provided AC power adapter to power the camcorder when formatting. The memory card may be corrupted if the battery becomes exhausted during formatting and the formatting process stops before the card is completely formatted.
- If the storage media becomes corrupted, format it again.



- Do not format the storage media on a PC or other device. Make sure to format the storage media on this camcorder.
- You can not format a memory card with the protection tab set to lock. ↪page 29
- If there is no storage media inserted, you can not select the Format function, and its name will be dimmed on the menu.
- Formatting completely deletes all files and options on a memory card, including protected files. By deleting all files and options, formatting typically corrects problems, enabling stable read/write speeds and operation.

File No.

File names (numbers) are assigned to recorded images according to the numbering option you select.

1. Touch the Menu (MENU) → Setting (⚙️) tab → “File No..”
2. Touch the desired submenu item.
3. To exit the menu, touch the Exit (✕) or Return (↩️) tab.

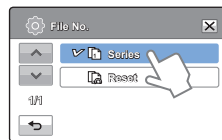

Submenu items

- **Series:** Assigns file numbers in a continuous sequence even after you replace or format the storage media or delete all files. Each file is given a unique file number that allows convenient image management on a PC.
- **Reset:** Resets the file number to 0001 after you format the memory card, delete all files, or insert a new memory card.



When you set “File No.” to “Series,” the camcorder assigns each file a different number to avoid duplicating file names. This is useful when you want to manage your files on a computer.

Time Zone

You can set the clock to the local time when using your camcorder in a different time zone.

Setting the local time

1. Touch the Menu (MENU) tab → Setting (⚙️) tab → “Time Zone” → “Visit.”
2. Touch the left (←) or the right (→) tab to select the visited area.
3. Touch the (OK) tab when the time zone setting is complete.
 - The camcorder does not apply the time zone you set if you finish the setting by touching the (OK) tab without touching the (↩️) tab.



Submenu items

- **Home:** The camcorder displays the time according to your settings on the Date/Time Set menu. Select Home when using the camcorder for the first time or when returning the clock to your hometown date/time setting.
- **Visit (📍):** When you visit a locale in a different time zone, the Visit function allows you to use the local time without changing your hometown time setting. The camcorder adjusts the clock in accordance with the time difference between the two locations.

system setting

Date/Time Set

By setting the date and time, you can display the date and time of the recording during playback. ↗page 26

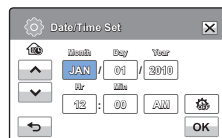

Date Type

You can set the display format for the date.

1. Touch the Menu (MENU) → Setting (⚙️) tab → “Date Type.”
2. Touch the desired submenu item.
3. To exit the menu, touch the Exit (⌘) or Return (↩️) tab.

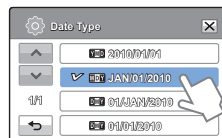

Submenu items

- **2010/01/01**: Displays the date in the year/month (two-digit)/day format.
- **JAN/01/2010**: Displays the date in the month/day/year format.
- **01/JAN/2010**: Displays the date in the day/month/year format.
- **01/01/2010**: Displays the date in the day/month (two-digit)/year format.



This function depends on the “Date/Time Display” setting. ↗page 77

Time Type

You can set the display format for the time.

1. Touch the Menu (MENU) → Setting (⚙️) tab → “Time Type.”
2. Touch the desired display option.
3. To exit the menu, touch the Exit (⌘) or Return (↩️) tab.

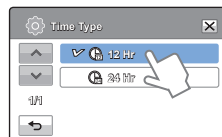

Submenu items

- **12Hr**: Displays the time information in 12 hour units.
- **24Hr**: Displays the time information in 24 hour units.



This function depends on the “Date/Time Display” setting. ↗page 77

Date/Time Display

You can set whether or not the date and/or time are displayed on the LCD screen.

PRECHECK!

Before you use the “Date/Time Display” function, you must set the date and time. ↪ page 76

1. Touch the Menu (MENU) → Setting (⚙️) tab → “Date/Time Display.”
2. Touch the desired submenu item.
3. To exit the menu, touch the Exit (⌘) or Return (↩️) tab.
 - The date/time is displayed on the LCD screen according to the selected option.

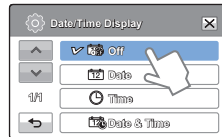

Submenu items

- **Off:** Current date/time information is not displayed.
- **Date:** Displays the current date.
- **Time:** Displays the current time.
- **Date & Time:** Displays the current date and time.



- The date/time will read “JAN/01/2010 12:00 AM” in the following case:
 - When the internal rechargeable battery is depleted.
- This function depends on the “Date Type” and “Time Type” setting. ↪ page 76

LCD Brightness

You can adjust the brightness of the LCD screen to compensate for ambient lighting conditions.

1. Touch the Menu (MENU) → Setting (⚙️) tab → “LCD Brightness.”
2. Touch the decrease (◀️) or increase (▶️) tab to adjust the setting values as you want.
 - You can set value for LCD brightness between 0 and 35.
3. To exit the menu, touch the Exit (⌘) or Return (↩️) tab.

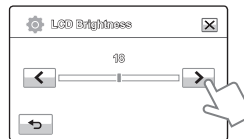

- If the surroundings are too bright, adjust the brightness of the LCD screen.
- Adjusting the LCD screen does not affect the image you are recording.
- A brighter LCD screen consumes more power.

system setting

Auto LCD Off

To reduce power consumption, the camcorder automatically dims the brightness of the LCD screen if the camcorder is idle for a period of time.

1. Touch the Menu (MENU) → Setting (⚙️) tab → “Auto LCD Off.”
2. Touch the desired submenu item.
3. To exit the menu, touch the Exit (⌫) or Return (↩️) tab.



Submenu items

- **Off:** Disables the function.
- **On:** When the camcorder is idle for more than 2 minutes in the STBY mode, or for more than 5 minutes when recording a video, the power saving mode starts by dimming the LCD screen.

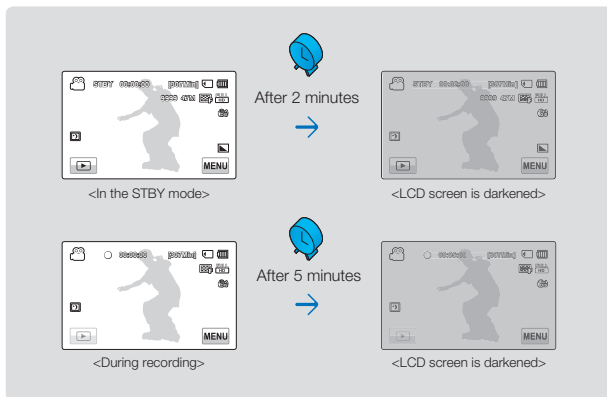

- When the “Auto LCD Off” function is enabled, you can press any button on the camcorder to return LCD brightness to normal.
- Auto LCD Off is disabled in the following cases:
 - If the AC power adaptor is connected.
 - While the Demo function is in operation.

Beep Sound

The Beep Sound function lets you control whether a beep sounds when you touch certain buttons on the screen.

1. Touch the Menu (MENU) → Setting (⚙️) tab → “Beep Sound.”
2. Touch the desired submenu item.
3. To exit, touch the Exit (✕) or Return (↩️) tab until the menu disappears.

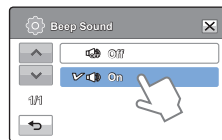

Submenu items

- **Off:** Disables the function.
- **On:** You will hear a beep when pressing buttons or tabs such as the **Power** (⏻) button or **Recording start/stop** button.



The Beep Sound is canceled in the following cases:

- During recording and playback.
- When the camcorder has a cable connection (Audio/Video cable, HDMI cable, etc.).

Shutter Sound

The Shutter Sound function lets you turn the shutter sound that plays when you press the **PHOTO** button on or off.

1. Touch the Menu (MENU) → Setting (⚙️) tab → “Shutter Sound.”
2. Touch the desired submenu item.
3. To exit the menu, touch the Exit (✕) or Return (↩️) tab.



Submenu items

- **Off:** Disables the function.
- **On:** You will hear the shutter sound when you press the **PHOTO** button.



The camcorder does not make the shutter sound:

- If you press the **PHOTO** button during video recording.
- When the camcorder has a cable connection (Audio/Video cable, HDMI cable, etc.).

system setting

Auto Power Off

You can set your camcorder to turn off automatically if it is idle for 5 minutes without an operation. This function prevents unnecessary power consumption.

1. Touch the Menu (MENU) → Setting (⚙️) tab → “Auto Power Off.”
2. Touch the desired submenu item.
3. To exit the menu, touch the Exit (✕) or Return (↩️) tab.

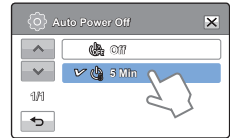

Submenu items

- **Off:** Disables the function.
- **5 Min:** The camcorder turns off if idle for 5 minutes without an operation.



- Auto Power Off does not work in the following situations:
 - When the camcorder has a cable connection. (USB cable, AC power adaptor, etc.)
 - While the Quick On STBY function is in operation.
 - While the Demo function is in operation.
 - While you are recording, playing (except pause), or running a photo slide show.
 - To turn the camcorder on again, press the **Power** (⏻) button.
-

Quick On STBY

When you are going to record frequently for an extended time, use the Quick On STBY function to reduce energy consumption and battery drain. With the Quick On STBY function On and the camcorder in standby mode, closing the LCD screen starts Quick On STBY. Once you are ready to record again and you open the LCD screen, Quick On STBY triggers the camcorder to come on quickly from the power saving mode.

1. Touch the Menu (MENU) → Setting (⚙️) tab → “Quick On STBY.”
2. Touch the desired submenu item.
3. To exit the menu, touch the Exit (✕) or Return (↩️) tab.

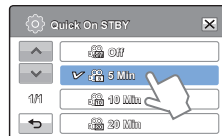

Submenu items

- **Off:** In the standby mode, closing the LCD screen turns off the camcorder.
- **5 Min:** In the standby mode, closing the LCD screen starts the Quick On STBY mode in a few seconds. The camcorder stays in Quick On STBY mode for 5 minutes and then turns off unless you open the LCD screen or push a button.
- **10 Min:** In the standby mode, closing the LCD screen starts the Quick On STBY mode in a few seconds. The camcorder stays in Quick On STBY mode for 10 minutes and then turns off unless you open the LCD screen or push a button.
- **20 Min:** In the standby mode, closing the LCD screen starts the Quick On STBY mode in a few seconds. The camcorder stays in Quick On STBY mode for 20 minutes and then turns off unless you open the LCD screen or push a button.



- We recommend turning off the camcorder after use to reduce energy consumption. However, as an alternative, you can use the Quick On STBY function under most shooting conditions to reduce energy consumption effectively.
- The mode indicator keeps blinking in the Quick On STBY mode.
- The Quick On STBY mode is not available under the following conditions:
 - When the LCD screen is open.
 - When a video cable (HDMI, Audio/Video cable) or the USB cable is connected to the camcorder.
 - When you operate the buttons on the camcorder.

system setting

PC Software

If you set PC Software to On, you can use the PC software built into the camcorder (IntelliStudio) by connecting your camcorder to your PC using the camcorder's USB cable. You can download the video and photo images stored on the camcorder to your PC's hard disk and edit the videos and photos using the internal PC software.

1. Touch the Menu (MENU) → Setting (⚙️) tab → “PC Software.”
2. Touch the desired submenu item.
3. To exit the menu, touch the Exit (⌫) or Return (↩️) tab.



Submenu items

- **Off:** Disables the PC Software function.
- **On:** The internal editing software starts when you connect the camcorder to a PC.



- The PC Software function is not available under the following conditions:
 - If “USB Connect” is set to “PictBridge”
- To enable the PC Software function, set “USB Connect” to “Mass Storage,” in the system setting menu option. ↪ page 82
- The PC Software is compatible with the Windows operating systems only.

USB Connect

You can transfer data to a PC or print photos directly by establishing the correct USB connection.

1. Touch the Menu (MENU) → Setting (⚙️) tab → “USB Connect.”
2. Touch the desired submenu item.
3. To exit the menu, touch the Exit (⌫) or Return (↩️) tab.

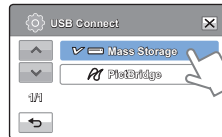

Submenu items

- **Mass Storage:** Connect to a PC to transfer videos or photos. ↪ page 100
- **PictBridge:** Connect to a PictBridge printer to print photos directly (when using the PictBridge function). ↪ page 92



Before connecting a USB cable, check whether the current USB mode is appropriate for the function you want to use.

HDMI TV Out

You can set the HDMI video output to match the TV you have connected the camcorder to.

PRECHECK!

Using the HDMI cable (not supplied), connect the camcorder to your TV. ↪page 87

1. Touch the Menu (MENU) → Setting (⚙️) tab → “HDMI TV Out.”
2. Touch the desired submenu item.
3. To exit the menu, touch the Exit (⌘) or Return (↩️) tab.

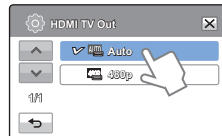

Submenu items

- **Auto:** The video signals are output in the same format as the recorded file. Use this setting only when connecting to an HDTV.
- **480p:** The recorded file is output in the 720x480p format. Use this setting only when connecting to a standard, analog TV which supports Standard Definition (SD) progressive scan through its the HDMI jacks.

TV Connect Guide

You can view the TV Connect Guide before you connect the camcorder to your TV set.

1. Touch the Menu (MENU) tab → Setting (⚙️) tab → “TV Connect Guide.”
2. Touch the desired submenu item.
 - The TV Connect Guide appears depending on the selected submenu items.
 - Refer to the TV Connect Guide when you connect your camcorder to a TV.
3. To exit the menu, touch the Exit (⌘) or Return (↩️) tab.

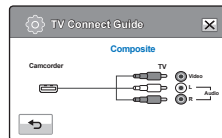
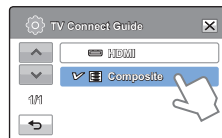

<To connect the Audio/Video cable>

Submenu items

- **HDMI:** Select HDMI when connecting the camcorder to a TV with an HDMI cable.
- **Composite:** Select Composite when connecting the camcorder to a TV with a Video/Audio (composite) cable.

system setting

TV Display

You can enable or disable the On Screen Display (OSD) that appears on the TV screen when you have connected your camcorder to a TV.

1. Touch the Menu (MENU) → Setting (⚙️) tab → “TV Display.”
2. Touch the desired submenu item.
3. To exit the menu, touch the Exit (⌘) or Return (↩️) tab.



Submenu items

- **Off:** The OSD (On Screen Display) menus are only shown on the LCD screen.
- **On:** The OSD menus are shown on the LCD screen and the TV screen as well.



The thumbnail display and Demo screens are shown on the TV even if you set “TV Display” to “Off.”

Default Set

You can restore all menu settings to their factory default settings.

1. Touch the Menu (MENU) → Setting (⚙️) tab → “Default Set.”
 - A message appears asking for your confirmation.
2. Touch “Yes” if you want all the settings returned to the default.
 - The Time Zone screen appears after all settings return to their defaults.
3. Set the date and time again. ↪️ page 26



- Do not turn off the power while using this function.
- Initializing the camcorder settings to factory defaults does not affect recorded images.

Language

You can select a language in which to display the menu and messages. ↪ page 27



Demo

Demo mode automatically shows you the major functions that are included with your camcorder so that you may use them more easily.

1. Touch the Menu (MENU) → Setting (⚙️) tab → “Demo.”
2. Touch the desired submenu item.
3. To exit the menu, touch the Exit (⊗) or Return (↩️) tab.

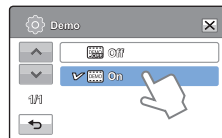

Submenu items

- **Off:** Disable the Demo function.
- **On:** Enables the Demo function.

Using the Demo function

The Demo mode is canceled in the following cases:

- If the LCD screen is touched.
- If you press any button (**Recording start/stop, Q.MENU, Display (□), SMART AUTO, MODE, PHOTO**, etc.). However, the camcorder enters the Demo mode automatically after 5 minutes in STBY mode if it is idle for 5 minutes without an operation. If you don't want the Demo function to start, set “**Demo**” to “**Off**.”



The Demo function does not operate in the following case:

- If you set “**Auto Power Off**” to “**5 Min**” and you are using the battery to power the camcorder, the Auto Power Off function turns the camcorder off before Demo can run.

system setting

Anynet+ (HDMI-CEC)

This camcorder supports Anynet+. Anynet+ is an AV network system that lets you control all connected Samsung AV devices with an Anynet+ supported Samsung TV remote control.

1. Touch the Menu (MENU) → Setting (⚙️) tab → “Anynet+ (HDMI-CEC).”
2. Touch the desired submenu item.
3. To exit the menu, touch the Exit (⌂) or Return (↩️) tab.

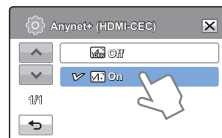

Submenu items

- **Off:** Disables the function.
- **On:** The Anynet+ function is enabled.

When the camcorder is connected to an Anynet+ supported TV, you can operate some functions of the camcorder using the TV's remote control.



- When you turn on the camcorder and it is connected by an HDMI cable to a TV that supports Anynet+, the TV automatically turns on. If you do not want to use the Anynet+ function, set the “Anynet+ (HDMI-CEC)” to “Off.”
 - For details on the Anynet+ (HDMI-CEC) function, refer to the user manual of Samsung's Anynet+ supported TV.
-

connecting to a TV

CONNECTING TO A HIGH DEFINITION TV WITH HDMI

You can view High Definition (HD) quality videos recorded in HD resolution on an HDTV using an HDMI connection. This camcorder supports HDMI output to deliver high-definition video transfer.

PRECHECK!

- Check if there is an HDMI input jack on your TV.
- Use the AC power adaptor to power the camcorder when you attach it to a TV.
- Select "HDMI TV Out." ↪page 83

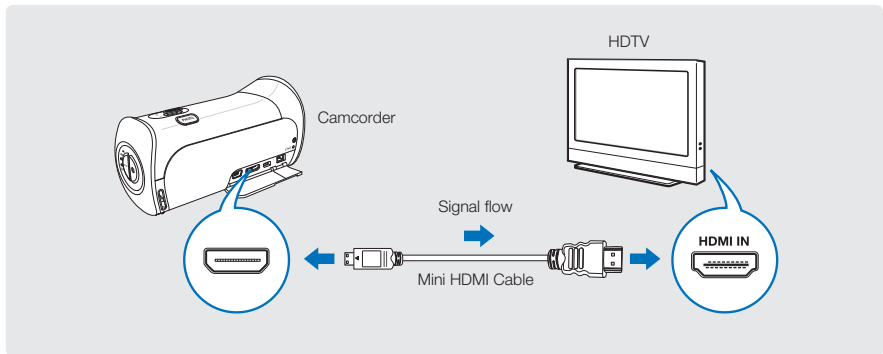

Using a mini HDMI cable

1. Turn on the camcorder.
 - If you do not turn on the camcorder first, the camcorder may fail to recognize the connected TV.
2. Connect the camcorder to the TV with a Mini HDMI cable.
3. Set the TV's input or source selector to the HDMI input you've attached the camcorder to.
 - Refer to the TV's instruction manual to see how to select the TV's input or source.
4. Select the playback mode on your camcorder, and then start to play back videos or photos.
↪pages 41~43

connecting to a TV

Understanding the HDMI cable

HDMI (High Definition Multimedia Interface) is a compact audio/video interface for transmitting uncompressed digital data.

What is Anynet+ function?

The Anynet+ function lets you control all devices that support the Anynet + function with the same remote. You can use the Anynet + function on the camcorder if the camcorder is connected by an HDMI cable to a TV that supports Anynet+. For more information, refer to the Anynet+ supported TV's user manual.



- When **"HDMI TV Out"** is set to **"Auto,"** you can play an SD video file in HD format.
 - This camcorder comes with the **"TV Connect Guide"** menu function. If you try to connect the camcorder to a TV and don't have your user's manual, you can use the **"TV Connect Guide"** menu function to view connection instructions on the camcorder's screen. ➔ page 83
 - You can use only a C to A type Mini HDMI cable with this camcorder.
 - The HDMI jack on the camcorder is for output only.
 - If you connect an Anynet+ supported TV to the camcorder with an HDMI cable, turning on the camcorder may turn the TV's power on. (an Anynet+ function) If you don't want this to occur, set **"Anynet+ (HDMI-CEC)"** to **"Off."** ➔ page 86
 - Use only HDMI 1.3 cable when connecting to the HDMI jack of this camcorder. If you use another type of HDMI cable, the screen display may not work.
-

CONNECTING TO A REGULAR TV

You can view images recorded with your camcorder on a regular TV that supports standard definition. This camcorder supports the composite output for standard definition video transfer.

PRECHECK!

Use the AC power adaptor to power the camcorder when you connect it to a TV.

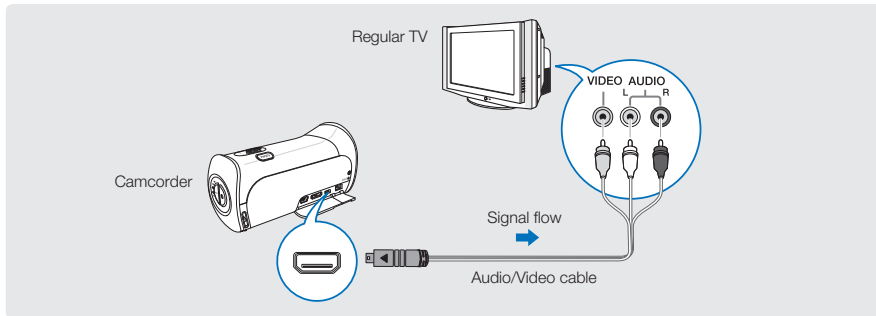

Connecting an Audio/Video cable for the composite output

1. Connect the camcorder to a TV with an Audio/Video cable.
 - Turn on the camcorder, and then connect an Audio/Video cable. If you do not turn on the camcorder first, the camcorder may fail to recognize the connected TV.
2. Set the TV's input or source selector to the input you've attached the camcorder to.
 - Refer to the TV's instruction manual to see how to select the TV input.
3. Select the playback mode on your camcorder, and then start to play back videos or photos.
↳ pages 41~43





- Make sure you've connected the camcorder to the correct input jacks. The TV screen may not display the right video information if the camcorder is connected incorrectly.
- When connecting to a TV using the Audio/Video cable, match the color of the cables to the color of the corresponding jacks.
- Video input may appear green depending on the TV. If this occurs, connect the yellow plug of the Audio/Video cable to the green jack of the TV.
- When the camcorder is connected to a TV with more than one type of cable, the camcorder outputs video signals in the following order of priority:
 - HDMI → Audio/Video (composite) output
- This camcorder comes with the "**TV Connect Guide**" menu function. If you try to connect the camcorder to a TV and don't have your user's manual, you can use the "**TV Connect Guide**" menu function to view connection instructions on the camcorder's screen. ↳ page 83
- If your TV has one audio jack (mono input), connect the yellow plug of the Audio/Video cable to the video jack, the white plug to the audio jack, and leave the red plug unconnected.
- When you connect the camcorder to a TV using the Audio/Video cable, images recorded in high-definition image quality (1080/60i or 720/60p) are played back in standard definition image quality.

connecting to a TV

VIEWING ON A TV SCREEN

Image appearance depends on the TV screen aspect ratio

Recording ratio	Appearance on Wide (16:9) TV	Appearance on 4:3 TV
Images recorded in a 16:9 ratio: <ul style="list-style-type: none">• Video images• Photo images• Photo capture images		



- Adjust the volume to a moderate level. If the volume is too high, the video may include noise.
- If **“TV Display”** is set to **“Off,”** the TV screen does not display the camcorder’s OSD (On Screen Display) menus. ➔ page 84

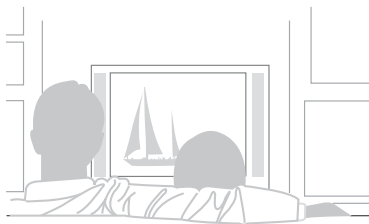

dubbing videos

DUBBING TO A VCR OR DVD/HDD RECORDER

Videos recorded in this camcorder can be dubbed to a VCR or DVD/HDD recorders.

PRECHECK!

- Videos are dubbed to the other recording device via analog data transfer (composite connection). Use the supplied Audio/Video cable.
- Use the AC power adaptor to power the camcorder when you dub to a VCR or DVD/HDD recorder.

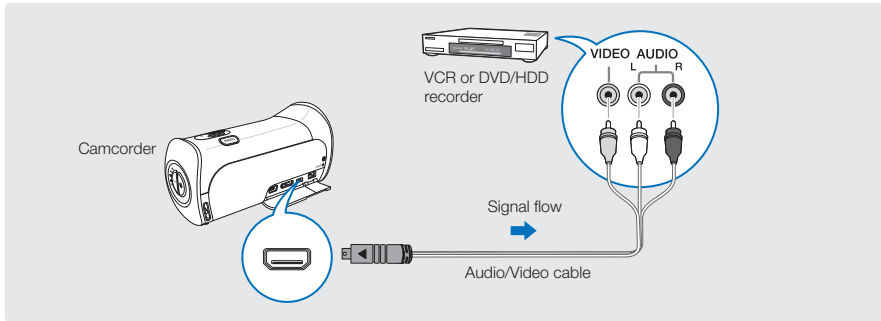

1. Connect your camcorder to the recording device (VCR or DVD/HDD recorder) with the Audio/Video cable.
 - Connect your camcorder to the input jacks of the recording device.
 - If your recording device has an input selector, set it to the correct input mode.
2. Insert the storage device (tape, disc, etc.) into the recording device.
3. Start the playback on your camcorder, and record it on the recording device.
 - Refer to the instruction manuals supplied with your recording device for details.
4. When dubbing is finished, stop the recording device and your camcorder.



- Videos recorded on this camcorder can only be dubbed using the Audio/Video cable in SD (standard definition) image quality, regardless of the recording resolution (HD/SD).
- You cannot dub to a recorder with an HDMI cable.
- To copy a video recorded in HD (high definition) image quality, use the internal software of your camcorder, and copy the video to your computer. ↪ page 95
- Because dubbing is performed via analog data transfer, the image quality may deteriorate.
- To hide the screen indicators (such as the counter, etc.) on the screen of the connected monitor device set **"TV Display: Off."** ↪ page 84
- To record the date/time, display it on the screen. ↪ page 77

printing photos

DIRECT PRINTING WITH A PICTBRIDGE PRINTER

You can print photos directly by connecting your camcorder to a PictBridge printer (sold separately) using a USB cable.

PRECHECK!

- Insert the memory card. ↪page 28
- Select the Play (▶) tab on the LCD screen to select the Photo play (▶) mode. ↪page 40

1. Touch the Menu (MENU) → Setting (⚙) tab → “USB Connect” → “PictBridge.”
2. Use a USB cable to connect your camcorder to the printer.
3. Turn your printer on.
 - The photo thumbnails appear on the LCD screen.
4. Touch the photos you want to print, and then touch the Print (🖨) tab.
 - The corresponding message appears.
5. Touch “Yes.”

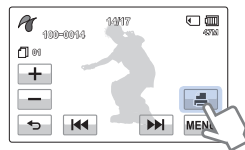
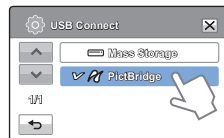

🔍 To set the number of prints

Touch the decrease (−)/increase (+) tab to set the number of copies to print.

- The number of copies is set.

🔍 To cancel the print setting

Touch the Return (↩) tab on the LCD screen.

🔍 To stop printing after printing starts

Touch “Cancel” on the screen.



- If the camcorder fails to recognize the printer, remove the USB cable, and then turn off the printer. Set “USB Connect” to “PictBridge,” and then connect the USB cable again.
- Use the supplied USB cable.

Camcorder

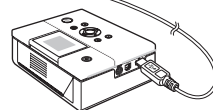
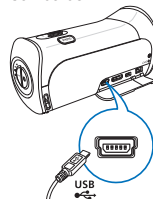

Printer
(Compatible with PictBridge)

To set the date/time imprint for Pictbridge printers

1. In the printer mode, touch the Menu (MENU) tab.
 - The print options appear on the screen.
2. Touch "Date/Time."
3. Touch the desired submenu item.
4. To exit the menu, touch the Exit (X) or Return (RETURN) tab.
 - The printer prints the selected date and time on the photos.

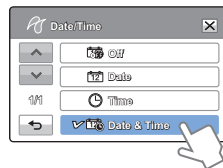
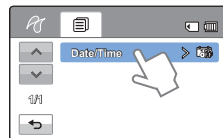
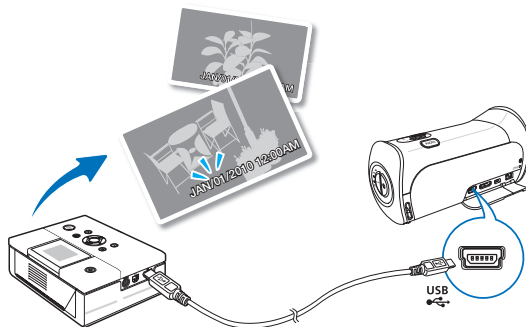

- The date/time imprint option may not be supported by all printers. Check with your printer manufacturer. You can not setup the "Date/Time" menu if the printer does not support this option.
- PictBridge™ is a registered trademark of CIPA (Camera & Imaging Products Association), an image transfer standard developed by Canon, Fuji, HP, Olympus, Seiko Epson, and Sony.
- Use the AC power adaptor to power your camcorder during PictBridge direct printing. Turning the camcorder off during printing might damage data on the storage media.
- You can not print video images.
- You can not print photos recorded on other devices.
- Various printing options are available depending on the printer. Refer to the printer's user manual for details.

using with a Windows computer

WHAT YOU CAN DO WITH A WINDOWS COMPUTER

You can perform the following functions by connecting your camcorder to your Windows computer with a USB cable and using the Intelli-studio editing software built into your camcorder.

Main functions

- Intelli-studio editing software's main functions.
 - Playing back recorded videos or photos.
 - Editing recorded videos or photos.
 - Uploading the recorded videos and photos to YouTube, Flickr, Facebook, etc.
- You can transfer or copy the files (videos and photos) saved on the storage media into your computer (the mass storage function).

System requirements

The following requirements must be satisfied to use the internal editing software (Intelli-studio):

Items	Requirement
OS	Microsoft Windows XP SP2, Vista, or Windows 7
CPU	Intel® Core 2 Duo® 1.66 GHz or higher is recommended AMD Athlon™ X2 Dual-Core 2.2 GHz or higher is recommended (Notebook: Intel Core2 Duo 2.2GHz or AMD Athlon X2 Dual-Core 2.6GHz or higher is recommended)
RAM	1GB or higher is recommended
Video Card	NVIDIA GeForce 8500 or higher, ATI Radeon HD 2600 series or higher
Display	1024 x 768, 16-bit color or higher (1280 x 1024, 32-bit color recommended)
USB	USB 2.0
Direct X	DirectX 9.0c or higher
*Memory Card	A Class 6 SDHC card or above.



- System requirements mentioned above are recommendations. Even on a system that satisfies the requirements, Intelli-studio may not operate optimally.
- On a slower computer than recommended, video playback may skip frames or operate erratically.
- If the version of DirectX on your computer is lower than 9.0c, install DirectX 9.0c or higher.
- We recommend transferring the recorded videos to a PC before playing back or editing the video data.
- To run Intelli-studio, a laptop computer requires better and faster components than a desktop PC.
- Intelli-studio is not Macintosh compatible.

USING THE Intelli-studio PROGRAM

Using the Intelli-studio program built into your camcorder, you can transfer video and photo files to your PC using a USB cable and edit them on your PC screen. Intelli-studio offers the most convenient way for you to manage your video and photo files.

Step 1. Connecting the USB cable

1. Set **"USB Connect: Mass Storage"** and **"PC Software: On."**
 - These are the default settings.
2. Connect the camcorder to a PC with the USB cable.
 - A new file saving window appears along with the Intelli-studio main window.
 - Depending on your version of Windows, the Windows removable disk window may also appear.
3. Click **"Yes"** in the new file saving window. The uploading procedure starts. Click **"Yes"** to confirm.
 - If you do not want to save any new files, select **"No."**

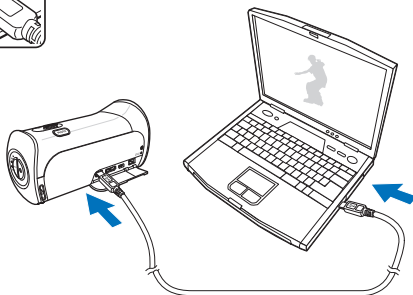
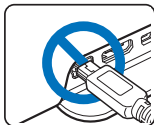
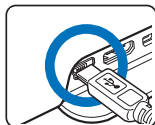
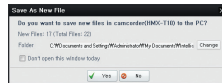

using with a Windows computer

To disconnect the USB cable

To disconnect the USB cable after completing the file transfer, you must follow these steps:

1. Click the **“Safely Remove Hardware”** icon on the taskbar.
2. Select **“USB Mass Storage Device,”** and then click **“Stop.”**
3. If the **“Stop a Hardware device”** window appears, click **“OK.”**
4. Disconnect the USB cable from the camcorder and PC.













- Use the provided USB cable. (Supplied by Samsung)
- Make sure you insert the USB plug into the USB jack with the plug facing in the correct direction.
- Use the AC power adaptor to power the camcorder when transferring files to your computer.
- When the USB cable is connected, turning the camcorder on or off may cause the PC to malfunction.
- If you disconnect the USB cable from the PC or the camcorder while transferring files, the data transmission will stop and the data may be damaged.
- If you connect the camcorder to a PC via a USB HUB or simultaneously connect the camcorder along with other USB devices, the camcorder may not work properly. If this occurs, remove all USB devices from the PC, and then reconnect the camcorder.
- Intelli-studio may not automatically run. If this occurs, access My Computer or Windows Explorer, open the drive that corresponds to your camcorder, find Intelli-studio, and then run iStudio.exe.

Step 2. About the Intelli-studio main window

When the Intelli-studio starts up, video and photo thumbnails are displayed in the main window.



1. Menu items
2. Switches to Library of the computer and connected camcorder.
3. Switches to Photo Edit mode.
4. Switches to Movie Edit mode.
5. Switches to Share mode.
6.  : Changes the size of thumbnails.
 : Displays all files (videos and photos).
 : Displays video files only.
 : Displays photo files only.
 : Displays voice files only.
7. Minimizes the connected device screen.
8. Displays videos and photos in various ways.
Thumbnails: Displays video and photo thumbnails.
Smart Album: Arranges multiple videos and photos by various classifications.
Global Map: Displays the locations where photos and videos were shot on a map.
9. Selects the connected device.
10. Shows Contents Manager and My Computer directories.
Contents Manager: You can classify and manage videos and photos on your computer.
My Computer: You can view videos and photos saved in selected directories of your computer.
11. Shortcut icons
 : Navigates files (previous and next).
 : Prints selected photo(s).
 : Displays locations where you shot selected photo(s) with GPS information.
 : Registers to Contents Manager.
 : Manages the registry of faces in the selected photo folder.



Intelli-studio is a program commonly used in Samsung camcorders or digital cameras. Some functions listed above may not work on the product you purchased.

using with a Windows computer

Step 3. Playing back videos or photos

You can play back the recordings conveniently using the Intelli-studio application.

1. Run the Intelli-studio program. ↪ page 95
2. Click the desired folder to display your recordings.
 - Video or photo thumbnails appear on the screen, depending on the folder you selected.
3. Choose the video or photo that you want to play.
 - You can view the file information by moving the mouse over the file.
 - If you click a video thumbnail once, the video plays back inside the thumbnail frame, allowing you to search for a desired scene with ease.
4. After you select the video or photo you want, double-click to play back.
 - Playback starts and the controls appear.



Intelli-studio supports the following file formats:

- Video formats: MP4 (Video: H.264, Audio: AAC), WMV (WMV 7/8/9)
- Photo formats: JPG, GIF, BMP, PNG, TIFF

Step 4. Editing videos or photos

With Intelli-studio, you can edit the videos or photos in various ways with various functions. (Change Size, Fine-Tuning, Image Effect, Insert Frame, etc.)

- Before editing a video or photo in Intelli-studio, make a backup copy of the video or photo file and store it on your computer for safe-keeping using My Computer or Windows Explorer.

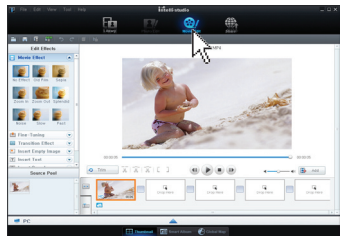

Step 5. Sharing the videos/photos online

Share your contents with the world by uploading photos and videos directly to a web site with one click.

1. Select the videos or photos you want to share.
2. Click **"Share"** on the Intelli-studio browser.
 - The selected file appears in the sharing window.
3. Click the web site you would like to upload files to.
 - You can choose "YouTube," "Flickr," "Facebook," or another web site you want to use for your uploading management.
4. Click **"Upload"** to start uploading.
 - A pop up window appears asking for your ID and password.
5. Enter your ID and the password to access.
 - Access to the web site contents can be limited depending on your web access environment.



- For more information about using Intelli-studio, open the Help Guide by clicking **"Help."**
- The Intelli-studio application will run faster if you install it on your Windows computer. To install, click **"Tool"** → **"Install Intelli-studio on PC"** on the Intelli-studio screen.

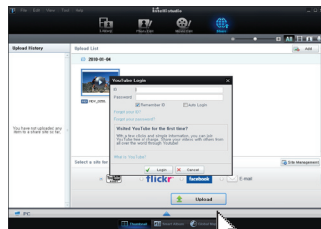
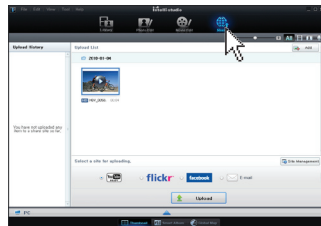

flickr

- Flickr is an image hosting website, web services suite, and online community platform. In addition to being a popular website for users to share personal photographs, this service is widely used by bloggers as a photo repository.

- <http://www.flickr.com/>

facebook

- Facebook is a global social networking website that is operated and privately owned by Facebook, Inc. Users can add friends and send messages, and update their personal profiles to notify friends about themselves. Additionally, users can join networks organized by city, workplace, school, and region.

- <http://www.facebook.com/>

YouTube
READY

- YouTube is a video sharing website. Users can upload, view, and share personalized video clips. The San Bruno-based service uses Adobe Flash technology to display a wide variety of users-generated contents including video clips, TV clips and music videos, as well as amateur contents such as video blogging and short original videos.
- <http://www.youtube.com/>

using with a Windows computer

USING AS A REMOVABLE STORAGE DEVICE

You can copy video or photo files recorded by the camcorder to a Windows computer by connecting the camcorder to the computer using a USB cable.

Viewing the contents of storage media

1. Set “USB Connect” to “Mass Storage.” ↪ page 82
2. Set “PC Software” to “Off.” ↪ page 82
3. Insert a memory card. ↪ page 28
4. Connect the camcorder to the PC with the USB cable.
↪ page 95
 - The “Removable Disk” or “Samsung” window appears on the PC’s screen after a moment.
 - Select “Open folders to view files using Windows Explorer”, and then click “OK.”
5. The folders in the storage media appear.
 - Different file types are stored in different folders.
6. Select the desired folder or files to copy, then drag and drop them into the destination folder.
 - The folder or files are copied from the storage media to the PC.



- If the “Removable Disk” window does not appear, confirm the connection (↪ page 95) or perform steps 1 and 4 again. If the removable disk does not appear automatically, open the removable disk folder in My Computer.
- If the connected camcorder’s disk drive does not open or the context menu that appears when right clicking your mouse (open or browse) appears broken, your computer may be infected by Autorun virus. Please update your anti-virus software to its latest version and scan your disk drives.

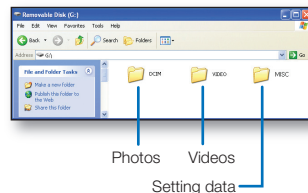
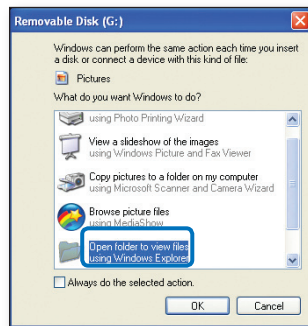

Structure of folders and files on the storage media

- The folder and file structure for storage media are below.
- File naming follows DCF (Design rule for Camera File System) rules.

Video file (H.264) ①

- HD-quality videos have an HDV_####.MP4 name format.
- SD-quality videos have a SDV_####.MP4 name format.
- The file number used in the file name automatically increases when you create a new video file.
- A new folder is created when the file number has reached 999-1,000.
- The folder names are given in the following order: 100VIDEO, 101VIDEO, etc. The maximum number of folders is 999.
- The camcorder can create a maximum of 9,999 files in a storage media.

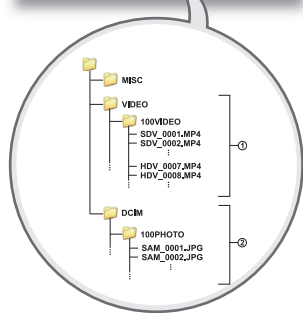
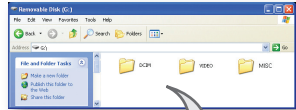

Photo file ②

- As with video files, the file number used in the file name automatically increases when you create a new photo file.
- Photos have a SAM_####.JPG name format.
- The folder names are given in the following order: 100PHOTO, 101PHOTO, etc.

File format

Video files

- Video files are compressed in H.264 format. The file extension is “.MP4.”
- Refer to page 50 for the video resolution.

Photo files

- Photo images are compressed in JPEG (Joint Photographic Experts Group) format. The file extension is “.JPG.”
- Refer to page 51 for the photo resolution.



Do not modify the name of a video file recorded by the camcorder. For proper playback, the camcorder requires that files have their original folder and file names.

troubleshooting

Before contacting a Samsung authorized service center, perform the following simple checks. They may save you the time and expense of an unnecessary call.





WARNING INDICATORS AND MESSAGES



Problems may occur because of the following reasons. Check the information and take corrective action.

Battery

Message	Icon	Informs that...	Action
Low Battery	-	The battery is almost discharged.	<ul style="list-style-type: none">• Replace with a charged battery or connect the AC power adaptor.
Check authenticity of the battery.	-	The battery can not pass authenticity check.	<ul style="list-style-type: none">• Check whether the battery is authentic. If not, change to an authentic Samsung battery.• We recommend you use only genuine Samsung batteries in this camcorder.

Storage media

Message	Icon	Informs that ...	Action
Insert card		There is no memory card inserted in the memory card slot.	<ul style="list-style-type: none">• Insert a memory card.
Card Full		There is not enough space to record on the memory card.	<ul style="list-style-type: none">• Delete unnecessary files from the memory card.• Back-up files to a PC or another storage media, and then delete unneeded files.• Replace the memory card with another card that has enough free space.
Card Locked		The write protection tab on an SD or SDHC card has been set to lock.	<ul style="list-style-type: none">• Release the write protection tab.
Card Error		The memory card has a problem and the camcorder can not recognize it.	<ul style="list-style-type: none">• Replace the memory card with another card.

Message	Icon	Informs that ...	Action
Not Formatted		The memory card is not formatted in this camcorder.	<ul style="list-style-type: none"> Format the memory card using this camcorder.
Not Supported Format		The memory card may have been formatted by another device and may still have existing images on it.	<ul style="list-style-type: none"> Files cannot be played as the memory card format is not supported by the camcorder. Format the card using the camcorder or replace the card with a card formatted correctly.
Not Supported Card		The memory card is not supported in this camcorder.	<ul style="list-style-type: none"> Replace the memory card with a recommended card.
Low Speed Card. Please record at a lower resolution.	-	The memory card is not fast enough to record at this resolution.	<ul style="list-style-type: none"> Record video at a lower resolution and quality. Replace memory card with a faster card.

Recording

Message	Icon	Informs that ...	Action
Write Error	-	A problem has occurred while the camcorder was writing data to storage media.	<ul style="list-style-type: none"> Turn the camcorder's power off and on for data recovery. If a file is not recovered, use the camcorder to format the storage media after backing up important files to a PC or another storage media.
Release the Smart Auto	-	You can not operate some functions manually when Smart Auto is activated.	<ul style="list-style-type: none"> Release the Smart Auto function.
Recovering Data... Don't power off and keep card inside.	-	The file was not created normally.	<ul style="list-style-type: none"> Wait until data recovery is finished. Never turn off the power or eject the memory card during recording.

troubleshooting

Recording

Message	Icon	Informs that ...	Action
The number of video files is full. Cannot record video.	-	The number of video files that can be stored is 9,999.	<ul style="list-style-type: none">• Delete unnecessary files from the storage media.• Back up files to your PC or another storage media and delete unneeded files.• Change to another card which has enough free space.• Set "File No." to "Reset."• Format the storage media.
The number of photo files is full. Cannot take a photo.	-	The number of photo files that can be stored is 9,999.	<ul style="list-style-type: none">• Delete unnecessary files on the storage media.• Back up files to your PC or another storage media and delete unneeded files.• Change to another card which has enough free space.• Set "File No." to "Reset."• Format the storage media.
File number is full. Cannot record video.	-	Folder and file number have reached the maximum number and you can not record.	<ul style="list-style-type: none">• Set "File No." to "Reset" and format the storage media. Remember to back up important files before formatting.
File number is full. Cannot take a photo.	-	Folder and file number have reached the maximum number and you can not record.	<ul style="list-style-type: none">• Set "File No." to "Reset" and format the storage media. Remember to back up important files before formatting.

Playback

Message	Icon	Informs that ...	Action
Read Error	-	A problem has occurred while the camcorder was reading data from the storage media.	<ul style="list-style-type: none">• Use the camcorder to format the storage media after backing up important files to a PC or another storage device.
Corrupted file	-	This file can not be read.	<ul style="list-style-type: none">• Use the camcorder to format the storage media after backing up important files to a PC or another storage device.

Editing videos

Message	Icon	Informs that ...	Action
Cannot select different resolution.	-	The files you want to combine have different resolutions.	<ul style="list-style-type: none">You can not combine files that have different resolutions.
Not enough free space in Card.	-	You cannot edit due to insufficient space on memory card.	<ul style="list-style-type: none">Edit after deleting unnecessary files.
Select 2 files for combine.	-	Only two files can be combined.	<ul style="list-style-type: none">Combine two files first, and then combine the resulting file with an additional file. Note that you can not combine files if the total size of the combined files exceeds 1.8GB.
Total file size is over than 1.8GB.	-	The files whose total size is likely to exceed 1.8GB cannot be combined.	<ul style="list-style-type: none">Perform a divide or partial delete function first to delete unnecessary parts of the files, and then perform the combine function.

troubleshooting

USB

Message	Icon	Informs that...	Action
Fail Printer Connecting Change 'USB Connect'	-	A problem occurred when connecting the camcorder via USB to a printer.	<ul style="list-style-type: none">• Check the USB cable.• Try the connection procedure again.• Switch "USB connect" function to "PictBridge."
Fail USB Connecting Change 'USB Connect'	-	A problem occurred when connecting the camcorder via USB to a PC.	<ul style="list-style-type: none">• Check the USB cable.• Try the connection procedure again.• Switch "USB connect" function to "Mass Storage."
Ink Error	-	There is a problem with an ink cartridge.	<ul style="list-style-type: none">• Check the ink cartridge.• Put a new ink cartridge into the printer.
Paper Error	-	There is a problem with the paper.	<ul style="list-style-type: none">• Check the paper in the printer. If there is no paper, insert paper.
File Error	-	There is a problem with the file.	<ul style="list-style-type: none">• Your camcorder does not support this file format.• Try another file recorded on your camcorder.
Printer Error	-	There is a problem with the printer.	<ul style="list-style-type: none">• Turn the printer's power off and on.• Contact the printer manufacturer's service center.
Print Error	-	A problem occurred during printing.	<ul style="list-style-type: none">• Do not remove the camcorder's power source or eject the memory card during printing.

SYMPTOMS AND SOLUTIONS

If these instructions do not solve your problem, contact your nearest Samsung authorized service center.

Power

Symptom	Explanation/Solution
The camcorder does not turn on.	<ul style="list-style-type: none">• The battery may not be installed in your camcorder. Insert the battery into the camcorder.• The inserted battery may be discharged. Charge the battery or replace it with a charged one.• If you use the AC power adaptor, make sure it is properly connected to a wall outlet.
The power turns off automatically.	<ul style="list-style-type: none">• Is "Auto Power Off" set to "5 Min"? If no button is pressed for about 5 minutes, the camcorder is automatically turned off ("Auto Power Off"). To disable this option, change the setting of "Auto Power Off" to "Off." ↪page 80• The battery is almost exhausted. Charge the battery or replace it with a charged one.
Power cannot be turned off.	<ul style="list-style-type: none">• Remove the battery or unplug the AC power adaptor, and connect the power supply to the camcorder again before turning it on.
The battery discharges quickly.	<ul style="list-style-type: none">• The temperature is too low.• The battery is not fully charged. Charge the battery again.• The battery has reached the end of its lifespan and cannot be recharged. Use another battery.

Display

Symptom	Explanation/Solution
The TV screen or LCD display has distorted images or has stripes at the top/bottom or on the left/right.	<ul style="list-style-type: none">• This can occur when recording or viewing a 16:9 ratio image on a 4:3 ratio TV, or vice versa. For more details, see the display specification. ↪page 90
Unknown image appears on the LCD screen.	<ul style="list-style-type: none">• The camcorder is in Demo mode. If you do not want to see Demo images, change "Demo" to "Off." ↪page 85
Unknown indicator appears on the screen.	<ul style="list-style-type: none">• A warning indicator or message appears on the screen. ↪pages 102~106
An afterimage remains on the LCD screen.	<ul style="list-style-type: none">• This occurs if you disconnect the AC power adaptor or remove the battery before turning the power off.
The image on the LCD screen looks dark.	<ul style="list-style-type: none">• Ambient light is too bright. Adjust the brightness and angle of the LCD.

troubleshooting

Recording

Symptom	Explanation/Solution
Pressing the Recording start/stop button does not start recording.	<ul style="list-style-type: none">• Press the MODE button to set the record mode. ↪page 24• There is not enough free space to record on the storage media.• Check if memory card is not inserted or write-protect tab is set to lock.
The actual recording time is less than the estimated recording time.	<ul style="list-style-type: none">• The estimated recording time may vary depending on content and features used.• When you record an object that moves quickly, the actual recording time may be shortened.
The recording stops automatically.	<ul style="list-style-type: none">• There is no more free space for recording on the storage media. Back up important files on your PC and format the storage media or delete unnecessary files.• If you make recordings or delete files frequently, the performance of the storage media deteriorates. If this occurs, format the storage media again.• If you use a memory card with a low write speed, the camcorder automatically stops recording videos and displays a message on the LCD screen.
When recording a subject illuminated by bright light, a vertical line appears.	<ul style="list-style-type: none">• This is not a malfunction.
When the screen is exposed to direct sunlight during recording, the screen becomes red or black for an instant.	<ul style="list-style-type: none">• This is not a malfunction.
During recording, the date/time does not display.	<ul style="list-style-type: none">• "Date/Time Display" is set to "Off." Set the "Date/Time Display" to On. ↪page 77
You cannot record a photo image.	<ul style="list-style-type: none">• Set your camcorder to the record mode. ↪page 24• Release the lock on the write-protection tab of the memory card if any.• The storage media is full. Use a new memory card or format the storage media. ↪page 74 Or remove unnecessary images. ↪page 69
You don't hear the shutter sound when you record a photo image.	<ul style="list-style-type: none">• Set "Shutter Sound" to "On."• During dual recording (video and photo), the Shutter Sound is off.• When the Mini HDMI cable or Audio/Video cable is connected to the camcorder, the Shutter Sound is not available.
You don't hear the beep sound.	<ul style="list-style-type: none">• Set "Beep Sound" to "On."• Beep sound is temporarily off while recording videos.• When the Mini HDMI cable or Audio/Video cable is connected to the camcorder, the Beep Sound is not available.
There is a time difference between the point where you press the Recording start/stop button and the point where the recorded video starts/stops.	<ul style="list-style-type: none">• On your camcorder, there may be a slight time delay between the point where you press the Recording start/stop button and the actual point where the recorded video starts/stops. This is not an error.
Horizontal stripes appear on the images.	<ul style="list-style-type: none">• This occurs when recording images under a fluorescent lamp, sodium lamp, or mercury lamp. This is not a malfunction.

Storage Media

Symptom	Explanation/Solution
Memory card functions do not operate.	<ul style="list-style-type: none"> • Insert a memory card into your camcorder properly. ↪page 28 • If you use a memory card formatted on a computer, format it again directly on your camcorder. ↪page 74
Image cannot be deleted.	<ul style="list-style-type: none"> • Release the lock on the write-protect tab of the memory card (SDHC/SD memory card), if any. ↪page 29 • You cannot delete a protected image. Release protection of the image using the Protect function. ↪page 70
You cannot format the memory card.	<ul style="list-style-type: none"> • Release the lock on the write-protect tab of the memory card (SDHC/SD memory card), if any. ↪page 29 • The memory card is not supported on your camcorder or the card has some problems.
The data file name is not indicated correctly.	<ul style="list-style-type: none"> • The file may be corrupted. • The file format is not supported by your camcorder. • The file name is displayed correctly only if the directory structure complies with the international standard.

Adjusting the image during recording

Symptom	Explanation/Solution
Focus does not adjust automatically.	<ul style="list-style-type: none"> • Set "Focus" to "Auto." ↪page 57 • The recording conditions are not suitable for auto focus. Adjust the focus manually. ↪page 57 • The lens is dusty on the surface. Clean the lens and check the focus. • Recording is being made in a dark location. Use a light to brighten the area.
The image appears too bright, flickers, or changes color.	<ul style="list-style-type: none"> • This may occur when you make a recording under a fluorescent sodium, or mercury lamp. Cancel "iSCENE" to avoid or minimize this phenomenon. ↪page 49
Image's color balance is not natural.	<ul style="list-style-type: none"> • The white balance is incorrect. Set the proper "White Balance." ↪page 52
A subject passing quickly through the frame appears distorted	<ul style="list-style-type: none"> • This is called the focal plane phenomenon. This is not a malfunction. Because of the way the image device (CMOS sensor) reads out video signals, a subject passing through a frame rapidly may appear to bend, depending on the recording conditions.

troubleshooting

Playback on your camcorder

Symptom	Explanation/Solution
Playback (play/pause) function does not work.	<ul style="list-style-type: none">• Image files recorded using another device may not play on your camcorder.• Check memory card compatibility. ↪ page 29
Photo images stored on a storage media are not displayed in the actual size.	<ul style="list-style-type: none">• Photo images recorded on other devices may not appear in their actual size. This is not an error.
Playback is interrupted unexpectedly.	<ul style="list-style-type: none">• Check if the AC power adaptor or battery back is properly connected and secure.

Playback on other devices (TV, etc.)

Symptom	Explanation/Solution
You cannot view the image on or hear the sound from the connected device.	<ul style="list-style-type: none">• Make sure that the connection cable is connected to the proper jack.
The image appears distorted on a TV.	<ul style="list-style-type: none">• This phenomenon is caused by connecting to a TV with 4:3 aspect ratio.
You cannot view the image on or hear the sound from a TV connected using the HDMI cable.	<ul style="list-style-type: none">• The camcorder can not output Images from the HDMI jack if the material is copyright protected.

Connecting/Dubbing with other devices (Recorder, PC, Printer, etc.)

Symptom	Explanation/Solution
You cannot dub correctly using the HDMI cable.	<ul style="list-style-type: none">• You cannot dub images using the HDMI cable.
You cannot dub correctly using the Audio/Video cable.	<ul style="list-style-type: none">• The Audio/Video cable is not connected properly. Make sure that the Audio/Video cable is connected to the proper jack, i.e. to the input jack of the device used for dubbing images from your camcorder. ↪ page 91
Your PictBridge printer cannot print photos from your camcorder.	<ul style="list-style-type: none">• Your printer may not print images edited on a computer or recorded using other devices. This is not an error.

Connecting to a computer

Symptom	Explanation/Solution
Your computer does not recognize your camcorder.	<ul style="list-style-type: none"> • Disconnect the USB cable from the computer and camcorder, restart the computer, and then connect the USB cable again correctly.
Cannot play a video file properly on a PC.	<ul style="list-style-type: none"> • You need a video codec to play the file recorded on your camcorder. Install the software provided with your camcorder. ↪page 99 • Make sure you insert the connector in the correct direction, and connect the USB cable to the USB jack on your camcorder firmly. • Disconnect the cable from the computer and camcorder, restart the computer, and then connect the cable again properly. • To play back an HD video file, you need a computer with better specifications. Use a computer with the recommended specifications. ↪page 94
Intelli-studio does not function properly.	<ul style="list-style-type: none"> • Exit the Intelli-studio application, and restart the Windows computer.
Intelli-studio does not start.	<ul style="list-style-type: none"> • Set "PC Software" to "On" in the Settings menu or install Intelli-studio on the computer. ↪pages 82, 99
Your computer is not playing videos, images, or sound located on your camcorder properly.	<ul style="list-style-type: none"> • Video playback or sound may stop temporarily depending on your computer. The video or sound copied to your computer is not affected. • If your camcorder is connected to a computer that does not support Hi-speed USB (USB2.0), the image or sound may not play correctly. Images, video, and sound copied from the camcorder to your computer are not affected.
The playback screen is paused or distorted.	<ul style="list-style-type: none"> • Check the system requirements to play a video. • Shut down all other applications currently running on the computer. • If you play a video on your camcorder when it is connected to a computer, the video may not play smoothly on the computer, depending on the transfer speed. Please copy the file to your PC, and then play it back.

troubleshooting

Overall operations

Symptom	Explanation/Solution
The date and time are incorrect.	<ul style="list-style-type: none">Has the camcorder been left unused for a long period of time? The backup internal rechargeable battery may be discharged. ↳ page 26

Menu items that cannot be used at the same time

Symptom	Cannot use	Because of the following settings
Menu items are grayed out	"Photo Resolution"	"Cont. Shot"

- You cannot select grayed menu items in the current recording/playback mode.
- There are some functions you cannot activate simultaneously.
The list shown above shows examples of unworkable combinations of functions and menu items.
- Menu and quick menu cannot be used in Smart Auto mode.
- The following functions cannot be used during video recording:
"Video Resolution," "Video Quality," "Photo Resolution," "Photo Sharpness," "Fader," "Cont.Shot," "Digital Zoom," "Self Timer."
- The following functions are automatically set to Off or Auto mode in the Smart Auto mode:
"iSCENE," "Shutter," "Digital Effect," "Tele Macro," etc.
- In the Smart Auto mode, your camcorder automatically chooses the appropriate camcorder settings based on a detected type of scene. Most settings are automatically adjusted in Smart Auto mode. To set or adjust functions on your own, release the Smart Auto mode first.

maintenance & additional information

MAINTENANCE

The suggestions below will help you fulfill any warranty obligations and allow you to enjoy this product for many years.

Cautions when storing

- For safekeeping of the camcorder, turn off the camcorder.
 - Remove the battery and AC power adaptor.
 - Remove the memory card.

Cleaning the camcorder

Before cleaning, turn off the camcorder and remove the battery and AC power adaptor.

- **To clean the exterior**
 - Wipe gently with a soft dry cloth. Do not apply excessive force when cleaning. Gently rub the surface.
 - Do not use benzene or thinner to clean the camcorder. The exterior coating could peel off or the case could deteriorate.
- **To clean the LCD screen**
Wipe very gently with a soft dry cloth. Be careful not to damage the screen.
- **To clean the lens**
Use a blower brush to remove dust, and then wipe the lens gently with a soft cloth. If necessary, wipe gently with lens paper or tissue.
 - Mold may form if the lens is left dirty.
 - If the lens looks dim, turn off the camcorder and leave it off for about 1 hour.

LCD screen

To prolong its service life, do not rub the LCD screen with a coarse cloth.

- **Be aware of the following LCD screen phenomena. They are not malfunctions.**
 - When you use the camcorder, the surface around the LCD screen may heat up.
 - If you leave the power on for a long time, the surface around the LCD screen becomes hot.
 - When using the camcorder in cold conditions, an afterimage may appear on the LCD screen.
- An LCD screen is manufactured using advanced technology which creates screens with pixel failure rates of less than 0.01%. However, a black or bright spot (red, blue, white) may appear in the center of the LCD screen and up to two spots may appear outside the center. These spots, which are normally incurred during the manufacturing process, do not affect the recorded images.

Q When there is dew condensation, put the camcorder aside for a while before using

- What is dew condensation?
Dew condensation happens when a camcorder is moved to a location where there is a significant temperature difference from the previous location. The dew condenses on the external or internal parts of the camcorder, and on the reflection lens. If there is dew on or in your camcorder, it may cause the camcorder to malfunction or damage the camcorder when you turn the power on.
- Exactly when does dew condensation occur?
When you move the camera to a location with a higher temperature than the previous location, or when you move it to a hot area suddenly. Examples:
 - You record outside in cold weather during the winter and then move the camera in indoors.
 - You record outside in hot weather after being indoors or inside a car where the A/C was running.
- What can I do?
 - Turn the power off, detach the battery, and leave the camcorder in a dry area for 1–2 hours before using it.



- Use the camcorder only after dew condensation has completely disappeared.
- Be sure to use the recommended accessories supplied with the camcorder. For service, contact your nearest Samsung authorized service center.

maintenance & additional information

USING YOUR CAMCORDER ABROAD

- Each country or region has its own electric and color systems.
- Before using your camcorder abroad, check the following items.

Power sources

The AC adaptor provided lets you power, recharge, and use your camcorder in any country/region that has AC power in the 100 V to 240 V, 50/60 Hz range. You may need a commercially available AC plug adaptor depending on the design of local wall outlets.

On TV color systems

Your camcorder is an **NTSC** based camcorder. If you want to view your recordings on a TV or copy them to an external device, it must be an **NTSC** based TV or external device and have the appropriate Audio/Video jacks. Otherwise, you may need to use a separate video format transcoder (For example, an NTSC to PAL format converter).



The format transcoder is not provided by Samsung.

NTSC-compatible countries/regions

Bahamas, Canada, Central America, Japan, Korea, Mexico, Philippines, Taiwan, United States of America, etc.

PAL-compatible countries/regions

Australia, Austria, Belgium, Bulgaria, China, CIS, Czech Republic, Denmark, Egypt, Finland, France, Germany, Greece, Great Britain, Holland, Hong Kong, Hungary, India, Iran, Iraq, Kuwait, Libya, Malaysia, Mauritius, Norway, Romania, Saudi Arabia, Singapore, Slovak Republic, Spain, Sweden, Switzerland, Syria, Thailand, Tunisia, etc.



You can make recordings with your camcorder and view pictures on the LCD screen anywhere in the world.

specifications

Model name	HMX-T10WN / HMX-T10BN / HMX-T10ON	
System	Video signal Picture compression format Audio compression format Image device Lens Focal length Filter diameter	NTSC H.264 (MPEG-4.AVC) AAC (Advanced Audio Coding) 1/4", 5.1M Pixel CMOS F1.8 ~ F2.5, 10x optical zoom, 100x digital zoom 2.75mm ~ 27.5mm Ø 34
LCD screen	Size/dot number LCD screen method	2.7" Wide Touch LCD / 230k TFT LCD
Connectors	Composite output HDMI output Audio output USB output	1Vp-p (75 Ω terminated) C type connector -7.5 dBs (600 Ω terminated) mini USB-B type (USB2.0 High Speed)
General	Power source Power source type Power consumption (Recording) Operating temperature Storage temperature Storage media External dimensions (WxHxD) Weight Internal MIC	DC 5 V, Lithium Ion battery pack 3.7 V Lithium Ion battery pack, Power supply (100 V ~ 240 V) 50/60 Hz 2.5W (LCD on) 0 °C ~ 40 °C (32 °F~104 °F) -20 °C ~ 60 °C (-4 °F ~ 140 °F) Memory card (SD/SDHC) (Not supplied) Approx. 38.6mm (1.52 inches) x 54.4mm (2.14 inches) x 118mm (4.65 inches) Approx. 195.3g (0.43 lb, 6.89 oz) (Except for Lithium Ion battery) Omni-directional stereo microphone

※ The technical specifications and design may be changed without notice.

warranty

SAMSUNG LIMITED WARRANTY

SAMSUNG Electronics America Inc. (SEA), warrants that this product is free from defective material and workmanship.

SEA further warrants that if product fails to operate properly within the specified warranty period and the failure is due to improper workmanship or defective material, SEA will repair or replace the product at it's option.

All warranty repairs must be performed by a SEA authorized service center. The name and address of the location nearest you can be obtained by calling toll free: 1-800 SAMSUNG (1-800-726-7864).

Labor

90 days carry-in

Parts

1 year

On carry-in models, transportation to and from the service center is the customer's responsibility.

The original dated sales receipt must be retained by the customer and is the only acceptable proof of purchase.

It must be presented to the authorized service center.

EXCLUSIONS (WHAT IS NOT COVERED)

This warranty does not cover damage due to accident, fire, flood and/or other acts of God; misuse, incorrect line voltage, improper installation, improper or unauthorized repairs, commercial use, or damage that occurs in shipping.

Exterior and interior finish, lamps, and glass are not covered under this warranty.

Customer adjustments which are explained in the instruction manual are not covered under the terms of this warranty.

This warranty will automatically be voided for any unit found with a missing or altered serial number. This warranty is valid only on products purchased in the United States and Puerto Rico.

Some States do not allow the exclusions or limitations of incidental or consequential damages, or allow limitations on how long an implied warranty lasts, so the above limitations or exclusions may not apply to you.

This warranty gives you specific legal rights, and you may also have other rights which vary from State to State.



COUNTRY	CALL	OR VISIT US ONLINE AT	WRITE
IN THE US	1-800-SAMSUNG (726-7864)	www.samsung.com	Samsung Electronics America, Inc. 85 Challenger Road Ridgefield Park, NJ 07660-2112



RoHS compliant

Our product complies with "The Restriction Of the use of certain Hazardous Substances in electrical and electronic equipment", and we do not use the 6 hazardous materials- Cadmium(Cd), Lead (Pb), Mercury (Hg), Hexavalent Chromium (Cr +6), Poly Brominated Biphenyls (PBBs), Poly Brominated Diphenyl Ethers(PBDEs)- in our products.

Free Manuals Download Website

<http://myh66.com>

<http://usermanuals.us>

<http://www.somanuals.com>

<http://www.4manuals.cc>

<http://www.manual-lib.com>

<http://www.404manual.com>

<http://www.luxmanual.com>

<http://aubethermostatmanual.com>

Golf course search by state

<http://golfingnear.com>

Email search by domain

<http://emailbydomain.com>

Auto manuals search

<http://auto.somanuals.com>

TV manuals search

<http://tv.somanuals.com>