

SHARP®

MODEL
AR-BC320

DIGITAL FULL COLOR MULTIFUNCTIONAL SYSTEM

OPERATION MANUAL
(for general information and copier operation)



(Option) Duplex bypass / inverter unit and Stand / 3 x 500 sheet paper drawer

| | Page |
|--|------|
| • BEFORE USING THE PRODUCT | 1-1 |
| • MANAGING THE MACHINE | 2-1 |
| • PERIPHERAL DEVICES | 3-1 |
| • BEFORE MAKING COPIES | 4-1 |
| • BASIC PROCEDURE FOR MAKING COPIES | 5-1 |
| • CONVENIENT COPY FUNCTIONS | 6-1 |
| • MACHINE MAINTENANCE (FOR COPYING) | 7-1 |
| • SPECIFICATIONS | 8-1 |

Be sure to become thoroughly familiar with this manual to gain the maximum benefit from the product.

Before installing this product, be sure to read the installation requirements and cautions sections.

Be sure to keep all operation manuals handy for reference including this manual, the "Operation manual (for general information and copier operation)" and operation manuals for any optional equipment which has been installed.

The power switch positions are marked " I " to indicate power "ON" and " ⏻ " to indicate stand-by.
In the stand-by position, power is being supplied to a drying heater within the optical system of the copier.

Caution:

For complete electrical disconnection, pull out the main plug.

The socket-outlet shall be installed near the equipment and shall be easily accessible.

FOR YOUR RECORDS ...

To protect against loss or theft, record and retain for reference the machine's serial number located on the back of the unit.

Model Number _____ AR-BC320 _____

Serial Number _____

Date of Purchase _____

Place of Purchase _____

Authorized Sharp Copier/Printer _____

Service Department Number _____

Warranty

While every effort has been made to make this document as accurate and helpful as possible, SHARP Corporation makes no warranty of any kind with regard to its content. All information included herein is subject to change without notice. SHARP is not responsible for any loss or damages, direct or indirect, arising from or related to the use of this operation manual.

© Copyright SHARP Corporation 2004. All rights reserved. Reproduction, adaptation or translation without prior written permission is prohibited, except as allowed under copyright laws.

This operation manual is also used for the AR-BC320 J.

Part 1: General Information

NOTES

- Considerable care has been taken in preparing this manual. If you have any comments or concerns about the manual, please contact your nearest SHARP Service Department.
- This product has undergone strict quality control and inspection procedures. In the unlikely event that a defect or other problem is discovered, please contact your dealer or nearest SHARP Service Department.
- Aside from instances provided for by law, SHARP is not responsible for failures occurring during use of the product or its options, or failures due to incorrect operation of the product and its options, or other failures, or for any damage that occurs due to use of the product.

The display screens, messages, and key names shown in the manual may differ from those on the actual machine due to product improvements and modifications.

OPERATION MANUALS

The following operation manuals are provided for the machine. Please read the appropriate manuals as needed for the features you wish to learn about.

- **Operation manual (for general information and copier operation) (this manual):**

The first half of this manual provides general information about the machine, including safety information, loading paper, removing misfeeds, and regular maintenance.

The second half of the manual explains how to use the copy functions.

- **Key operator's guide:**

This primarily explains key operator programs for machine management and copier related functions. Key operator programs for the printer, the facsimile and network scanner functions are explained in separate manuals.

Key operator programs are used by key operators to configure function settings to meet the needs of the customer.

- **Operation manual (for facsimile):**

This manual explains the procedures for using the machine as a facsimile. To use the fax function, the facsimile expansion kit must be installed.

- **Installation guide (for printer):**

This explains how to connect the machine to your computer, install the printer driver for Windows, and configure the printer driver settings.

- **Operation manual (for printer)*:**

This manual explains the procedures for using the machine as a printer.

- **Operation manual (for network scanner)*:**

This manual explains the procedures for using the machine as a network scanner when connected to a computer.

* The Operation manual (for printer) and the Operation manual (for network scanner) are provided as PDF files on the supplied CD-ROM.

These manuals are not provided as printed manuals.

Some options may not be available in some countries and regions. This manual assumes that the optional facsimile expansion kit has been installed, however, the basic operations of the machine are the same regardless of the peripheral devices that are installed. For the peripheral devices that can be installed, see "Part names and functions of peripheral devices" (1-6).

INSTALLATION REQUIREMENTS

Improper installation may damage this product. Please note the following during initial installation and whenever the machine is moved.

1. The machine should be installed near an accessible power outlet for easy connection.



2. Be sure to connect the power cord only to a power outlet that meets the specified voltage and current requirements. Also make certain the outlet is properly grounded.

- For the power supply requirements, see the name plate on the main unit.

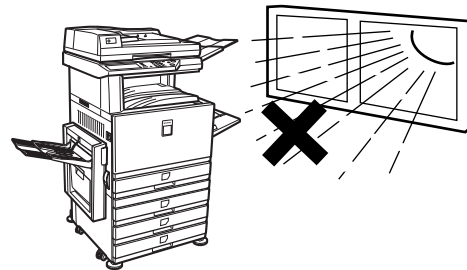

3. Do not install your machine in areas that are:

- damp, humid, or very dusty
- exposed to direct sunlight
- poorly ventilated
- subject to extreme temperature or humidity changes, e.g., near an air conditioner or heater.

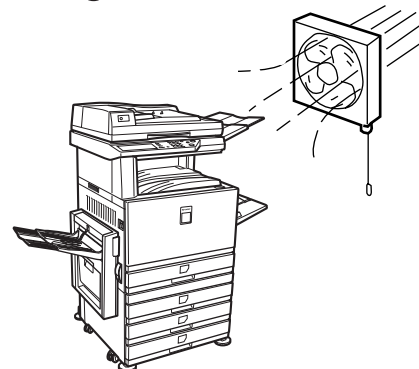

4. Be sure to allow the required space around the machine for servicing and proper ventilation.

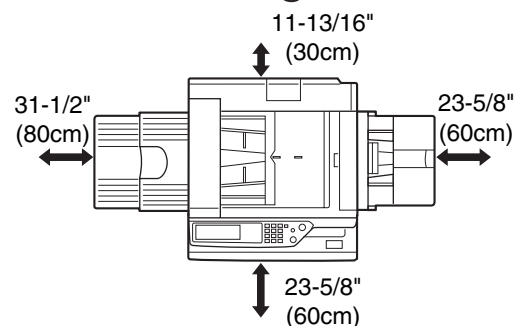
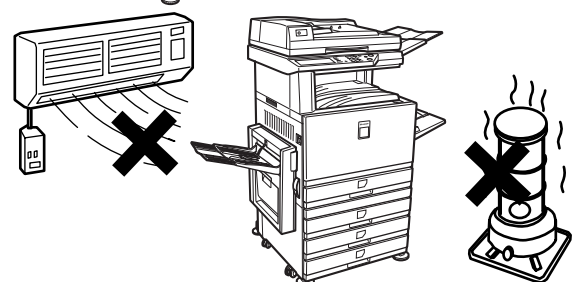

A small amount of ozone is produced within the copier during operation. The emission level is insufficient to cause any health hazard.

NOTE:

The present recommended long term exposure limit for ozone is 0.1 ppm (0.2 mg/m³) calculated as an 8 hr. time-weighted average concentration.

However, since the small amount that is emitted may have an objectionable odor, it is advisable to place the copier in a ventilated area.

Moving this machine

Pull out the four handles as shown below, grasp them firmly, and keep the machine horizontal while moving it.

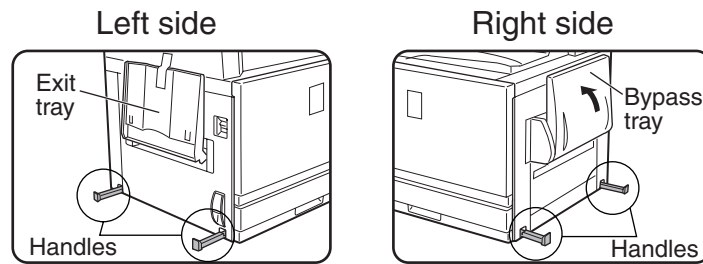

Before lifting the machine, fold up the exit tray and tape it securely to the machine.

Before lifting the machine, fold up the bypass tray and tape it securely to the machine.

Caution

Two people are required to lift and carry this machine.

If the machine has been placed on a stand/paper drawer:

The stand/paper drawer is on casters for moving. Unlock the casters and the adjusters of the stand/paper drawer and gently move the machine taking care to steady it to prevent it from toppling.

For locking and unlocking the casters and the adjusters, see page 0-4.

If the machine is to be left unused for a long time

If the machine is to be left unused for a month or longer, follow the procedure on pages 2-6 and 2-7 to release the pressure on the fusing roller.

CAUTIONS

1. Do not touch the photoconductive drum. Scratches or smudges on the drum will cause dirty prints.
2. The fusing unit is extremely hot. Exercise care in this area.
3. Do not look directly at the light source. Doing so may damage your eyes.
4. Four adjusters are provided on all optional stand/paper drawer units. These adjusters should be lowered until they contact the floor. When moving the machine with the optional stand/paper drawer, be sure to raise the adjusters. Also, unlock the two casters at the front of the optional stand/paper drawer. After moving the machine, lower the four adjusters until they reach the floor and lock the two casters.
5. Do not make any modifications to this machine. Doing so may result in personal injury or damage to the machine.
6. Since this machine is heavy, it is recommended that it be moved by more than one person to prevent injury.
7. When connecting this machine to a computer, be sure to first turn both the computer and the machine off.
8. Do not make copies of anything which is prohibited from copying by law. The following items are normally prohibited from printing by national law. Other items may be prohibited by local law.
 - Money • Stamps • Bonds • Stocks
 - Bank drafts • Checks • Passports
 - Driver's licenses

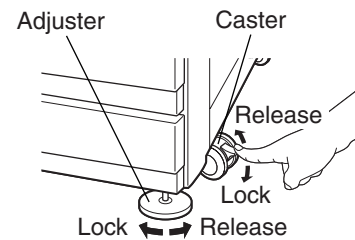
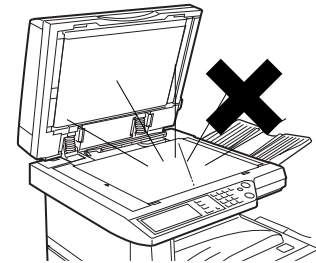
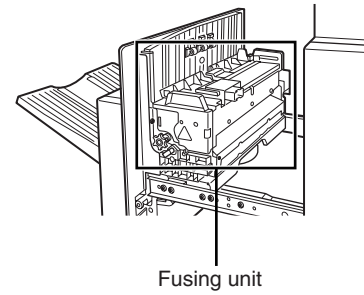

"BATTERY DISPOSAL"

THIS PRODUCT CONTAINS A LITHIUM PRIMARY MEMORY BACK-UP BATTERY THAT MUST BE DISPOSED OF PROPERLY. PLEASE CONTACT YOUR LOCAL SHARP DEALER OR AUTHORIZED SERVICE REPRESENTATIVE FOR ASSISTANCE IN DISPOSING OF THIS BATTERY.

This product utilizes tin-lead solder, and a fluorescent lamp containing a small amount of mercury. Disposal of these materials may be regulated due to environmental considerations.

For disposal or recycling information, please contact your local authorities or the Electronics Industries Alliance: www.eia.org

CONTENTS

| | |
|--------------------------------|-----|
| OPERATION MANUALS..... | 0-1 |
| INSTALLATION REQUIREMENTS..... | 0-2 |
| ● Moving this machine..... | 0-3 |
| CAUTIONS..... | 0-4 |

CHAPTER 1 BEFORE USING THE PRODUCT

| | |
|---|------|
| INTRODUCTION..... | 1-2 |
| MAIN FEATURES..... | 1-2 |
| PART NAMES AND FUNCTIONS..... | 1-4 |
| ● Exterior..... | 1-4 |
| ● Interior..... | 1-5 |
| ● Part names and functions of peripheral devices..... | 1-6 |
| ● Operation panel..... | 1-8 |
| ● Touch panel..... | 1-9 |
| AUDITING MODE..... | 1-11 |
| ● Using the machine when the auditing mode is enabled..... | 1-11 |

CHAPTER 2 MANAGING THE MACHINE

| | |
|---|------|
| LOADING PAPER..... | 2-2 |
| ● Loading paper in paper tray 1..... | 2-2 |
| ● Changing the paper size in paper tray 1..... | 2-2 |
| ● Loading paper in the bypass tray..... | 2-4 |
| ● Loading paper in the stand/1 x 500 sheet paper drawer/ stand/3 x 500 sheet paper drawer..... | 2-7 |
| ● Specifications (stand/1 x 500 sheet paper drawer/ stand/3 x 500 sheet paper drawer)..... | 2-7 |
| ● Loading paper in the duplex module/2 x 500 sheet paper drawer..... | 2-8 |
| ● Specifications (duplex module/2 x 500 sheet paper drawer)..... | 2-8 |
| ● Specifications of paper trays..... | 2-9 |
| ● Setting the paper type (except the bypass tray)..... | 2-11 |
| ● Setting the paper size when an extra size is loaded..... | 2-11 |
| ● Setting the paper type and paper size in the bypass tray..... | 2-12 |
| CUSTOM SETTINGS..... | 2-13 |
| ● Operation procedure common to all custom settings | 2-13 |
| ● About the settings..... | 2-14 |
| REPLACING THE TONER CARTRIDGES..... | 2-15 |
| STORAGE OF SUPPLIES..... | 2-17 |
| MISFEED REMOVAL..... | 2-18 |
| ● Misfeed removal guidance..... | 2-18 |
| ● Misfeed in the paper feed area..... | 2-19 |
| ● Misfeed in the transport area, fusing area, and exit area..... | 2-20 |
| ● Misfeed in the stand/1 x 500 sheet paper drawer..... | 2-21 |
| ● Misfeed in the stand/3 x 500 sheet paper drawer..... | 2-21 |
| ● Misfeed in the duplex bypass/inverter unit and duplex module/2 x 500 sheet paper drawer..... | 2-22 |
| TROUBLESHOOTING..... | 2-24 |

CHAPTER 3 PERIPHERAL DEVICES

| | |
|---|------|
| SADDLE STITCH FINISHER..... | 3-2 |
| ● Part names and functions..... | 3-2 |
| ● Specifications..... | 3-2 |
| ● Saddle stitch finisher functions..... | 3-4 |
| ● Using the saddle stitch finisher..... | 3-6 |
| ● Staple cartridge replacement and staple jam removal.. | 3-7 |
| ● Misfeed in the saddle stitch finisher..... | 3-10 |
| ● Troubleshooting saddle stitch finisher problems..... | 3-12 |
| ● Stapling position quick reference guide for duplex output..... | 3-13 |
| ● Relation between print image and saddle stitch..... | 3-14 |
| LARGE CAPACITY TRAY..... | 3-15 |
| ● Part name..... | 3-15 |
| ● Specifications..... | 3-15 |
| ● Loading paper in the large capacity tray..... | 3-16 |
| ● Misfeed in the large capacity tray..... | 3-17 |

CHAPTER 4 BEFORE MAKING COPIES

PART NAMES AND FUNCTIONS (The Reversing Automatic Document Feeder) 4-2

- Exterior 4-2
- Operation Panel 4-3
- Touch Panel (main screen of copy mode) 4-4

REVERSING AUTOMATIC DOCUMENT FEEDER 4-5

- Acceptable originals 4-5

SETTING ORIGINALS 4-6

SELECTING THE ORIGINAL SIZE 4-8

STORING, DELETING, AND USING ORIGINAL SIZES 4-9

CHAPTER 5 BASIC PROCEDURE FOR MAKING COPIES

NORMAL COPYING 5-2

- Copying from the reversing automatic document feeder 5-2
- Automatic two-sided copying from the reversing automatic document feeder 5-6
- Copying from the document glass 5-7
- Automatic two-sided copying from the document glass 5-9

EXPOSURE ADJUSTMENTS 5-10

REDUCTION/ENLARGEMENT/ZOOM 5-12

- Automatic selection (auto image) 5-12
- Manual selection 5-13
- XY ZOOM 5-15

SPECIAL PAPERS 5-17

CHAPTER 6 CONVENIENT COPY FUNCTIONS

SPECIAL MODES 6-2

- Common operation procedure for using the special functions 6-3
- Margin shift 6-4
- Erase 6-5
- Dual page copy 6-6
- Centering 6-7
- Transparency film with insert sheets 6-8
- Covers 6-9
- B/W reverse 6-10

COLOR ADJUSTMENTS MENU 6-11

- RGB adjust 6-12
- Sharpness 6-13
- Suppress background 6-13
- Color balance 6-14
- Brightness 6-15
- Intensity 6-15

IMAGE EDIT MENU 6-16

- Single color 6-17
- Mirror image 6-17
- Photo Repeat 6-18
- Multi shot 6-19
- 11" x 17" (A3) Full-bleed 6-21
- Multi-page enlargement 6-22
- Pamphlet copy 6-24

JOB PROGRAM MEMORY 6-25

- Storing a job program 6-25
- Recalling a job program 6-26
- Deleting a stored job program 6-26

INTERRUPTING A COPY RUN 6-27

CHAPTER 7 MACHINE MAINTENANCE (FOR COPYING)

REMOVING AN ORIGINAL MISFEED 7-2

- Removing a misfed original from the reversing automatic document feeder 7-2

USER MAINTENANCE (For copying) 7-3

TROUBLESHOOTING 7-4

CHAPTER 8 SPECIFICATIONS

SPECIFICATIONS 8-2

- Copier and Main unit 8-2
- Reversing automatic document feeder 8-4
- Duplex bypass/inverter unit (optional) 8-4

INDEX 8-5



CHAPTER 1

BEFORE USING THE PRODUCT

This chapter contains basic information that should be read before using the product.

| | Page |
|---|------|
| INTRODUCTION | 1-2 |
| MAIN FEATURES | 1-2 |
| PART NAMES AND FUNCTIONS | 1-4 |
| • Exterior | 1-4 |
| • Interior | 1-5 |
| • Part names and functions of peripheral devices | 1-6 |
| • Operation panel | 1-8 |
| • Touch panel | 1-9 |
| AUDITING MODE | 1-11 |
| • Using the machine when the auditing mode is enabled | 1-11 |

INTRODUCTION

To gain the maximum benefits in using this product, it is recommended that the user read this manual to become familiar with all the features and functions of the basic product and the precautionary information contained in the manual.

This product is a high speed Digital full color copier / printer that can be expanded to become multifunctional through the installation of optional peripheral devices. The product can be extended to include printer, network scanning or network printing capabilities. This manual describes the basic use of the product as a copier and does not contain information on using any of the optional peripheral devices. Separate operation manuals are included with each of the optional peripheral devices. Refer to these manuals for their operation.

Original and paper sizes

This machine allows use of standard sizes in both the inch and AB systems.

These are shown in the tables below.

| Sizes in the inch system |
|------------------------------|
| 11" x 17" (LEDGER) |
| 8-1/2" x 14" (LEGAL) |
| 8-1/2" x 13" (FOOLSCAP) |
| 8-1/2" x 11" (LETTER) |
| 7-1/4" x 10-1/2" (EXECUTIVE) |
| 5-1/2" x 8-1/2" (INVOICE) |

| Sizes in the AB system |
|------------------------|
| A3 |
| B4 |
| A4 |
| B5 |
| A5 |
| |

The meaning of "R" in original and paper size indications

Some original and paper sizes can be placed in either the portrait or landscape orientations. To differentiate between landscape and portrait, the landscape orientation size indication will contain an "R". These are indicated as 8-1/2" x 11"R, 5-1/2" x 8-1/2"R, A4R, B5R, etc. Sizes that can be placed only in the landscape orientation (11" x 17", 8-1/2" x 14", 8-1/2" x 13", A3, B4) do not contain the "R" in their size indication.

Size indication with "R"



Landscape orientation

Size indication without "R"

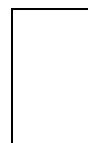

Portrait orientation

MAIN FEATURES

1 Full-color copies with vivid colors based on digital technology

Photos, color text, and other originals are scanned by full-color CCD sensors, and the acquired image information is output in vivid full color at a resolution of 600 dpi using digital image processing technology.

The machine can also be used as a full-color network printer, and network scanner.

2 A range of optional units to enhance productivity

A range of optional equipment is available to enhance productivity, such as duplex units for producing two-sided output, additional paper feed units to increase the number of available paper sizes and paper capacity, and paper output units that are capable of stapling and saddle stitch binding.

3 Advanced image processing features based on digital technology

The scanned image data is converted to digital data, enabling the following advanced image processing features:

- **Photo Repeat :**

Up to 24 full-size copies of a photo image can be made on a single sheet of paper (page 6-18).

- **Multi shot :**

Up to four original pages can be copied onto a single sheet (page 6-19).

- **Pamphlet copy* :**

Copies of original pages are arranged in proper order for copying so that the copies can be center-stapled and folded into a pamphlet (page 6-24).

* Pamphlet copy requires the Duplex module/2 x 500 sheet paper drawer and Duplex bypass/inverter unit options. If a saddle stitch finisher is installed, copies can be stapled in two positions along the center of copies and folded at the center.

4 Image processing manual exposure adjustment for optimal copying

Image processing is optimized for the type of original being copied (text, photo, mixed text and photo or map). This along with the ability to manually adjust exposure makes it possible to obtain copies that are faithful to the original.

5 Standard offset function makes it easy to distinguish between sets of copies

As sets of copies are delivered to the center tray, each set is offset from the previous set for easy separation.

6 PostScript compatible

Installation of an optional PS expansion kit (AR-PK4) gives PostScript compatibility (PostScript 3).



As an ENERGY STAR® Partner, SHARP has determined that this product meets the ENERGY STAR® guidelines for energy efficiency.

Energy saving features

This product has the following two power reducing modes to help conserve natural resources and reduce environmental pollution.

Preheat mode

Preheat mode automatically reduces the temperature of the fusing unit after the time set in the key operator programs elapses when the machine is on standby. This allows the machine to use less power while on standby. The machine automatically returns to normal operation when a key is pressed on the operation panel, or when an original is placed to make a copy or send a fax.

Auto power shut-off mode

Auto power shut-off mode automatically shuts off power to the fusing unit after the time set in the key operator programs elapses when the machine is on standby. This minimizes the power used by the machine while on standby. When this mode activates, the touch panel screen turns off.

To return the machine to normal operation, press the mode select key (the indicator of this key will be lit).

Auto power shut-off mode can be configured in the key operator programs. The mode is initially set (factory default setting) to activate after 60 seconds elapses. (See page 9 of the key operator's guide.)

If a print job or fax is received while auto power shut-off mode or preheat mode is activated, the machine automatically returns to normal operation.



The Environmental Choice Program guidelines are applied to the products only in Canada. The products that meet the Environmental Choice Program guidelines carry the logo shown above. The products without the logo may not meet the Environmental Choice Program guidelines.

PART NAMES AND FUNCTIONS

Exterior

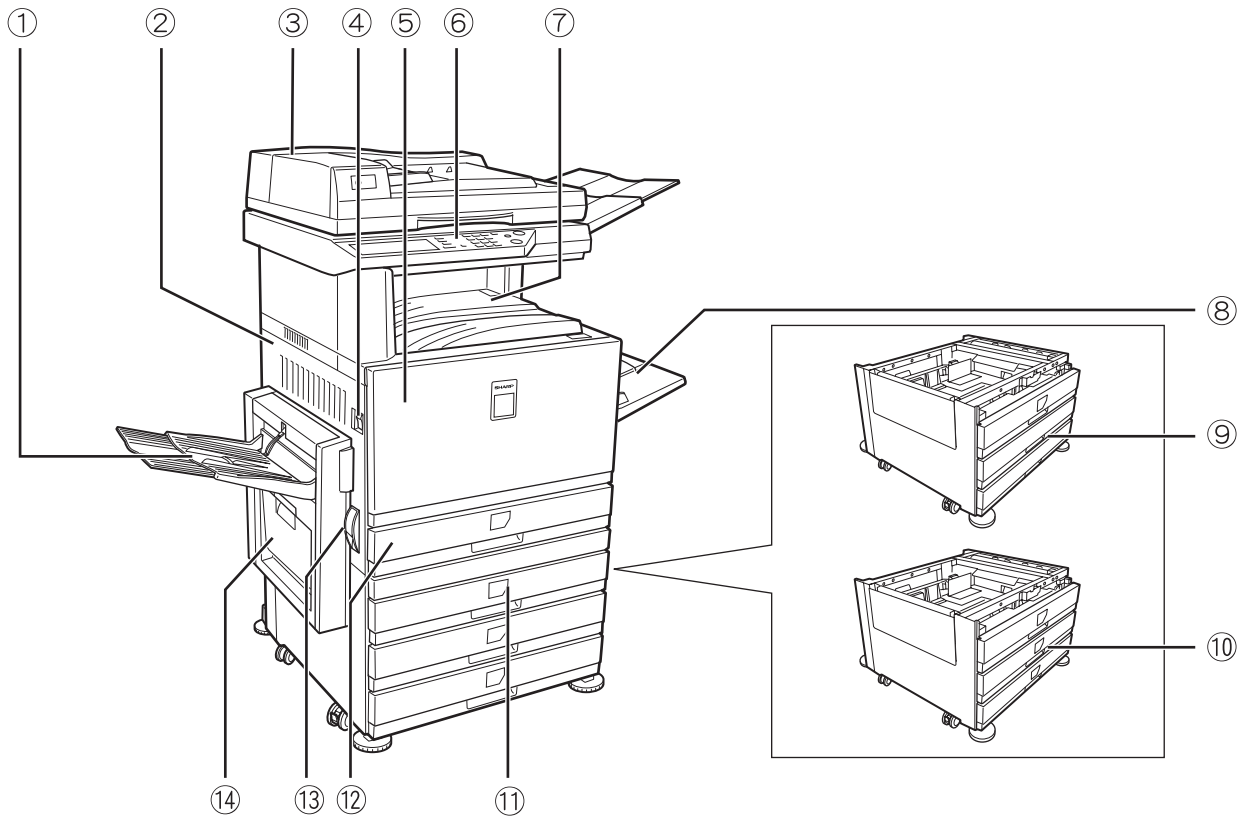

① **Left tray (See page 5-5)**

Finished sheets are deposited here.

② **Left side cover**

Open this cover when a paper misfeed occurs in the fusing unit or the transfer unit.

③ **Reversing automatic document feeder (See page 4-2)**

This automatically feeds originals to be scanned. The feeder can turn the original over and scan the back side as well as the front side for support of two-sided originals.

④ **Power switch**

Press to turn power on and off.

⑤ **Front cover**

Open to replace toner cartridge.

⑥ **Operation panel**

⑦ **Center tray (See page 5-5)**

Finished sheets are deposited here.

⑧ **Bypass tray**

Special papers (including transparency film) and copy paper can be fed from the bypass tray.

⑨ **Stand/1 x 500 sheet paper drawer* (See page 2-7)**

⑩ **Stand/3 x 500 sheet paper drawer* (See page 2-7)**

⑪ **Duplex module/2 x 500 sheet paper drawer* (See page 2-8)**

⑫ **Paper tray**

Each tray can hold approximately 500 sheets of the recommended paper for color (21 lbs. or 80 g/m²), or approximately 500 sheets of SHARP standard paper (21 lbs. or 80 g/m²).

⑬ **Left side cover release**

Push this release up to open the left side cover.

⑭ **Duplex bypass/inverter unit and exit tray* (See page 1-6)**

* ⑨, ⑩, ⑪ and ⑭ are peripheral devices. For a description of these devices, see page 1-6.

Interior

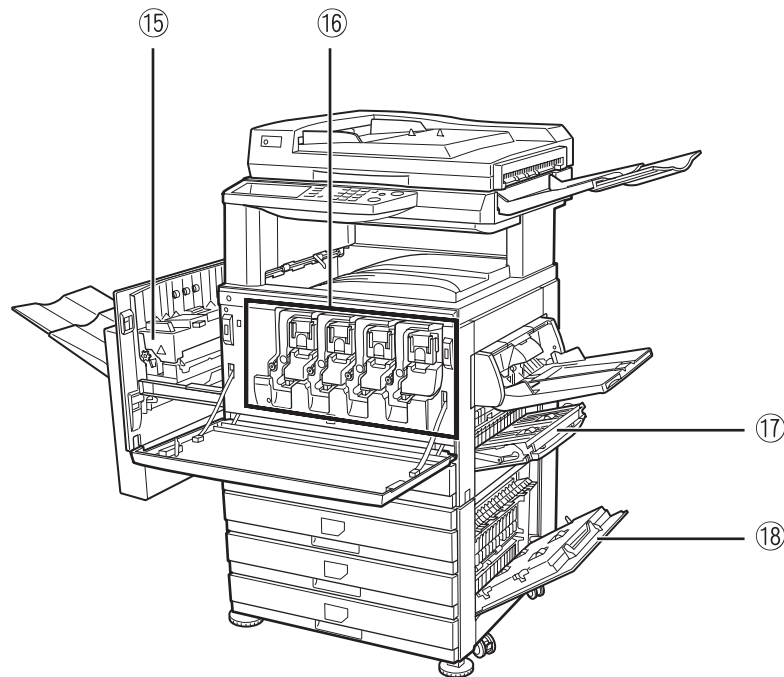

1

15 Fusing unit

Toner images are fused here.

CAUTION

The fusing unit is hot. Take care in removing misfed paper.

16 Toner cartridge

The toner cartridge must be replaced when indicated on the operation panel. (See page 2-15)

17 Right side cover

Open when a misfeed has occurred in the paper feed area.

18 Right cover of paper drawer

Open this cover to remove paper misfed in the paper drawer.

Part names and functions of peripheral devices

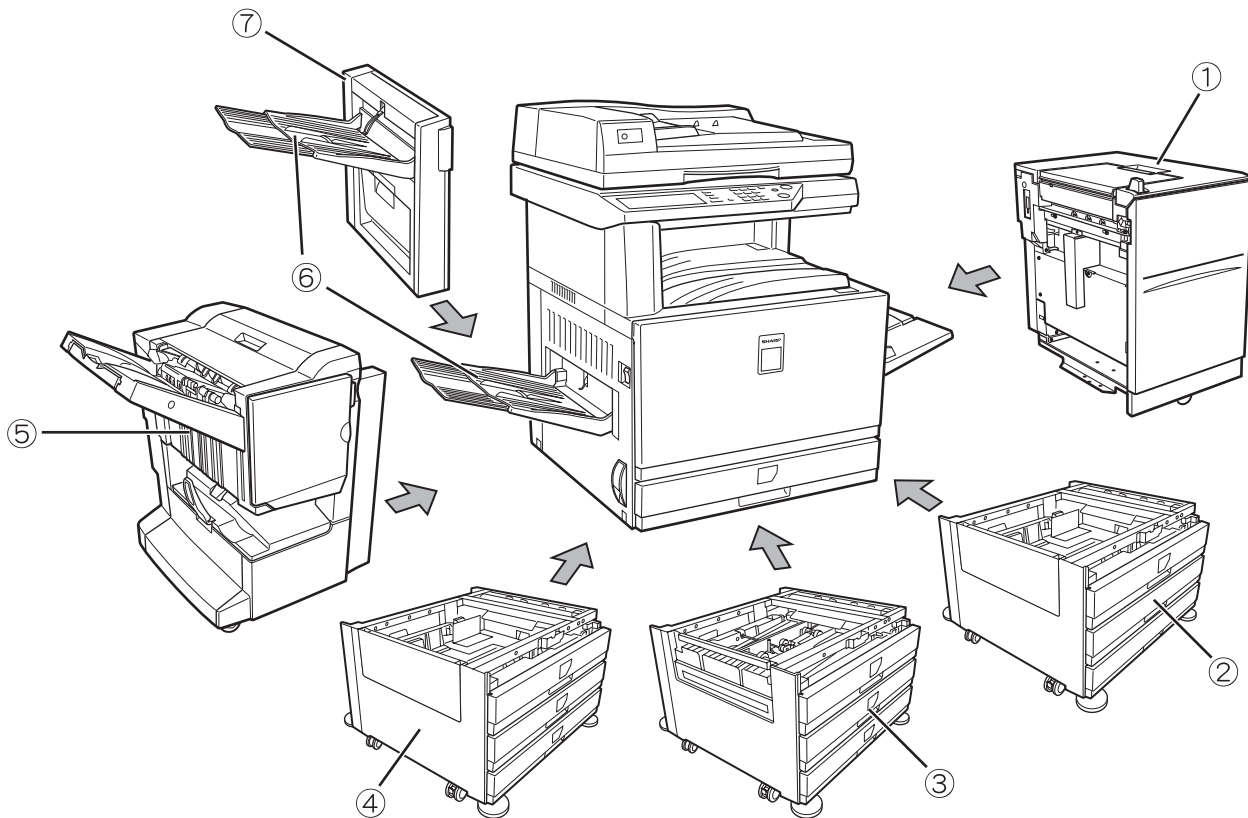

① **Large Capacity tray (AR-LC8)**

The large capacity tray provides the added convenience of having 3,500 sheets of 8-1/2" x 11" or A4 paper (21 lbs. or 80 g/m²) available.

② **Stand/1 x 500 sheet paper drawer (AR-D17N)**

This stand has one paper tray. It can hold approximately 500 sheets of the recommended paper for color (21 lbs. or 80 g/m²), or approximately 500 sheets of SHARP standard paper (21 lbs. or 80 g/m²).

③ **Duplex module/2 x 500 sheet paper drawer (AR-D19N)**

This stand includes a module for automatic two-sided printing and two paper trays. The two trays can hold approximately 500 sheets of the recommended paper for color (21 lbs. or 80 g/m²), or approximately 500 sheets of SHARP standard paper (21 lbs. or 80 g/m²). To perform two-sided printing, a duplex bypass/inverter unit (AR-RB1) is required.

④ **Stand/3 x 500 sheet paper drawer (AR-D18N)**

This stand has three paper trays. Each tray can hold approximately 500 sheets of the recommended paper for color (21 lbs. or 80 g/m²), or approximately 500 sheets of SHARP standard paper (21 lbs. or 80 g/m²).

⑤ **Saddle stitch finisher (AR-F13)**

The finisher can deliver sets saddle stitched and folded at the paper centerline to form a pamphlet, edge stapled in three different modes or unstapled. For two-hole or three-hole output, a hole punch module must be installed.

⑥ **Exit tray (AR-TE3)**

The exit tray is installed on the output outlet of the machine or the duplex tray / inverter unit.

⑦ **Duplex bypass/inverter unit (AR-RB1)**

This module is required to automatically turn paper over within the machine for automatic two-sided printing.

■ Other optional equipment

● PS3 expansion kit (AR-PK4)

This kit provides compatibility of PostScript level 3 to the printer.

● Facsimile expansion kit (AR-FX10)

This kit must be installed to use the fax function.

● Fax memory (8 MB) (AR-MM9)

This adds memory for use by the fax function.

● 256 MB optional memory (AR-SM5)

This adds memory that is used for the copy function, printer function, and scanner function.

1

■ Face-up and face-down output

After printing, the paper is delivered to the exit tray. This product has two exit trays (center tray and left tray). The paper specifications (page 8-3) and output conditions differ for each tray; however, if the paper and output conditions are such that the paper can be delivered to either tray, you can select the tray to which the paper will go.

- Paper exits to the center tray face-down only.
- Paper exits to the left tray face-up only. However, if a duplex bypass/inverter unit has been installed, face-down output is also possible. In this case, face-up or face-down output is automatically selected according to the paper and output conditions (it is not possible to manually select face-up or face-down.)

Operation panel

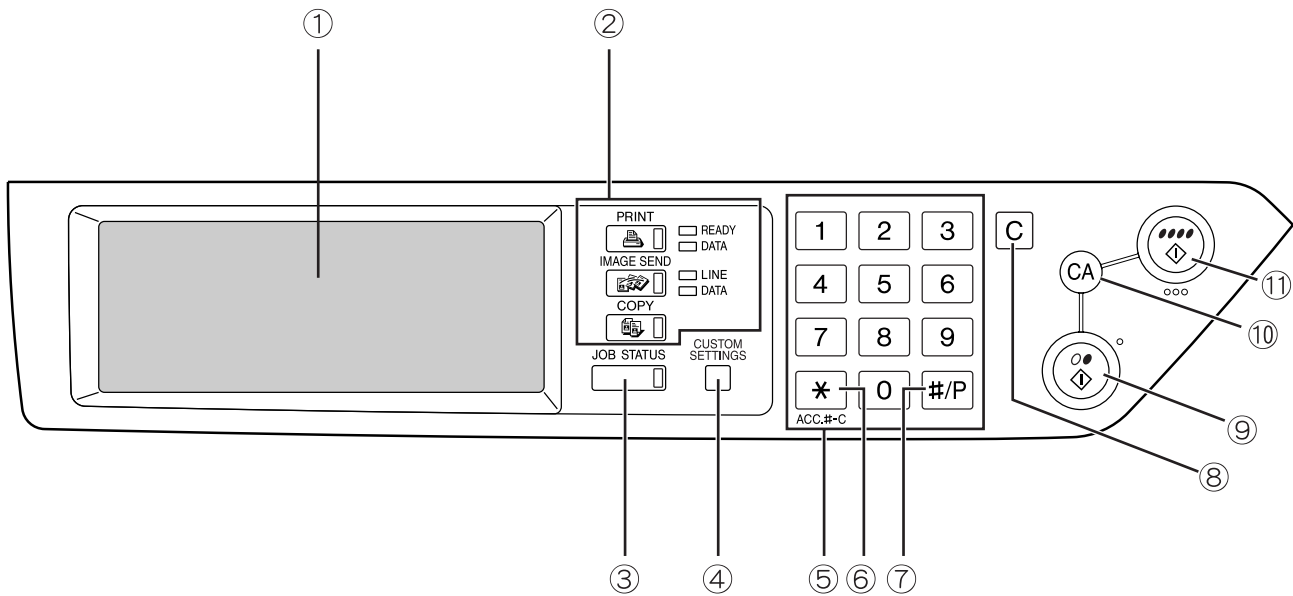

① Touch panel

The machine status, messages and touch keys are displayed on the panel. When using the touch panel, first change the display to the mode that you wish to use: printer mode, copy mode, network scanner mode, or fax mode*. For details see the next page.

② Mode select keys and indicators

Use to change modes and the corresponding display on the touch panel.

[PRINT] key/READY indicator/DATA indicator

Press to enter the printer mode.

READY indicator

Print data can be received when this indicator is lit.

DATA indicator

Lights up or blinks when print data is being received. Also lights up or blinks when printing is being performed.

[IMAGE SEND] key/LINE indicator/DATA indicator

Press this key to switch the display between network scanner mode and fax mode*. (See the operation manuals for network scanner and fax.)

[COPY] key

Press to select the copy mode.

③ [JOB STATUS] key

Press to display the current job status. (See page 1-10.)

④ [CUSTOM SETTINGS] key

Use to adjust the contrast of the touch panel or to set key operator programs. (See page 2-13.)

⑤ Numeric keys

Use to enter number values for various settings.

⑥ [*] key ([ACC.#-C] key)

This is used when the copy, network scan, and fax* functions are used.

⑦ [#/P] key

This is used as a program key when using the copy function, and to dial when using the fax function*.

⑧ [C] key

This key is used in copy mode, network scanner mode, and fax mode*.

⑨ [BLACK COPY START (O●)] key

This is used to make black and white copies and to scan a black and white original when the network scan function is used. This is also used to scan an original to be faxed using the fax function*.

⑩ [CA] key

This key is used in copy mode, network scanner mode, and fax mode*.

⑪ [COLOR COPY START (●●●●)] key

This is used to make full-color or single-color copies and to scan a color original when the network scanner function is used.

* When the fax option is installed.

Touch panel

Using the touch panel

[Example 1]

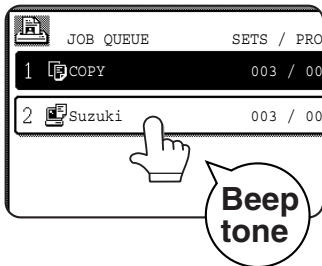

Items on the touch panel are easily selectable by touching the key associated with the item with a finger. Selection of an item will be accompanied with a beep tone to confirm the item was selected. Also, the key area for the item will be highlighted for visual confirmation.

[Example 2]

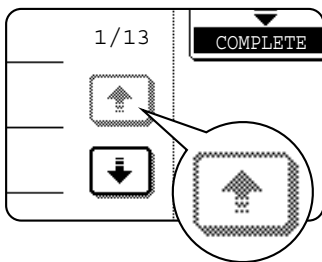

Keys which are grayed out on any screen are not selectable. If a grayed out key is touched, a double beep will be sounded.

The confirmation beeps can be disabled by a key operator program. (See page 10 of the key operator's guide.)

The touch panel screens shown in this manual are printed images, and may appear different from the actual screens.

Selection of function

[Example 1]

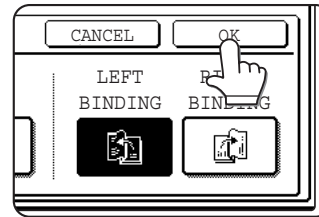

Items which are highlighted at the time a screen appears are already selected and will be registered to function if the [OK] key is touched.

[Example 2]

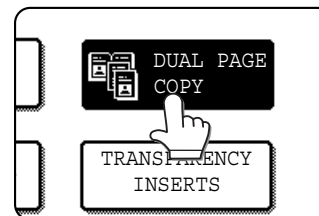

When the machine is used in the copy mode, the functions shown in the table below can only be set or canceled on the special feature screen by alternate touches of the function keys on the panel.

Copier feature

- Dual page copy
- Centering
- Transparency inserts
- Mirror image
- 11"x17" (A3) Full-bleed
- B/W Reverse

[Example 3]

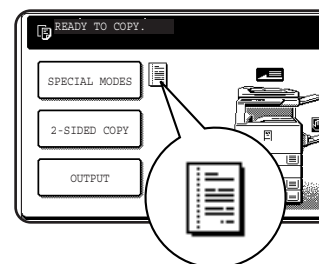

When the machine is used in the copy mode and a special feature is selected, a corresponding icon representing the feature will appear on the touch key and on the main screen of the mode selected. If this icon is touched, the setting screen of the function (or a menu screen) will appear, allowing the settings to be checked or adjusted and the function to be canceled easily.

Job status screen (common to print, copy, network scan and fax)

This screen is displayed when the [JOB STATUS] key on the operation panel is pressed.

A job list showing the current job at the top of the job queue or a list showing completed jobs can be displayed. The contents of jobs can be viewed or jobs can be deleted from the queue. (The screen below is an example and differs from actual screens.)

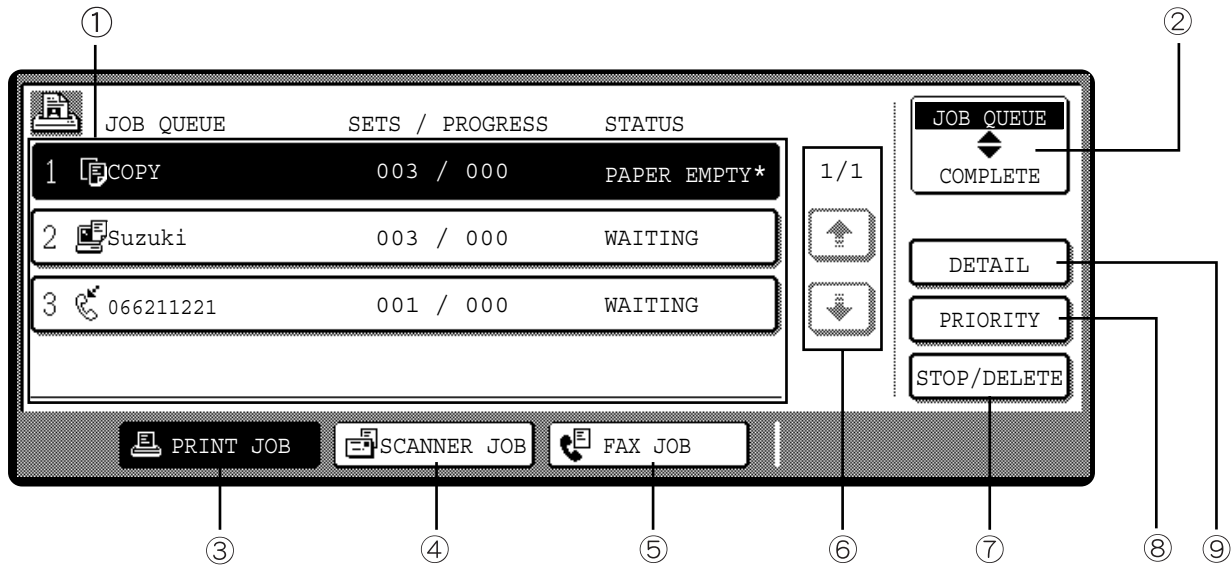

① Job list

This shows the current job and the jobs waiting to be run. The icons to the left of the jobs in the queue show the job mode.

- Copy mode Printer mode
- Network scanner mode
- Fax send job Fax reception job

The displayed jobs in the job list are themselves operation keys. To cancel printing or to give a job the highest print priority, touch the relevant job key to select the job and execute the desired operation using the keys described in 5 and 6.

*** "PAPER EMPTY" in the job status display**

When a job status display indicates "PAPER EMPTY", the specified paper size for the job is not loaded in any of the trays.

When the [DETAIL] key appears, the key of a job in the job queue can be touched followed by the [DETAIL] key to change the paper size selection to a different paper size (only in printer mode).

② Mode select key

This only appears in the job status screen of fax mode. The key is used to switch the job list display between "JOB QUEUE" and "COMPLETE".

"JOB QUEUE": Shows stored jobs and the job in progress.

"COMPLETE" : Shows finished jobs.

③ [PRINT JOB] key

Use to display the print job list for printer, copy and fax mode.

④ [SCANNER JOB] key

This displays a list of jobs that only used the network scanner function.

⑤ [FAX JOB] key

This displays the transmission/reception status and finished jobs of fax mode when the fax option is installed.

⑥ Display switching keys

Use to switch the page of the displayed job list.

⑦ [STOP/DELETE] key

Use to cancel or delete the current job or delete the selected reserved job. Note that a fax print job cannot be canceled or deleted.

⑧ [PRIORITY] key

This only appears in the job status screen of fax mode. Touch this key to give priority to a job that has been selected in the job queue.

⑨ [DETAIL] key

The key is only effective for computer print jobs and only appears in the job status screen of the printer mode. It is used to display detailed information of a selected print job and to change the paper size for the print job.

AUDITING MODE

When the account counter function is turned on, a count is kept of the number of copy sheets used by each account (maximum of 200 accounts). The counts can be displayed and totaled as needed.

The key operator programs can be used to enable auditing mode separately for copy mode, fax mode, network scanner mode and printer mode. (Page 6 of key operator's guide)

Using the machine when the auditing mode is enabled

The procedure for using the machine for copying functions when the Auditing Mode has been enabled for the copier functions is explained below.

1

NOTES

- When the account counter is turned on for fax or network scanner functions, a message will appear prompting you to enter your account number each time the touch panel is changed to the main screen of the function. Enter your account number as explained below and then proceed with the job.
- When the account counter is turned on for the printer function, you must enter your account number in the setting screen of the printer driver on your computer in order to print.

When the account counter is turned on, the following messages appear on the touch panel. There are two types of prompts, depending on whether the account counter was turned on for both the color copy and the black and white copy modes, or only for color copy mode.

- Account counter enabled for both the color copy and the black and white copy modes

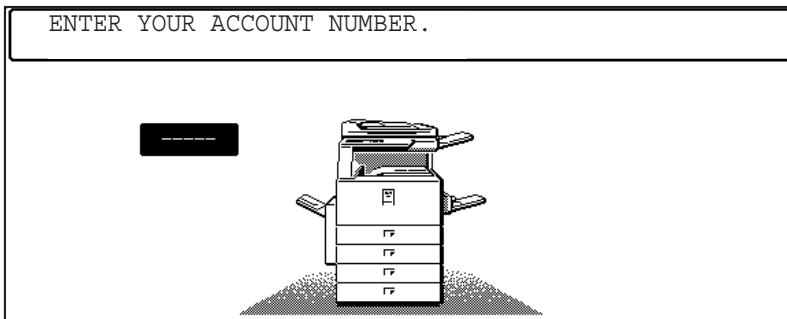

- The account counter is enabled only for the color copy mode

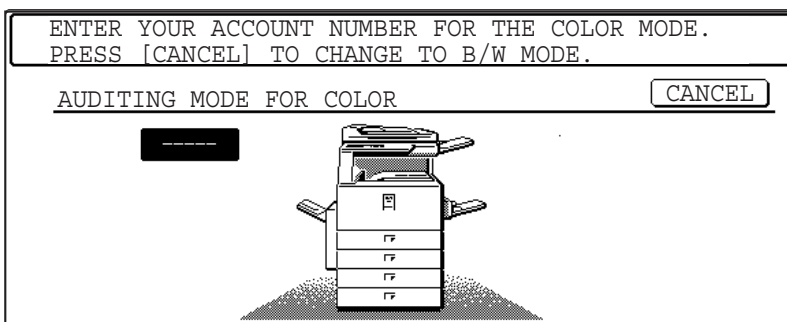

When the [✖] key ([ACC.#-C] key) or the [COLOR COPY START] key is pressed, the message at left appears.

In this case, enter your 5-digit account number as explained on the next page to gain access to the copier functions.

1 Enter your account number (5 digits) with the numeric keys.

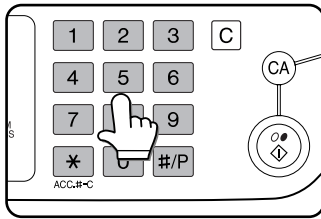

As you enter your account number, the hyphens (—) change to asterisks (*). If you enter an incorrect digit, press the [C] key and re-enter the correct digit. When a correct account number is entered, the following message will appear.

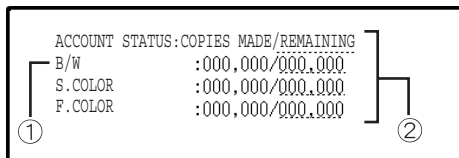

- ① This does not appear if the account counter has only been set for color copy mode.
- ② If a limit has been set by key operator program for the number of copies that can be made by the account, the remaining number that can be made is displayed.

This message appears for several seconds and then changes to the following message.



NOTE

If "Account number security" is turned on in the key operator programs, the following message will appear in the event that an incorrect account number is entered three times in a row. (Page 8 of the key operator's guide)



While this message appears (for about one minute), no other operations can be performed.

2 Follow the appropriate steps to perform the copy job.

When copying is begun, the following message will appear.



In the case of interrupt copying (page 6-27), the following message will appear.



3 When the copy job is finished, press the [*] key ([ACC.#-C] key)

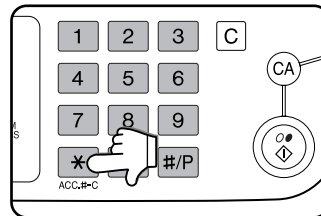

CHAPTER 2

MANAGING THE MACHINE

This chapter explains how to load paper, replace the toner cartridge, and remove paper misfeeds. It also contains information about supplies.

| | Page |
|---|------|
| LOADING PAPER..... | 2-2 |
| • Loading paper in paper tray 1 | 2-2 |
| • Changing the paper size in paper tray 1 | 2-2 |
| • Loading paper in the bypass tray | 2-4 |
| • Loading paper in the stand/1 x 500 sheet paper drawer/stand/3 x 500 sheet paper drawer..... | 2-7 |
| • Specifications (stand/1 x 500 sheet paper drawer/stand/3 x 500 sheet paper drawer) | 2-7 |
| • Loading paper in the duplex module/2 x 500 sheet paper drawer | 2-8 |
| • Specifications (duplex module/2 x 500 sheet paper drawer) | 2-8 |
| • Specifications of paper trays | 2-9 |
| • Setting the paper type (except the bypass tray)..... | 2-11 |
| • Setting the paper size when an extra size is loaded | 2-11 |
| • Setting the paper type and paper size in the bypass tray | 2-12 |
| CUSTOM SETTINGS | 2-13 |
| • Operation procedure common to all custom settings..... | 2-13 |
| • About the settings | 2-14 |
| REPLACING THE TONER CARTRIDGES | 2-15 |
| STORAGE OF SUPPLIES | 2-17 |
| MISFEED REMOVAL | 2-18 |
| • Misfeed removal guidance | 2-18 |
| • Misfeed in the paper feed area | 2-19 |
| • Misfeed in the transport area, fusing area, and exit area..... | 2-20 |
| • Misfeed in the stand/1 x 500 sheet paper drawer | 2-21 |
| • Misfeed in the stand/3 x 500 sheet paper drawer | 2-21 |
| • Misfeed in the duplex bypass/inverter unit and duplex module/2 x 500 sheet paper drawer | 2-22 |
| TROUBLESHOOTING | 2-24 |

LOADING PAPER

The message "ADD PAPER" or "OPEN TRAY AND ADD PAPER" will appear when paper runs out during operation. Follow the procedure below to load paper.

NOTES

- Do not use curled or folded paper. Doing so may cause a misfeed.
- For best results use paper supplied by SHARP. (See pages 2-9, 2-17.)
- When you change the paper type and size in paper tray 1, you must change the paper type and size settings as explained in "Setting the paper type" (page 2-11).
- Do not place heavy objects or press hard on any tray which is pulled out.

Loading paper in paper tray 1

1 Pull out paper tray 1.

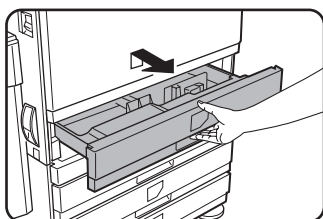

Gently pull the tray out until it stops.

2 Load paper into the tray.

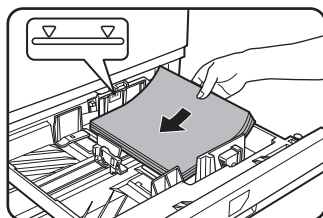

Load a stack of paper no higher than the indicator line (about 500 sheets of the recommended paper for color (21 lbs. or 80 g/m²), or approximately 500 sheets of SHARP standard paper (21 lbs. or 80 g/m²)).

3 Gently push tray 1 into the machine.

Push the tray firmly all the way into the machine.

4 Set the paper type.

If you change the paper type, be sure to set the paper type refer to "Setting the paper type" (page 2-11).

NOTE

If you load a different size of the same type of paper, you only need to change the position of the size slide (see step 2 below); you do not need to change the paper type.

5 Loading paper in paper tray 1 is now complete.

Changing the paper size in paper tray 1

The following paper size settings are available for paper tray1: 11" x 17" to 8-1/2" x 5-1/2" (A3 to A5), and "EXTRA"*1. Use the following procedure to change the size as needed.

*1 This is limited to square or rectangular paper, 11" x 17" to 8-1/2" x 5-1/2" (A3 to A5) size.

1 Pull out paper tray 1.

If paper remains in the tray, remove it.

2 Adjust the paper size slide to the paper size.

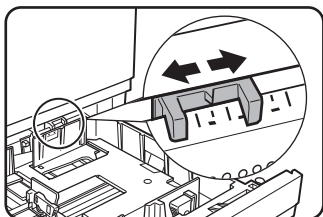

Move the paper size slide right or left to indicate the paper size being loaded.

If a special size paper is loaded in the paper tray, set the size slide to

"EXTRA" to inform the machine that a special size paper has been loaded. (When AB-based size paper is loaded, move the size slide to "EXTRA".)

Note that setting the size slide to "EXTRA" only informs the machine that a special size of paper has been loaded; it does not inform the machine of the specific size. If you wish to inform the machine of the specific size, follow the steps in "Setting the paper size when an extra size is loaded" (page 2-11). (If you do not set a size, part or all of the image may not print.)

3 Adjust the guide plates A and B by squeezing their lock levers and sliding them to the paper size to be loaded.

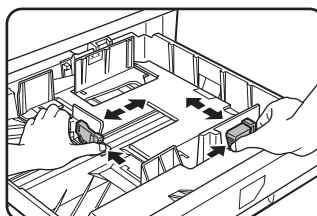

The guide plates A and B are slidable. Adjust them to the paper size to be loaded while squeezing their lock levers.

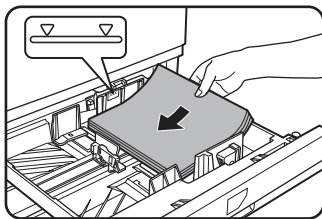
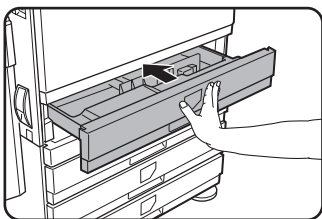
4 Load paper into the tray.**5** Gently push tray 1 into the machine.

Push the tray firmly all the way into the machine.

6 Set the paper type of the paper that was loaded in the 1st tray.

If you loaded a different type of paper from the previous paper, be sure to set the new paper type as explained in "Setting the paper type" (page 2-11).

7 Changing paper size in paper tray 1 is now complete.**2****NOTE**

If the size slide position (step 2 of page 2-2) is not set correctly after changing the paper size, or if the paper type (page 2-11) is not set correctly, incorrect paper selection or paper misfeeding may occur.

Loading paper in the bypass tray

The bypass tray can be used to feed the same paper specified for paper tray 1 or for special papers. For paper types that can be used in the bypass tray, see the specifications for the bypass tray in the paper tray specifications (page 2-9).

Up to 250 sheets of SHARP standard paper or up to 100 postcards can be set in the bypass tray.

NOTES

- After loading the paper in the bypass tray, be sure to set the paper type and size (step 4) if these were changed.
- Do not use inkjet paper. This may cause misfeeds in the fusing unit.

1 Open the bypass tray.

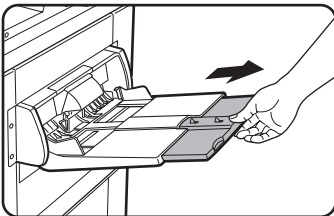
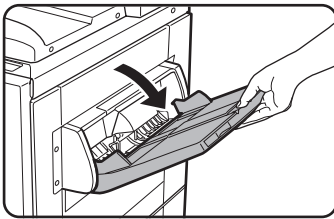

When loading paper that will extend past the end of the tray, pull out the tray extension to support the paper and to allow the paper sensors to properly sense the paper size.

Be sure to pull the tray extension all the way out. If the tray extension is not pulled all the way out, the size of the paper loaded in the bypass tray may not display correctly.

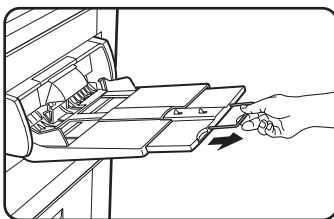

To support papers that extend past the tray extension, pull out the wire extension.

2 Set the bypass tray guides to the width of the copy paper.

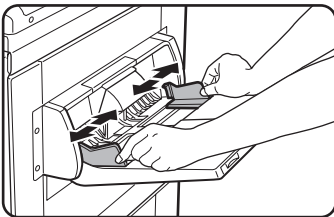

3 Insert the copy paper all the way into the bypass tray. (Do not force the paper in.)

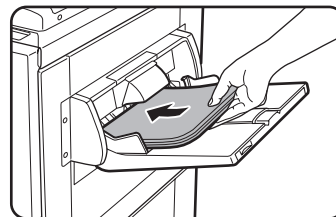

Place the copy paper face up. If the bypass tray guides are set wider than the copy paper, the inside of the machine may become soiled, resulting in

smudges on succeeding copies. Special purpose papers other than SHARP recommended transparency film must be fed individually. Multiple sheets of SHARP recommended transparency film can be loaded in the bypass tray.

4 Set the type and size of the paper loaded in the bypass tray.

If you loaded a different type of paper from the previous paper, be sure to set the new paper type as explained in "Setting the paper type and paper size in the bypass tray" (page 2-12). If you loaded a special size of paper in the bypass tray, set the paper size as explained in "Setting the paper type and paper size in the bypass tray" (page 2-12). (If you do not set a size, part or all of the image may not print.)

5 This completes the procedure for loading paper in the bypass tray.

NOTE

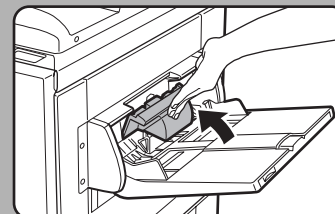

When loading paper in the bypass tray or closing the tray, close the paper cover as shown.

NOTES

- Be sure to load 5-1/2" x 8-1/2" paper, A6 paper, A5 paper, and postcards as shown in the diagram below.

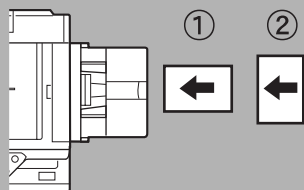

- ① A6 paper, post cards.
- ② 5-1/2" x 8-1/2" paper, A5 paper.

- When loading plain paper other than paper recommended for color, SHARP standard paper, special media other than postcards, SHARP-recommended transparency film, or paper to be printed on the back, the paper must be loaded one sheet at a time. Loading more than one sheet at a time will cause misfeeds.
- Before loading heavy paper, straighten any curling in the paper.
- When adding paper, remove any paper remaining in the tray, combine it with the paper to be added, and reload as a single stack.
- Do not use paper that has already been printed on by a plain paper fax machine or a laser printer. This may cause printed images to become dirty.
- When printing on transparency film, be sure to remove each sheet as it exits the machine. Allowing sheets to stack in the output tray may cause curling.
- Use only SHARP-recommended transparency film. Insert the film so that the rounded corner is on the left for horizontal loading, or on the right for vertical loading.

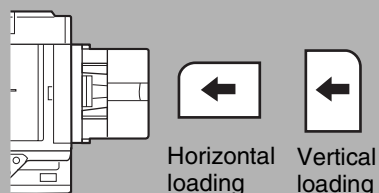

- When loading multiple sheets of transparency film in the bypass tray, fan the sheets several times before loading.

■ Setting envelopes or postcards

When setting envelopes or postcards in the bypass tray, set them in the orientation shown below.

Loading postcards

Insert the postcard with the side to be printed on facing up. The postcard should be oriented as shown in the diagram.

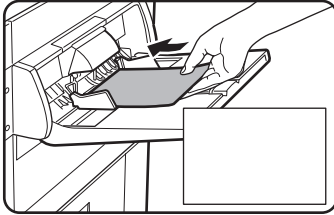

Loading envelopes

Only the front side of envelopes can be printed. Insert the envelope with the front side facing up.

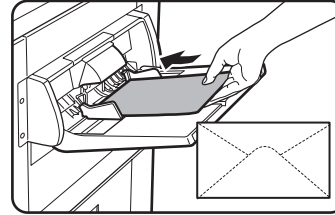

Printing onto envelopes or postcards

- Attempting to print onto both sides of envelopes or postcards may result in misfeeds or poor prints.
- Do not use pre-printed envelopes.
- Before inserting a postcard or envelope, straighten any curled edges. Curled edges may cause creases, color deviations, misfeeds, and poor quality images.

Printing onto envelopes

- Attempting to print on envelopes that have metal clasps, plastic snaps, string closures, windows, linings, self-adhesive patches or synthetic materials may cause misfeeds, inadequate toner adherence or other trouble.
- Envelopes with embossed surfaces may cause the prints to become smudged.
- Use only envelopes which are flat and crisply folded. Curled or poorly formed envelopes may be poorly printed or may cause misfeeds.
- Print quality is not guaranteed in the area 13/32" or 10 mm from the edges of the envelope.
- Print quality is not guaranteed on parts of envelopes where there is a large step-like change of thickness, such as on three-layer or four-layer envelopes.
- Print quality is not guaranteed on envelopes having peel off flaps for sealing the envelopes.

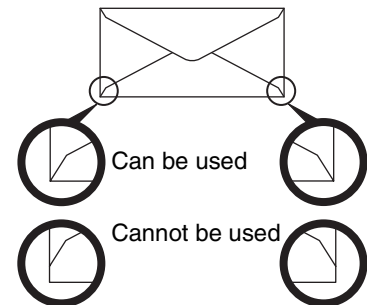

Fusing unit pressure adjusting levers

In some cases damage to the envelopes, color deviations, or smudging may occur even if envelopes within the specifications are used. This problem may be reduced by shifting the fusing unit pressure adjusting levers from their normal pressure position to the lower pressure position. Follow the procedure on the next page. (2-7)

NOTE

Be sure to return the lever to the normal position when you have finished feeding envelopes. If not, inadequate toner adherence, paper misfeeds or other trouble may occur.

1 Unlatch the duplex bypass/inverter unit and slide it to the left.

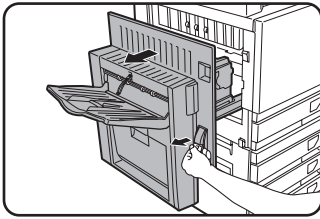

Unlatch the unit and gently move it away from the machine. If the machine is not equipped with a duplex bypass/inverter unit, open the side cover similarly.

3 Gently close the duplex bypass/inverter unit.

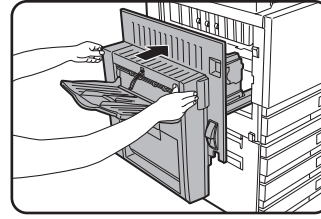

If the machine is not equipped with a duplex bypass/inverter unit, close the side cover.

2 Lower the two fusing unit pressure adjusting levers marked A and B in the illustration.

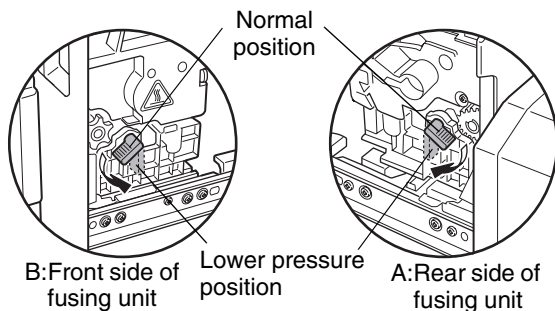
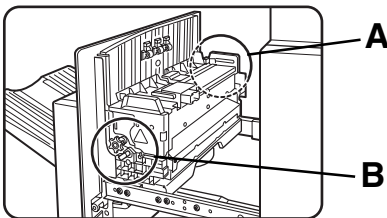

Loading paper in the stand/1 x 500 sheet paper drawer/stand/3 x 500 sheet paper drawer

Upper tray / middle tray / lower tray*

Up to 500 sheets of paper recommended for color or SHARP recommended plain paper can be loaded in these trays. The method of loading paper is the same as for paper tray 1 in the main unit (see the explanation on page 2-2).

* The stand/1 x 500 sheet paper drawer only has the upper tray.

NOTE

If the size of paper being loaded is different from the previous size, or is an extra size, or if the paper type is different from the previous type, you must change the paper tray settings in the custom settings. Change the settings as explained in "Setting the paper type" and "Setting the paper size when an extra size is loaded" on page 2-11.

Specifications (stand/1 x 500 sheet paper drawer/stand/3 x 500 sheet paper drawer)

| | | |
|-------------------|--|--|
| Name | Stand/1 x 500 sheet paper drawer (AR-D17N) | Stand/3 x 500 sheet paper drawer (AR-D18N) |
| Paper size/weight | 11" x 17", 8-1/2" x 14", 8-1/2" x 13", 8-1/2" x 11", 8-1/2" x 11"R, 7-1/4" x 10-1/2"R, 5-1/2" x 8-1/2", Extra. (A3, B4, A4, A4R, B5, B5R, A5) / 17 to 28 lbs. or 64 to 105 g/m ² | |
| Paper capacity | Paper recommended for color (21 lbs. or 80 g/m ²): 500 sheets; SHARP standard paper (21 lbs. or 80 g/m ²): 500 sheets | |
| Power supply | Supplied from the main unit | |
| Dimensions | 23-5/8" (W) x 25-9/32" (D) x 15-7/8" (H) (600 mm (W) x 642 mm (D) x 403 mm (H)) (not including the adjuster) | |
| Weight | Approximately 49.6 lbs. or 22.5 kg | Approximately 65.0 lbs. or 29.5 kg |

Specifications are subject to change for improvement without notice.

Loading paper in the duplex module/2 x 500 sheet paper drawer

Upper tray:

The upper tray contains a duplex module that automatically turns print paper over for automatic two-sided printing.

Middle and lower paper trays:

The middle and lower trays are paper trays.

Up to 500 sheets of paper recommended for color or SHARP recommended plain paper can be loaded in these trays. The method of loading paper is the same as for paper tray 1 in the main unit. See the explanation on page 2-2.

NOTE

If the size of paper being loaded is different from the previous size, or is an extra size, or if the paper type is different from the previous type, you must change the paper tray settings in the custom settings. Change the settings as explained in "Setting the paper type" and "Setting the paper size when an extra size is loaded" on page 2-11.

Specifications (duplex module/2 x 500 sheet paper drawer)

| | |
|-----------------------|--|
| Name | Duplex module/2 x 500 sheet paper drawer (AR-D19N) |
| Paper size/weight | 11" x 17", 8-1/2" x 14", 8-1/2" x 13", 8-1/2" x 11", 8-1/2" x 11"R, 7-1/4" x 10-1/2"R, 5-1/2" x 8-1/2", Extra. (A3, B4, A4, A4R, B5, B5R, A5) / 17 to 28 lbs. or 64 to 105 g/m ² |
| Paper capacity | Paper recommended for color (21 lbs. or 80 g/m ²): 500 sheets; SHARP standard paper (21 lbs. or 80 g/m ²): 500 sheets |
| Power supply | Supplied from the main unit |
| Dimensions | 23-5/8" (W) x 25-9/32" (D) x 15-7/8" (H) (600 mm (W) x 642 mm (D) x 403 mm (H)) (not including the adjuster) |
| Weight | Approximately 68.3 lbs. or 31 kg |
| Duplex module | |
| Size of plain paper | 11" x 17", 8-1/2" x 14", 8-1/2" x 13", 8-1/2" x 11", 8-1/2" x 11"R, 7-1/4" x 10-1/2"R, 5-1/2" x 8-1/2", A3, B4, A4, A4R, B5, B5R, A5 |
| Weight of plain paper | 17 to 54 lbs. or 64 to 200 g/m ² |
| Number of sheets | One sheet (single pass type) |

Specifications are subject to change for improvement without notice.

Specifications of paper trays

The specifications for the types and sizes of paper that can be loaded in the paper trays are shown below.

| | Paper tray type | Tray No. (tray name) | Applicable paper types | Applicable paper sizes | Remarks | | |
|---|--|--|--|---|---|---|---|
| A | Paper tray 1 | Tray 1 | Paper recommended for color | 11"x17", 8-1/2"x14", 8-1/2"x13", 8-1/2"x11", 8-1/2"x11"R, 5-1/2"x8-1/2", 7-1/4"x10-1/2"R, Extra. (A3, B4, A4, A4R, B5, B5R, A5) | See "STORAGE OF SUPPLIES" on page 2-17 | | |
| | | | Plain paper | 11"x17", 8-1/2"x14", 8-1/2"x13", 8-1/2"x11", 8-1/2"x11"R, 5-1/2"x8-1/2", 7-1/4"x10-1/2"R, Extra. (A3, B4, A4, A4R, B5, B5R, A5) | See "More information on plain paper" on the next page | | |
| B | Bypass tray | Bypass tray | Same as paper types and sizes in row A * Paper size 12" x 18" (A3W) and A6R can also be used in the bypass tray | | | See "More information on special media that can be used" on the next page | |
| | | | Special paper (Refer to the next page for applicable special papers.) | Heavy paper | Heavy paper 1 | | 5-1/2"x8-1/2" - 12"x18" (A6R - A3W), Special (paper weight: 28 to 54 lbs. (106 to 200 g/m ²)), Postcard |
| | | | | | Heavy paper 2 | | 5-1/2"x8-1/2" - 12"x18" (A6R - A3W), Special (paper weight: 54 to 80 lbs. (201 to 300 g/m ²)) |
| | | | | Transparency film | Transparency film | | |
| | Envelopes | ●Standard-size envelopes that can be used :COM10,Monarch,DL,C5 | | | | | |
| C | Stand/1 x 500 sheet paper drawer | Tray 2 | Same as paper types and sizes in row A | | | | |
| D | Stand/3 x 500 sheet paper drawer | Upper | | | | Tray 2 | |
| | | Middle | | | | Tray 3 | |
| | | Lower | Tray 4 | | | | |
| E | Duplex module/2 x 500 sheet paper drawer | Upper | Duplex | Duplex module (See page 2-8 for paper sizes and weights that can be used.) | | | |
| | | Middle | Tray 2 | Same as paper types and sizes in row A | | | |
| | | Lower | Tray 3 | | | | |
| F | Large Capacity tray | Tray 4* ¹ or Tray 5* ² | Same as paper types in row A | 8-1/2"x11" (A4) | See the specifications in "LARGE CAPACITY TRAY" on page 3-15, and "More information on plain paper" on the next page. | | |

*1 When the Duplex module/2 x 500 sheet paper drawer is installed.

*2 When the Stand/3 x 500 sheet paper drawer is installed.

More information on plain paper

The following restrictions apply to plain paper. Be sure to load the paper correctly. Incorrect loading may result in skewed feeding or misfeeds.

| | | Paper in inch system | Paper in AB system |
|---|---|--|--------------------|
| | | 5-1/2"x8-1/2" - 12"x18"* | A6R - A3W* |
| Plain paper | SHARP standard paper | 21 lbs. | 80g/m ² |
| | Restrictions on paper other than SHARP standard paper | 17 to 28 lbs. or 64 to 105g/m ² | |
| Recycled, colored, pre-punched, pre-printed and letterhead papers must conform to the same conditions as above. | | | |

* In the large capacity tray, only 8-1/2" x 11" size paper can be used when using inch sizes, and only A4 can be used when using AB sizes.

More information on special media that can be used

The following restrictions apply to special media. The use of incorrect media may result in fusing problems (weak adhesion of toner to paper or toner smudging when rubbed), skewed feeding, misfeeds, or other failures.

| | | Type | Remarks |
|---------------|-------------------|---------------|---|
| Special paper | Heavy paper | heavy paper 1 | For paper sizes from 5-1/2" x 8-1/2" to 12" x 18" (A6R to A3W), paper weights from 28 to 54 lbs. (106 to 200 g/m²) can be used. ● Postcards can be used. Do not use folded postcards, picture postcards, or postcards with a coated front. These may cause misfeeds or a dirty printed image. |
| | | heavy paper 2 | For paper sizes from 5-1/2" x 8-1/2" to 12" x 18" (A6R to A3W), paper weights from 54 to 80 lbs. (201 to 300 g/m²) can be used. |
| | Transparency film | | Use SHARP recommended transparencies. |
| | Envelopes | | Applicable standard envelopes: COM-10, Monarch, DL, C5 Envelopes can only be fed from the Bypass tray. Applicable paper stock weight for envelopes is 20 to 23 lbs. or 75 to 90 g/m ² |

- Special paper such as heavy paper 2, transparency film, and envelopes cannot be output to the center tray.
- Paper that cannot be output to the center tray is output face-up to the left tray.

Paper that can be used for automatic two-sided printing

Paper used for automatic two-sided printing (paper that can be fed through the duplex module) must meet the following conditions:

- Paper type : Plain paper as specified on page above.
- Paper size : Must be one of the following standard sizes: 11" x 17", 8-1/2" x 14", 8-1/2" x 13", 8-1/2" x 11", 8-1/2" x 11"R, 7-1/4" x 10-1/2" or 5-1/2" x 8-1/2" (A3, B4, A4, A4R, B5, B5R or A5)
- Paper weight : 17 to 54 lbs. or 64 to 200 g/m²

NOTES

- Special papers as described above cannot be used for automatic two-sided printing. Heavy paper up to 54 lbs. (200 g/m²) can be used.
- The image quality and toner fusibility of special papers may change due to ambient conditions, operating conditions, and paper characteristics, resulting in image quality inferior to that of SHARP standard paper.
- Various types of plain paper and special paper are sold. Some of these cannot be used in the machine. Please consult your retailer or your dealer when buying paper.

Setting the paper type (except the bypass tray)

Follow these steps to change the paper type setting when the paper type has been changed in a paper tray. For the paper types that can be used in each tray, see page 2-9. To change the paper type setting for the bypass tray, see page 2-12.

1 Press the [CUSTOM SETTINGS] key.

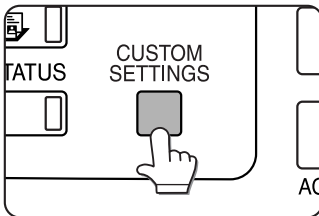

The custom setting menu screen will appear.

2 Touch the [TRAY SETTINGS] key.

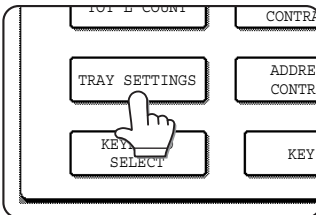

The paper tray selection screen will appear.

3 Select the paper tray for which the setting is to be made. (For the tray numbers, see the tray specifications on page 2-9.)

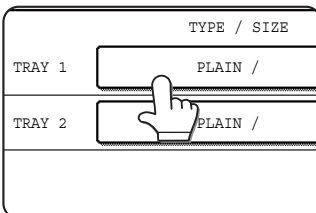

If the desired tray is not on the display, use or key to scroll the display until it appears.

4 Select the type of paper that was loaded in the tray.

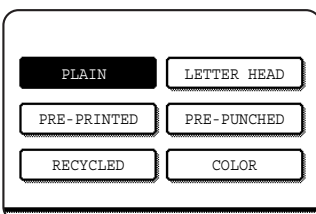

The currently selected paper type will be highlighted. To change the setting, touch the desired type.

NOTE

Special paper such as transparency film, envelopes, and postcards can only be used in the bypass tray.

5 Touch the [OK] key to complete the setting.

Setting the paper size when an extra size is loaded

When a paper tray is set to "extra", this informs the machine that an extra size is being used. It does not inform the specific size. To enter the specific size of the paper loaded, follow the steps below.

For example, if A4 size paper is loaded in the tray (with the size slide set to "extra"), you can use this procedure to set the paper size recognized by the machine to A4 size. If you loaded an irregular size of paper, you can enter the dimensions of the paper.

To set the paper size when an extra size of paper is loaded in the bypass tray, see page 2-12.

1 Perform steps 1 through 4 of "Setting the paper type" at left.

2 Touch the key to display the paper size setting screen.

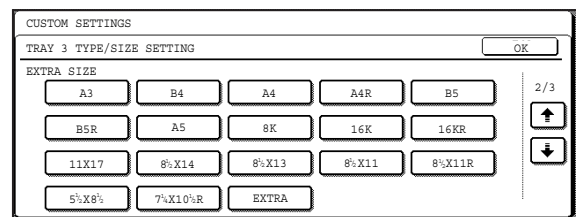

3 When the loaded paper size appears in the display (if you loaded an AB-based size such as A4), touch the size key to highlight it, and then touch the [OK] key to complete the procedure.

4 If an irregular size of paper was loaded after the [EXTRA] key was touched, touch the key in the screen of step 2 to display the following screen.

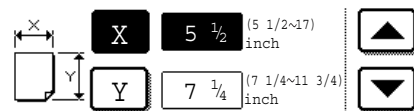

When the screen opens the X key will be highlighted. Use the and touch keys to enter the X dimension. Next touch the Y key to highlight it and enter the dimensions for Y.

The permitted range for the X dimension is 5-1/2 to 17 inches (139 to 432 mm), and the permitted range for the Y dimension is 7-1/4 to 11-3/4 inches (182 to 297 mm).

When both have been entered, touch the [OK] to complete the operation.

Setting the paper type and paper size in the bypass tray

Follow the steps below to set the type and size of the paper loaded in the bypass tray.

1 Touch the [PAPER SELECT] key.

(When copy mode is selected)

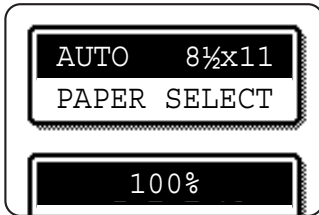

Touch the [PAPER SELECT] key in the main screen of the copy mode.

(When printer mode is selected)

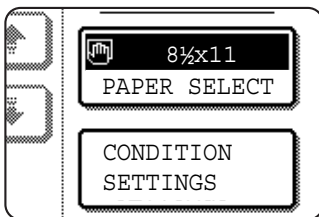

Touch the [PAPER SELECT] key in the main screen of printer mode.

2 Touch the key for the desired paper type.

(When copy mode is selected)

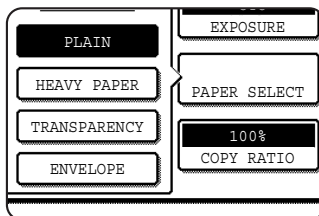

The key for the selected paper type will be highlighted.

(When printer mode is selected)

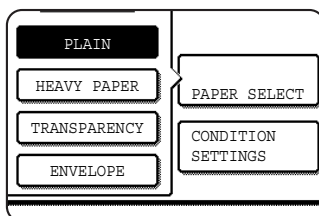

The steps that follow differ depending on the paper type selected. Follow the steps for the selected type.

- If you touched [PLAIN], go to step 6.
- If you touched [HEAVY PAPER], go to step 3
- If you touched [TRANSPARENCY], go to step 4.
- If you touched [ENVELOPE], go to step 5.

3 Touch [HEAVY PAPER 1] or [HEAVY PAPER 2], and go to step 6.

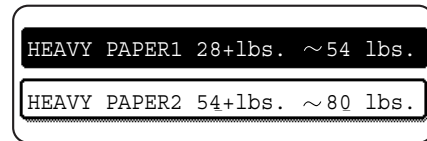

For the types of heavy paper that can be used, see page 2-10.

4 Touch [SPEED MODE] or [QUALITY MODE] for the transparency film, and go to step 7.

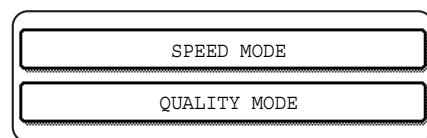

- SPEED MODE is for fast printing.
- QUALITY MODE is for a high quality image.

5 Touch the type of envelope, and go to step 7.

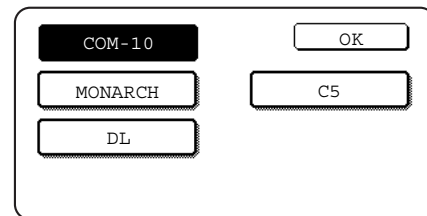

6 If you inserted a non-standard size of paper in the bypass tray, remove the checkmark from "ENABLE AUTO SIZE DETECTION" and then touch the [EXTRA SIZE] tab. When the screen opens, the X key will be highlighted. Use the [▲] and [▼] touch keys to enter the X dimension. If you inserted a standard size of paper in the bypass tray, make sure that a checkmark appears in the [ENABLE AUTO SIZE DETECTION] checkbox.

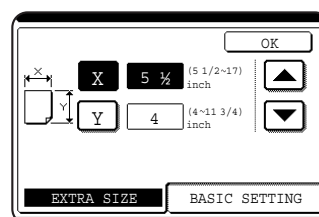

Next touch the [Y] key to highlight it and enter the dimensions for Y.

The permitted range for the X dimension is 5-1/2 to 17 inches (139 to 432 mm), and the permitted

range for the Y dimension is 4 to 11-3/4 inches (100 to 297 mm).

7 Touch the [OK] key to complete the setting.

CUSTOM SETTINGS

The items that can be set with the custom settings are shown below.

- Total count The number of pages processed by the machine and optional equipment can be displayed. (See page 2-14.)
- Display contrast Used to adjust the contrast of the operation panel display. (See page 2-14.)
- List print Used to print a list of machine settings. (See page 2-14.)
- Clock adjust Used to set the date and time of the built-in clock of the machine. (See this page.)
- Tray settings The paper type, paper size and automatic tray switching can be set for each tray. Automatic tray switching allows feeding to switch between trays loaded with the same type and size of paper. If one tray runs out of paper during printing, printing will continue from the other tray. (See page 2-14)

For the detailed descriptions and use of the settings listed below, see the Operation manuals for fax* and network scanner.

- Address control..... Use this to store fax destinations (fax numbers). This is also used to store groups, memory boxes, and user indexes. E-mail addresses, user indexes, and scanner senders can be stored for the network scanner function.
- Receive mode..... Use this to configure fax reception settings (auto/manual).
- Fax data forward..... Faxes received to memory can be forwarded to another destination.
- Keyboard select..... When using the fax function or network scanner function, you can switch the arrangement of the letter keys in the display keyboard used for storing and editing destinations in the English character entry screen.
- Key operator program..... These are programs that are used by the key operator (administrator of the machine) to configure machine settings. A key appears for these settings in the custom settings menu screen. For information on these settings, see the key operator's guide.

* These fax settings can be configured only if the fax function has been enabled.

Operation procedure common to all custom settings

1 Press the [CUSTOM SETTINGS] key.

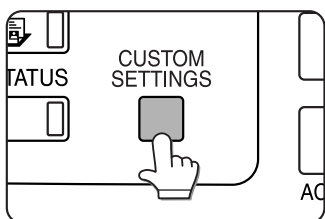

The custom setting menu screen will appear.

2 Touch the key of the desired item to display its setting screen.

The settings accessed by touching the [CLOCK] key are explained here.

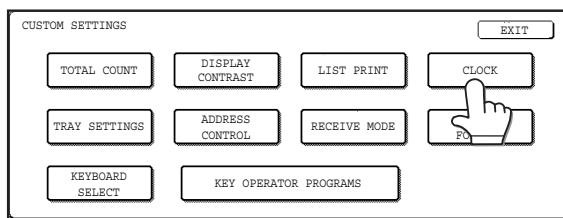

Detailed descriptions for program settings start on the next page.

The procedure for setting the clock is shown below as an example.

More information on setting procedures

In the following type of screen, a setting is turned on when a checkmark (☑) appears next to the key. A checkmark will appear or disappear by alternate touches of the checkmark box. In the following screen, tray 1 can be used in print, copy, and fax modes. Tray 2 can only be used in the copy mode.

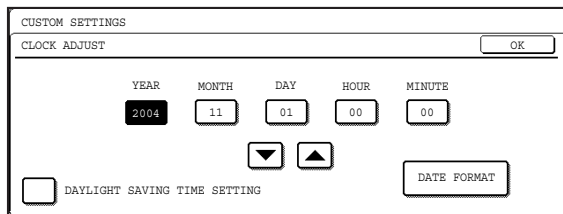
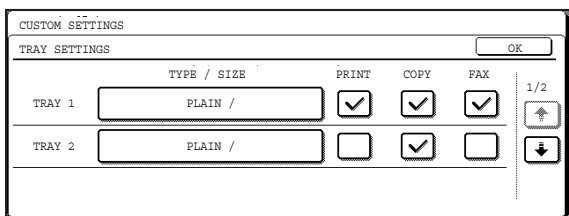

3 Touch the year, month, day, hour or minute key, and then use the ▲ or ▼ key to adjust the setting.

- If you select a non-existent date (for example, Feb. 30), the [OK] key will gray out to prevent entry of the date.
- Select [DAYLIGHT SAVING TIME SETTING] checkbox to have the time automatically change at the beginning and end of daylight saving time.

4 Touch the [OK] key.

5 To finish the setting operation, touch the [EXIT] key.

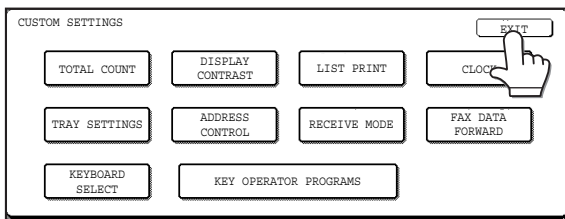

About the settings

■ Total count

This displays the following sheet counts:

- ① The number of sheets printed in copy, print, and fax modes.
- ② The number of sheets transmitted using the fax function and scanned using the network scanner function.
- ③ The number of sheets used by optional equipment such as the reversing automatic document feeder and the duplex module of the duplex module/2 x 500 sheet paper drawer, and the number of sheets stapled by the saddle stitch finisher.

In the case of ① only,

- Each sheet of paper that is 11" x 17" (A3) size or larger is counted as two sheets.
- Each sheet of paper used for automatic two-sided copying is counted as two sheets (11" x 17" (A3) paper is counted as four sheets). (When an optional duplex module/2 x 500 sheet paper drawer and a duplex bypass/inverter unit are installed.)

■ Display contrast

Screen contrast adjustment is used to make the LCD touch panel easier to view under various lighting conditions. Touch the [LIGHTER] key to make the screen lighter, or the [DARKER] key to make the screen darker.

■ List print

Used to print a list of the settings configured in the fax, printer and network scanner function.

■ Clock adjust

Use this to set the date and time in the machine's built-in clock. This clock is used by functions that require date and time information.

The format of the printed date can also be changed.

■ Tray settings

The paper type, paper size, enabled modes and automatic tray switching can set for each tray. See page 2-11 for details on setting the paper type and paper size. Automatic tray switching to another paper tray is used to automatically switch to another tray with the same size and type of paper in the event that the paper runs out during continuous printing. This requires that the trays be loaded with the same size of paper. To enable any function, touch the check box key so that a checkmark (☑) appears.

■ Keyboard select

When using the fax function or network scanner function, you can switch the arrangement of the letter keys in the display keyboard that appear in the character entry screen when storing or editing destinations. Select the arrangement of the letter keys that you find easiest to use.

The following three alphabet keyboard configurations are available:

- Keyboard 1 (QWERT... configuration)*
 - Keyboard 2 (AZERTY...configuration)
 - Keyboard 3 (ABCDEF...configuration)
- * The default setting is "Keyboard 1".

(Example: Character entry screen when Keyboard 3 is selected)

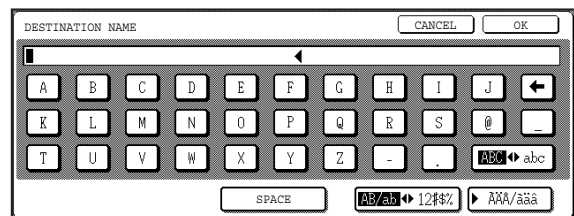

REPLACING THE TONER CARTRIDGES

When toner runs low, "[□□□□] TONER SUPPLY IS LOW" appears in the display. It is recommended that you keep a set of new toner cartridges so that you can replace them quickly when toner runs out.

READY TO COPY.
([□□□□] TONER SUPPLY IS LOW.)



If you continue to use the toner cartridge, the toner will eventually run out, the machine will stop and the following message will appear.

△ CHANGE THE TONER CARTRIDGE.
([□□□□])

This indicates the color of toner that is low.

- Y = Yellow toner
- M = Magenta toner
- C = Cyan toner
- BK = Black toner

2

NOTES

- There may be cases that copy images become light or uneven before the message is displayed, depending on the way the machine is used. If this occurs, take out the toner cartridge by following the same steps as replacement, shake it horizontally to even out the toner in the cartridge, and re-insert the toner cartridge. If copy images do not improve even after following this procedure, replace the toner cartridge with a new cartridge.
- If one of the toners is out, including black toner, color copying will not be possible. If Y, M, or C runs out but BK toner remains, black and white copying will still be possible.

Follow these steps to replace the toner cartridge that is out of toner.

1 Open the front cover.

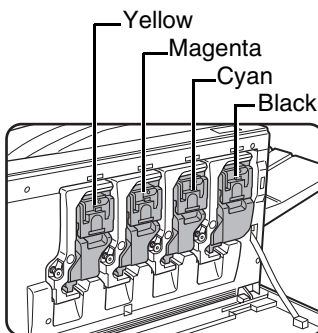
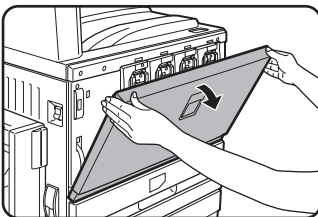

Arrangement of color toner cartridges

2 Lift the cartridge lock lever toward you.

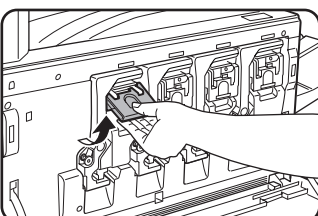

Example: Replacing the yellow toner cartridge

3 While holding the lock lever on the toner cartridge, pull the toner cartridge toward you.

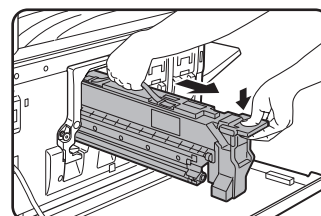
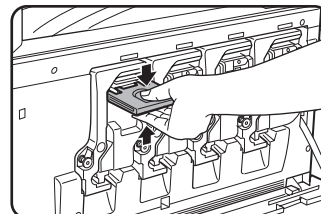

Hold the toner cartridge with both hands as shown in the illustration, and pull it out of the machine.

4 Remove a new toner cartridge from the package and shake it horizontally five or six times.

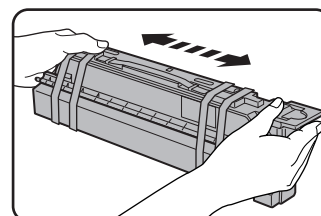

NOTE

Shake the toner cartridge well to ensure that the toner flows well and will not stick to the inside of the cartridge.

5 Remove the protective material from the new toner cartridge.

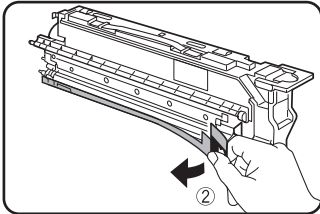
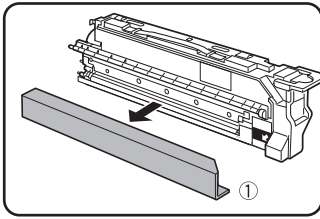

6 Insert the new toner cartridge.

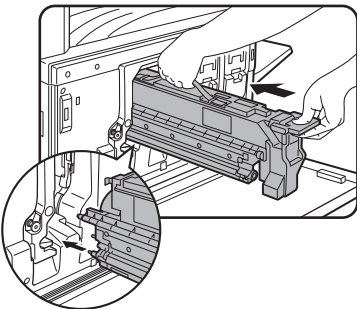

Align the insert holes as shown and then push the cartridge in.

NOTE

A toner cartridge of a different color cannot be installed. For instance, a yellow cartridge cannot be installed in the cyan position.

7 Push the cartridge in until it locks securely in place.

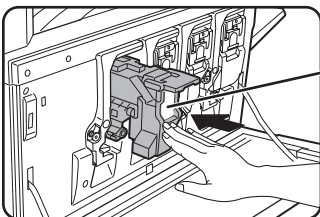

NOTE

Do not push the white area shown in the illustration. The lock lever may come down.

8 Return the cartridge lock lever.

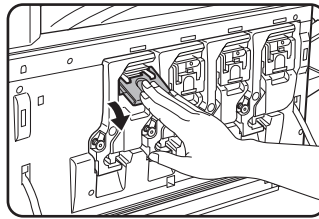

9 Close the front cover.

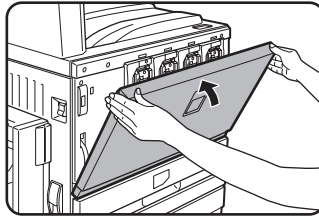

After the toner cartridge is replaced, the machine automatically enters resolution adjustment mode. (In some cases, this may take about 1 to 5 minutes.)

CAUTION

- Do not throw the toner cartridge into a fire. Toner may fly and cause burns.
- Store toner cartridges out of the reach of small children.

STORAGE OF SUPPLIES

Standard supplies for this product that can be replaced by the user include paper, toner cartridges, and staple cartridges for the finisher.

SHARP

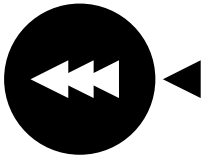

For best copying results, be sure to use only Sharp Genuine Supplies which are designed, engineered, and tested to maximize the life and performance of Sharp products. Look for the Genuine Supplies label on the toner package.

GENUINE SUPPLIES

2

■ Proper storage

1. Store the supplies in a location that is:
 - clean and dry,
 - at a stable temperature,
 - not exposed to direct sunlight.
2. Store paper in the wrapper and lying flat.
3. Paper stored in packages standing up or out of the wrapper may curl or become damp, resulting in paper misfeeds.
4. Store a new toner cartridge box horizontally. Do not store it standing on end. If stored standing on end, the toner may not distribute well even after shaking the cartridge vigorously, and will remain inside the cartridge without flowing out.

Supply and Consumables

The supply of spare parts for a repair of the appliance is guaranteed for at least 7 years following the termination of production. Spare parts are those parts of the apparatus which may break down within the scope of the ordinary use of the product - whereas those parts which normally exceed the life of the product are not to be considered as spare parts. Consumables too, are available for 7 years following the termination of production.

MISFEED REMOVAL

When a misfeed has occurred during printing, the message "MISFEED HAS OCCURRED." will appear in the touch panel display of the operation panel and printing output will stop. The approximate locations of possible misfeeds are indicated by "▼" in the illustration below. The page numbers for detailed information for misfeed removal for each are also shown.

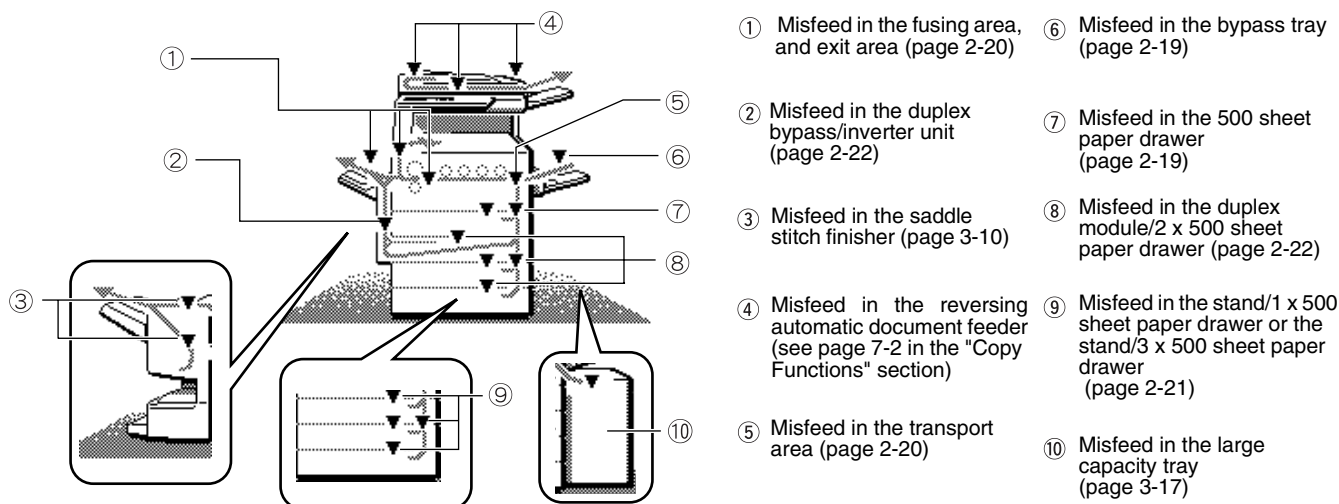

- ① Misfeed in the fusing area, and exit area (page 2-20)
- ② Misfeed in the duplex bypass/inverter unit (page 2-22)
- ③ Misfeed in the saddle stitch finisher (page 3-10)
- ④ Misfeed in the reversing automatic document feeder (see page 7-2 in the "Copy Functions" section)
- ⑤ Misfeed in the transport area (page 2-20)
- ⑥ Misfeed in the bypass tray (page 2-19)
- ⑦ Misfeed in the 500 sheet paper drawer (page 2-19)
- ⑧ Misfeed in the duplex module/2 x 500 sheet paper drawer (page 2-22)
- ⑨ Misfeed in the stand/1 x 500 sheet paper drawer or the stand/3 x 500 sheet paper drawer (page 2-21)
- ⑩ Misfeed in the large capacity tray (page 3-17)

NOTE

Received faxes are all temporarily stored in memory. If a paper misfeed occurs, received faxes cannot be printed. When the misfeed is removed, the received faxes will print out automatically.

NOTES

- Be careful not to tear the misfed paper during removal.
- If paper is accidentally torn during removal, be sure to remove all pieces.
- Take care not to damage or leave fingerprints on the transfer belt when removing the misfed paper.

CAUTION

The fusing unit is hot. Take care in removing paper.

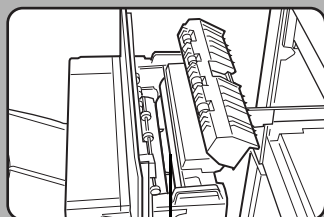

Upper fusing unit

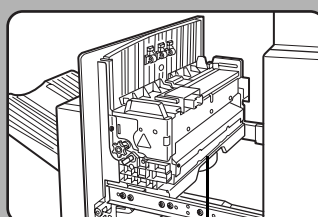

Fusing unit paper guide

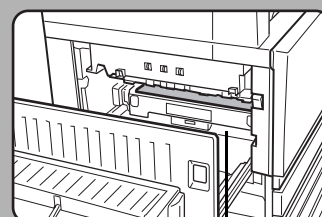

Transfer belt

Misfeed removal guidance

Misfeed removal guidance can be displayed by touching the [INFORMATION] key on the touch panel after a misfeed has occurred.

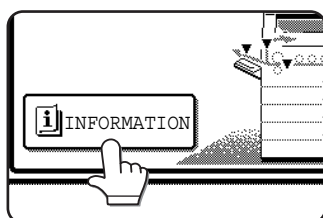

Misfeed in the paper feed area

NOTE

Paper misfed from a paper tray may be extending out of the tray into the right side cover area. In this case if the tray is drawn out of the machine, the paper may become torn and difficult to remove. To prevent this from happening, always open the right side cover first and remove the misfed paper if it is extending into that area.

Misfeed in the 500 sheet paper drawer

1 Open the upper side cover.

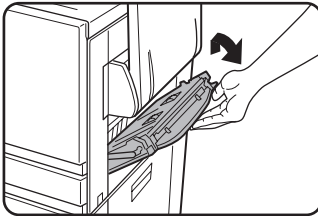

Push the lever upward and gently open the cover.

NOTE

If paper is loaded in the bypass tray, temporarily remove the paper and close the bypass tray before opening the side cover.

2 Remove the misfed paper.

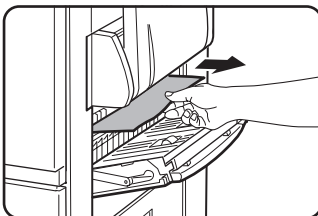

Be careful not to tear the misfed paper during removal.

NOTE

The misfeed may have occurred inside the machine. Check carefully and remove it.

3 If misfed paper is not found in step 2, pull out paper tray 1 and remove the misfed paper.

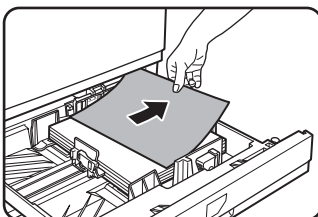

Be careful not to tear the misfed paper during removal.

4 Gently close the paper tray.

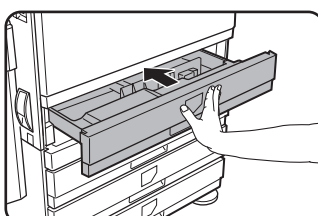

Push the tray firmly all the way into the machine.

5 Gently close the upper side cover.

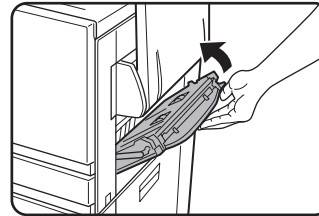

After closing, confirm that the misfeed message has been cleared and the normal display appears.

2

Misfeed in the bypass tray

1 Remove the misfed paper from the bypass tray.

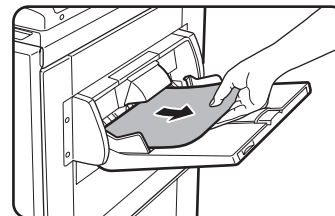

Be careful not to tear the misfed paper during removal.

2 After removing the misfed paper, open and close the duplex bypass/inverter unit to reset.

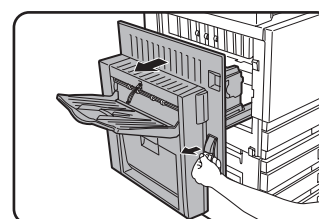

Grasp the finger hold and gently open the unit.

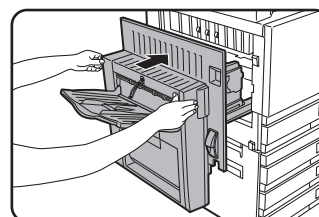

After closing, confirm that the misfeed message has been cleared and the normal display appears. If the duplex bypass/inverter unit is not installed, close the side cover in the same way.

Misfeed in the transport area, fusing area, and exit area

Transport area

1 Open the upper side cover and check for a misfeed.

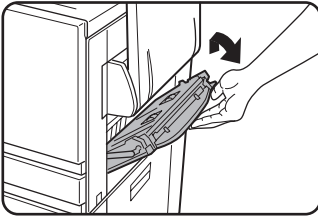

① Push the lever upward and gently open the cover.

NOTE

If paper is loaded in the bypass tray, temporarily remove the paper and close the bypass tray before opening the side cover.

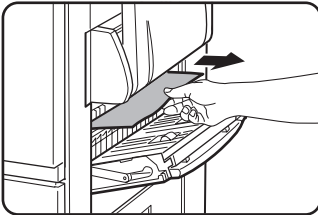

② Be careful not to tear the misfed paper during removal.

NOTE

The misfeed may have occurred inside the machine. Check carefully and remove it.

2 Gently close the upper side cover.

NOTE

Even after clearing a misfeed, paper may remain inside the machine on the transfer belt where it is not visible. In this case, after visible misfeeds are removed, the paper on the transfer belt will be automatically moved to a position where it is visible and a misfeed will be indicated once again on the display. Clear the misfeed as explained in "Misfeed in the transfer unit" (step 3 on the right side of this page). For this reason, it may be necessary to perform the "Misfeed in the transfer unit" procedure twice.

Exit area

1 Misfeed in the exit area

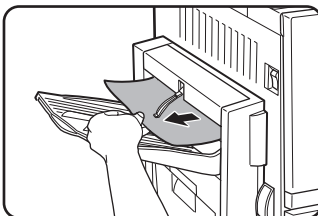

Models with an exit tray attached to the duplex bypass/inverter unit:

Gently remove the misfed paper as shown in the illustration, taking care not to tear the paper.

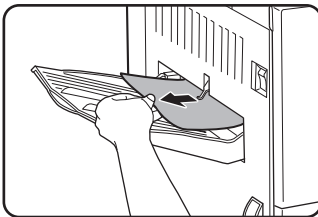

Models without the duplex bypass/inverter unit:

Gently remove the misfed paper as shown in the illustration, taking care not to tear the paper.

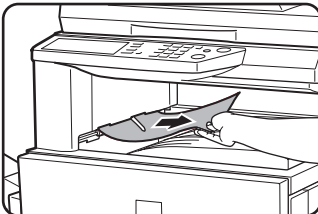

Upper exit tray:

Gently remove the misfed paper as shown in the illustration, taking care not to tear the paper.

Fusing area

1 Open the duplex bypass/inverter unit.

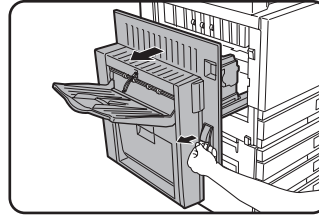

Grasp the finger hold and gently open the unit.

2 Remove the misfed paper as shown in the illustrations below.

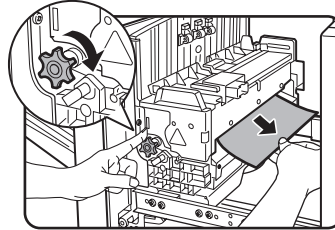

If paper is misfed in the transport area, turn roller rotating knob A in the direction of the arrow to remove the misfed paper.

CAUTION

The fusing unit is hot. Take care in removing paper. (Do not touch any metal parts.)

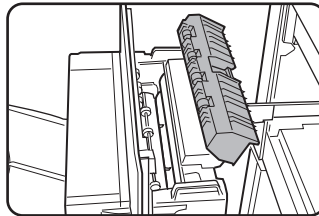

If you do not find a misfeed, open the cover of the fusing unit and check for a misfeed inside the fusing unit.

CAUTION

The fusing unit is hot. Take care in removing paper. (Do not touch any metal parts.)

3 Misfeed in the transfer unit

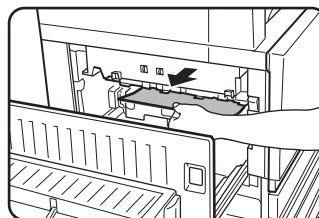

If paper is misfed on the transfer belt, remove it gently without touching the transfer belt. Do not pull out the transfer unit.

CAUTION

The transfer unit is hot. Take care in removing paper. (Do not touch any metal parts.)

4 Gently close the duplex bypass/inverter unit.

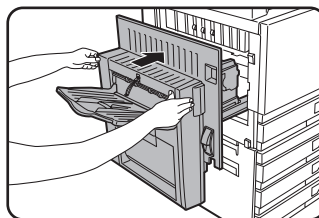

After closing, confirm that the misfeed message has been cleared and the normal display appears. If the duplex bypass/inverter unit is not installed, close the side cover in the same way.

Misfeed in the stand/1 x 500 sheet paper drawer

NOTE

Paper misfed from a paper tray may be extending out of the tray into the right side cover area. In this case if the tray is drawn out of the machine, the paper may become torn and difficult to remove. To prevent this from happening, always open the right side cover first and remove the misfed paper if it is extending into that area.

1 Open the upper and lower side covers.

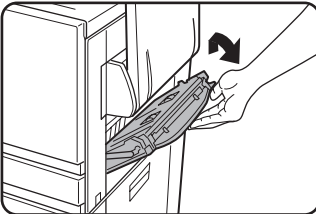

Push the lever upward and gently open the cover.

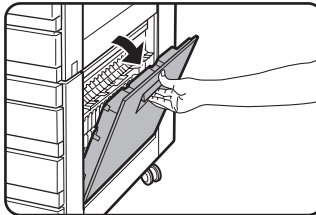

NOTE

If paper is loaded in the bypass tray, temporarily remove the paper and close the bypass tray before opening the side cover.

2 Remove the misfed paper.

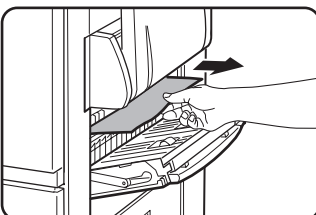

Be careful not to tear the misfed paper during removal.

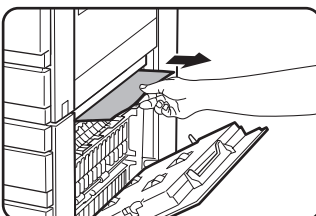

NOTE

The misfeed may have occurred inside the machine. Check carefully and remove it.

3 If misfed paper is not found in step 2, pull out paper tray 1 and remove the misfed paper.

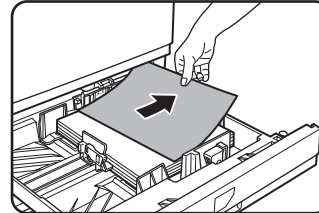

Be careful not to tear the misfed paper during removal.

4 Gently push the paper tray into the machine.

Push the tray firmly all the way into the machine.

5 Gently close the upper and lower side covers.

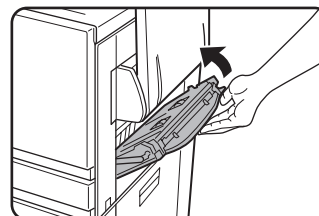

After closing, confirm that the misfeed message has been cleared and the normal display appears.

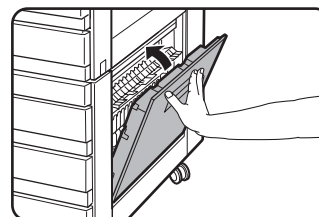

Misfeed in the stand/3 x 500 sheet paper drawer

To remove a misfeed in the upper, middle, or lower tray, follow steps 1 through 5 above of "Misfeed in the stand/1 x 500 sheet paper drawer".

Misfeed in the duplex bypass/inverter unit and duplex module/2 x 500 sheet paper drawer

NOTE

Paper misfed from a paper tray may be extending out of the tray into the right side cover area. In this case if the tray is drawn out of the machine, the paper may become torn and difficult to remove. To prevent this from happening, always open the right side cover first and remove the misfed paper if it is extending into that area.

1 Perform steps 1 and 2 of "Misfeed in the stand/1 x 500 sheet paper drawer" on the previous page.

2 Open the upper cover of the duplex bypass/inverter unit.

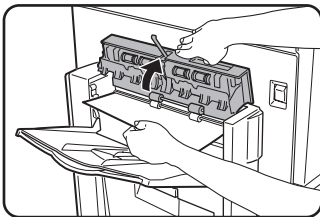

3 Remove the misfeed from the upper part of the duplex bypass/inverter unit.

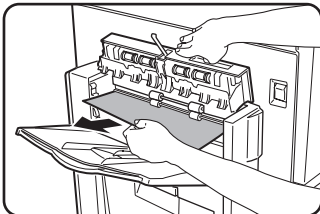

Hold the upper cover of the unit open while removing the misfed paper.

4 Close the upper cover of the duplex bypass/inverter unit.

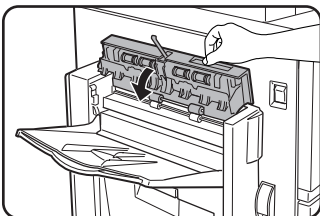

5 Lift the exit tray if one is installed and open the cover of the duplex bypass/inverter unit.

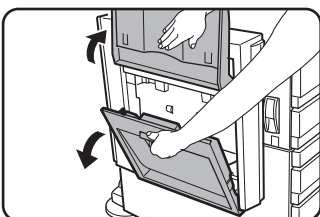

6 Remove the misfed paper.

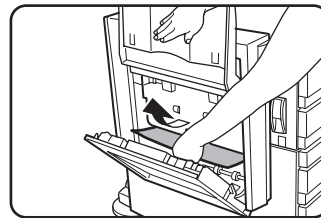

While holding the exit tray up, remove the misfed paper as shown in the illustration. Be careful not to tear the misfed paper during removal.

7 Close the cover of the duplex bypass/inverter unit and return the exit tray to its original position.

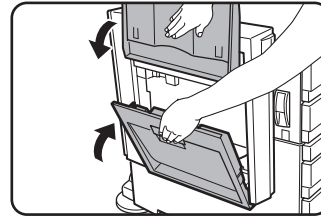

8 Remove a misfeed from the bottom of the duplex bypass/inverter unit.

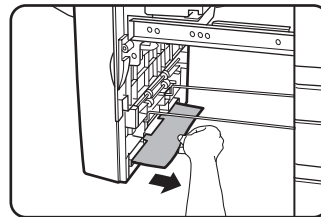

Gently remove the misfed paper from the bottom of the duplex bypass/inverter unit as shown in the illustration, taking care not to tear the paper.

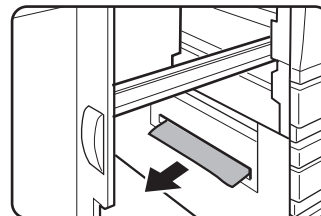

Make sure that there is no misfed paper in the machine.

9 Pull out the duplex module of the duplex module/2 x 500 sheet paper drawer.

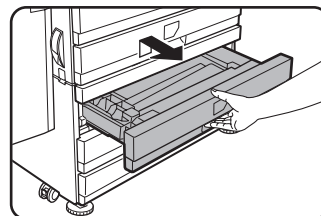

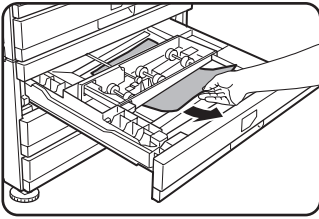
10 Remove the misfed paper from the duplex module.

Be careful not to tear the misfed paper during removal.

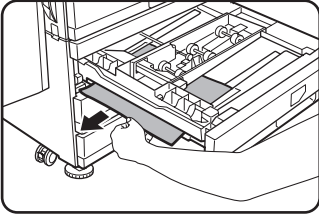
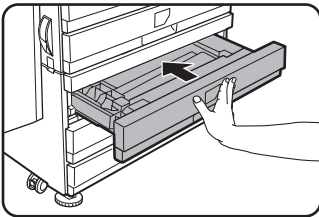
**11** Gently close the duplex module.

Push the tray firmly all the way into the machine.

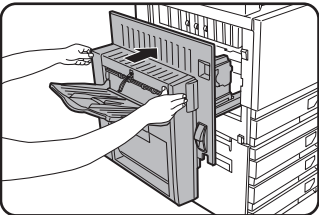
12 Gently close the duplex bypass /inverter unit.**■ Misfeed in the upper or lower tray**

To remove misfed paper from the upper tray or lower tray, follow steps 1 through 5 of "Misfeed in the stand/1 x 500 sheet paper drawer" on page 2-21.

TROUBLESHOOTING

Check the following troubleshooting list before requesting service as many problems can be fixed by the user. If you are unable to solve the problem by checking the list, turn off the power switch, unplug the power cord.

Problems related to general use of the machine are described below. For problems related to the copy function, see page 7-4. For fax, printer, and network scanner problems, see the manuals for those functions. For peripheral device problems, see the explanation of the device.

If the message "CALL FOR SERVICE. CODE:**_***" appears in the touch panel, turn off the power switch, wait about 10 seconds, and then turn the power switch back on. If the message still appears after turning the switch off and on several times, it is likely that a failure has occurred and maintenance would be required. In this event, stop using the machine, unplug the power cord, and contact your Sharp dealer.

Note: Letters and numbers appear in "***_***" above. When you contact your Sharp dealer, please tell your dealer what letters and numbers appear.

| Problem | Check | Solution or cause |
|---|---|--|
| The machine does not operate. | Printer plugged in? | Plug the printer into a grounded outlet. |
| | Power switch on? | Turn on the power switch. |
| | READY indicator off? | The printer is warming up. (Warm-up time is approximately 99 seconds.) Wait until the READY indicator lights up. |
| | Message indicating need to load paper displayed? | Load paper. (page 2-2) |
| | Message indicating need to replace the toner cartridge displayed? | Replace the toner cartridge.(page 2-15) |
| | Message indicating a paper misfeed displayed? | Remove misfed paper. (page 2-18) |
| | A message appears saying that the power must be turned off and then turned on. | Turn off the power switch, wait about 10 seconds, and then turn on the switch again. If the same message appears after turning the power switch off and on several times, it is possible that the machine needs service. In this event, contact your dealer. |
| Copying/printing is not possible. | A message appears saying that this type of paper cannot be used for two-sided copying. | Two-sided printing is not possible on special paper. Use paper that can be used for automatic two-sided printing. (page 2-10) |
| Incorrect bypass tray paper size. | Incorrect display of paper sizes 12" x 18", 11" x 17", 8-1/2" x 14", 8-1/2" x 13", 8-1/2" x 11"R, A3W, A3, B4, or A4R only. | When loading sizes 12" x 18", 11" x 17", 8-1/2" x 14", 8-1/2" x 13", 8-1/2" x 11"R, A3W, A3, B4, or A4R, be sure to open the tray extension. |
| Copying/printing on paper from the bypass tray is skewed. | The number of sheets placed on the bypass tray exceeds the maximum number. | Do not place more than the maximum number of sheets. |
| | The bypass guide is not adjusted to the size of the loaded paper. | Adjust the bypass guide to the size of the loaded paper. |
| Paper from the bypass tray misfeeds. | The paper size and paper type have not been set. | Be sure to set the paper size and paper type when using special size or special type papers. (page 2-12) |
| | The number of sheets placed on the bypass tray exceeds the maximum number. | Do not place more than the maximum number of sheets. |
| | The bypass guide is not adjusted to the size of the loaded paper. | Adjust the bypass guide to the size of the loaded paper. |
| Printing stops before the job is finished. | If too many pages collect on the output tray, the tray full sensor activates and stops printing. | Remove the paper from the output tray. |
| | You have run out of paper. | Load paper. (page 2-2) |

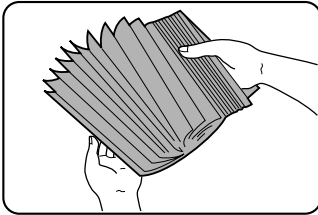
| Problem | Check | Solution or cause |
|---|---|--|
| Smudges on printed sheets. | Does a message appear indicating the need for maintenance? | Please contact the your dealer as soon as possible. |
| Color deviations occur. | When printing in color, character and color deviations appear. | Perform color registration as explained on pages 12 and 13 of the key operator's guide. |
| The displayed paper size differs from the loaded paper size. | The display of the tray's paper size slide differs from the paper size in the tray. | When you change the paper size in the tray, be sure to adjust the paper size slide on the tray to the new paper size. (page 2-2) |
| When printing on a special size of paper, part of the printed image is missing. | The paper size setting is not set correctly in the paper tray settings of the custom settings. | When using a special size of paper, set the correct paper size in millimeters in the paper tray settings of the custom settings (see page 2-11). If the paper size setting is not correct, part or all of the image may not print (this depends on the options installed). |
| When printing on a special size of paper using the bypass tray, part of the printed image is missing. | The paper size is not set correctly in the special size settings for the bypass tray. | When using a special size of paper, set the correct paper size in millimeters as explained in step 6 on page 2-12. If the paper size setting is not correct, part or all of the image may not print (this depends on the options installed). |
| Paper misfeeds frequently. | Is paper other than SHARP-recommended paper being used? | Use SHARP-recommended paper. |
| | Paper curled or damp? | Do not use curled or crimped paper. If you do not use paper for a long time, store paper in the wrapper in a dry location. |
| | Is the paper curled and does it frequently misfeed in the duplex module/2 x 500 sheet paper drawer or saddle stitch finisher? | Paper may be curled when output depending on the paper type and quality. In some cases turning the paper over in the tray will reduce misfeeding due to curling. |
| | Multiple sheets of paper fed simultaneously? |  Remove the paper from the paper tray or the bypass tray, fan the paper as shown in the illustration, and then load it again. |
| Printed paper is wrinkled or the image rubs off easily. | Is paper other than SHARP-recommended paper being used? | Use SHARP-recommended paper. |
| | Is paper size or weight out of the allowable range? | Use paper in the allowable range. |
| | Do wrinkles appear when printing envelopes? | Moving the pressure adjusting levers of the fusing unit from the normal position to a weaker pressure position may help alleviate this problem. (page 2-6) |
| | Is the pressure adjustment lever of the fusing unit out of position? | Return the pressure adjusting levers of the fusing unit to the normal position. (page 2-7) |
| | Paper damp? | Be sure to store paper in the wrapper in a dry location and do not store paper in a location that is ● humid ● at a high temperature or an extremely low temperature. |
| The contrast on the touch panel is too high or too low. | Is LCD contrast properly adjusted? | Adjust the contrast using "DISPLAY CONTRAST" of custom settings. (page 2-13) |

CHAPTER 3

PERIPHERAL DEVICES

This chapter explains procedures for using the peripheral devices such as the Saddle Stitch Finisher.

| | Page |
|--|------|
| SADDLE STITCH FINISHER..... | 3-2 |
| • Part names and functions | 3-2 |
| • Specifications | 3-2 |
| • Saddle stitch finisher functions..... | 3-4 |
| • Using the saddle stitch finisher | 3-6 |
| • Staple cartridge replacement and staple jam removal | 3-7 |
| • Misfeed in the saddle stitch finisher | 3-10 |
| • Troubleshooting saddle stitch finisher problems | 3-12 |
| • Stapling position quick reference guide for duplex output..... | 3-13 |
| • Relation between print image and saddle stitch..... | 3-14 |
| LARGE CAPACITY TRAY | 3-15 |
| • Part name..... | 3-15 |
| • Specifications | 3-15 |
| • Loading paper in the large capacity tray | 3-16 |
| • Misfeed in the large capacity tray..... | 3-17 |

SADDLE STITCH FINISHER

The saddle stitch finisher can automatically place two staples for centerline binding of prints or copies and fold them along the centerline. An optional hole punching unit is available for installation into the finisher.

Part names and functions

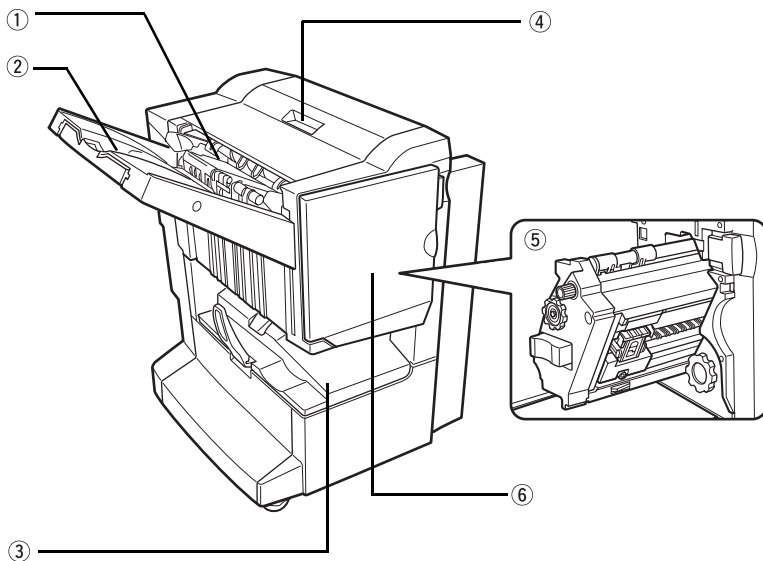

- ① **Stapler compiler**
Paper to be stapled is stacked temporarily. When printing on post cards or envelopes, remove the output from here.
- ② **Offset tray**
Output which is stapled or offset will be delivered to this tray.
- ③ **Saddle stitch tray**
Saddle stitched output is delivered here.
- ④ **Top cover**
Open for misfeed removal.
- ⑤ **Stapler section**
Open the front cover and pull out this section to replace the staple cartridge or to remove jammed staples.
- ⑥ **Front cover**
Open to replace the staple cartridge, to remove the misfed paper, or to remove jammed staples.

NOTES

- Do not press on the saddle stitch finisher (particularly the offset tray).
- Use caution when near the offset tray during printing as the tray moves up and down.
- To install the saddle stitch finisher, a duplex bypass/inverter unit and either a stand/1 x 500 sheet paper drawer, a stand/3 x 500 sheet paper drawer, or a duplex module/2 x 500 sheet paper drawer must also be installed.

Specifications

| Name | SADDLE STITCH FINISHER (AR-F13) |
|--------------------------|---|
| Paper size/Useable paper | Paper size Upper paper tray: Face up output: Same as paper specifications of machine Face down output: 12" x 18", 11" x 17", 8-1/2" x 14", 8-1/2" x 13", 8-1/2" x 11", 8-1/2" x 11"R, 7-1/4" x 10-1/2"R, 5-1/2" x 8-1/2", A3W, A3, B4, A4, A4R, B5, B5R, A5 Lower tray: 11" x 17", 8-1/2" x 11"R, A3, B4, A4R |
| | Paper weight Upper tray: 17 to 80 lbs. or 64 to 300 g/m ² for face up output 17 to 54 lbs. or 64 to 200 g/m ² for face down output Lower tray: 17 to 28 lbs. or 64 to 105 g/m ² |
| | Paper types Upper tray: Same as paper specifications of the machine Lower tray: Plain paper only |
| Number of trays | 2 (offset tray + saddle stitch tray) |
| Tray capacity | Upper paper tray: Non-stapling: 1000 sheets of paper: 8-1/2" x 11", 8-1/2" x 11"R, A4, A4R, B5, B5R (21 lbs. or 80 g/m ²) 500 sheets of paper: Sizes other than 8-1/2" x 11", 8-1/2" x 11"R, A4, A4R, B5 or B5R (up to 10 envelopes or postcards inside the staple compiler; alignment is not guaranteed) Stapling: Maximum of 30 sets or 1000 sheets of 8-1/2" x 11", A4, or B5 paper (50 sets maximum for vertically fed paper stapled at one location in the upper left corner). Maximum of 30 sets or 500 sheets of other paper sizes. Lower tray: Stapled print capacity is (6 - 10) sheets x 10 sets or (1 - 5) sheets x 20 sets. |

(Continued on next page)

| | |
|---|--|
| Staple | Allowed paper sizes for stapling Upper tray: 11" x 17", 8-1/2" x 14", 8-1/2" x 13", 8-1/2" x 11", 8-1/2" x 11"R, A3, B4, A4, A4R, B5 Lower tray: 11" x 17", 8-1/2" x 11"R, A3, B4, A4R |
| | Maximum number of sheets for stapling See "Staple sort mode" on the next page |
| | Stapling positions Upper tray: 3 locations (1 position back, 1 position front, 2 positions center) Lower tray: 4-47/64" (120 mm) pitch from center of paper |
| Saddle stitch | Maximum of 10 sheets can be stapled (21 lbs. or 80 g/m ²) Paper size: 11" x 17", 8-1/2" x 11"R, A3, B4, A4R Paper weight: 17 to 28 lbs. or 64 to 105 g/m ² |
| Power supply | Supplied from machine (Stand / paper drawer) |
| Dimensions | 24-59/64" (W) x 23-3/4" (D) x 30-23/64" (H) (633mm(W) x 603mm(D) x 771mm(H)) |
| Weight | Approximately 79.4lbs. (36kg) |
| Overall dimensions when attached to machine | 56-25/64" (W) x 26-5/8" (D) (1432mm(W) x 676mm(D)) (when tray is extended) |
| Remarks | |
| Paper output | Upper tray: Supports both face-up and face-down output Lower tray: Face-down output only |
| Paper full detection | Both upper and lower tray |
| Offset function | Upper tray only (offset function not possible for 12" x 18", 5-1/2" x 8-1/2"R, A3W and A5R size paper) |
| Paper conveying | Center reference |

| | |
|----------------------------------|--|
| Name | Punch module |
| Hole punching | 3 or 2 holes |
| Allowed paper sizes for punching | 3 holes: 11" x 17", 8-1/2" x 11", A3, A4 2 holes: 8-1/2" x 14", 8-1/2" x 11"R |
| Power supply | Supplied from machine saddle stitch finisher |
| Dimensions | 3-3/4" (W) x 22-1/16" (D) x 6-45/64" (H) (95mm(W) x 560mm(D) x 170mm(H)) |
| Weight | Approximately 5.6lbs. (2.5kg) |

Specifications are subject to change for improvement without notice.

NOTES

- Transparency film, envelopes, postcards, and other special papers cannot be stapled.
- If mixed paper sizes are selected for stapling jobs, stapling will be automatically canceled.

Supplies

AR-SC2 staple cartridges must be used for this finisher.
The cartridge package contains three cartridges of approximately 5000 staples each.

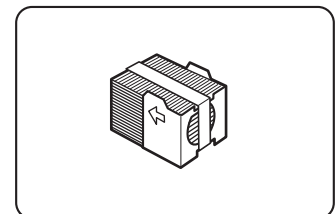

Saddle stitch finisher functions

Sort mode

Sorted sets will be delivered.

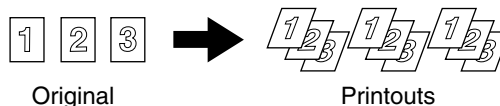

Group mode

Groups of copies of the same page will be delivered.

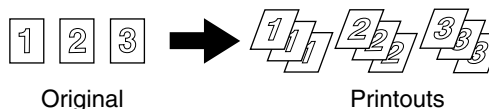

Offset mode

Offset mode

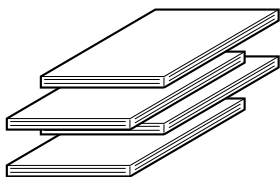

Non-offset mode

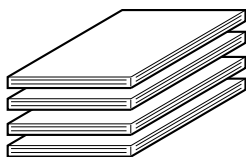

Sets will move from side to side so that each set or group will be offset from the previous set or group for easy separation.

(The offset function only operates in the offset tray.)

Stapled sets will not be offset.

Staple sort mode

Collated sets of prints or copies will be stapled and delivered to the offset tray. When saddle stitching is selected, the prints or copies will be stapled at the center and delivered to the saddle stitch tray. The stapling positions, orientation, paper size for stapling, and stapling capacity are shown below.

| Stapling positions | Portrait orientation | | Landscape orientation | |
|--|----------------------|--|-----------------------|---|
| Top left corner of printouts | | Available paper sizes: 8-1/2" x 11", A4 and B5 Stapling capacity: For each size, up to 30 sheets can be stapled | | Available paper sizes: 11" x 17", 8-1/2" x 14", 8-1/2" x 13", 8-1/2" x 11" R, A3, B4 and A4R Stapling capacity: Up to 30 sheets of 8-1/2" x 11"R or A4R paper can be stapled, up to 25 sheets of other paper sizes |
| Lower left corner of printouts | | Same as above | | Same as above |
| Center left two positions of printouts | | Same as above | | Same as above |
| Saddle stitch on centerfold line. | | Paper in the portrait direction cannot be saddle stitched. | | Available paper sizes: 11" x 17", 8-1/2" x 11"R, A3, B4, and A4R Stapling capacity: For each size, up to 10 sheets can be stapled |

■ Saddle stitch function

The saddle stitch finisher can automatically place two staples for centerline binding of prints or copies and fold them along the centerline.

<Example>

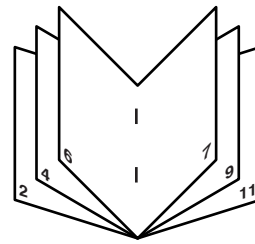

■ Hole punching (only if a punch module is installed)

If the saddle stitch finisher is equipped with a hole punch module, printed paper can be hole punched and delivered to the offset tray. Saddle stitching and hole punching cannot be selected at the same time. The automatic image rotation will not function when the hole punching function is used.

For the allowed paper sizes for punching, see the specifications on page 3-3.

When using the punch function in copy mode, place the original with the top toward the inside of the machine. If the original is not placed in this orientation, punching will not take place at the correct positions. (See "Standard original setting orientation" on page 4-7 of the copy section.)

<Example>

{Original 1}

{Punch positions}

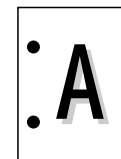
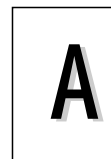

{Original 2}

{Punch positions}



Using the saddle stitch finisher

Touch the [Output] key on the main screen of copy mode to display the screen that allows selection of sort, staple sort, centerline stapling, group function, and the output tray.

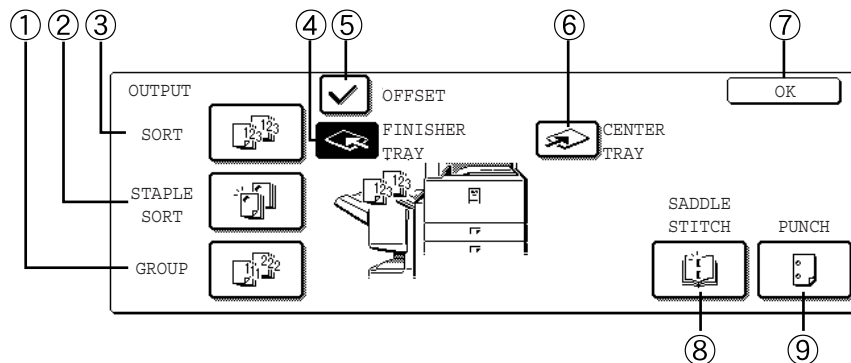

- ① **[GROUP] key (See page 3-4.)**
When Group is selected, all copies of the same original will be grouped.
- ② **[STAPLE SORT] key (See page 3-4.)**
When Staple Sort is selected, sorted sets will be stapled and delivered to the offset tray. (They will not be offset stacked.)
- ③ **[SORT] key (See page 3-4.)**
When Sort is selected, sets of copies will be sequentially delivered.
- ④ **[FINISHER TRAY] key (See page 3-2.)**
When the offset function is selected, output goes to the offset tray. (The offset tray is automatically selected when the staple sort function is turned on.)
- ⑤ **[OFFSET] key (See page 3-4.)**
The offset function operates when "Yes" is selected, and doesn't operate when "No" is selected. (The offset checkmark is automatically cleared when the staple sort function is turned on.)
- ⑥ **[CENTER TRAY] key**
If the center tray is selected, output paper will be delivered to the exit tray located above the main unit.
- ⑦ **[OK] key**
Touch to close the [OUTPUT] screen and to return to the main screen.
- ⑧ **[SADDLE STITCH] key (See page 3-5.)**
When saddle stitching is selected, the copies will be stapled at the center and delivered to the saddle stitch tray.
Touch this key to display the pamphlet copy setting screen (page 6-24). (This is only possible when a checkmark appears in the checkbox of the [AUTOMATIC SADDLE STITCH] key operator program (see page 12 of the Key operator's guide.))
- ⑨ **[PUNCH] key (See page 3-5.)**
If the saddle stitch finisher is equipped with a hole punch module, printed paper can be hole punched and delivered to the offset tray.
*When one of the functions is selected, it is highlighted.

Staple cartridge replacement and staple jam removal

When the staple cartridge becomes empty or staples become jammed, a message will appear in the message display of the operation panel.

Follow the procedure below to replace the staple cartridge or remove jammed staples.

■ Staple cartridge replacement

1 Open the front cover.

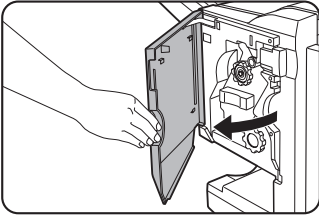

2 Pull out the stapler section.

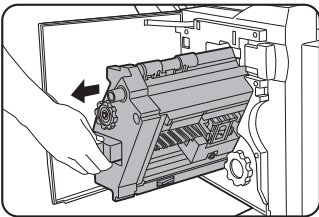

3 Turn roller rotating knob A in the direction of the arrow to move the staple unit to the front.

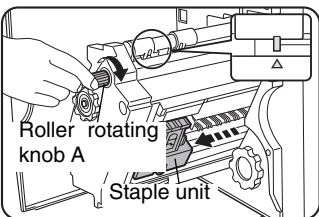

Turn the roller rotating knob until the triangle mark is aligned with the index.

4 Remove the empty staple box.

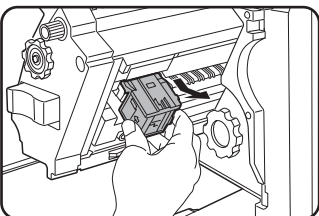

5 Remove the empty staple cartridge.

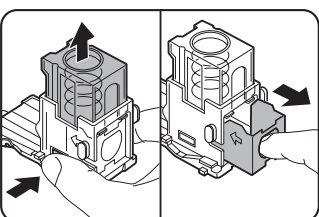

Press the lock button to unlock the staple box cover and remove the staple cartridge.

NOTE

If staples remain, the staple cartridge cannot be removed.

6 Insert a new staple cartridge into the staple box.

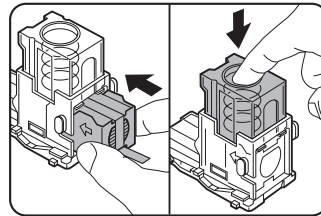

After inserting the staple cartridge, press down on the staple box cover to lock the cartridge in place.

NOTES

- Do not remove the tape from the cartridge before inserting the staple cartridge into the box.
- Make sure that the new staple cartridge is locked securely in the staple box. Press down on the staple box cover until you hear a "click" indicating that the staple cartridge is locked.

7 Remove the tape from the staple cartridge by pulling it straight.

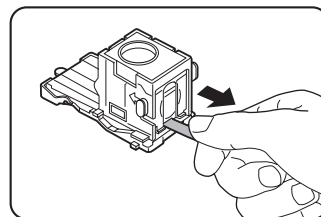

8 Insert the staple box.

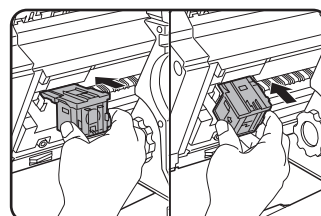

Push the staple box in until it clicks into place.

9 Push the stapler section back into the finisher.

10 Close the front cover.

NOTE

Make a test print or copy in the staple sort mode to ensure that stapling is performed properly.

■ Staple jam removal

1 Unlatch the saddle stitch finisher and slide it away from the main unit.

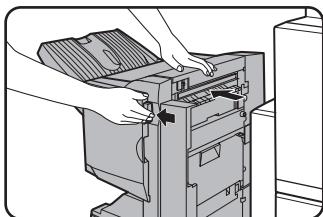

2 Open the front cover.

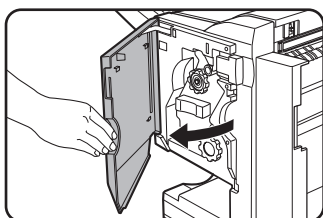

3 Turn roller rotating knob C as shown in the illustration until the blue indication is seen.

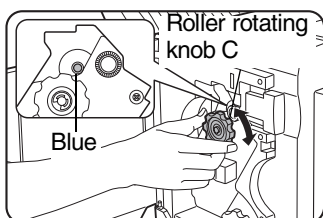

4 Remove the paper from the stapler compiler.

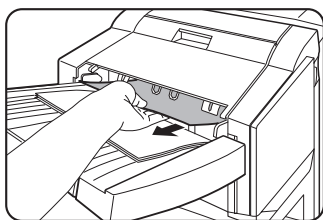

5 If saddle stitching was selected, open the saddle stitch section cover.

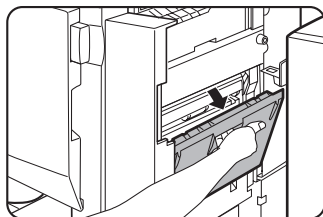

6 Remove the misfed paper.

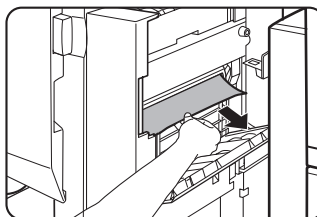

Be careful not to tear the misfed paper during removal.

7 Close the saddle stitch section cover.

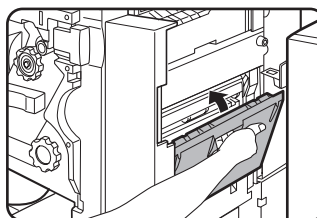

8 Pull out the stapler section.

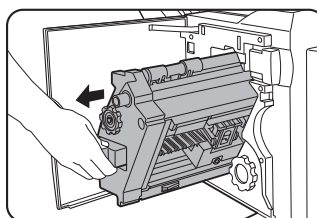

9 Turn roller rotating knob A in the direction of the arrow to move the staple unit to the front.

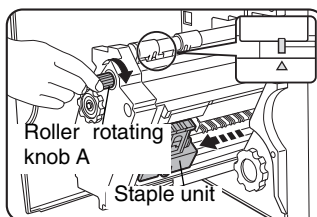

Turn the roller rotating knob until the triangle mark is aligned with the index.

10 Remove the staple box.

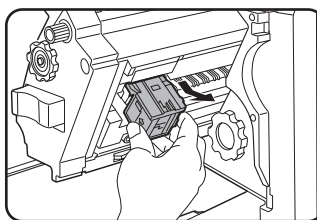

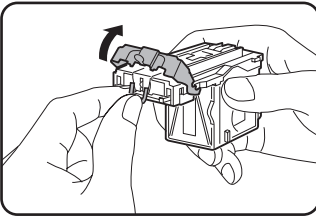
11 Raise the lever at the end of the staple box.

Remove the top staple if it is bent. If bent staples remain, a staple jam will occur again.

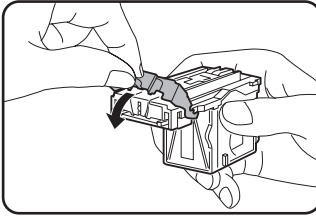
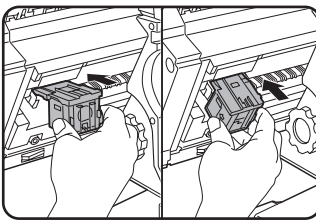
12 Return the lever to its original position.**13** Reinstall the staple box.

Push the staple box in until it clicks into place.

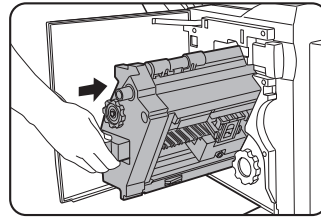
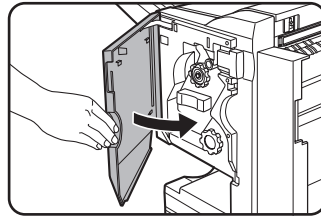
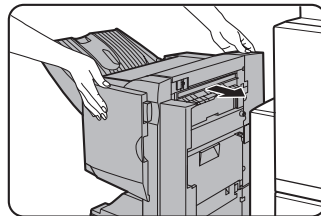
14 Push the stapler section back into the finisher.**15** Close the front cover.**16** Push the saddle stitch finisher back against the main unit.**NOTE**

Make a test print or copy in the staple sort mode to ensure that stapling is performed properly.

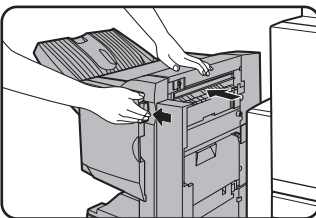
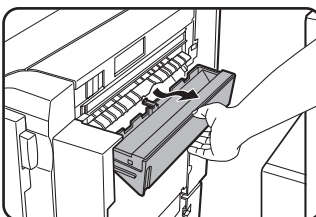
■ Disposal of hole punch scrap (when the punch unit is installed)**1** Unlatch the saddle stitch finisher and slide it away from the main unit.**2** Pull out the punch scrap collecting container and empty it.

Discard the punch scraps in a plastic bag or other container, taking care not to let the scraps scatter.

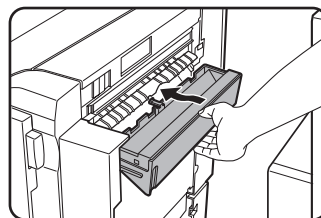
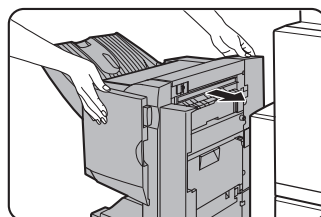
3 Return the punch scrap collecting container to its original position.**4** Push the saddle stitch finisher back against the main unit.

Misfeed in the saddle stitch finisher

When a misfeed occurs in the saddle stitch finisher, remove the misfed paper following the procedure below.

1 Unlatch the saddle stitch finisher and slide it away from the main unit.

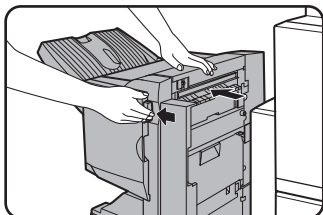

NOTE

The saddle stitch finisher and the machine are connected at the rear. Exercise caution when pulling them apart.

2 Remove the misfed paper from the main unit.

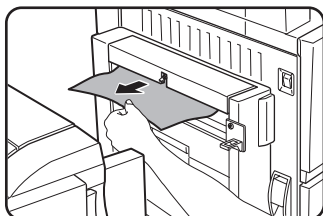

After removing the misfed paper, open and close the duplex bypass/inverter to reset the jam indicator. ("Misfeed in the Fusing area" step 1 or 4 on page 2-20)

3 If there was no misfed paper in step 2, pull roller rotating knob B on the punch unit towards you and rotate it. (Only when an optional punch unit is installed.)

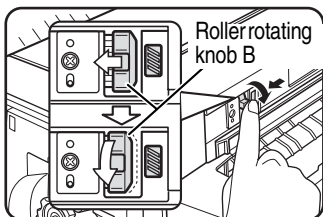

Rotating roller rotating knob B releases the caught paper.

4 Open the top cover.

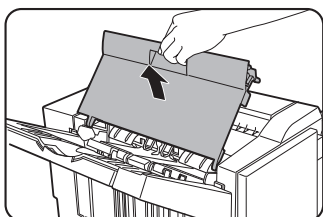

5 Remove the misfed paper.

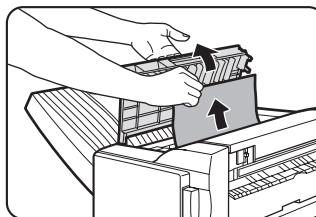

Remove the paper gently, taking care not to tear it.

6 Close the top cover.

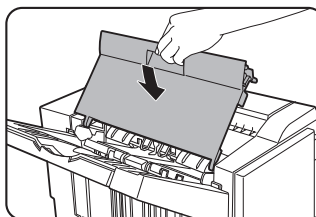

7 Remove the misfed paper from the stapler compiler.

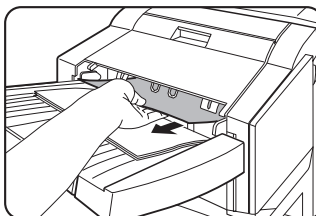

Be careful not to tear the misfed paper during removal.

8 Open the saddle stitch section cover.

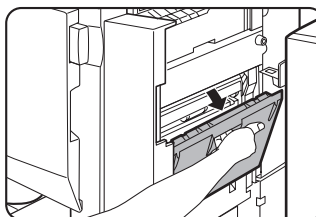

9 Remove the misfed paper.

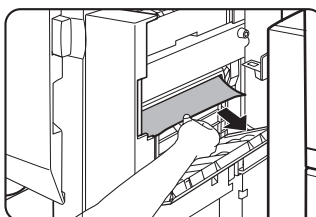

Be careful not to tear the misfed paper during removal.

10 Open the front cover.

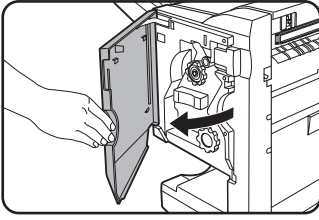

11 Turn roller rotating knob in the direction of the arrow.

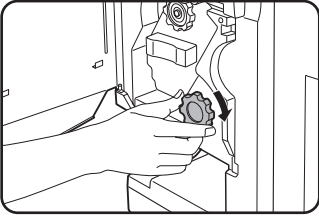

12 Remove any misfed paper from the saddle stitch tray.

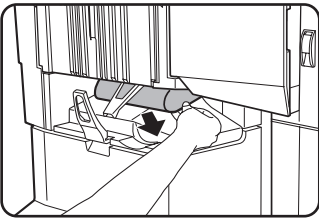

Be careful not to tear the misfed paper during removal.

13 Close the saddle stitch section cover.

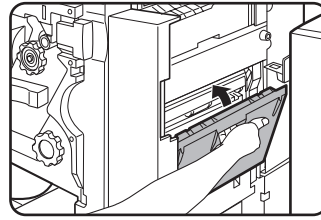

14 Close the front cover.

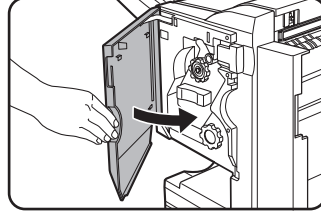

15 Push the saddle stitch finisher back against the main unit.

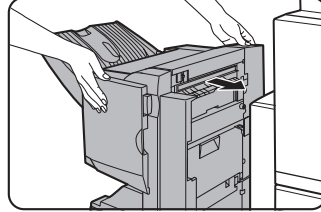

3

Troubleshooting saddle stitch finisher problems

Check the list below before calling for service.

| Problem | Check | Solution or cause |
|---|--|--|
| Stapling position is not correct (including saddle stitch). | Stapling position not set properly? | Check the stapling position setting. (See pages 3-4, 3-13 and 3-14.) |
| The saddle stitch finisher does not operate. | Are any saddle stitch finisher covers open? | Close all covers. (See page 3-10 and 3-11.) |
| | Message indicating need to remove paper from the stapler compiler displayed? | Remove all remaining paper from the stapler compiler referring to step 4 on page 3-8. |
| Stapling cannot be performed (including saddle stitch). | Message to check the staple unit displayed? | Remove jammed staples. (See page 3-8.) |
| | Message to add staples displayed? | Replace the staple cartridge. (See page 3-7.) Check that a staple cartridge has been installed. (See page 3-7.) |
| | Different size paper included? | Stapling cannot be performed onto different size paper. |
| | Is the paper badly curled, preventing stapling? | Differences in paper quality and type may result in bad curling of output paper. Take the paper out of the tray or bypass tray, turn it around, and reload it so that the top and bottom edges are reversed. |
| The punch hole positions are not correct* ¹ | The punch function is not set to the correct punch positions. | Check the allowed hole punch positions. (See page 3-5.) |
| Cannot be punched.* | Message to check the punch module displayed? | Dispose of punch scraps. (See page 3-9.) |
| | Mixed paper sizes? | Punching is not possible when different paper sizes are mixed together. |
| | Paper is badly curled and the output paper is not punched. | Differences in paper quality and type may result in bad curling of output paper. Take the paper out of the tray or bypass tray, turn it around, and reload it so that the top and bottom edges are reversed. |

* When a hole punch module is installed









Stapling position quick reference guide for duplex output

The orientation of the copy paper, original, scanned original data, and binding position selection are all interrelated. The table below shows these relationships.

| | | Orientation of original or original data | | | Output result | |
|--------------------------------|---------------|--|--------|--------------------------|---------------------------|--|
| | | Page 1 | Page 2 | Page 1 & Page 2 Duplexed | | |
| Portrait orientation printing | Left binding | | | | One-position stapling | Two-position stapling |
| | | | | | | Two-position stapling along the shorter edge is not possible. |
| | Top binding | | | | One-position stapling | Two-position stapling Top binding with two-position stapling is not possible. |
| | | | | | | |
| | Right binding | | | | One-position stapling | Two-position stapling |
| | | | | | | Two-position stapling along the shorter edge is not possible. |
| Landscape orientation printing | Left binding | | | | One-position stapling | Left binding with two-position stapling is not possible. |
| | | | | | | |
| | Top binding | | | | One-position stapling | Two-position stapling |
| | | | | | | Two-position stapling along the shorter edge is not possible. |
| | Right binding | | | | One-position stapling | Right binding with two-position stapling is not possible. |
| | | | | | | |

Relation between print image and saddle stitch

The orientation of the copy paper, original, scanned original data, and binding position selection are all interrelated. The table below shows these relationships.

| | | Orientation of original or original data | | | Output result |
|--------------------------------|---------------|---|---|---|--|
| Portrait orientation printing | Left binding | Page 1  | Page 2  | Page 1 & Page 2 Duplexed  |  |
| | Right binding | Same as above | | | |
| Landscape orientation printing | Left binding | Page 1  | Page 2  | Page 1 & Page 2 Duplexed  |  |
| | Right binding | Same as above | | | |

LARGE CAPACITY TRAY

The large capacity tray can hold approximately 3,500 sheets (21 lbs. (80 g/m²)) of 8-1/2" x 11" (A4) size paper. (For the types of paper that can be loaded in the large capacity tray, see "Large Capacity tray" in the tray specifications (page 2-9).)

Part name

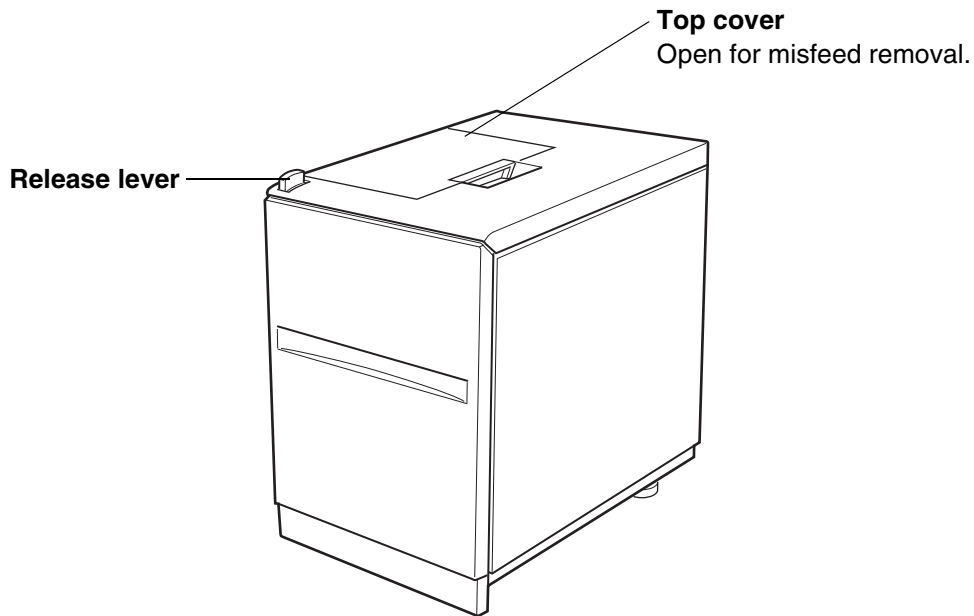

3

NOTES

- Do not place heavy objects on the large capacity tray or press down hard on the tray.
- To install the large capacity tray, the optional duplex module/2 x 500 sheet paper drawer or the stand/3 x 500 sheet paper drawer must also be installed.

Specifications

| | |
|---|--|
| Name | LARGE CAPACITY TRAY (AR-LC8) |
| Paper size | 8-1/2" x 11" (A4) |
| Paper weight | 17 to 28 lbs. (64 to 105 g/m ²) |
| Number of trays | 1 tray |
| Paper capacity | 3,500 sheets (21 lbs. or 80 g/m ²) |
| Power supply | Supplied from machine |
| Dimensions | 14-13/16" (W) x 21-15/32" (D) x 23-7/16" (H) (376 mm (W) x 545 mm (D) x 595 mm (H)) |
| Weight* | Approximately 66.2 lbs. (30kg) *without mounting kit |
| Overall dimensions when attached to machine | 38-7/16" (W) x 26-5/8" (D) (976 mm (W) x 676 mm (D)) |

Specifications are subject to change for improvement without notice.

Loading paper in the large capacity tray

1 Pull the tray out until it stops.

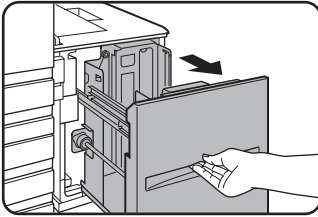

When the tray is in operation, do not use excessive force to pull the tray out. This may damage the tray.

3 Push the tray firmly all the way into the machine.

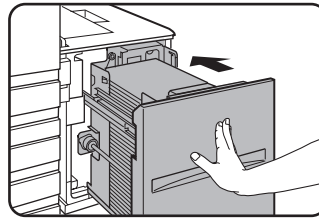

The paper table will automatically rise to the paper feed position.

2 Place the paper in the center of the paper table.

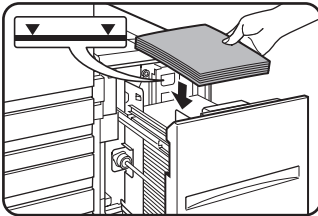

The paper stack must not be higher than the indicator line (up to 3,500 sheets of SHARP standard paper (21 lbs. (80 g/m²))

If the paper type was changed, be sure to change the appropriate settings as explained in "Setting the paper type (except the bypass tray)" (See page 2-11).

Misfeed in the large capacity tray

When a misfeed occurs in the large capacity tray, remove the misfed paper, following the procedure below.

- 1** While holding the tray release lever, carefully slide the large capacity tray away from the main unit until it stops.

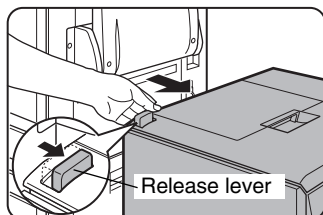

- 2** Remove any misfed paper from the main unit and the large capacity tray.

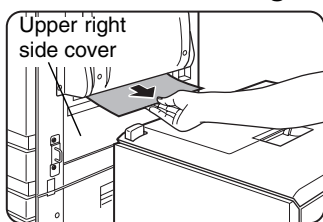

If the misfed paper is stuck inside the machine and cannot be removed, open the side cover and then remove the misfed paper. (See "Misfeed in the transport area, fusing area, and exit area" on page 2-20.)

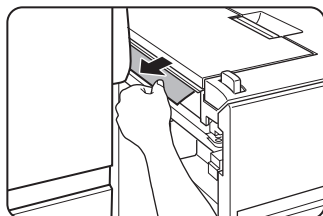

- 3** Open the top cover.

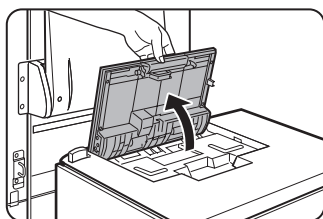

- 4** Remove the misfed paper.

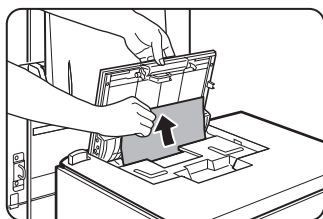

Be sure not to tear the misfed paper during removal.

After removing the misfed paper, close the top cover.

- 5** Push the large capacity tray towards the main unit and latch it into place.

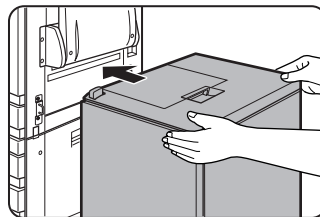

Gently push the large capacity tray back in until it stops.

- 6** If misfed paper is not found in step 2, pull the tray out.

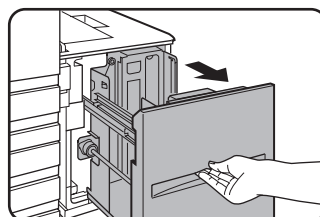

- 7** Remove the misfed paper.

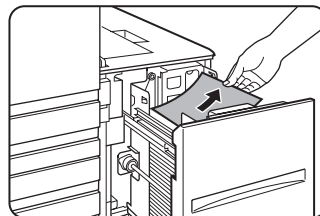

- 8** Gently push the tray back into place.

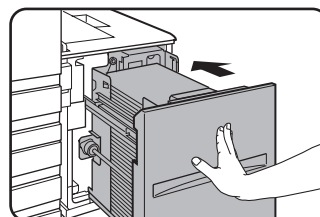

The paper feed table automatically rises to the paper feed position. Make sure that the paper misfeed screen is cleared and the normal message screen appears.

Part 2: Copier Operation

CHAPTER 4

BEFORE MAKING COPIES

This chapter provides basic information necessary for using the copier functions of the machine. Please read this chapter before making copies.

| | Page |
|---|------|
| PART NAMES AND FUNCTIONS (The Reversing Automatic Document Feeder) | 4-2 |
| • Exterior..... | 4-2 |
| • Operation Panel..... | 4-3 |
| • Touch Panel (main screen of copy mode) | 4-4 |
| REVERSING AUTOMATIC DOCUMENT FEEDER | 4-5 |
| • Acceptable originals..... | 4-5 |
| SETTING ORIGINALS..... | 4-6 |
| SELECTING THE ORIGINAL SIZE | 4-8 |
| STORING, DELETING, AND USING ORIGINAL SIZES | 4-9 |

PART NAMES AND FUNCTIONS (The Reversing Automatic Document Feeder)

Exterior

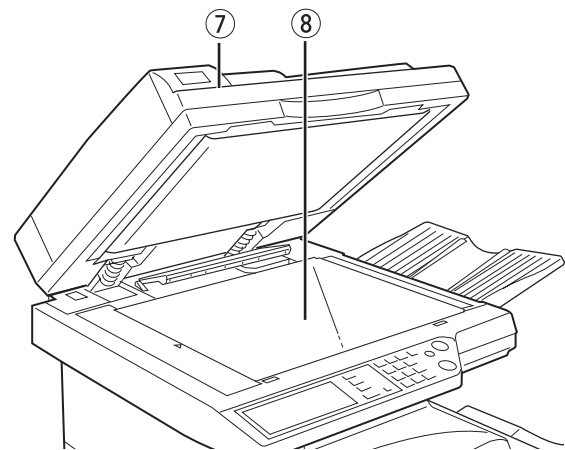
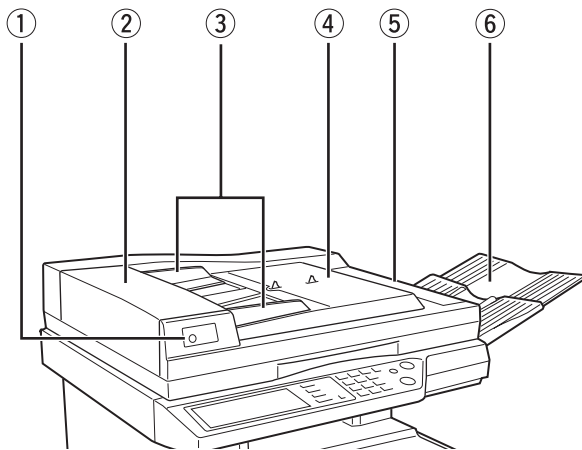

① [] **Original reminder (page 4-6)**

Indicates an original is still on the document glass.

② **Document feeding area cover (page 7-2)**

Open to remove misfed originals in this area.

③ **Original guides (page 4-6)**

Adjust to the size of the originals.

④ **Document feeder tray (page 4-6)**

Set the originals here for automatic feeding.

⑤ ***RADF exit area cover (page 7-2)**

Open to remove misfed originals.

⑥ ***RADF exit area**

Finished originals are output here.

⑦ **Document cover**

⑧ **Document glass**

All originals which cannot be copied from the document feeder tray must be copied here.

* "RADF" is an acronym for "Reversing Automatic Document Feeder".

Operation Panel

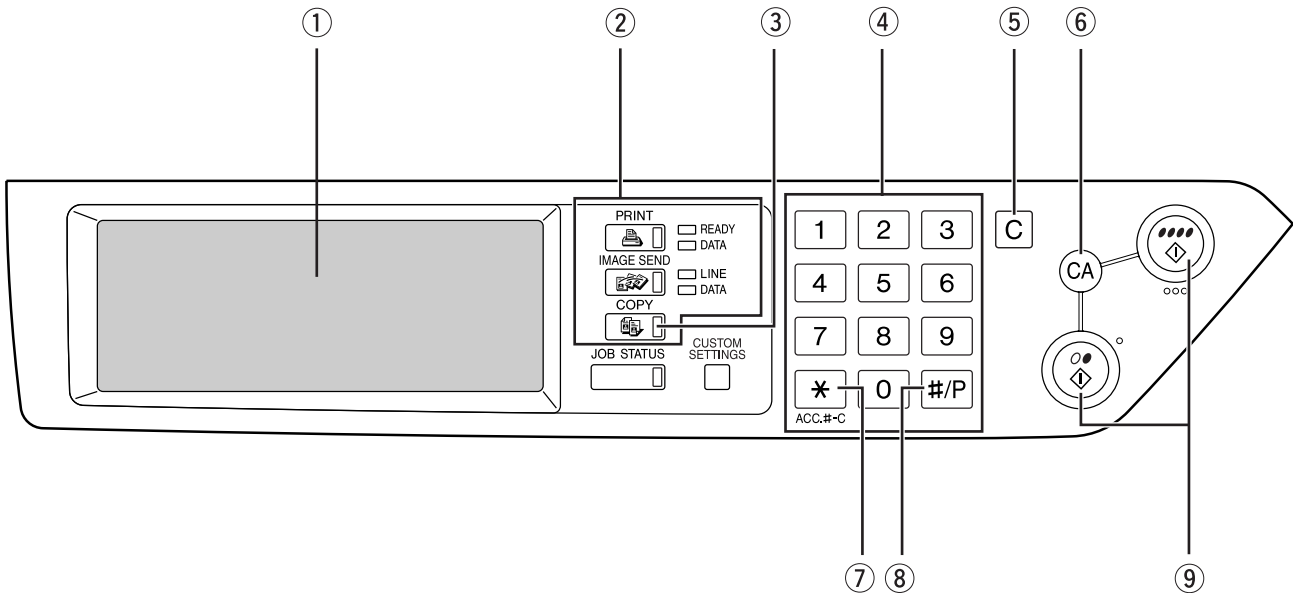

① Touch panel (Details are on the next page 4-4)

Messages and touch keys are displayed here. Selections are made by touching the displayed keys. Selections made with the keys are confirmed by a "beep"* that is sounded when a key is touched, and highlighting of the selection key.

* If a key that cannot be selected is touched, double-beep will sound.

Keys that are grayed out cannot be selected.

② Mode select keys

Use to change modes and the corresponding display on the touch panel.

③ [COPY] key

Press to select the copy mode and display the main screen of the copy mode. (next page 4-4)

If this key is pressed and held while the main screen of the copy mode is displayed, the total output count will be displayed.

④ Numeric keys

Use to select the number of copies and to make numerical entries for setting operations.

⑤ [C] key (clear key)

Press to clear a copy quantity entry. If this key is pressed while the reversing automatic document feeder is being used, any originals in progress will be automatically output.

⑥ [CA] key (clear all key)

This returns all copy mode settings to the default settings. However, the touch panel display mode will not be changed.

When beginning a copy job, press this key.

⑦ [*] key ([ACC.#-C] key)

If the auditing mode has been set, press this key to close an open account after finishing a copy job. For setting of the auditing mode, see page 1-11.

⑧ [#/P] key (page 6-25)

Press to select the job memory mode.

⑨ [START] key

When the indicator is lit, a copying job can be started. Press to start copying.

● [COLOR COPY START (●●●●)] key

Press this key to start a single or multiple color copy job.

● [BLACK COPY START (○●)] key

Press this key to start a black and white copy job.

Touch Panel (main screen of copy mode)

The main screen of copy mode shows messages and keys necessary for copying and settings that can be selected. Touch a key to make a selection. The main screen of the copy mode will be displayed when the [COPY] key is pressed.*

* Except when the custom settings screen is displayed.

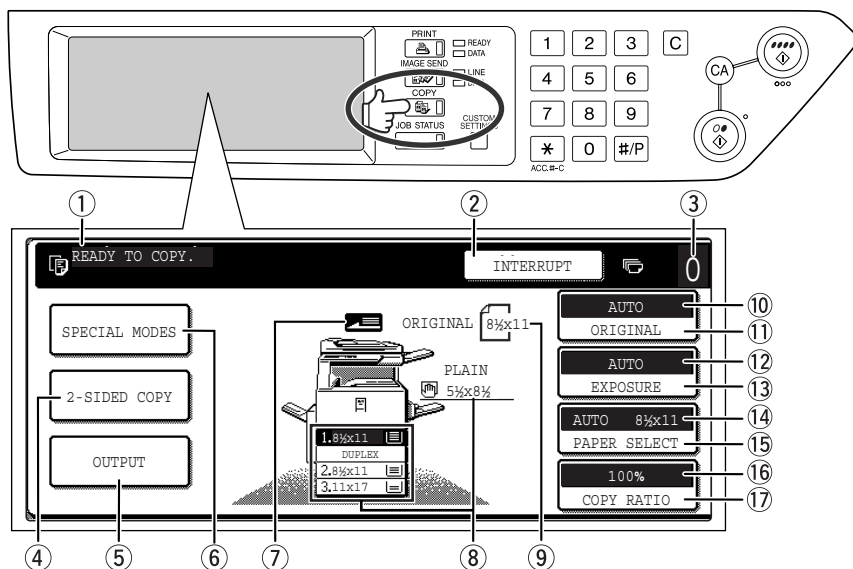

The screen at left shows the machine with the duplex module/2 x 500 sheet paper drawer and the duplex bypass/inverter unit installed. The image will vary depending on the equipment installed.

① Message display

Basic status messages are displayed here.

② [INTERRUPT] key display area

When interrupt copy is available, the [INTERRUPT] key will be displayed here. When an interrupt copy job is being run, a [CANCEL] key will be displayed here to be used for canceling the interrupt copy job.

③ Copy quantity display

Displays the selected number of copies before the [START] key is pressed or the number of remaining copies after the [START] key is pressed. A single copy can be made when "0" displayed.

④ [2-SIDED COPY] key (page 5-6, 5-9)

Touch to display the duplex copy mode setting screen.

⑤ [OUTPUT] key (page 5-3, 5-8)

Touch to select sort, group, and staple sort.

⑥ [SPECIAL MODES] key (page 6-2)

Touch to display the special modes selection screen.

⑦ Original feed display

This lights steadily when an original is placed on the original table of the reversing automatic document feeder. When "Stream feeding mode" in the key operator programs is turned on, the display blinks during the waiting period (about 5 seconds) for placement of the next original. (See page 12 of the key operator's guide.)

⑧ Paper size display

The display shows the location of the paper trays, the size of the paper in the trays and the approximate amount of paper loaded in each tray. The approximate amount of paper in a tray is indicated by .

⑨ Original size display

Displays the original size only when an original is placed for copying.

⑩ Original display

"AUTO" appears when the automatic original size detection function is operating, and the original size appears when the original size has been entered manually.

⑪ [ORIGINAL] key

Use this key to manually enter the original size.

⑫ Exposure display

Displays the icon of the selected resolution and the exposure scale.

⑬ [EXPOSURE] key (page 5-10)

Use this key to adjust the copy exposure.

⑭ Paper select display

Displays the selected paper size. When the auto paper select mode has been selected, "AUTO" will be displayed.

⑮ [PAPER SELECT] key (page 5-2, 5-7)

Use this key to select the paper size.

⑯ Copy ratio display

Displays the selected copy ratio.

⑰ [COPY RATIO] key (page 5-13)

Use this key to select the copy ratio.

REVERSING AUTOMATIC DOCUMENT FEEDER

The reversing automatic document feeder can be used to automatically feed originals for continuous copying. Both sides of two-sided sheet originals can be scanned without having to manually turn the originals over. This feature is convenient for making copies of a large number of originals.

Acceptable originals

A stack of up to 100 original sheets (8-1/2" x 11" (A4) size, 21 lbs. (80 g/m²)) of the same size paper can be set in the document feeder tray. Originals of mixed size can be set if the width of the originals is the same.

■ Size and weight of acceptable originals

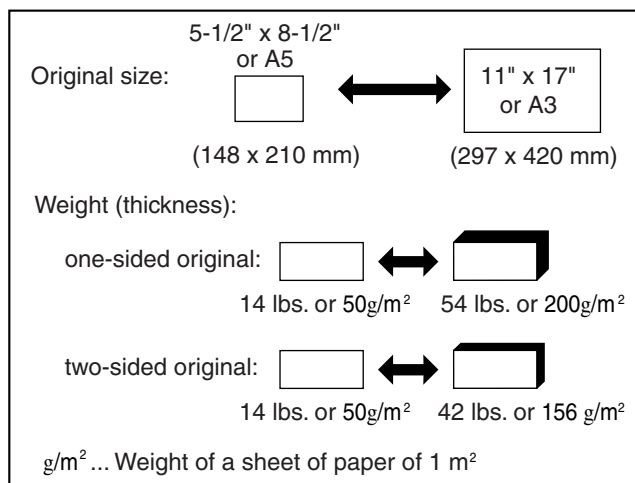

■ Total number of originals that can be set in the document feeder tray

- 100 pages (8-1/2" x 11" (A4) size originals weighing 21 lbs. (80 g/m²)) (For originals heavier than 21 lbs. (80 g/m²), the maximum stack thickness is 13/32" (10 mm).)
- 60 pages (8-1/2" x 14" (B4) size or larger originals weighing 21 lbs. (80 g/m²)) (For originals heavier than 21 lbs. (80 g/m²), the maximum stack thickness is 64" (6 mm).)

Notes on use of the reversing automatic document feeder

- Use originals within the specified size and weight ranges. Use of originals out of the specified range may cause an original misfeed.
- Before loading originals into the document feeder tray, be sure to remove any staples or paper clips.
- If originals have damp spots from correction fluid, ink or glue from pasteups, be sure they are dried before they are fed. If not, the interior of the document feeder or the document glass may be soiled.
- To prevent incorrect original size detection, original misfeeds or smudges on copies, use the following as a guide for feeding originals.

Transparency film, tracing paper, carbon paper, thermal paper or originals printed with thermal transfer ink ribbon should not be fed through the document feeder. Originals to be fed through the feeder should not be damaged, crumpled or folded or have loosely pasted paper on them or cutouts in them. Originals with multiple punched holes other than two-hole or three-hole punched paper may not feed correctly.

- When using originals with two or three holes, place them so that the punched edge is at a position other than the feed slot.

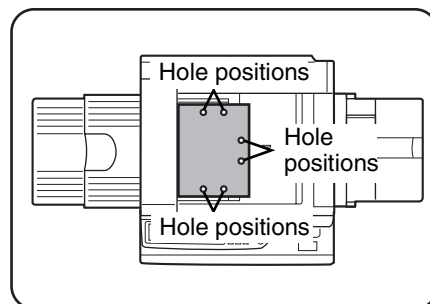

SETTING ORIGINALS

■ When using the reversing automatic document feeder

- 1 Open the document cover, make sure that an original has not been left on the document glass, and then gently close the document cover.

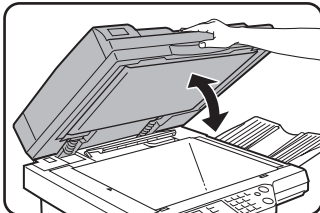

If an original is left on the document glass, the original reminder indicator (⏏) will blink. Remove the original from the document glass.

- 2 Adjust the original guides to the size of the originals.

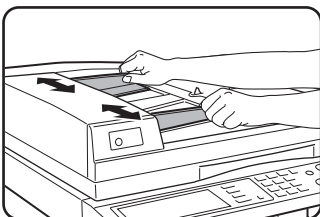

- 3 Place the originals face up in the document feeder tray.

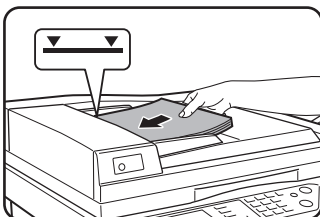

Set the originals all the way into the feed slot. Do not exceed the maximum height line marked on the original guide.

■ When using the document glass

Open the document cover, place the original face down on the document glass, and then gently close the document cover.

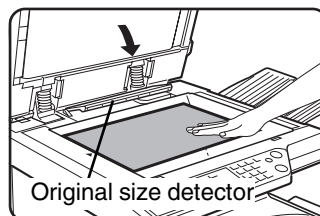

NOTE

Do not place any objects under the original size detector, because they may damage it or the original size may not be detected properly.

[How to place the original]

Place the original in the appropriate position shown below according to its size. (▶ Center the original on the centering scale.)

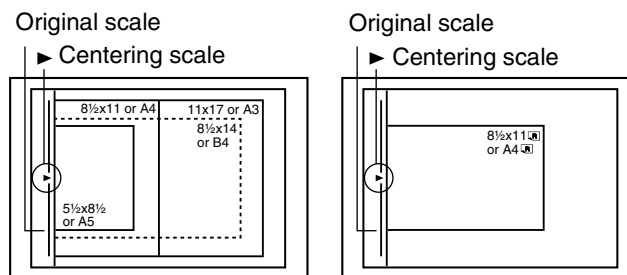

NOTE

Original size detection function

One of the four groups of standard original sizes shown below can be selected for detection by the original size detection function. The factory default setting is "INCH-1 (AB-1)". The setting can be changed using "ORIGINAL SIZE DETECTOR SETTING" in the key operator programs. (Page 11 of the key operator's guide.)

| Group | Detectable original sizes | |
|------------|---|---------------------------------------|
| | Document feeder tray (for reversing automatic document feeding) | Document glass |
| 1 INCH - 1 | 11" x 17", 8-1/2" x 14", 8-1/2" x 11", 8-1/2" x 11"R, 5-1/2" x 8-1/2" | A3, B4, A4, B5, B5R |
| 2 INCH - 2 | 11" x 17", 8-1/2" x 13", 8-1/2" x 11", 8-1/2" x 11"R, 5-1/2" x 8-1/2" | A3, B4, A4, B5, B5R |
| 3 AB - 1 | A3, A4, A4R, A5, B4, B5, B5R | 11" x 17", 8-1/2" x 14", 8-1/2" x 11" |
| 4 AB - 2 | A3, A4, A4R, A5, B5, B5R, 8-1/2" x 13" | 11" x 17", 8-1/2" x 11", B4 |

■ Standard original setting orientation

[Example 1]

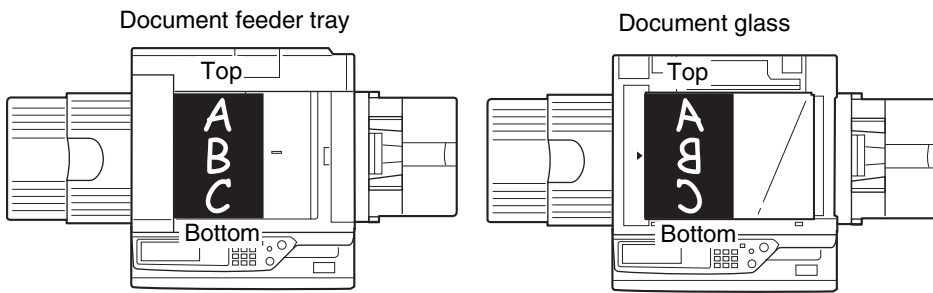

Place originals in the document feeder tray or on the document glass so that the top and bottom of the original is positioned as shown in the illustration. If not, staples will be incorrectly positioned and some special features may not give the expected result.

[Example 2]

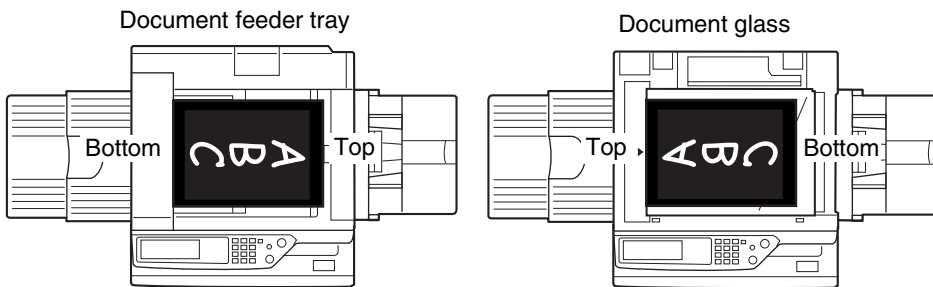

* When the original is placed as shown in example 2 and stapling is to be performed, orient the top of the original as shown below.

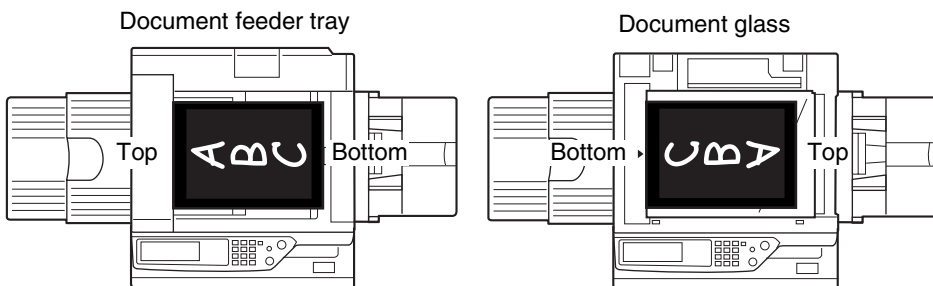

■ Automatic copy image rotation - rotation copying

If the orientation of the originals and copy paper are different, the original image will be automatically rotated 90° and copied. (When an image is rotated, a message will be displayed.) If a function is selected that is not suitable for rotation, such as enlarging the copy to greater than 8-1/2" x 11" (A4) size or staple sorting with the saddle stitch finisher, rotation will not be possible.

[Example]

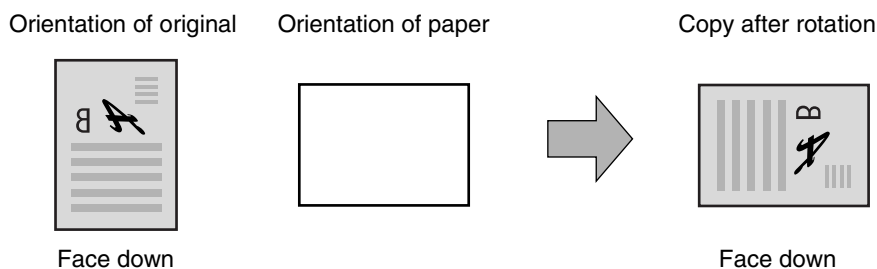

● This function operates in both the auto paper select or auto image mode. (Rotation copying can be disabled with a key operator program. See page 15 of the key operator's guide.)

SELECTING THE ORIGINAL SIZE

When the correct original size is not detected or the original size is not displayed, you can manually specify the original size.

By causing the machine to recognize the original size, you can have the automatic ratio selection function (page 5-12) automatically set a suitable enlargement or reduction ratio for the selected paper size.

Place the original in the document feeder tray or on the document glass and then follow the steps below.

1 Touch the [ORIGINAL] key.

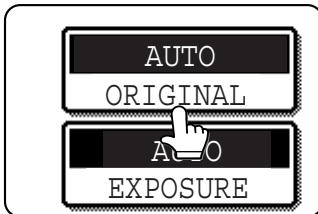

2 Enter the original size.

If the original size is a standard size, touch the appropriate original size key.

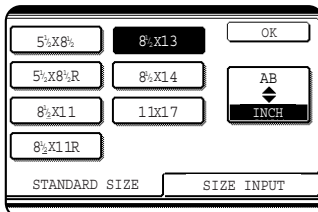

[MANUAL] and the original size key you touched are highlighted.

If you wish to select an AB size, touch the [AB/INCH] key and then touch the desired original size key.

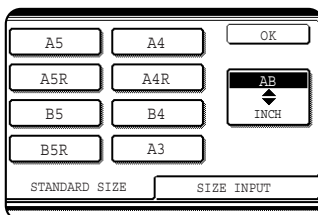

[AB] is highlighted and AB size keys are displayed. To return to the INCH palette, touch the [AB/INCH] key once again.

If the original size is a non-standard size, touch the [SIZE INPUT] tab and then enter the X (width) and Y (length) dimensions of the original with the \uparrow or \downarrow key.

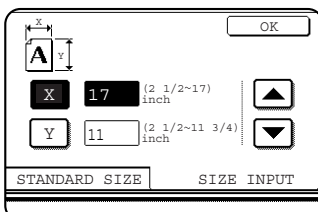

The X dimension (width) is initially selected. Touch the Y (\downarrow) key and enter the Y dimension (length).

The range of original sizes that can be entered is as follows.

| | Using the reversing automatic document feeder | Using the document glass |
|--------------------------|---|-------------------------------------|
| X (horizontal direction) | 5-1/2" to 17" (139 to 432 mm) | 2-1/2" to 17" (64 to 432 mm) |
| Y (vertical direction) | 4" to 11-3/4" (100 to 297 mm) | 2-1/2" to 11-3/4" (64 to 297 mm) |

3 Touch the [OK] key.

You will return to the initial screen.

4 The selected original size appears in the top half of the [ORIGINAL] key.

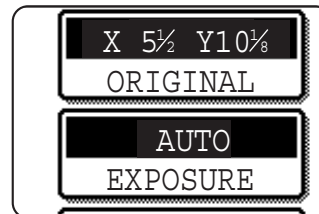

STORING, DELETING, AND USING ORIGINAL SIZES

Up to 9 special original sizes can be stored. Stored sizes can be easily called up and are not erased if the power is turned off. Storing a frequently used original size saves you the trouble of manually setting the size each time you copy that size of document.

- To cancel an original size storing, using, or deleting operation, press the [CA] key or touch the [ORIGINAL] key on the screen.

Storing or deleting an original size

1 Touch the [ORIGINAL] key.

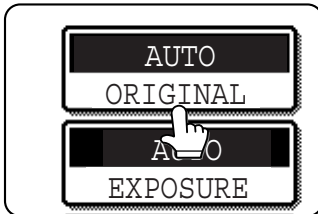

2 Touch the [CUSTOM SIZE] key.

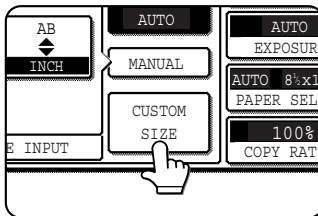

3 Touch the [STORE/DELETE] key.

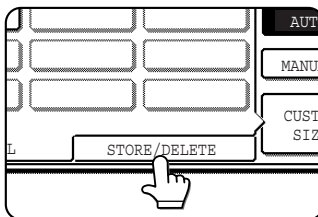

4 Touch the original size key () that you wish to store or delete.

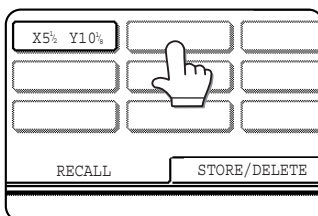

To store an original size, touch a key that does not show a size ().

Keys that already have an original size stored will show the stored size (X5% Y10%).

To delete or change a stored size, touch the key that shows the size that you wish to delete or change.

- If you are storing an original size, go to step 5.
- To delete or change an original size, go to step 7.

5 Enter the X (width) and Y (length) dimensions of the original with the \uparrow \downarrow keys.

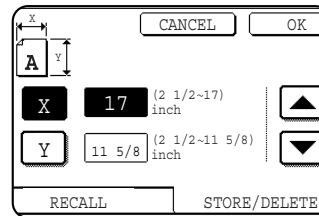

X (width) is initially selected.

Enter X and then touch the (Y) key to enter Y. A width of 2-1/2 to 17 inches can be entered in X, and a length of 2-1/2 to 11-5/8 inches can be entered in Y.

6 Touch the [OK] key.

The original size entered in step 5 is stored in the key selected in step 4.

To exit, touch the [ORIGINAL] key.

7 When you touch a key that shows an original size in step 4, a message screen appears that contains the keys [CANCEL], [DELETE], and [STORE].

- To cancel the procedure, touch the [CANCEL] key.
- To delete the selected original size, touch the [DELETE] key.
- To change the original size stored in the key, touch the [STORE] key. The screen of step 5 will appear to let you change the size.

8 To exit, touch the [ORIGINAL] key.

■ USING A STORED ORIGINAL SIZE

1 Follow steps 1 to 2 of "STORING OR DELETING AN ORIGINAL SIZE".

2 Touch the original size key that you wish to use.

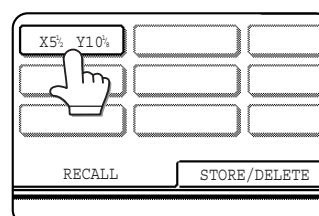

3 Touch the [OK] key.

The stored original size is called up.

CHAPTER 5

BASIC PROCEDURE FOR MAKING COPIES

This chapter explains the procedures for using basic copy functions, including making normal copies and enlarging/reducing copies.

| | Page |
|--|------|
| NORMAL COPYING | 5-2 |
| • Copying from the reversing automatic document feeder | 5-2 |
| • Automatic two-sided copying from the reversing automatic document feeder ... | 5-6 |
| • Copying from the document glass | 5-7 |
| • Automatic two-sided copying from the document glass | 5-9 |
| EXPOSURE ADJUSTMENTS | 5-10 |
| REDUCTION/ENLARGEMENT/ZOOM | 5-12 |
| • Automatic selection (auto image)..... | 5-12 |
| • Manual selection | 5-13 |
| • XY ZOOM | 5-15 |
| SPECIAL PAPERS | 5-17 |

NORMAL COPYING

This section describes the normal copying procedure.

Copying from the reversing automatic document feeder

NOTE

Certain restrictions exist depending on the amount of memory installed and the copy settings. (See "Copy mode output restrictions" and "Guidelines for the number of scannable originals during sort copying" on page 5-4.)

■ 1-sided copies of 1-sided originals

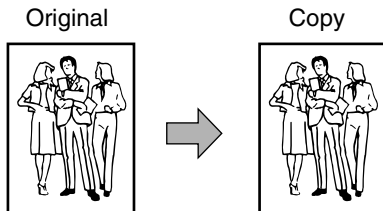

- 1 Place the originals in the document feeder tray. (pages 4-6 to 4-9)

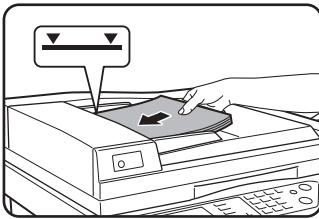

- 2 Ensure that the 1-sided to 1-sided copy mode is selected.

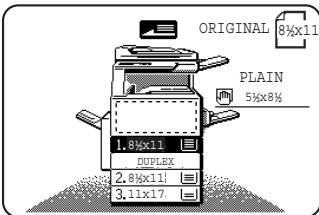

The one-sided to one-sided mode is selected when no icon for a two-sided mode appears in the dashed area on the display. If the 1-sided to 1-sided copy mode is already selected, steps 3 to 5 are not needed.

- 3 Touch the [2-SIDED COPY] key.

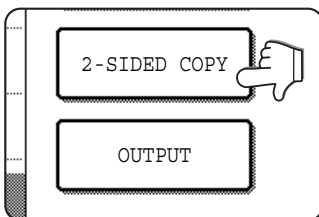

- 4 Touch the [1-sided to 1-sided copy] key.

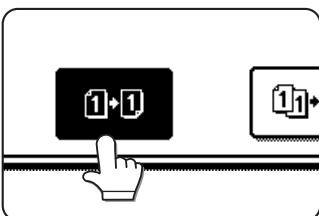

It may happen that a mode other than [1-sided to 1-sided copy] is selected, thus [1-sided to 1-sided copy] should be selected again. (Touch the [1-sided to 1-sided copy] key so that it is highlighted.)

- 5 Touch the [OK] key.

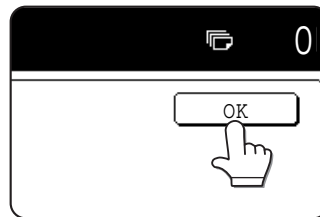

- 6 Ensure that paper of the same size as the originals is automatically selected. (*Note)

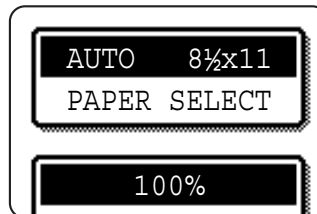

The selected tray will be highlighted or the message "LOAD xxxxxx PAPER." will appear. If the message appears, load paper in a paper tray with paper of the required size.

Even if the message above is displayed, copying can be performed onto the currently selected paper.

(*Note) The following requirements must be satisfied.

Originals of a standard size (11" x 17", 8-1/2" x 14", 8-1/2" x 11", 8-1/2" x 11"R or 5-1/2" x 8-1/2" (A3, B4, A4, A4R, B5, B5R or A5)) are set and the auto paper select function is enabled.

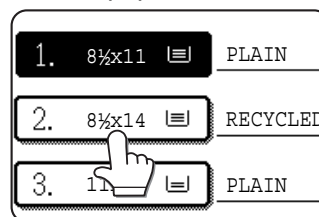

If originals of a size other than the sizes above are to be copied, manually select the desired paper size by touching the [PAPER SELECT] key and then touching the desired paper size selection key.

The selected key will be highlighted and the paper selection screen will close. To close the paper selection screen without making a selection, touch the [PAPER SELECT] key.

7 Select the desired output mode (see page 5-5).

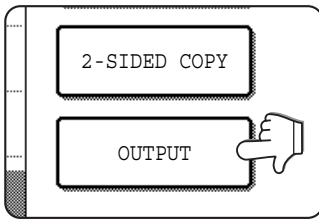

The sort mode is the default mode. To select the group mode, touch the [OUTPUT] key, then touch the [GROUP] key on the output setting screen, and then touch the [OK] key on the setting screen.

8 Use the numeric keys to set the desired number of copies.

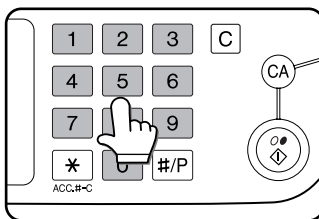

Up to 999 can be set. If you are only making a single copy, the copy can be made with the copy number display showing "0". Use the [C] (clear) key to cancel an entry if a mistake has been made.

9 Press the [COLOR COPY START (●●●●)] or [BLACK COPY START (○●)] key.

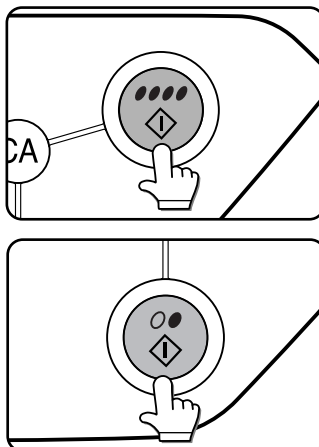

If the [C] key is pressed while originals are being scanned, scanning will stop. If copying had already started, copying and scanning will stop after the original in progress is output to the original exit area. In these cases the copy quantity will be reset to "0".

NOTE

The 1-sided to 1-sided copying mode is set as the default in the initial settings. If the default setting has not been changed using the "Initial status settings" program (key operator program), steps 3 to 5 on page 5-2 can be omitted.

Copy mode output restrictions

| | | | No added memory | | Memory added (128 MB or 256 MB) | |
|-----------------------------|-------------------------|----------------------------------|-----------------|-------|------------------------------------|-------|
| Two-sided copying mode | Output mode | original/paper size | Sort | Group | Sort | Group |
| One-sided copying | Color copying | Up to 11" x 17" (A3) | ○ | | | |
| | | 12" x 18" (A3W)* | ○ | | | |
| | Black and white copying | Up to 11" x 17" (A3) | ○ | | | |
| | | 12" x 18" (A3W)* | ○ | | | |
| Automatic two-sided copying | Color copying | Up to 8-1/2" x 11" (A4) | ○ | | | |
| | | 8-1/2" x 14", 11" x 17" (B4, A3) | ○ | × | ○ | |
| | | 12" x 18" (A3W)* | × | | | |
| | Black and white copying | Up to 11" x 17" (A3) | ○ | | | |
| | | 12" x 18" (A3W)* | × | | | |





○: Copying possible using selected settings ×: Copying not possible

* The reversing automatic document feeder cannot be used to copy an 12" x 18" (A3W) size original.

Guidelines for the number of scannable originals during sort copying

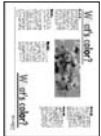
When using sort copy mode, the number of pages shown in the table below will all be scanned into memory and the set number of copies made.

(Note that the numbers shown below are general guidelines. The actual number of original pages that can be scanned into memory will vary depending on the content of the originals.)

| Output mode | Original type | Original size | No added memory | Added memory | |
|-------------------------|---|----------------------------------|-----------------|--------------|--------|
| | | | | 128 MB | 256 MB |
| Color copying | Full color original (mostly text)  | Up to 8-1/2" x 11" (A4) | 100 | 180 | |
| | | 8-1/2" x 14", 11" x 17" (B4, A3) | 50 | 90 | |
| | | 12" x 18" (A3W) | 41 | 74 | |
| | Full color original (text and photos)  | Up to 8-1/2" x 11" (A4) | 37 | 64 | |
| | | 8-1/2" x 14", 11" x 17" (B4, A3) | 18 | 32 | |
| | | 12" x 18" (A3W) | 15 | 26 | |
| | Full color original (photo)  | Up to 8-1/2" x 11" (A4) | 21 | 37 | |
| | | 8-1/2" x 14", 11" x 17" (B4, A3) | 10 | 18 | |
| | | 12" x 18" (A3W) | 8 | 15 | |
| Black and white copying | Text original  | Up to 8-1/2" x 11" (A4) | 400 | 680 | |
| | | 8-1/2" x 14", 11" x 17" (B4, A3) | 200 | 340 | |
| | | 12" x 18" (A3W) | 165 | 280 | |

Copy output (sort and group)

Example: Making five sets or five copies each of three originals

● Sorting copies into sets

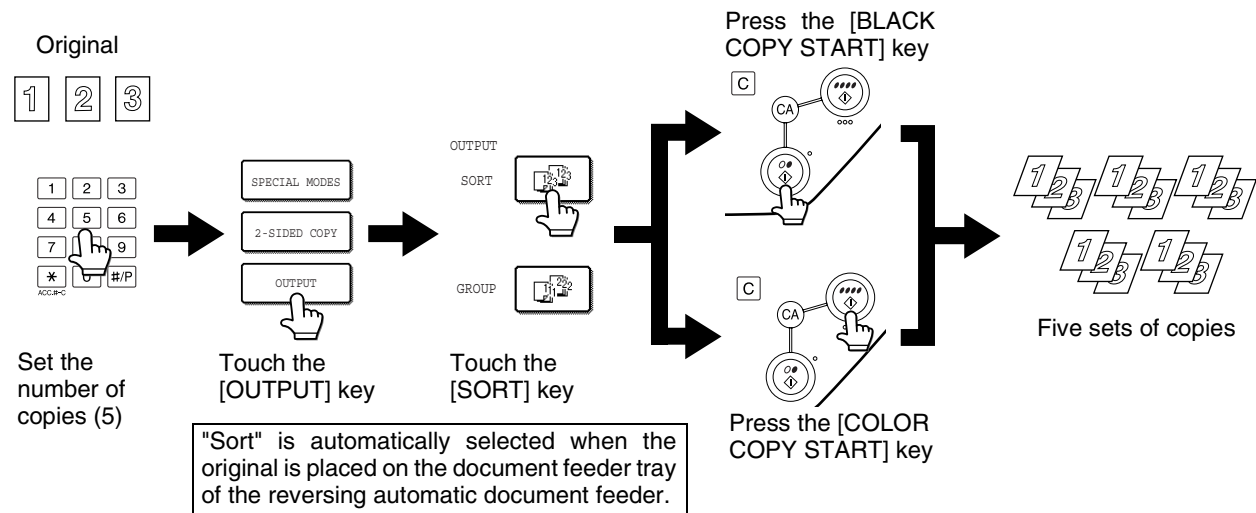

● Grouping copies by page

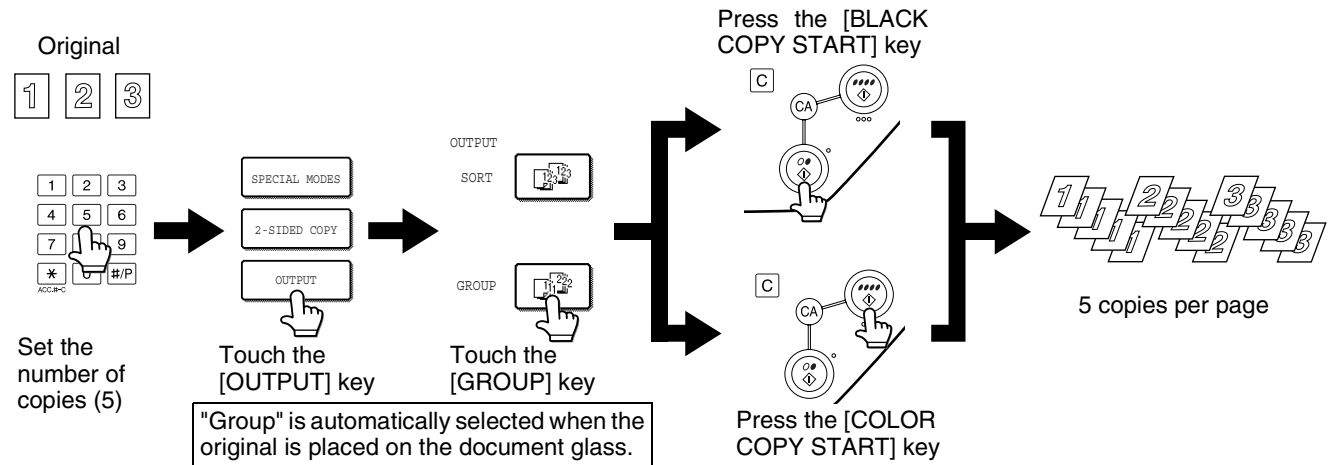

About the offset function

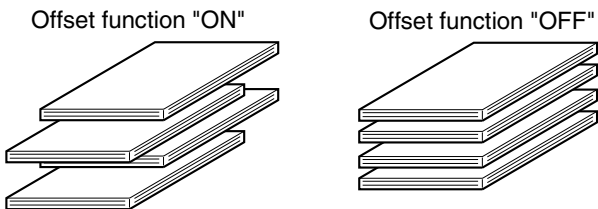

This function offsets each set of copies from the previous set in the output tray, making it easy to separate sets of copies.

(Offset can function for output to the center tray or in the offset tray of the saddle stitch finisher.)

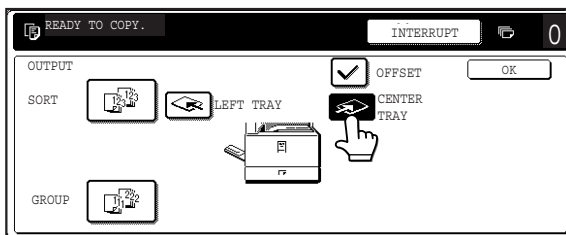

Turning on the offset function

The offset function operates when a checkmark appears in the [OFFSET] checkbox, which is displayed by touching the [CENTER TRAY] key. (If a checkmark doesn't appear, touch the checkbox.)

Offset width: Approximately 1-3/10" (30 mm)
(12" x 18" (A3W) paper cannot be offset.)

Selecting the output tray

When the [LEFT TRAY] key in the above illustration is highlighted, copies are output to the tray on the left side of the machine (the left tray). When the [CENTER TRAY] key is highlighted, copies are output to the center tray. Touch the key of the tray you wish to use for copy output.

Automatic two-sided copying from the reversing automatic document feeder

When a duplex module/2 x 500 sheet paper drawer and a duplex bypass/inverter unit are installed, the following automatic two-sided copy functions are possible. The copy paper is turned over automatically, allowing easy two-sided copying.

NOTE

Certain restrictions exist depending on the amount of memory installed and the copy settings. (See "Copy mode output restrictions" and "Guidelines for the number of scannable originals during sort copying" on page 5-4.)

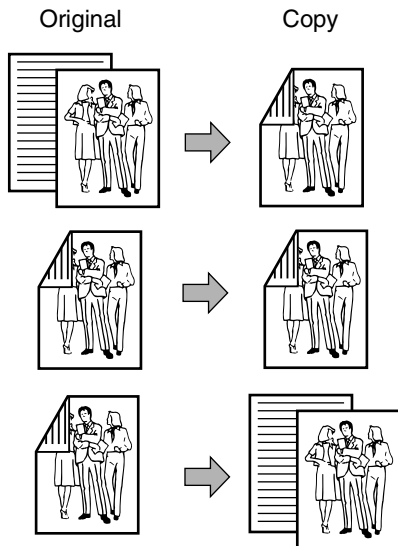

The following two-sided modes can be selected

1. **Automatic two-sided copying from one-sided originals**
2. **Automatic two-sided copying from two-sided originals**
3. **Automatic one-sided copying from two-sided originals**
 - This function can be used even if a duplex module/2 x 500 sheet paper drawer and/or a duplex bypass/inverter unit are not installed.

1 Place the originals in the document feeder tray. (pages 4-6 to 4-9)

2 Touch the [2-SIDED COPY] key.

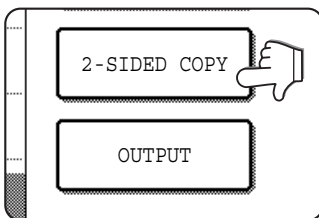

3 Select the desired duplex copy mode.

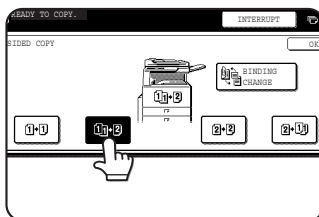

The left screen shows the display when a reversing automatic document feeder, a duplex module/2 x 500 sheet paper drawer, and a duplex bypass/inverter unit are installed. The display will vary depending on the equipment installed.

If a copy key is touched for a mode that cannot be selected, a double beep will be sounded.

Example of a portrait-oriented original

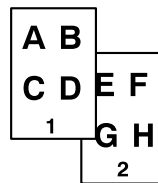

Example of a landscape-oriented original

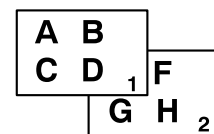

The image to be copied onto the second side of 2-sided copies can be inverted so that the resultant 2-sided copies are in the correct orientation for binding at the top. For top binding, touch the [BINDING CHANGE] key on the 2-sided copy selection screen.

4 Touch the [OK] key.

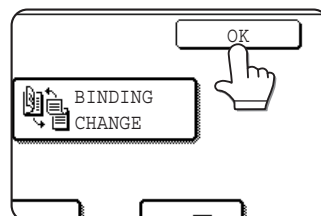

Make selections and proceed as in steps 6 to 9 on pages 5-2 and 5-3.

Copying from the document glass

When copying originals which cannot be fed from the reversing automatic document feeder such as thick originals, open the document cover and copy the originals from the document glass.

NOTE

Certain restrictions exist depending on the amount of memory installed and the copy settings. (See "Copy mode output restrictions" and "Guidelines for the number of scannable originals during sort copying" on page 5-4.)

■ 1-sided copies of 1-sided originals

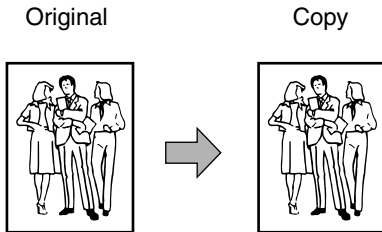

1 Set an original on the document glass. (pages 4-6 to 4-9)

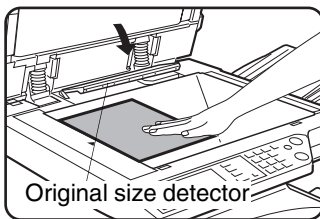

NOTE

Do not place any objects under the original size detector, because they may damage it or the original size may not be detected properly.

[How to place the original]

Place the original in the appropriate position shown below according to its size. (▶ Center the original on the centering scale.)

Original scale

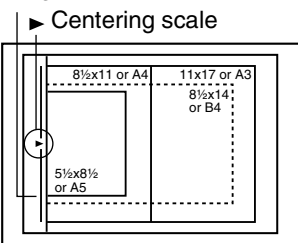

Original scale

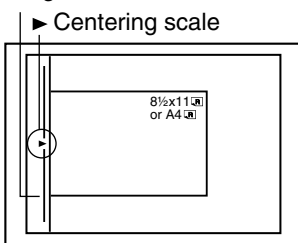

2 Ensure that the 1-sided to 1-sided copy mode is selected.

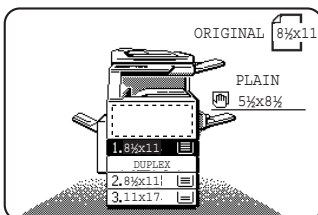

The one-sided to one-sided mode is selected when no icon for a two-sided mode appears in the dashed area on the display.

3 Ensure that paper of the same size as the original is automatically selected. (*Note)

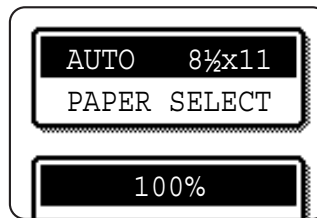

The selected tray will be highlighted or the message "LOAD xxxxxx PAPER." will appear. If the message appears, load paper in a paper tray with paper of the required size. Even if the

message above is displayed, copying can be performed onto the currently selected paper.

(*Note) The following requirements must be satisfied.

Originals of a standard size (11" x 17", 8-1/2" x 14", 8-1/2" x 11", 8-1/2" x 11"R or 5-1/2" x 8-1/2" (A3, B4, A4, A4R, B5, B5R or A5)) are set and the auto paper select function is enabled.

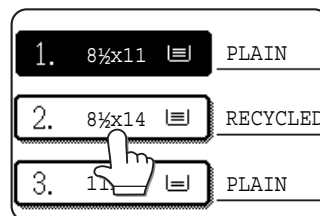

If originals of a size other than the sizes above are to be copied, manually select the desired paper size by touching the [PAPER SELECT] key and then touching the desired paper size selection key.

The selected key will be highlighted and the paper selection screen will close. To close the paper selection screen without making a selection, touch the [PAPER SELECT] key.

4 Select the desired output mode. (See page 5-5.)

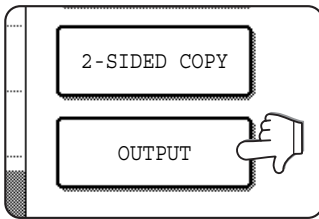

When a document is detected on the document glass, the group mode will be automatically selected. To select sort copy, touch the [OUTPUT] key, then touch the [SORT] key on the displayed screen, and then touch the [OK] key.

NOTE

If the [SORT] or [GROUP] key is touched, its corresponding icon will appear on the touch panel. To clear the icon display, press the [CA] (clear all) key. Note that all selections made to that point will be canceled.

5 Use the numeric keys to set the desired number of copies.

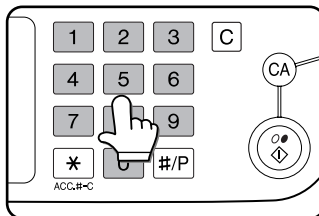

Up to 999 can be set. If you are only making a single copy, the copy can be made with the copy number display showing "0". Use the [C] (clear) key to cancel an entry if a mistake has been made.

6 Press the [COLOR COPY START (●●●●)] or [BLACK COPY START (○○)] key.

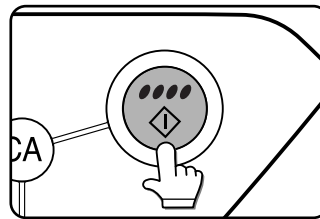

Replace the original with the next original and press the [START] key. Repeat this operation until all originals have been scanned.

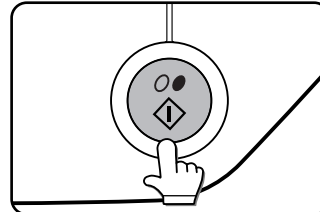

7 Touch the [READ-END] key.

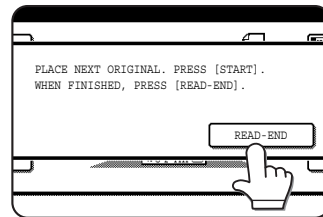

If you selected "Sort" for the output in step 4, it is necessary to touch the [READ-END] key.

Automatic two-sided copying from the document glass

When a duplex module/2 x 500 sheet paper drawer and a duplex bypass/inverter unit are installed, the following automatic two-sided copy function is possible. The copy paper is turned over automatically, allowing easy two-sided copying.

NOTE

Certain restrictions exist depending on the amount of memory installed and the copy settings. (See "Copy mode output restrictions" and "Guidelines for the number of scannable originals during sort copying" on page 5-4.)

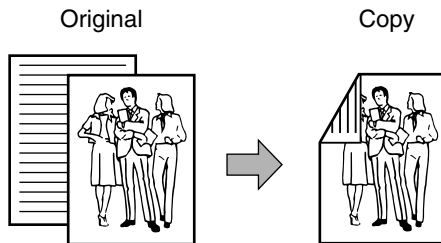

1 Place an original on the document glass. (pages 4-6 to 4-9)

2 Touch the [2-SIDED COPY] key.

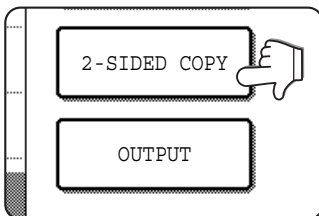

4 Touch the [OK] key.

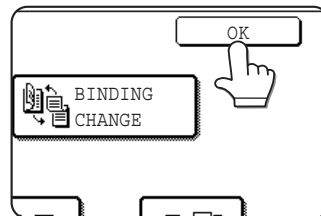

3 Touch the [1-sided to 2-sided copy] key.

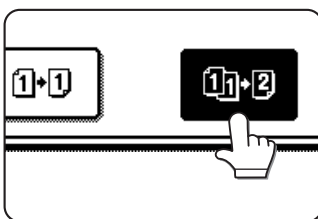

Make selections and proceed as in steps 3 to 7 on pages 5-7 and 5-8.

Example of a portrait-oriented original

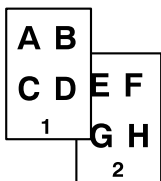

Example of a landscape-oriented original

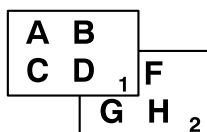

When making automatic two-sided copies of a one-sided 11" x 17" (A3) or 8-1/2" x 14" (B4) size portrait original, or when the front and back side of a two-sided original are copied backwards, touch the [BINDING CHANGE] key.

EXPOSURE ADJUSTMENTS

This copier has seven exposure modes to choose from: AUTO, TEXT/PRTD. PHOTO, TEXT/PHOTO, TEXT, PHOTO, PRINTED PHOTO and MAP.

[AUTO]

This setting automatically adjusts the image to provide the optimum image quality. Normally this setting is selected.

[TEXT/PRTD. PHOTO, TEXT/PHOTO, TEXT, PHOTO, PRINTED PHOTO and MAP.]

The exposure can be manually adjusted in 9 steps.

1 Touch the [EXPOSURE] key.

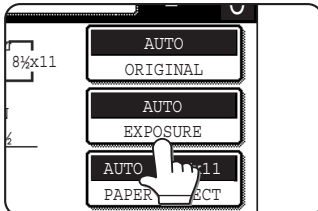

2 Select [AUTO], [TEXT/PRTD. PHOTO], [TEXT/PHOTO], [TEXT], [PHOTO], [PRINTED PHOTO], or [MAP] depending upon the original type.

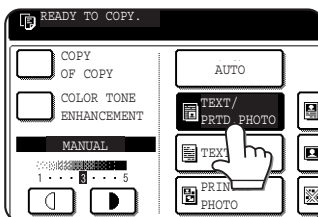
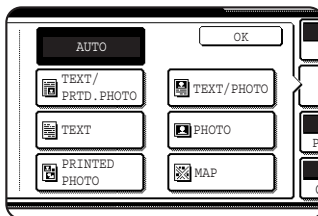

Example:
The [TEXT/PRTD. PHOTO] key is selected

NOTES

● Selecting the resolution

Six resolution settings are available for both color copying and black and white copying, depending on the contents of the original.

| Original type | Contents of the original |
|------------------|---|
| AUTO | This setting automatically adjusts the image to provide the optimum image quality. Normally this setting is selected. |
| TEXT/PRTD. PHOTO | This mode provides the best balance for copying an original which contains both text and printed photographs. |
| TEXT/PHOTO | This mode provides the best balance for copying an original which contains both text and photographs. |
| TEXT | This mode is useful in enhancing very low density areas of an original or in suppressing unusually high-density background areas. |
| PHOTO | This mode provides the best copies of photographs with fine details. |
| PRINTED PHOTO | This mode is useful for copying printed photographs. |
| MAP | This mode is useful to provide the best shading and fine details found on most maps. |

● Making a copy of a copy

When making a copy of a copy made on this machine, touch the checkbox for COPY OF COPY to select the mode. Three resolution settings are available when this mode is selected: "TEXT/PRINTED PHOTO", "TEXT", and "PRINTED PHOTO".

● For brighter colors in color copies, touch the COLOR TONE ENHANCEMENT checkbox. The following restrictions apply when color tone enhancement is selected:

Color tone enhancement cannot be selected at the same time as COPY OF COPY mode (above).

Brightness adjustment (page 6-15) and single color copying (page 6-17) are not possible.

- 3** If a setting other than "AUTO" has been selected in step 2, manually adjust the copy exposure.

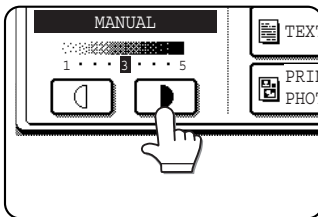

Touch the  key to make darker copies.

Touch the  key to make lighter copies.

NOTES

● Recommended exposure levels for the text mode

- 1 to 2: Dark originals such as newspaper
- 3: Normal density originals
- 4 to 5: Originals written with pencils or light color characters

● Color adjustment menu

As special functions for color copying, the following color image adjustments can be made. (Page 6-11)

- RGB ADJUST
- SHARPNESS
- SUPPRESS BACKGROUND
- COLOR BALANCE
- BRIGHTNESS
- INTENSITY

- 4** Use the numeric keys to set the desired number of copies.

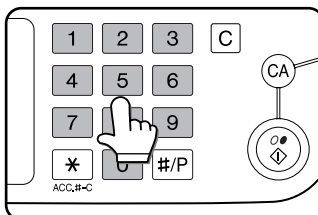

- 5** Press the [COLOR COPY START (●●●●)] or [BLACK COPY START (○○)] key.

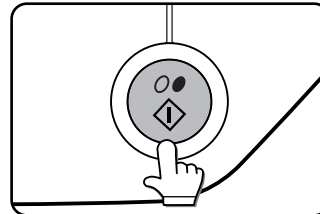
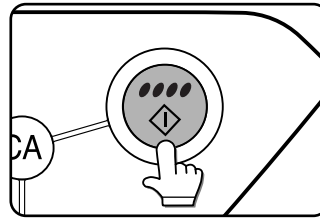

To return to the automatic exposure mode, touch the [EXPOSURE] key and select [AUTO].

NOTE

The exposure level for automatic exposure adjustment can be changed using the key operator program on page 15 of the key operator's guide. (Exposure adjustment)

REDUCTION/ENLARGEMENT/ZOOM

Reduction and enlargement ratios can be selected either automatically or manually as described in this section.

Automatic selection (auto image)

The reduction or enlargement ratio will be selected automatically based on the original size and the selected paper size.

1 Place the original in the document feeder tray or on the document glass. (pages 4-6 to 4-9)

The detected original size will be displayed.

NOTE

Automatic ratio adjustment can only be used for the following original and paper sizes. It cannot be used for other sizes. However, in the case of non-standard original and paper sizes, the sizes can be entered to make automatic ratio adjustment possible for those sizes. (page 4-8)

Original sizes: 11" x 17", 8-1/2" x 14", 8-1/2" x 11", 8-1/2" x 11"R, 5-1/2" x 8-1/2" (A3, B4, A4, A4R, B5, B5R, A5)

Paper size: 11" x 17", 8-1/2" x 14", 8-1/2" x 13", 8-1/2" x 11", 8-1/2" x 11"R, 5-1/2" x 8-1/2" (A3, B4, A4, A4R, B5, A5)

2 Touch the [PAPER SELECT] key and then select the desired paper size.

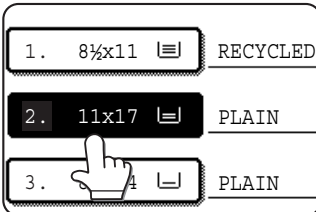

When touching the desired paper size selection key, the selected key will be highlighted and the paper selection screen will close.

NOTE

If paper of the desired size is not loaded in any tray, load paper of the required size in a paper tray or the bypass tray.

3 Touch the [AUTO IMAGE] key.

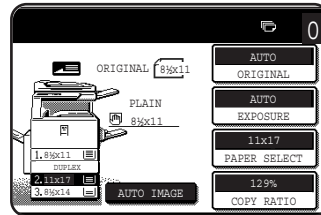
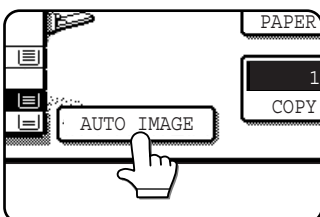

The [AUTO IMAGE] key will be highlighted and the best reduction or enlargement ratio for the original size and the selected paper size will be selected and displayed in the copy ratio display.

NOTE

If the message "ROTATE ORIGINAL FROM [icon] TO [icon]" is displayed, change the orientation of the original as indicated in the message. When the message above is displayed, copying can be done without changing the orientation, but the image will not fit the paper correctly.

4 Use the numeric keys to set the desired number of copies.

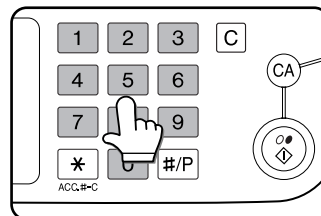

Up to 999 can be set. If you are only making a single copy, the copy can be made with the copy number display showing "0".

Use the [C] (clear) key to cancel an entry if a mistake has been made.

5 Press the [COLOR COPY START (●●●●)] or [BLACK COPY START (○○)] key.

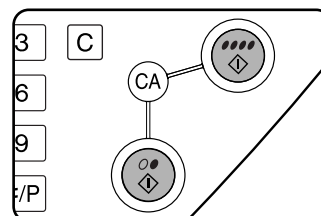

If you placed the original on the document glass, set the output to "Sort", you must touch the [READ-END] key after all pages of the original have been scanned. (Step 7 on page 5-8)

To cancel the auto image mode, touch the [AUTO IMAGE] key again to clear the highlighted display. (Step 3)

Manual selection

The preset ratios (maximum 400%, minimum 25%) can be selected with the enlargement and reduction keys. In addition, the zoom keys can be used to select any ratio from 45% to 400% in increments of 1%.

<The key operator program on page 15 of the key operator's guide can be used to set two additional enlargement ratios and two additional reduction ratios.>

1 Place the original in the document feeder tray or on the document glass. (pages 4-6 to 4-9)

2 Touch the [COPY RATIO] key.

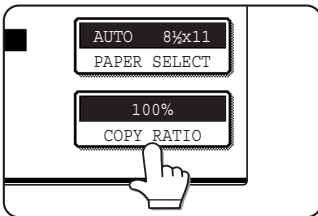

3 Use the [MENU] key to select menu "1" or menu "2" for copy ratio selection.

Menu **1**

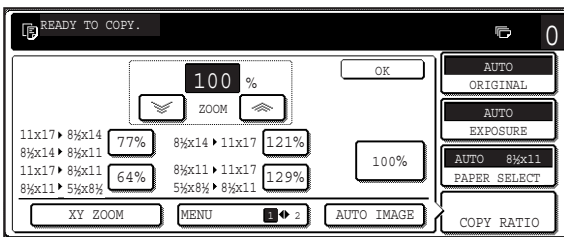

- A. Preset reduction copy ratios are:
77% and 64% (for the inch system).
70%, 81% and 86% (for the AB system).
- B. Preset enlargement copy ratios are:
121% and 129% (for the inch system).
115%, 122% and 141% (for the AB system).

Menu **2**

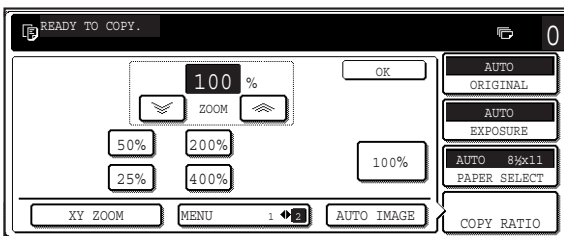

- A. Preset reduction copy ratios are:
50% and 25%.
- B. Preset enlargement copy ratios are:
200% and 400%.

(The custom ratios set by the key operator appear in ratio menu 2.)

4 Use the reduction, enlargement, and [ZOOM] keys on the touch panel to set the desired copy ratio.

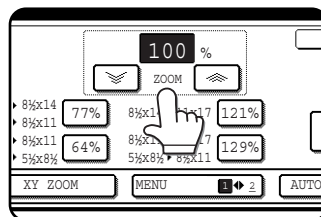
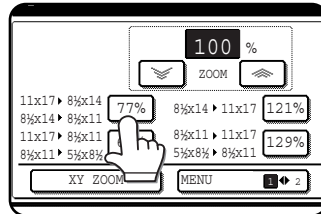

Zoom ratios: Any ratio from 45% to 400% can be set in 1% increments. Touch the [] key to increase the ratio, or the [] key to decrease the ratio. If you continue to touch either key for 3 seconds, the ratio begins to change quickly.

NOTES

- Touch a reduction or enlargement key to set the approximate ratio, then touch the [] key to decrease the ratio or the [] key to increase the ratio.
- The message "IMAGE IS LARGER THAN COPY PAPER." may appear, indicating that the selected copy ratio is too large for the copy paper size. However, if you press the [START] key, a copy will be made.
- To set the horizontal and vertical copy ratios separately, use the XY ZOOM feature. See page 5-15.

5 Touch the [OK] key.

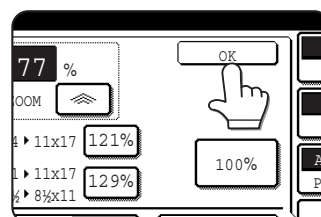

6 Ensure that the desired paper size has been automatically selected based on the selected copy ratio or select another size as needed.

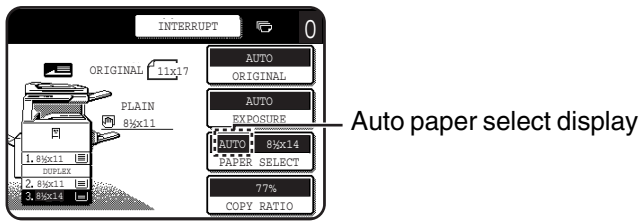

NOTE
If the auto paper select display does not appear, no appropriate paper size for the selected ratio is available.

7 Use the numeric keys to set the desired number of copies.

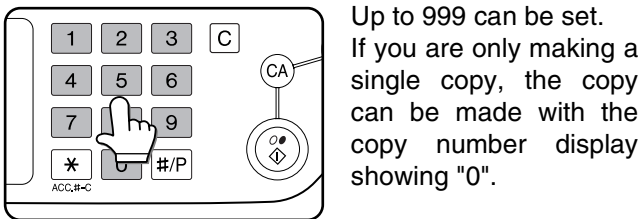

Use the [C] (clear) key to cancel an entry if a mistake has been made.

8 Press the [COLOR COPY START (●●●●)] or [BLACK COPY START (○●)] key.

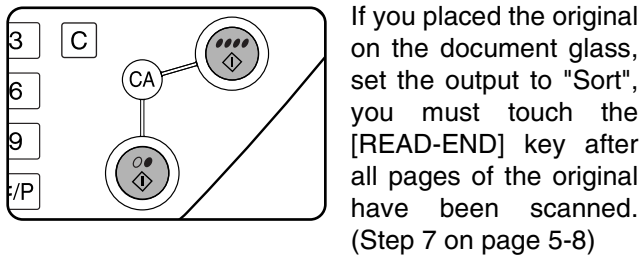

To return the ratio to 100%
To return the ratio setting to 100%, touch the [COPY RATIO] key to display the ratio menu and then touch the [100%] key. (Steps 2 and 3 on page 5-13.)

XY ZOOM

The XY ZOOM feature allows the horizontal and vertical copy ratios to be changed independently. If this feature is selected, the copy ratios can be set from 25% or 45% to 400%.

Example: Selecting 100% for the length and 50% for the width

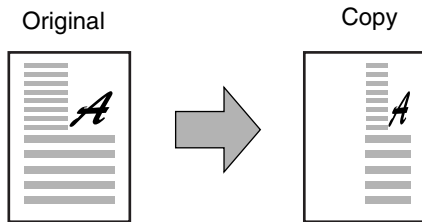

1 Place the original in the document feeder tray or on the document glass. (pages 4-6 to 4-9)

2 Touch the [COPY RATIO] key on the touch panel.

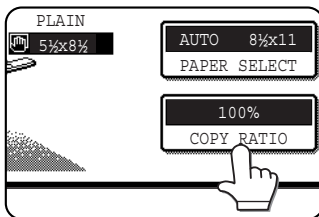

3 Touch the [XY ZOOM] key.

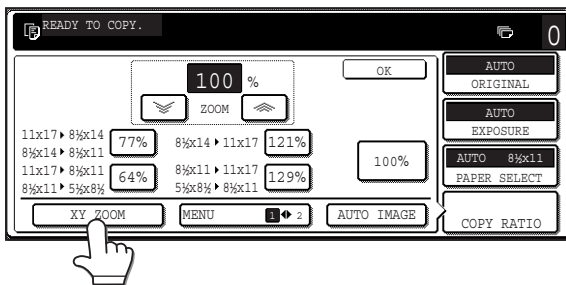

4 Touch the [X] key.

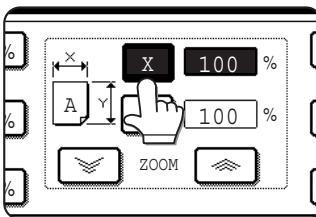

5 Use the reduction, enlargement, and ZOOM ([↖], [↗]) keys to change the copy ratio in the horizontal (X) direction.

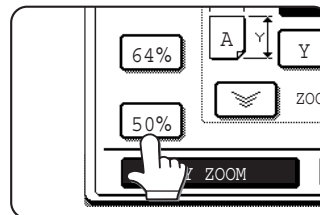

A fixed ratio key will not become highlighted when touched.

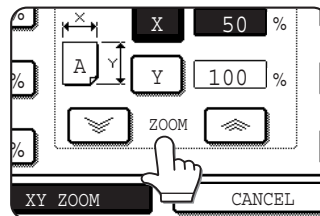

The zoom keys can be used to change the ratio from 45% to 400% in increments of 1%.

Touch the [↖] key to increase the ratio, or the [↗] key to decrease the ratio. If you continue to touch either key for 3 seconds, the ratio begins to change quickly.

NOTE

Touch a reduction key or an enlargement key to set the approximate ratio, then touch the [↖] key to decrease the ratio or [↗] key to increase the ratio.

6 Touch the [Y] key.

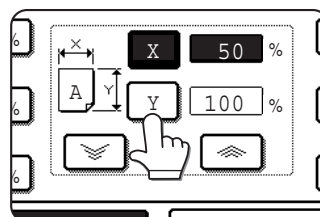

5

7 Use the reduction, enlargement, and ZOOM ([≡], [≡]) keys to change the copy ratio in the vertical (Y) direction.

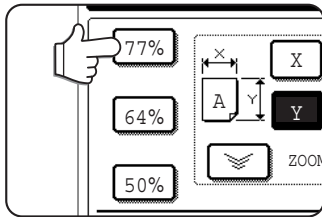

A fixed ratio key will not become highlighted when touched.

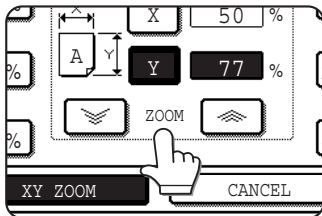

The zoom keys can be used to change the ratio from 45% to 400% in increments of 1%.

Touch the [≡] key to increase the ratio, or the [≡] key to decrease

the ratio. If you continue to touch either key for 3 seconds, the ratio begins to change quickly.

Either copy ratio can be changed for fine-tuning until the next step is performed.

8 Touch the [OK] key.

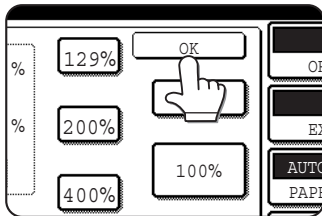

9 Touch the [PAPER SELECT] key and select the paper tray with the desired paper size.

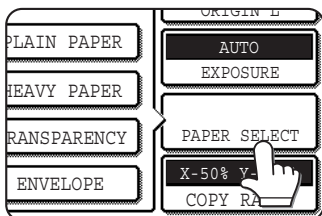

If the AUTO PAPER SELECT mode is on, the appropriate copy paper size will have been automatically selected based on the original size and selected copy ratios.

10 Make all other desired settings such as exposure, paper size and number of copies and then press the [COLOR COPY START (●●●●)] or [BLACK COPY START (○●)] key.

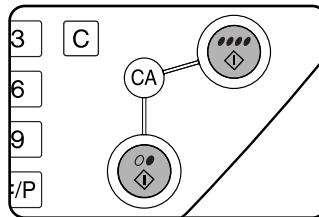

To cancel this function, touch the [CANCEL] key or the [XY ZOOM] key again as in step 3 or 5 on page 5-15.

SPECIAL PAPERS

Special papers including transparency film, postcards and envelopes must be fed through the bypass tray.

- 1 Place the original in the document feeder tray or on the document glass. (pages 4-6 to 4-9)**

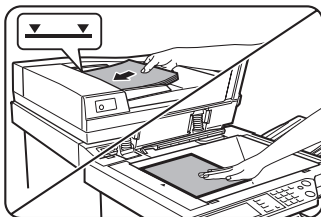

- 2 Load the special paper in the bypass tray.**

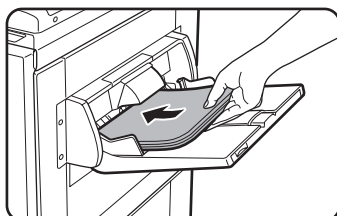

See pages 2-6 and 2-9 for the specifications of paper that can be used in the bypass tray. For the paper loading instructions see "Loading paper in the bypass tray" (page 2-4).

- 3 Touch the [PAPER SELECT] key and then select the bypass tray.**

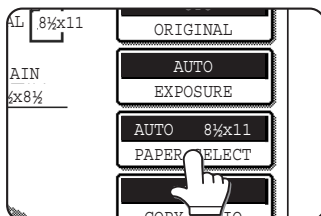

Select the type of paper that you inserted in the bypass tray.

- 4 Make all other desired settings such as exposure or the number of copies, and press the [COLOR COPY START (●●●●)] or [BLACK COPY START (○●)] key.**

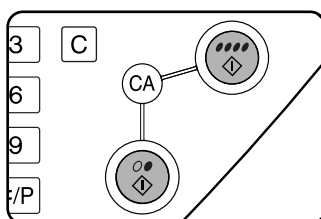

If you placed the original on the document glass, you must touch the [READ-END] key after all pages of the original have been scanned. (Step 7 on page 5-8)

NOTES

- **Output location for copies on heavy paper 2, transparencies, and envelopes**

Copies on these types of paper will be output face-up to the tray on the left side of the machine.

They cannot be delivered to the center tray. Face-down delivery is not possible for these papers.

- **Color adjustment menu**

As special functions of color copying, the following color image adjustments are available. (Page 6-11)

- RGB ADJUST
- SHARPNESS
- SUPPRESS BACKGROUND
- COLOR BALANCE
- BRIGHTNESS
- INTENSITY

CHAPTER 6

CONVENIENT COPY FUNCTIONS

This chapter explains special-purpose functions, storing of copy settings, and other convenient functions. Please select and read sections of this chapter as needed.

| | Page |
|--|------|
| SPECIAL MODES..... | 6-2 |
| • Common operation procedure for using the special functions | 6-3 |
| • Margin shift | 6-4 |
| • Erase..... | 6-5 |
| • Dual page copy | 6-6 |
| • Centering | 6-7 |
| • Transparency film with insert sheets..... | 6-8 |
| • Covers..... | 6-9 |
| • B/W reverse | 6-10 |
| COLOR ADJUSTMENTS MENU | 6-11 |
| • RGB adjust..... | 6-12 |
| • Sharpness..... | 6-13 |
| • Suppress background | 6-13 |
| • Color balance | 6-14 |
| • Brightness | 6-15 |
| • Intensity..... | 6-15 |
| IMAGE EDIT MENU..... | 6-16 |
| • Single color | 6-17 |
| • Mirror image..... | 6-17 |
| • Photo Repeat | 6-18 |
| • Multi shot..... | 6-19 |
| • 11" x 17" (A3) Full-bleed | 6-21 |
| • Multi-page enlargement | 6-22 |
| • Pamphlet copy | 6-24 |
| JOB PROGRAM MEMORY | 6-25 |
| • Storing a job program | 6-25 |
| • Recalling a job program | 6-26 |
| • Deleting a stored job program..... | 6-26 |
| INTERRUPTING A COPY RUN..... | 6-27 |

SPECIAL MODES

When the [SPECIAL MODES] key on the main screen of the copy mode is touched, the special modes screen containing several special function touch keys will appear. These functions are shown below.

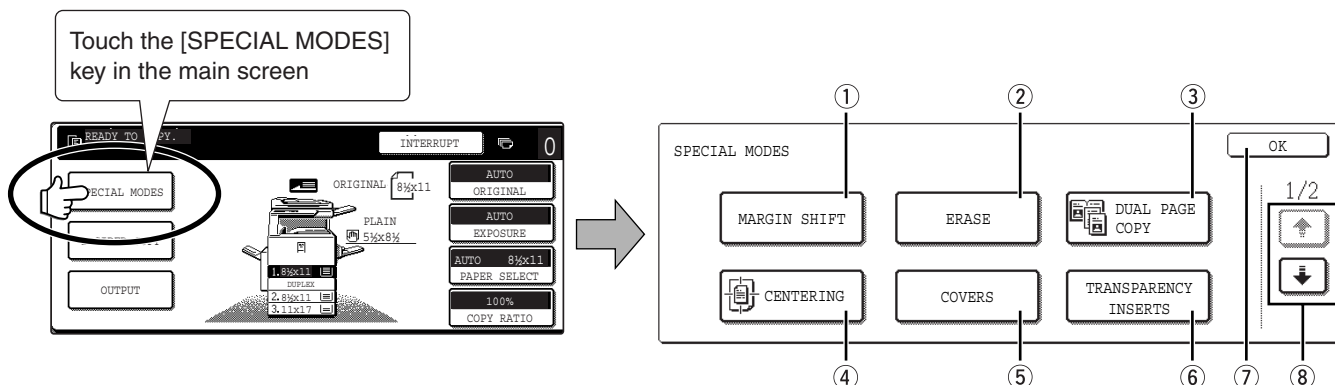

① **[MARGIN SHIFT] key (page 6-4)**

Use this to shift the image on the copy to create binding margins.

② **[ERASE] key (page 6-5)**

Use this to erase peripheral shadows that occur when making copies of books and other thick originals.

③ **[DUAL PAGE COPY] key (page 6-6)**

This is useful to copy the left and right pages of bound documents without shifting the document on the document glass.

④ **[CENTERING] key (page 6-7)**

Use this to center the copied image on the paper.

⑤ **[COVERS] key (page 6-9)**

Use this to insert a different type of paper for use as front and back covers. (The reversing automatic document feeder must be used.)

⑥ **[TRANSPARENCY INSERTS] key (page 6-8)**

When copying onto transparencies, use this to automatically insert a sheet of copy paper between transparency sheets.

⑦ **[OK] key on the special modes screen**

Touch the [OK] key to return to the main screen of the copy mode.

⑧ **↑ / ↓ key**

Touch these keys to switch between the special modes menu screens.

The special modes menu consists of two screens.

Touch the ↓ key ⑧ to switch to the screen below.

- The special modes below can be selected in the second screen (2/2).

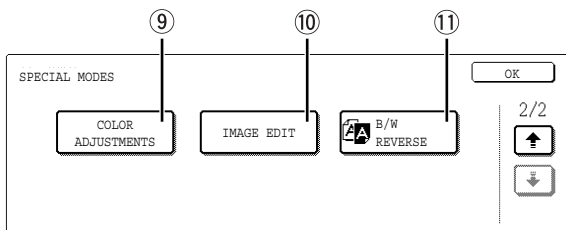

⑨ **[COLOR ADJUSTMENTS] key (page 6-11)**

Touch this key to display the color adjustments menu screen. This allows you to select the special functions shown below for color adjustment when making color copies.

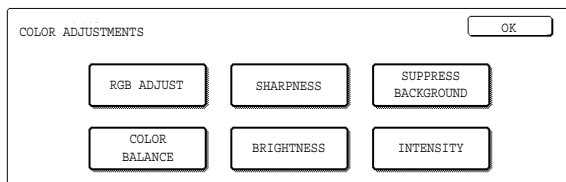

⑩ **[IMAGE EDIT] key (page 6-16)**

Touch this key to display the image edit menu screen. This allows you to select the special functions shown below for image editing.

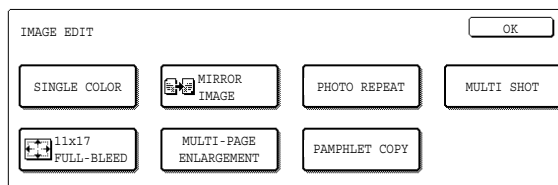

⑪ **[B/W REVERSE] key (page 6-10)**

A copy can be made with black and white reversed. (This function can only be used for black and white copying.)

Common operation procedure for using the special functions

- 1 Touch the [SPECIAL MODES] key.

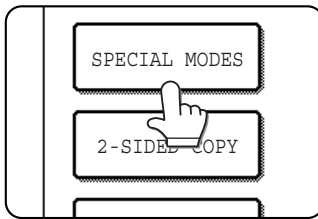

- 2 Touch the key for the desired special mode.

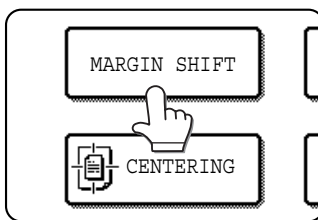

Example:
To set the margin shift function

If you touch the menu keys for color adjustment or image editing, you will go to the menu screen for selection of the corresponding functions.

Setting procedures for modes requiring setting screens start on the next page.

The dual page copy, centering, transparency film with insert sheets, B/W reverse, mirror image and 11" x 17" (A3) full-bleed functions do not require setting screens.

Margin shift

The margin shift function will automatically shift the text or image on the copy paper approximately 1/2" (10 mm) in its initial setting.

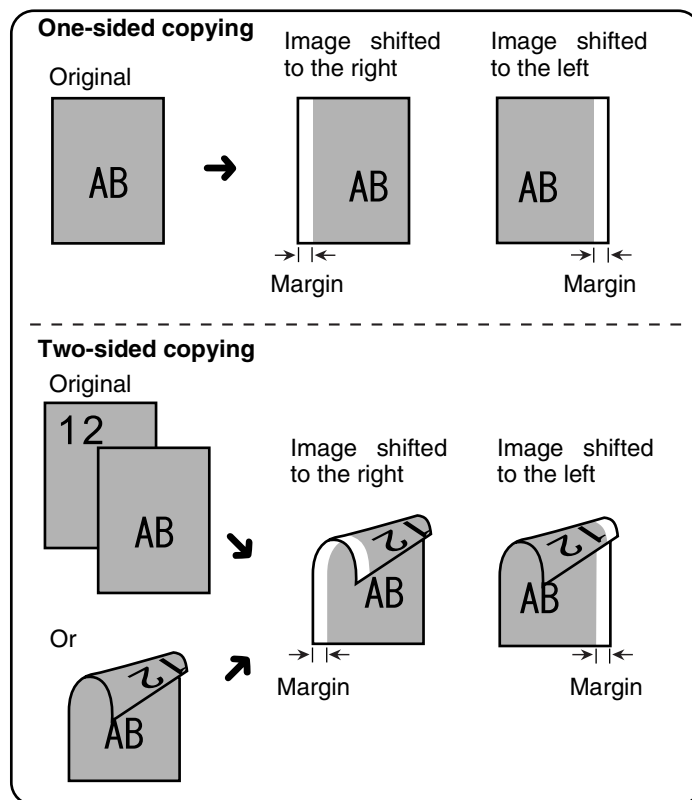

- The shift direction can be selected from right or left shift as shown in the illustration.

1 Touch the [MARGIN SHIFT] key on the SPECIAL MODES screen.

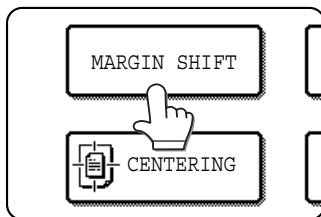

The margin shift setting screen will appear. The margin shift icon () will also appear in the upper left of the screen to indicate that the function is turned on.

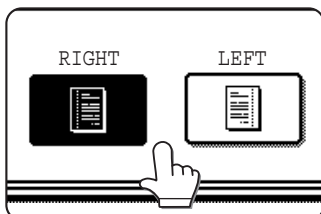

2 Select the shift direction.

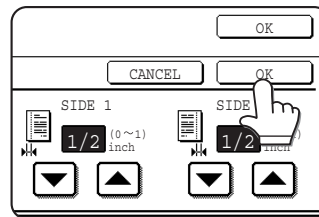

Touch a shift direction key to select right or left. The selected key will be highlighted.

3 Set the shift amount as needed and touch the [OK] key.



Use the  and the  keys to set the shift amount. The shift amount can be set from 0" to 1" in 1/8" increments.

If a duplex module/2 x 500 sheet paper drawer and duplex bypass/inverter unit are not installed, the margin shift setting for back-side copies will not be displayed.

4 Touch the [OK] key on the SPECIAL MODES screen.

Return to the main screen of copy mode.

About the steps that follow

If a reversing automatic document feeder is being used, see pages 5-2 through 5-6. If the document glass is being used, see pages 5-7 through 5-9.

To cancel the margin shift function, touch the [CANCEL] key on the margin shift setting screen.

Erase

The erase function is used to erase the shadow lines on copies produced when copying thick originals or books. The erase modes that can be selected are shown below. The erase width is approximately 1/2" (10 mm) in its initial setting.

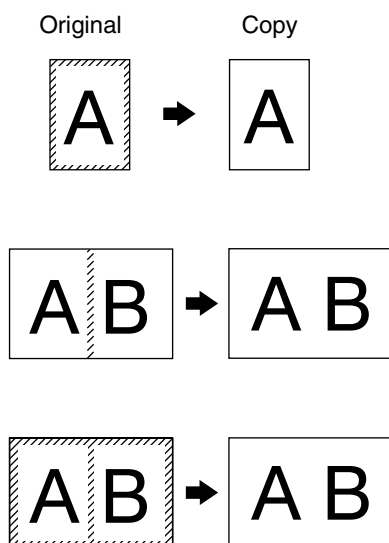

EDGE ERASE

Eliminates shadow lines around the edges of copies caused when heavy paper or a book is used as an original.

CENTER ERASE

Eliminates shadow lines produced by the bindings of bound documents.

EDGE + CENTER ERASE

Eliminates shadow lines around the edges of copies and eliminates the shadow at the center of copies.

1 Touch the [ERASE] key on the SPECIAL MODES screen.

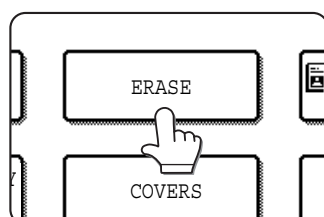

The erase setting screen will appear. The erase icon (🗑️) will also appear in the upper left of the screen to indicate that the function is turned on.

2 Select the desired erase mode.

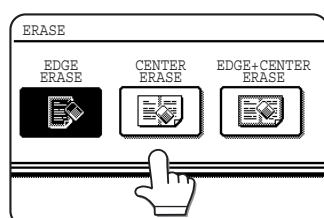

Select one of the three erase modes. The selected key will be highlighted.

3 Adjust the amount of erase and touch the [OK] key.

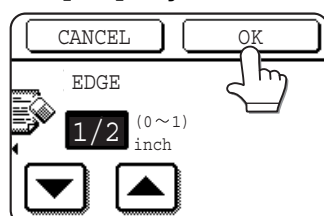

Use the ▼ and ▲ keys to adjust the erase width and then touch the [OK] key.

4 Touch the [OK] key on the SPECIAL MODES screen.

Return to the main screen of copy mode.

About the steps that follow

If a reversing automatic document feeder is being used, see pages 5-2 through 5-6. If the document glass is being used, see pages 5-7 through 5-9.

To cancel the erase function, touch the [CANCEL] key on the erase setting screen.

Dual page copy

The dual page copy function produces separate copies of two documents placed side by side on the document glass. It is especially useful when copying books and other bound documents.

[Example] Copying right and left pages of a book

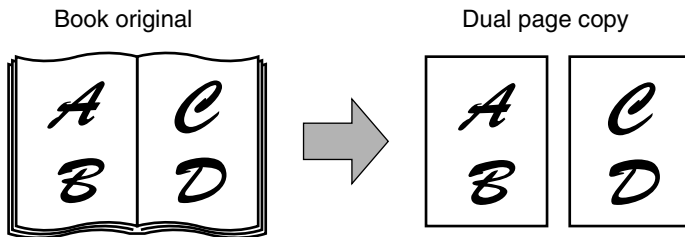

- The dual page copy function can be used with reduction copying but cannot be used with enlargement copying.
- The dual page copy function can be done only from the document glass. The reversing automatic document feeder cannot be used with this function.
- Only 8-1/2" x 11" (A4) paper can be used.

1 Touch the [DUAL PAGE COPY] key on the SPECIAL MODES screen.

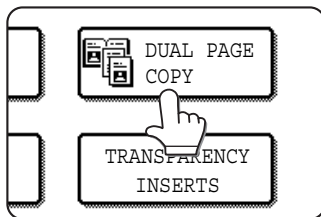

The [DUAL PAGE COPY] key will be highlighted to indicate that the function is turned on, and the dual page copy icon (📄📄) will appear in the upper left of the screen.

When copying book originals:

When copying a thick book, press down lightly on the book to flatten it against the document glass.

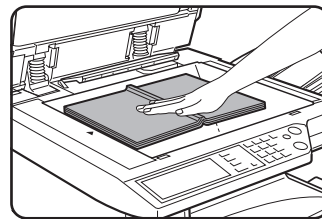

2 Touch the [OK] key on the SPECIAL MODES screen.

Return to the main screen of copy mode.

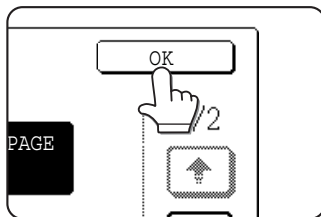

4 Ensure that 8-1/2" x 11" (A4) size paper is selected.

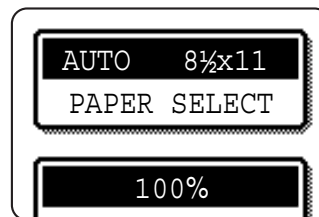

If 8-1/2" x 11" (A4) size paper is not selected, touch the [PAPER SELECT] key to select 8-1/2" x 11" (A4) size paper.

3 Place the originals on the document glass.

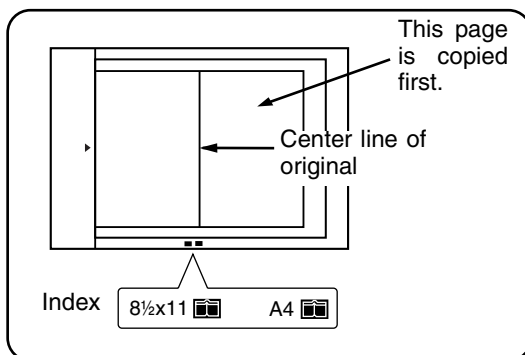

About the steps that follow
 For two-sided copying, follow steps 2 through 4 on page 5-9 and then follow steps 4 through 7 on page 5-8.
 For one-sided copying, follow steps 4 through 7 on page 5-8.

To cancel the dual page copy function, touch the [DUAL PAGE COPY] key on the special modes screen (step 1). (The highlighted display will be canceled.)

NOTE
 To erase shadows caused by document binding, use the edge erase function (page 6-5). (Center Erase and Edge + Center Erase cannot be used in combination.)

Centering

When the original and copy paper are of different sizes, CENTERING is used to shift the image to the center of the copy paper but only in the left to right direction.

[Example]

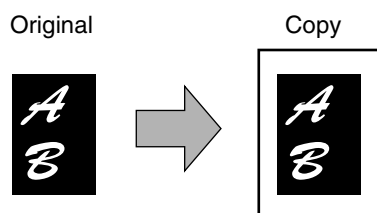

- This function can be used to reduce a larger sized original image and center it on a copy of smaller paper size, as well as center a smaller original onto a larger sized copy.
- This function will not work when non-standard size originals or copy paper are used. This function cannot be selected when enlargement copying has been selected.

1 Touch the [CENTERING] key on the SPECIAL MODES screen.

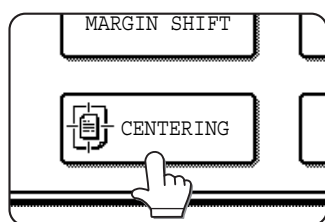

The [CENTERING] key is highlighted to indicate that the function is turned on, and the centering icon () will appear in the upper left of the screen.

2 Touch the [OK] key on the SPECIAL MODES screen.

Return to the main screen of copy mode.

About the steps that follow

If a reversing automatic document feeder is being used, see pages 5-2 through 5-6. If the document glass is being used, see pages 5-7 through 5-9.

To cancel the CENTERING function, touch the [CENTERING] key again on the SPECIAL MODES screen (step1).

Transparency film with insert sheets

When copying onto transparency film, blank insert sheets can be placed between transparent sheets.

Example: Inserting insert sheets between transparencies

Originals (1-sided)

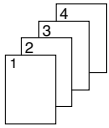

Originals (2-sided)



For two-sided originals, this is only possible when using a reversing automatic document feeder.

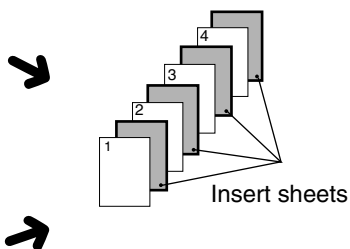

- Insert sheets cannot be copied on in any mode.
- This mode can be selected only in the 1-sided to 1-sided and 2-sided to 1-sided modes.
- A multiple number of copies cannot be selected in this mode.
- Transparency film must be fed from the bypass tray.
- Insert sheets must be the same size (8-1/2" x 11" or 8-1/2" x 11"R (A4 or A4R)) as the transparency film.
- For best results, use SHARP recommended transparency film.

Before performing the following procedure, touch the [OUTPUT] key in the main screen of Copy mode to display the OUTPUT settings screen (page 5-5), and then touch the [LEFT TRAY] key* to set the output tray to the left tray*.

* If the optional saddle stitch finisher is installed, touch the [FINISHER TRAY] key to set the output tray to the finisher tray.

1 Touch the [TRANSPARENCY INSERTS] key on the SPECIAL MODES screen.

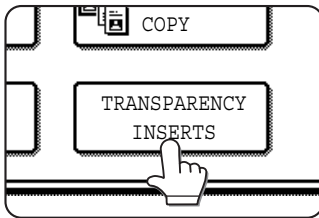

The [TRANSPARENCY INSERTS] key is highlighted to indicate that the function is turned on, and the transparency inserts icon (📄) appears in the upper left of the screen.

2 Touch the [OK] key on the SPECIAL MODES screen.

Return to the main screen of copy mode.

3 Load transparency film into the bypass tray.

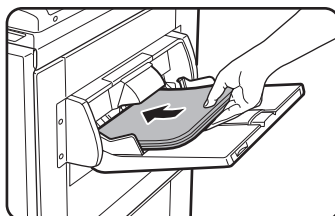

Remove any paper already in the bypass tray before loading the transparency film. (To load paper in the bypass tray, see pages 2-4 and 2-5.)

4 Touch the [PAPER SELECT] key and select the transparency film loaded in the bypass tray.

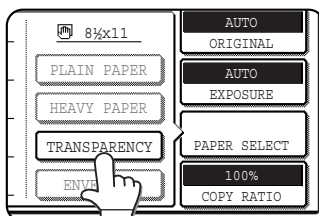

Touch the [TRANSPARENCY] key.

5 Touch the [SPEED MODE] key or the [QUALITY MODE] key for the transparency film.

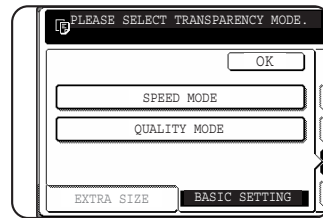

SPEED MODE is for fast printing. QUALITY MODE is for a high quality image. After touching either key followed by the [OK] key, you will return to the main screen of copy mode.

6 Touch the [PAPER SELECT] key again and select the paper (8-1/2" x 11" (A4) or 8-1/2" x 11"R (A4R) size) to be used for the inserts.

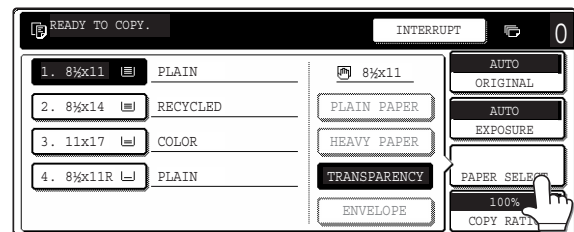

About the steps that follow

If a reversing automatic document feeder is being used, see pages 5-2 and 5-3. If the document glass is being used, see pages 5-7 and 5-8.

To cancel the TRANSPARENCY INSERTS function, touch the [TRANSPARENCY INSERTS] key again on the SPECIAL MODES screen.

NOTE

When the copy job is finished, remove any transparencies that remain in the bypass tray.

Covers

The COVERS mode is used to place covers on the front, back, or both the front and back of multipage documents. This function can only be used when the originals are placed in the document feeder tray of the reversing automatic document feeder. (The document glass cannot be used.)

■ Copying onto a cover

One-sided copies from one-sided or two-sided originals

One-sided originals → One-sided copies (copying onto a cover)
 Cover original → Front cover (can copy onto front side)
 Back cover (no copying)

Two-sided originals → One-sided copies (copying onto a cover)
 Cover original → Front cover (can copy onto front side)
 Back cover (no copying)

Two-sided copies from one-sided or two-sided originals

One-sided originals → Two-sided copies (copying onto a cover)
 Cover original → Front cover (can copy onto front side)
 Back cover (no copying)

Two-sided originals → Two-sided copies (copying onto a cover)
 Cover original → Front cover (can copy onto front side)
 Back cover (no copying)

Selections for front cover, back cover, or front and back cover can be made.
 Back cover sheets cannot be copied on, either on the front side or on the back side.

■ Not copying onto a cover

One-sided copies from one-sided or two-sided originals

One-sided originals → One-sided copies (not copying onto a cover)
 Back cover
 Front cover (not copying onto a cover)

Two-sided originals → One-sided copies (not copying onto a cover)
 Back cover
 Front cover

Two-sided copies from one-sided or two-sided originals

One-sided originals → One-sided copies (not copying onto a cover)
 Back cover
 Front cover

Two-sided originals → One-sided copies (not copying onto a cover)
 Back cover
 Front cover

Selections for front cover, back cover, or front and back cover can be made.

1 Touch the [COVERS] key on the SPECIAL MODES screen.

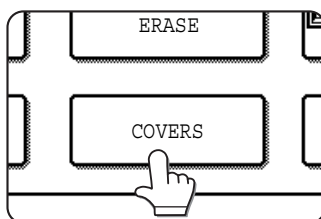

The COVERS setting screen will appear. The covers icon (📄, etc.) will also appear in the upper left of the screen to indicate that the function is turned on.

2 Select cover placement.

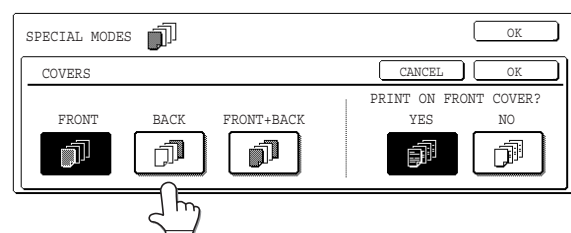

Select [FRONT], [BACK] or [FRONT+BACK] on the touch panel.

3 Indicate whether the front cover sheets are copied on or not.

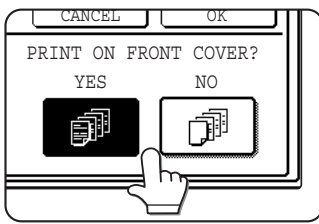

Select [YES] or [NO] on the touch panel. If [YES] is selected, the first page of the document will be copied onto the front cover sheet.

4 Touch the [OK] key on the COVER setting screen.

Return to the SPECIAL MODES screen.

5 Touch the [OK] key on the SPECIAL MODES screen.

Return to the main screen of copy mode.

6 Load the cover paper to be used into the bypass tray.

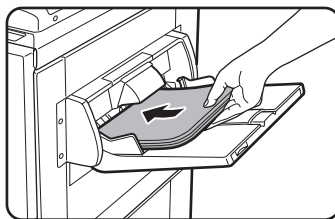

Load the same size of paper as the paper to be used for the copy job. If the saddle stitch finisher is to be used for stapling, heavy stock cannot be used for the covers. (See page 2-10) Paper within the range of the stapler must be used.

About the steps that follow

See pages 5-2 through 5-6.

NOTE

Be sure to place the originals in the document feeder tray of the reversing automatic document feeder. The document glass cannot be used for this function.

NOTES

- During cover copying, the stream feeding mode will not function even if it is turned on by the program on page 12 of the key operator's guide.
- During cover copying, the pamphlet copy function (page 6-24) and the saddle stitch (pamphlet staple) function (page 3-5) will not operate.

To cancel the COVERS function, select the COVERS function again and touch the [CANCEL] key (step2).

B/W reverse

Black and white are reversed in the copy to create a negative image. (This function can only be used for black and white copying.)

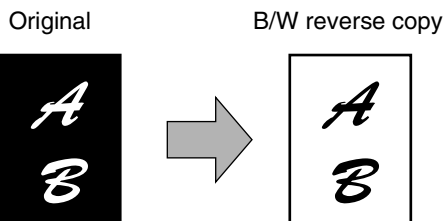

NOTE

Originals with large black areas (which use a large amount of toner) can be printed with black/white reverse to reduce toner consumption.

1 Touch the [DOWN] key to switch to the second SPECIAL MODES screen.

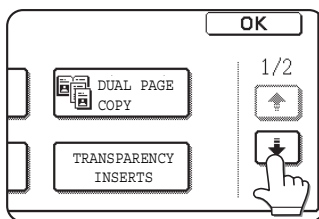

2 Touch the [B/W REVERSE] key in the second SPECIAL MODES screen.

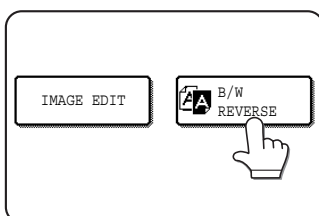

The [B/W REVERSE] key will be highlighted to indicate that the function is selected. In addition, the B/W reverse icon (A) will appear in the upper left-hand corner of the screen.

3 Touch the [OK] key on the SPECIAL MODES screen.

Return to the main screen of copy mode.

About the steps that follow

If a reversing automatic document feeder is being used, see pages 5-2 through 5-6. If the document glass is being used, see pages 5-7 through 5-9.

To cancel the B/W reverse function, touch the [B/W REVERSE] key in the SPECIAL MODES screen (the screen of step 2).

COLOR ADJUSTMENTS MENU

The [COLOR ADJUSTMENTS] menu in [SPECIAL MODES] enables the following parameters to be adjusted to modify the characteristics of a color copy.

Settings adjusted with the color adjustments menu do not affect black and white copying.

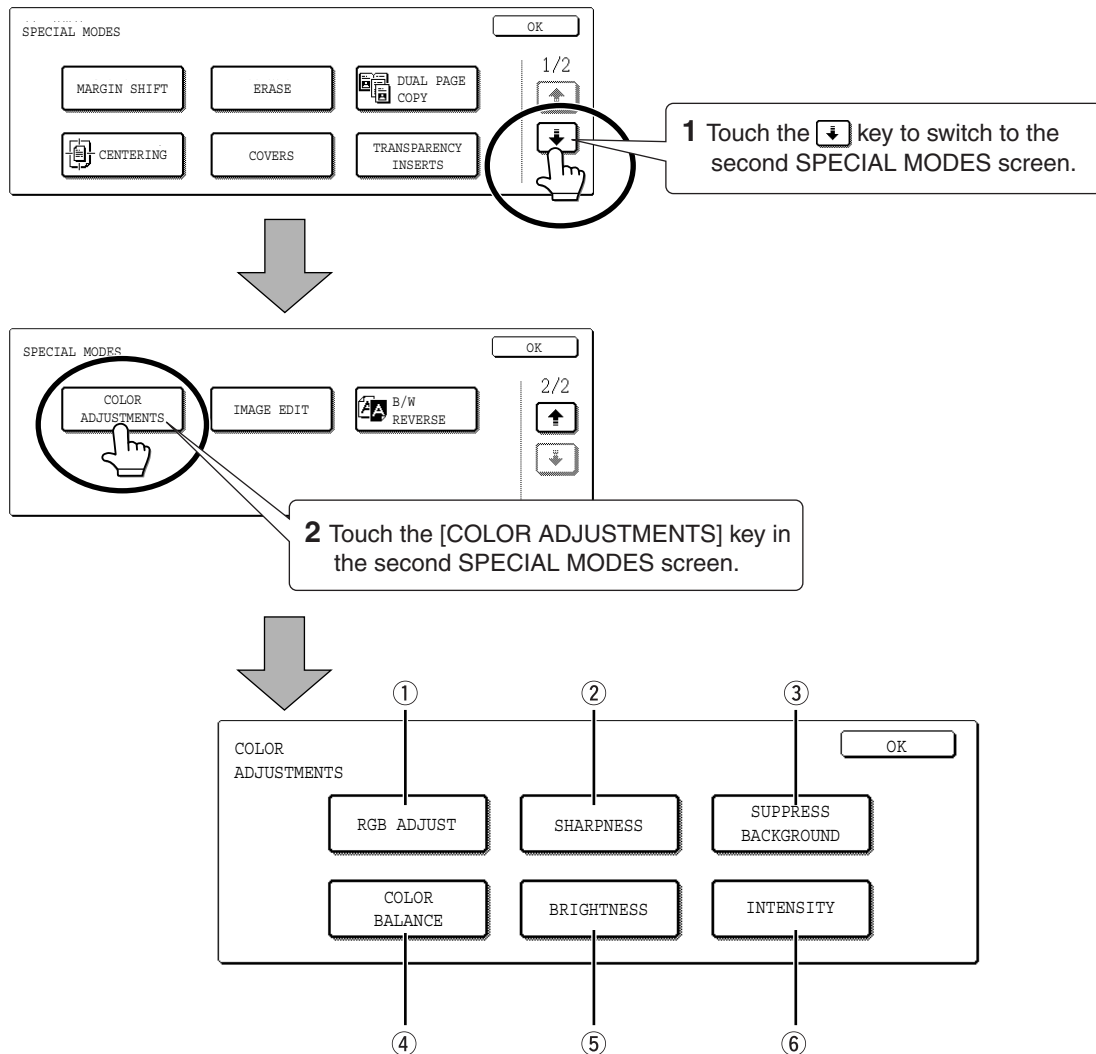

① **RGB ADJUST (next page 6-12)**

Strengthens or weakens one of three primary colors, R (red), G (green), or B (blue).

② **SHARPNESS (page 6-13)**

Sharpens or softens image outlines.

③ **SUPPRESS BACKGROUND (page 6-13)**

Suppresses copying of lighter background areas.

④ **COLOR BALANCE (page 6-14)**

Adjusts the color, tone, and density of color copies.

⑤ **BRIGHTNESS (page 6-15)**

This copier allows the level of brightness to be adjusted. If brightness is selected, color tone can be darkened or lightened.

⑥ **INTENSITY (page 6-15)**

This copier allows the level of intensity to be adjusted. If intensity is selected, color saturation can be made to be more vivid or more dull.

RGB adjust

Strengthens or weakens one of three primary colors, red (R), green (G), or blue (B).

- 1 Touch the [RGB ADJUST] key on the COLOR ADJUSTMENTS menu screen.

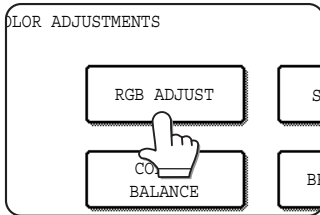

- 2 Select a color from R (RED), G (GREEN), and B (BLUE).

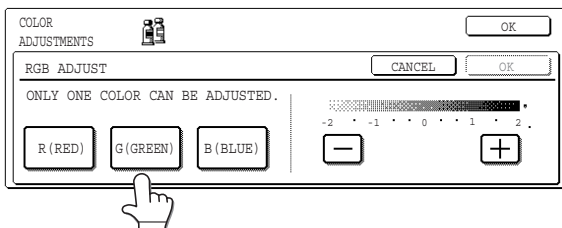

Only one primary color can be adjusted.

- 3 Adjust the selected color.

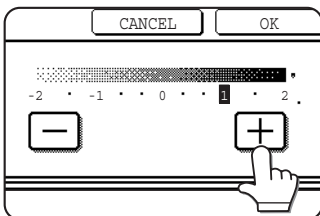

Touch the [+] to strengthen the selected color or touch the [-] key to weaken the color.

When the key is touched, the color adjustments menu icon () will appear at the upper left of the screen to indicate that the function is turned on.

- 4 Touch the [OK] key (inside [OK] key) on the RGB ADJUST setting screen.

Return to the COLOR ADJUSTMENTS menu screen.

- 5 Touch the [OK] key on the COLOR ADJUSTMENTS menu screen.

Return to the SPECIAL MODES screen.

- 6 Touch the [OK] key on the SPECIAL MODES screen.

Return to the main screen of copy mode.

About the steps that follow

If the reversing automatic document feeder is being used, see pages 5-2 through 5-6. If the document glass is being used, see pages 5-7 through 5-9.

In either case, press the [COLOR COPY START] key to begin copying.

To cancel the RGB ADJUST function, select the RGB ADJUST function again and touch the [CANCEL] key (step 2 or 3).

Sharpness

Sharpens or softens image outlines.

- 1 Touch the [SHARPNESS] key on the COLOR ADJUSTMENTS menu screen.

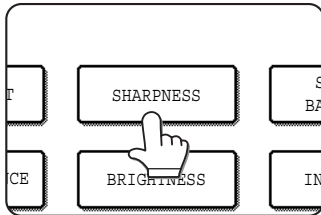

The SHARPNESS setting screen will appear. The color adjustments icon (🖨️) will also appear in the upper left of the screen to indicate that the function is turned on.

- 2 Touch the [SOFT] key to soften image outlines or touch the [SHARP] key to sharpen them.

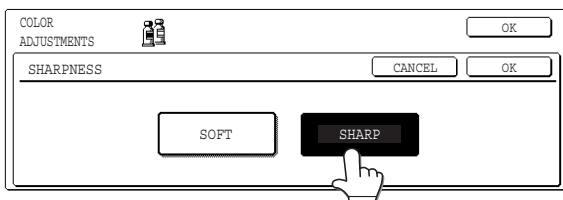

- 3 Touch the [OK] key (inside [OK] key) on the SHARPNESS setting screen.

Return to the COLOR ADJUSTMENTS menu screen.

- 4 Touch the [OK] key on the COLOR ADJUSTMENTS menu screen.

Return to the SPECIAL MODES screen.

- 5 Touch the [OK] key on the SPECIAL MODES screen.

Return to the main screen of copy mode.

About the steps that follow

If the reversing automatic document feeder is being used, see pages 5-2 through 5-6. If the document glass is being used, see pages 5-7 through 5-9.

In either case, press the [COLOR COPY START] key to begin copying.

To cancel the SHARPNESS function, select the SHARPNESS function again and touch the [CANCEL] key (step 2).

Suppress background

This copier can suppress unwanted background areas on the original images when copying.

- 1 Touch the [SUPPRESS BACKGROUND] key on the COLOR ADJUSTMENTS menu screen.

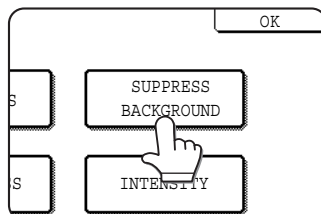

The SUPPRESS BACKGROUND setting screen will appear. The color adjustments icon (🖨️) will also appear in the upper left of the screen to indicate that the function is turned on.

- 2 Use the [+] and [-] keys to select the desired background suppression level.

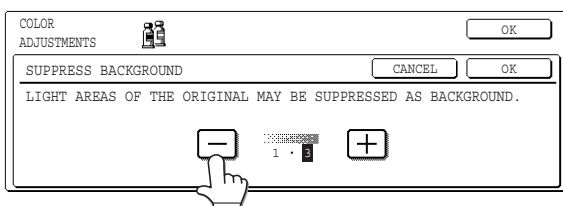

If level 1 is selected, darker background areas will be erased. The level can be adjusted in three steps. The default setting is level 3.

- 3 Touch the [OK] key (inside [OK] key) on the SUPPRESS BACKGROUND setting screen.

Return to the COLOR ADJUSTMENTS menu screen.

- 4 Touch the [OK] key on the COLOR ADJUSTMENTS menu screen.

Return to the SPECIAL MODES screen.

- 5 Touch the [OK] key on the SPECIAL MODES screen.

Return to the main screen of copy mode.

About the steps that follow

If the reversing automatic document feeder is being used, see pages 5-2 through 5-6. If the document glass is being used, see pages 5-7 through 5-9.

In either case, press the [COLOR COPY START] key to begin copying.

To cancel the SUPPRESS BACKGROUND function, select the SUPPRESS BACKGROUND function again and touch the [CANCEL] key (step 2).

Color balance

This function is used to adjust the color, tone, and density of color copies.

1 Touch the [COLOR BALANCE] key on the COLOR ADJUSTMENTS menu screen.

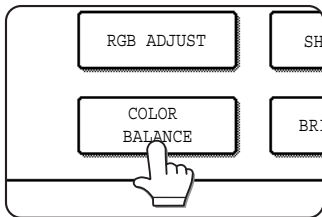

The COLOR BALANCE setting screen will appear.

2 Use the keys indicated in the illustration below to adjust the color balance settings.

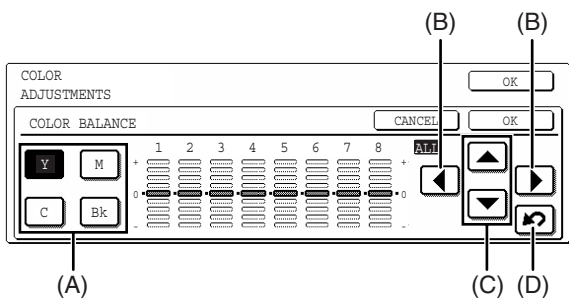

The Color Balance setting allows you to adjust the densities of four colors: cyan, magenta, yellow, and black.

The density range is divided into eight levels for each color, from 1 (lowest density areas) to 8 (highest density areas). The density can be adjusted one level at a time or eight levels at once.

(A) Use these keys to select the color to be adjusted ([C] = cyan, [M] = magenta, [Y] = yellow, [Bk] = black).

If only the area around the letter inside a key is highlighted, the settings have been changed from the factory default settings.

(B) Use these keys to change the densities of all eight levels at once.

When either key is touched, the indicator lines of all eight levels will move up or down one step.

(C) Use these keys to adjust the densities of each of the eight density levels.

When one of the keys is touched, the corresponding indicator line will move up or down one step. Touch the ▲ key to increase the density of the corresponding level, or the ▼ key to decrease the density.

(D) Use this key to return the densities of all eight levels to the initial settings.

The initial color balance settings are the values set with key operator program "Initial color balance setting" (See page 15 of the key operator's guide). For this reason, the initial settings may not necessarily be 0 (the middle indicator position) for all levels. The initial setting of each level is shown by a gray indicator.

When the color balance setting is adjusted, the color adjustments menu icon () will appear at the upper left of the screen to indicate that the function is turned on.

3 Touch the [OK] key (inside [OK] key) on the COLOR BALANCE setting screen.

Return to the COLOR ADJUSTMENTS menu screen.

4 Touch the [OK] key on the COLOR ADJUSTMENTS menu screen.

Return to the SPECIAL MODES screen.

5 Touch the [OK] key on the SPECIAL MODES screen.

Return to the main screen of copy mode.

About the steps that follow

If the reversing automatic document feeder is being used, see pages 5-2 through 5-6. If the document glass is being used, see pages 5-7 through 5-9.

In either case, press the [COLOR COPY START] key to begin copying.

To cancel the COLOR BALANCE function, select the COLOR BALANCE function again and touch the [CANCEL] key (step 2).

Brightness

This copier allows the level of brightness of images to be adjusted.

- 1 Touch the [BRIGHTNESS] key on the COLOR ADJUSTMENTS menu screen.

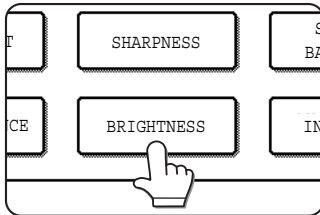

The BRIGHTNESS setting screen will appear.

- 2 Adjust the brightness.

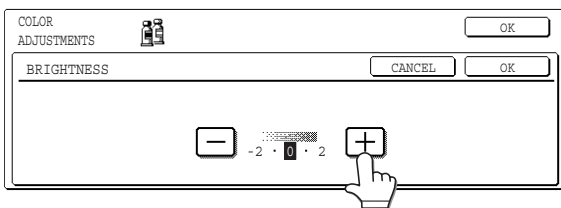

Use the [-] and [+] keys to adjust the level of the BRIGHTNESS.

When the key is touched, the color adjustments menu icon () will appear at the upper left of the screen to indicate that the function is turned on.

- 3 Touch the [OK] key (inside [OK] key) on the BRIGHTNESS setting screen.

Return to the COLOR ADJUSTMENTS menu screen.

- 4 Touch the [OK] key on the COLOR ADJUSTMENTS menu screen.

Return to the SPECIAL MODES screen.

- 5 Touch the [OK] key on the SPECIAL MODES screen.

Return to the main screen of copy mode.

About the steps that follow

If the reversing automatic document feeder is being used, see pages 5-2 through 5-6. If the document glass is being used, see pages 5-7 through 5-9.

In either case, press the [COLOR COPY START] key to begin copying.

To cancel the BRIGHTNESS function, select the BRIGHTNESS function again and touch the [CANCEL] key (step2).

Intensity

This copier allows the level of intensity of images to be adjusted.

- 1 Touch the [INTENSITY] key on the COLOR ADJUSTMENTS menu screen.

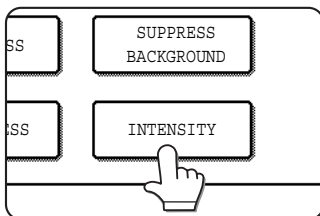

The INTENSITY setting screen will appear.

- 2 Adjust the intensity.

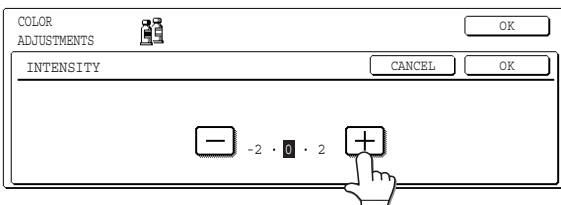

Use the [-] and [+] keys to adjust the level of the INTENSITY.

When the key is touched, the color adjustments menu icon () will appear at the upper left of the screen to indicate that the function is turned on.

- 3 Touch the [OK] key (inside [OK] key) on the INTENSITY setting screen.

Return to the COLOR ADJUSTMENTS menu screen.

- 4 Touch the [OK] key on the COLOR ADJUSTMENTS menu screen.

Return to the SPECIAL MODES screen.

- 5 Touch the [OK] key on the SPECIAL MODES screen.

Return to the main screen of copy mode.

About the steps that follow

If the reversing automatic document feeder is being used, see pages 5-2 through 5-6. If the document glass is being used, see pages 5-7 through 5-9.

In either case, press the [COLOR COPY START] key to begin copying.

To cancel the INTENSITY function, select the INTENSITY function again and touch the [CANCEL] key (step 2).

IMAGE EDIT MENU

To use the following convenient copy functions, touch the [IMAGE EDIT] key in [SPECIAL MODES].

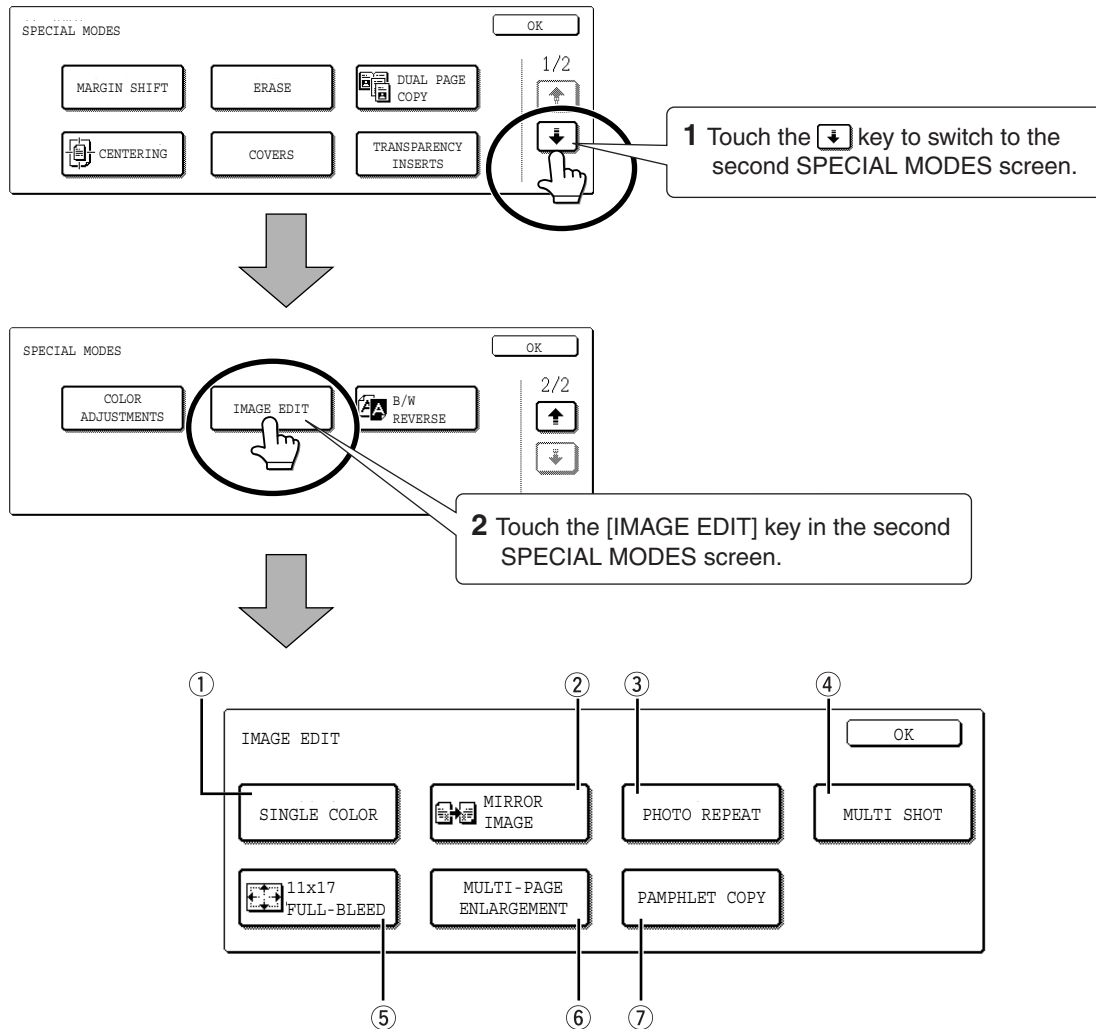

① **SINGLE COLOR (page 6-17)**

Produces copies with a selected single color.

② **MIRROR IMAGE (page 6-17)**

A mirror image of the original is printed.

③ **PHOTO REPEAT (page 6-18)**

Produces repeated images of a photo on a single sheet of copy paper.

④ **MULTI SHOT (page 6-19)**

The multi shot function is used to copy up to four originals, collectively in a specified order, per sheet of copy paper in any one of four layout patterns.

⑤ **11x17 FULL-BLEED (page 6-21)**

Produces 11" x 17" (A3) full image copies onto 12" x 18" (A3W) copy paper.

⑥ **MULTI-PAGE ENLARGEMENT (page 6-22)**

Enlarges an original image to a size larger than 11" x 17" (A3) and prints divided images onto multiple sheets of copy paper for assembly into large composite copy.

⑦ **PAMPHLET COPY (page 6-24)**

The pamphlet copy function is used to arrange copies in proper order for eventual center-stapling and folding into a booklet. Two original pages are copied onto each side of copy paper. Four pages are, therefore, copied onto one sheet.

(A duplex module/2 x 500 sheet paper drawer and a duplex bypass/inverter unit are required for this function.)

Single color

Produces copies with a selected single color.

- 1 Touch the [SINGLE COLOR] key on the IMAGE EDIT screen.

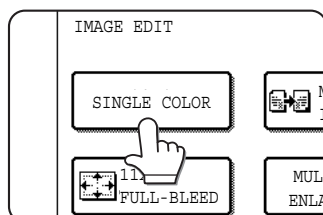

The SINGLE COLOR setting screen will appear.

- 2 Select the desired color.

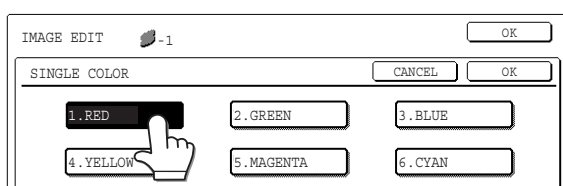

When one of the keys is touched, the single color icon (1) will appear at the upper left of the screen to indicate that the single color function is turned on. (The number that appears with the icon indicates the selected color, and is the number on the key of the selected color.)

- 3 Touch the [OK] key (inside [OK] key) on the SINGLE COLOR setting screen.

Return to the IMAGE EDIT menu screen.

- 4 Touch the [OK] key on the IMAGE EDIT menu screen.

Return to the SPECIAL MODES screen.

- 5 Touch the [OK] key on the SPECIAL MODES screen.

Return to the main screen of copy mode.

About the steps that follow

If the reversing automatic document feeder is being used, see pages 5-2 through 5-6. If the document glass is being used, see pages 5-7 through 5-9.

In either case, press the [COLOR COPY START] key to begin copying.

To cancel the SINGLE COLOR function, select the SINGLE COLOR function again and touch the [CANCEL] key (step 2).

Mirror image

This function is used to print a mirror image of the original. The images will be inverted in the right to left direction on the copies.

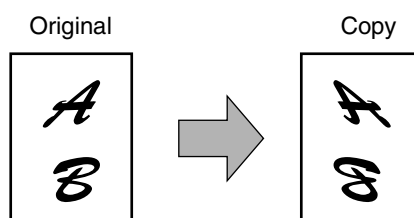

- 1 Touch the [MIRROR IMAGE] key on the IMAGE EDIT menu screen.

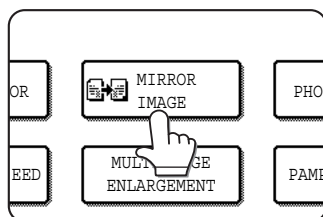

The [MIRROR IMAGE] key will be highlighted to indicate that the function is turned on, and the mirror image icon () will appear in the upper left of the screen.

- 3 Touch the [OK] key on the SPECIAL MODES screen.

Return to the main screen of copy mode.

About the steps that follow

If a reversing automatic document feeder is being used, see pages 5-2 through 5-6. If the document glass is being used, see pages 5-7 through 5-9.

To cancel the MIRROR IMAGE function, touch the MIRROR IMAGE again on the IMAGE EDIT menu screen (step 2).

- 2 Touch the [OK] key on the IMAGE EDIT menu screen.

Return to the SPECIAL MODES screen.

Photo Repeat

PHOTO REPEAT is used to produce repeated images of a photo on a single sheet of copy paper.

- Up to 24 repeats can be made on a single copy sheet. The number of copies on a single sheet depends on the original size and copy paper size.
- Reduction or enlargement cannot be selected with this function. If reduction or enlargement has been selected, the copy ratio will be reset to 100% when this function is selected.
- This function will not work when non-standard size paper is used.
- This function can only be used with 8-1/2" x 11" (A4) or 11" x 17" (A3) paper.

● **Original size (to 3" x 5" (130 x 90 mm))**

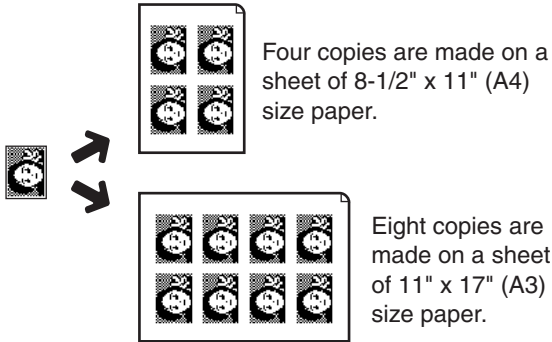

● **Original size (to 5" x 7" (100 x 150 mm))**

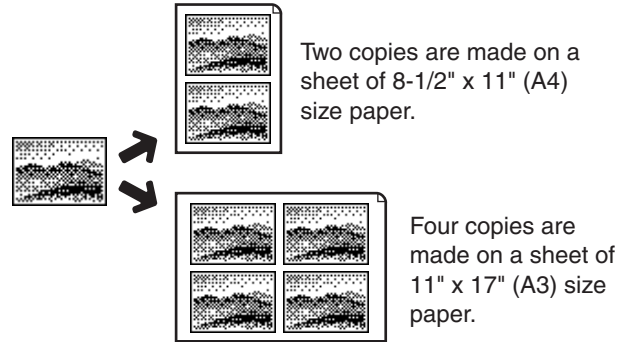

● **Original size (to 2-1/2" x 4" (70 x 100 mm))**

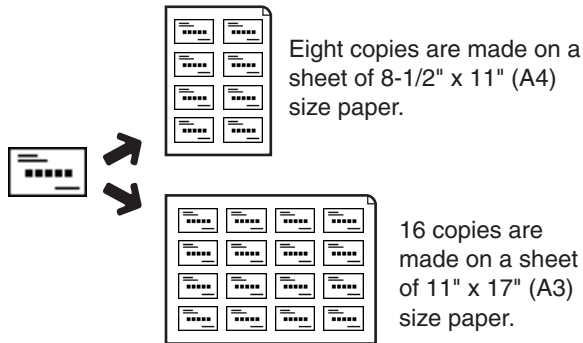

● **Original size (to 2-1/2" x 2-1/2" (65 x 70 mm))**

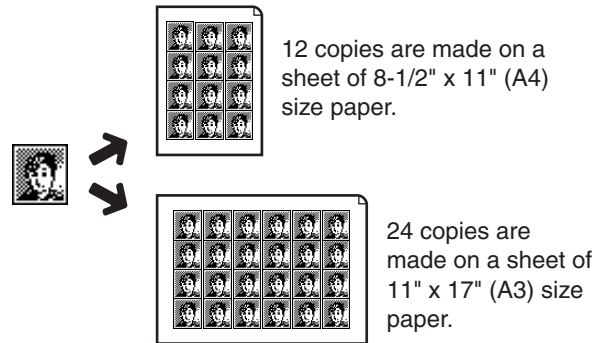

● **Original size (to 2-1/8" x 3-5/8" (57 x 100 mm))**

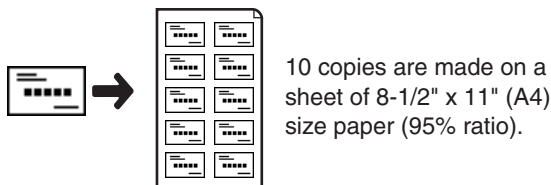

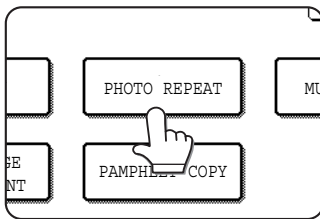

1 Touch the [PHOTO REPEAT] key on the IMAGE EDIT menu screen.



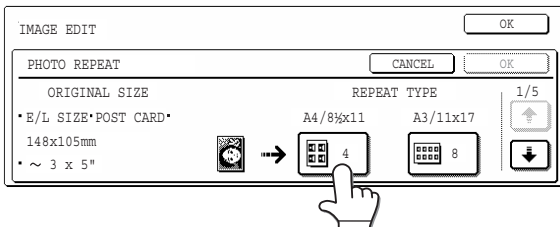

The PHOTO REPEAT setting screen will appear.

2 Touch the key for the desired combination of original type and paper size.



When any one of the keys is touched, the photo repeat icon ( , etc.) will appear at the upper left of the screen to indicate that the function is turned on.

If the key for the desired combination doesn't appear, touch the  or  key to scroll, and then touch the desired repeat type key (8-1/2" x 11" (A4) or 11" x 17" (A3)).

When making repeat copies of an original size (to 2-1/8" x 3-5/8" (57 x 100 mm)), only 8-1/2" x 11" (A4) can be selected for the paper size.

3 Touch the [OK] key (inside [OK] key) on the PHOTO REPEAT setting screen.

Return to the IMAGE EDIT menu screen.

4 Touch the [OK] key on the IMAGE EDIT menu screen.

Return to the SPECIAL MODES screen.

5 Touch the [OK] key on the SPECIAL MODES screen.

Return to the main screen of copy mode.

About the steps that follow

See pages 5-7 through 5-8.

NOTES

- Be sure to place the original on the document glass, The reversing automatic document feeder cannot be used for this function.
- Place ~2-1/2" x 4" (70 x 100mm), ~2-1/2" x 2-1/2" (65 x 70mm) and ~2-1/8" x 3-5/8" (57 x 100mm) originals as shown below.

Centering scale

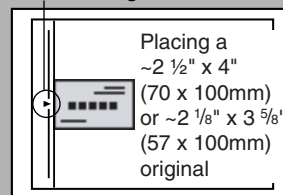

Centering scale

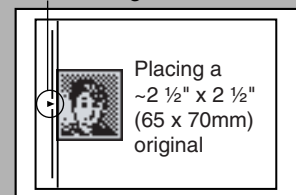

To cancel the PHOTO REPEAT function, select the PHOTO REPEAT function again and touch the [CANCEL] key (step 2).

Multi shot

The multi shot function is used to copy up to four originals, collectively in a specified order, per sheet of copy paper in any one of four layout patterns.

[Example] Copying seven originals using the 4 in 1 MULTI SHOT selection in a layout pattern starting from the upper left to lower right.

One-sided copies from one-sided originals

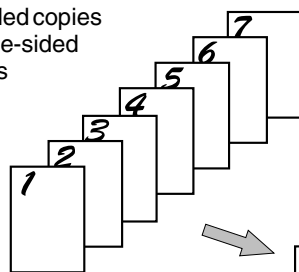

One-sided copies from two-sided originals

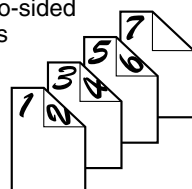

Copies

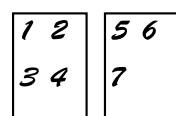

- When using the multi shot function, place the originals, select the desired paper size, and select the copying mode before selecting the multi shot function on the special modes screen.
- When using the multi shot function, the appropriate copy ratio will be automatically set based on the original size, paper size, and the number of originals to be copied onto one sheet. The minimum possible reduction ratio is 25%. Depending on the original size, paper size, and the number of originals to be copied onto one sheet, the copy ratio required to fit the original images onto one sheet may be smaller than 25%. In this case, a ratio of 25% will be used, and parts of the original images may be cut off.

1 Touch the [MULTI SHOT] key on the IMAGE EDIT menu screen.

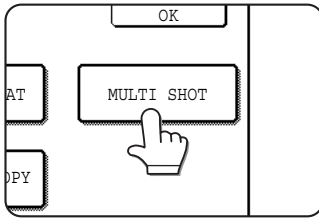

The MULTI SHOT setting screen will appear. The multi shot icon (1/2 3/4, etc.) will also appear in the upper left of the screen to indicate that the function is turned on.

2 Select the number of originals to be copied onto one sheet of copy paper on the multi shot selection screen.

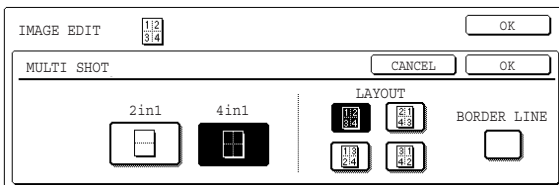

The orientation of copy paper and the image of the originals may be rotated as needed.

3 Select the layout.

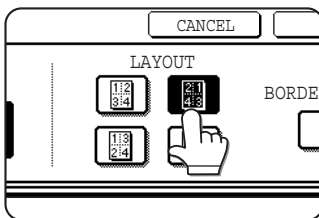

Select the order in which the originals will be arranged on the copy.

4 Select whether or not to add borderlines.

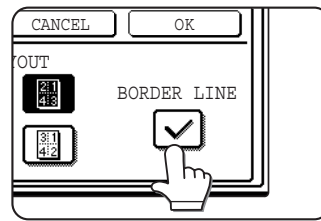

When the BORDER LINE checkbox is selected, borderlines are added around the borders of the images.

5 Touch the [OK] key (inside [OK] key) on the MULTI SHOT setting screen.

Return to the IMAGE EDIT menu screen.

6 Touch the [OK] key on the IMAGE EDIT menu screen.

Return to the SPECIAL MODES screen.

7 Touch the [OK] key on the SPECIAL MODES screen.

Return to the main screen of copy mode.

About the steps that follow

If a reversing automatic document feeder is being used, see pages 5-2 through 5-6. If the document glass is being used, see pages 5-7 through 5-9.

To cancel the multi shot function, touch the [CANCEL] key on the multi shot setting screen (step 2).

| Shot number | Layout |
|-------------|--------|
| 2in1 | |
| 4in1 | |

The arrows in the above diagram indicate the directions in which the images are arranged.

11" x 17" (A3) Full-bleed

In other copy modes, image loss will occur along the copy edges. When the 11" x 17" (A3) FULL-BLEED function is used, the full image of an 11" x 17" (A3) size original will be copied onto 12" x 18" (A3W) size copy paper.

The 11" x 17" (A3) FULL-BLEED function can only be used when the original is placed on the document glass. (The reversing automatic document feeder cannot be used.)

Reduction or enlargement cannot be selected with this function. If reduction or enlargement has been selected, the copy ratio will be reset to 100% when this function is selected.

Automatic two-sided copying is not possible.

Original (11" x 17" (A3)) size

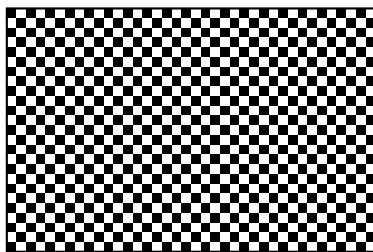

Copy (12" x 18" (A3W)) size

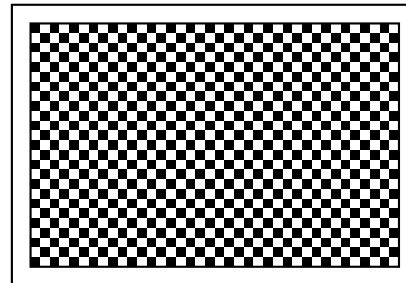

- 1** Touch the [11x17 FULL-BLEED] key on the IMAGE EDIT menu screen.

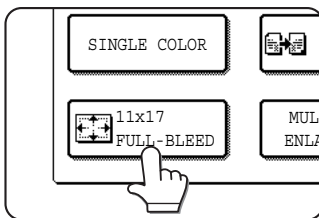

The [11x17 FULL-BLEED] key will be highlighted to indicate that the function is turned on, and the full-bleed icon () will appear in the upper left of the screen.

- 2** Touch the [OK] key on the IMAGE EDIT menu screen.

Return to the SPECIAL MODES screen.

- 3** Touch the [OK] key on the SPECIAL MODES screen.

Return to the main screen of copy mode.

- 4** Load 12" x 18" (A3W) copy paper into the bypass tray.

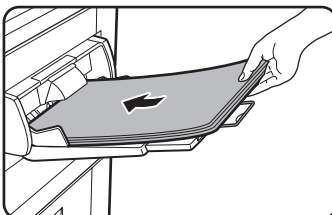

Adjust the bypass guide to 12" x 18" width before loading the paper. Remove any paper remaining in the tray. Pull out the tray extension and wire extension. (See page 2-4)

- 5** Touch the [PAPER SELECT] key on the touch panel and then select the paper type in the bypass tray.

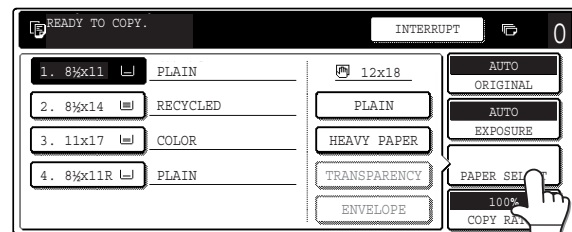

Touch the [PLAIN] key or the [HEAVY PAPER] key.

If you touched the [HEAVY PAPER] key, touch the [HEAVY PAPER1] key or the [HEAVY PAPER2] key as appropriate for the weight of the paper you loaded. (See step 3 on page 2-12.)

About the steps that follow

See pages 5-7 and 5-8.

Extend the copy receptacle and then begin copying.

To cancel the 11 x 17 (A3) FULL-BLEED function, touch the [11x17 FULL-BLEED] key again on the IMAGE EDIT menu screen (step 1).

Multi-page enlargement

This function is used to enlarge an original image to a size larger than 11" x 17" (A3) and print divided images onto multiple sheets of copy paper.

[Example]

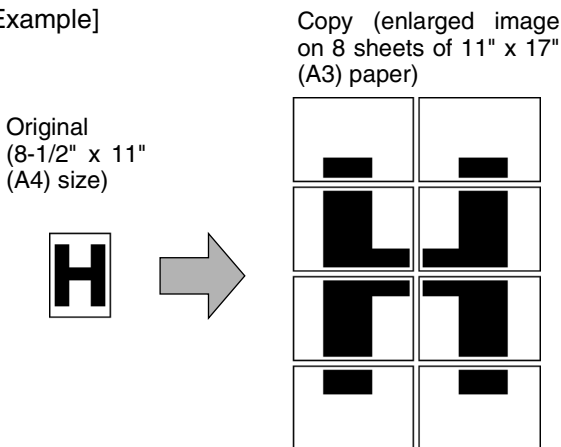

Overlap of sections of image

- There will be a margin around the edges of each copy.
- The original image will be divided and copied onto multiple sheets of paper. Areas for overlapping the copies will be made along the leading and trailing edges of each copy.

1 Touch the [MULTI-PAGE ENLARGEMENT] key on the IMAGE EDIT menu screen.

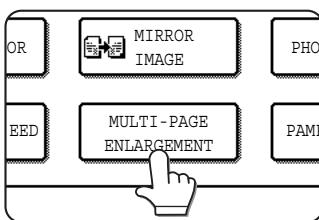

The MULTI-PAGE ENLARGEMENT setting screen will appear.

2 Select the size system for multi-page enlargement

Touch the or key to display the size settings of the desired size system.

Inch system

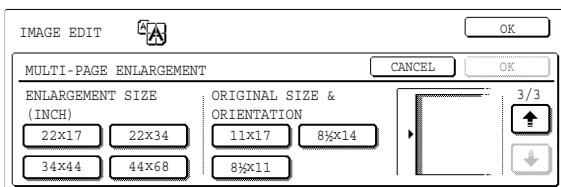

A system

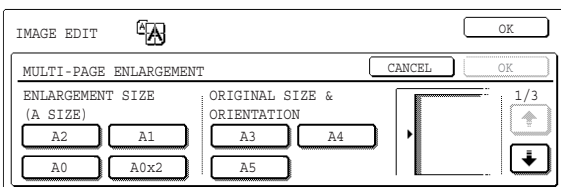

B system

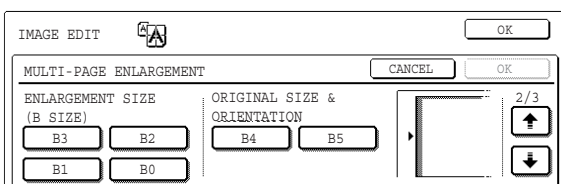

3 Set the enlargement size and the original size.

The order of selection can begin from the enlargement size or the original size. When the enlargement size and original size are set, the multi-page enlargement icon () will appear in the upper left of the screen to indicate that the function is turned on.

The combinations of original size and enlargement size for which multi-page enlargement is possible are as follows.

| | Enlargement size ↔ Original size |
|-------------|---|
| Inch system | 22 x 17 ↔ 11 x 17/8-1/2 x 14/8-1/2 x 11 |
| | 22 x 34 ↔ 11 x 17/8-1/2 x 14/8-1/2 x 11 |
| | 34 x 44 ↔ 11 x 17/8-1/2 x 14/8-1/2 x 11 |
| | 44 x 68 ↔ 11 x 17/8-1/2 x 14/8-1/2 x 11 |
| A system | A2 ↔ A3/A4/A5 |
| | A1 ↔ A3/A4/A5 |
| | A0 ↔ A3/A4 |
| | A0 x 2* ↔ A3 |
| B system | B3 ↔ B4/B5 |
| | B2 ↔ B4/B5 |
| | B1 ↔ B4/B5 |
| | B0 ↔ B4 |

Multi-page enlargement is not possible of an A-system size original to a B-system enlargement size, nor of a B-system size original to an A-system enlargement size.

*Indicates the size that is twice A0 size.

NOTES

- If an original size is selected first, a message will indicate the enlargement sizes that can be selected. If an enlargement size is selected first, a message will indicate the original sizes that can be selected.
- If a combination is selected for which multi-page enlargement is not possible, invalid selection beeps will be sounded.

4 Check the placement orientation and the number of copies

Example: Enlargement size = 22" x 17" (A2),
original size = 8-1/2" x 11" (A4)

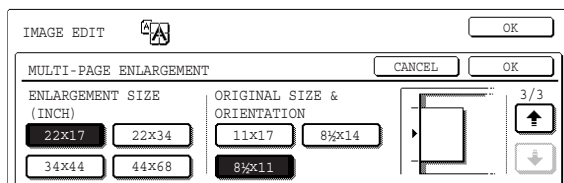

A suitable orientation for placement of the original and the number of sheets of paper required for the enlarged image are displayed based on the selected original size and enlargement size.

NOTES

- The paper size, number of sheets required for the enlarged image, and the ratio are automatically selected based on the selected original size and enlargement size. (The paper size and ratio cannot be selected by the operator.)
- The relations between the original size and enlargement size selected by the operator and the automatically selected paper size, number of sheets, and ratio are shown on the previous page.
- If no paper trays have the size of paper that was automatically selected, "Load XXX paper" will appear. Change the paper in one of the trays or the bypass tray to the indicated size of paper.

5 Place the original on the document glass in accordance with the indicated orientation. (page 4-6)

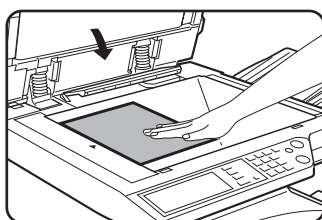

Multi-page enlargement is only possible using the document glass.

The reversing automatic document feeder cannot be used for this function.

6 Touch the [OK] key (inside [OK] key) on the MULTI-PAGE ENLARGEMENT setting screen.

Return to the IMAGE EDIT menu screen.

7 Touch the [OK] key on the IMAGE EDIT menu screen.

Return to the SPECIAL MODES screen.

8 Touch the [OK] key on the SPECIAL MODES screen.

Return to the main screen of copy mode.

About the steps that follow

See pages 5-7 and 5-8.

NOTE

Be sure to place the original on the document glass. The reversing automatic document feeder cannot be used for this function.

To cancel the MULTI-PAGE ENLARGEMENT function, select the MULTI-PAGE ENLARGEMENT function again and touch the [CANCEL] key (step 4).

Pamphlet copy

The pamphlet copy function is used to arrange copies in proper order for eventual center-stapling and folding into a booklet. Two original pages are copied onto each side of copy paper. Four pages are, therefore, copied onto one sheet. This function is convenient for arranging copies into an attractive booklet or pamphlet.

[Example] Copying eight originals in the pamphlet copy mode

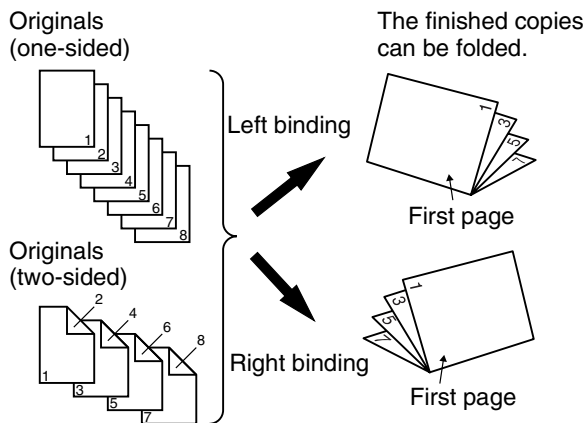

- Scan the originals in order from the first page to the last page. The order of copying will be automatically adjusted by the machine.
- Either left binding (opening from right to left) or right binding (opening from left to right) can be selected.
- Four originals will be copied onto one sheet. Blank pages may be automatically added at the end, depending on the number of the originals.
- A duplex module/2 x 500 sheet paper drawer and duplex bypass/inverter unit are required for this function.
- If a saddle stitch finisher is installed, copies can be stapled in two positions along the center of copies and folded at the center.

1 Touch the [PAMPHLET COPY] key on the IMAGE EDIT menu screen.

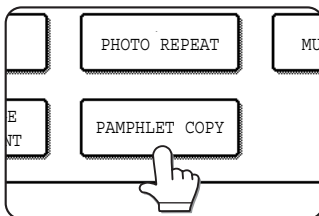

The PAMPHLET COPY setting screen will appear. The pamphlet copy icon (📄, etc.) will also appear in the upper left corner of the screen to indicate that the function is turned on.

2 Designate the type of originals to be copied: 1-sided or 2-sided.

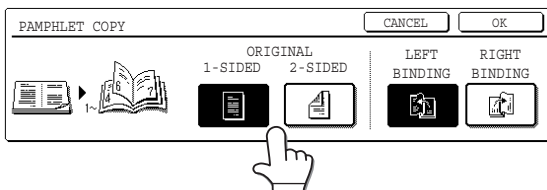

Select the [2-SIDED] key when you are using the reversing automatic document feeder to scan a two-sided original.

3 Select the binding position (left binding or right binding) and touch the [OK] key (inside [OK] key) on the PAMPHLET COPY setting screen.

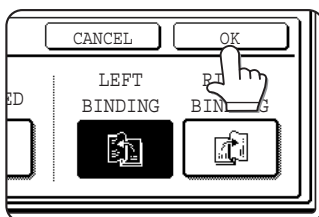

Return to the IMAGE EDIT menu screen.

4 Touch the [OK] key on the IMAGE EDIT menu screen.

Return to the SPECIAL MODES screen.

5 Touch the [OK] key on the SPECIAL MODES screen.

Return to the main screen of copy mode.

6 Place the original in the document feeder tray or on the document glass. (pages 4-6 to 4-9)

7 Ensure that the desired paper size has been automatically selected based on the original size.

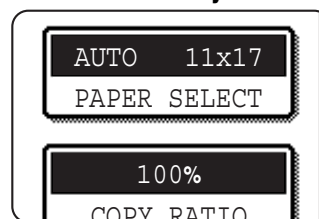

To select another size paper, select the desired size and touch the [AUTO IMAGE] key. The appropriate copy ratio will be selected automatically based on the original size and the paper size. (See steps 2 and 3 on page 5-12.)

8 Make all other desired settings such as exposure or the number of copies, and press the [START] key.

9 [When using the automatic document feeder:] Copying will start after all originals have been scanned. (The next step is not needed.)

[When using the document glass:]

Replace the original with the next original and press the [START] key. Repeat this operation until all originals have been scanned. Then touch the [READ-END] key.

When the pamphlet copy function is set, the two-sided copying mode will be automatically selected.

To cancel the pamphlet copy function, touch the [CANCEL] key on the pamphlet copy setting screen (step 2).

JOB PROGRAM MEMORY

Frequently used job programs can be stored in each of ten storage registers. This is convenient for quick job recall without losing time manually reprogramming each aspect of a job. Job programs can be recalled with ease, and the programs are retained even when the power is turned off. By programming frequently used copy settings, you can eliminate the bother of selecting the settings each time you use them for a copy job.

- Selection for functions stored as part of a job program, will not be recalled as part of the program if the function has been disabled or changed by a key operator program.
- To exit the job memory mode, press the [CA] (clear all) key on the operation panel or touch the [EXIT] key on the touch panel.

Storing a job program

1 Press the [#]/P key.

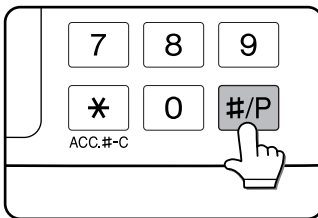

5 Touch the [OK] key.

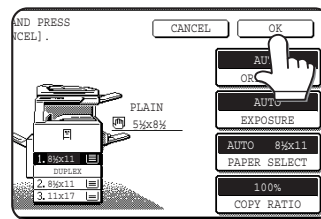

The selected settings will be stored under the register number selected in step 3.

2 Touch the [STORE/DELETE] key to obtain the storage register screen.

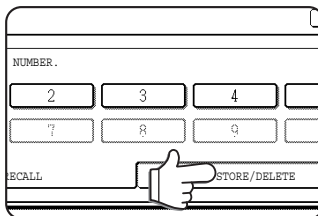

3 Touch a number key from 1 to 10 on the storage register screen.

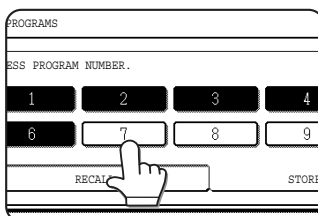

Highlighted storage register numbers are registers which already have programs stored.

4 Make all copier selections to be stored.

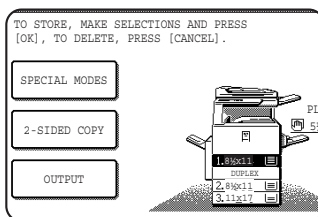

The number of copies cannot be stored.

If a number key is selected in step 3 that has already been programmed.

A setting confirmation screen will appear. To replace the existing program with the new program, touch the [STORE] key and continue from step 4. If you do not wish to replace the existing program, touch the [CANCEL] key to return to the screen of step 3 and select a different number key.

NOTE

If overwriting of programmed copy settings has been prohibited in the key operator programs, you will not be able to storing a job program. (See page 16 of the key operator's guide.)

Recalling a job program

1 Press the [# / P] key.

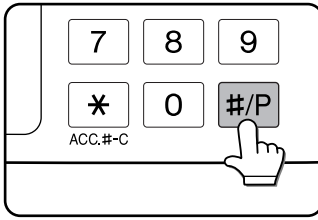

2 Touch the desired storage register number key to recall the job from memory.

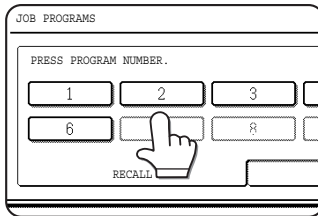

When a number key is touched, the selection screen will be closed and the stored job program will be recalled. A number for which no job program has been stored cannot be selected.

3 Set the number of copies as needed and press the [COLOR COPY START (●●●●)] or [BLACK COPY START (●●)] key.

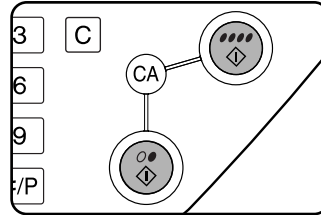

Copying will start with the settings of the recalled job program.

NOTE

If any settings related to the contents of a job program were changed in the key operator programs after the job program was stored, the changed settings will not be included when the job program is recalled.

Deleting a stored job program

1 Press the [# / P] key.

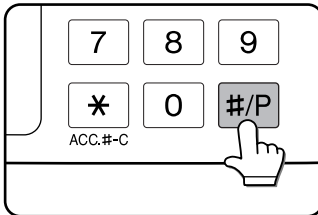

2 Touch the [STORE/DELETE] key to obtain the storage register screen.

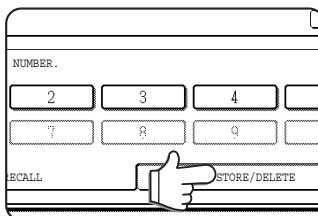

3 Select a storage register number of the program to be deleted.

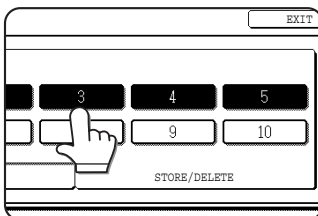

If a number key for which no job program has been stored is selected, the screen will change to the screen of step 4 on the previous page (for storing a job program).

4 Touch the [DELETE] key.

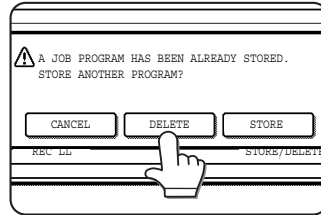

When the [DELETE] key is touched, the screen in step 3 will return and the program will be deleted. If the [CANCEL] key is touched, the screen in step 3 will return but the program will not be deleted. If no other programs are to be deleted, touch the [EXIT] key on the screen displayed in step 3 to exit the job program mode.

NOTE

If overwriting of programmed copy settings has been prohibited in the key operator programs, you will not be able to clear a job program. (See page 16 of the key operator's guide.)

INTERRUPTING A COPY RUN

INTERRUPT can be used to temporarily stop a long copy run so that another copy job can be run. It is not possible to interrupt an automatic two-sided copy job.

1 Touch the [INTERRUPT] key.

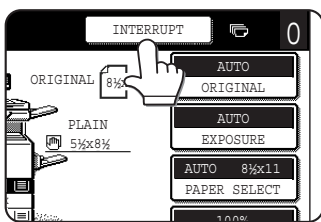

If the [INTERRUPT] key does not appear, interrupt copying is not possible.

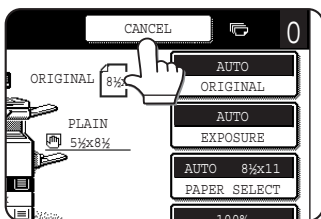

When the [INTERRUPT] key is touched in step 1, the [INTERRUPT] touch key will be replaced by the [CANCEL] key as shown in the illustration.

NOTES

- If you touch the [INTERRUPT] key when the account counter function is turned on, the display will prompt you to enter your account number. Enter your account number with the numeric keys. The copies you make will be added to the count of the entered account number.
- If the [INTERRUPT] key is touched while an original is being scanned, the interrupt state will begin after scanning is completed. If the [INTERRUPT] key is touched during copying, the interrupt state will begin after the copy is completed.
- Interrupt copying is not possible during automatic two-sided copying using the optional duplex module/2 x 500 sheet paper drawer. In addition, automatic two-sided copying is not possible during interrupt copying.

2 Place the original for the interrupt copy job in the document feeder or on the document glass (pages 4-6 to 4-9).

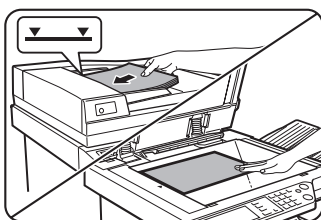

If a black and white copy job is being interrupted to run another black and white copy job, the number of originals that can be copied in the interrupt job is 35. (based on text original (A) on page 5-4)

3 Make all other desired settings such as exposure, paper size and number of copies and then press the [COLOR COPY START (●●●●)] or [BLACK COPY START (○●)]key.

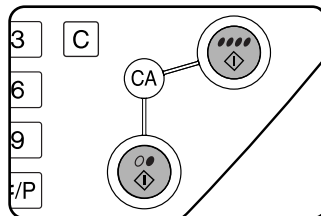

When making black and white copying using the document glass in the sort mode, replace the original with the next original and press the [BLACK COPY START] key. Repeat this operation until all originals have been scanned. Then, touch the [READ-END] key.

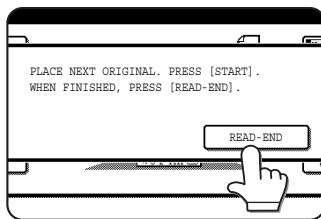

4 When the interrupt copy job is finished, touch the [CANCEL] key to turn off the interrupt copy state.

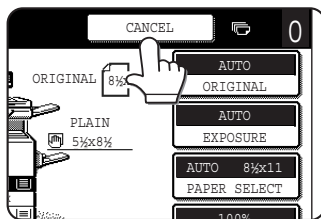

5 Resume the interrupted copy job.

If a color copy job was interrupted, replace the originals that have not yet been copied and resume copying.

If a black and white copy job was interrupted, replace the originals that have not yet been copied and press the [BLACK COPY START] key to resume copying.



CHAPTER 7

MACHINE MAINTENANCE (FOR COPYING)

This chapter explains procedures for removing misfeeds in a reversing automatic document feeder, cleaning the machine, and troubleshooting.

| | Page |
|---|------|
| REMOVING AN ORIGINAL MISFEED | 7-2 |
| • Removing a misfed original from the reversing automatic document feeder | 7-2 |
| USER MAINTENANCE (For copying)..... | 7-3 |
| TROUBLESHOOTING..... | 7-4 |

REMOVING AN ORIGINAL MISFEED

Removing a misfed original from the reversing automatic document feeder

If an original misfeed occurs in the reversing automatic document feeder, follow the steps below to remove the misfed original.

NOTES

- For misfeed removal in the main unit and other peripheral devices, see page 2-18.
- When a misfeed occurs, touch the [INFORMATION] key to display detailed information for misfeed removal.

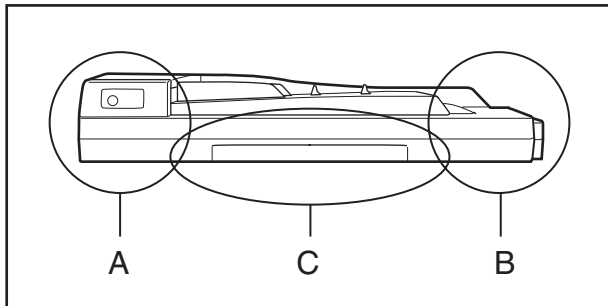

Check locations A, B, and C in the diagram at left to remove the original.

1 Removing misfeeds from each location

● Check location A

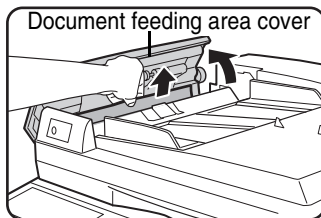

Open the cover of the document feeder and gently remove the original, taking care not to tear it.

● Check location B

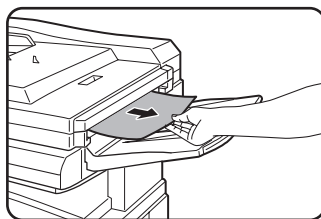

Remove the misfed original. If the original is difficult to remove, open the RADF exit area cover and then remove the original.

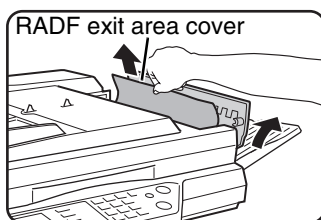

Open the RADF exit area cover and remove the misfed original.

● Check location C

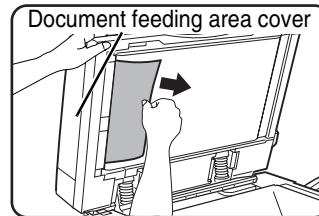

Open the document feeder cover and remove the misfed original. If the original is difficult to remove, open the document feeder cover and then remove the original.

2 Open and close the document feeder cover.

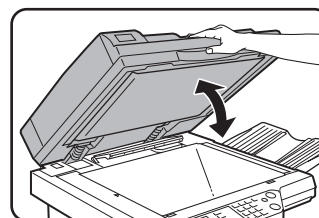

Opening and closing the cover clears the misfeed display. Copying cannot be resumed until this step is performed.

However, this step is not necessary after a misfeed is removed from location C.

A message may appear indicating the number of originals which must be returned to the document feeder tray. Return the originals to the document feeder tray and press the [START] key for color or black and white copying as appropriate for the job being resumed.

USER MAINTENANCE (For copying)

The document glass and the transport belt of the reversing automatic document feeder must be kept clean to avoid dirty areas from being copied onto the copies.

CAUTION

Do not use flammable spray to clean the machine. If gas from the spray comes in contact with hot electrical components or the fusing unit inside the machine, fire or electrical shock may result.

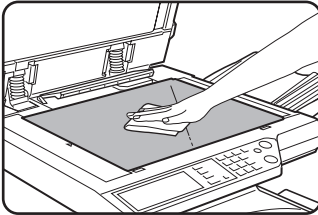

Wipe the document glass and the transport belt of the reversing automatic document feeder with a soft, clean cloth.

NOTE

When cleaning, do not use thinner, benzene, or similar volatile cleaning agents. These may degrade or discolor the housing.

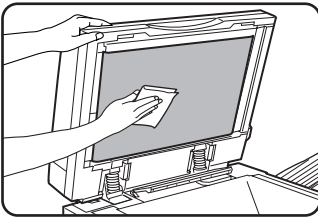

TROUBLESHOOTING

Whenever the machine stops or operation is not possible, check the operation panel display for messages. In most cases, these messages will give sufficient information to return the machine to an operating condition. In cases where this information is not enough, check the list below for more information. This section describes problems concerning copier features. For troubleshooting specific problems related to the printer or network scanner, and fax features, see the separate manuals provided for these features. For problems related to other peripheral devices, see page 2-24.

| Problem | Check | Solution or cause |
|--|---|--|
| Machine does not operate. | Are the [START] keys indicators off? | If the indicators are not on, the machine may be warming up. Warm-up should be completed in 99 seconds or less. |
| Copies are too dark or too light. | Is the original image too dark or too light? | Select an appropriate resolution setting for the original being copied and adjust the copy exposure. (See page 5-10) |
| | Is the exposure mode set to "AUTO"? | The exposure level for "AUTO" can be adjusted using the "Exposure adjustment" key operator program. Contact your key operator. (See page 15 of the key operator's guide.) |
| | An appropriate resolution setting for the original has not been selected. | Change the resolution setting to "AUTO" or manually select an appropriate resolution setting. (See page 5-10) |
| Text is not clear on a copy. | An appropriate resolution setting for the original has not been selected. | Change the resolution setting to "TEXT". |
| Moiré appears on a copy of a magazine, catalogue, or other printed material. | An appropriate resolution setting for the original has not been selected. | Change the resolution setting to "PRINTED PHOTO". |
| Text overlaying a photo is not clear on a copy of a map, magazine or other printed material. | An appropriate resolution setting for the original has not been selected. | Change the resolution setting to "MAP". |
| Smudges appear on copies. | Document glass or document cover dirty? | Clean the surface of the document glass, and the transport belt of the reversing automatic document feeder. (See page 7-3.) |
| | Original smudged or blotchy? | Use a clean original. |
| Image cannot be rotated. | Is the auto paper select or auto image function set? | Rotation copy functions only if the machine is either in the auto paper select mode or in the auto image mode. (See page 4-7.) |
| Part of original image is not copied. | Is the original positioned correctly? | Set the original properly. (page 4-6) |
| | Is the copy ratio proper for the original and paper sizes? | Use the auto image function to select the appropriate copy ratio based on the original and copy sizes. (See page 5-12.) |
| Blank copies | Is the original placed correctly? | When using the document glass, place the original face down. When using the reversing automatic document feeder, place original face up. |
| Order of copies incorrect | Is the order of originals correct? | When using the document glass, set the originals from the first page one sheet at a time. When using the reversing automatic document feeder, set the originals with the first page up. |

| Problem | Check | Solution or cause |
|---|--|--|
| Job cancelation needed | Is a message requesting cancelation of job displayed? | Press the [CA] (clear all) key to cancel the current job. |
| Scanning of originals is incomplete. | Is a message indicating memory is full displayed? | If the data amount exceeds the limit when using the pamphlet copy or multi shot copy which requires scanning of all originals, scanning will be canceled and copying will not be performed. If you install an additional memory, the storage capacity will increase. |
| The selected number of sets of copies is not printed. | For an interrupt copy job, are you attempting color copying in sort mode? | When color copying is performed in sort mode for an interrupt copy job, only one set of copies can be made. If more than one set is needed, replace the original and repeat the copy procedure for each set needed. |
| Not all pages are copied | When making copies, the memory became full during scanning of the originals and a message appears asking you whether you want to continue copying or cancel. | When the memory becomes full during scanning of the originals, you can select whether you want to continue the job and print only those originals that were scanned, or cancel the job. If you continue the job, copies will only be made of the originals that were scanned, and thus all originals cannot be copied at once. |

CHAPTER 8

SPECIFICATIONS

This chapter contains useful information about the machine.

| | Page |
|--|------|
| SPECIFICATIONS | 8-2 |
| • Copier and Main unit | 8-2 |
| • Reversing automatic document feeder | 8-4 |
| • Duplex bypass/inverter unit (optional) | 8-4 |
| INDEX | 8-5 |

SPECIFICATIONS

Copier and Main unit

| | |
|--|---|
| Type | Desktop (can be upgraded to console type if an optional stand is installed.) |
| Print system | Electrophotographic system (LED head system) |
| Photoconductive type | OPC drum |
| Developer system | Contact non-magnetic single-component development |
| Fusing system | Press roller fusing method |
| Resolution | Scan: 600 x 600 dpi, output: 600 x 600 dpi (However, if the "B/W 600dpi scanning mode for document feeder" checkbox is not selected in the key operator programs, scan: 600 x 300 dpi) |
| Gradation | Scan: Color; 256 levels, Black and white; 2 levels Printing: Color: Equivalent of 256 levels / Black and white: 2 levels (in copy mode) / Equivalent of 256 levels (in printer mode) |
| Originals | Sheets, bound documents Maximum size: 11" x 17" or A3 |
| Copy paper | Plain paper and special papers |
| Copy sizes | Max. 12" x 18" or A3wide, min. 5-1/2" x 8-1/2" or A6R Image loss: 4 mm ± 2 mm at edges |
| Warm-up time | 99 seconds or less |
| First-copy time* | Full color/single color copying : 8.0 seconds or less Black/white copying : 7.0 seconds or less |
| Copy ratio | Variable: 45 to 400% in 1% increments, total 356 steps Fixed presets: 25%, 50%, 64%, 77%, 100%, 121%, 129%, 200% and 400% for inch system, 25%, 50%, 70%, 81%, 86%, 100%, 115%, 122%, 141%, 200% and 400% for AB system. |
| Paper feed | A paper tray and bypass tray |
| Continuous copy | 999 copies; subtractive counter |
| Expansion DIMM slot | 1 slot (128 MB or 256 MB can be installed) |
| Required power supply | USA: AC120V, 60Hz, 12A Other countries: Local voltage ±10% (For power supply requirements, see the name plate located on the right hand side at the rear of the main unit.) |
| Power consumption | Max. 1.5 kW |
| Dimensions | 26-25/64" (W) x 26-5/8" (D) x 30-5/8" (H) (670 mm (W) x 676 mm (D) x 778 mm (H)) |
| Weight (Not including toner cartridge) | Approx. 194.0 lbs. (Approx. 88.0kg) |
| Overall dimensions | 53-1/8" (W) x 26-5/8"(D) (1349 mm (W) x 676 mm (D)) |
| Operating conditions | Temperature: 59°F to 86°F (15°C to 30°C), Humidity: 20% to 80% |

* The indicated first-copy time assumes the following conditions:

Upper tray at paper intake / horizontal feeding of 8-1/2" x 11" (A4) size paper / no pre-scan / left tray / transfer belt: black copy position

The first-copy time is slower when making copies on transparency film, heavy paper, or other special paper in the bypass tray.

Continuous copying speed (when the offset function is not used)

| | Black and white copying | Color copying |
|---|---------------------------|---------------------------|
| Copy paper size | 100% / Reduced / Enlarged | 100% / Reduced / Enlarged |
| 11" x 17" (A3) | 15 copies/min. | 13 copies/min. |
| 12" x 18" (A3 wide) | 7 copies/min. | 7 copies/min. |
| 8-1/2" x 14" (B4), 8-1/2" x 13" | 17 copies/min. | 15 copies/min. |
| 8-1/2" x 11" (A4) | 32 copies/min. | 26 copies/min. |
| 8-1/2" x 11"R (A4R) | 22 copies/min. | 19 copies/min. |
| B5 | 32 copies/min. | 26 copies/min. |
| 7-1/4" x 10-1/2"R (B5R) | 22 copies/min. | 19 copies/min. |
| 8-1/2" x 5-1/2" (A5) | 32 copies/min. | 26 copies/min. |
| Transparencies (fast speed setting*) (8-1/2" x 11" (A4)) | 26 copies/min. | 26 copies/min. |
| Transparencies (high resolution setting) (8-1/2" x 11" (A4)) | 13 copies/min. | 13 copies/min. |
| Heavy paper 1,2 (8-1/2" x 11" (A4)) | 13 copies/min. | 13 copies/min. |

* The continuous copying speed when the fastest copying conditions are used.

Output tray specifications

| | |
|--|--|
| Output method | Center tray: Face-down output Left tray: Face-up output |
| Maximum number of sheets (8-1/2" x 11" (A4) size/ recommended paper for color) | Center tray: 500 sheets Left tray: 250 sheets |
| Paper type | Center tray: Plain paper (including recommended paper for color) and heavy paper 1 (28 to 54 lbs.) (106 to 200 g/m ²) Left tray: Plain paper and special paper |
| Paper size | Center tray: 12" x 18", 11" x 17", 8-1/2" x 14", 8-1/2" x 11", 8-1/2" x 11"R, 7-1/4" x 10-1/2"R, 8-1/2" x 5-1/2" (A3W, A3, B4, A4, A4R, B5, B5R, A5, A6R) Left tray: 12" x 18", 11" x 17", 8-1/2" x 14", 8-1/2" x 11", 8-1/2" x 11"R, 7-1/4" x 10-1/2"R, 8-1/2" x 5-1/2" (A3W, A3, B4, A4, A4R, B5, B5R, A5, A6R) |
| Paper weight | Center tray: 17 to 54 lbs. (64 to 200 g/m ²) Left tray: 17 to 80 lbs. (64 to 300 g/m ²) |

Acoustic Noise Emission* (measurement according to ISO7779)

| Sound power level _{L_{WA}} | Printing mode | | Standby mode |
|---|---------------|---------------|---------------|
| | Black/White | Color | |
| | | 6.8 B or less | 6.3 B or less |

* Measurement conditions: The duplex module/2 x 500 sheet paper drawer option is installed and paper is fed from paper tray 1.

Emission Concentration (measurement according to RAL-UZ62: Edition Jan. 2002)

| | |
|---------|---------------------------------|
| Ozone | 0.02 mg/m ³ or less |
| Dust | 0.075 mg/m ³ or less |
| Styrene | 0.07 mg/m ³ or less |



Reversing automatic document feeder

| | |
|-----------------|---|
| Original sizes | 5-1/2" x 8-1/2" to 11" x 17" (A5 to A3) |
| Original weight | One-sided original : 14 to 54 lbs. (50 to 200 g/m ²) Two-sided original : 14 to 42 lbs. (50 to 156 g/m ²) |
| Capacity | Up to 100 sheets (8-1/2" x 11", 21 lbs. (A4, 80 g/m ²)) Up to 60 sheets (8-1/2" x 14" or larger, 21 lbs. (B4 or larger, 80 g/m ²)) For originals heavier than 21 lbs. (80 g/m ²), the total thickness must not exceed 13/32" (10 mm). However, for originals that are larger than 8-1/2" x 14" (B4), the total thickness must not exceed 1/4" (6 mm). |
| Power supply | Supplied from machine |
| Dimensions | 32-3/8" (W) x 20" (D) x 4-13/16" (H) (822 mm (W) x 508 mm (D) x 121 mm (H)) |
| Weight | Approx. 26.5 lbs. (Approx. 12 kg) |

Duplex bypass/inverter unit (optional)

| | |
|---------------------------|--|
| Number of sheets | 1 sheet (non-stack method) |
| Paper size | Face-up output: Same as paper feed specifications of machine Face-down output: 12"x18", 11"x17", 8-1/2"x14", 8-1/2"x13", 8-1/2"x11", 8-1/2"x11"R, 7-1/4"x10-1/2"R, 8-1/2"x5-1/2", A3W, A3, B4, A4, A4R, B5, B5R, A5 |
| Page weight | Face-up output: 17 to 80 lbs. (64 to 300 g/m ²) Face-down output: 17 to 54 lbs. (64 to 200 g/m ²) |
| Transport reference point | Center reference point |
| Dimensions | 6-5/32" (W) x 17-29/64" (D) x 17-1/64" (H) (156 mm (W) x 443 mm (D) x 432 mm (H)) |
| Weight | Approx. 14.3 lbs. (Approx. 6.5 kg) |

As a part of our policy of continuous improvement, SHARP reserves the right to make design and specification changes for product improvement without prior notice. The performance specification figures indicated are nominal values of production units. There may be some deviations from these values in individual units.

INDEX

| | |
|------------------------------|------------|
| [#/P] key | 4-3 |
| [✖] key | 4-3 |
| 1-sided copies | 5-2, 5-7 |
| 11" x 17" Full-bleed | 6-16, 6-21 |
| 256 MB optional memory | 1-7 |

■ A

| | |
|---|--------------|
| ACC.#-C | 1-11 to 1-12 |
| Acceptable originals | 4-5 |
| Account number | 1-12 |
| Address control | 2-13 |
| Applicable paper sizes | 2-9 to 2-10 |
| Applicable paper types | 2-9 to 2-10 |
| Auditing mode | 1-11 |
| Auto (resolution) | 5-10 |
| Auto image | 5-12, 6-24 |
| Auto power shut-off mode | 1-3 |
| Automatic copy image rotation | 4-7 |
| Automatic exposure adjustment | 5-11 |
| Automatic selection (reduction/enlargement) | 5-12 |
| Automatic two-sided copying | |
| - Document glass | 5-9 |
| - Reversing automatic document feeder | 5-6 |
| Automatic two-sided printing | 2-8, 2-10 |

■ B

| | |
|------------------------------|------------|
| Binding change | 5-9 |
| [BLACK COPY START] key | 1-8, 4-3 |
| Black toner | 2-15 |
| Book original | 6-6 |
| Brightness | 6-11, 6-15 |
| Bypass tray | 1-4, 2-24 |
| B/W reverse | 6-10 |

■ C

| | |
|---|---------------|
| [C] key | 4-3 |
| [CA] key | 4-3 |
| Call for service | 2-24 |
| Center erase | 6-5 |
| Center tray | 1-4, 3-6, 5-5 |
| Centering | 6-2, 6-7 |
| Changing the paper size | 2-2 |
| Checkmark | 2-14 |
| Clear all key | 4-3 |
| Clear key | 4-3 |
| Clock adjust | 2-14 |
| Color adjustments menu | 6-2, 6-11 |
| Color balance | 6-11, 6-14 |
| [COLOR COPY START] key | 1-8, 4-3 |
| Color deviations occur | 2-24 |
| Common operation procedure for using the special functions .. | 6-3 |
| Contents | 0-5 |
| Continuous copying speed | 8-3 |
| [COPY] key | 4-3 |
| Copy mode | 4-4 |
| Copy mode output restrictions | 5-4 |
| Copy output | 5-5 |
| Copy ratio | 5-12 |
| Copy ratio display | 4-4 |
| Copy ratio selection | 5-13 |

| | |
|------------------------------------|-----------|
| Copying from the bypass tray | 5-17 |
| Covers | 6-2, 6-9 |
| Custom settings | 1-8, 2-13 |
| Cyan toner | 2-15 |

■ D

| | |
|--|----------------|
| Deleting a stored job program | 6-27 |
| Detail | 1-10 |
| Display contrast | 2-14 |
| Display switching | 1-10 |
| Disposal of hole punch scrap | 3-9 |
| Document feeder tray | 4-2, 4-6 |
| Document feeding area cover | 4-2, 7-2 |
| Document glass | 4-2 |
| - 1-sided copies | 5-7 |
| - Automatic two-sided copying | 5-9 |
| - Setting originals | 4-6 |
| - User maintenance | 7-3 |
| Does not operate | 2-24 |
| Dual page copy | 6-2, 6-6 |
| Duplex bypass/inverter unit | 1-6, 2-22, 8-4 |
| Duplex module/2 x 500 sheet paper drawer | 1-6, 2-8, 2-22 |

■ E

| | |
|--|------------------------|
| Enable auto size detection | 2-12 |
| Energy saving features | 1-3 |
| Energy Star guidelines | 1-3 |
| Enlargement | 5-12 |
| Envelopes | 2-6, 2-9 to 2-10, 5-17 |
| Erase | 6-2, 6-5 |
| Erase the shadow lines on copies | 6-5 |
| Exit tray | 0-3, 1-4, 1-6, 2-20 |
| Exposure | 4-4, 5-10 |
| Exposure adjustments | 5-10 |

■ F

| | |
|---|------------|
| Face-up and face-down output | 1-7 |
| Facsimile expansion kit | 1-7 |
| Fast printing | 2-12 |
| Fax data forward | 2-13 |
| Fax memory | 1-7 |
| Fax receive settings | 2-13 |
| Features | 1-2 |
| Finisher tray | 3-6 |
| Folded postcards | 2-10 |
| Front cover | 1-4 |
| Fusing unit | 1-5, 2-7 |
| Fusing unit pressure adjusting levers | 2-6 to 2-7 |

■ G

| | |
|----------------------|---------------------------|
| Grayed out key | 1-9 |
| Group | 3-4, 3-6, 5-3 to 5-5, 5-8 |

■ H

| | |
|---|-------------------|
| Heavy paper | 2-9 to 2-10, 2-12 |
| High quality image | 2-12 |
| Highlighted for visual confirmation | 1-9 |
| Hole punching (Punch unit) | 3-5 to 3-6 |

I

| | |
|---|------------|
| Icon | 1-9 |
| If the machine is to be left unused for a long time.. | 0-3 |
| Image edit menu | 6-2, 6-16 |
| Image send | 1-8 |
| Information | 2-18 |
| Insert sheets..... | 6-8 |
| Installation requirements | 0-2 |
| Intensity..... | 6-11, 6-15 |
| Interior | 1-5 |
| Interrupt..... | 4-4, 6-27 |

J

| | |
|--------------------------|--------------|
| Job program memory | 6-25 to 6-26 |
| Job status..... | 1-8 |
| Job status screen | 1-10 |

K

| | |
|----------------------------|------|
| Key operator program | 2-13 |
| Keyboard select | 2-14 |

L

| | |
|--|-------------------|
| Landscape..... | 1-2 |
| Large capacity tray..... | 1-6, 3-15 to 3-17 |
| Left side cover..... | 1-4 |
| Left side cover release | 1-4 |
| Left tray | 1-4, 5-5 |
| List print..... | 2-14 |
| Loading paper in the bypass tray | 2-4 to 2-6, 2-12 |
| Loading paper | |
| - Bypass tray | 2-4 |
| - Duplex module/2 x 500 sheet paper drawer | 2-8 |
| - Large capacity tray..... | 3-16 |
| - Paper tray 1 | 2-2 |
| - Stand/1 x 500 sheet paper drawer..... | 2-7 |
| - Stand/3 x 500 sheet paper drawer..... | 2-7 |
| Loading postcards..... | 2-4 to 2-6 |

M

| | |
|--|--------------|
| Magenta toner | 2-15 |
| Main features | 1-2 |
| Main screen..... | 4-4 |
| Manual exposure adjustment | 5-10 |
| Manual selection (reduction/enlargement) | 5-13 |
| Map | 5-10 |
| Margin shift..... | 6-2, 6-4 |
| Meaning of "R" | 1-2 |
| Message..... | 2-24 |
| Mirror image | 6-16 to 6-17 |
| Misfed original | 7-2 |
| Misfeed removal..... | 2-18 |
| - Duplex bypass/inverter unit..... | 2-22 |
| - Duplex module/2 x 500 sheet paper drawer ... | 2-22 |
| - Exit area..... | 2-20 |
| - Fusing area..... | 2-20 |
| - Large capacity tray..... | 3-17 |
| - Paper feed area | 2-19 |
| - Saddle stitch finisher..... | 3-10 |
| - Stand/1 x 500 sheet paper drawer..... | 2-21 |
| - Stand/3 x 500 sheet paper drawer..... | 2-21 |

| | |
|---|-----------------|
| - Transport area | 2-20 |
| Mode select..... | 1-8, 4-3 to 4-4 |
| More information on plain paper | 2-10 |
| More information on special media | 2-10 |
| Moving this machine | 0-3 |
| Multi shot..... | 6-16, 6-19 |
| Multi-page enlargement | 6-16, 6-22 |

N

| | |
|--|-------------------|
| Non-standard size | 2-9 to 2-11, 6-24 |
| Number of copy sheets used by each account ... | 1-11 |
| Number of scannable originals..... | 5-4 |
| Numeric keys | 4-3 |

O

| | |
|-----------------------------------|--------------------|
| Offset..... | 3-4, 3-6, 5-5 |
| Offset tray..... | 3-2 |
| Operation panel..... | 1-8, 4-3 |
| Original feed display..... | 4-4 |
| Original guides | 4-2, 4-6 |
| [ORIGINAL] key | 4-4, 4-8, 4-9 |
| Original reminder indicator | 4-2, 4-6 |
| Original size | 4-4, 4-5, 4-8, 4-9 |
| Output | 4-4, 5-3, 5-5, 5-8 |
| Output tray | 1-4 |
| Output tray specifications..... | 8-3 |

P

| | |
|---|------------------|
| Pamphlet copy | 6-16, 6-24 |
| Paper curled..... | 2-25 |
| Paper recommended for color..... | 2-9 |
| Paper select display | 4-4 |
| [PAPER SELECT] key | 4-4, 5-2, 5-7 |
| Paper size slide..... | 2-2 |
| Paper tray 1..... | 2-2, 2-19 |
| Paper tray..... | 1-4 |
| Part names and functions | |
| - Exterior..... | 1-4 |
| - Interior..... | 1-5 |
| - Large capacity tray..... | 3-15 |
| - Operation panel (Copier Operation)..... | 4-3 |
| - Operation panel (General Information) | 1-8 |
| - Reversing automatic document feeder | 4-2 |
| - Saddle stitch finisher..... | 3-2 |
| Peripheral devices..... | 1-6 |
| Photo..... | 5-10 |
| Photo Repeat | 6-16, 6-18 |
| Plain paper | 2-9 to 2-10 |
| Portrait..... | 1-2 |
| Postcards | 2-4 to 2-6, 5-17 |
| Postcards with a coated front..... | 2-10 |
| Power switch | 1-4 |
| Preheat mode..... | 1-3 |
| Preset reduction/enlargement ratios | 5-13 |
| Pressure adjusting levers..... | 2-6 to 2-7 |
| Print..... | 1-8 |
| Print job | 1-10 |
| Printed photo | 5-10 |
| Priority | 1-10 |

■ Q

Quality mode 2-12

■ R

RADF exit area..... 4-2

RADF exit area cover 4-2, 7-2

Read-end 5-8

Recalling a job program 6-27

Reduction/enlargement..... 5-12

Registration adjustment 2-24

Replacing the toner cartridges 2-15

Reversing automatic document feeder 1-6, 4-2

- 1-sided copies..... 5-2

- Acceptable originals..... 4-5

- Automatic two-sided copying 5-6

- Misfed original..... 7-2

- Setting originals 4-6

- Specifications..... 8-4

RGB adjust..... 6-11 to 6-12

Right cover of paper drawer..... 1-5

Right side cover 1-5

Rotation copying 4-7

■ S

Saddle stitch..... 3-5, 3-14

Saddle stitch finisher 1-6, 3-2 to 3-14

Saddle stitch function 3-5

Saddle stitch tray..... 3-2

Scanner job 1-10

Selecting the output tray 5-5

Selecting the resolution..... 5-10

Selection of function 1-9

Setting originals..... 4-6

Setting the paper size

- Bypass tray 2-12

- Extra size 2-11

Setting the paper type 2-11

Sharpness 6-11, 6-13

Single color 6-16 to 6-17

Size slide..... 2-2

Sort..... 3-4, 3-6, 5-3 to 5-5, 5-8

Special modes..... 4-4, 6-2

Special papers 2-9 to 2-10, 5-17

Specifications 8-2

- Duplex bypass/inverter unit..... 8-4

- Duplex module/2 x 500 sheet paper drawer 2-8

- Large capacity tray..... 3-15

- Reversing automatic document feeder 8-4

- Saddle stitch finisher..... 3-2

- Stand/1 x 500 sheet paper drawer..... 2-7

- Stand/3 x 500 sheet paper drawer..... 2-7

Specifications of paper trays 2-9

Speed mode..... 2-12

Stand/1 x 500 sheet paper drawer 1-6, 2-7, 2-21

Stand/3 x 500 sheet paper drawer 1-6, 2-7, 2-21

Stand/paper drawer..... 0-3

Standard sizes 1-2, 2-9 to 2-10

Standard sizes in both the inch and AB systems... 1-2

Standard supplies 2-17

Staple cartridge 3-3

Staple cartridge replacement 3-7

Staple jam removal 3-8

Staple sort 3-4, 3-6

Stapler compiler 3-2

Stapler section 3-2

Stapling position quick reference guide 3-13

Stapling positions 3-4

[START] key..... 4-3, 5-3

Stop/delete 1-10

Storage of supplies 2-17

Storing a job program..... 6-26

Suppress background 6-11, 6-13

■ T

Text 5-10

Text/photo 5-10

Text/prtd.photo 5-10

The machine does not operate 2-24

To make darker copies..... 5-11

To make lighter copies 5-11

Toner cartridge..... 1-5, 2-15

Total count 2-14

Total number of originals..... 4-5

Touch panel 1-8 to 1-9, 4-3 to 4-4

Transfer belt..... 2-20

Transparency film..... 2-9, 5-17, 6-8

Transparency inserts..... 6-2, 6-8

Tray extension..... 2-4

Tray settings..... 2-11, 2-14

Troubleshooting

- Copier operation 7-4

- General information 2-24

- Saddle stitch finisher 3-12

■ U

User maintenance 7-3

■ W

Warm-up time..... 2-24, 8-2

Weight of acceptable originals 4-5

Wire extension 2-4

■ X

XY zoom..... 5-15

■ Y

Yellow toner 2-15

■ Z

Zoom 5-13

For users in the USA

This device complies with Part 15 of the FCC rules. Operation is subject to the following two conditions: (1) This device may not cause harmful interference, and (2) this device must accept any interference received, including interference that may cause undesired operation.

WARNING:

FCC Regulations state that any unauthorized changes or modifications to this equipment not expressly approved by the manufacturer could void the user's authority to operate this equipment.

Note:

This equipment has been tested and found to comply with the limits for a Class A digital device, pursuant to part 15 of the FCC Rules. These limits are designed to provide reasonable protection against harmful interference when the equipment is operated in a commercial environment. This equipment generates, uses, and can radiate radio frequency energy and, if not installed and used in accordance with the operation manual, may cause harmful interference to radio communications. Operation of this equipment in a residential area is likely to cause harmful interference in which case the user will be required to correct the interference at his own expense.

Shielded cables must be used with this equipment to maintain compliance with standard.

NOTICE for users in the USA

BE SURE TO ASK YOUR AUTHORIZED SHARP DEALER ABOUT THE WARRANTY THAT YOUR SELLING DEALER EXTENDS TO YOU. In order to assure you, the end-user, of warranty protection, Sharp extends a limited warranty to each of its authorized dealers and, in turn, requires each of its authorized dealers to extend its own warranty to you on terms that are no less favorable than those given to the dealer by Sharp. You should be aware, however, that Sharp does not itself extend any warranties, either express or implied, directly to you, the end-user, and no one is authorized to make any representations or warranties on behalf of Sharp. Specifically, SHARP DOES NOT EXTEND TO YOU, THE END-USER, ANY EXPRESS WARRANTY OR ANY IMPLIED WARRANTY OF MERCHANTABILITY, FITNESS FOR USE OR FITNESS FOR ANY PARTICULAR PURPOSE IN CONNECTION WITH THE HARDWARE, SOFTWARE OR FIRMWARE EMBODIED IN, OR USED IN CONJUNCTION WITH THIS PRODUCT. Sharp is not responsible for any damages or loss, either direct, incidental or consequential, which you, the end-user, may experience as a result of your purchase or use of the hardware, software or firmware embodied in or used in conjunction with this Product. Your sole remedy, in the event that you encounter any difficulties with this Product, is against the authorized dealer from which you purchased the Product.

AR-BC320 Digital Full Color Multifunctional System

In the event that this authorized dealer does not honor its warranty commitments, please contact the General Manager, Business Products Group, Sharp Electronics Corporation, Sharp Plaza, Mahwah, NJ 07430-1163, so that Sharp can try to help assure complete satisfaction of all the warranty rights to which you are entitled from the authorized dealer.

SHARP®

SHARP ELECTRONICS CORPORATION
Sharp Plaza, Mahwah, New Jersey 07430-1163.

www.sharppusa.com

SHARP ELECTRONICS OF CANADA LTD.
335 Britannia Road East, Mississauga, Ontario, L4Z 1W9

This manual has been printed using a vegetable-based soy oil ink
to help protect the environment.
Printed on 100% post-consumer recycled paper

PRINTED IN CHINA
2004J KS2
TINSE2926FCZZ

Free Manuals Download Website

<http://myh66.com>

<http://usermanuals.us>

<http://www.somanuals.com>

<http://www.4manuals.cc>

<http://www.manual-lib.com>

<http://www.404manual.com>

<http://www.luxmanual.com>

<http://aubethermostatmanual.com>

Golf course search by state

<http://golfingnear.com>

Email search by domain

<http://emailbydomain.com>

Auto manuals search

<http://auto.somanuals.com>

TV manuals search

<http://tv.somanuals.com>