

SHARP®

LC-24LE240E

LCD COLOUR TELEVISION

OPERATION MANUAL

SHARP®

SHARP ELECTRONICS (Europe) GmbH

Sonninstraße 3, D-20097 Hamburg

SHARP CORPORATION

<http://www.sharp-eu.com>

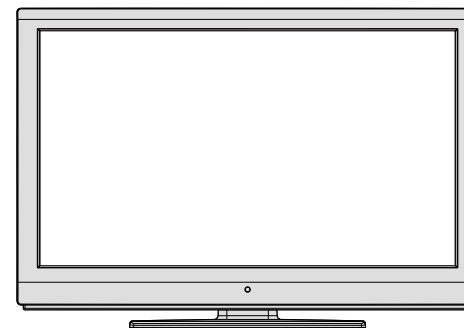

HDMI™
HIGH DEFINITION MULTIMEDIA INTERFACE

HD TV
1080p

DVB™
Digital Video
Broadcasting

PIN



--	--	--	--

Contents

Features	3	Managing Stations: Sorting Channel List	20
Dear SHARP customer.....	3	On-Screen Information	20
Introduction.....	3	Media Playback Using Media Browser.....	20
Preparation.....	3	Timeshift Recording	23
Important safety precautions	4	Instant Recording	23
Safety Precautions	5	Watching Recorded Programmes	24
Package Contents	7	Changing Image Size: Picture Formats.....	24
Environmental Information	7	Configuring Picture Settings.....	25
Repair Information	7	Operating Picture Settings Menu Items.....	25
Remote Control Buttons	8	Picture Settings Menu Items.....	25
LCD TV and Operating Buttons.....	9	PC Picture Settings.....	26
Viewing the Connections - Back Connectors	9	Configuring Sound Settings.....	26
Viewing the Connections - Side Connectors	10	Operating Sound Settings Menu Items.....	26
Power Connection	10	Sound Settings Menu Items.....	26
Aerial Connection	10	Configuring Your TV's Settings.....	27
Using USB Inputs	11	Operating Settings Menu Items	27
Connecting to a DVD Player via HDMI.....	12	Settings Menu Items	27
Connecting to a DVD Player via Component		Using a Conditional Access Module	28
Sockets (YPbPr) or Scart Cable.....	12	Viewing Conditional Access Menu (*).....	28
Connecting the LCD TV to a PC.....	13	Configuring Language Preferences.....	28
Using Side AV Connectors	13	Language Settings.....	29
Remote Control Handset	13	Parental Control.....	29
Inserting Batteries.....	13	Parental Settings Menu Operation	29
Switching On/Off.....	13	Timers.....	30
To Switch the TV On.....	13	Setting Sleep Timer	30
To Switch the TV to Standby.....	13	Setting Programme Timers.....	30
To Switch the TV Off	13	Recording Configuration.....	30
Input Selection.....	14	Configuring Date/Time Settings.....	31
Basic Operations	14	Configuring Source Settings.....	31
Operation with the Buttons on the TV.....	14	Configuring Other Settings	31
Operation with the Remote Control	14	Operation	31
Viewing Electronic Programme Guide (EPG).....	15	Other Features	32
Recording via EPG Screen.....	15	Teletext	33
Programme Options.....	16	Tips	33
First Time Installation.....	16	Appendix A: PC Input Typical Display Modes.....	34
Installation	17	Appendix B: AV and HDMI Signal Compatibility	
Auto Channel Scan (Retune) Menu Operation....	17	(Input Signal Types).....	34
Manual Tuning	18	Appendix C: Supported DVI Resolutions.....	35
Digital Aerial Manual Search.....	18	Appendix D: Supported File Formats for USB	
Digital Cable Manual Search*.....	18	Mode.....	36
Analogue Manual Search	18	Appendix E: Software Upgrade	37
Analogue Fine Tune.....	18	Specifications	38
Managing Stations: Channel List.....	19	Digital Reception (DVB-C).....	38
Operating the Channel List.....	19	Dimensional Drawings.....	39
Moving a Channel.....	19	End of life disposal	40
Deleting a Channel	19	Installing the Stand	41
Renaming a Channel.....	19	Uninstalling the Stand.....	42
Locking a Channel.....	19	Screw Dimensions.....	43
Managing Stations: Favourites	20		
Button Functions.....	20		



SPECIAL NOTE FOR USERS IN THE U.K.

The mains lead of this product is fitted with a non-rewireable (moulded) plug incorporating a 5A fuse. Should the fuse need to be replaced, a BSI or ASTA approved BS 1362 fuse marked  or  and of the same rating as above, which is also indicated on the pin face of the plug, must be used.

Always refit the fuse cover after replacing the fuse. Never use the plug without the fuse cover fitted.

In the unlikely event of the socket outlet in your home not being compatible with the plug supplied, cut off the mains plug and fit an appropriate type.

DANGER:

The fuse from the cut-off plug should be removed and the cut-off plug destroyed immediately and disposed of in a safe manner.

Under no circumstances should the cut-off plug be inserted elsewhere into a 5A socket outlet, as a serious electric shock may occur.

To fit an appropriate plug to the mains lead, follow the instructions below:

IMPORTANT:

The wires in the mains lead are coloured in accordance with the following code:

Blue: Neutral

Brown: Live

As the colours of the wires in the mains lead of this product may not correspond with the coloured markings identifying the terminals in your plug, proceed as follows:

- The wire which is coloured blue must be connected to the plug terminal which is marked N or coloured black.
- The wire which is coloured brown must be connected to the plug terminal which is marked L or coloured red.

Ensure that neither the brown nor the blue wire is connected to the earth terminal in your three pin plug.

Before replacing the plug cover make sure that:

- If the new fitted plug contains a fuse, its value is the same as that removed from the cut-off plug.
- The cord grip is clamped over the sheath of the mains lead, and not simply over the lead wires.

IF YOU HAVE ANY DOUBT, CONSULT A QUALIFIED ELECTRICIAN.

Features

- Remote controlled colour LCD TV.
 - Fully integrated Terrestrial digital-cable TV (DVB-T-C- MPEG2) (DVB-T-C MPEG4).
 - HDMI connectors for digital video and audio. This connection is also designed to accept high definition signals.
 - USB input.
 - Programme recording
 - Programme timeshifting
 - 1000 programmes (analogue+digital).
 - OSD menu system.
 - Integrated tuner DVB-T-C HD, MPEG 2 / MPEG 4 compatible.
 - Scart socket for external devices (such as video, video games, audio set, etc.).
 - Stereo sound system. (German+Nicam)
 - Teletext, fasttext, TOP text.
 - Headphone connection.
 - Automatic programming system.
 - Forward or backward manual tuning.
 - Sleep timer / Child lock.
 - Automatic sound mute when no transmission.
 - NTSC playback.
 - AVL (Automatic Volume Limiting).
 - Auto power down.
 - PLL (Frequency Search).
 - PC input.
 - Plug&Play for Windows 98, ME, 2000, XP, Vista, Windows 7.
 - Game Mode
- The illustrations and the OSD in this operation manual are for explanation purposes and may vary slightly from the actual operations.
- The examples used throughout this manual are based on the LC-24LE240E model.

Dear SHARP customer

Thank you for your purchase of the SHARP LCD colour TV product. To ensure safety and many years of trouble-free operation of your product, please read **important safety precautions** carefully before using this product.

Introduction

Please read the corresponding instructions of this handbook prior to the first usage of the device, even when the usage of electronic devices is familiar to you. Notice especially the chapter SAFETY PRECAUTIONS. Carefully keep the handbook as future reference. When selling the device or giving it away, absolutely give these direction for use.

Thank you for choosing this product. This manual will guide you for the proper operation of your TV. Before operating the TV, please read this manual thoroughly. Please do keep this manual in a safe place for future references.

This device is intended to receive and display TV programs. The different connection options make an additional expansion of the reception and display sources possible (receiver, DVD player, DVD recorder, VCR, PC etc.). This device is only suitable for the operation in dry interiors. This appliance is intended solely for private domestic use and may not be used for industrial and commercial purposes. We exclude liability in principle, if the device is not used as intended, or unauthorized modifications have been made. To operate your LCD TV in extreme ambient conditions may cause the damage of the device.

Preparation

For ventilation, leave a free space of at least 10 cm all around the set. To prevent any fault and unsafe situations, please do not place any objects on top of the set. Use this device in moderate climates.

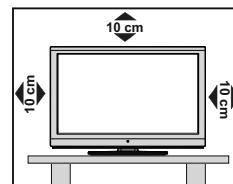



Important safety precautions

- **Cleaning**—Unplug the AC cord from the AC outlet before cleaning the product. Use a damp cloth to clean the product. Do not use liquid cleaners or aerosol cleaners.
- Use a soft damp cloth to gently wipe the panel when it is dirty. To protect the panel, do not use a chemical cloth to clean it. Chemicals may cause damage or cracks in the cabinet of the TV.
- **Water and moisture**—Do not use the product near water, such as bathtub, washbasin, kitchen sink, laundry tub, swimming pool and in a wet basement.
- Do not place vases or any other water-filled containers on this product. The water may spill onto the product causing fire or electric shock.
- **Stand**—Do not place the product on an unstable cart, stand, tripod or table. Doing so can cause the product to fall, resulting in serious personal injuries as well as damage to the product. Use only a cart, stand, tripod, bracket or table recommended by the manufacturer or sold with the product. When mounting the product on a wall, be sure to follow the manufacturer's instructions. Use only the mounting hardware recommended by the manufacturer.
- When relocating the product placed on a cart, it must be moved with utmost care. Sudden stops, excessive force and uneven floor surface can cause the product to fall from the cart.
- **Ventilation**—The vents and other openings in the cabinet are designed for ventilation. Do not cover or block these vents and openings since insufficient ventilation can cause overheating and/or shorten the life of the product. Do not place the product on a bed, sofa, rug or other similar surface, since they can block ventilation openings. This product is not designed for built-in installation; do not place the product in an enclosed place such as a bookcase or rack, unless proper ventilation is provided or the manufacturer's instructions are followed.
- The LCD panel used in this product is made of glass. Therefore, it can break when the product is dropped or impact applied. If the LCD panel is broken, be careful not to be injured by broken glass.
- **Heat sources**—Keep the product away from heat sources such as radiators, heaters, stoves and other heat-generating products (including amplifiers).
- To prevent fire, never place any type of candle or naked flames on the top or near the TV set.
- To prevent fire or shock hazard, do not place the AC cord under the TV set or other heavy items.
- **Headphones**—Do not set the volume at a high level. Hearing experts advise against extended listening at high volume levels.
- Do not display a still picture for a long time, as this could cause an afterimage to remain.
- There is power consumption always if main plug is connected.
- **Servicing**—Do not attempt to service the product yourself. Removing covers can expose you to high voltage and other dangerous conditions. Request a qualified person to perform servicing.

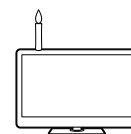

The LCD panel is a very high technology product, giving you fine picture details.

Due to the very large number of pixels, occasionally a few non-active pixels may appear on the screen as a fixed point of blue, green or red. This is within product specifications and does not constitute a fault.

Precautions when transporting the TV

When transporting the TV, never carry it by holding onto the speakers. Be sure to always carry the TV by two people holding it with two hands—one hand on each side of the TV.

WARNING

To prevent the spread of fire, keep candles or other open flames away from this product at all times.



Safety Precautions

Read the following recommended safety precautions carefully for your safety.

Power Source

The TV set should be operated only from a 220-240V AC, 50Hz outlet. Ensure that you select the correct voltage setting for your convenience.

Power Cord

Do not place the set, a piece of furniture, etc. on the power cord (mains lead) or pinch the cord. Handle the power cord by the plug. Do not unplug the appliance by pulling from the power cord and never touch the power cord with wet hands as this could cause a short circuit or electric shock. Never make a knot in the cord or tie it with other cords. The power cords should be placed in such a way that they are not likely to be stepped on. A damaged power cord can cause fire or give you an electric shock. When it is damaged and needs to be replaced, it should be done by qualified personnel.

Moisture and Water

Do not use this device in a humid and damp place (avoid the bathroom, the sink in the kitchen, and near the washing machine). Do not expose this device to rain or water, as this may be dangerous and do not place objects filled with liquids, such as flower vases, on top. Avoid from dripping or splashing.



If any solid object or liquid falls into the cabinet, unplug the TV and have it checked by qualified personnel before operating it any further.

Cleaning

Before cleaning, unplug the TV set from the wall outlet. Do not use liquid or aerosol cleaners. Use soft and dry cloth.



Ventilation

The slots and openings on the TV set are intended for ventilation and to ensure reliable operation. To prevent overheating, these openings must not be blocked or covered in anyway.

Heat and Flames

The set should not be placed near to open flames and sources of intense heat such as an electric heater. Ensure that no open flame sources, such as lighted candles, are placed on top of the TV. Batteries should not be exposed to excessive heat such as sunshine, fire or the like.



Lightning

In case of storm and lightning or when going on holiday, disconnect the power cord from the wall outlet.

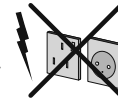

Replacement Parts

When replacement parts are required, make sure that the service technician has used replacement parts, which are specified by the manufacturer or have the same specifications as the original one. Unauthorized substitutions may result in fire, electrical shock or other hazards.

Servicing

Please refer all servicing to qualified personnel. Do not remove the cover yourself as this may result in an electric shock.



Waste Disposal

- Packaging and packaging aids are recyclable and should principally be recycled. Packaging materials, such as a foil bag should be kept away from children
- Batteries, including those which are heavy metal free, should not be disposed of with household waste. Please dispose of used batteries in an environmentally friendly manner. Find out about the legal regulations which apply in your area.
- Do not try to recharge batteries, there is a danger of explosion. Replace batteries only with the same or equivalent type.

This symbol on the product or on its packaging means that your electrical and electronic device should be disposed at the end of its service life separately from your household wastes. There are separate collection systems for recycling in the EU. For more information, please contact the local authority or the dealer where you purchased the product.



Disconnecting the Device

The mains plug is used to disconnect the TV set from the mains and therefore it must remain readily operable.

Headphone Volume

Excessive sound pressure from earphones and headphones can cause hearing loss.



Installation

To prevent injury, this device must be securely attached to the wall in accordance with the installation instructions when mounted to the wall (if the option is available).

LCD Screen

The LCD panel is a very high technology product with about a million thin film transistors, giving you fine picture details. Occasionally, a few non-active pixels may appear on the screen as a fixed blue, green or red point. Please note that this does not affect the performance of your product.

Warning! Do not leave your TV in standby or operating mode when you leave your house.

Connection to a Television Distribution System (Cable TV etc.) from Tuner

Device connected to the protective earthing of the building installation through the mains connection or through other apparatus with a connection to protective earthing-and to a television distribution system using coaxial cable, may in some circumstances create a fire hazard.

Connection to a cable distribution system has therefore to be provided through a device providing electrical isolation below a certain frequency range (galvanic isolator, see EN 60728-11).

Note: The HDMI connection between PC and TV may cause radio interference in which case it is recommended to use VGA(DSUB-15) connection.

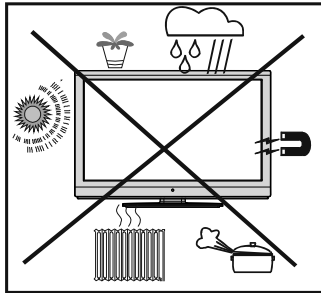

The Standby Off/On button doesn't separate this device completely from mains. Moreover the device consumes power in the standby operation. In order to separate the device completely from mains, the mains plug has to be pulled from the mains socket. Because of that the device should be set up in a way, that an unobstructed access to mains socket is guaranteed, so that in case of emergency the mains plug can be pulled immediately. To exclude the danger of fire, the power cord should principally be separated from the mains socket prior to a longer period of non-usage, i.e. during vacations.

- "HDMI, the HDMI logo and High-Definition Multimedia Interface are trademarks or registered trademarks of HDMI Licensing LLC."

- Manufactured under license from Dolby Laboratories.

- The "HD TV 1080p" Logo is a trademark of EICTA.

- The DVB logo is the registered trademark of the Digital Video Broadcasting—DVB—project.

Electrical device not in the hands of children

Never let children use any electrical device unsupervised. Children cannot always recognise possible dangers. Batteries / accumulators can be life threatening when swallowed. Store batteries out of the reach of small children. In case of swallowing a battery medical aid has to be sought immediately. Also keep the packaging foils away from children as there is danger of suffocation.

Licence Notification

DivX®, DivX Certified® and associated logos are trade-marks of DivX®, Inc. and are used under license.

DIVX™

ABOUT DIVX VIDEO: DivX® is a digital video format created by DivX, LLC, a subsidiary of Rovi Corporation. This is an official DivX Certified® device that plays DivX® video. Visit divx.com for more information and software tools to convert your files into DivX video.

ABOUT DIVX VIDEO-ON-DEMAND: This DivX Certified® device must be registered in order to play purchased DivX® Video-on-Demand (VOD) movies. To obtain your registration code, locate the DivX® VOD section in your device setup menu. Go to vod.divx.com for more information on how to complete your registration.

DivX Certified® to play DivX® video, including premium content.

Package Contents

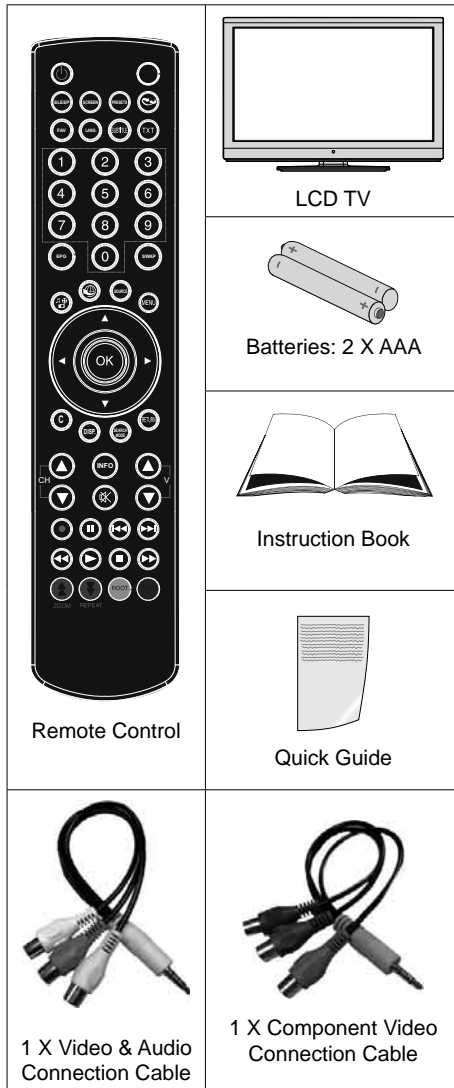

Note: You should check the accessories after purchasing. Make sure that each accessory is included.

As the manufacturer's specification supports communication on cable lengths shall be smaller than 3m.

Environmental Information

- This television is designed to consume less energy to save environment.

You not only help to save the environment but also you can save money by reducing electricity bills thanks to the energy efficiency feature of this TV. To reduce energy consumption, you should take the following steps:

- You can use Power Save Mode setting, located in the Other Settings menu. If you set Power Save Mode as On, the TV will switch to energy-saving mode and luminance level of TV set will be decreased to optimum level. Note that some picture settings will be unavailable to be changed when the TV is in Power Save Mode.

Power Save Mode Off

- When the TV is not used, please switch off at the rear rocker switch to further reduce power consumption.
- Disconnect the TV from the mains socket when it will not be used for prolonged periods.
- When the TV is left in stand-by it consumes a small amount of power switching off at the rear rocker switch or disconnect the TV from the mains will make further energy savings. Note activating the "Power Save Mode" saves on an annual bases more energy than switching off the mains when the TV is not used, to save most energy it is highly recommended that "Power Save Mode" is switch on.

Repair Information

Please refer all servicing to qualified personnel. Only qualified personnel must repair the TV. Please contact your local dealer, where you have purchased this TV for further information.

Remote Control Buttons

1. Standby
2. Image size / Zooms videos (in Media Browser video mode)
3. Sleep Timer
4. Mono / Stereo - Dual I-II / Current Language (*) (in DVB channels)
5. Favourite Mode Selection (in DVB channels)
6. Numeric buttons
7. Electronic programme guide (in DVB channels)
8. No function
9. Media Browser
10. Navigation buttons (Up/Down/Left/Right)
11. No function
12. Recordings Library
13. Programme Down / Page up - Programme Up / Page down
14. Mute
15. Programme recording
16. Pause (in Media Browser mode) / Timeshift recording
17. Rapid reverse (in Media Browser mode)
18. Play (in Media Browser mode)
19. Red button
20. Green button / List Schedule (in EPG) / Tag / Untag All (in favourite list) / Play-Slideshow (in Media Browser) / Loop-Shuffle (in Media Browser)
21. Picture mode selection / Changes picture mode (in Media Browser video mode)
22. No function
23. Teletext / Mix (in TXT mode)
24. Subtitle on-off (in DVB channels)
25. Previous programme
26. AV / Source selection
27. Menu on-off
28. Okay (Confirm) / Hold (in TXT mode) / Edit Channel List
29. Exit / Return / Index page (in TXT mode)
30. No function
31. Info / Reveal (in TXT mode)
32. Volume Up / Down
33. No function
34. No function
35. Rapid advance (in Media Browser mode)

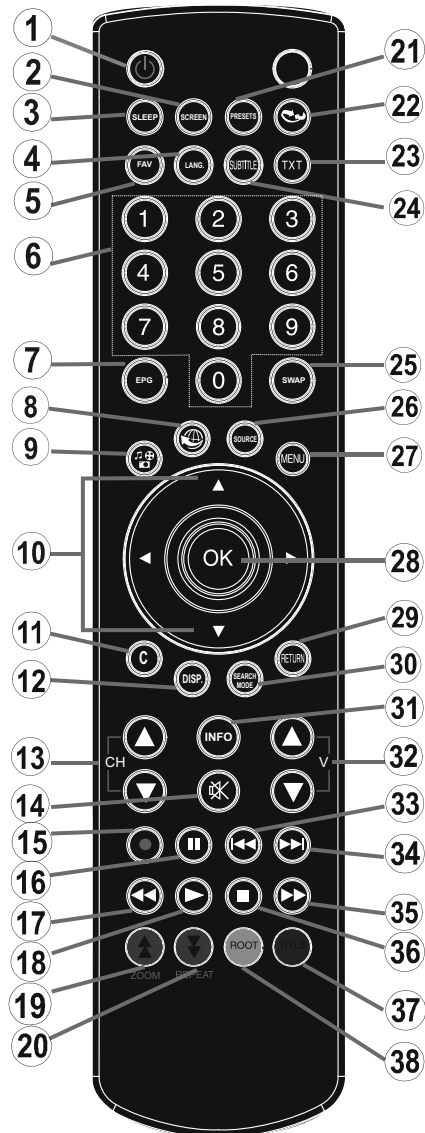

36. Stop (in Media Browser mode)
37. Blue button / Edit Channel List / Filter (In Favourite List&EPG)
38. Yellow button / Timeline Schedule (in EPG)

LCD TV and Operating Buttons

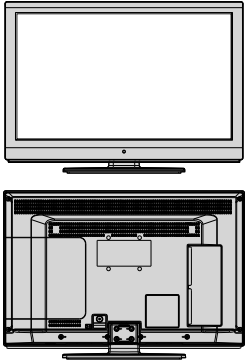
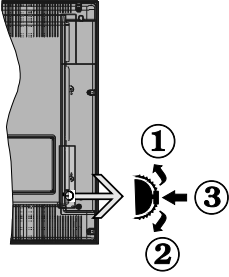
FRONT and REAR VIEW	Control buttons VIEW	Control Buttons
		<ol style="list-style-type: none"> 1. Up direction 2. Down direction 3. Programme/Volume / AV / Standby-On selection switch <p><i>Note: You can move the switch, upward or downward to change the volume. If you want to change channels, press the middle of the switch once (Position 3) and then move upward or downward. If you press the middle of the switch once more, source OSD will be displayed. To select desired source, move the switch upward or downward and release. If you press the middle of the switch and hold about a few seconds, the TV will switch to standby mode. Main menu OSD cannot be displayed via control buttons.</i></p>

Viewing the Connections - Back Connectors

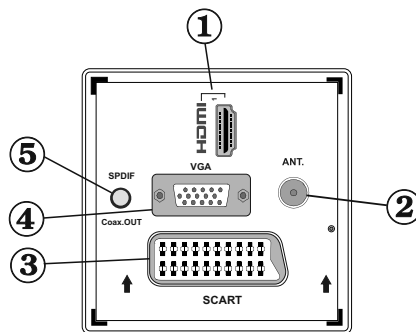

1. **HDMI 1: HDMI Input**
HDMI Inputs are for connecting a device that has an **HDMI** socket. Your LCD TV is capable of displaying High Definition pictures from devices such as a High Definition Satellite Receiver or DVD Player. These devices must be connected via the HDMI sockets or Component Socket. These sockets can accept either 720p or 1080i signals. No sound connection is needed for an HDMI to HDMI connection.
2. **RF Input** connects to an aerial antenna system or a cable.
 Note that if you use a decoder or a media recorder, you should connect the aerial cable through the device to the television with an appropriate antenna cable, as shown in the illustration in the following pages.
3. **SCART** input or output for external devices. Connect the SCART cable between SCART socket on TV and SCART socket on your external device (such as a decoder, a VCR or a DVD player).
Note: If an external device is connected via the SCART socket, the TV will automatically switch to AV mode.
Note: S-VHS signal is supported via the scart socket (optional).
4. **PC Input** is for connecting a personal computer to the TV set.
 Connect the PC cable between the **PC INPUT** on the TV and the PC output on your PC.
5. **SPDIF Coaxial Out** outputs digital audio signals of the currently watched source.
 Use an **SPDIF coaxial cable** to transfer audio signals to a device that has SPDIF input

Viewing the Connections - Side Connectors

1. CI Slot is used for inserting a CI card. A CI card allows you to view all the channels that you subscribe to. For more information, see "Conditional Access" section.
2. USB Inputs.
Note that programme recording feature is available via these USB inputs. You can connect external hard disk drives to this input.
3. **Component Video Input (YPbPr)** is used for connecting component video. You can connect the component video and audio sockets with a device that has component output. To do this, you must use the supplied component video connection cable for enabling connection. First, plug single jack of the cable to the TV's YPbPr socket (side). Afterwards, insert your component cable's (not supplied) connectors into the plural part of the Component video connection cable. Colours of the connected jacks should match.
4. **Side audio-video connection** input is used for connecting video and audio signals of external devices. To make a video connection, you must use the supplied AV connection cable for enabling connection. First, plug singular jack of the cable to the TV's Side AV socket. Afterwards, insert your video cable's (not supplied) connector into the YELLOW input (located on the plural side) of the supplied AV connection cable. Colours of the connected jacks should match.
To enable audio connection, you must use RED and WHITE inputs of the side AV connection cable. Afterwards, insert your device's audio cable's connectors into the RED and WHITE jack of the **supplied** side AV connection cable. Colours of the connected jacks should match.
Note: You should use audio inputs of side AV connection cable (RED & WHITE) to enable sound connection when connecting a device to your TV by using PC or COMPONENT VIDEO input.
5. Headphone jack is used for connecting an external headphone to the system. Connect to the HEADPHONE jack to listen to the TV from headphones (optional).
6. Volume/ Programme/ Source and Standby-On switch
7.  switch is used for turning the TV on or off.

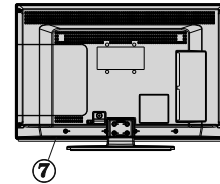

Power Connection

IMPORTANT: The TV set is designed to operate on 220-240V AC, 50Hz.

- After unpacking, allow the TV set to reach the ambient room temperature before you connect the set to the mains. Plug the power cable to the mains socket outlet.

Aerial Connection

- Connect the aerial ,cable TV plug to the AERIAL INPUT socket located at the rear of the TV.

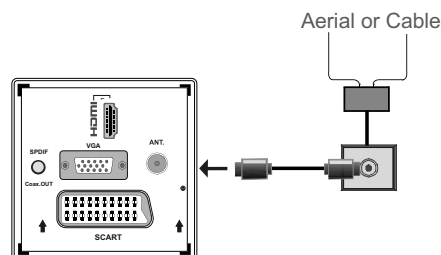

Using USB Inputs

USB Connection

- You can connect a USB hard disk drive or USB memory stick to your TV by using the USB inputs of the TV. This feature allows you to play files stored in a USB drive or record programmes.
- 2.5" and 3.5" inch (hdd with external power supply) external hard disk drives are supported.
- To record a programme, you should first connect a USB disk to your TV while the TV is switched off. You should then switch on the TV to enable recording feature. Otherwise, recording feature will not be available.
- If one or more partitions of your hard drive are exFAT formatted, none or less partitions might be visible, even if they are formatted with a different file system than exFat.

IMPORTANT !

- You may back up your files before making any connections to the TV set in order to avoid any possible data loss. Note that manufacturer will not be responsible for any file damage or dataloss.
- It is possible that certain types of USB devices (e.g. MP3 Players) or USB hard disk drives/memory sticks may not be compatible with this TV.

IMPORTANT: The TV supports only FAT32 and NTFS disk formatting. However, NTFS format is not supported for recording features. For recording, if you connect a USB disk with NTFS format, the TV will ask you to format the content. See the section, "Format Disk" in the following pages for more information on disk formatting.

Note that ALL the data stored on the USB disk will be lost and then the disk format will be converted to FAT32 in such a case.

USB Disk Connection

- Plug your USB device to the USB input of the TV.

Note: Plug or unplug your USB disk while the TV is switched off.

Note: If you are going to connect a USB hard disk drive to the TV set, USB connection cable used between the disk drive and the TV should have a USB logo and should be as short as possible.

Note: While formatting a USB hard disk that has 1TB (Tera Byte) or more file capacity, you can experience problems with the formatting process. In such a case, you should format the disk with your personal computer and the formatted disk type should be FAT32.

SIDE VIEW USB MEMORY

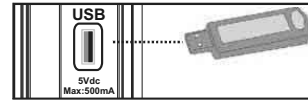

CAUTION !

- Quickly plugging and unplugging USB devices, is a very hazardous operation. Especially, do not repeatedly quickly plug and unplug the drive. This may cause physical damage to the USB player and especially the USB device itself.
- Do not pull out USB module while playing or recording a file.

Programme Recording

To record a programme, you should first connect a USB disk to your TV while the TV is switched off. You should then switch on the TV to enable recording feature.

IMPORTANT: When using a new USB hard disk drive, it is recommended that you first format the disk using your TV's "Format Disk" option.

- For using recording function, you should connect a USB disk or an external hard disk drive to the TV and connected USB disk should have at least 1 GB capacity and should have 2.0 speed compatibility. If the connected USB device does not support 2.0 speed, an error message will be displayed.

Note: Recorded programmes are saved into the connected USB disk. If desired, you can store/copy recordings on a computer; however, these files will not be available to be played on a computer. You can play the recordings only via your TV.

- For more information on recording programmes, see sections "Instant Recording", "Timeshifting", "Electronic Programme Guide", "Recordings Library" or "Recording Timers" in the following parts.
- Recorded programmes are split into 4GB partitions.
- Recorded programmes are stored in the following directory of the connected USB disk: \DVR\RECS. All recordings are indicated with a number. A text (txt) file is created for each recording. This text file includes information such as broadcaster, programme, and recording time.
- Timeshifting may be stopped according to USB device write speed. If the USB device speed is not enough for video stream bitrate, timeshifting may be stopped and recording may fail. If HD service bitrate is greater than 13 Mbp/sec. some freeze can be seen during timeshifting on both USB disk and on external HDD.

- Recordings of HD programmes can occupy bigger size on the USB disk depending on the broadcast's resolution. For this reason it is recommended to use USB hard disk drives for recording HD programmes.
- Do not plug out the USB/HDD during the recording. This may harm the connected USB/HDD.
- Multipartition support is available. Maximum two different partitions are supported. If the disk have more than two partitions, crash may occur. First partition of the usb disk is used for PVR ready features. It also must be formatted as primary partition to be used for PVR ready features.
- Some stream packets may not be recorded because of signal problems, so sometimes video may freezes during playback.
- Record, Play, Pause, Display (for PlayListDialog) keys could not be used when teletext is ON. If a recording starts from timer when teletext is ON, teletext is automatically turned off. Also teletext usage is disabled when there is ongoing recording or playback.
- Radio record is not supported.
- The TV can record programmes up to ten hours.

Connecting to a DVD Player via HDMI

Please refer to your DVD player's instruction book for additional information. Power off both the TV and the device before making any connections.

Note: Not all cables shown in the illustration are supplied.

- If your DVD player has an **HDMI** socket, you can connect via **HDMI** for better video and audio quality.

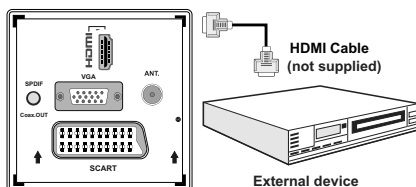

- When you connect to DVD player as illustrated above, switch to the connected **HDMI** source. See, **Input Selection** section for more information on changing sources.

Connecting to a DVD Player via Component Sockets (YPbPr) or Scart Cable

- Some DVD players are connected through **COMPONENT SOCKETS (YPbPr)**. In this case, you must use the supplied Component video connection cable for enabling connection. First, plug single jack of the cable to the TV's YPbPr socket (side). Afterwards, insert your component cable's (not supplied) connectors into the socket part of the Component video connection cable (see illustration below). Colours of the connected jacks should match.
- To enable audio connection, use the **VGA/Component Audio cable**. First, plug single jack of the cable to the TV. Afterwards, insert your DVD player's audio cable's connectors into the socket part of the **VGA/Component audio connection cable** (see illustration below). Colours of the connected jacks should match.

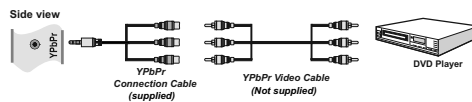

- When the connection is made, switch to **YPbPr** source. See, **Input selection** section. **Note:** To connect YPb Pr device, you should use supplied component (YPbPr) connection cable
- You may also connect through the **SCART** input.

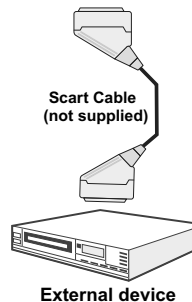
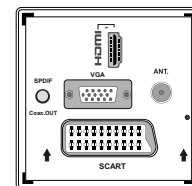

- **Note:** These three methods of connection perform the same function but in different levels of quality. It is not necessary to connect by all three methods.

Connecting the LCD TV to a PC

For displaying your computer's screen image on your LCD TV, you can connect your computer to the TV set. Power off both computer and display before making any connections. Use 15-pin D-sub display cable to connect a PC to the LCD TV. When the connection is made, switch to PC source. See "Input selection" section. Set the resolution that suits your viewing requirements. Resolution information can be found in the appendix parts

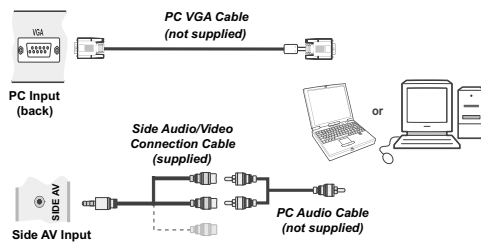

Using Side AV Connectors

You can connect a range of optional equipment to your LCD TV using side connectors of the TV.

- For connecting a camcorder or camera, you should use **AV** socket (side). To do this, you must use the supplied **video/audio connection cable**. First, plug single jack of the cable to the TV's **AV IN** socket (side). Afterwards, insert your camera cable's (*not supplied*) connectors into the plural part of the **video/audio connection cable**. Colours of the connected jacks should match. See illustration below.
- Afterwards, you should switch to **Side AV** source. See the section **Input selection** in the following sections for more information.

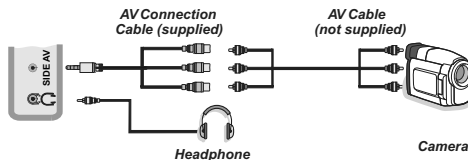

- To listen the TV sound from headphones, you should connect headphones to your TV by using the **HEADPHONE** jack as illustrated above..

Remote Control Handset

Inserting Batteries

- Remove the battery cover located on the back of the handset by gently pulling backwards from the indicated part.
- Insert two **AAA/R3** or equivalent type batteries inside. Observe the correct polarity (+/-) when inserting batteries and replace the battery cover.



Note: Remove the battery from remote control handset when it is not to be used for a long period. Otherwise it can be damaged due to any leakage of batteries. Remote range is approximately 7m/23ft.

Switching On/Off

To Switch the TV On

Connect the power cord to the 220-240V AC 50 Hz.

- Switch the "1" button on the bottom right hand side under the screen to position "1" so the TV will switch to standby mode. Then the standby LED lights up.
- To switch on the TV from standby mode either:
 - Press the "⏻" button, CH▲ / CH▼ or a numeric button on the remote control.
 - Press the "⏻" or +/- button on the TV.
- The TV will then switch on.

Note: If you switch on your TV via CH▲ / CH▼ buttons on the remote control or on the TV set, the programme that you were watching last will be reselected.

By either method the TV will switch on.

To Switch the TV to Standby

To switch the TV to low power stand by press the "⏻" button on the remote control or right hand side of the TV.

Note: When the TV is switched to standby mode, standby LED can blink to indicate that features such as Standby Search, Over Air Download or Timer is active.

To Switch the TV Off

- Switch the "1" button on the bottom right hand side under the screen to position 2 as illustrated,  to isolate the TV from the mains, the LED will go out.

- If the TV will not be used for a long period i.e. holidays, then unplug the power cord from the mains socket.

Standby Notifications

If the TV switches off while in No Signal mode, the following on-screen message will be displayed on the next switch-on:

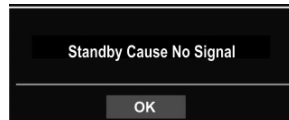

When the Auto Tv Off timeout is reached, the following message will be displayed on the screen. Select YES to shut down the TV. Select NO to cancel. The TV will switch off as well, if you do not make a selection on this screen.

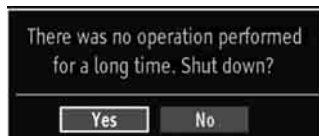

If the TV switches off owing to the auto power down feature, the following on-screen message will be displayed on the next switch-on:

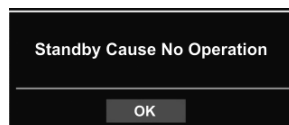

Input Selection

Once you have connected external systems to your TV, you can switch to different input sources. Press "SOURCE" button on your remote control consecutively for directly changing sources.



Basic Operations

You can operate your TV using both the remote control and onset buttons.

Operation with the Buttons on the TV

Volume Setting

- You can use the control switch to change the volume of the TV. To increase volume, please move the switch upward. Move the switch downward to decrease the volume. A volume level scale (slider) will be displayed on the screen.

Programme Selection

- First press the control switch once to change channel. You can move the switch upward to select the next programme or move it downward to select the previous programme.

Viewing Main Menu

- The Main Menu screen cannot be displayed by using the control switch on the TV.

AV Mode

- Press the control switch consecutively until the source OSD is displayed on the screen.

Operation with the Remote Control

- The remote control of your TV is designed to control all the functions of the model you selected. The functions will be described in accordance with the menu system of your TV.

Volume Setting

- Press "V▲" button to increase the volume. Press "V▼" button to decrease the volume. A volume level scale (slider) will be displayed on the screen.

Programme Selection (Previous or Next Programme)

- Press "CH▼" button to select the previous programme.
- Press "CH▲" button to select the next programme.

Programme Selection (Direct Access)

- Press numeric buttons on the remote control to select programmes between 0 and 9. The TV will switch to the selected programme. To select programmes between, press the numeric buttons consecutively. When the pressing time is due for the second numeric button, only the first digit programme will be displayed. Press directly the programme number to reselect single digit programmes.

Viewing Electronic Programme Guide (EPG)

You can view the electronic programme guide (EPG) to view information about available programmes. To view the EPG menu please press **EPG** button on the remote control.

- Press “▼/▲” buttons to navigate through channels.
- Press “◀/▶” buttons to navigate through the programme list.
- EPG menu displays available information on all channels.
- Please note that event information is updated automatically. If there are no event information data available for channels, EPG will be displayed with blanks.



Up/Down/Left/Right: Navigate.

OK (Options): views/records or sets timer for future programs.

INFO (Event Details): Displays the programmes in detail.

Green button: Programme schedule will be listed

Yellow button: Display EPG data in accordance with timeline schedule

Blue button (Filter): Views filtering options.

(RECORD): the TV will start to record the selected programme. You can press again to stop the recording.



Up/Down/Left/Right: Navigate.

Red button (Prev Time Slice): Displays the programmes of previous time slice.

Green button (Next Time Slice): Displays the programmes of the next time slice.

Yellow button (Prev Day): Displays the programmes of previous day.

Blue button (Next day): Displays the programmes of the next day.

Numeric buttons (Jump): Jumps to the preferred channel directly via numeric buttons.

OK (Options): views/records or sets timer for future programs.

Text button (Filter): Views filtering options.

INFO (Details): Displays the programmes in detail.

(RECORD): the TV will start to record the selected programme. You can press again to stop the recording.



Red button (Prev Day): Displays the programmes of previous day.

Green button (Next day): Displays the programmes of the next day.

Yellow button (Zoom): Expands programme information.

Blue button (Filter): Views filtering options.

INFO (Details): Displays the programmes in detail.

Numeric buttons (Jump): Jumps to the preferred channel directly via numeric buttons.

OK (Options): views/records or sets timer for future programs.

Text (Search): Displays “Guide Search” menu.

SUBTTL: Press SUBTITLE button to view Select Genre menu. Using this feature, you can search the programme guide database in accordance with the genre. Info available in the programme guide will be searched and results matching your criteria will be listed.

SWAP (Now) : Shows the current programme.

Recording via EPG Screen

IMPORTANT: To record a programme, you should first connect a USB disk to your TV while the TV is switched off. You should then switch on the TV to enable recording feature. Otherwise, recording feature will not be available.

RECORD: the TV will start to record the selected programme. You can press again to stop the recording.

Note: Switching to a different broadcast or source is not available during the recording.

◀ / ▶ : Page left / Page right.

Programme Options

In EPG menu, press the OK button to enter the "Event Options" menu.



Select Channel

In EPG menu, using this option, you can switch to the selected channel.

Record / Delete Record Timer

IMPORTANT: To record a programme, you should first connect a USB disk to your TV while the TV is switched off. You should then switch on the TV to enable recording feature. Otherwise, recording feature will not be available.

- After you have selected a programme in EPG menu, press the **OK** button and **Options** screen will be displayed. Select **"Record"** option and press the **OK** button. After this operation, a recording becomes set to the selected programme.

- To cancel an already set recording, highlight that programme and press the **OK** button and select the option **"Delete Rec. Timer"**. The recording will be cancelled.

Note: You cannot switch to any other channel or source while there is an active recording on the current channel.

Set Timer / Delete Timer

After you have selected a programme in EPG menu, press the **OK** button and **Options** screen will be displayed. Select **"Set Timer on Event"** option and press **OK** button. You can set a timer for future programmes.

To cancel an already set reminder, highlight that programme and press the **OK** button. Then select **"Delete Timer"** option. The timer will be cancelled.

Note: It is not possible to record or set timer for two or more individual events at the same time interval.

First Time Installation

IMPORTANT: Ensure that the aerial or cable is connected before switching on the TV for the first time installation.

- When the TV is operated for the first time, installation wizard will guide you through the process. First, language selection screen will be displayed:



- Use "▼" or "▲" buttons to select your language and press **OK** button to set selected language and continue.

- After selecting the language, **"Welcome!"** screen will be displayed, requiring you to set **Country**, **Search Type**, **Teletext Language**, **Store Mode** and **Scan Encrypted** options.



- By pressing "◀" or "▶" button, select the country you want to set and press "▼" button to highlight **Search Type** option. Use "◀"/"▶" to set the desired search type. Available search types are digital only, analog TV only and full. When set, press "▼" to select **Teletext Language**. Use "◀"/"▶" to select the desired **Teletext Language**.

- When set, press "▼" to select **Teletext Language**. Use "◀" or "▶" to select the desired **Teletext Language**.

- Press "▼" button after setting **Teletext Language** option. **Scan Encrypted** will be then highlighted. You can set **Scan Encrypted** as **Yes** if you want to scan coded stations. Afterwards select the desired **Teletext Language**.

- You can activate **Store Mode** option by using left or right button. If the **Store Mode** is set to "enabled", **E-Pop** option will be available in other settings

menu. If it is set to "disabled", Store Mode will not be available after the First Time Installation.
Note: If Store Mode is enabled, some features may be affected.

- Press **OK** button on the remote control to continue and the following message will be displayed on the screen:

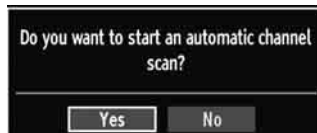

To select the "Yes" or "No" option, highlight the item by using "◀" or "▶" buttons and press **OK** button.

Afterwards, the following OSD will be displayed on the screen:



If you select **CABLE** option, the following screen will be displayed (This screen will not be available if you have selected the Country as Netherlands. Automatic Channel Scan will be displayed instead.):



You can select frequency ranges from this screen. For highlighting lines you see, use "▼" or "▲" button. You can enter the frequency range manually by using the numeric buttons on the remote control. Set Start and Stop Frequency as desired by using numeric buttons on the remote control. After this operation, you can set Search Step as 8000 KHz or 1000 KHz. If you select 1000 KHz, the Tv will perform search process in a detailed way. Searching duration will thus increase accordingly. When finished, press **OK** button to start automatic search.

If you select **AERIAL** option from the Search Type screen, the television will search for digital terrestrial TV broadcasts.

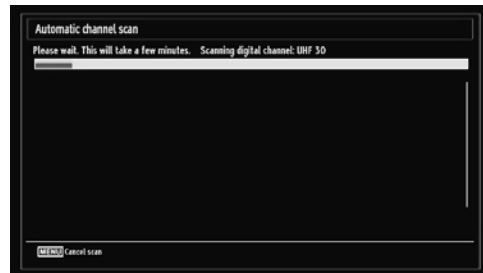

Note: You can press "**MENU**" button to cancel.

- After all the available stations are stored, Channel List will be displayed on the screen. If you like the sort channels, according to the LCN, please select "Yes" and then press "**OK**".



- Press **OK** button to quit channel list and watch TV. If you have selected the Country option as Netherlands in First Time Installation, only **OK** and **LOCK** options will be displayed.

Installation

Press "**MENU**" button on the remote control and select **Installation** by using "◀" or "▶" button. Press **OK** button and the following menu screen will be displayed.

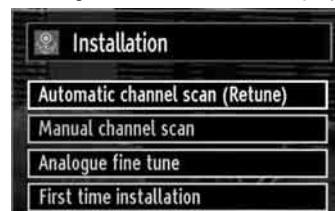

Select **Automatic Channel Scan (Retune)** by using "▼" or "▲" button and press **OK** button. **Automatic Channel Scan (Retune)** options will be displayed. You can select options by using "▼" or "▲" and **OK** buttons.

Auto Channel Scan (Retune) Menu Operation

Digital Aerial: Searches and stores aerial DVB stations.

Digital Cable: Searches and stores cable DVB stations.

Analogue: Searches and stores analogue stations.

Digital Aerial & Analogue: Searches and stores both analogue and aerial DVB stations.

Digital Cable & Analogue: Searches and stores both analogue and cable DVB stations.

- Whenever you select an automatic search type and press **OK** button, a confirmation screen will appear on the screen. To start installation process, select **Yes**, to cancel select **No** by using “◀” or “▶” and **OK** button.
- After auto channel scan type is set and selected and confirmed, installation process will start and progress bar will move along. Press “**MENU**” button to cancel process. In such a case, located channels are not stored.

Manual Tuning

HINT: This feature can be used for direct broadcast entry.

- Select **Manual Channel Scan** from the Installation menu by using “▼”/“▲” and **OK** buttons. Manual Scan options screen will be displayed.
- Select the desired **Search Type** using “◀” or “▶” button. Manual search options will change accordingly. Use “▼”/“▲” button to highlight an item and then press “◀” or “▶” button to set an option. You can press “**MENU**” button to cancel.

Digital Aerial Manual Search



In manual channel scan, the number of the multiplex or frequency are entered manually and only that multiplex or frequency are searched for the channels. After selecting search type as **Digital Aerial**, you must select the desired Band and then , you can enter the multiplex or frequency number using the numeric buttons and press **OK** button to search.

Band Options:

D_Band = VHF 9-24

S_Band = VHF 12-20, UHF 21-41

K_Band = VHF 5-12, UHF 21-69

Digital Cable Manual Search*



In cable manual scan, you can enter frequency, modulation, symbol rate and network channel scan options. After selecting search type as Digital Cable, you can set the desired options and press **OK** button to search.

(*) If you have selected the Country option to Netherlands in First Time Installation, cable manual search option will not be available.

Analogue Manual Search



After selecting search type as analogue, you can use “▼”/“▲” button to highlight an item and then press “◀” or “▶” button to set an option.

Enter the channel number or frequency using the numeric buttons. You can then press **OK** button to search. When the channel is located, any new channels that are not on the list will be stored.

Analogue Fine Tune

- Select **Analogue Fine Tune** from the Installation menu by using “◀” or “▶” and **OK** buttons. Analogue fine tune screen will be displayed. Analogue Fine Tune feature will not be available if there are no analogue channels, digital channels and external sources stored.
- Press **OK** button to proceed. Use “◀” or “▶” button to set Fine Tune. When finished, press **OK** button again.

Managing Stations: Channel List

The TV sorts all stored stations in the Channel List. You can edit this channel list, set favourites or set active stations to be listed by using the Channel List options.

- Press “**MENU**” button to view main menu. Select Channel List item by using “◀” or “▶” button. Press **OK** to view menu contents.



Select Active Network feature allows you to select only the broadcasts within the selected network.

Select **Edit Channel List** to manage all stored channels. Use “◀” or “▶” and **OK** buttons to select Edit Channel List.

Operating the Channel List



- Press “▼” or “▲” button to select the channel that will be processed. Press “◀” or “▶” button to select a function on Channel List menu.
- Use CH▲/CH▼ buttons to move page up or down.
- Press **BLUE** button to view filtering options.
- Press “**MENU**” button to exit.

Note: The channels listed are mixed at the channel list. Channel types can be differentiated by the icons next to them: DTV (digital tv), HD (HD TV), ATV (Analogue TV), TV (TV), RD (Radio), encrypted, lock, and at the favourite list.

Listed channels can also be sorted by using the active channel list filter. The last available channel number is 999.

If you have selected the Country option as Netherlands in First Time Installation, performed Ziggo network search and stored Ziggo channels, only **OK** and **LOCK** options will be available.

Moving a Channel

- First select the desired channel. Select Move option in the channel list and press **OK** button.
- Edit Number screen will be displayed. Enter the desired channel number by using the numeric buttons on the remote control. If there is a previously stored channel on that number, a warning screen will be displayed. Select Yes if you want to move the channel and press **OK**.
- Press **OK** button to process. Selected channel is now moved.

Deleting a Channel

You can press **GREEN** button to tag/untag all channels; **YELLOW** button to tag/untag channel.

- Select the channel that you want to delete and select **Delete** option. Press **OK** button to continue.
- A warning screen will appear. Select **YES** to delete, select **No** to cancel. Press **OK** button to continue.

Renaming a Channel

- Select the channel that you want to rename and select **Edit Name** option. Press **OK** button to continue.
- Pressing “◀” or “▶” button moves to the previous/next character. Pressing “▼” or “▲” button toggles the current character, i.e., ‘b’ character becomes ‘a’ by “▼” and ‘c’ by “▲”. Pressing the numeric buttons ‘0...9’ replaces the highlighted character with the characters printed above the button one by one as the button is pressed.
- When finished, press **OK** button to save. Press “**MENU**” to cancel.

Locking a Channel

You can press **GREEN** button to tag/untag all channels; **YELLOW** button to tag/untag a single channel.

- Select the channel that you want to lock and select **Lock** option. Press **OK** button to continue.
- You will be asked to enter parental control PIN. Default PIN is set as **0000**. Enter the PIN number.

Note: If the Country option is set to France, you can use 4725 as the default code.



- Press **OK** button when the desired channel is highlighted to lock/unlock the channel. Lock symbol will be displayed next to the selected channel.

Managing Stations: Favourites

You can create a list of favourite programmes.

- Press **"MENU"** button to view main menu. Select Channel List item by using **"◀"** or **"▶"** button. Press **OK** to view menu contents.
- Select **Favourites** to manage favourite list. Use **"▼"** / **"▲"** and **OK** buttons to select **Favourites**.
- You can set various channels as favourites so that only the favourite channels are navigated.



- Select a channel by using **"▼"** or **"▲"** button. Press **OK** button to add selected channel to favourites list. Press **OK** button again to remove.

Button Functions

- **OK:** Add/remove a station.
- **YELLOW:** Tag/untag a channel.
- **GREEN:** Tag/untag all channels.
- **BLUE:** Displays filtering options.

Managing Stations: Sorting Channel List

You can select broadcasts to be listed in the channel list. To display specific types of broadcast, you should use Active channel list setting.

Select Active channel list from the Channel list menu by using **"◀"** or **"▶"** button. Press **OK** button to continue.



You can select a broadcast type option from the list by using **"▼"** / **"▲"** and **OK** buttons.

On-Screen Information

You can press **"INFO"** button to display on-screen information. Details of the station and current programme will be displayed on the information banner.

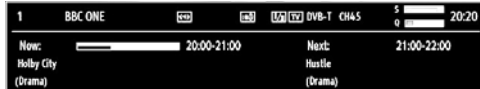

The information banner gives information on the channel selected and the programmes on it. The name of the channel is displayed, along with its channel list number. *Hint: Not all channels broadcast the programme data. If the name and time of the programme are not available, then information banner will be displayed with blanks.*

If you have searched and stored Ziggo channels, BER value of the cable channels will be displayed in the info banner.

If there are more than one videos available on a Ziggo channel, press **YELLOW** button to view video selection menu, while info banner is displayed on the screen.

If the selected channel is locked, you must enter the correct four-digit numeric code to view the channel (default code is **0000**). **"Enter PIN"** will be displayed on the screen.

Note: If the Country option is set to France, you can use 4725 as the default code.

Media Playback Using Media Browser

If the USB stick is not recognized after power off/on or First Time Installation, first, plug the USB device out and power off/on the TV set. Plug the USB device in again.

To display Media Browser window, press either **"MENU"** button on the remote control and then select Media Browser by pressing **"◀"** or **"▶"** button. Press **OK** button to continue. Media Browser menu options will be displayed.

Also, when you plug USB devices, media browser screen will be displayed automatically:



You can play music, picture and video files from the connected USB memory stick. Use “◀” or “▶” button to select Videos, Photos, Music, Recording Library or Settings.

Viewing Videos via USB



When you select Videos from the main options, available video files will be filtered and listed on this screen. You can use “▼” or “▲” button to select a video file and press **OK** button to play a video. If you select a subtitle file and press **OK** button, you can select or deselect that subtitle file. The following menu will be displayed while playing a video file:

Jump (Numeric buttons): The TV will jump to the file starting with the letter you input via the numeric buttons on your remote control.

Play This (OK button) : Plays the selected file.

Up/Down: Navigate.

Play (▶ button) : Plays all media files starting with the selected one.

Lang (Play Preview): Displays selected file in a small preview screen.

RED button: Sorts files by name.

YELLOW button: Toggles viewing style.

GREEN button: Activates Loop/Shuffle functions.

BLUE button: Changes media type.

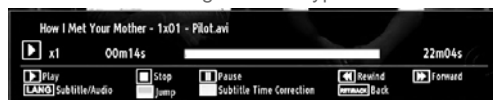

Play (▶ button): Starts the video playback.

Stop (■ button): Stops the video playback.

Pause (|| button): Pause the video playback.

Rewind (◀◀ button): Goes backward.

Forward (▶▶ button): Goes forward.

Subtitle/Audio (LANG button): Sets subtitle/Audio.

Jump (GREEN button): Jumps to time. Use numeric buttons to type the desired time and press GREEN button again to proceed.



Yellow: Opens subtitle time correction menu



Press **SWAP** button to switch back to previous menu.

Viewing Photos via USB

When you select Photos from the main options, available image files will be filtered and listed on this screen.



Jump (Numeric buttons): Jump to selected file using the numeric buttons.

OK: Views the selected picture in full screen.

Up/Down: Navigate.

Slideshow (▶ button): Starts the slideshow using all images.

GREEN button: Views images in thumbnails.

RED button: Sorts files by date.

YELLOW button: Toggles viewing style.

BLUE button: Changes media type.

Slideshow Options



Pause (|| button): Pauses the slideshow.

Continue (▶ button): Continues the slideshow.

Loop/Shuffle (GREEN button): Press once to disable Loop. Press again to disable both Loop and Shuffle. Press once more to enable only Shuffle. Press again to enable all. You can follow the disabled functions with the change of the icons.

Previous/Next (Left/Right buttons): Jumps to previous or next file on slideshow.

Rotate (Up/Down buttons): Rotates the image using up/down buttons.

RETURN: Back to file list.

INFO: Displays help screen.

Playing Music via USB

When you select Music from the main options, available audio files will be filtered and listed on this screen.

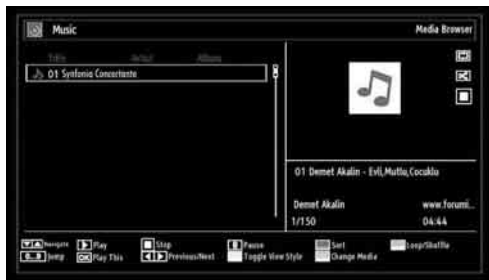

Up/Down: Navigate.

Play (▶ button): Plays all media files starting with the selected one.

Stop (■ button): Stops playback.

Pause (|| button): Pauses the selected playback.

RED: Sorts files by Title, Artist or Album.

Loop/Shuffle (GREEN button): Press once to disable Loop. Press again to disable both Loop and Shuffle. Press once more to enable only Shuffle. Press again to enable all. You can follow the disabled functions with the change of the icons.

Note:

If you start the playback with the ▶ button and activate the [▶] symbol, the TV will play the next music/video file. The playback will proceed accordingly and when the end of the list is reached, it will be played again from the beginning (loop function).

If you start the playback with the OK button and activate the [▶] symbol, the same music or video file will be played in a loop (repeat function).

If you start the playback with ▶ or OK button and activate the [◀▶] symbol, music or video file will be played in a shuffle.

If you start the playback with ▶ or OK button and activate [▶], [◀▶] symbols, music or video file playback will continue randomly and the random playback will continue.

0..9 (Numeric buttons): The TV will jump to the file starting with the letter you input via the numeric buttons on your remote control.

Play This (OK button): Plays the selected file.

Previous/Next (Left/Right buttons): Jumps to previous or next file to play.

YELLOW: Toggles viewing style.

BLUE: Changes media type.

Recordings Library

IMPORTANT: To view recordings library, you should first connect a USB disk to your TV while the TV is switched off. You should then switch on the TV to enable recording feature. Otherwise, recording feature will not be available.

To view the list of recordings, select "Recordings Library" and press the OK button. Recordings Library will then be displayed with available recordings.

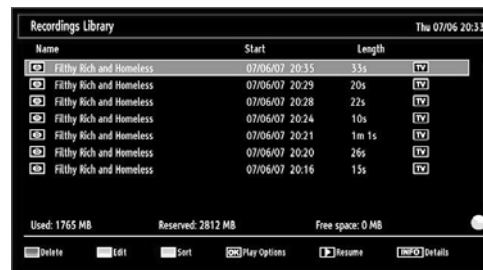

All the recordings are kept in a list in the recordings library.

RED button (Delete): Erases the selected recording.

GREEN button (Edit): Makes changes on the selected recording.

BLUE button (Sort): Changes the order of the recordings. You can select from a wide range of sorting options.

OK button: Activates play options menu:

- **Play from start:** Plays the recording from the beginning.
- **Resume:** Recommences the recordings.
- **Play from offset:** Specifies a playing point.

Note: Viewing main menu and menu items will not be available during the playback.

▶ **(Resume):** Recommences the recordings.

INFO (Details): Displays the short extended programmes in detail.

Media Browser Settings



You can set your Media Browser preferences by using the Settings dialog. Press “▼” or “▲” button to highlight an item and use “◀” or “▶” button to set.

View Style: Sets default browsing mode.

Music FF/FR Speed: Sets forwarding/advancing speed.

Slide Show Interval: Sets slide show interval time.

Show Subtitle: Sets subtitle enabling preference.

Subtitle Position: Sets subtitle position as up or down.

Subtitle Font Size: Sets subtitle font size (max. 54pt).

DivX® Registration Code: Some DivX® Video-On-Demand files require registration code, this code can be used for this purpose.

Timeshift Recording

IMPORTANT: To record a programme, you should first connect a USB disk to your TV while the TV is switched off. You should then switch on the TV to enable recording feature. Otherwise, recording feature will not be available.

- Press **PAUSE** button while watching a broadcast for switching to timeshifting mode.
- In timeshifting mode, the programme is paused and simultaneously recorded to the connected USB disk (*). Press **PLAY** button again to watch the paused programme from the stopped moment.
- This playback is performed in x1 playback speed. You will see the timeshift gap between the real and the timeshifted programme in the info bar.
- Use **PREVIOUS/NEXT** buttons to move forward or backward on timeshift playback. When the timeshift is reached, timeshifting mode will be quitted and you will switch back to watching normal broadcast.
- Press **STOP** button to quit timeshifting mode.

(*) Continuous time shift recording's duration depends on your connected USB disk's file size and defined Max. Timeshift in the Recordings Configuration menu.

See the section, “Recordings” for more information on setting Max. Timeshift.

Note: Switching to a different broadcast or source; and viewing main menu are not available during the timeshifting.

Lip Sync delay may occur during the timeshifting.

Standby button is ignored during the timeshifting. The TV will not switch to standby mode during the timeshifting.

Instant Recording

IMPORTANT: To record a programme, you should first connect a USB disk to your TV while the TV is switched off. You should then switch on the TV to enable recording feature. Otherwise, recording feature will not be available.

- Press **RECORD** button to start recording an event instantly while watching a programme. The following OSD appears on the screen:



- Record OSD will then be displayed for a short time and the current event will be recorded.
- You can press **RECORD** button on the remote control again to record the next event on the EPG. In this case, OSD will display the programmed events for recording.



Press **STOP** button to cancel instant recording. The following OSD will be displayed:

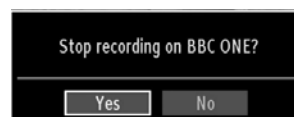

Select Yes by using “◀” or “▶” / **OK** buttons to cancel instant recording.

Note: Switching to a different broadcast or source; and viewing Media Browser are not available during the recording.

Watching Recorded Programmes

In the main menu, use “◀” or “▶” buttons to select Media Browser. Highlight Recordings Library item by using “◀” or “▶” button and press OK button to enter. Recordings Library will then be displayed.

IMPORTANT: To view recordings library, you should first connect a USB disk to your TV while the TV is switched off. You should then switch on the TV to enable recording feature. Otherwise, recording feature will not be available.

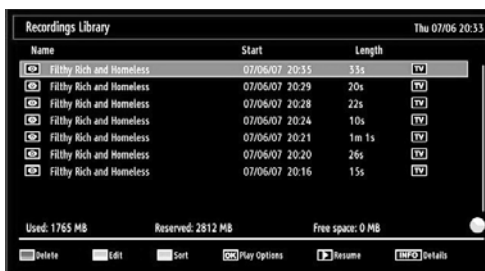

Select a recorded item from the list (if previously recorded) by using “▼”/“▲” button. Press **OK** button to view **Play Options**. Select an option by using “▼”/“▲” or **OK** buttons.



Available playback options:

- Play from start: Plays the recording from the beginning.
- Resume: Recommences the recordings.
- Play from offset: Specifies a playing point.

Note: Viewing main menu and menu items will not be available during the playback.

Press **■** (STOP) button to stop a playback and return to return to Recordings Library.

Slow Forward

If you press **⏸** (PAUSE) button while watching recorded programmes, slow forward feature will be available. You can use **▶▶** button to slow forward. Pressing **▶▶** button consecutively will change slow forwarding speed.

Changing Image Size: Picture Formats

- You can change the aspect ratio (image size) of the TV for viewing the picture in different zoom modes.
- Press “**SCREEN**” button repeatedly to change the image size. Available zoom modes are listed below.

Auto

When AUTO is selected, the aspect ratio of the screen is adjusted by the information provided by the selected source (if available).

The format being displayed in AUTO mode is completely independent of WSS information which could be included in the broadcast signal or the signal from an external device.

Note: Auto mode only will be available in HDMI, YPbPr and DTV sources.

16:9

This uniformly stretches the left and right sides of a normal picture (4:3 aspect ratio) to fill the wide TV screen.

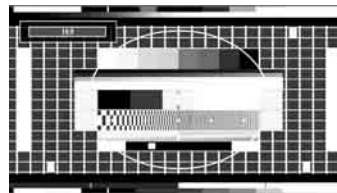

- For 16:9 aspect ratio pictures that have been squeezed into a normal picture (4:3 aspect ratio), use the **16:9** mode to restore the picture to its original shape.

Subtitle

This zooms up the wide picture (16:9 aspect ratio) with subtitles to the full screen.

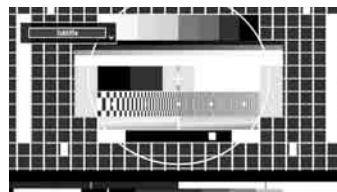

Note: You can shift to screen up or down by pressing “▼”/“▲” buttons while picture zoom is selected as panoromic, 14:9 Zoom, Cinema or Subtitle.

14:9

This zooms up the wide picture (14:9 aspect ratio) to the upper and lower limits of the screen.

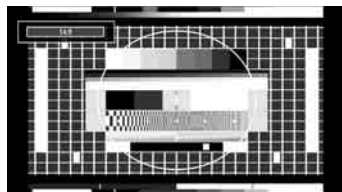

14:9 Zoom

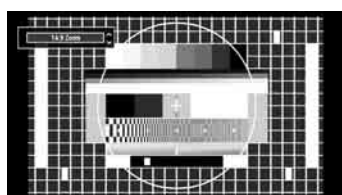

This option zooms to the 14:9 picture.

4:3

Use to view a normal picture (4:3 aspect ratio) as this is its original size.

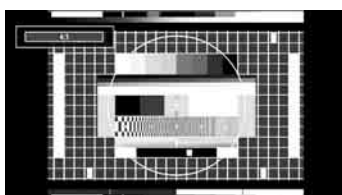

Panoramic

This stretches the left and right sides of a normal picture (4:3 aspect ratio) to fill the screen, without making the picture appear unnatural.

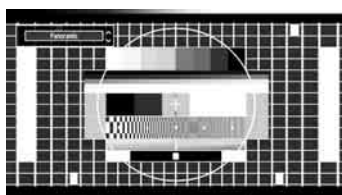

The top and bottom of the picture are slightly cut off.

Cinema

This zooms up the wide picture (16:9 aspect ratio) to the full screen.

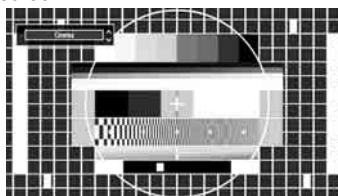

Configuring Picture Settings

You can use different picture settings in detail.

Press "MENU" button and select the Picture icon by using "◀" or "▶" button. Press OK button to view Picture Settings menu.

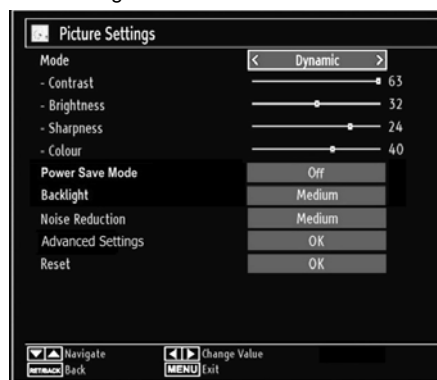

Operating Picture Settings Menu Items

- Press "▼" or "▲" button to highlight a menu item.
- Use "◀" or "▶" button to set an item.
- Press MENU button to exit.

Picture Settings Menu Items

Mode: For your viewing requirements, you can set various screen modes. The Picture mode can be set to one of these options: **Cinema, Game, Dynamic** and **Natural**.

Contrast: Sets the lightness and darkness values of the screen.

Brightness: Sets the brightness value for the screen.

Sharpness: Sets the sharpness value for the objects displayed on the screen.

Colour: Sets the colour value, adjusting the colors.

Power Save Mode : Use "▼" or "▲" button to select Power Save Mode. Press "◀" or "▶" button to set Power Save Mode as Eco, Picture Off and Disabled. See the section, "Environmental Information" in this manual for further information on Power Save Mode.

Backlight (optional): This setting controls the backlight level and it can be set to Auto, Maximum, Minimum and Medium.

Note: Backlight can not be activate in VGA or Media Browser mode or while picture mode is set as Game.

Noise Reduction: If the broadcast signal is weak and the picture is noisy, use **Noise Reduction** setting to reduce the noise amount. Noise Reduction can be set to one of these options: **Low, Medium, High** or **Off**.

Advanced Settings

- **Colour Temp:** Sets the desired colour tone.

Setting **Cool** option gives white colours a slight blue stress.

For normal colours, select **Normal** option.

Setting **Warm** option gives white colours a slight red stress.

- **Picture Zoom:** Sets the picture size to **Auto,16:9, Subtitle,14:9, 14:9 Zoom, 4:3, Panoramic** or **Cinema**.

- **HDMI True Black (optional):** While watching from HDMI source, this feature will be visible in the Picture Settings menu. You can use this feature to enhance blackness in the picture. You can set this feature as "On" for activating HDMI True Black mode.

- **Film Mode (optional):** Films are recorded at a different number of frames per second to normal television programmes. Press "▼" or "▲" buttons to select Film mode. Press "◀" or "▶" buttons to set this feature Auto or Off. Turn this feature to Auto when you are watching films to see the fast motion scenes clearly.

- **Colour Shift:** Adjust the desired colour tone.

Reset: Resets the picture settings to factory default settings.

While in VGA (PC) mode, some items in Picture menu will be unavailable. Instead, VGA mode settings will be added to the Picture Settings while in PC mode.

PC Picture Settings

For adjusting PC picture items, do the following:

Press "◀" or "▶" button to select Picture icon. Picture menu appears on the screen.

Contrast, Brightness, Colour, Colour Temp and Picture Zoom settings in this menu are identical to settings defined in TV picture menu under "Main Menu System".

Sound,Settings and Source settings are identical to the settings explained in main menu system.

PC Position: Select this to display PC position menu items.

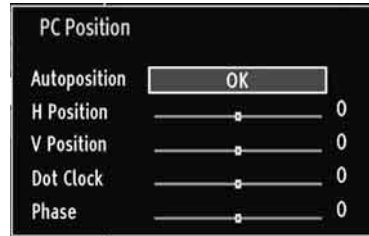

Autoposition: Automatically optimizes the display. Press **OK** to optimize.

H Position: This item shifts the image horizontally to right hand side or left hand side of the screen.

V Position: This item shifts the image vertically towards the top or bottom of the screen.

Dot Clock: Dot Clock adjustments correct the interference that appear as vertical banding in dot intensive presentations like spreadsheets or paragraphs or text in smaller fonts.

Phase: Depending on the resolution and scan frequency that you input to the TV set, you may see a hazy or noisy picture on the screen. In such a case you can use this item to get a clear picture by trial and error method.

Configuring Sound Settings

Sound settings can be configured according to your personal preferences.

Press "**MENU**" button and select the first icon by using "◀" or "▶" button. Press **OK** button to view Sound Settings menu.

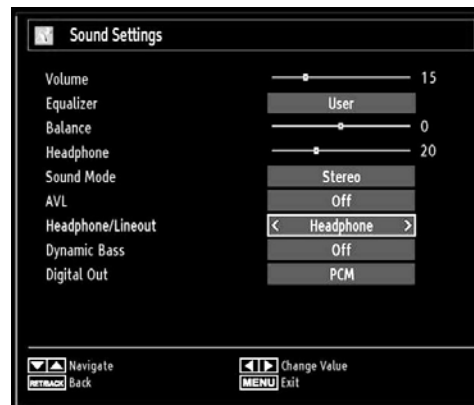

Operating Sound Settings Menu Items

- Press "▼" or "▲" button to highlight a menu item.
- Use "◀" or "▶" button to set an item.
- Press "**MENU**" button to exit.

Sound Settings Menu Items

Volume: Adjusts volume level.

Equalizer: Press **OK** button to view equalizer sub-menu.

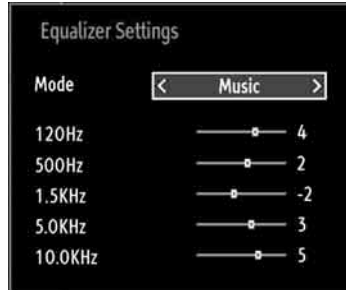

In equalizer menu, the preset can be changed to **Music, Movie, Speech, Flat, Classic** and **User**. Press the “**MENU**” button to return to the previous menu.

Note: Equalizer menu settings can be changed manually only when the **Equalizer Mode** is in **User**.

Balance: This setting is used for emphasizing left or right speaker balance.

Headphone: Sets headphone volume.

Sound Mode: You can select Mono, Stereo, Dual I or Dual II mode, only if the selected channel supports that mode.

AVL: Automatic Volume Limiting (AVL) function sets the sound to obtain fixed output level between programmes (For instance, volume level of advertisements tend to be louder than programmes).

Headphone/Lineout: When you connect an external amplifier to your TV using the headphone jack, you can select this option as Lineout. If you have connected headphones to the TV, set this option as Headphone.

Dynamic Bass: Dynamic Bass is used to increase bass effect of the TV set.

Digital Out: Sets digital out audio type.

Configuring Your TV's Settings

Detailed settings can be configured to suit your personal preferences.

Press “**MENU**” button and select Settings ikon by using “**◀**” or “**▶**” button. Press **OK** button to view Settings menu.



Operating Settings Menu Items

- Press “**▼**” or “**▲**” button to highlight a menu item.
- Press **OK** button to select an item.
- Press “**MENU**” button to exit.

Settings Menu Items

Conditional Access: Controls conditional access modules when available.

Language: Configures language settings.

Parental: Configures parental settings.

Timers: Sets timers for selected programmes.

Date/Time: Sets date and time.

Sources: Enables or disables selected source options.

Other Settings: Displays other setting options of the TV set.

Using a Conditional Access Module

IMPORTANT: Insert or remove the CI module only when the TV is SWITCHED OFF.

- In order to watch certain digital channels, a conditional access module (CAM) can be necessary. This module must be inserted in the CI slot of your TV.
- Obtain the Conditional Access Module (CAM) and the viewing card by subscribing to a pay channel company, then insert those to the TV using the following procedure.
- Insert the CAM and then the viewing card to the slot that is located in the terminal cover at the rear side of the TV.
- The CAM should be correctly inserted, it is impossible to insert fully if reversed. The CAM or the TV terminal may be damaged if the CAM is forcefully inserted.

Connect the TV to the mains supply, switch on and then wait for few moments until the card is activated.

- When no module is inserted, "**No Common Interface module detected**" message appears on the screen.
- Refer to the module instruction manual for details of the settings.

Viewing Conditional Access Menu (*)

(*) These menu settings may change depending on the service provider.

Press "**MENU**" button and select the icon by using "**◀**" or "**▶**" button. Press **OK** button to view Settings menu. Use "**▼**" or "**▲**" button to highlight **Conditional Access** and press **OK** to view menu items.

Configuring Language Preferences

You can operate the TV's language settings using this menu.

Press "**MENU**" button and select the fifth icon by using "**◀**" or "**▶**" button. Press **OK** button to view Settings menu. Use "**◀**" or "**▶**" button to highlight **Language** and press **OK** to continue:

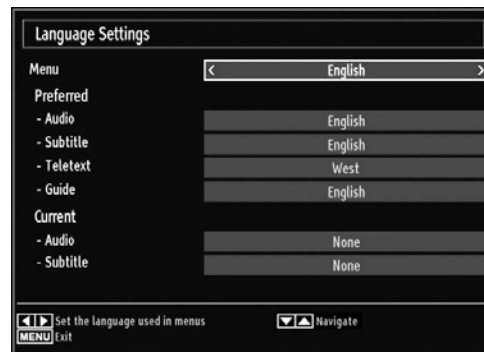

Use "**▼**" or "**▲**" button to set an item. Settings are stored automatically.

Menu: displays the system language.

Preferred

These settings will be used if available. Otherwise the current settings will be used.

- **Audio:** Sets the preferred audio language.
- **Subtitle:** Sets the subtitle language. Selected language will be seen in subtitles.
- **Teletext:** Sets teletext language.
- **Guide:** Sets the preferred Guide language.

Current (*)

(*) These settings can be changed if only the broadcaster supports. Otherwise, settings will not be available to be changed.

Audio: Changes the audio language for the current channel.

- **Subtitle:** Sets the subtitle language for the current channel.

Note: If the Country option is set to Denmark, Sweden, Norway, Netherlands or Finland, the Language Settings menu will function as described below:

Language Settings

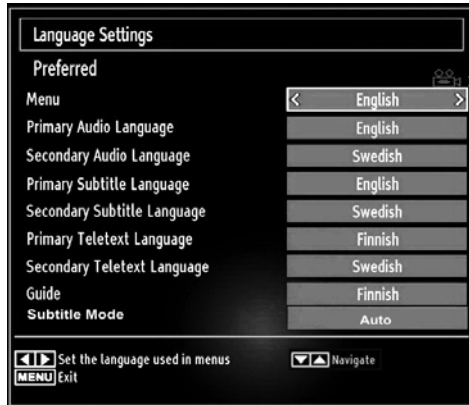

In the configuration menu, highlight the Language Settings item by pressing “▼” or “▲” buttons. Press OK and Language Settings submenu will be displayed on the screen:

Use “▼” or “▲” buttons to highlight the menu item that will be adjusted and then press “◀” or “▶” button to set.

Notes:

- System Language determines the on-screen menu language.
- Audio Language is used for selecting the soundtrack of a channels.
- Primary settings are the first priority when multiple choices are available on a broadcast. Secondary settings are the alternatives when the first options are not available.
- Subtitle Mode defines the current subtitle option.

Parental Control

To prohibit viewing of certain programmes, channels and menus can be locked by using the parental control system.

This function enables or disables the menu protection system and allows the PIN code to be changed.

Press “MENU” button and select the icon by using “◀” or “▶” button. Press OK button to view Settings menu. Use “▼” or “▲” button to highlight **Parental** and press OK to continue:



To display parental lock menu options, PIN number should be entered. Factory default PIN number is **0000**.

Note: If the Country option is set to France, you can use 4725 as the default code.

After coding the correct PIN number, parental settings menu will be displayed:



Parental Settings Menu Operation

- Select an item by using “▼” or “▲” button.
- Use “◀” or “▶” button to set an item.
- Press OK button to view more options.

Menu Lock: Menu lock setting enables or disables the menu access. You can disable access to the installation menu or the whole menu system.

Maturity Lock (optional): When set, this option gets the maturity information from the broadcast and if this maturity level is disabled, disables access to the broadcast.

Child Lock (optional): When Child Lock is set, the TV can only be controlled by the remote control. In this case the control panel buttons will not work, except for the Standby Off/On button. When Child Lock is activated you are able to switch the TV into Standby mode with the Standby Off/On button. To switch the TV on again, you need the remote control. Hence, if one of those buttons is pressed, **Child Lock Is On** will be displayed on the screen when the menu screen is not visible.

Set PIN: Defines a new PIN number. Use numeric buttons to enter a new pin number. You will need to code your new pin a second time for verification purposes.

IMPORTANT: The factory default pin number is **0000**, if you change the pin number make sure you write it down and keep it safe.

Note: If the Country option is set to France, you can use 4725 as the default code.

Timers

To view Timers menu, press "MENU" button and select Channel List icon by using "◀" or "▶" button. Press OK button to view Channel List menu. Use "▼" or "▲" button to highlight Timers and press OK to continue:

Setting Sleep Timer

This setting is used for setting the TV to turn off after a certain time.

- Highlight Sleep Timer by using "▼" or "▲" button.
- Use "◀" or "▶" button to set. The timer can be programmed between **Off** and **2.00** hours (120 minutes) in steps of 30 minutes.

Setting Programme Timers

You can set programme timers for a particular programme using this feature.

Press "▼" button to set timers on an event. Programme timer function buttons will be displayed on the screen.

Adding a Timer

- Press **YELLOW** button on the remote control to add a timer. The following menu appears on the screen:

Network Type: This feature is unavailable to be set.

Timer Type: You can select timer type as Record or Timer.

Channel: Changes channel by using "◀" or "▶".

Record Type: This item is unavailable to be set.

Date: Enter a date using the numeric buttons.

Start: Enter a starting time using the numeric buttons.

End: Enter an ending time using the numeric buttons.

Duration: Displays duration between the starting and ending time.

Repeat: Sets a timer to be repeated as Once, Daily or Weekly. Use "◀" or "▶" buttons to select an option.

Change/Delete: Sets the change/delete permission.

Playback: Sets the playback permission and parental settings.

- Press **GREEN** button to save the timer. Press **RED** button to cancel.

Editing a Timer

- Select the timer you want to edit by pressing "▼" or "▲" button.
- Press **GREEN** button. Edit Timer menu screen will be displayed.
- When finished with editing, press **GREEN** button to save. You can press "MENU" button to cancel.

Deleting a Timer

- Select the timer you want to delete by pressing "▼" or "▲" button.
- Press **RED** button.
- Select **YES** by using "◀" or "▶" buttons to delete the timer. Select **NO** to cancel.

Recording Configuration

Select Recording Configuration item in the Settings menu to configure recording settings. The following menu is displayed for recording configuration.

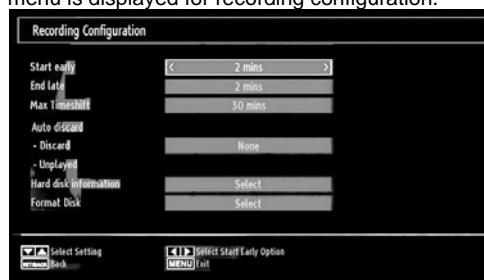

The following options are available for adjustments:

Start Early (*)

You set recording timer's starting time to start earlier by using this setting.

(*) **Available only for EU country options.**

End Late (*)

You set recording timer's end time to end later by using this settings.

(*) **Available only for EU country options.**

Max Timeshift

This setting allows you to set the maximum time allowed for timeshifting. Duration options are approximate and can change accordingly, depending on the broadcast received.

Format Disk

IMPORTANT: Note that ALL the data stored on the USB disk will be lost and then the disk format will be converted to FAT32 if you activate this feature.

• If you want to delete all files on the connected USB hard disk drive or memory stick, you can use Format Disk option.

• Also, if your USB disk malfunctions, you can try formatting the USB disk. In most cases formatting the USB disk will restore normal operation; however, ALL the data stored on the USB disk will be lost in such a case.

• Press **OK** button while the Format Disk option is highlighted. A menu will appear on the screen, requiring you to enter a pin number. If you have not changed the pin number, the factory default is 0000.

Note: If the Country option is set to France, you can use 4725 as the default code.

After you enter the pin, a pop-up menu appears on the screen to ensure that the hard disk should be formatted, select "YES" and press OK to format the hard disk. Select "NO" and press OK to cancel. Ensure you back up important recordings before you format the USB disk unit.

Hard Disk Info

To view the details about the USB disk, highlight Hard Disk Info by using "▼" or "▲" key and press OK. USB disk information will be displayed:

Configuring Date/Time Settings

Select **Date/Time** in the Settings menu to configure Date/Time settings. Press **OK** button.



- Use "▼" or "▲" buttons to highlight **Date/Time**.

Date, Time, Time Settings Mode and Time Zone Setting will be available.

Use "▲" or "▼" buttons to highlight the Time Settings Mode. Time Settings Mode is set using "◀" or "▶" buttons. It can be set to AUTO or MANUAL.

When AUTO is selected, Date/Time and Time Zone options will not be available to be set. If MANUAL option is selected as the Time Zone can be altered:

- By pressing "▲" or "▼" buttons select Time Zone.

Use "◀" or "▶" buttons to change the Time Zone between GMT-12 or GMT+12. Date/Time on the top of the menu list will then change according to the selected Time Zone.

If you have selected Country option in the First Time Installation as Netherlands, Date/Time Settings will not be available to be changed.

- Changes are automatically stored. Press "MENU" to exit.

Configuring Source Settings

You can enable or disable selected source options. The TV will not switch to the disabled source options when "SOURCE" button is pressed.



- Select **Sources** in the Settings menu and press **OK** button.
- Press "▼" or "▲" buttons to select a source.
- Use "◀" or "▶" button to enable or disable the selected source. Changes are automatically stored.

Configuring Other Settings

To view general configuration preferences, select **Other Settings** in the Settings menu and press **OK** button.

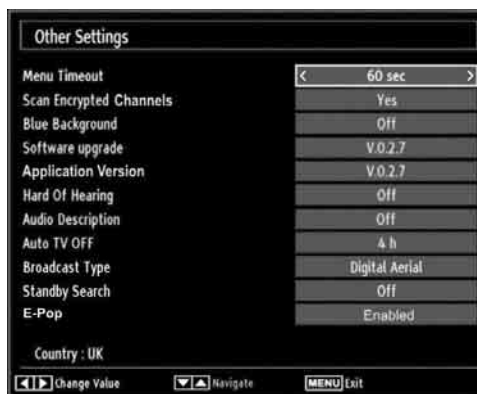

Operation

- Press "▼" or "▲" buttons to select an item.
- Use "◀" or "▶" button to set an option.
- Press **OK** button to view a sub-menu.

Menu Timeout: Changes timeout duration for menu screens.

Scan Encrypted Channels: When this setting is on, search process will locate the encrypted channels as well. If it is set as **Off**, encrypted channels will not be located in automatic search or manual search.

If the country option in the First Time Installation/Other Settings is set to Netherlands, Scan Encrypted will always be YES and this cannot be modified.

Blue Background (Optional): Activates or deactivates blue background system when the signal is weak or absent.

Software Upgrade: To ensure that your TV always has the most update information, you can use this setting. In order for the proper operation, please ensure that the TV is set to standby mode.

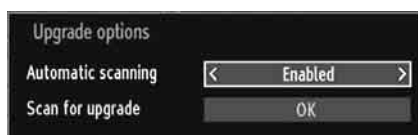

You can enable or disable automatic upgrade by setting **Automatic Scanning** option.

You can manually search for new software by selecting **Scan for upgrade**.

Application version: Displays the current application version.

Hard of Hearing: If the broadcaster enables any special signal concerning the audio, you can set this setting as On to receive such signals. If you have selected the Country option as Netherlands in First Time Installation, performed Ziggo network search and stored Ziggo channels, this option will be set to OFF and remain disabled.

Audio Description: Audio description refers to an additional narration track for blind and visually impaired viewers of visual media, including television and movies. The description narrator talks through the presentation, describing what is happening on the screen during the natural pauses in the audio (and sometimes during dialogue, if deemed necessary). You can use this feature, only if the broadcaster supports that additional narration track.

Auto TV Off: You can set the timeout value of auto off feature. After the timeout value is reached and the TV is not operated for selected time, the TV will go off.

Broadcast Type (optional):

When you set the desired broadcast type by using “◀” or “▶” button, the TV will display the related channel list. If the related source has does not include any stored channels, “No channels for this type have been found.” message will be displayed on the screen.

Standby Search (optional): Use “▼” or “▲” button to select Standby Search and then press “◀” or “▶” button to set this setting as On or Off. If you change Standby Search to Off, this function will be unavailable. To use Standby search please make sure that you select Standby Search as On.

If the Standby Search is set to On, when the TV is in standby mode, available broadcasts will be searched. If the TV locates any new or missing broadcasts, a menu screen will be displayed, asking you whether or not to execute these changes. If you have selected the Country option as Netherlands in First Time Installation, performed Ziggo network search and stored Ziggo channels, this option will be set to OFF and remain disabled.

E-Pop: If you set E-Pop to “enabled”, your TV’s features will be illustrated on the top of the screen.

To deactivate this feature, please set to “disabled”.

Other Features

Displaying TV Information: Programme Number, Programme Name, Sound Indicator, time, teletext, channel type and resolution information is displayed on the screen when a new programme is entered or “INFO” button is pressed.

Mute Function: Press “⊗” button to disable sound. Mute indicator will be displayed in the upper side of the screen. To cancel mute, there are two alternatives; the first one is pressing the “⊗” button and the second one is increasing the volume level.

Picture Mode Selection: By pressing **PRESETS** button, you can change **Picture Mode** settings in accordance with your viewing requirements. Available options are Dynamic, Natural and Cinema.

Displaying Subtitles: Press **LANG** button to select subtitle language and press **SUBTITLE** button to activate or deactivate subtitles.

Selected subtitle language may not be stored when you change channels.

To omit this, you should set the Preferred Subtitle Language option in the Language Settings menu to the desired language. This enables the TV to switch to the preferred subtitle language when the channel is changed.

Teletext

The teletext system transmits information such as news, sports and weather on your TV. Note that if the signal degrades, for example in poor/adverse weather conditions, some text errors may occur or the teletext mode may be aborted.

Teletext function buttons are listed below:

“” **Teletext / Mix** : Activates teletext mode when pressed once. Press again to place the teletext screen over the programme (mix). Pressing again will quit the teletext mode.

“**RETURN**” **Index**: Selects the teletext index page.

“**INFO**” **Reveal**: Shows hidden information (e.g. solutions of games).



“**OK**” **Hold**: Holds a text page when convenient. Press again to resume.

“/” **Subcode Pages** : Selects subcode pages if available when the teletext is activated.

P+ / P- and numbers (0-9): Press to select a page.

Note: Most TV stations use code 100 for their index pages.

Coloured Buttons (RED/GREEN/YELLOW/BLUE)

Your TV supports both **FASTTEXT** and **TOP text** systems. When these systems are available, the pages are divided into groups or topics. When **FASTTEXT** system is available, sections in a teletext page will become colour-coded and can be selected by pressing the coloured buttons. Press a coloured button that corresponds to with your needs. The coloured writings will appear, showing you which coloured buttons to use when **TOP text** transmission is present. Pressing “” or “” commands will request the next or previous page respectively.

Tips

Screen Care: Clean the screen with a slightly damp, soft cloth. Do not use abrasive solvents as they may damage the coating layer of the TV screen. For your safety, unplug the mains plug when cleaning the set. When moving the TV, hold it properly from the bottom part.

Image Persistence: Please note that ghosting may occur while displaying a persistent image. LCD TVs' image persistence may disappear after a short time. Try turning off the TV for a while.

To avoid this, do not leave the screen in still picture for extended periods.

No Power: If your TV system has no power, please check the main power cable and connection to the mains socket outlet.

Poor Picture: Have you selected the correct TV system? Is your TV set or house aerial located too close to a non-earthed audio equipment or neon lights, etc.? Mountains or high buildings can cause double pictures or ghost images. Sometimes you can improve the picture quality by changing the direction of the aerial. Is the picture or teletext unrecognisable? Check if you have entered the correct frequency. Please retune the channels. The picture quality may degrade when two peripherals are connected to the TV at the same time. In such a case, disconnect one of the peripherals.

No Picture: Is the aerial connected properly? Are the plugs connected tightly to the aerial socket? Is the aerial cable damaged? Are suitable plugs used to connect the aerial? If you are in doubt, consult your dealer. No Picture means that your TV is not receiving a transmission. Have you selected the correct button on the remote control? Try once more. Also make sure the correct input source has been selected.

Sound: You can not hear any sound. Did you perhaps interrupt the sound, pressing the  button? Sound is coming from only one of the speakers. Is the balance set to one extreme? See **Sound Menu**.

Remote Control: Your TV no longer responds to the remote control. Perhaps the batteries are exhausted. If so you can still use the local buttons on the TV.

Input Sources: If you cannot select an input source, it is possible that no device is connected. Check the AV cables and connections if you have tried to connect a device.

Recording Unavailable: To record a programme, you should first connect a USB disk to your TV while the TV is switched off. You should then switch on the TV to enable recording feature. Otherwise, recording feature will not be available. If you cannot perform recording, try switching off the TV and then re-inserting the USB device while the TV is switched off.

USB Is too Slow: If “USB is too slow” message is displayed on the screen while starting a recording, try restarting the recording. If you still get the same error, it is possible that your USB disk does not meet the speed requirements. Try connecting another USB disk.

Appendix A: PC Input Typical Display Modes

The display has a maximum resolution of 1920 x 1080. The following table is an illustration of some of the typical video display modes. Your TV may not support different resolutions. Supported resolution modes are listed below. If you switch your PC to an unsupported mode, a warning OSD will appear on the screen.

Index	Resolution	Frequency
1	640x350	85 Hz
2	640x400	70 Hz
3	640x480	60Hz-66Hz-72Hz -75Hz-85Hz
4	800x600	56Hz-60Hz-70Hz-72Hz -75Hz-85Hz
5	832x624	75 Hz
6	1024x768	60Hz-66Hz-70Hz-72Hz -75Hz
7	1152x864	60Hz-70Hz-75Hz -85 Hz
8	1280x768	60 HzA
9	1280x768	60 HzB
10	1280x768	75Hz-85Hz
11	1280x960	60Hz-75Hz-85Hz
12	1280x1024	60Hz-75Hz-85Hz
13	1360x768	60 Hz
14	1400x1050	60 HzA
15	1400x1050	60 HzB
16	1400x1050	75Hz-85Hz
17	1400x900	65Hz-75Hz
18	1600x1200	60 Hz
19	1680x1050	60 Hz
20	1920x1080	60 HzA
21	1920x1080	60 HzB

Appendix B: AV and HDMI Signal Compatibility (Input Signal Types)

Source	Supported Signals	Available	
EXT (SCART)	PAL 50/60	O	
	NTSC 60	O	
	RGB 50	O	
	RGB 60	O	
Side AV	PAL 50/60	O	
	NTSC 60	O	
YPbPr	480I	60Hz	O
	480P	60Hz	O
	576I	50Hz	O
	576P	50Hz	O
	720P	50Hz	O
	720P	60Hz	O
	1080I	50Hz	O
	1080I	60Hz	O
	1080P	50Hz	O
	1080P	60Hz	O
HDMI	480I	60Hz	O
	480P	60Hz	O
	576I	50Hz	O
	576P	50Hz	O
	720P	50Hz	O
	720P	60Hz	O
	1080I	50Hz	O
	1080I	60Hz	O
	1080P	24Hz	O
	1080P	25Hz	O
	1080P	30Hz	O
	1080P	50Hz	O
	1080P	60Hz	O

(X: Not Available, O: Available)

In some cases a signal on the LCD TV may not be displayed properly. The problem may be an inconsistency with standards from the source equipment (DVD, Set-top box, etc.). If you do experience such a problem please contact your dealer and also the manufacturer of the source equipment.

Appendix C: Supported DVI Resolutions

When connecting devices to your TV's connectors by using DVI to HDMI cables (not supplied), you can refer to the following resolution information.

Index	Resolution	Frequency
1	640x400	70Hz
2	640x480	60Hz-66Hz-72Hz -75Hz
3	800x600	56Hz-60Hz-70Hz- 72Hz -75Hz
4	832x624	75 Hz
5	1024x768	60Hz-66Hz-70Hz- 72Hz -75Hz
6	1152x864	60Hz-70Hz-75Hz
7	1152x870	75Hz
8	1280x768	60 HzA
9	1280x768	60 HzB
10	1280x768	75Hz
11	1280x960	60Hz-75Hz
12	1280x1024	60Hz-75Hz
13	1360x768	60 Hz
14	1400x1050	60 HzA
15	1400x1050	60 HzB
16	1400x1050	75Hz
17	1400x900	65Hz-75Hz
18	1600x1200	60 Hz
19	1680x1050	60 Hz
20	1920x1080	60 HzA
21	1920x1080	60 HzB
22	1920x1200	60HzA
23	1920x1200	60Hz
24	480i-480p	60Hz
25	576i-576p	50Hz

Appendix D: Supported File Formats for USB Mode

Media	File Extension	Format		Remarks
		Video	Audio	(Maximum resolution/Bit rate etc.)
Movie	.mpg, .mpeg	MPEG1, 2	MPEG Layer 1/2/3	MAX 1920x1080 @ 30P 20Mbit/sec
	.dat	MPEG1, 2	MPEG2	
	.vob	MPEG2		
	.mkv	H.264, MPEG1,2,4	EAC3 / AC3	
	.mp4	MPEG4, Xvid 1.00, Xvid 1.01, Xvid 1.02, Xvid 1.03, Xvid 1.10-beta1/2 H.264	PCM/MP3	MAX 1920x1080 @ 30P 20Mbit/sec
	.avi	MPEG2, MPEG4	PCM/MP3	
		Xvid 1.00, Xvid 1.01, Xvid 1.02, Xvid 1.03, Xvid 1.10-beta1/2 H.264	PCM	
.avi, .dvix(optional)	Divx 3.11, Divx 4.Divx 5, Divx 6	PCM/MP3/AC-3	(MAX 1920x1080 @ 30P - 20Mbit/sec) (HD DivX is not supported.)	
Music	.mp3	-	MPEG 1 Layer 1 / 2 (MP3)	32Kbps ~ 320Kbps(Bit rate) 32KHz ~ 48KHz(Sampling rate)
Photo	.jpg .jpeg	Baseline JPEG		max WxH = 15360x8640 4147200bytes
		Progressive JPEG		max WxH = 1024x768 6291456bytes
	.bmp	-		max WxH = 9600x6400 3840000bytes
Subtitle	.sub	-		-
	.srt	-		

Note: It is not guaranteed that all DivX® formats are supported.



Appendix E: Software Upgrade

- Your TV is capable of finding and updating new software upgrades over broadcast channels.
- For broadcast channels search, TV looks the available channels stored in your settings. So before software upgrade search, it is advised to auto search and update all available channels.

1) Software upgrade search via user interface

- It is possible manually to check if there is a new software upgrade for your TV set.
- Simply navigate on your main menu. Choose **Settings** and select **Other Settings** menu. In **Other Settings** menu navigate on to the **Software Upgrade** item and press **OK** button to open **Upgrade Options** menu.
- In **Upgrade Options** menu select **Scan for upgrade** and press **OK** button.
- If a new upgrade is found, it starts to download the upgrade. A progress bar indicates the remaining download progress. When download completes with success a message is displayed for reboot to activate new software. Press **OK** to continue with the reboot operation.

2) 3.AM search and upgrade mode

- If **Automatic scanning** in **Upgrade Options** menu is enabled, TV wakes up at 03:00 and searches broadcast channels for new software upgrade. If new software is found and downloaded successfully, with next power up TV opens with new software version.

Note on reboot operation: Reboot is the last step in software upgrade operation if download of new software is finished successfully. During reboot TV makes final initializations. In reboot sequence panel power is closed and front led indicates the activity with blinking. Around 5 minutes later TV restarts with new software activated.

- If your TV fails to restart in 10 minutes, unplug power for 10 minutes and re-plug again. TV should open with new software safely. If you still can not get TV working, please kindly repeat unplug and plug sequence a few times more. If your set still can not operate, please call the service personnel to fix the problem for you.

Caution: While led is blinking during reboot do not unplug your TV's power. Doing this may cause your TV not to re-open again and can only be fixed by service personnel.



Products



Battery

Information for Users on Disposal of old Equipment and Batteries

[European Union only]

These symbols indicate that equipment with these symbols should not be disposed of as general household waste. If you want to dispose of the product or battery, please consider the collection systems or facilities for appropriate recycling.

Notice: The sign Pb below the symbol for batteries indicates that this battery contains lead.



Specifications

TV BROADCASTING

PAL/SECAM B/G D/K K' I/I' L/L'

RECEIVING CHANNELS

VHF (BAND I/III)

UHF (BAND U)

HYPERBAND

NUMBER OF PRESET CHANNELS

1000

CHANNEL INDICATOR

On Screen Display

RF AERIAL INPUT

75 Ohm (unbalanced)

OPERATING VOLTAGE

220-240V AC, 50Hz.

AUDIO

German + Nicam Stereo

AUDIO OUTPUT POWER (W_{RMS}) (10% THD)

2 x 2,5

POWER CONSUMPTION (W)

50 W (max)

< 0,5 W (Standby)

PANEL

16:9 display, 24" (60 cm) Screen Size

DIMENSIONS (mm)

DxLxH (With foot): 149 x 580,4 x 404,8

Weight (Kg): 5,65

DxLxH (Without foot): 35,5 x 580,4 x 379,6

Weight (Kg): 5,00

Digital Reception (DVB-C)

Transmission Standards:

DVB-C, MPEG2, DVB-C, MPEG4

i. DEMODULATION

-Symbolrate: 4.0 Msymbols/s to 7.2 Msymbols/s

- Modulation: 16-QAM , 32-QAM ,64-QAM, 128-QAM and 256-QAM

ii. VIDEO

- All MPEG2 MP@ML formats with up-conversion and filtering to CCIR601 format.

-CVBS analogue output

iii. AUDIO

-All MPEG1 Layer 1 and 2 modes

-Sampling frequencies supported are 32, 44.1 & 48 kHz



Digital Reception	MHEG-5 ENGINE compliant with ISO/IEC 13522-5 UK engine Profile 1	for UK
	Object carousel support compliant with ISO/IEC 135818-6 and UK DTT profile	
	Frequency range: 474-850 MHz for UK models	
	170-862 MHz for EU models	
	Transmission standard: DVB-T. MPEG-2, MPEG-4	
	Demodulation: COFDM with 2K/8K FFT mode	
	FEC: all DVB modes	
	Video: MP@ML, PAL, 4:3/16:9	
	Audio: MPEG Layer I&II 32/44.148kHz.	

Dimensional Drawings

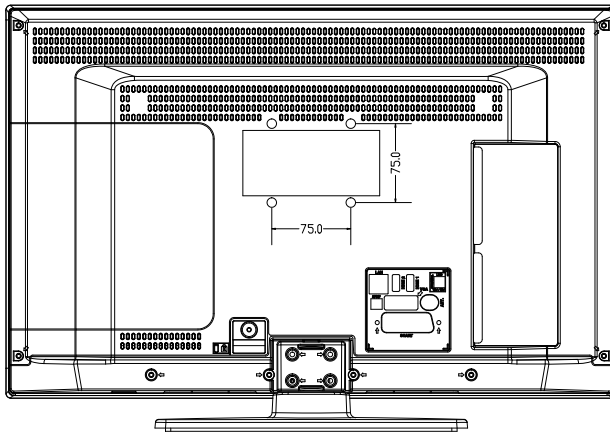
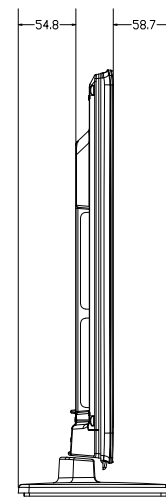
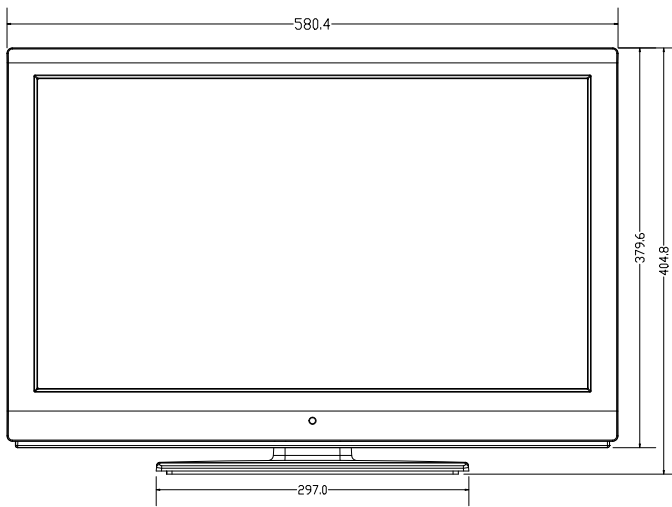
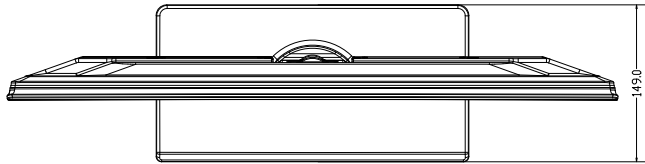



End of life disposal



Attention: Your product is marked with this symbol. It means that used electrical and electronic products should not be mixed with general household waste. There is a separate collection system for these products.

A. Information on Disposal for Users (private households)

1. In the European Union

Attention: If you want to dispose of this equipment, please do not use the ordinary dust bin!

Used electrical and electronic equipment must be treated separately and in accordance with legislation that requires proper treatment, recovery and recycling of used electrical and electronic equipment.

Following the implementation by member states, private households within the EU states may return their used electrical and electronic equipment to designated collection facilities free of charge*. In some countries* your local retailer may also take back your old product free of charge if you purchase a similar new one.

*) Please contact your local authority for further details.

If your used electrical or electronic equipment has batteries or accumulators, please dispose of these separately beforehand according to local requirements.

By disposing of this product correctly you will help ensure that the waste undergoes the necessary treatment, recovery and recycling and thus prevent potential negative effects on the environment and human health which could otherwise arise due to inappropriate waste handling.

2. In other Countries outside the EU

If you wish to discard this product, please contact your local authorities and ask for the correct method of disposal.

For Switzerland: Used electrical or electronic equipment can be returned free of charge to the dealer, even if you don't purchase a new product. Further collection facilities are listed on the homepage of www.swico.ch or www.sens.ch.

B. Information on Disposal for Business Users

1. In the European Union

If the product is used for business purposes and you want to discard it:

Please contact your SHARP dealer who will inform you about the take-back of the product. You might be charged for the costs arising from take-back and recycling. Small products (and small amounts) might be taken back by your local collection facilities.

For Spain: Please contact the established collection system or your local authority for take-back of your used products.

2. In other Countries outside the EU

If you wish to discard of this product, please contact your local authorities and ask for the correct method of disposal.



The battery supplied with this product contains traces of Lead.

For EU: The crossed-out wheeled bin implies that used batteries should not be put to the general household waste! There is a separate collection system for used batteries, to allow proper treatment and recycling in accordance with legislation. Please contact your local authority for details on the collection and recycling schemes.

For Switzerland: The used battery is to be returned to the selling point.

For other non-EU countries: Please contact your local authority for correct method of disposal of the used battery.

Installing the Stand

IMPORTANT

Please read the following information carefully before attaching the stand to your new Sharp Television.

Installing the Stand

- Before fitting the stand, ensure that the TV is unplugged from its power source.
- Place the Sharp Television (1) on a soft, stable and flat surface, facing down.
- Place the Stand (3) on the stand mounting pattern on the rear side of the TV.
Ensure the Stand (3) is placed correctly and that you can see the screw holes on the back of the Sharp Television.
- Place the Stand Cover (2) on the Stand (3).
- Ensure the Stand Cover (3) is placed correctly and that you can see the screw holes on the back of the Sharp Television.
- DO NOT insert the screws before placing the plastic molding.
- Insert the four screws provided and tighten them gently until the stand is properly fitted.

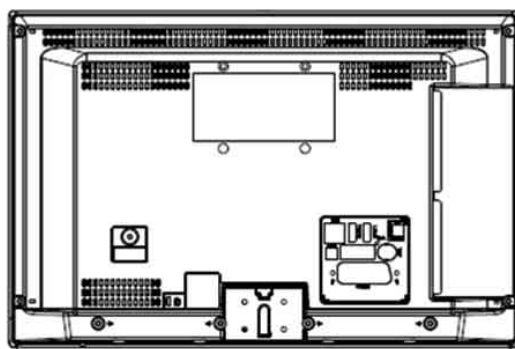

1. Sharp Television

2. Stand Cover

3. Stand



Uninstalling the Stand

IMPORTANT

Please read the following information carefully before detaching the stand of your Sharp Television.

Uninstalling the Stand

- Before detaching the stand, ensure that the TV is unplugged from its power source.
- Place the Sharp Television on a soft, stable and flat surface, facing down.
- Unscrew gently the four screws that attach the foot assembly and remove the screws when they are completely unscrewed.
- Remove the stand and plastic moulding gently from the panel.

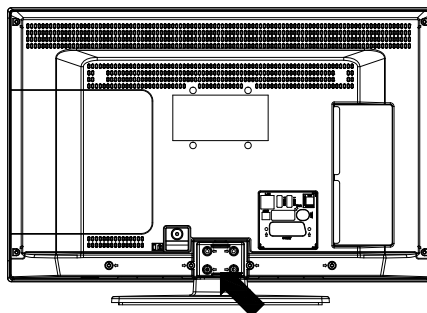
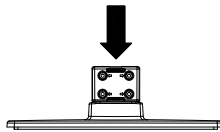
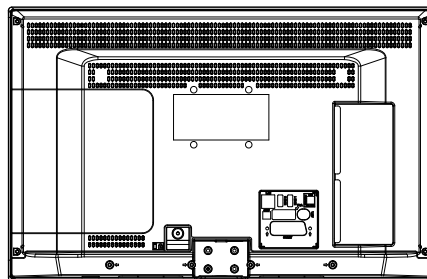

English - 42 -

Screw Dimensions

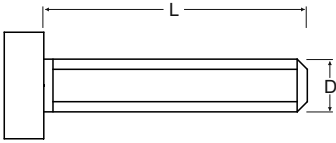

Model	D	L	Item Number	VESA	Installation of the Screw
LC-24LE240E	Ø4	30	4	75 x 75 (W x H)	To the wall
	M4	18	4		To the product

Free Manuals Download Website

<http://myh66.com>

<http://usermanuals.us>

<http://www.somanuals.com>

<http://www.4manuals.cc>

<http://www.manual-lib.com>

<http://www.404manual.com>

<http://www.luxmanual.com>

<http://aubethermostatmanual.com>

Golf course search by state

<http://golfingnear.com>

Email search by domain

<http://emailbydomain.com>

Auto manuals search

<http://auto.somanuals.com>

TV manuals search

<http://tv.somanuals.com>