

- The illustrations and the OSD in this operation manual are for explanation purposes and may vary slightly from the actual operations.
- The examples used throughout this manual are based on the LC-32DH500E and LC-32DH510E models.
- The LC-32DH500E, LC-32DH500S, LC-32DH510E and LC-32DH510S models are compatible with high definition broadcasts, H.264 compressed (MPEG4 H.264, MPEG4 AVC, MPEG4 AVC/H.264).

Contents

Contents	1	Menu Operation	16
Introduction	2	What is the menu?	16
Dear SHARP customer	2	Common operations	16
Important Safety Precautions	2	Basic Adjustment	17
Trademarks	2	Picture adjustments	17
Remote Control unit	3	AV MODE	17
TV (Front view)	4	Sound adjustments	17
TV (Top and rear view)	4	Channel settings	18
Preparation	5	Install channels	18
Supplied accessories	5	Time settings	18
How to detach the stand of the TV	5	Option settings.....	18
Optional accessory	5	Lock settings.....	19
Inserting the batteries	6	Useful viewing functions	20
Using the Remote Control unit	6	Channel list	20
Cautions regarding the remote control unit	6	Selecting the channel you want display	20
Quick guide	7	Channel information display (DTV only)	20
Initial installation overview	7	Selecting the picture format	20
Before turning on the power	8	Selecting the picture format manually	20
Inserting a CA card	8	Other useful features	21
Initial Auto Installation	9	Setting when using external devices	21
Checking quality and signal strength	9	Input source settings	21
Watching TV	10	Connecting a USB device (Media Player function)	21
Daily operation	10	MEDIA PLAYER FUNCTION	21
Switching on/off	10	PHOTO MODE	21
Switching between analogue and digital broadcasts ..	10	MUSIC MODE	22
Changing channels	10	MOVIE MODE	22
Selecting an external video source	10	TEXT MODE	22
Selecting language	10	USB device compatibility	23
Selecting subtitle language	10	Power save settings	23
EPG	11	Abbreviation list	23
Selecting a programme using EPG	11	Timeshift function	24
Teletext	12	Appendix	25
Using MHEG-5 application (UK only)	12	Troubleshooting	25
Connecting external devices	13	Information on the software license for this product	25
Introduction to connections	13	Fixing the TV on a wall.....	25
HDMI connection	14	Specifications	26
Components connection	14	Environmental Specifications	26
VIDEO connection	14	Information about EU Eco-Label	27
SCART connection	15	End of life disposal	28
PC connection by HDMI (DVI)	15		
HDMI connection	15		
Speaker/amplifier connection	15		

Introduction

Dear SHARP customer

Thank you for your purchase of the SHARP LCD colour TV product. To ensure safety and many years of trouble-free operation of your product, please read the Important Safety Precautions carefully before using this product.

Important Safety Precautions

- Cleaning—Unplug the AC cord from the AC outlet before cleaning the product. Use a damp cloth to clean the product. **Do not use liquid cleaners** or aerosol cleaners.
- Use a soft damp cloth to gently wipe the panel when it is dirty. To protect the panel, do not use a chemical cloth to clean it. Chemicals may cause damage or cracks in the cabinet of the TV.
- Water and moisture—Do not use the product near water, such as bathtub, washbasin, kitchen sink, laundry tub, swimming pool and in a wet basement.
- Do not place vases or any other water-filled containers on this product. The water may spill onto the product causing fire or electric shock.
- Stand—Do not place the product on an unstable cart, stand, tripod or table. Doing so can cause the product to fall, resulting in serious personal injuries as well as damage to the product. Use only a cart, stand, tripod, bracket or table recommended by the manufacturer or sold with the product. When mounting the product on a wall, be sure to follow the manufacturer's instructions. Use only the mounting hardware recommended by the manufacturer.
- When relocating the product placed on a cart, it must be moved with utmost care. Sudden stops, excessive force and uneven floor surface can cause the product to fall from the cart.
- Ventilation—The vents and other openings in the cabinet are designed for ventilation. Do not cover or block these vents and openings since insufficient ventilation can cause overheating and/or shorten the life of the product. Do not place the product on a bed, sofa, rug or other similar surface, since they can block ventilation openings. This product is not designed for built-in installation; do not place the product in an enclosed place such as a bookcase or rack, unless proper ventilation is provided or the manufacturer's instructions are followed.
- The LCD panel used in this product is made of glass. Therefore, it can break when the product is dropped or impact applied. If the LCD panel is broken, be careful not to be injured by broken glass.
- Heat sources—Keep the product away from heat sources such as radiators, heaters, stoves and other heat-generating products (including amplifiers).
- Headphones—Do not set the volume at a high level. Hearing experts advise against extended listening at high volume levels.
- To prevent fire, never place any type of candle or naked flames on the top or near the TV set.
- To prevent fire or shock hazard, do not place the AC cord under the TV set or other heavy items.
- Do not display a still picture for a long time, as this could damage the LCD screen.
- There is power consumption always if main plug is connected.
- Servicing—Do not attempt to service the product yourself. Removing covers can expose you to high voltage and other dangerous conditions. Request a qualified person to perform servicing.

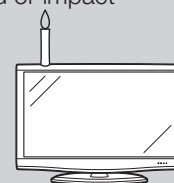
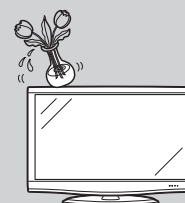

The LCD panel is a very high technology product, giving you fine picture details.

Due to the very large number of pixels, occasionally a few non-active pixels may appear on the screen as a fixed point of blue, green or red. This is within product specifications and does not constitute a fault.

Precautions when transporting the TV

When transporting the TV, never carry it by holding onto the speakers. Be sure to always carry the TV by two people holding it with two hands—one hand on each side of the TV.

Trademarks

- “HDMI, the HDMI logo and High-Definition Multimedia Interface are trademarks or registered trademarks of HDMI Licensing LLC.”
- Manufactured under license from Dolby Laboratories.
- “Dolby” and the double-D symbol are trademarks of Dolby Laboratories.
- The “HD ready” and “HD TV” Logos are trademark of EICTA.
- The DVB logo is the registered trademark of the Digital Video Broadcasting—DVB—project.
- DivX® is a registered trademark of DivX, Inc., and is used under license.

Remote control unit

- 1 **Standby/On**
Enter standby mode or turn on the power.
- 2 **Channel information / EPG**
(See pages 11 and 20.)
- 3 **DTV MENU**
Display the MEDIA PLAYER screen.
- 4 **0-9**
Set the channel in TV mode.
Set the page in Teletext mode.

When one of the 5 Nordic countries (Sweden, Norway, Finland, Denmark or Iceland) is selected in the country setting of Auto Installation, DTV channels are 4 digits. When another country is selected, DTV channels are 3 digits.

- 5 **Flashback**
Press to return to the previous selected channel or external input mode.
- 6 **DTV**
Change between ATV and DTV mode.
- 7 **Picture format**
Change between different picture formats (see page 20.)
- 8 **Sound Mode / Timeshift**
DH500: Change between different sound modes established.
DH510: Activate or deactivate the Timeshift.
- 9 **(Cursor)**
Select a desired item on the setting screen.
OK
Execute a command within the menu screen.
TV/DTV: Display the programme list. (See page 20.)
- 10 **END**
Exit the menu screen.
- 11 **EPG**
DTV: To display EPG (Electronic Programme Guide) screen. (See page 11.)
- 12 **Teletext**
ATV: Select the TELETEXT mode (See page 12.)
DTV: Select DTV (MHEG-5) data broadcasting or TELETEXT.

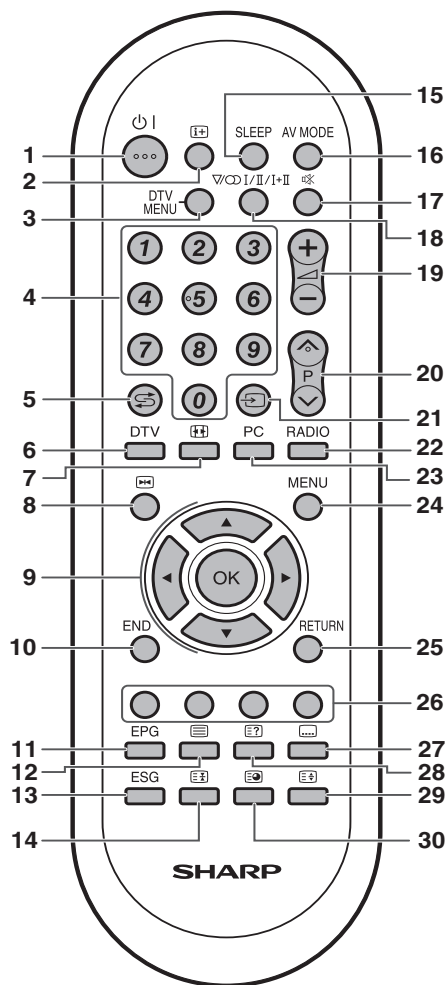

- 15 **(+/-) Volume**
 (+) Increase the volume.
 (-) Decrease the volume.
- 16 **SLEEP**
Set the sleep timer on (in units of 10 min. up to max. 4 hr) and off.
- 17 **Mute**
Switch the sound on and off.
- 18 **Audio mode**
Select the sound multiplex mode. (See below.)
- 19 **(+/-) Volume**
 (+) Increase the volume.
 (-) Decrease the volume.
- 20 **P**
TV/DTV: Select the program or move up or down the channel list pages.
Input source: Switch to TV or DTV input mode.
Teletext: Move to the next/previous page.
- 21 **Input source**
Select an input source. (See page 10.)
- 22 **RADIO**
Switch between RADIO and DTV mode.
•Due to the large variation in transmitted volume levels in RADIO mode, some stations will produce distortion if the volume level is set too high.
- 23 **PC**
Not used.
- 24 **MENU**
Display the MENU screen. (See page 16.)
- 25 **RETURN**
Not used.
- 26 **Colour (Red/Green/Yellow/Blue)**
TELETEXT: Select a page. (See page 12.)
DTV: The coloured buttons are used to select correspondingly to the coloured items in the menu screen.
- 27 **Subtitle for Teletext**
ATV: Subtitles on / off.
DTV: Display the subtitle selection screen. (See page 12.)
- 28 **Reveal hidden Teletext**
(See page 12.)
- 29 **Top/Bottom/Full**
Switch the Teletext image to Top, Bottom or Full.
- 30 **Subpage**
(See page 12.)

• Using on the remote control unit

DTV mode:

Press to open the multi audio screen. (See page 10.)

Analogue TV mode:

Each time you press , the mode switches as illustrated in the following tables:

NICAM TV broadcasts selection

Singnal	Selectable items
Stereo	NICAM STEREO, MONO
Bilingual	NICAM CH A, NICAM CH B, NICAM CH AB, MONO
Monoaural	NICAM MONO, MONO

A2 TV broadcasts selection

Singnal	Selectable items
Stereo	STEREO, MONO
Bilingual	CH A, CH B, CH AB
Monoaural	MONO

Introduction

TV (Front view)

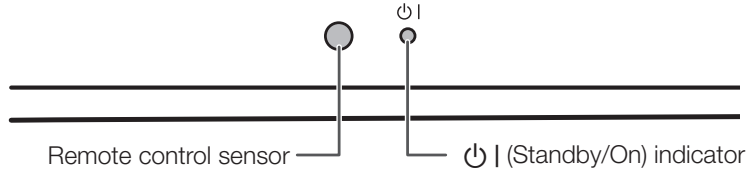
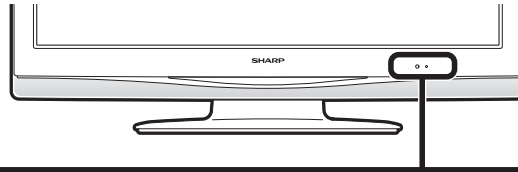

TV (Top and rear view)

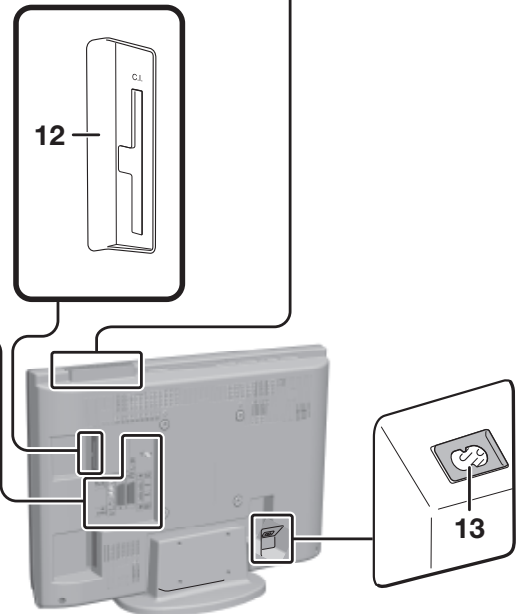
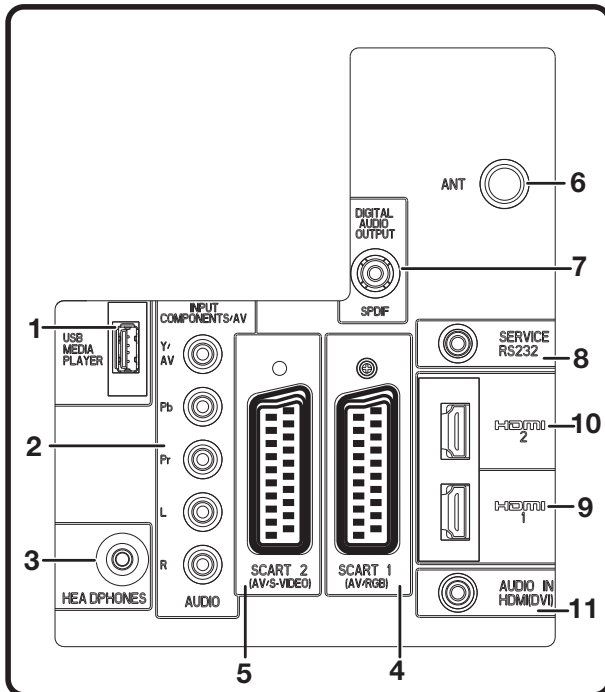
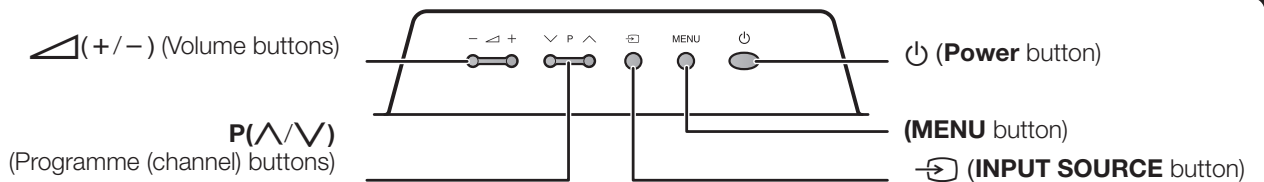

- | | | |
|---------------------------------|-----------------------------------|--------------------------|
| 1 USB terminal | 6 Antenna input terminal | 11 AUDIO input for DVI |
| 2 COMPONENTS / AV terminals | 7 OUTPUT (DIGITAL AUDIO) terminal | 12 COMMON INTERFACE slot |
| 3 HEADPHONES jack | 8 SERVICE connector (jack 3.5mm) | 13 AC INPUT terminal |
| 4 SCART 1 (AV/RGB) terminal | 9 HDMI 1 (HDMI/AUDIO-DVI) | |
| 5 SCART 2 (AV/S-VIDEO) terminal | 10 HDMI 2 (HDMI/AUDIO-DVI) | |

WARNING

- Excessive sound pressure from earphones and headphones can cause hearing loss.
- Do not set the volume at a high level. Hearing experts advise against extended listening at high volume levels.

Preparation

Supplied accessories

Remote control unit
(× 1)

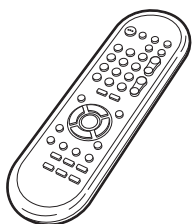

AC cord (× 1)



Product shape varies in
some countries.

• “AA” size zinc-carbon battery (× 2)

• Operation manual (This publication)

How to detach the stand of the TV

- This TV is supplied with the stand attached.
- If you need to detach the stand (e.g. to mount the TV on the wall), read carefully these instructions.

CAUTION

- Before detaching (or attaching) the stand, unplug the AC cord from the AC INPUT terminal.
- Before starting to perform, spread a cushioning over the surface of where you will lay the TV on. This will prevent it from being damaged.

1 Lay the TV on a table with the way that the stand would stay out of the table and the screen on the surface of the cushioning as indicated in the drawing.

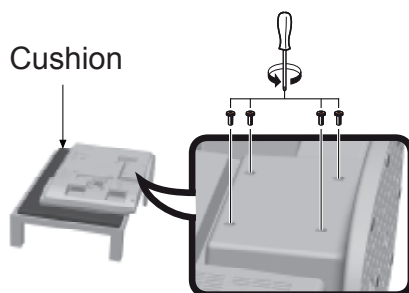

- 2** Using a star shaped screwdriver of the proper size (no supplied), remove the screws which fasten the stand as indicated below:
- a. Loosen four screws (Approx. a half-turn)
 - b. Unscrew completely three of four screws (two from the bottom area and the other one from the upper area)
 - c. Hold the stand in one hand with the way that the it will not fall down on unscrewing the last screw.
- 3** Keep the stand and four screws in case you may need to attach them in the future.

NOTE

- To attach the stand, perform the above steps in reverse order.

Optional accessory

The listed optional accessories are available for this LCD colour TV. Please purchase them at your nearest shop.

- Additional optional accessories may be available in the near future. When purchasing, please read the newest catalogue for compatibility and check the availability.

No.	Part name	Part number
1	Wall mount bracket	AN-37AG5

Preparation

Inserting the batteries

Before using the TV for the first time, insert two supplied "AA" size zinc-carbon batteries. When the batteries become depleted and the remote control unit fails to operate, replace the batteries with new "AA" size batteries.

- 1 Hold in the tab on the battery cover and pull the cover towards the direction of the arrow.
- 2 Insert two supplied "AA" size batteries.
 - Place batteries with their terminals corresponding to the (+) and (-) indications in the battery compartment.
- 3 Close the battery cover.

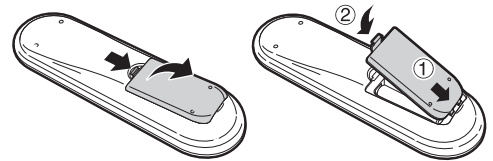

CAUTION

Improper use of batteries can result in chemical leakage or explosion. Be sure to follow the instructions below.

- Do not mix batteries of different types. Different types of batteries have different characteristics.
- Do not mix old and new batteries. Mixing old and new batteries can shorten the life of new batteries or cause chemical leakage in old batteries.
- Remove batteries as soon as they have worn out. Chemicals that leak from batteries can cause a rash. If you find any chemical leakage, wipe thoroughly with a cloth.
- The batteries supplied with this product may have a shorter life expectancy due to storage conditions.
- If you will not be using the remote control unit for an extended period of time, remove the batteries from it.

Note on disposing batteries:

The batteries provided contain no harmful materials such as cadmium, lead or mercury.

Regulations concerning used batteries stipulate that batteries may no longer be thrown out with the household rubbish. Deposit any used batteries free of charge into the designated collection containers set up at commercial businesses.

Using the remote control unit

Use the remote control unit by pointing it towards the remote control sensor. Objects between the remote control unit and sensor may prevent proper operation.

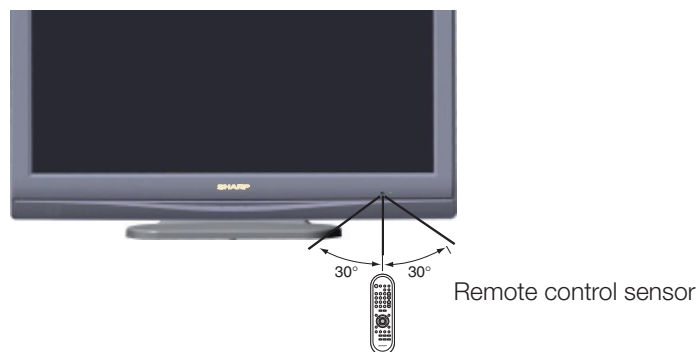

Cautions regarding the remote control unit

- Do not expose the remote control unit to shock. In addition, do not expose the remote control unit to liquids, and do not place in an area with high humidity.
- Do not install or place the remote control unit under direct sunlight. The heat may cause deformation of the unit.
- The remote control unit may not work properly if the remote control sensor of the TV is under direct sunlight or strong lighting. In such cases, change the angle of the lighting or the TV, or operate the remote control unit closer to the remote control sensor.

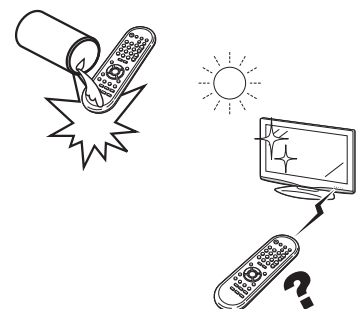

Quick guide

Initial installation overview

Follow the steps below one by one when using the TV for the first time. Some steps may not be necessary depending on your TV installation and connection.

1

Preparation

- 1 Connect an antenna cable to the antenna terminal (Page 8).

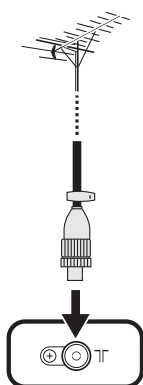

- 2 If necessary, insert a CA card into the CI slot to watch scrambled broadcasts (Page 8.)

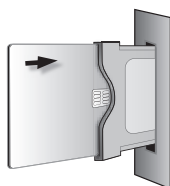

- 3 Connect the AC cord to the TV (Page 8).

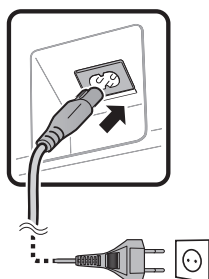

Product shape varies in some countries.

2

Power on and run the auto installation

- 1 Turn on the power using  on the TV (Page 10).

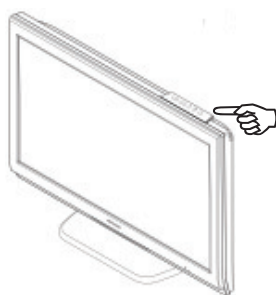

- 2 Run the initial auto installation (Page 9).
✓ Language and country setting



✓TV Location setting

Home

Store



Start searching channels

3

Watch TV

- 1 **Congratulations!**
Now you can watch TV.
- 2 If necessary, adjust the antenna to attain maximum signal reception (Page 9).

Connect external devices

- 1 Connect external devices such as a DVD player/recorder as instructed (Pages 14 and 15).

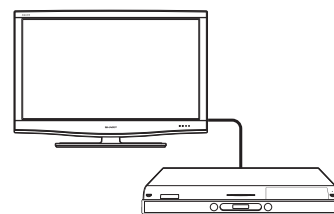

- 2 Connect external audio devices such as speakers/amplifier as instructed (Pages 14 and 15).

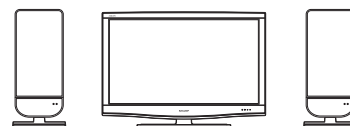

Before turning on the power

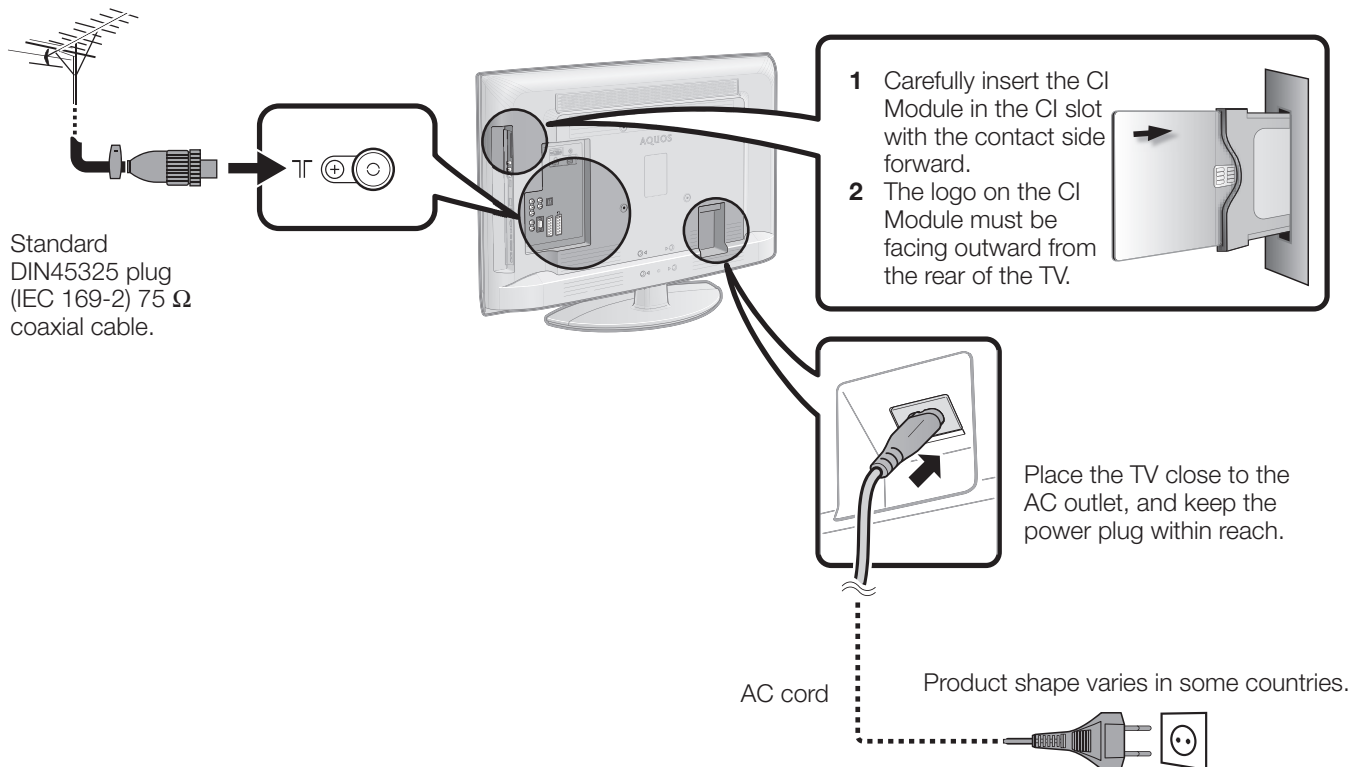

Inserting a CA Card

In order to receive coded digital stations, a Common Interface Module (CI Module) and a CA Card must be inserted in the CI slot of the TV. The CI Module and the CA Card are not supplied accessories. They are usually available from your dealers.

Inserting the CA Card into the CI Module

- With the side with the gold coloured contact chip facing the side of the CI Module marked with the provider's logo, push the CA Card into the CI Module as far as it will go. Note the direction of the arrow printed on the CA Card.

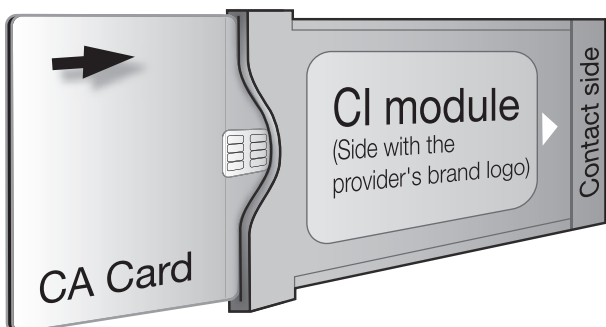

Inserting the CI Module in the CI slot

- Carefully insert the CI Module in the CI slot with the contact side forward. The logo on the CI Module must be facing outward from the rear of the TV. Do not use excessive force. Make sure the module is not bent in the process.

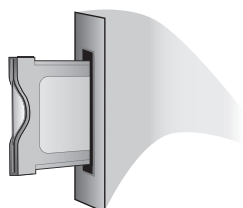

Checking CI Module information

NOTE

- Make sure that the CI Module is properly inserted.
- This menu is only available for digital stations.

- Press **MENU** and the "PICTURE" menu is shown.
- Press **◀/▶** to select "CHANNEL" menu.
 - The content of this menu depends on the provider of the CI Module.
- Press **▲/▼** to select "CI information", and then press **OK**.

● Module

General information on CI Module displays.

● Menu

Adjustment parameters of each CA Card displays.

● Enquiry

You can input numerical values such as passwords here.

NOTE

The content of each screen depends on the provider of the CI Module.

Quick guide

Initial auto installation

When the TV is powered on for the first time after purchase, the initial auto installation wizard appears. Follow the menus and make the necessary settings one after another.

Confirm the following before turning on the power

- Is the antenna cable connected?
- Is the AC cord plugged in?

- 1 Press  on the TV.
 - The initial auto installation wizard appears.
- 2 Setting the OSD language.



Press /// to select the desired language.

- 3 Setting the country.

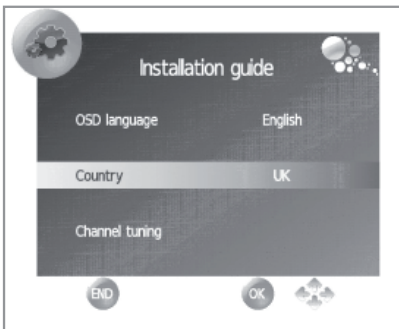

Press /// to select your country or area.

- This setting screen only appears during the first installation.

- 4 Starting channel search.





Press / to select "**Channel tuning**" and then press **OK**.

- If you want to search for more broadcasts, execute "DTV (or ATV) manual tuning" from the menu "CHANNEL" (Page 18).
- To watch both analogue broadcasts and digital broadcasts, you should perform the channel search setting "DTV+ATV".

- 5 Selecting the TV location.



Press / to select where you will use this TV, and then press **OK**.

•**HOME:** For home.

•**STORE: DYNAMIC** mode is predetermined. If the "**Picture Mode**" is changed, the TV will automatically switch back to "**DYNAMIC**" when there is no signal input from the TV or remote control unit for 30 minutes.

If you have chosen "**STORE**" by mistake, go to "**OPTION**" → "**Restore Factory Default**" → **OK**, and the TV returns to the initial screen.

- 6 The TV searches for, sorts and stores all the receivable TV stations according to their settings and the connected antenna.

•To cancel the initial auto installation in progress, press **END**.

NOTE

- If you turn the power on the TV after performing step 4, initial auto installation wizard does not appear. The auto installation function allows you to execute the installation again from the "CHANNEL" menu (Page 18).
- The initial auto installation wizard will turn off if you leave the TV unattended for 30 minutes before searching for channels in step 4.
- After initial Auto Tuning is completed, the default PIN is automatically set to "1234". To change the PIN setting, refer to "LOCK" menu on page 19.

Checking quality and signal strength

If you install a DVB-T antenna for the first time or relocate it, you should adjust the alignment of the antenna to receive a good reception while checking the antenna setup screen.

- 1 Press a channel you want to check.
- 2 Press **MENU**. "**PICTURE**" menu will appear.
- 3 Press / to select "**CHANNEL**" menu.
- 4 Press / to select "**Signal Information**" and then press **OK**.

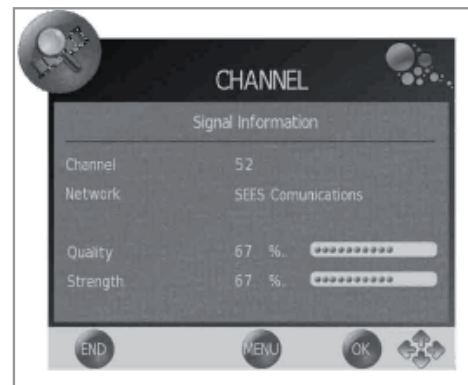

- 5 Position and align the antenna so that the maximum possible values for "Quality" and "Strength" are obtained.

NOTE

The values of "Quality" and "Signal Strength" indicate when to check the appropriate alignment of the antenna.

Watching TV

Daily operation

Switching on/off

Turning on/off the power

Press  on the TV to switch it on.
Switch it off by pressing  on the TV.

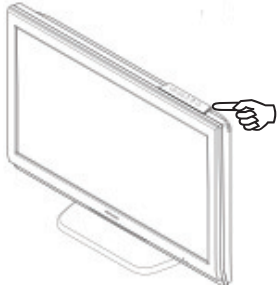

NOTE

- When turning off the power using  on the TV, EPG data will be lost.

* The terminal layout may differ depending on the model.

Standby mode

Switching to standby mode

If the TV is switched on (GREEN LED), you can switch it to standby by pressing  on the remote control unit.

Switching on from standby

From standby (RED LED), press  on the remote control unit.

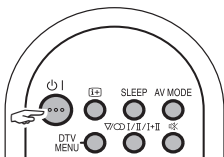

TV indicator status

 indicator	Status
Off	Power off
Green	Power on
Red	Standby

NOTE

- If you are not going to use this TV for a long period of time, be sure to remove the AC cord from the AC outlet.
- A small amount of electric power is still consumed even when  is turned off.

Switching between analogue and digital broadcasts

- Press “DTV” to change between ATV and DTV mode.



Changing channels



With P  :



With 0-9:



Selecting an external video source

Once the connection is made, press  to display the “INPUT SOURCE” screen, and then press / to switch over to the appropriate external source with **OK**.

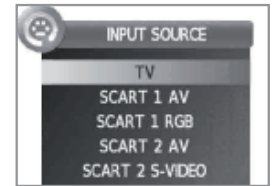

Selecting language audio

DTV mode:

Pressing  appear a menu with languages or audio sources available depending on the received broadcast.

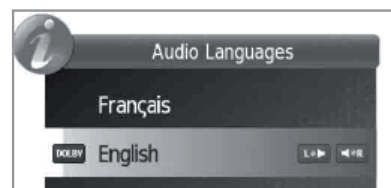

Press / to select the language and press **OK**.

NOTE

- The audio mode screen disappears in three seconds.
- Selectable items vary depending on the received broadcasts.

ATV mode:

Each time you press , the mode switches as shown in the following tables.

NICAM TV broadcasts selection	
Signal	Selectable items
Stereo	NICAM STEREO, MONO
Bilingual	NICAM CH A, NICAM CH B, NICAM CH AB, MONO
Monaural	NICAM MONO, MONO
A2 TV broadcasts selection	
Signal	Selectable items
Stereo	STEREO, MONO
Bilingual	CH A, CH B, CH AB
Monaural	MONO

NOTE

- When no signal is received, the audio mode will display “MONO”.

Switching subtitle languages

- DTV mode:** Press SUBTITLES  button to access “Subtitles Languages”.

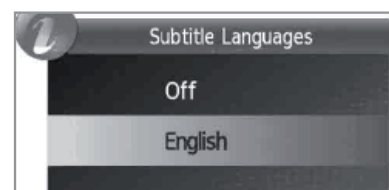

- ATV mode:** The available subtitles according to the broadcasting will be enabled or disabled by pressing the Subtitle key .

EPG

EPG is a programme list that is displayed on the screen. With the EPG, you can check the schedule of DTV, view detailed information about it, tune to an event currently on-air and set a timer for future events.

Selecting a programme using EPG

Basic Operation

The illustrations on this page are explained using three digit services.

● Display/Close the EPG screen

Press **EPG**.

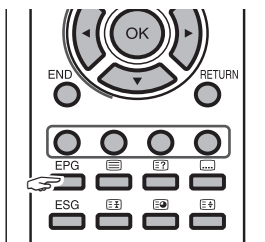

● Select a program

① Select the time span

Press **◀/▶** to select the time span you want to search, press **OK**.

- Continue to press **▶** to display programs in the next time span.

② Select the desired program

Press **▲/▼** to select the desired program, press **OK**.

- If **▲** or **▼** are displayed on the left of the programs, continue to press **▲/▼** to display next or previous screen.

Other EPG functions

③ Revise the program information

- 1 Press **▲/▼/◀/▶** to select the program you want to revise.
- 2 Press **i+**.

Program information



- 3 Press **i+** to return to EPG.

④ "Reminder" function

- 1 Select the broadcasting emitting the program which you want to remember.

- 2 Press the **BLUE** key on the remote control.



- 3 With **▲/▼/◀/▶** select Hour, Minute, Mode, Date and Month which you want the program to be remembered. Press **OK**.

- This program stays skipped in red within the programming guide.

⑤ "Schedule" function

- 1 Press the **YELLOW** key to visualize all programmed reminders.

Watching TV



- Press **▲/▼/◀/▶** to select a reminder and then press the **RED** key to delete it.

Teletext

What is Teletext?

Teletext broadcasts pages of information and entertainment to specially equipped TV. Your TV receives teletext signals broadcast by a TV network, and decodes them into graphical format for viewing. News, weather and sports information, stock exchange prices and programme previews are among the many services available.

Turning Teletext on/off

- Select a TV channel or external source providing a teletext programme.
- Press **⏏** to display the Teletext.
 - Many stations use the TOP operating system, while some use FLOF (e.g. CNN). Your TV supports both these systems. The pages are divided into topic groups and topics. After switching on the teletext, up to 1.000 pages are stored for fast access.
 - Each time you press **⏏**, the screen switches as shown below.
 - If you select a programme with no teletext signal, "No Teletext available" displays.
 - The same message displays during other modes if no teletext signal is available.

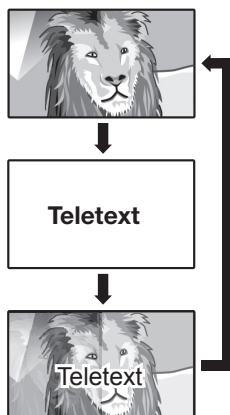

NOTE

- Teletext will not work if the selected signal type is RGB.

Buttons for teletext operations

Buttons	Description
P▲/▼	Increase or decrease the page number.
Colour (R/G/Y/B)	Select a group or block of pages displayed in the coloured brackets at the bottom of the screen by pressing the corresponding Colour (R/G/Y/B) on the remote control unit.
0-9	Directly select any page from 100 to 899 by using the 0-9 numeric buttons.
⏏ (Top/Bottom/Full)	Switch the teletext image to Top, Bottom or Full.
⏏ (Reveal hidden Teletext)	Reveal or hide hidden information such as an answer to a quiz.
⏏ (Freeze/Hold)	Stop updating teletext pages automatically or release the hold mode.
⏏ (Subtitle for Teletext)	Display the subtitle or exit the subtitle screen. <ul style="list-style-type: none"> Subtitles will not be displayed when the service does not contain subtitle information.
⏏ (Subpage)	TXT mode: Reveal or hide subpages. <ul style="list-style-type: none"> R button: Move to the previous subpage. G button: Move to the following subpage. These two buttons are shown on the screen by the symbols "+" and "-". TV mode: Display the time.

Using the MHEG-5 application (UK only)

Some services bring you programmes with the MHEG application encoded, letting you experience DTV interactively.

When provided, the MHEG-5 application will start when you press **⏏**.

Sample MHEG-5 screen



Connecting external devices

● Before connecting ...

- Be sure to turn off the TV and any devices before making any connections.
- Firmly connect a cable to a terminal or terminals.
- Carefully read the operation manual of each external device for possible connection types. This also helps you get the best possible audiovisual quality to maximise the potential of the TV and the connected device.

Introduction to connections

The TV is equipped with the terminals as shown below. Find the cable corresponding the TV's terminal and connect the device.

NOTE

- The cables illustrated in pages 13, 14 and 15 are commercially available items.

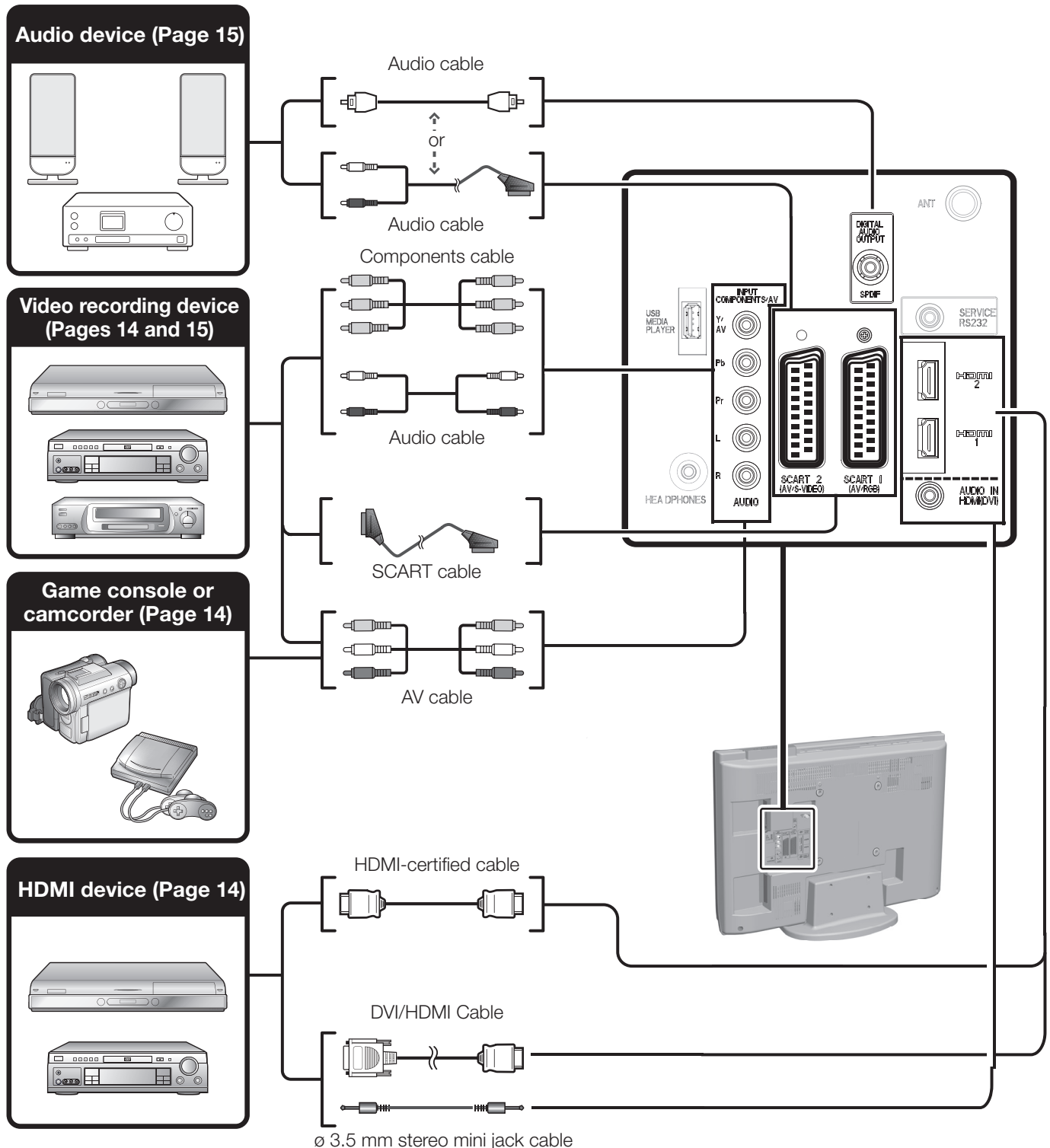

Connecting external devices

HDMI connection

Example of connectable devices

- DVD player/recorder
- Blu-ray player/recorder
- Game console

The HDMI connections permit digital video and audio transmission via a connection cable from a player/recorder. The digital picture and sound data are transmitted without data compression and therefore lose none of their quality. Analogue/digital conversion is no longer necessary in the connected devices, which also would result in quality losses.

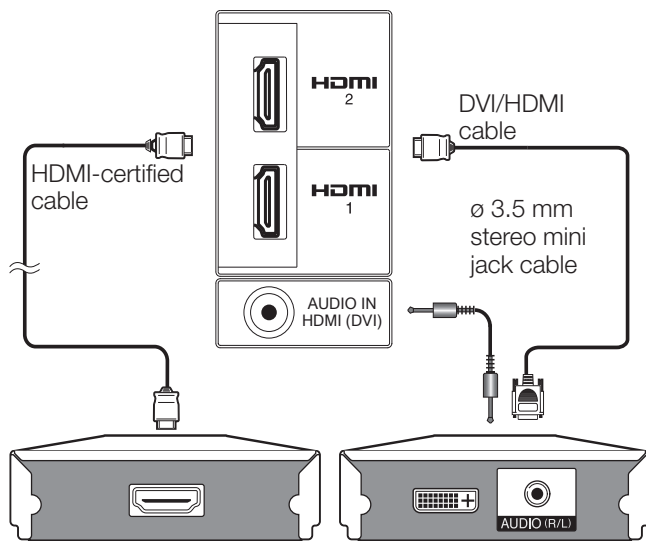

DVI/HDMI conversion

Using a cable DVI/HDMI, the digital signals of a DVD video, can be also reproduced through a compatible HDMI connection. The sound should be supplied additionally.

- On connecting a DVI/HDMI cable to the HDMI terminal, may be the picture does not become visualized clearly.
- Both HDMI and DVI use the same method of HDCP protection against copy.
- For connecting a DVI cable, a commercially available adaptor (not supplied) is necessary.

NOTE

- Depending on the type of HDMI cable used, it may appear a video noise. Be sure to use a certified HDMI cable.
- On reproducing HDMI picture, the best format is automatically detected and adjusted for the picture.

Compatible video signal

576i, 576p, 480i, 480p, 1080i, 720p, 1080p

Component connection

Example of connectable devices

- VCR
- DVD player/recorder
- Blu-ray player/recorder

You will enjoy accurate colour reproduction and high quality images through the INPUT COMPONENTS / AV terminal when connecting a DVD player/recorder or other device.

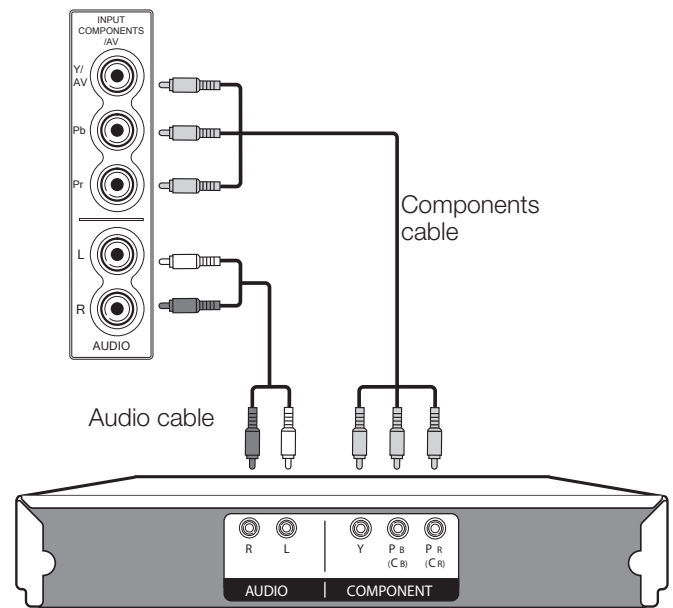

VIDEO connection

Example of connectable devices

- VCR
- DVD player/recorder
- Blu-ray player/recorder
- Game console
- Camcorder

You can use the COMPONENTS/AV terminal when connecting to a game console, camcorder, a DVD player / recorder or other device.

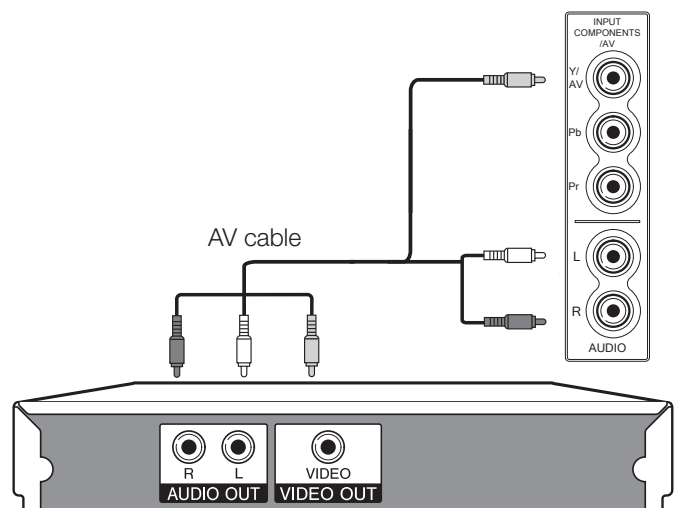

Connecting external devices

SCART connection

Example of connectable devices

- VCR
- Decoder (only SCART 1)
- DVD player/recorder

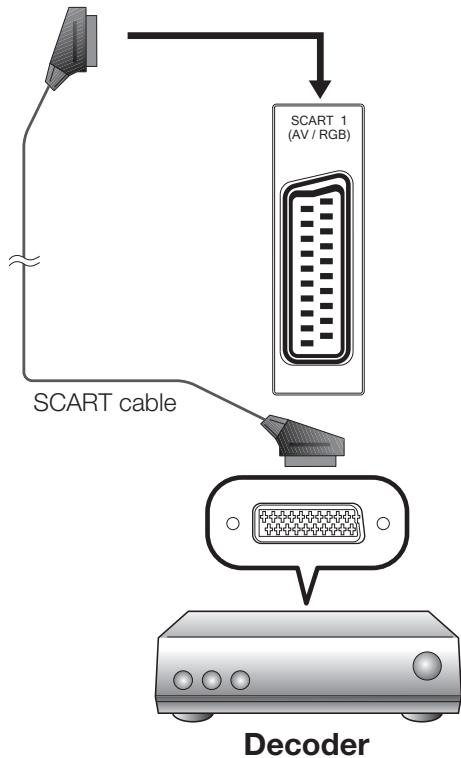

NOTE

- In cases when the decoder needs to receive a signal from the TV, make sure to select the appropriate input terminal to which the decoder is connected in "Input Source" (Page 10).

PC connection through HDMI (DVI)

HDMI (DVI) Connection

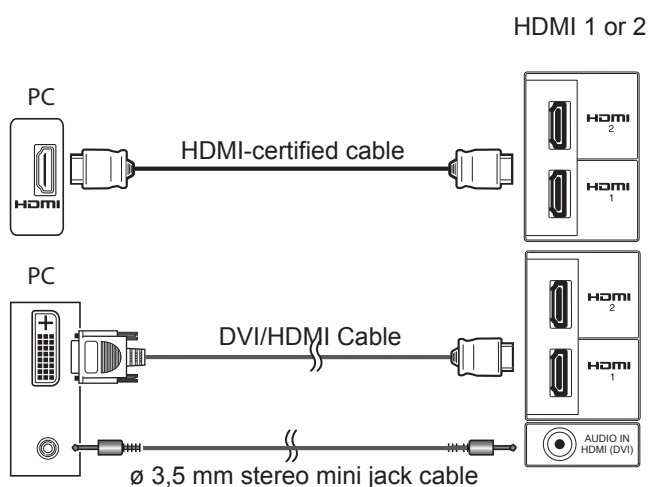

After connection

- If after connecting a PC to the TV through a HDMI cable, the audio does not run, connect a mini stereo connector of ø 3.5mm between TV and PC as indicated in the previous drawing.
- When a PC is connected to the TV with a DVI cable, it will be necessary to connect a mini stereo connector of ø 3.5mm of the TV to PC as indicated in the previous drawing

Speaker/amplifier connector

Example of connectable devices

- Connecting an amplifier with digital audio input

Connect an amplifier with external speakers as shown below.

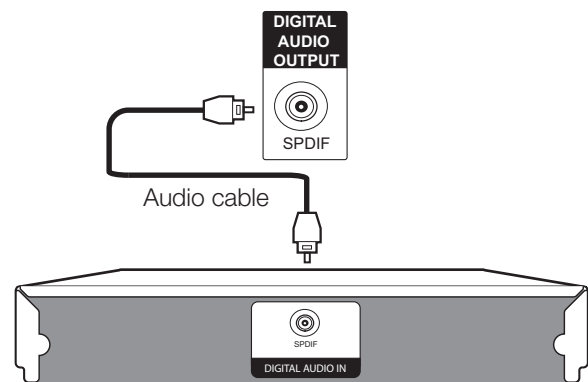

Amplifier with digital audio input

After connecting

Digital audio output setting

After connecting an amplifier with digital audio input and external speakers as shown, you should set an audio output format compatible with the programme you are watching or the device connected.

Go to "MENU" > "SOUND" > "SPDIF Mode" > select "PCM" or "Dolby Digital".

NOTE

- When you set this to "Dolby Digital", and you receive the Dolby Digital or Dolby Digital Plus audio formats, Dolby Digital audio is output. Otherwise, PCM audio is output. When you set this to "PCM", PCM audio is output no matter what audio formats you receive.

Menu operation

What is the menu?

- You need to call up the OSD to perform settings for the TV. The OSD for the settings is called menu.
- The menu enables various settings and adjustments.
- The menu can be operated with the remote control unit and with the TV panel control keys.

Common operations

1 Display the menu screen

Press MENU and the "PICTURE" screen displays.

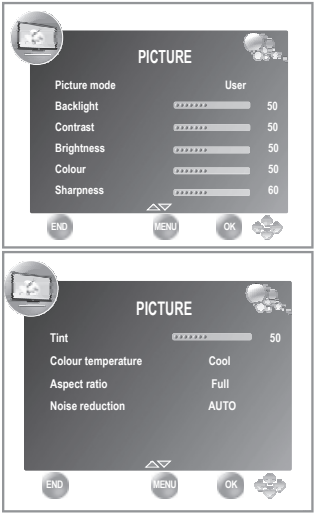

END MENU OK

2 Select an item

Press ▲/▼/◀/▶ to select/adjust the desired menu, and adjust the item to the desired level, and then press **OK**.

Press MENU to return to the previous page.

- **Selecting in the menu**

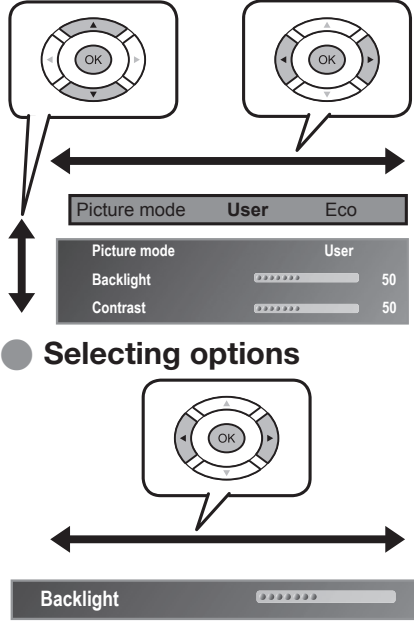

- **Selecting options**

3 Exit the menu screen

The operation will exit the menu screen if you press **END** before it is completed.

NOTE

- The menu options differ in the selected input modes, but the operating procedures are the same.
- The screens in the operation manual are for explanation purposes (some are enlarged, others cropped) and may vary slightly from the actual screens.
- Items in darker grey cannot be selected.

Operation without a remote control unit (with the TV panel control keys)

This function is useful when there is no remote control unit within your reach.

- 1 Press **MENU** and the "PICTURE" screen displays.
- 2 Press **P▲/▼** instead of ▲/▼ or **▶/◀** instead of ◀/▶ to select the item.
- 3 Press **→** to complete the setting.

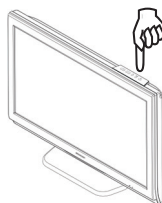

About the Guide Display

The Guide Display at the bottom of the screen shows operations with the OSD.



The bar above is an operational guide for the remote control unit. The bar will change in accordance with each menu setting screen.

NOTE

- The "PICTURE" screen will disappear if left unattended for several seconds.

Basic adjustment

Picture settings

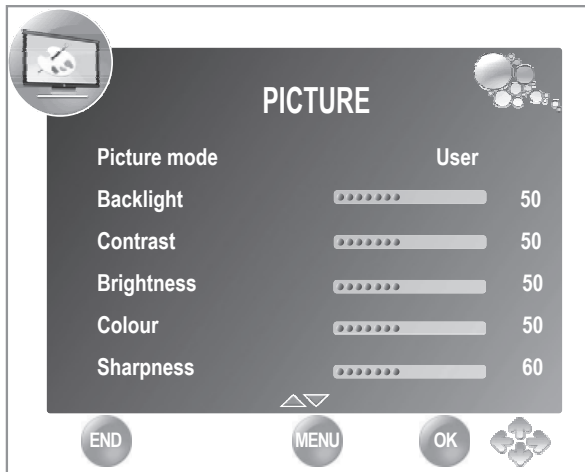

Picture adjustments

When the **Picture Mode** is set to “User”, the picture can be adjusted according to your preferences. See the following setting table.

Adjustments options

Selected setting	◀ Button	▶ Button
Backlight	The screen dims	The screen brightens
Contrast	Contrast goes down	Contrast goes up
Brightness	Brightness goes down	Brightness goes up
Colour	Colour intensity goes down	Colour intensity goes up
Sharpness	Soften details	Emphasize details
Tint	Skin tones become purplish	Skin tones become greenish
Colour Temperature	Reddish white	Bluish white
Aspect Ratio	Changes between different picture sizes	
Noise Reduction*	Improves picture quality (choose among different options)	

*This function may be not available in some types of input signal.

AV MODE

“**AV MODE**” gives you several viewing options to choose from to best match your system environment, which can vary due to factors like room-brightness, type of programme watched or the type of image input from external equipment.

- 1 Press **AV MODE**.
- 2 Every time **AV MODE** is pressed the TV changes the mode as follows:

STANDARD → SOFT → ECO → USER → DYNAMIC ↩

Audio settings

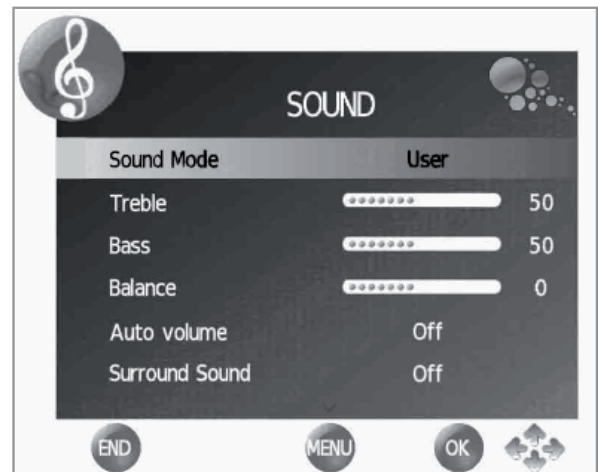

Sound adjustments

When the **Sound Mode** is set to “User”, the sound can be adjusted according to your preferences. See the following setting table.

Adjustments options

Selected setting	◀ Button	▶ Button
Treble	Reduce trebles	Increase trebles
Bass	Reduce bass	Increase bass
Balance	Increase audio from the left speaker	Increase audio from the right speaker
Auto Volume	Off	On
Surround Sound	Off	On
SPDIF Mode	(PCM) Activates digital audio output	Dolby Digital

- **Sound Mode**
Select your desired setting. The available options are:
STANDARD → MUSIC → MOVIE → SPORTS → USER ↩
- **Auto Volume**
Reduces sudden volume changes, for example, during commercials or when switching from one channel to another.
- **Surround Sound**
This function allows you to enjoy surround sound.
- **SPDIF Mode**
Digital audio output.

Basic adjustment

Channel settings



Channel adjustments

Allows to reconfigure the channels after initial auto installation has been completed.

Install channels

- **Auto Tuning**
This function allows you to select the country and automatically adjusts the channels for digital and analogue individually.
- **DTV Manual Tuning**
Allows you to tune digital channels manually.
- **ATV Manual Tuning**
Allows you to tune in analogue channels manually.
- **Programme Edit**
Allows you to delete channels, to skip channels and to set up a favourite channels list.
Select the channel you want to reorganize and press the **RED** button to delete it, the **BLUE** button to skip it (to ignore it), **YELLOW** button to move it, ESG to mark it as favourite or **GREEN** button to rename it (only in ATV mode.)

NOTE

If you press **ESG** when you are not in any adjustment menu, the favourite channel list will appear.

- **Signal Information**
Show the signal power and quality.
- **CI Information**

Allows to see the CA card information (Conditional Access Module): name, supplier and OSD.

Time settings



This adjustment allows you to set or to display the following functions: Clock, Off / On Timer and Sleep Timer.

Time adjustments

- **Clock**
This function allows you to display the clock information (day / month / hour/ minute). The time and the date can't be modified in this option.
- **Off Timer**
Allows you to set a time when the TV automatically enters in standby mode.
- **On Timer**
Allows you to set the time when the TV must switch on.
- **Sleep Timer**
Allows you to setup the automatic Switch Off for: 10min., 20min., 30min., 60min., 90min., 120min., 180min. and 240 min..

NOTE

- Select "Off" to cancel the sleep timer.
- When the time has been set, countdown starts automatically.
- The last minute is displayed second to second.
- **No Operation Off**
Switches the TV off when no key is pressed for 3 hours.
- **No Signal Off**
When this function is activated the TV automatically enter standby mode if there is no signal input during 10 minutes.
- **Time Zone**
Allows you to setup the time zone.
- **Summer time**
Allows you to change automatically to summer time (auto, off, on.)

Option settings

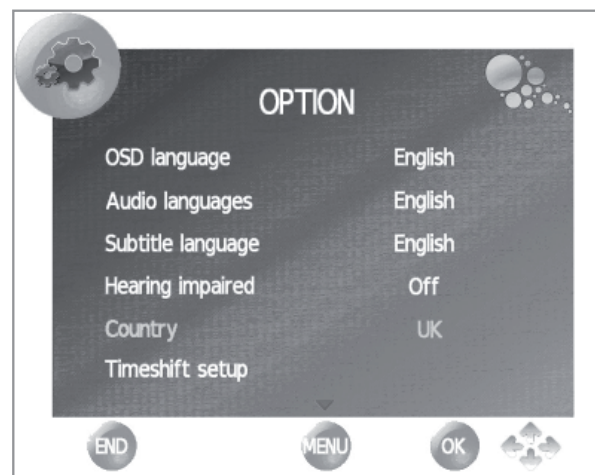

Basic adjustment

Options Options menu

- **OSD Language**
Allows you to select the screens language.
- **Audio Languages**
Allows you to select the audio language.
- **Subtitle Language**
Allows you to select the subtitles language.
- **Hearing Impaired**
This function allows you to activate or deactivate the subtitles for the hearing impaired. These subtitles have priority.

NOTE

Subtitles will not be displayed when the service does not contain subtitle information.

- **Timeshift setup (only DH510 models)**
Allows select modes, disk, disk setup and speed test for Timeshift function.
See the operation on page 24.
- **Restore factory default**
Recover the configuration that the TV had when it left the factory.
- **Software Update (USB)**
This option allows you to have the TV software version always updated.

- 1 Add the binary file to USB memory root.
- 2 Insert the memory in the TV USB socket.
- 3 Press **MENU** on the remote control unit and select **OPTION**.

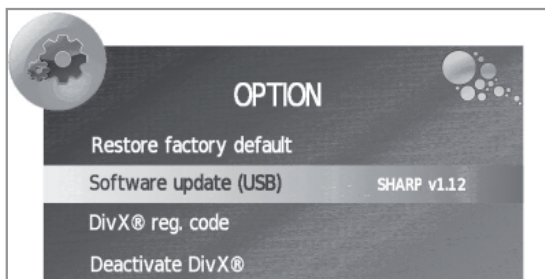

- 4 Press **▼** until Software Update (USB) option appears.
 - Press **OK**. **Are you sure?** message is displayed.
 - Select Yes with **◀/▶** and press **OK**. The software update will start.
 - The updated percentage appears. The TV will restart automatically when the process arrives at 100%.

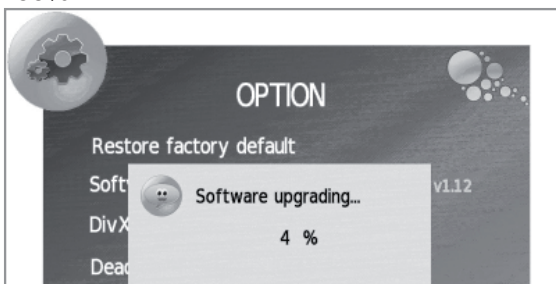

- 5 Return to **OPTION** menu to check that the version has been updated successfully.

- **DivX® registration code (VOD)**

This TV allows play video on demand (DivX® VOD). To activate this option you need to register the TV at www.divx.com/vod, download the VOD log file and reproduce it in TV.

- **Deactivation code DivX® (VOD)**

Displays the deactivation code necessary to write off this TV at www.divx.com/vod.

Lock settings

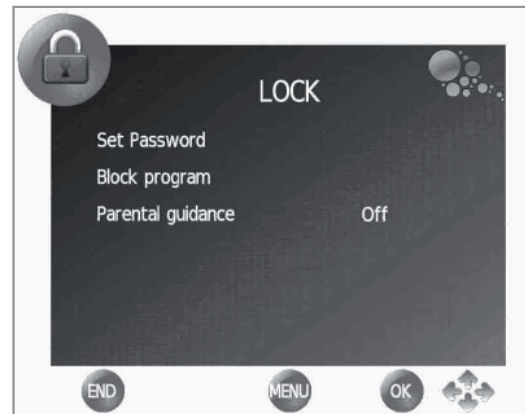

Lock Lock programs

This function allows you to use a password to lock certain programs and adjustments.

The password is always needed to access to this menu (by default, the password is 1234.)

- **Set password**
Allows you to change the password. Press **OK**, enter the new password and confirm.
- **Block program**
The password is needed before locking one program.
 - 1 Select the program or programs you want to lock and press **GREEN** button. A padlock appears next to the locked channel in the channel list.
 - 2 Press **End** to exit.

This option enters your selection in a locked channels list.

NOTE

- To prevent the channel search, when one program is locked, the channel menu is locked too.
- To view a locked channel, you must enter the password. When you select a locked channel a password prompt message pops up.
- You must repeat the previous steps to unlock one locked program.

- **Parental Guidance**

This function allows you to restrict DTV programs depending on the age classification. The information about classification is provided by the broadcasting station.

Useful viewing functions

Channel list

Selecting the channel you want to watch

- 1 Press **OK** and the list of tuned channels will be displayed.
- 2 Use **▲/▼** to select the channel you want to watch and press **OK**.



Channel information display (DTV only)

You can display the channel information that you are watching at this moment by pressing (i+) on the remote control unit.

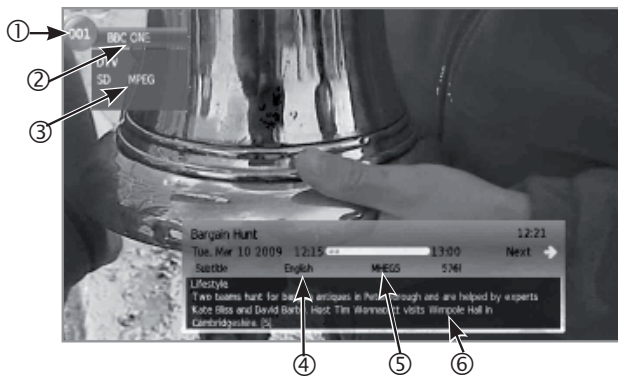

Information that appears on the screen:

- ① **Program number**
- ② **Program name**
- ③ **Channel information**
- ④ **Language**
- ⑤ **Teletext**
- ⑥ **Information about the program which is being broadcast**

CLEARING THE PIN

If you lose or forget your PIN, you can clear the PIN following these steps:

- 1 Go to «MENU»→«LOCK»→«PASSWORD».
- 2 Enter "3001" to cancel out the current PIN.
The current PIN is reset to "1234".

Selecting the picture format

Selecting the picture format manually

You can select the picture format. The selected picture format varies depending on the type of signal received.

- 1 Press (P) on the remote control unit to change between different kinds of pictures.

Sizes for SD Signal (Standard Definition)

Normal 4:3 : Keeps the original aspect ratio in a full screen display.

Zoom 14:9 : For 14:9 letterbox pictures. A thin side bar appears on each side, and you may also see bars on the top and bottom with some programs.

Panorama: In this mode, picture is stretched toward each side of the screen. The picture may appear similar to "Full" depending on broadcast signals.

Full: For 16:9 squeeze pictures.

Cinema 16:9: For 16:9 letterbox pictures. Bars may appear on the top and bottom with some programs.

Cinema 14:9: For 14:9 letterbox pictures. Bars may appear on the top and bottom with some programs.

Auto: The TV selects the picture size automatically.

Sizes for HD Signal (High Definition) HDMI

Full: Overscan image. Cuts out all sides of the picture.

Underscan: Displays a high definition picture adjusted perfectly. Picture noise may appear on the sides of picture with some programs.

Auto: this mode allows the TV to change between different picture sizes automatically.

NOTE

Some items do not appear depending on the type of received signal.

Other useful features

Setting when using external devices

Input source settings



For selecting the input type of external equipment

SCART 1: CVBS, RGB

SCART 2: Y/C, CVBS

- If no (colour) image is displayed, try changing to another signal type.
- Check the operations manual of the external equipment for the signal type.

Connecting a USB device (Media Player)

Connect an USB device to the TV as shown below.

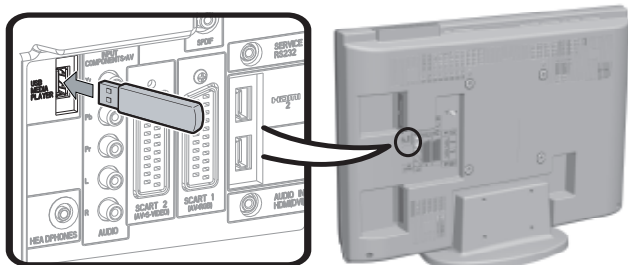

- Depending on the USB device, the TV may not be able to recognise the contained data.
- Use only alphanumeric characters for naming files.
- File names over 80 characters (may vary depending on character set) may not be displayed.
- Do not disconnect a USB device or memory card from the TV while transferring files, using the slide show function, when a screen is switching to another or before you exit "MEDIA PLAYER" from the "INPUT SOURCE" menu.
- Compatibility with USB hard disc connection.
- Do not connect and disconnect a USB device from the TV repeatedly.

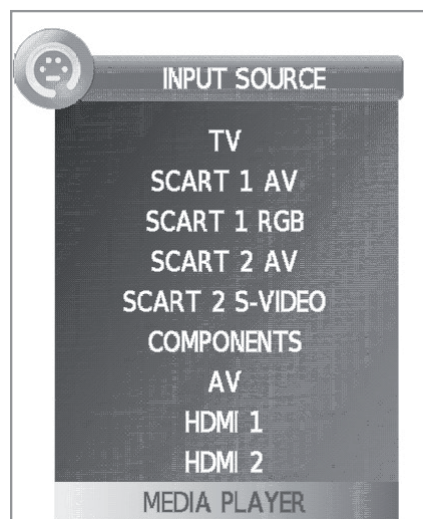

MEDIA PLAYER function

After selecting Media Player, the TV loads USB device files, and shows the following screen:



1 Pressing ◀/▶ buttons you can change between different modes: **PHOTO**, **MUSIC**, **MOVIE** or **TEXT**. Press **OK** to select the option you want to reproduce.

2 Press ▲/▼/◀/▶ to select the folder where you want to search the files and then press **OK**.

PHOTO mode

You can reproduce photos with JPG, JPEG and BMP format on your TV.

Several kinds of reproduction are possible.

- 1** Select **PHOTO** mode and press **OK**.
- 2** Select the file you want to display on full screen with ▲/▼/◀/▶ buttons and press **OK** to start the viewing.

Other useful features

Viewing photos on full screen

Buttons for full screen display operation

Buttons	Description
▲/▼ (Cursor)	Go to the previous/next photo in the same directory..
◀/▶ (Cursor)	Select / unselect the photos you want to see.
END button	Go back to the previous screen.
Ⓜ button	Zoom: ▲/▼/◀/▶ allow to move through the pictures when zoom is activated.
↻ button	Rotates 90° the photo on screen.

MUSIC mode

Reproduces MP3 music files.

- 1 Select **MUSIC** mode and press **OK**.
- 2 Select the files you want to reproduce with ▲/▼/◀/▶ buttons and press **OK** to start the reproduction.
- 3 Press **OK** to stop the reproduction of MP3 files and press **END** to exit the **MUSIC** mode.
 - You can stop/restart the reproduction pressing **OK**.

Buttons for music reproduction

Buttons	Description
▲/▼ (Cursor)	Go to the previous/next track in the same directory.
◀/▶ (Cursor)	<ul style="list-style-type: none"> •Mark with X the tracks you want to play (on MUSIC MENU) •Backward / Fast forward (on reproduction mode)
END button	Go back to the previous screen.
RED button	Options: <ul style="list-style-type: none"> Ⓚ Reproduce the selected files indefinitely. Ⓛ Reproduce the folder files only once. When the reproduction has finished, go back to the previous screen. Ⓜ Reproduce all the files on the folder indefinitely.

MOVIE mode

Reproduces films and videos.

- 1 Select **MOVIE** mode and press **OK**.
- 2 Select the files you want to reproduce with ▲/▼/◀/▶ buttons and press **OK** to start the reproduction.
 - If there is only one file, the reproduction will start automatically when this file is selected.
- 3 Press **OK** to stop / restart the reproduction.
- 4 Press **END** to exit the **MOVIE** mode.

Buttons for film reproduction

Buttons	Description
▲/▼ (Cursor)	Go to the previous/next file in the same directory (on MOVIE MENU)
◀/▶ (Cursor)	<ul style="list-style-type: none"> • Mark with X the files you want to play. • Backward / Fast forward (on reproduction mode)
END button	Go back to the previous screen.
RED button	-Movie Menu options: <ul style="list-style-type: none"> Ⓚ Only reproduces the selected file. Ⓛ Reproduce the folder files only once. When the reproduction has finished, go back to the previous screen. Ⓜ Reproduce the folder files indefinitely. -On reproduction mode: <ul style="list-style-type: none"> Ⓜ Allows you to repeat a fragment of a film indefinitely. The first keystroke defines A (initial point), the second keystroke defines B (final point). The third keystroke restarts the normal reproduction.
BLUE button Ⓚ	Allows you to backward or forward until a point in the movie. Introduce "hh:mm:ss" and press OK .

TEXT mode

Displays text files.

- 1 Select **TEXT** mode and press **OK**.
- 2 Select the file you want to display with ▲/▼/◀/▶ buttons and press **OK**. The selected file will appear on full screen.
- 3 You can move up and down in the file with ▲/▼/◀/▶ buttons.
- 4 You can display the previous or next text file with ◀/▶ buttons.
- 5 Press **END** to exit the **TEXT** mode.

Other useful features

USB device compatibility

USB 2.0 device	USB Memory, USB card reader, HDD (Mass Storage class)
File system	FAT / FAT32 / NTFS
Photo file format	JPEG (*.JPE, *.JPG), BMP, PNG
Music file format	MPEG1 (*.MP3), AAC / HE AAC (*.AAC, *.M4A), PCM (*.WAV) Bitrate: 32k, 40k, 48k, 56k, 64k, 80k, 96k, 112k, 128k, 160k, 192k, 224k, 256k, 320kbps Sampling frequency: 32k, 44.1k, 48kHz
Video file format	MPEG1/2 (*.MPG, *.MPE, *.MPEG, *.VOB, *.DAT, *.TS, *.TRP), MPEG4 (*.AVI, *.MOV, *.MP4, *.MKV), H.264 (*.AVI, *.TS, *.TRP, *.MOV, *.MP4, *.MKV), DivX® (*.DIVX, *.AVI, *.MP4), XviD (*.AVI, *.MKV)
Text file format	TXT (*.TXT, *.SRT, *.SSA)

NOTE

- Progressive format jpeg files are not supported.
- Music files in USB 1.1 devices may not be played properly.
- Operation using USB hubs is not guaranteed.
- The external hard disc with capacity exceeding 1TB cannot be detected correctly.
- Cables used to prolong the USB device must be certified as USB 2.0.
- In USB devices, video files may not be played properly if speed is not enough.
- Play non-standard encoded files is not guaranteed.

Power save settings

This function enables you to automatically reduce the backlight brightness in order to decrease the power consumption and increase the backlight life span.

In menu **PICTURE** → **Picture Mode** select the **ECO** setting.

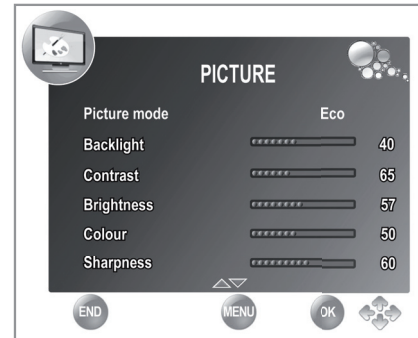

Abbreviation list

Abbreviated term	Stands for
ATV	Analogue TV
CEC	Consumer Electronics Control
DNR	Digital Noise Reduction
DTV	Digital TV
DVB-T	Digital Video Broadcasting-Terrestrial
DVI	Digital Visual Interface
EPG	Electronic Pogramme Guide
HDCP	High-bandwidth Digital Content Protection
HDMI	High-Definition Multimedia Interface
MHEG	Multimedia and Hypermedia Expert Group
OSD	On Screen Display
PCM	Pulse Code Modulation
USB	Universal Serial Bus
WSS	Wide Screen Signalling
DivX®	Digital Video Express

Timeshift function (only DH510 models)

Timeshift function allows you to record the current digital TV programme and watch it later. Timeshift requires an external USB 2.0 memory, always connected and previously configured to record the information.

The USB 2.0 memory must be formatted before first use for Timeshift function.



● Start mode

Change between **Manual** and **Always** mode.

Manual: The recording starts when user decides.

Always: The recording starts automatically each time that a digital programme is selected (DTV.)

To confirm the change of mode is necessary press **END** button to exit of this menu, and then enter again in the “**Timeshift setup**” menu.

● Select disk

Only available in case that there are more than one partition in the external USB memory (Choose between C:, D:, etc.).

● Disk setup

You can choose the size of USB device which will be used for Timeshift function, in 1GByte fractions. The USB device will be formatted.

ATTENTION:

- All the data in this device will be lost.
- In case that you have a USB device with partitions, all the data in the selected partition will be lost.

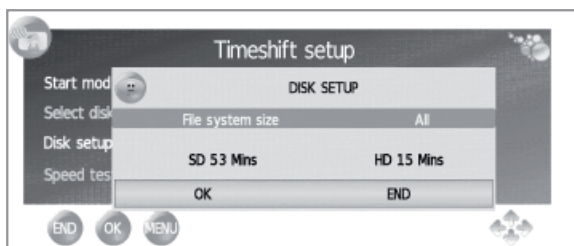

● Speed test

Allows to see the compatibility grade between USB memory and the TV set.

NOTES:

- The file system of USB device must be FAT/FAT32. If the device has other system, the TV set does not recognize it.
- The minimum USB 2.0 memory size to use with Timeshift function is 1GByte.
- As a concept, Timeshift can record up to 26 minutes on SD DTV broadcasts and 7 minutes on HD DTV broadcasts, for every GByte.

Timeshift operation

● Manual mode

The recording starts when user decides.

1. Press **⏸** to start recording the current programme. The picture remains frozen and the TV set shows **||** symbol on screen.
2. Press **⏸** to resume the recorded broadcast. The TV set continues recording the broadcast while you are watching the recorded programme. The TV set shows **▶** symbol on screen.
3. Press **▶** key to fast forward. By pressing **▶** key repeatedly, allows you to select the fast forward speed. Press **⏸** to restore the normal speed.
4. Press **◀** key to rewind. By pressing **◀** key repeatedly, allows you to select the rewind speed. Press **⏸** to restore the normal speed.
5. To cancel Timeshift mode press “**END**”, change TV programme or input source, or switch-off the TV set.

While **Timeshift** is activated, **▶** or **||** symbols, or the recording progress bar may be displayed.

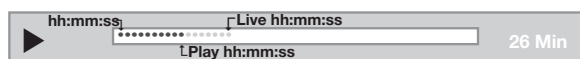

The bar shows Start, Play and Live markers, and the maximum recording time.

● Always mode

The recording starts automatically each time that a digital TV programme is selected.

1. Press **◀** to rewind until the desired point.
2. Press **⏸** to resume or pause the recorded broadcast. This action does not interrupt the real time TV programme recording.
3. Press “**END**” to return to real time broadcast, without losing any data. The recording process will continue activated.
4. By changing the TV programme the Timeshift function will be reset (all the previous data will be lost), and will return to real time broadcast. The recording process will continue activated.





In this mode, after the user selects any of the Timeshift available functions (fast forward, rewind, play, pause, etc...), the “**▶**” or “**||**” symbols, or the recording progress bar can be displayed.

NOTES:

- The Timeshift function does not work for ATV channels or external inputs.
- With Timeshift activated only will be available video, audio and subtitles services.
- If during Timeshift the maximum capacity of USB is exceeded, the oldest data will be lost.
- It can appear displaying troubles during rewind or fast forward modes, depending on the USB memory characteristics.
- Timeshift has not been created as a real recording method, so the recorded data will be deleted each time you cancel it, change programme or input source, or switch off the TV. The recorded data will never be available for any external device.
- During timeshift mode, **Ⓢ**, “**EPG**” and **☰** show live broadcast information, not recorded one.
- Keeping “**ALWAYS**” mode as a permanent option may shorten the life of the external USB memory.
- Programmes which require a PIN to watch them cannot be recorded with Timeshift function until you enter the PIN.

Appendix

Troubleshooting

Problem	Possible Solution
<ul style="list-style-type: none"> No power. 	<ul style="list-style-type: none"> Check if you pressed  on the remote control unit. If the indicator on the TV lights up red, press . Is the AC cord disconnected? Check if you pressed  on the TV.
<ul style="list-style-type: none"> The TV cannot be operated. 	<ul style="list-style-type: none"> External influences such as lightning, static electricity, etc., may cause improper operation. In this case, operate the TV after first turning off the power, or unplugging the AC cord and re-plugging it in after one or two minutes.
<ul style="list-style-type: none"> Remote control unit does not operate. 	<ul style="list-style-type: none"> Are batteries inserted with polarity (+, -) aligned? Are batteries worn out? (Replace with new batteries.) Are you using it under strong or fluorescent lighting? Is a fluorescent light illuminating to the remote control sensor?
<ul style="list-style-type: none"> Picture is cut off. 	<ul style="list-style-type: none"> Is the image position correct? Are screen mode adjustments (Aspect ratio) such as picture size made correctly? (Page 20.)
<ul style="list-style-type: none"> Strange colour, light colour, or dark colour, or colour misalignment. 	<ul style="list-style-type: none"> Adjust the picture tone. Is the room too bright? The picture may look dark in a room that is too bright. Check the "PICTURE" setting (Page 17).
<ul style="list-style-type: none"> Power is suddenly turned off. 	<ul style="list-style-type: none"> The TV's internal temperature has increased. Remove any objects blocking the vent or clean. Is the "Sleep Timer" set? Select "Off" from the "TIME" menu (Page 18). Is "No Signal Off" or "No operation Off" activated?
<ul style="list-style-type: none"> No picture. 	<ul style="list-style-type: none"> Are connections to external equipment correct? (Pages 13, 14 and 15) Is the input signal type selected correctly after connection? (Page 10) Is the correct input source selected? (Page 10) Is the picture adjustment correct? (Pages 17) Is the antenna connected properly? (Page 8)
<ul style="list-style-type: none"> No sound. 	<ul style="list-style-type: none"> Is the volume too low? Make sure that headphones are not connected. Check if you pressed  on the remote control unit.
<ul style="list-style-type: none"> The TV sometimes makes a cracking sound. 	<ul style="list-style-type: none"> This is not a malfunction. This happens when the cabinet slightly expands and contracts according to changes in temperature. This does not affect the TV's performance.

Cautions regarding use in high and low temperature environments

- When the TV is used in a low temperature space (e.g. room, office), the picture may leave trails or appear slightly delayed. This is not a malfunction, and the TV will recover when the temperature returns to normal.
- Do not leave the TV in a hot or cold location. Also, do not leave the TV in a location exposed to direct sunlight or near a heater, as this may cause the cabinet to deform and the LCD panel to malfunction.
Storage temperature: -20 °C to +60 °C.

Information on the software license for this product

Software composition

The software included in this product is comprised of various software components whose individual copyrights are held by SHARP or by third parties.

Software developed by SHARP and/or third part

The copyrights for the software components and various relevant documents included with this product that were developed or written by SHARP are owned by SHARP and are protected by the Copyright Act, international treaties, and other relevant laws. This product also makes use of freely distributed software and software components whose copyrights are held by third parties.

Fixing the TV on a wall

- This TV should be fixed on a wall only with the wall fix bracket available from SHARP (Page 5). The use of other wall fix brackets may result in an unstable installation and may cause serious injuries.**
- Fixing the LCD colour TV requires special skills and should only be performed by qualified service personnel. Customers should not attempt to do the work themselves. SHARP bears no responsibility for improper fixing or fixing that results in accident or injury.**
- You can ask qualified service personnel about using an optional bracket to fix the TV on a wall.
- To use this TV fixed on a wall, first remove the adhesive tape at the two locations on the rear of the TV, and then use the screws supplied with the wall fix bracket to secure the bracket to the rear of the TV.
- When you fix the TV on a wall, you should attach the supporting post.

Appendix

Specifications

Item		32" LCD COLOUR TV, Model: LC-32DH500E, LC-32DH500S, LC-32DH510E, LC-32DH510S	
LCD Panel		32" Advanced Super View & BLACK TFT LCD	
Resolution		1,049,680 pixels (1,366 x 768)	
Video Colour System		PAL/SECAM/NTSC 3.58/NTSC 4.43/PAL 60	
TV Functions	TV Standard	Analogue	CCIR (B/G, I, D/K, L/L')
		Digital	DVB-T (2K/8K OFDM)(H.264)
	Receiving Channel	VHF/UHF	E2–E69 ch, F2–F10 ch, I21–I69 ch, IR A–IR J ch (Digital: IR A ch–E69 ch)
		CATV	Hyper-band, S1–S41 ch
	TV-Tuning System	Auto Preset 999 ch: non-Nordic / 9999 ch: Nordic (ATV: 99 ch), Auto Label, Auto Sort	
STEREO / BILINGUAL		NICAM/A2	
Brightness		500 cd/m ²	
Backlight life		60,000 hours (when "Backlight" is set the STANDARD, the default position)	
Viewing angles		H: 176°, V: 176°	
Audio Amplifier		10 W x 2	
Speaker		(35 mm x 100 mm) x 2	
Terminals	TV Antenna	UHF/VHF 75 Ω Din type (Analogue & Digital)	
	SERVICE	Ø 3.5 mm jack	
	SCART1	SCART (AV input, RGB input, TV output)	
	SCART2	SCART (AV input/ monitor output, Y/C input)	
	COMPONENTS	COMPONENT IN: Y/PB(CB)/PR(CR), RCA pin (AUDIO R/L)	
	HDMI1	HDMI, Ø 3.5mm jack	
	HDMI2	HDMI, Ø 3.5mm jack	
	AV	RCA connector (AV input)	
	MEDIA PLAYER	USB 2.0 HOST (A type)	
	DIGITAL AUDIO OUTPUT	S/PDIF digital audio output.	
	C. I. (Interface Common)	EN50221, R206001	
Headphones	Ø 3.5 mm jack (Audio output)		
OSD language		Czech, Danish, Dutch, English, Estonian, Finnish, French, German, Greek, Hungarian, Italian, Latvian, Lithuanian, Norwegian, Polish, Portuguese, Russian, Slovak, Slovene, Spanish, Swedish, Turkish, Ukrainian	
Power Requirement		AC 220–240 V, 50 Hz	
Power Consumption (IEC62087 Method)		104W (0.20 W Standby)	
Weight		9,4 Kg (Without stand), 11,1 Kg (With stand)	
Operating Temperature		0 °C to +40 °C	

Environmental Specifications

*1 On-Mode (W) (HOME MODE)		81 W
*2 Energy-Save-Mode (W)	ECO	65 W
*3 Standby-Mode (W)		0.20 W
*4 Off Mode (W)		0.17 W
*5 Annual Energy Consumption (kWh)		119kWh
*6 Annual Energy Consumption Energy-Save-Mode (kWh)	ECO	95kWh

*1 Measured according to IEC 62087 Ed. 2.

*2 For further information about the Energy Save function, please see related pages in this operation manual.

*3 Measured according to IEC 62301 Ed. 1.

*4 Measured according to IEC 62301 Ed. 1.

*5 Annual energy consumption is calculated on the basis of the On-Mode (HOME MODE) power consumption, watching TV 4 hours a day, 365 days a year.

*6 Annual energy consumption is calculated on the basis of the Energy-Save-Mode power consumption, watching TV 4 hours a day, 365 days a year.

NOTE

- The power consumption of On-Mode varies depending on the images the TV displays.

Information on the EU Eco-label



Sharp LCD-TV with an EU Eco-label

This product has officially been awarded the Eco-label of the European Union, "The Flower" (for details see EU Commission Decision 2009/300/EC - OJ L 82/3 dated 28.3.2009).

Sharp is the first company to achieve this Eco-label for TVs thus demonstrating its commitment to improving our environment.

The Flower is granted only to the products that meet rigorous criteria and demonstrate positive contributions towards a better environment. Further information can be found at:

<http://www.ecolabel.eu>

What makes this Sharp product ecologically outstanding?

This TV set uses a Liquid Crystal Display (LCD) instead of the classical Cathode Ray Tube (CRT). Some of the advantages are:

- Design for high energy efficiency. This cuts energy consumption and saves money.
- Reduced energy consumption during use and stand-by. Energy savings in different modes are possible (see Appendix in this operation manual.)
- The lifetime of the background light is approx. 2.5 times longer than that of a CRT.
- This TV complies with the chemical requirements of the EU Eco-label.
- A minimum of two year functionality are granted in all EU-states.
- Spare parts will be available after ceasing the production of this model for:
 - seven years, for electrical components
 - five years, for mechanical parts
 - four years, for decorative parts
- This product has been designed for easy disassembly, recovery and recycling and should not be discarded with your ordinary household waste – for further details please refer to the "Information on Proper Disposal" mentioned in this operation manual.
- Should repair become necessary, please contact your retailer. You can also contact your local Sharp approved service centre (see Sharp local website).

What can you do to contribute towards helping to protect the environment?

- Please do not leave your TV in stand-by mode, unplug it when it is not used for a long time. There is zero energy consumption if you unplug your TV or nearly zero watt if the TV has a hard-off-switch. The location is described in this operation manual.
- The energy consumption in the on-mode can be reduced by lowering the brightness of the backlight when the unit is in operation. This will reduce overall running costs.

July 2009

End of life disposal



Attention: Your product is marked with this symbol. It means that used electrical and electronic products should not be mixed with general household waste. There is a separate collection system for these products.

A. Information on Disposal for Users (private households)

1. In the European Union

Attention: If you want to dispose of this equipment, please do not use the ordinary dust bin!

Used electrical and electronic equipment must be treated separately and in accordance with legislation that requires proper treatment, recovery and recycling of used electrical and electronic equipment.

Following the implementation by member states, private households within the EU states may return their used electrical and electronic equipment to designated collection facilities free of charge*. In some countries* your local retailer may also take back your old product free of charge if you purchase a similar new one.

*) Please contact your local authority for further details.

If your used electrical or electronic equipment has batteries or accumulators, please dispose of these separately beforehand according to local requirements.

By disposing of this product correctly you will help ensure that the waste undergoes the necessary treatment, recovery and recycling and thus prevent potential negative effects on the environment and human health which could otherwise arise due to inappropriate waste handling.

2. In other Countries outside the EU

If you wish to discard this product, please contact your local authorities and ask for the correct method of disposal.

For Switzerland: Used electrical or electronic equipment can be returned free of charge to the dealer, even if you don't purchase a new product. Further collection facilities are listed on the homepage of www.swico.ch or www.sens.ch.

B. Information on Disposal for Business Users

1. In the European Union

If the product is used for business purposes and you want to discard it:

Please contact your SHARP dealer who will inform you about the take-back of the product. You might be charged for the costs arising from take-back and recycling. Small products (and small amounts) might be taken back by your local collection facilities.

For Spain: Please contact the established collection system or your local authority for take-back of your used products.

2. In other Countries outside the EU

If you wish to discard of this product, please contact your local authorities and ask for the correct method of disposal.



Pb

The battery supplied with this product contains traces of Lead.

For EU: The crossed-out wheeled bin implies that used batteries should not be put to the general household waste! There is a separate collection system for used batteries, to allow proper treatment and recycling in accordance with legislation. Please contact your local authority for details on the collection and recycling schemes.

For Switzerland: The used battery is to be returned to the selling point.

For other non-EU countries: Please contact your local authority for correct method of disposal of the used battery.

Free Manuals Download Website

<http://myh66.com>

<http://usermanuals.us>

<http://www.somanuals.com>

<http://www.4manuals.cc>

<http://www.manual-lib.com>

<http://www.404manual.com>

<http://www.luxmanual.com>

<http://aubethermostatmanual.com>

Golf course search by state

<http://golfingnear.com>

Email search by domain

<http://emailbydomain.com>

Auto manuals search

<http://auto.somanuals.com>

TV manuals search

<http://tv.somanuals.com>