

SHARP®

ELECTRONIC PRINTING CALCULATOR

MODEL
CS-2800
CS-2850

OPERATION MANUAL

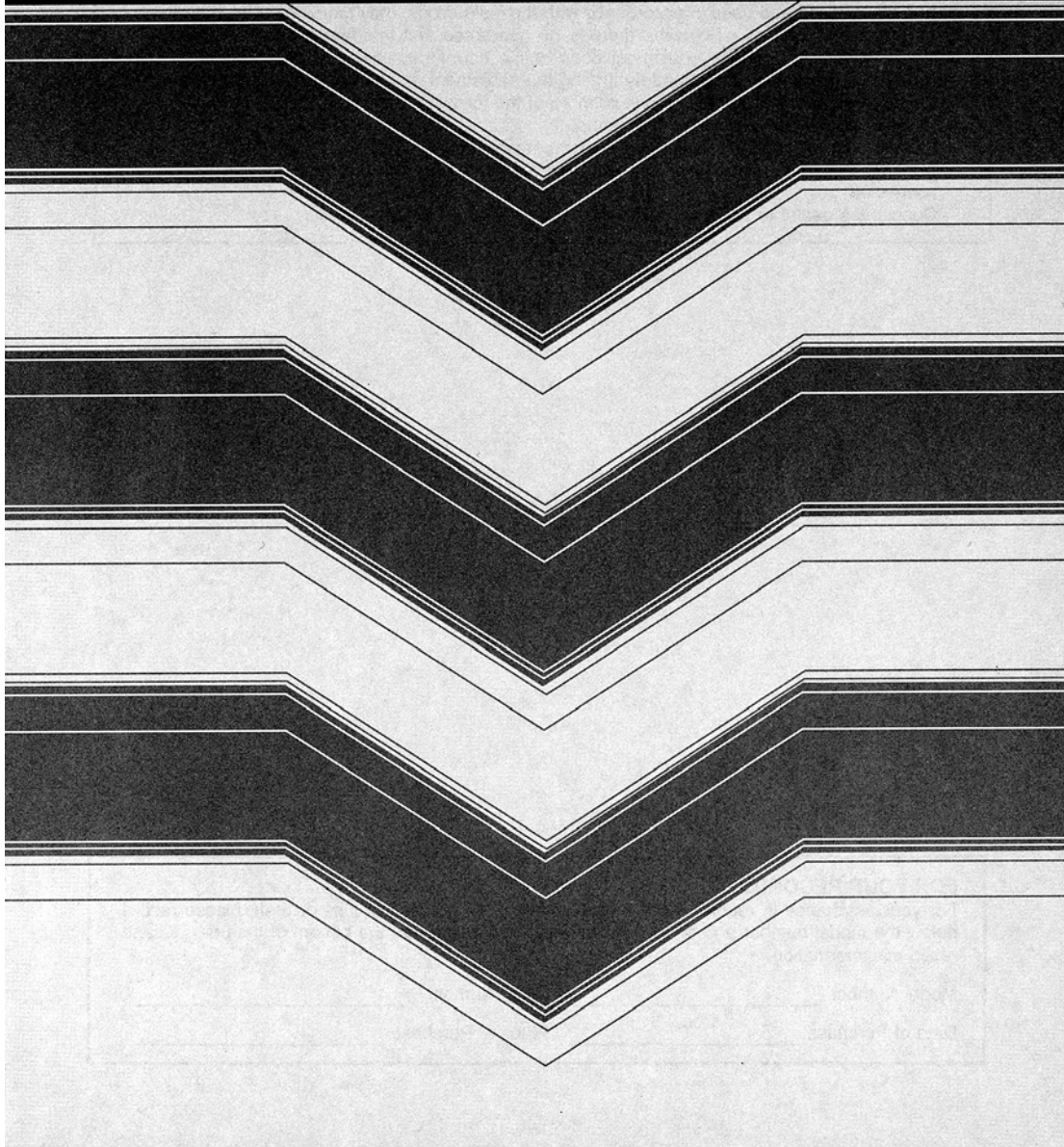

This device complies with Part 15 of the FCC Rules. Operation is subject to the following two conditions: (1) This device may not cause harmful interference, and (2) this device must accept any interference received, including interference that may cause undesired operation.

WARNING – FCC Regulations state that any unauthorized changes or modifications to this equipment not expressly approved by the manufacturer could void the user's authority to operate this equipment.

Note: This equipment has been tested and found to comply with the limits for a Class B digital device, pursuant to Part 15 of the FCC Rules.

These limits are designed to provide reasonable protection against harmful interference in a residential installation. This equipment generates, uses, and can radiate radio frequency energy and, if not installed and used in accordance with the instructions, may cause harmful interference to radio communications. However, there is no guarantee that interference will not occur in a particular installation. If this equipment does cause harmful interference to radio or television reception, which can be determined by turning the equipment off and on, the user is encouraged to try to correct the interference by one or more of the following measures:

- Reorient or relocate the receiving antenna.
- Increase the separation between the equipment and receiver.
- Connect the equipment into an outlet on a circuit different from that to which the receiver is connected.
- Consult the dealer or an experienced radio/TV technician for help.

FOR YOUR RECORDS

For your assistance in reporting this electronic calculator in case of loss or theft, please record below the model number and serial number which are located on the bottom of the unit. Please retain this information.

Model Number _____ Serial Number _____

Date of Purchase _____ Place of Purchase _____

INTRODUCTION

Thank you for your purchase of the SHARP electronic calculator, model CS-2800/2850. Your SHARP calculator is specially designed to save work and increase efficiency in all business applications and general office calculations. Careful reading of this manual will enable you to use your new SHARP to its fullest capability.

OPERATIONAL NOTES

To insure trouble-free operation of your SHARP calculator, we recommend the following:

1. The calculator should be kept in areas free from extreme temperature changes, moisture, and dust.
2. A soft, dry cloth should be used to clean the calculator. Do not use solvents or a wet cloth.
3. Turn off the power switch prior to connecting or disconnecting the AC cord.
4. If service should be required on this equipment, use only a SHARP servicing dealer, a SHARP approved service facility or SHARP repair service where available.

Note: Unless otherwise specified, the text material applies to both models.

CONTENTS

	Page
• THE KEYBOARD2
• FEATURES3
• OPERATING CONTROLS4
• INK RIBBON REPLACEMENT	10
• PAPER ROLL REPLACEMENT	11
• ERRORS	12
• DECIMAL SYSTEM	12
• CALCULATION EXAMPLES	13
• SAMPLE APPLICATIONS	26
• SPECIFICATIONS	28

THE KEYBOARD

CS-2850

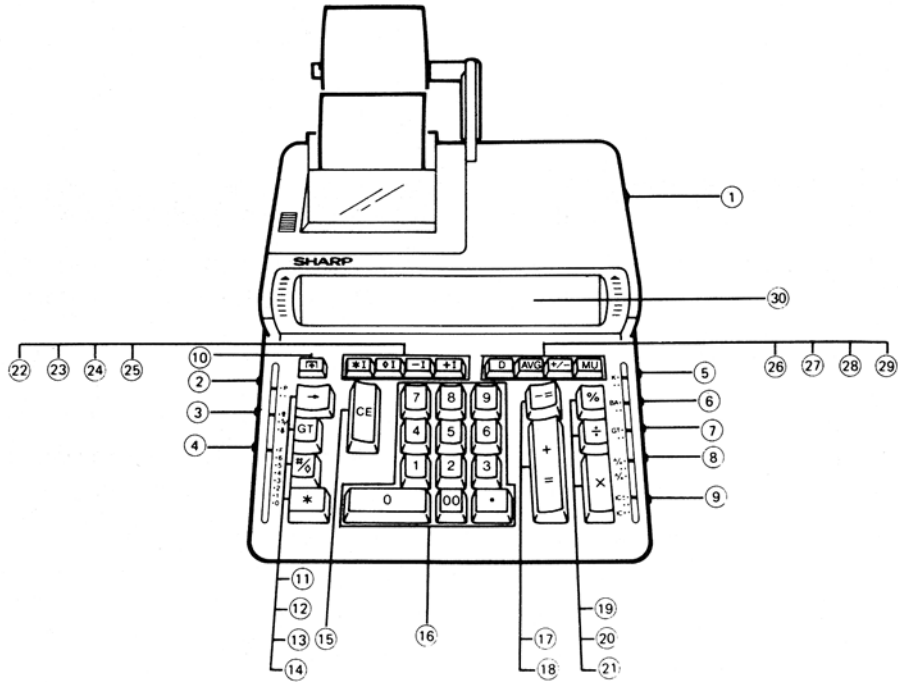

CS-2800



FEATURES

■ Tilt-adjustable Display

The calculator has a 7-position Tilt-adjustable Display for easy viewing. With a touch of your finger, you can select the position of the display for optimum viewing. (See figure)

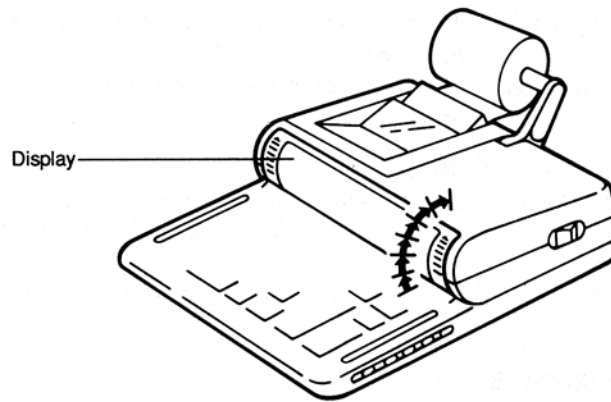

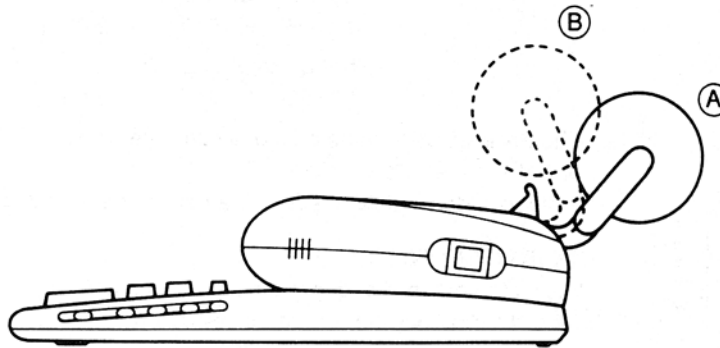

■ Adjustable position paper roll holder

The paper roll holder can be adjusted to either position (A) or position (B) according to the amount of space available (see below).



OPERATING CONTROLS

①  **POWER SWITCH:**
When the power switch is turned on, the calculator is ready for operation.

②  **PRINT MODE SELECTOR:**
"P" position: The calculator functions as a print/display calculator. (Print mode)
"•" position: The calculator functions as a display calculator. (Non-print mode)

Mode change print:

When changing the print mode selector, the following print will appear.

".....•••-P" (red print): When changing the selector from P to •.

".....•••+P" (red print): When changing the selector from • to P.

③  **ROUNDING SELECTOR:**
"↑" position: An answer is rounded up.
"5/4" position: An answer is rounded off.
"↓" position: An answer is rounded down.

EXAMPLE: $10.005 \div 5 = 2.001$

Set decimal to 2, ↑

$10.005 \div 5 \rightarrow 2.01 *$

Set decimal to 2, 5/4

$10.005 \div 5 \rightarrow 2.00 *$

Note: The decimal point floats during successive calculation by the use of \times or \div key.

In floating decimal point system, an answer is rounded down.

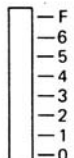
④  **DECIMAL SELECTOR:**
Presets the number of decimal places in the answer.
In the "F" position, the answer is displayed in the floating decimal system.

⑤  **CONSTANT MODE SELECTOR:**
"K" position: The following constant functions will be performed:
Multiplication: The calculator will automatically remember the first number entered (the multiplicand) and the \times instruction.

Division: The calculator will automatically remember the second number entered (the divisor) and the \div instruction.

Add-on/Discount/Mark up:
The calculator will automatically remember the first entered number and key functions for Add-on/Discount/Mark up calculation.

"•" position: Neutral

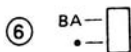

⑥

BALANCE MODE SELECTOR:

"BA" position: Make balance calculation possible.

"•" position: Neutral

Mode change print:

".....•••••◊" (red print): When any key (except \uparrow) is pressed after changing the selector from • to BA.

".....•••••" (red print): When any key (except \uparrow) is pressed after changing the selector from BA to •.

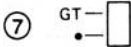

⑦

GRAND TOTAL MODE SELECTOR:

"GT" position: This selector will accumulate the following:
(The symbol "*+" will be printed.)

1. Addition and subtraction totals obtained with the \star or **AVG** (only CS-2850) key.
2. Product and quotient totals obtained with the \times or \div key.
3. Answers obtained with the % or **MU** key.

"•" position: Neutral, GT OFF

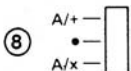

⑧

ADD MODE SELECTOR:

"A/+" position – **Effective only in addition and subtraction:**

Use of the A/+ mode permits addition and subtraction of numbers without an entry of the decimal point. When the A/+ mode is activated, the decimal point is automatically positioned according to the decimal selector setting.

EXAMPLES: Set A/+•-A/x to A/+

A. Set decimal to 2

Enter 123456 \div Prints 1.234.56 +

B. Set decimal to 3

Enter 123456 \div Prints 123.456 +

Use of the \square , \times , and \div keys will automatically override the Add mode and decimally correct answers will be printed at the preset decimal position.

EXAMPLES: Set $A/+ \bullet -A/x$ to $A/+$, 5/4

A. Set decimal to 2

Enter	.1234	\times	Prints	0.1234	x
	100	\div		100	=
				12.34	*

B. Set decimal to 3

Enter	2	\div	Prints	2	\div
	3	\div		3	=
				0.667	*

C. Set decimal to 2

Enter	123	\div	Prints	1.23	+
	10	\cdot		10.00	+
		\times		11.23	*

Note that decimal point was entered.

"A/x" position – **Multiplication and division:**

When the A/x mode is activated, the number entered before \times or \div key will override the add mode. But the number entered following \times or \div key and before \div (or $=$, $+1$ *, -1 *) key will obey the decimal setting. This is useful for invoicing. (*: only CS-2850)

EXAMPLE: Set $A/+ \bullet -A/x$ to A/x

Set decimal to 2

Enter	7	\times	Prints	7	x
	3	\div		0.03	=
				0.21	*

Note: Use of the \cdot key will automatically override the A/x mode.

Addition and subtraction:

The A/x mode functions same as the A/+ mode.

"•" position: Neutral

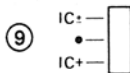

ITEM COUNT MODE SELECTOR:

"IC±" position: 1) The counter will count the number of times that the \div key has been pressed in addition.

- Note:
- Each time the $=$ key is used in subtraction, 1 will be subtracted from the count.
 - The count is printed when the calculated result is obtained.
 - Pressing of the \times , \div , \cdot , AVG (only CS-2850) or MU key clears the counter.

2) When the grand total mode selector is in the ON position (GT), the counter will count the number of times that the calculation results have been stored in the grand total memory. To print and clear the count, press the **GT** key.

3) (only CS-2850)

The memory item counter will count the number of times that the **+I** key has been pressed in the addition.

Note:

- Each time the **-I** key is used in the subtraction, 1 will be subtracted from the count.
- The count is printed when the memory is recalled.
- Pressing of the ***I** key clears the counter.

"IC+" position – 1) The counter will count the number of times that the **±** or **-±** has been pressed in addition and subtraction.

Note:

- The count is printed when the calculated result is obtained.

- Pressing of the *****, **X**, **÷**, **AVG** (only CS-2850) or **MU** key clears the counter.

2) When the grand total mode selector is in the ON position (GT), the counter will count the number of times that the calculation results have been stored in the grand total memory. To print and clear the count, press the **GT** key.

3) (only CS-2850)

The memory item counter will count the number of times that the **+I** or **-I** key has been pressed in addition and subtraction.

Note:

- The count is printed when the memory is recalled.
- Pressing of the ***I** key clears the counter.

"•" position: Neutral, counter is turned off.

Note: The counter has a maximum capacity of 3 digits (up to ±999). If the count exceeds the maximum, the counter will recount from zero.

⑩ ** PAPER FEED KEY:**

When pressed, advances the paper.

Note: You can also pull the paper manually.

⑪ ** RIGHT SHIFT KEY:**

Operation of this key in entered numbers or calculated results shifts the number one digit to the right together with the decimal point. Used for one digit correction.

- ⑫ **GT GRAND TOTAL KEY:**
Prints and clears the "GT" memory contents.
- ⑬ **%/□ NON-ADD/SUBTOTAL KEY:**
Non-add – When this key is pressed right after an entry of a number in the Print mode, the entry is printed on the left-hand side with the symbol "#".
 This key is used to print out numbers not subjects to calculation such as code, date, etc.
Subtotal – Used to get subtotal(s) of additions and/or subtractions. When pressed following the $\frac{\square}{\square}$ or $\frac{\square}{\square}$ key, the subtotal is printed with the symbol "◇" and the calculation may be continued.
By pressing this key even in the Non-print mode, the displayed number is printed with the symbol "P".
- ⑭ *** TOTAL KEY:**
Prints the total of addition and subtraction with the symbol "*". This key also serves as a clear key for the calculation register and resets an error condition.
- ⑮ **CE CLEAR ENTRY KEY:**
Clears number entered prior to use of a function key.
Also used to clear an overflow error caused by an entry.
 Ex. $123 \times 455 \rightarrow 123 \times 456 =$
 Press 123 \times 455 **CE** 456 $=$
- ⑯ **0 ~ 9 . 00 NUMERAL KEYS:**
- ⑰ **-- MINUS EQUALS KEY:**
Prints the entered number with a "-" symbol and subtracts the number from the contents of the calculation register. This key is also used to obtain the product/quotient in negative multiplication and division and prints it with the symbol "*".
- ⑱ **+ = PLUS EQUALS KEY:**
Prints the entered number with a "+" symbol and adds the number to the contents of the calculation register. This key is also used to obtain the results in multiplication and division and prints the product/quotient with the symbol "*".
- ⑲ **% PERCENT KEY**
- ⑳ **÷ DIVISION KEY**
- ㉑ **× MULTIPLICATION KEY**

- ②② ***I** **TOTAL MEMORY KEY (only CS-2850)**
- ②③ **◊I** **SUBTOTAL MEMORY KEY (only CS-2850)**
- ②④ **-I** **MEMORY MINUS KEY (only CS-2850)**
- ②⑤ **+I** **MEMORY PLUS KEY (only CS-2850)**
- ②⑥ **D** **DATE KEY: (only CS-2850)**
Can be used to store and display/print or recall the date or any other factor for repeated use in an application.
- ②⑦ **AVG** **AVERAGE KEY: (only CS-2850)**
Used to calculate the average.
- ②⑧ **+/-** **CHANGE SIGN KEY:**
Changes the algebraic sign of a number (i.e., positive to negative or negative to positive).
- ②⑨ **MU** **MULTIPLE USE KEY:**
Used to perform mark-ups, percent change and automatic add-on/discount.

③⑩ **DISPLAY**

Display format:

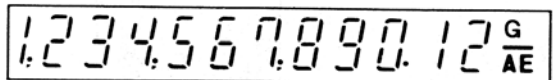
 (CS-2800)

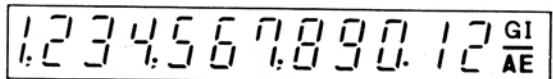
 (CS-2850)

Symbols:

- I** : **Memory symbol (only CS-2850)**
Appears when a number is in the memory.
- : **Minus symbol (red)**
Appears when a number is negative.
- E** : **Error symbol (red)**
Appears when an overflow or other error is detected.
- G** : **Grand total memory symbol**
Appears when a number is in the grand total memory.
- A** : **A symbol (red)**
Appears with the calculated result or the intermediate result to distinguish it from the keyed-in value.

INK RIBBON REPLACEMENT

1. Remove the paper roll tape from the calculator. (Tear the paper and remove from the print mechanism by using the paper feed key.)
2. **Set the power switch at OFF position.**
Make sure that the print wheel has stopped.
3. Remove the printer cover by sliding it towards the back of the calculator. (See Fig.1)
 - Roll the display downwards till it stops.
4. Remove the used ribbon.
5. Install the new ribbon.
6. With the black side of the ribbon facing upwards, place one of the reels on the reel shaft on the left. Make sure that the reel is securely in place.
7. Thread the ribbon around the outside of the metal guides. (See Fig. 2)
8. Insert the right reel securely.
9. Take up any slack by manually turning one of the reels.
10. Replace the cover.
11. Replace the paper roll.

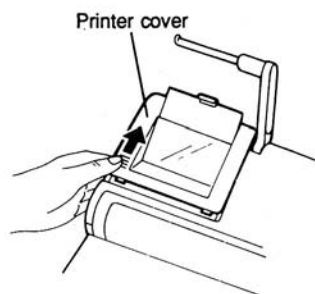

Fig. 1

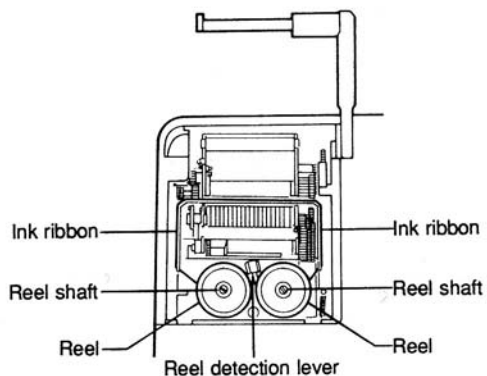
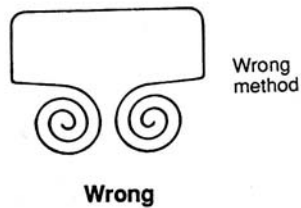
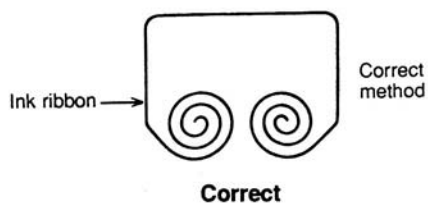

Fig. 2



PAPER ROLL REPLACEMENT

1. Lift the paper holder up. (See Fig. 1)
2. Fold the leading edge of the paper roll 3 to 5 cm. (Do not fold it slantwise.) (See Fig. 2)
3. Insert the paper roll from the left side of the paper holder and make sure the paper roll is set in the proper direction (with the paper feeding from the bottom) as shown in the figure. (See Fig. 3)
4. Fold the paper holder down to the printer cover. Insert the leading edge of the paper into the opening directly behind the print mechanism. (See Fig. 4)
5. Lift the paper holder up. Press the paper feed key and feed the paper under the edge of the paper cutter. (See Fig. 5)

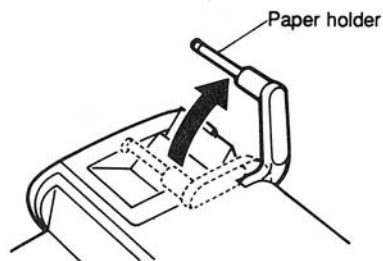

Fig. 1

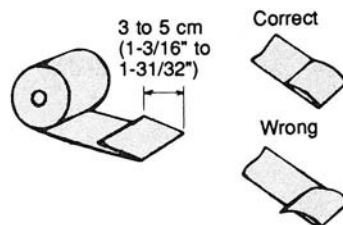

Fig. 2

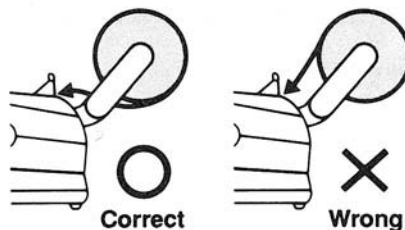

Fig. 3

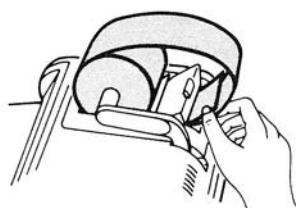

Fig. 4

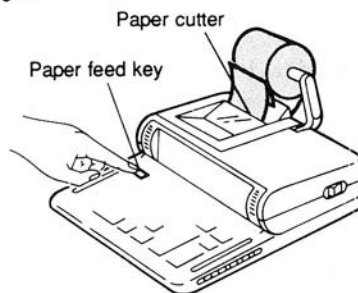

Fig. 5

ERRORS

There are several situations which will cause an overflow or an error condition. When this occurs, the error symbol "E" will be displayed and all keys will electronically lock. The contents of the memory at the time of the error are retained.

If an "0-E" is printed on the tape at the time of the error, the \boxed{C} key must be used to clear the calculator. If an "E" with any numerals except zero is printed on the tape or if an "E" is not printed on the tape, the error may be cleared with the \boxed{CE} or $\boxed{\rightarrow}$ key and the calculation can still be continued.

Error conditions:

1. Entry of more than 12 digits or 11 decimals.
This error can be cleared with the \boxed{CE} or $\boxed{\rightarrow}$ key.
2. When the integer portion of an answer exceeds 12 digits.
3. When the integer portion of the contents of the memory exceeds 12 digits.
(only CS-2850) (Ex. $\boxed{M+}$ 999999999999 $\boxed{M+}$ 1 $\boxed{M+}$)
4. When any number is divided by zero. (Ex. $5 \div 0 \text{ E}$)

DECIMAL SYSTEM

Input override decimal feature

The calculator operates on a principle of floating decimal entries with preset decimal answers.

1. An entry may contain up to 11 decimal places, regardless of the decimal selector setting.
2. Answers will be printed to the preset decimal position except when an underflow condition prevails.

Output override decimal feature

This feature enables an answer to be printed in the floating decimal when the result is too small to be picked up within the range of the preset decimal.

EXAMPLE: Set decimal at 2







Enter	5 \div	Tape prints	5 \div
	7777 \div		77.777 =
			0.00006428635 *

CALCULATION EXAMPLES

1. Set the decimal selector as specified in each example.
The rounding selector should be in the "5/4" position unless otherwise specified.
2. The grand total mode, constant mode, add mode, item count mode, and balance mode selectors should be in the "•" position (off position) unless otherwise specified.
3. Print mode selector should be in the "P" position unless otherwise specified.
4. If an error is made while entering a number, press the **CE** or **→** key and enter the correct number.
5. Negative values are printed with "-" symbol in red.

Note: All totals and sub-totals may be used for further calculations. **RE-ENTER** the number into the calculator by using a **FUNCTION** key and continue the problem.

EXAMPLE:







Selector	Operation	Print	Note	
	123 	123.00 +		
	456 	456.00 +		
		579.00		
		* 579.00 x		* Re-entry of total
	2 	2. =		
			1,158.00 *	

DATE MEMORY (only CS-2850)

The CS-2850, provided with date memory, allows date, number etc. to be stored once and then recalled and printed as necessary.



Note: The date memory can also be used as a constant memory.

- A. Print the date of March 5, 1993.

Selector (1)	Operation (2)	Display (3)	Print (4)
	3.05.1993 	3.05-1993	3.05-1993 (red)
		0.	0. *
	20 	20.00 _A	20.00 +
	30 	50.00 _A	30.00 +
		50.00 _A	50.00 *
		3.05-1993	3.05-1993 (red)

B. $2 \times 12.34 =$

$4 \div 12.34 =$

(1)	(2)	(3)	(4)
	12.34 D	12.34	12.34 (red)
	2 X	2.	2. x
	D	12.34	12.34 (red)
	=	24.68 _A	12.34 = 24.68 *
	4 ÷	4.	4. ÷
	D	12.34	12.34 (red)
	=	0.32 _A	12.34 = 0.32 *

↑ Enters numbers into the date memory.

ADDITION

$12.45 + 36.62 - 93.20 =$

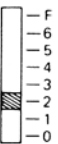
(1)	(2)	(3)	(4)
	12.45 +	12.45 _A	12.45 +
	36.62 +	49.07 _A	36.62 +
	93.20 -	44.13 _A	93.20 -
	=	44.13 _A	- 44.13 *

REPEAT ADDITION AND SUBTRACTION

$123 + 123 + 123 + 456 - 100 - 100 =$

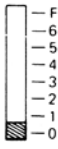
(1)	(2)	(3)	(4)
	123 +	123. _A	123. +
	+	246. _A	123. +
	+	369. _A	123. +
	456 +	825. _A	456. +
	100 -	725. _A	100. -
	-	625. _A	100. -
	=	625. _A	625. *

ADDITION AND SUBTRACTION WITH ADD MODE

$$12.45 + 16.24 + 19.35 - 5.21 =$$

(1)	(2)*	(3)	(4)
	1245 $\frac{+}{\pm}$	12.45 _A	12.45 +
	1624 $\frac{+}{\pm}$	28.69 _A	16.24 +
	1935 $\frac{+}{\pm}$	48.04 _A	19.35 +
	521 $\frac{-}{\pm}$	42.83 _A	5.21 -
	$\frac{*}{\pm}$	42.83 _A	42.83 *

* : The $\frac{\cdot}{\pm}$ key was not used in the entries.

MULTIPLICATION

$$12.36 \times 3.33 \times 53.21 =$$

(1)	(2)	(3)	(4)
	12.36 $\frac{\times}{\pm}$	12.36	12.36 x
	3.33 $\frac{\times}{\pm}$	41.1588 _A	3.33 x
	53.21 $\frac{\times}{\pm}$	2,190.06 _A	53.21 =
			2.190.06 *

DIVISION

$$256 \div 12 \div 0.56 =$$

(1)	(2)	(3)	(4)
	256 $\frac{\div}{\pm}$	256.	256. \div
	12 $\frac{\div}{\pm}$	21.3333333333 _A	12. \div
	.56 $\frac{\div}{\pm}$	38.095 _A	0.56 =
			38.095 *

MIXED CALCULATIONS

A. $(10 + 2) \times 5 =$

(1)	(2)	(3)	(4)
	10 $\frac{+}{\pm}$	10. _A	10. +
	2 $\frac{+}{\pm}$	12. _A	2. +
	$\frac{\times}{\pm}$		12. \diamond
	5 $\frac{\times}{\pm}$	12.	12. x
		60. _A	5. =
			60. *

B. $5 \times 2 + 12 =$

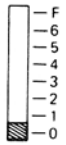
(1)	(2)	(3)	(4)
	$5 \times$ $2 \div$ $12 \div$ \times	5. 10. _A 10. _A 22. _A 22. _A	$5 \cdot \times$ $2 \cdot =$ $10 \cdot *$ $10 \cdot +$ $12 \cdot +$ $22 \cdot *$

C. $\frac{(5 + 12) \times 3.2 \times 6.7}{2} =$

(1)	(2)	(3)	(4)
	$5 \div$ $12 \div$ \times $3.2 \times$ $6.7 \div$ $2 \div$	5.00 _A 17.00 _A 17.00 54.4 _A 364.48 _A 182.24 _A	$5 \cdot 00 +$ $12 \cdot 00 +$ $17 \cdot 00 \diamond$ $17 \cdot 00 \times$ $3 \cdot 2 \times$ $6 \cdot 7 \div$ $2 \cdot =$ $182 \cdot 24 *$

CONSTANT CALCULATIONS

A. MULTIPLICATION

$62.35 \times 11.11 =$ ①

$62.35 \times 22.22 =$ ②

$62.35 \times 33.33 =$ ③

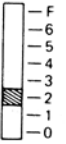
(1)	(2)	(3)	(4)
	$62.35 \times$ $11.11 \div$ $22.22 \div$ $33.33 \div$	62.35 692.71 _A 1,385.42 _A 2,078.13 _A	$62 \cdot 35 \times$ $11 \cdot 11 = K$ $692 \cdot 71 *$ ① $22 \cdot 22 = K$ $1 \cdot 385 \cdot 42 *$ ② $33 \cdot 33 = K$ $2 \cdot 078 \cdot 13 *$ ③

B. DIVISION

$11.11 \div 77.77 = \textcircled{1}$

$22.22 \div 77.77 = \textcircled{2}$

$33.33 \div 77.77 = \textcircled{3}$

(1)	(2)	(3)	(4)
	$11.11 \div$ $77.77 =$	11.11 0.143_A	$11 \cdot 11 \div$ $77 \cdot 77 = K$ $0 \cdot 143 * \textcircled{1}$
	$22.22 \div$ $77.77 =$	0.286_A	$22 \cdot 22 = K$ $0 \cdot 286 * \textcircled{2}$
	$33.33 \div$ $77.77 =$	0.429_A	$33 \cdot 33 = K$ $0 \cdot 429 * \textcircled{3}$

POWER CALCULATIONS

A. SQUARING

$5.25^2 = 5.25 \times 5.25 =$

(1)	(2)	(3)	(4)
	$5.25 \times$ $5.25 =$	5.25 27.563_A	$5 \cdot 25 \times$ $5 \cdot 25 =$ $27 \cdot 563 *$

B. CUBING

$5^3 = 5 \times 5 \times 5 =$

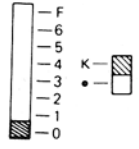
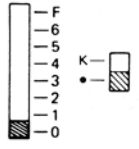
(1)	(2)	(3)	(4)
	$5 \times$ $5 \times$ $5 =$	$5.$ 25_A 125_A	$5 \cdot \times$ $5 \cdot = K$ $25 \cdot *$ $25 \cdot = K$ $125 \cdot *$
	$5 \times$ $5 \times$ $5 =$	$5.$ 25_A 125_A	$5 \cdot \times$ $5 \cdot \times$ $5 \cdot =$ $125 \cdot *$

CORRECTION OF ERRORS

A. $123 + \underline{556} \rightarrow 123 + \underline{456}$

(1)	(2)	(3)	(4)
	123 $\boxed{+}$ 556 \boxed{CE} 456 $\boxed{+}$ $\boxed{=}$	123. _A 0. 579. _A 579. _A	123. + 456. + 579. *

B. $1234567 \rightarrow 1234578$

(1)	(2)	(3)
	1234567 $\boxed{\rightarrow}$ $\boxed{\rightarrow}$ 78	1,234,567. 123,456. 12,345. 1,234,578.

RECIPROCAL CALCULATIONS

$$\frac{1}{7} = \textcircled{1} \quad \frac{1}{7^3} = \textcircled{2}$$

(1)	(2)	(3)	(4)
	7 $\boxed{\div}$ $\boxed{=}$ $\boxed{=}$	7. 1. _A 0.14285714285 _A	7. \div 7. \div 7. = 0.14285714285 * $\textcircled{1}$
	7 $\boxed{\div}$ $\boxed{\div}$ $\boxed{\div}$ $\boxed{\div}$ $\boxed{=}$	7. 1. _A 0.14285714285 _A 0.02040816326 _A 0.00291545189 _A	7. \div 7. \div 7. \div 7. \div 7. = 0.00291545189 * $\textcircled{2}$

PERCENT MULTIPLICATION – DIVISION

A. $100 \times 25\% =$

(1)	(2)	(3)	(4)
	100 $\boxed{\times}$ 25 $\boxed{\%}$	100. 25.00 _A	100. x 25. % 25.00 *

B. $123 \div 1368 = (\%)$

(1)	(2)	(3)	(4)
	$123 \div$ 1368%	$123.$ 8.99_A	$123 \div$ 1.368% $8.99 *$

SQUARE ROOT CALCULATION

EXAMPLE: $\sqrt{123,456} =$

(1)	(2)	(3)	(4)
	$123456 \sqrt{\div}$ $\sqrt{=}$	$123,456.$ 351.363_A	$123,456 \div$ $123,456 \sqrt{\div}$ $351.363 *$

ADD-ON/DISCOUNT

EXAMPLE: 1 A 5% add-on to 100

EXAMPLE: 2 A 10% discount on 100

(1)	(2)	(3)	(4)
	$100 \times$ 5 MU	$100.$ 105.00_A	$100 \cdot x$ $5 \cdot \%$ 5.00 Increase $105.00 *$ New amount

(1)	(2)	(3)	(4)
	$100 \times$ 10 +/- MU	$100.$ 90.00_A	$100 \cdot x$ $- 10 \cdot \%$ $- 10.00$ Discount $90.00 *$ Net amount

EXAMPLE: 3 A 5% add-on to 200 ——— ①
 A 10% add-on to 200 ——— ②

(1)	(2)	(3)	(4)
	$200 \times$ 5 MU	$200.$ 210.00_A	$200 \cdot x$ Constant $5 \cdot \%$ 10.00 $210.00 *$ ①
	10 MU	220.00_A	$10 \cdot \%$ 20.00 $220.00 *$ ②

Markup and Profit Margin are both ways of calculating percent profit.

The difference is:

- Profit margin is percent profit vs. selling price.
- Markup is percent profit vs. cost.

Note: In some cases, negative percentages will be shown for margin or markup.
This is a normal function of the calculation logic.

MARGIN

EXAMPLE: Calculate the profit margin of a \$65.00 item being sold at \$89.00.

(1)	(2)	(3)	(4)
	65 \div 89 \pm MU	65.00 \bar{A} 24.00 \bar{A} 26.97 \bar{A}	65.00 - 89.00 + 24.00 * 26.97 %C

SELLING PRICE (USING MARGIN)

EXAMPLE: Calculate the selling price (a) and the gross profit (b) from a cost of \$8,160 on the basis of a 15% profit on the selling price.

(1)	(2)	(3)	(4)
	8160 \div 15 MU	8,160. 1,440.00 \bar{A}	8,160 \div 15 %M 9,600.00 * (a) 1,440.00 GP (b)

COST (USING MARGIN)

EXAMPLE: Calculate the cost (a) and the gross profit (b) from a selling price of \$500 on the basis of a 35% profit on the selling price.

(1)	(2)	(3)	(4)
	500 \times 35 \div MU	500. 325.00 \bar{A}	500 \times - 35 % - 175.00 (b) 325.00 * (a)

MARKUP

EXAMPLE: Calculate the markup of a \$150.00 item being sold at \$200.00.

(1)	(2)	(3)	(4)
	200 $\boxed{+}$	200.00 _A	200.00 +
	150 $\boxed{-}$	50.00 _A	150.00 -
	\boxed{MU}		50.00 *
		33.33 _A	33.33 %C

SELLING PRICE (USING MARKUP)

EXAMPLE: Calculate the selling price (a) and gross profit (b) from a cost of \$6,950 on the basis of a 25% profit on the cost.

(1)	(2)	(3)	(4)
	6950 \boxed{x}	6,950.	6.950. x
	25 \boxed{MU}		25. %
		8,687.50 _A	1.737.50 (b)
			8.687.50 * (a)

COST (USING MARKUP)

EXAMPLE: Calculate the cost (a) and the gross profit (b) from a selling price of \$9,780 on the basis of a 20% profit on the cost.

(1)	(2)	(3)	(4)
	9780 $\boxed{\div}$	9,780.	9.780. \div
	20 $\boxed{+/-}$ \boxed{MU}		- 20. %M
		1,630.00 _A	8.150.00 * (a)
			1.630.00 GP (b)

PERCENT CHANGE



EXAMPLE: Calculate the dollar difference (a) and the percent change (b) between two yearly sales figures \$1,500 in one year and \$1,300 in the previous year.

(1)	(2)	(3)	(4)
	1500 $\boxed{+}$	1,500.00 _A	1.500.00 +
	1300 $\boxed{-}$	200.00 _A	1.300.00 -
	\boxed{MU}		200.00 * (a)
		15.38 _A	15.38 %C (b)

PERCENT PRORATION

EXAMPLE: Calculate the percentage of each of the parts is to the whole.

Expenses	%
\$ 123	(a)
456	(b)
789	(c)
(D)	(d)

(1)	(2)	(3)	(4)
 GT 	GT * 123 + 456 + 789 + 123 MU	123.00 _A 579.00 _A 1,368.00 _A	123-00 + 456-00 + 789-00 + 1,368-00 * (D)
		8.99 _A ^a	123 F 8-99 %P (a)
	456 MU	33.33 _A ^a	456 F 33-33 %P (b)
	789 MU	57.68 _A ^a	789 F 57-68 %P (c)
	GT	100.00 _A	100-00 * G (d)

ITEM COUNT CALCULATION

Bill No.	Number of bills	Amount
1	1	\$100.55
2	1	\$200.00
3	1	\$200.00
4	1	\$400.55
5	1	\$500.65
Total	(a)	(b)

(1)	(2)	(3)	(4)
	100.55	100.55 _A	100.55 +
	200	300.55 _A	200.00 +
	400.55	500.55 _A	200.00 +
	500.65	901.10 _A	400.55 +
		1,401.75 _A	500.65 +
			005 (a)
		1,401.75 _A	1,401.75 * (b)

GRAND TOTAL CALCULATION

EXAMPLE:

$$100 + 200 + 300 = \textcircled{1}$$

$$+) 300 + 400 + 500 = \textcircled{2}$$

$$+) 500 - 600 + 700 = \textcircled{3}$$

Grand total $\textcircled{4}$

(1)	(2)	(3)	(4)
	100	100. _A	100. +
	200	300. _A	200. +
	300	600. _A	300. +
		600. _A	600. *+ $\textcircled{1}$
	300	300. _A	300. +
	400	700. _A	400. +
	500	1,200. _A	500. +
		1,200. _A	1,200. *+ $\textcircled{2}$
	500	500. _A	500. +
	600	100. _A	600. -
	700	600. _A	700. +
		600. _A	600. *+ $\textcircled{3}$
		2,400. _A	2,400. *G $\textcircled{4}$

MEMORY CALCULATIONS (only CS-2850)

EXAMPLE (1): $46 \times 78 = \textcircled{1}$
 $+) 125 \div 5 = \textcircled{2}$
 $-) 72 \times 8 = \textcircled{3}$

Total $\textcircled{4}$

(1)	(2)	(3)	(4)
	MC		
	46 M	46.	46 \times
	78 M		78 =
		3,588. ^A	3,588 M $\textcircled{1}$
	125 M	125. ^I	125 \div
	5 M		5 =
		25. ^I	25 M $\textcircled{2}$
	72 M	72. ^I	72 \times
	8 M		8 =
		576. ^A	576 M $\textcircled{3}$
	3,037. ^A	3,037 M $\textcircled{4}$	

* : Press the MC key to clear the memory before starting a memory calculation.

EXAMPLE (2): $(123 + 45) \times (456 - 89) =$

(1)	(2)	(3)	(4)
	MC		
	123 M	123. ^A	123 M
	45 M	45. ^A	45 M
		456. ^A	456 M
	456 M	367. ^A	89 M
	89 M		89 M
		367. ^I	367 M
		168. ^A	168 M
		61,656. ^A	168 =
			61,656 *

BALANCE CALCULATION

Setting the balance mode selector to the "BA" position makes balance calculation possible. In other words, the calculations are performed and the balance is always printed out.

In the balance mode, the entry and balance only for addition and subtraction (by the \pm and \mp key operations) can be printed out.

Also, the entry is printed on the left hand side of the paper and the balance is printed with the symbol "◇" on the right hand side of the paper.

EXAMPLE:

Entry	Balance
123.00 +	123.00
456.00 +	579.00
234.00 -	345.00
Total	345.00

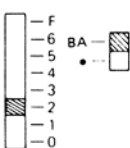
(1)	(2)	(3)	(4)
	123 \pm		123.00 +
		123.00 A	123.00 ◇
	456 \pm		456.00 +
		579.00 A	579.00 ◇
	234 \mp		234.00 -
		345.00 A	345.00 ◇
	$*$	345.00 A	345.00 *

SAMPLE APPLICATIONS

1. Set the decimal selector as specified in each example.
The rounding selector should be in the "5/4" position unless otherwise specified.
2. The grand total mode, constant mode, add mode, item count mode, and balance mode selectors should be in the "•" position (off position) unless otherwise specified.
3. Print mode selector should be in the "P" position.

AVERAGING (only CS-2850)

Calculate the average of a series of values.

- SOLUTION:**
1. Add the values to calculate the TOTAL VALUES.
 2. Determine the NUMBER OF VALUES.
 3. Calculate the average.

FORMULA:

$$\text{Average} = \frac{\text{Total of the values}}{\text{Number of values}}$$

EXAMPLE:

	Day	Sales
If	Monday	\$123.15
	Tuesday	118.00
	Wednesday	131.58
	Thursday	125.02
	Friday	158.25
	Total Sales \$656.00 for 5 days	

Then Average Sales = \$131.20

Note: If you are working in dollars and cents, use the "Add Mode." If not, set the decimal as desired.

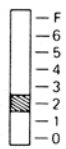
Selector (1)	Operation (2)	Display (3)	Print (4)
	* 12315 118 • 13158 12502 15825 • AVG	123.15 A 241.15 A 372.73 A 497.75 A 656.00 A 131.20 A	123-15 + 118-00 + 131-58 + 125-02 + 158-25 + 005 No. of items 656-00 * Total sales 131-20 AG Average

COMPOUND INTEREST

Calculate the new balance on a deposit which is compounded quarterly for 4 years at a given annual interest rate.

SOLUTION: 1. Calculate the quarterly interest rate.
2. Calculate the new balance (principal plus interest)

FORMULA: $\text{New balance} = P (1 + i)^n$

Where P = amount of deposit (principal)
i = interest rate per period
n = number of years x 4

EXAMPLE: If P = \$6,150
i = 5% annum ÷ 4 periods = 0.0125
n = 4 years x 4 periods = 16

Then $6,150 (1 + 0.0125)^{16} \doteq \$7,502.32$ (New Balance)

(1)	(2)	(3)	(4)
	.05	0.05	0.05 ÷ Annual int. rate
	4	0.0125 _A	4 · = Quarterly int. rate
		0.0125 _A	0.0125 * Quarterly int. rate
	1	1.0125 _A	0.0125 +
		1.0125	1 · +
		1.0125	1.0125 ◊ (1 + i)
		1.02515625 _A	1.0125 x
		1.02515625	1.0125 =
		1.05094533691 _A	1.02515625 * (1 + i) ²
		1.05094533691	1.02515625 x
		1.10448610117 _A	1.05094533691 = (1 + i) ⁴
		1.10448610117	1.05094533691 x
		1.21988954767 _A	1.10448610117 = (1 + i) ⁸
		1.21988954767	1.10448610117 x
	6150	7,502.32071817 _A	1.21988954767 * (1 + i) ¹⁶
			1.21988954767 x
		6.150 · = Principal	
		7.502.32071817 * New balance	

SPECIFICATIONS

Type:	Electronic print/display calculator
Power source:	AC: 120V, 60Hz
Display:	Fluorescent display
Operating capacity:	12 digits
Display/Print capacity:	With symbol and 3-digit punctuations 13 digits (display), 18 digits (printing)
Decimal point:	Automatic decimal point positioning by preset decimal selector (0-1-2-3-4-5-6-F) with Add mode (A/+, A/x)
Calculations:	Four arithmetic calculations, constant multiplication and division, power calculation, add-on/discount calculation, repeat addition and subtraction, square root calculation, reciprocal calculation, grand total calculation, item count calculation, markup calculation, balance calculation, average calculation (only CS-2850), memory calculation (only CS-2850), etc.
Components:	LSI, etc.

PRINTING SECTION

Printer:	Mechanical printer
Printing speed:	Approx. 4.5 lines/sec.
Paper feed speed:	Approx. 13.5 lines/sec.
Printing paper:	57 mm (2-1/4") ~ 58 mm (2-9/32") wide 80 mm (3-5/32") in diameter (max.)
Operating temperature:	0°C ~ 40°C (32°F ~ 104°F)
Power consumption:	16.3W
Dimensions:	215.9 (W) x 279.4 (D) x 78 (H) mm 8-1/2" (W) x 11" (D) x 3-1/16" (H)
Weight:	Approx. 2.1 kg (4.63 lbs.)
Accessories:	1 paper roll, 1 ink ribbon and operation manual

WARNING

THE VOLTAGE USED MUST BE THE SAME AS SPECIFIED ON THIS CALCULATOR. USING THIS CALCULATOR WITH A HIGHER VOLTAGE THAN THAT WHICH IS SPECIFIED IS DANGEROUS AND MAY RESULT IN A FIRE OR OTHER TYPE OF ACCIDENT CAUSING DAMAGE. WE ARE NOT RESPONSIBLE FOR ANY DAMAGE RESULTING FROM USE OF THIS CALCULATOR WITH A VOLTAGE OTHER THAN THAT WHICH IS SPECIFIED.

SHARP

SHARP ELECTRONICS CORPORATION

Sharp Plaza, Mahwah, New Jersey 07430-2135

SHARP CORPORATION

PRINTED IN CHINA
T(E0141E) ©
OGS9208291////

Free Manuals Download Website

<http://myh66.com>

<http://usermanuals.us>

<http://www.somanuals.com>

<http://www.4manuals.cc>

<http://www.manual-lib.com>

<http://www.404manual.com>

<http://www.luxmanual.com>

<http://aubethermostatmanual.com>

Golf course search by state

<http://golfingnear.com>

Email search by domain

<http://emailbydomain.com>

Auto manuals search

<http://auto.somanuals.com>

TV manuals search

<http://tv.somanuals.com>