

SHARP®

LCD MONITOR

LL-T2000A

OPERATION MANUAL

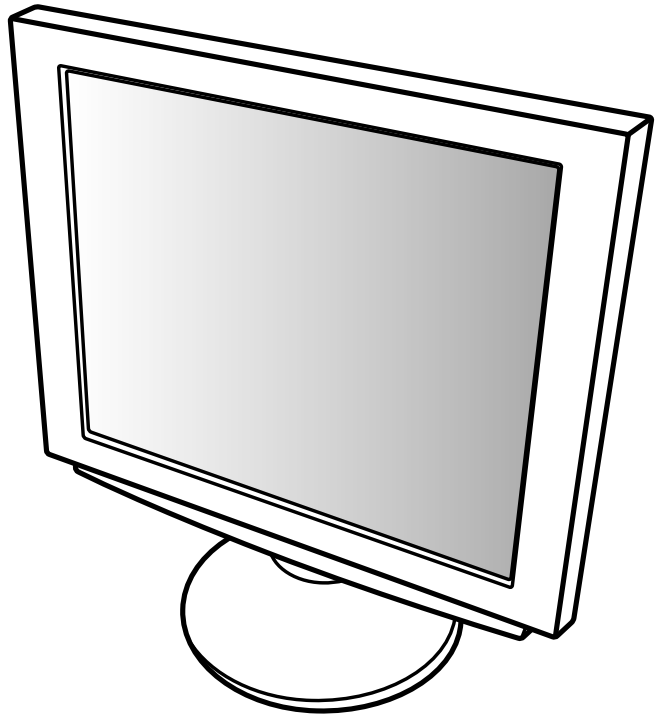

Table of Contents

Notice for Users in the USA	4
Notice for Users in Europe	5
Notice for Users in the UK	6
Notice for Users in Australia	6
Tips and safety precautions	7
Product description	8
Connecting the monitor and turning the monitor on and off	10
Connecting the monitor to a power source	10
Connecting the monitor to a computer (PC etc.)	11
Connecting to a second computer	11
Connecting a USB device	11
Turning the power on	12
Turning the power off	15
Adjusting the screen display	16
Automatic screen adjustment	17
Adjusting the backlight	17
Manual screen adjustment	18
Monitor care and repair	21
Monitor care	21
Storage	21
Troubleshooting	21
Specifications	22
Instructions for attaching a VESA compliant arm	25

Notice for Users in the USA

FCC Statement

WARNING – FCC Regulations state that any unauthorized changes or modifications to this equipment not expressly approved by the manufacturer could void the user's authority to operate this equipment.

Note: This equipment has been tested and found to comply with the limits for a Class B digital device pursuant to Part 15 of the FCC Rules.

These limits are designed to provide reasonable protection against harmful interference in a residential installation. This equipment generates, uses and can radiate radio frequency energy and, if not installed and used in accordance with the instructions, may cause harmful interference to radio communications. However, there is no guarantee that interference will not occur in a particular installation. If this equipment does cause harmful interference to radio or television reception, which can be determined by turning the equipment off and on, the user is encouraged to try to correct the interference by one or more of the following measures:

- Reorient or relocate the receiving antenna.
- Increase the distance between the equipment and receiver.
- Connect the equipment into an outlet on a circuit different from that to which the receiver is connected.
- Consult the dealer or an experienced radio/TV technician for help.

Use nothing but the included cables and AC cord to insure compliance with FCC regulation for Class B computing equipment.

Declaration of Conformity

SHARP LCD Color Monitor LL-T2000A

This device complies with part 15 of the FCC rules. Operation is subject to the following conditions: (1) this device may not cause harmful interference, and (2) this device must accept any interference received, including interference that may cause undersized operation.

Responsible Party : SHARP ELECTRONICS CORPORATION
Sharp Plaza, Mahwah, New Jersey 07430
TEL :1-800-BE-SHARP



* As an ENERGY STAR Partner, SHARP has determined that this product meets the ENERGY STAR guidelines for energy efficiency.

This product utilizes tin-lead solder, and fluorescent lamp containing a small amount of mercury. Disposal of these materials may be regulated due to environmental considerations. For disposal or recycling information, please contact your local authorities or the Electronics Industries Alliance: www.eiae.org

Notice for Users in Europe

This equipment complies with the requirements of Directives 89/336/EEC and 73/23/EEC as amended by 93/68/EEC.

Dieses Gerät entspricht den Anforderungen der EG-Richtlinien 89/336/EWG und 73/23/EWG mit Änderung 93/68/EWG.

Ce matériel répond aux exigences contenues dans les directives 89/336/CEE et 73/23/CEE modifiées par la directive 93/68/CEE.

Dit apparaat voldoet aan de eisen van de richtlijnen 89/336/EEG en 73/23/EEG, gewijzigd door 93/68/EEG.

Dette udstyr overholder kravene i direktiv nr. 89/336/EEC og 73/23/EEC med tillæg nr. 93/68/EEC.

Quest' apparecchio è conforme ai requisiti delle direttive 89/336/EEC e 73/23/EEC, come emendata dalla direttiva 93/68/EEC.

Η εγκατάσταση ανταποκρίνεται στις απαιτήσεις των οδηγιών της Ευρωπαϊκής Ένωσης 89/336/EOK και 73/23/EOK, όπως οι κανονισμοί αυτοί συμπληρώθηκαν από την οδηγία 93/68/EOK.

Este equipamento obedece às exigências das directivas 89/336/CEE e 73/23/CEE, na sua versão corrigida pela directiva 93/68/CEE.

Este aparato satisface las exigencias de las Directivas 89/336/CEE y 73/23/CEE, modificadas por medio de la 93/68/CEE.

Denna utrustning uppfyller kraven enligt riktlinjerna 89/336/EEC och 73/23/EEC så som komplette ras av 93/68/EEC.

Dette produktet oppfyller betingelsene i direktivene 89/336/EEC og 73/23/EEC i endringen 93/68/EEC.

Tämä laite täyttää direktiivien 89/336/EEC ja 73/23/EEC vaatimukset, joita on muutettu direktiivillä 93/68/EEC.

CAUTION :

TO PREVENT ELECTRICAL SHOCK, DISCONNECT THE AC CORD BEFORE SERVICING.

CAUTION :

FOR A COMPLETE ELECTRICAL DISCONNECTION, PULL OUT THE MAIN PLUG.

VORSICHT :

UM DIE STROMZUFUHR VOLLSTÄNDIG ZU UNTERBRECHEN, DEN NETZSTECKER HERAUSZIEHEN ENTFERNEN.

ATTENTION :

POUR UN ARRÊT TOTAL DU SYSTEME, DECONNECTEZ LA PRISE DE COURANT SECTEUR.

VARNING :

FÖR TOTAL ELEKTRISK URKOPPLING, KOPPLA UR KONTAKTEN OCH.

PRECAUCION :

PARA UNA COMPLETA DESCONEXION ELECTRICA DESENCHUFE LA CLAVIJA DE LA RED.

Notice for Users in the UK

FOR CUSTOMERS IN U.K.

IMPORTANT

The wires in this mains lead are coloured in accordance with the following code :

GREEN-AND-YELLOW : **Earth**
BLUE : **Neutral**
BROWN : **Live**

As the colours of the wires in the mains lead of this apparatus may not correspond with the coloured markings identifying the terminals in your plug proceed as follows. The wire which is coloured GREEN-AND-YELLOW must be connected to the terminal in the plug which is marked by the letter E or by the safety earth \perp or coloured green or green-and-yellow.

The wire which is coloured BLUE must be connected to the terminal which is marked with the letter N or coloured black.

The wire which is coloured BROWN must be connected to the terminal which is marked with the letter L or coloured red.

Ensure that your equipment is connected correctly-if you are in any doubt consult a qualified electrician.

"WARNING : THIS APPARATUS MUST BE EARTHED"

Notice for Users in Australia

Service Inquiries

Please contact your dealer for service if required or contact Sharp Corporation of Australia on 1 300 13 50 22 for referral to your nearest Sharp authorized Service Center.

Tips and safety precautions

- Under certain display conditions, minute specks or spots may be noticeable. This is common for liquid crystal monitors and is not a malfunction.
- The LCD panel has been manufactured using highly elaborate technology. Properly working pixels comprise 99.99% of total pixels. However, please understand that 0.01% or less of pixels may be missing or be brighter than usual.
- Do not leave the screen displaying idly for long periods of time, as this could cause afterimage to remain.
- If the brightness is adjusted to the minimum setting it may be difficult to see the screen.
- The quality of the computer signal may influence the quality of the display. We recommend using a computer able to emit high quality video signals.
- Never rub or tap the monitor with hard objects.
- Please understand that Sharp Corporation bears no responsibility for errors made during use by the customer or a third party, nor for any other malfunctions or damage to this product arising during use, except where indemnity liability is recognized under law.
- This monitor and its accessories may be upgraded without advance notice.

Location

- Do not use the monitor where ventilation is poor, where there is a lot of dust, where humidity is high, or where the monitor may come into contact with oil or steam, as this could lead to fire.
- Ensure that the monitor does not come into contact with water or other fluids. Ensure that no objects such as paper clips or pins enter the monitor as this could lead to fire or electric shock.
- Do not place the monitor on top of unstable objects or in unsafe places. Do not allow the monitor to come into contact with strong shocks or vibrations. Causing the monitor to fall or topple over may damage it.
- Do not use in places where the monitor will be subject to direct sunlight, near heating equipment or anywhere else where there is likelihood of high temperature, as this may lead to generation of excessive heat and outbreak of fire

The Power Cord

- Do not damage the power cord nor place heavy objects on it, stretch it or overly bend it. Also, do not add extension cords. Damage to the cord may result in fire or electric shock.
- Use only the AC adapter supplied with the monitor. Using an AC adapter other than that supplied may lead to fire.
- Insert the power plug directly into the AC outlet. Adding an extension cord may lead to fire as a result of overheating

Monitor and accessory checklist

- Please check that the following items are included in the package.
 - LCD monitor (1)
 - AC adapter (1)
 - USB cable (1)
 - Utility Disk for Windows and Macintosh (1)
 - Operation manual (1)

Notes:

- You are advised to retain the carton in case the monitor needs to be transported.
- Authorship rights to the Monitor Settings Adjustment Disk's program are held by Sharp Corporation. Do not reproduce it without permission.

Manual Scope

- In this booklet, Microsoft Windows 2000 will be referred to as [Windows2000], Microsoft Windows Millenium as [WindowsMe], Microsoft Windows 98 as [Windows98], Microsoft Windows 95 as [Windows95], and Microsoft Windows Version 3.1 as [Windows3.1]. When there is no need to distinguish between programs, the term [Windows] will be used.
- Microsoft and Windows are registered trademarks of Microsoft Corporation.
- Macintosh is a registered trademark of Apple Computer, Inc.

Product description

Front view

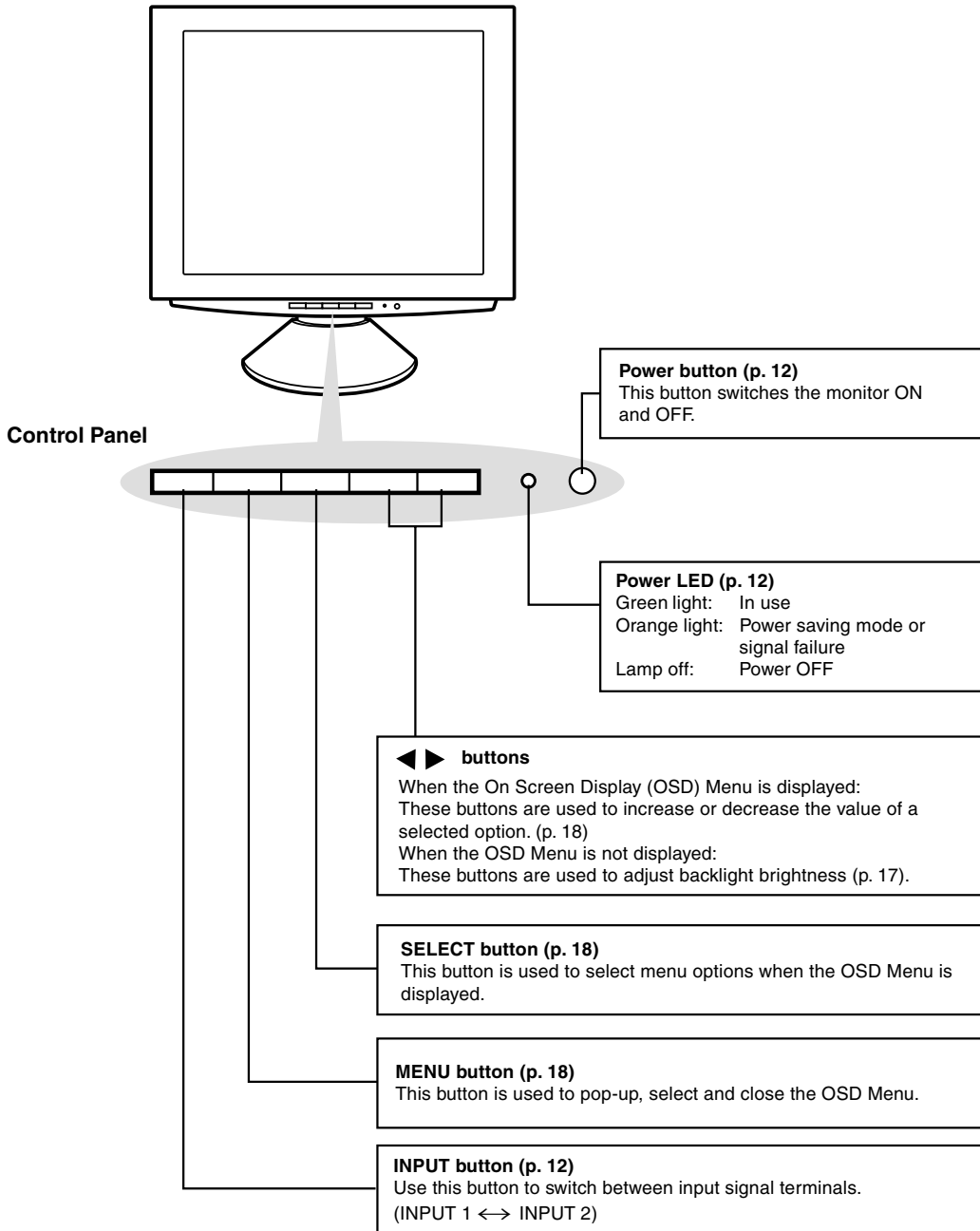

Product description

Front view

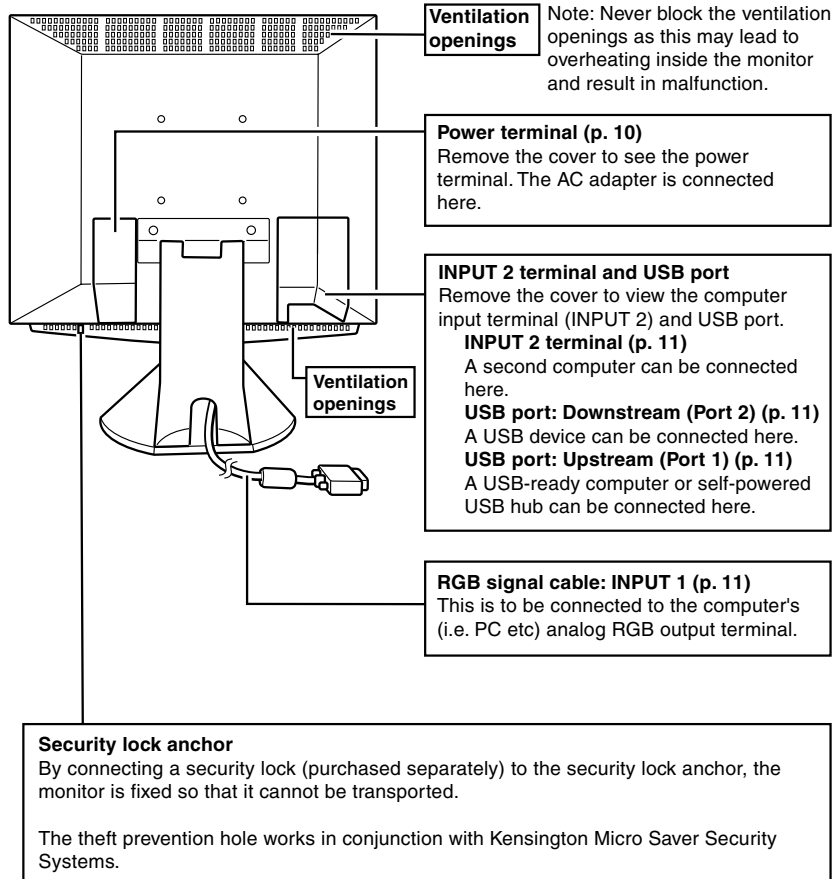

Adjusting the angle of the monitor

Lightly holding both sides of the monitor, adjust it to a suitable viewing angle.

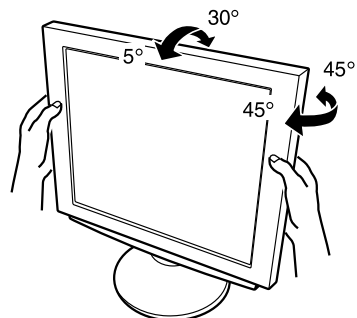

Connecting the monitor and turning the monitor on and off

Connecting the monitor to a power source

Use only the AC adapter supplied.

Note:

- Do not overly bend the cable or add extension cords as this could lead to malfunction.

1. Remove the stand cover.

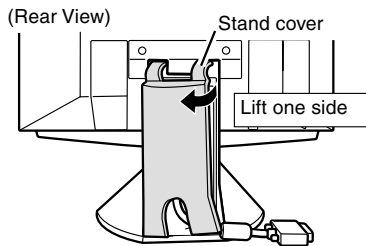

2. Remove the cover.

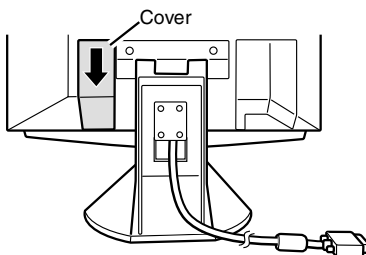

3. Connect the AC adapter to the monitor's power terminal.

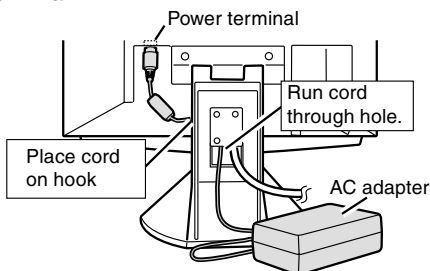

4. Replace cover.

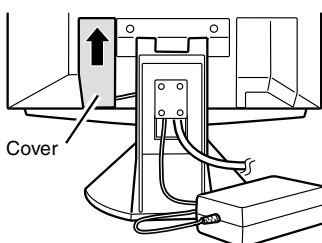

5. Connect power cord to AC adapter.

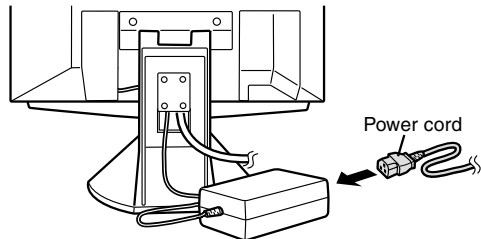

Fitting the AC adapter inside the stand

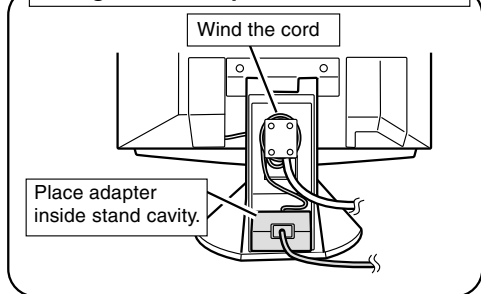

6. Replace stand cover.

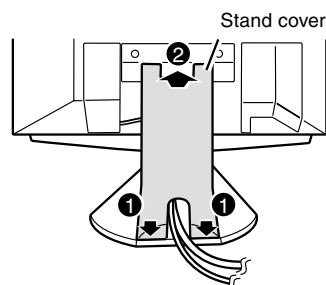

7. Place power plug into AC outlet.

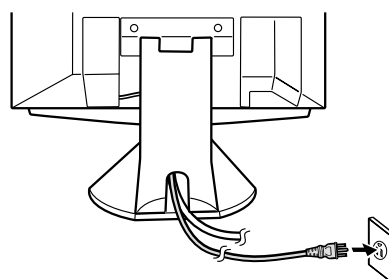

Connecting the monitor and turning the monitor on and off

Connecting the monitor to a computer (PC etc.)

When connecting, ensure that both the monitor and computer are switched off.

Note:

- Do not overly bend the cable or add extension cords as this could lead to malfunction.

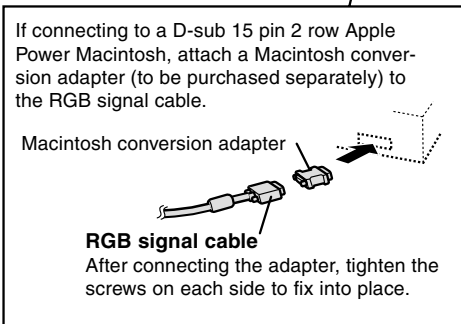
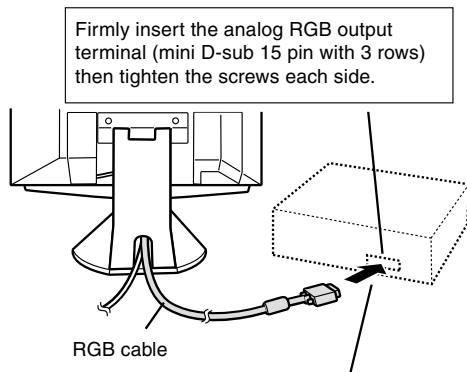

Note:

- If connecting to the Sun Ultra series, a conversion adapter (purchased separately) may be required.

Connecting to a second computer

A RGB signal cable (to be purchased separately) is needed to connect a second computer.

Note:

- Do not overly bend the cable or add extension cords as this could lead to malfunction.

1. Remove the cover

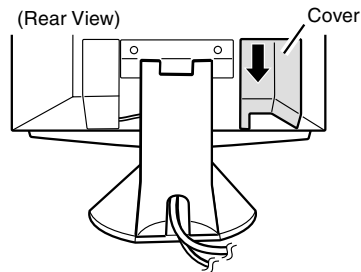

2. Connect the RGB signal cable (purchased separately) to the INPUT 2 terminal.

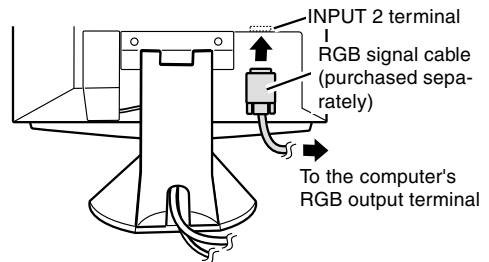

3. Replace the cover.

Connecting a USB device

This monitor can be used with hubs which use the USB standard (Rev. 1.1).

Downstream (2 ports)

USB devices such as keyboard and mouse can be connected here. Up to 100mA of power is able to be supplied per port. Devices requiring more than 100mA cannot be connected.

Upstream (1 port)

USB compatible computers and self-powered hubs can be connected. (Bus-powered hubs cannot be connected.)

Connecting the monitor and turning the monitor on and off

Notes:

- Before connecting, ensure that the shape of the USB cable connector is correct.
- For information regarding the USB function (such as set-up) please refer to the operation manual of the computer to be connected.
- Some computers, OS and other devices may not be able to be activated. To ascertain a certain device's USB compatibility, please contact the manufacturer of the device.

1. Remove the cover.

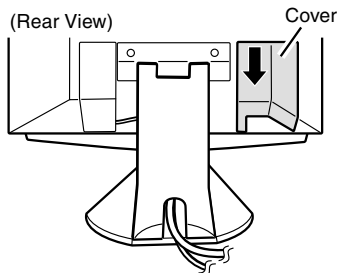

2. Plug one end of the USB cable (provided) into the monitor's USB upstream port.

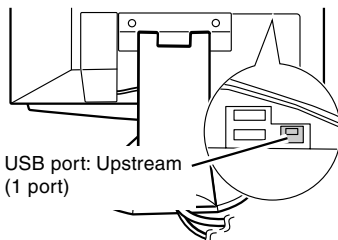

3. Connect the other end of the USB cable into the computer or the USB downstream port.
4. Plug the USB device into the monitor's USB downstream port.

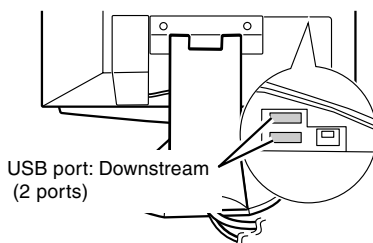

5. Replace the cover.

Turning the power on

1. Turn on the computer.
2. Press the monitor's power button. The power LED will be lit green, and the screen will display an image.

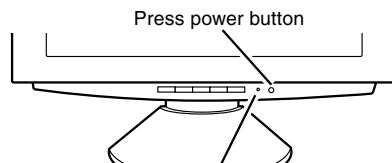

Power LED

Green light:	In use
Orange light:	Power saving mode or signal failure
Lamp off:	Power OFF

Notes:

- Depending on the computer or OS, it may be necessary to use the computer to install monitor set-up information. If so, follow the steps below to install the monitor set-up information. (p. 13)
- When setting up the monitor or a connected computer for the first time, connecting an additional computer or after having changed an aspect of the current system, perform an automatic screen adjustment before use (p. 17).

Changing between input terminals (INPUT 1 ↔ 2)

When connected to two computers, use the INPUT button to switch between input signal terminals (i.e. to choose which computer's screen you want displayed.)

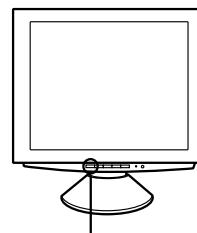

INPUT button

Pushing this button switches between input signal terminals, so that the screen changes to display any of the machines connected.

Connecting the monitor and turning the monitor on and off

Installing set-up information and the ICC profile (for Windows)

Depending on the computer or OS, it may be necessary to use the computer to operate the installation of monitor set-up information etc. If so, follow the steps below to install the monitor set-up information. (Depending on the computer type, command names and methods may differ. Please follow the computer's own operation manual while reading this.)

Note:

This explanation assumes that the floppy disk drive is "A drive". If the floppy disk drive of your computer is not "A drive", please read the below substituting the floppy disk drive you are using in place of "A drive" or "A".

About ICC profiles

An ICC (International Color Consortium) profile is a file that describes the color characteristics of the LCD monitor. By using an application that works together with an ICC profile, a high color resolution can be realized.

Notes:

- Windows 98/2000/Me use the ICC profile.
- When the storing Windows 98/2000/Me set-up information, the ICC profile is also installed. If you would like to install the ICC profile only, please refer to Installing the ICC profile on the following page.
- When using the ICC profile, please set the [WHITE BALANCE] to [STD] and set the [COLOR MODE] to [OFF].

[For Windows 95]

Installing monitor set-up information into Windows 95. This explanation assumes that the floppy disk drive is "A drive".

1. Place the Utility Disk (provided) into the computer's A drive.
2. Click on the [Start] button. From [Settings], choose [Control Panel].
3. Double click on [Display].
4. Click on [Settings], [Advanced Properties], and [Monitor], then [Change].
5. Click on [Have Disk], confirm that [Copy manufacturer's files from:] is [A:] then click [OK].
6. Confirm that the monitor details are selected, and click [OK].
7. Check that the monitor details are displayed, then click [Apply].
8. Click [OK], and close the window.
9. Remove the Utility Disk from the A drive.

[For Windows98]

Installing monitor set-up information into Windows 98, and setting the monitor's ICC profile as a predetermined value.

This explanation assumes that the floppy disk drive is "A drive".

If the "Add New Hardware Wizard" has appeared:

1. Place the Utility Disk (provided) into the computer's A drive.
2. Click [Next].
3. Check [Display a list of all the drivers in a specific location, so you can select the driver you want.], then click [Next].
4. When [Models] is displayed, click on [Have Disk], confirm that [Copy manufacturer's files from:] is [A:], and click [OK].
5. Confirm that the monitor details are selected, then click [Next], [Next], and [Finish]. If the "Add New Hardware Wizard" appears, repeat the installation commands beginning from 2 above.
6. Remove the Utility Disk from the A drive.

If the "Add New Hardware Wizard" has not appeared:

1. Place the Utility Disk (provided) into the computer's A drive.
2. Click on the [Start] button. From [Settings], choose [Control Panel].
3. Double click on [Display].
4. Click on [Settings], [Advanced] and [Monitor].
5. In [Options], check [Automatically detect Plug & Play monitors] and click on [Change].
6. Click [Next].
7. Click on [Display a list of all the drivers in a specific location, so you can select the driver you want.], then click [Next].
8. When [Models] is displayed, click on [Have Disk], confirm that [Copy manufacturer's files from:] is [A:], and click [OK].
9. Confirm that the monitor details are selected, then click [Next], [Next], and [Finish].
10. Check that the monitor details are displayed, then click [Apply].
11. Click [OK], and close the window.
12. Remove the Utility Disk from the A drive.

[For Windows2000]

Installing monitor set-up information into Windows 2000, and setting the monitor's ICC profile as a predetermined value.

This explanation assumes that the floppy disk drive is "A drive".

Connecting the monitor and turning the monitor on and off

1. Place the Utility Disk (provided) into the computer's A drive.
2. Click on the [Start] button. From [Settings], choose [Control Panel].
3. Double click on [Display].
4. Click on [Settings], [Advanced] and [Monitor].
5. Click on [Properties], [Driver] and [Update Driver].
6. When [Upgrade Device Driver Wizard] appears, click [Next].
7. Check [Display a list of the known drivers for this device so that I can choose a specific driver] and click [Next].
8. When [Models] is displayed, click on [Have disk], confirm that [Copy manufacturer's files from:] is [A:], and click [OK].
9. Select the monitor from the list displayed and click [Next].
10. Click [Next], confirm that the monitor's name appears on the screen, and click [Finish]. If [Digital Signature Not Found] appears, click [Yes].
11. Click on [Close].
12. Click [OK], and close the window.
13. Remove the Utility Disk from the A drive.

[For WindowsMe]

Installing monitor set-up information into Windows Me, and setting the monitor's ICC profile as a predetermined value.

This explanation assumes that the floppy disk drive is "A drive".

If the "Add New Hardware Wizard" has appeared:

1. Place the Utility Disk (provided) into the computer's A drive.
2. Check [Specify the location of the driver [Advanced]] and click [Next].
3. Check [Display a list of all the drivers in a specific location, so you can select the driver you want.], then click [Next].
4. When [Models] is displayed, click on [Have Disk], confirm that [Copy manufacturer's files from:] is [A:], and click [OK].
5. Select the monitor details from the list, then click [Next], [Next], and [Finish]. If the "Add New Hardware Wizard" appears, repeat the installation commands beginning from 2 above.
6. Remove the Utility Disk from the A drive.

If the "Add New Hardware Wizard" has not appeared:

1. Place the Utility Disk (provided) into the computer's A drive.
2. Click on the [Start] button. From [Settings], choose [Control Panel].
3. Double click on [Display].
4. Click on [Settings], [Advanced] and [Monitor].
5. In [Options], check [Automatically detect Plug & Play monitors] and click on [Change].
6. Check [Specify the location of the driver [Advanced]] and click [Next].
7. Check [Display a list of all the drivers in a specific location, so you can select the driver you want.] and click [Next].
8. When [Models] is displayed, click on [Have Disk], confirm that [Copy manufacturer's files from:] is [A:], and click [OK].
9. Select the monitor details, then click [Next], [Next], and [Finish].
10. Check that the monitor details are displayed, then click [Apply].
11. Click [OK], and close the window.
12. Remove the Utility Disk from the A drive.

[Installing the ICC profile]

Installing the monitor's ICC profile. (If the set-up information has already been installed, so too has the profile, and there is no need to install it.)

This explanation assumes that the floppy disk drive is "A drive".

1. Place the Utility Disk (provided) into the computer's A drive.
2. Click on the [Start] button. From [Settings], choose [Control Panel].
3. Double click on [Display].
4. Click on [Settings] and [Advanced].
5. Click on [General] and from [Compatibility] select [Apply the new display settings without restarting], then click on [Color Management].
6. Click [Add], and select [3 ½ Floppy [A:]] as the file location.
7. Choose the color profile that you would like to install, and click on [Add].
8. Choose the profile and click on [Set As Default].
9. Click [OK], and close the window.
10. Remove the Utility Disk from the A drive.

When using the ICC profile, please set the [WHITE BALANCE] to [STD] and set the [COLOR MODE] to [OFF].

Connecting the monitor and turning the monitor on and off

Installing ColorSync profile (for MacOs)

About ColorSync profiles

ColorSync is the color management system of Apple Computer, Inc. ColorSync is the function to realize color reappearance with the application which coped with it. A ColorSync profile is a file that describes the color characteristics of the LCD monitor.

Notes:

- The ColorSync profile of this opportunity copes with it after MacOS8.5.
- When using the ColorSync profile, please set the [WHITE BALANCE] to [STD] and set the [COLOR MODE] to [OFF].

Setting ColorSync profile

- **A floppy disk drive is necessary.** And, "PC Exchange" or "File Exchange" must be installed in the system.
 - Depending on the computer or OS, command names and methods may differ. Please follow the computer's own operation manual while reading this.
1. Place the Utility Disk (provided) into the computer's floppy disk drive.
 2. The profile used is copied onto the ColorSync profile folder in the system folder.
 3. The profile used is chosen with ColorSync of the control panel.

Turning the power off

1. Turn the computer off.
2. Press the monitor's power button.
The Power LED will disappear.

CAUTION!

Do not leave the monitor in contact with rubber or plastic items for long periods of time as this could lead to color change or change in shape.

Adjusting the screen display

If necessary, the screen can be adjusted as follows.

Automatic screen adjustment (p. 17)

The CLOCK, PHASE, H-POS (horizontal positioning) and V-POS (vertical positioning) functions can be adjusted automatically.

Adjustment of backlight (p. 17)

Brightness of backlight can be adjusted.

Manual adjustment (p. 18)

Fine adjustments can be made using the On Screen Display (OSD) Menu.

Note:

- All adjustments will be saved even after turning the power off.

Useful functions and tips

Resetting MENU 1 (ADJUSTMENT)

MENU 1 (ADJUSTMENT) values can be returned to their original ex-factory values in one command.

1. Turn on the monitor power.
2. Press the MENU button and the ◀ button simultaneously. When [RESET] appears on the screen, the reset is complete.

Resetting all adjustment values

All adjustment values can be returned to their original ex-factory values in one command.

1. Turn off the monitor power.
2. Press the MENU button and the SELECT button simultaneously, and while doing this press the power button (i.e. turn the power on). When [ALL RESET] appears on the screen, the reset is complete.

Note:

- While ALL RESET is displayed, the control buttons are disabled.
- It is not possible to reset values when the adjustment lock is in place. Remove the adjustment lock before attempting to operate control buttons.

Adjustment lock function

By disabling the control buttons (i.e. setting the lock) any attempted changes to adjusted values will be voided.

1. Turn off the monitor power.
2. While pressing the MENU button, press the power button (i.e. turn the power on).
When the menu is unlocked:
[ADJUSTMENT LOCKED] will appear on the screen, and the lock will be set.
When the menu is locked:
[ADJUSTMENT UNLOCKED] will appear on the screen, and the lock will be removed.

Note:

- When the lock is in place, all buttons other than the power button are disabled.

Choosing a message language

Messages displayed on the screen and OSD Menu contents can be changed to the following languages. Dutch, English, French, German, Spanish, Italian, Swedish.

1. Turn off the monitor.
2. Pressing the ◀ and ▶ buttons simultaneously, press the power button (i.e. turn the power on).
The Language Selection Menu (LANGUAGE) will be displayed on the screen.
3. Use the SELECT button to choose a language.
4. Press the MENU button.
The setting is complete. From now, messages and adjustment menus will be displayed in the chosen language.

Adjusting the screen display

Automatic screen adjustment

Options in MENU 1 (ADJUSTMENT) can be adjusted automatically (CLOCK, PHASE, H-POS, V-POS).

Note:

- When setting up the monitor or a connected computer for the first time, connecting an additional computer or after having changed an aspect of the current system, perform an automatic screen adjustment before use

Automatic adjustment screen display

To perform an automatic adjustment, first display an image that makes the entire screen very bright. If you are using Windows, you can also use the Adjustment Pattern on the accompanying Utility Disk for Windows.

Displaying the Adjustment Pattern (for Windows)

This explanation is for Windows 95/98/2000/Me, and assumes that the floppy disk drive is [A drive].

Note:

- If the floppy disk drive of your computer is not "A drive", please read the below substituting the floppy disk drive you are using in place of "A drive" or "A".
1. Place the Utility Disk (provided) into the computer's A drive.
 2. Open [My Computer] and select [3 ½ Floppy (A:)]. If using Windows 3.1, open [File Manager] and choose "A drive".
 3. Double click on [Adj_uty.exe] to run the Adjustment Program. The Adjustment Pattern will appear.

Adjustment pattern

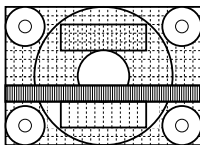

Notes:

- After completing the adjustment, press the computer's [Esc] key to exit the Adjustment Program.
- If your computer's display mode is set to 65K colors, you may see the different color levels in each color pattern or the gray scale may look colored. (This is due to the input signal specification and is not a malfunction.)

Adjusting the screen automatically

1. Press the MENU button.
The ADJUSTMENT Menu will be displayed.

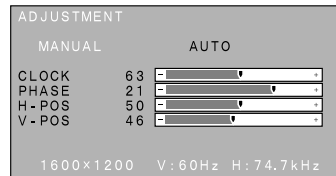

2. Press the ► button.
The screen will become dark and [ADJUSTING] will be displayed. After a few seconds the ADJUSTMENT Menu will return. (The automatic adjustment is now complete.)
3. Press the MENU button 4 times to make the On Screen Display (OSD) Menu disappear.

Notes:

- In most cases the monitor is ready to be used after automatic adjustment.
- If necessary due to any of the following, manual adjustments (p. 18) can be made after the automatic adjustment.
 - When further fine adjustment is needed.
 - When the computer's video input signals are Composite Sync or Sync On Green. (Automatic adjustments may not be possible.)
 - When [OUT OF ADJUST] is displayed. (When the screen displays an entirely dark image, the automatic screen adjustment may be disabled. When making an automatic adjustment, be sure to either use the Adjustment Pattern or try displaying an image that makes the entire screen very bright.)

Adjusting the backlight

The backlight brightness can be adjusted.

Carry out the commands without the On Screen Display (OSD) Menu displayed. If the OSD Menu is displayed, press the MENU button (several times may be required) and begin when the OSD Menu has disappeared.

1. Without the OSD Menu being displayed, push the ◀ or the ► button. At the bottom of the screen the BRIGHT bar will appear.



2. Adjust by pressing the ◀ button (darker) or ► button (lighter).

The BRIGHT bar automatically disappears several seconds after the last command.

Adjusting the screen display

Manual screen adjustment

Fine adjustments can be made using the On Screen Display (OSD) Menu provided.

The screen display during adjustment

If using Windows, the Adjustment Pattern on the accompanying Utility Disk for Windows can be used. (p. 17)

If using a computer other than Windows, the adjustment pattern cannot be used. Display an image that makes the entire screen very bright, and adjust while watching the screen.

Note:

- This explanation is based on using the Adjustment Pattern (for Windows) to make adjustments.

Adjusting

1. Press the MENU button. The ADJUSTMENT Menu will be displayed.

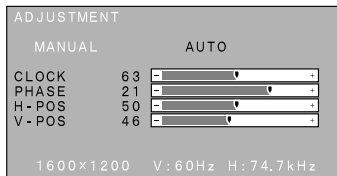

At this point relevant menu options can be adjusted. Each time the MENU button is pressed, the next menu is selected. (MENU 1 → 2 → 3 → 4 → OSD Menu disappears)

Note:

- The OSD Menu automatically disappears approximately 20 seconds after the last command.

MENU 1: ADJUSTMENT

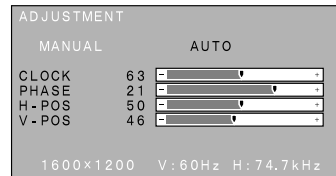

MANUAL: Individual menu options are manually adjusted.

AUTO: Every menu option is automatically adjusted

Notes:

- Press the ► button to select AUTO.
- To choose a menu option: SELECT button
- To go to MENU 2: MENU button

CLOCK

The figure below demonstrates how to adjust so that vertical flicker noise is not emitted. (◀▶ buttons)

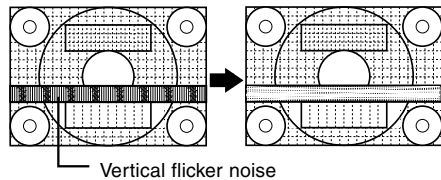

PHASE

The figure below demonstrates how to adjust so that horizontal flicker noise is not emitted. (◀▶ buttons)

Note:

- Adjustments to PHASE should be made only after CLOCK has been correctly set.

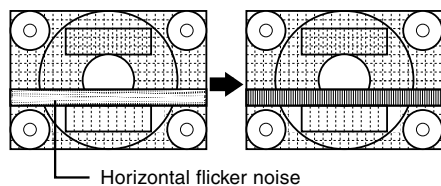

H-POS (horizontal positioning) and V-POS (vertical positioning)

To center the screen image within the boundaries of the screen, adjust the left-right (H-POS) values and the up-down (V-POS) values. (◀▶ buttons)

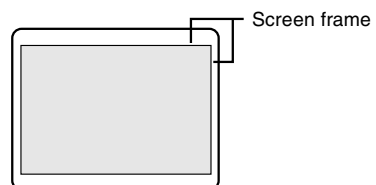

Adjusting the screen display

MENU 2: GAIN CONTROL

BRIGHT (brightness) and CONT (contrast) are optimized before shipment, but depending on the type of computer being used, further adjustment may be necessary.

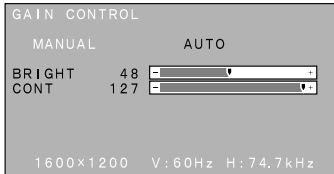

MANUAL: Individual menu options are manually adjusted.

AUTO: Every menu option is automatically adjusted using the Auto Gain Control* function,

Notes:

- Press the ► button to select AUTO.
- To choose a menu option: SELECT button
- To go to MENU 3: MENU button

***Auto Gain Control function**

The Auto Gain Control adjusts contrast and brightness based on the brightest color of the image displayed. If you are not using the Adjustment Pattern it is necessary to have an area of at least 5 mm x 5 mm of white image displayed, and if not adjustments may not be possible. (In such case, [OUT OF ADJUST] will appear and setting values remain unchanged.)

BRIGHT (brightness)

Total screen brightness can be adjusted while watching the color pattern. (◀▶ buttons)

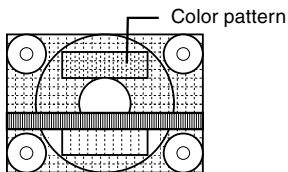

CONT (Contrast)

While watching the color pattern, adjustments can be made so that all graduations appear. (◀▶ buttons)

MENU 3: WHITE BALANCE

WHITE BALANCE can be adjusted as necessary. (As adjustments are made before shipment, there is no real necessity for further alteration.)

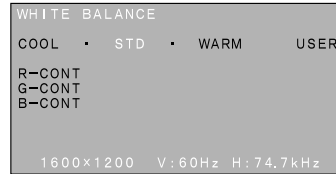

Notes:

- On settings other than [STD] not all graduations can be displayed. To display all graduations, set to STD.
- Selecting USER will display the setting values for R-CONT, G-CONT and B-CONT, enabling fine adjustments.
- To choose a menu option: SELECT button
- To go to MENU 4: MENU button

COOL . . . Color tone bluer than standard

- Color tone slightly bluer than standard

STD Color tone standard setting

- Color tone slightly redder than standard

WARM . . . Color tone redder than standard

USER

R-CONT ◀ button for blue-green
 ▶ button for red

G-CONT ▶ button for purple
 ◀ button for green

B-CONT ◀ button for yellow
 ▶ button for blue

Adjusting the screen display

MENU 4: MODE SELECT

The resolution can be adjusted

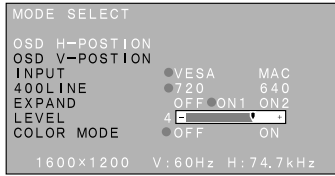

Notes:

- To choose a menu option: SELECT button
- When adjustment complete: MENU button

OSD H-POSITION (OSD horizontal position)

The position of the OSD display can be moved to the left and right. (◀▶ buttons)

OSD V-POSITION (OSD vertical position)

The position of the OSD display can be moved up and down. (◀▶ buttons)

INPUT (Input mode)

The input mode can be set (◀▶ buttons)

VESA: VESA mode

MAC: Power Macintosh mode

400 LINES (degree of resolution)

You can specify the horizontal resolution of a 400-line screen when using US text, etc. (◀▶ buttons)

640 640 X 400 dot mode

720 720 X 400 dot mode (US text etc.)

Note:

- As the resolution input for other than 400 lines is done automatically, there is no need to set it.

EXPAND (Screen expansion)

For display modes of less than 1600 X 1200 pixels, the display can be expanded if desired.

(◀▶ buttons)

OFF It doesn't expand.

ON1 It expands by the aspect ratio fixation.

ON2 It spreads throughout the whole of the screen.

Notes:

- Display modes of 1600 X 1200 pixels cannot be changed.
- If a resolution of 1600 X 1200 pixels cannot be achieved even after expansion is attempted, the screen's perimeter will display black. (This is not a malfunction.)

LEVEL (Level of scaling)

When EXPAND is ON1 or ON2, the sharpness of the image can be adjusted. (◀▶ buttons)

Note:

- When EXPAND is OFF, no adjustments can be made.

COLOR MODE

OFF It is indicated in the color of the LCD monitor origin.

ON It is corrected in the more suitable color, and indicated in the computer image.

Note:

- Set up WHITE BALANCE in STD when you turn on COLOR MODE.

Monitor care and repair

Monitor care

Always remove the plug from the AC outlet when cleaning the monitor.

Cabinet and control panel section

Use a soft dry cloth to lightly wipe away any grime from the cabinet and control panel.

If they are very dirty, apply neutral detergent to a dampened soft cloth, wring it out well and wipe away grime.

LCD panel section

Use a soft dry cloth to lightly wipe away dirt and dust from the surface of the LCD panel. (A soft cloth such as gauze or that used for lens cleaning is suitable.)

CAUTION!

- Never use thinner, benzine, alcohol, glass cleaner, etc, as this could lead to color change or change in shape.
- Never scratch the monitor with anything hard or apply strong pressure as this could leave marks or result in malfunction.

Storage

If the monitor will not be used for a long period of time, be sure to remove the power plug from the AC outlet.

CAUTION!

Do not leave the monitor in contact with rubber or plastic items for long periods of time as this could lead to color change or change in shape.

Troubleshooting

If you think the monitor may be faulty, please check the following points before taking it to be repaired. If afterwards it still does not work, please contact the shop where you purchased the monitor or your nearest Sharp authorized Service Center.

The monitor's florescent tubes have a limited life span.

- If the screen darkens, persistently flickers or does not light up, it may be necessary to replace the florescent tube unit. Please inquire at the shop where you purchased the monitor or your nearest Sharp authorized Service Center. (Never attempt this replacement on your own.)
- In the initial period of use, due to the characteristics of florescent tubes the screen may flicker. (This is not a malfunction.) Should this happen, check by first turning off the power, then turning it on again.

No image appears on the monitor (Power LED is not lit)

- Are the AC adapter and power cord connected properly? (p. 10)

No image appears on the monitor (Power LED is lit)

- Try pressing the INPUT button to switch between incoming power terminals. (p. 12)
- Is the computer connected properly? (p. 11)
- Is the computer turned on?
- Does the computer's signal timing correspond to monitor specifications? (p. 23)
- Is the computer in power-saving mode?

Control buttons do not work

- Is the adjustment lock on? (p. 16)

Only VGA image is displayed

- Does the Windows display timing setting meet monitor specifications? Refer to the monitor signal timings (p. 23) and set to appropriate timing.

The image appears distorted

- Does the computer's signal timing correspond to monitor specifications? (p. 23)
- Perform automatic adjustment. (p. 17)

Specifications

Product specifications

- LCD display
 - 19.6 inches (50 cm measured diagonally)
 - Super High resolution and Anti Glare Low Reflection TFT LCD module
- Resolution (max.)
 - UXGA 1600 x 1200 pixels
- Displayable colors (max.)
 - 16.77 million colors (8 bit)
- Brightness (max.)
 - 200cd/m²
- Dot pitch
 - 0.249(H) 0.249(V) mm
- Contrast ratio
 - 300:1
- Angle of visibility
 - Left-right 150°; Up-down 150°
- Screen display size
 - Horizontal 398.4 mm x Vertical 298.8 mm
- Video signal
 - Analog RGB (0.7Vp-p) [75Ω]
- Sync signal
 - Separate Sync (TTL level: +/-), Sync on Green, Composite Sync (TTL level: +/-)
- Expansion compensation
 - Digital screening (enlargement of display to correct VGA/SVGA/XGA/SXGA)
- Plug & Play
 - VESA: DDC1/DDC2B compatible
- Power management
 - VESA: based on DPMS
- Computer signal input terminal
 - 2 x 15 pin mini D-sub (3 rows)
- USB hub function
 - 1 upstream port, 2 downstream ports (bus-powered hub based on USB standard Rev 1.1)
- Screen tilt
 - Upward 0° -30°; downward 0° - 5°
- Screen swivel
 - 90° from left through right
- Power supply
 - AC100-240V (Use special AC adapter)
- Temperature of operating environment
 - 5 - 35°C
- Power consumption
 - 48W max. (3.5W when in power-saving mode)
- Dimensions (W x D x H, excluding rubber base)
 - 483 mm x 218 mm x 478 mm
- Weight
 - Approx. 10.5 kg (excluding AC adapter)

Dimensions (Units: mm)

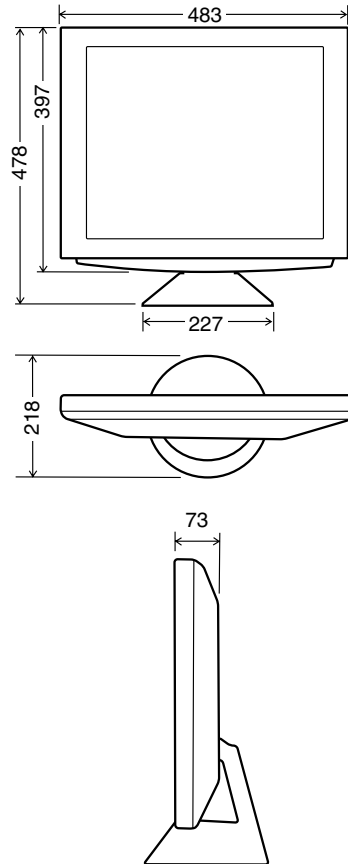

Specifications

Signal timings

Display mode	Hsync	Vsync	Dot frequency		
VESA	640x480	31.5kHz	60.0Hz	25.175MHz	
		37.9kHz	72.0Hz	31.5MHz	
		37.5kHz	75.0Hz	31.5MHz	
		43.3kHz	85.0Hz	36.0MHz	
	640x400	37.9kHz	85.0Hz	31.5MHz	
		720x400	37.9kHz	85.0Hz	35.5MHz
		800x600	35.1kHz	56.0Hz	36.0MHz
			37.9kHz	60.0Hz	40.0MHz
			48.1kHz	72.0Hz	50.0MHz
			46.9kHz	75.0Hz	49.5MHz
	1024x768	53.7kHz	85.0Hz	56.25MHz	
		48.4kHz	60.0Hz	65.0MHz	
		56.5kHz	70.0Hz	75.0MHz	
		60.0kHz	75.0Hz	78.75MHz	
	1152x864	68.7kHz	85.0Hz	94.5MHz	
		67.5kHz	75.0Hz	108.0MHz	
	1280x960	60.0kHz	60.0Hz	108.0MHz	
		85.9kHz	85.0Hz	148.5MHz	
1280x1024	64.0kHz	60.0Hz	108.0MHz		
	80.0kHz	75.0Hz	135.0MHz		
	91.1kHz	85.0Hz	157.5MHz		
1600x1200	75.0kHz	60.0Hz	162.0MHz		
US TEXT	720x400	31.5kHz	70.0Hz	28.3MHz	
Power Macintosh series	640x480	35.0kHz	66.7Hz	30.2MHz	
	832x624	49.7kHz	74.6Hz	57.3MHz	
	1024x768	60.2kHz	75.0Hz	80.0MHz	
	1152x870	68.7kHz	75.0Hz	100.0MHz	
		64.0kHz	60.0Hz	108.0MHz	
		80.0kHz	75.0Hz	135.0MHz	
1280x1024	91.1kHz	85.0Hz	157.5MHz		
	75.0kHz	60.0Hz	162.0MHz		
Sun Ultra series	1024x768	48.3kHz	60.0Hz	64.13MHz	
		53.6kHz	66.0Hz	70.4MHz	
		56.6kHz	70.0Hz	74.25MHz	
	1152x900	61.8kHz	66.0Hz	108.01MHz	
		71.8kHz	76.1Hz	117.01MHz	
	1280x1024	71.7kHz	67.2Hz	117.01MHz	
		81.1kHz	76.0Hz	134.99MHz	
	1600x1000	68.6kHz	66.0Hz	135.76MHz	

The connector pin

Input connector diagram (Mini D-sub connector with 15 pins)

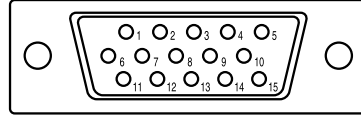

Number	Function
1	Red video signal input
2	Green video signal input
3	Blue video signal input
4	GND
5	GND
6	For red video signal GND
7	For green video signal GND
8	For blue video signal GND
9	N.C.
10	GND
11	GND
12	DDC data
13	For Hsync signal input
14	For Vsync signal input
15	DDC clock

Notes:

- All are compliant only with non-interlace.
- Frequencies for Power Macintosh and the Sun Ultra series are reference values.
- If the monitor is receiving timing signals that are not compatible, [OUT OF TIMING] will appear. Follow your computer's instruction manual to set the timing to be compatible with the monitor.
- If the monitor is not receiving any signal (synch signal), [NO SIGNAL] will appear.

Specifications

Standards and compatibility

Power management

The monitor is based on VESA DPMS (Display Power Management Signaling).

To activate the monitor's Power Management function, both the video card and the computer must conform to the VESA DPMS standard.

DPMS mode	Screen	Power consumption	H-sync	V-sync
ON	Display on	48W	Yes	Yes
STANDBY	Display off	Less than 3.5W	No	Yes
SUSPEND			Yes	No
OFF			No	No

DDC (Plug & Play)

This monitor supports the VESA DDC (Display Data Channel) standard.

DDC is a signal standard for carrying out Plug & Play functions on the monitor or PC. It transfers information such as degree of resolution between the monitor and PC. You can use this function if your PC is DDC compliant and if it is set so that it can detect the Plug & Play monitor.

There are many varieties of DDC due to the differences between systems. This monitor works with DDC1 and DDC2B.

Instructions for attaching a VESA compliant arm

An arm or stand based on the VESA standard (purchased separately) can be attached to the monitor.

Procurement of the arm or stand is at the customer's discretion.

Arms or stands able to be used

Attachments must satisfy the following.

- Compatible with the VESA standard
- Have a gap of at least 100 mm x 100 mm between the screw holes on the section to be attached
- Not be likely to fall off or break off after being attached to the monitor.

How to attach the arm or stand

Note:

- While following these instructions, please also refer to the installation instructions in the operation manual included with the arm or stand
- Do not overly bend the cable or add extension cords as this could lead to malfunction.

1. Spread out a soft cloth on a suitable horizontal surface.
2. Being careful not to damage the monitor, gently lay the monitor on it display-side down.

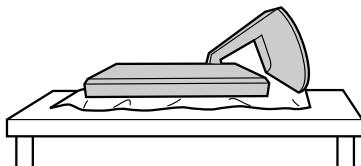

3. Remove the stand cover.

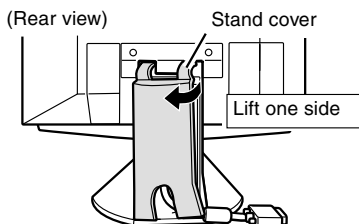

4. Remove the two screws, and remove the cover.

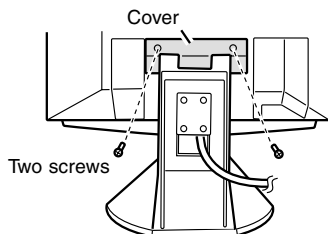

5. Remove the four screws and then remove the stand from the monitor.

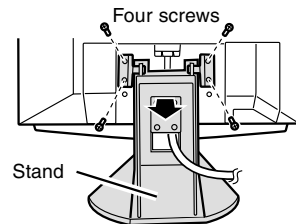

6. Attach the arm to the monitor with the four screws.

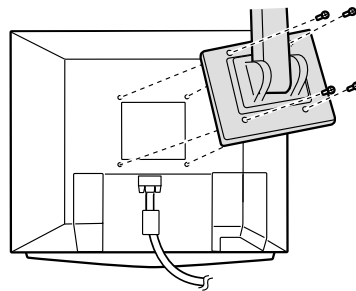

The screws used to attach the arm should be M4 screws with a length of 8 mm ~ 10 mm protruding from the surface to be attached. Using any other kind of screw may lead to the monitor falling off or damage to the internal part of the monitor

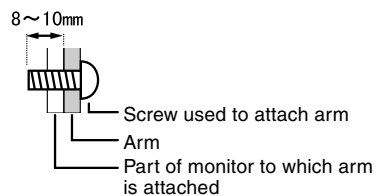

Memo

Memo

SHARP®
SHARP CORPORATION

© 2001 SHARP CORPORATION

Free Manuals Download Website

<http://myh66.com>

<http://usermanuals.us>

<http://www.somanuals.com>

<http://www.4manuals.cc>

<http://www.manual-lib.com>

<http://www.404manual.com>

<http://www.luxmanual.com>

<http://aubethermostatmanual.com>

Golf course search by state

<http://golfingnear.com>

Email search by domain

<http://emailbydomain.com>

Auto manuals search

<http://auto.somanuals.com>

TV manuals search

<http://tv.somanuals.com>