

SHARP®



OPERATION MANUAL MODEL **XG-PH50X** (Standard zoom lens attached)

XG-PH50X-NL (No lens attached)

MULTIMEDIA PROJECTOR

Conference Series



香港電器安全規格
(國際電工委員會規格適合)



Introduction

Quick Start

Setup

Connections

Basic Operation

Useful Features

Appendix

IMPORTANT

For your assistance in reporting the loss or theft of your Projector, please record the Serial Number located on the bottom of the projector and retain this information. Before recycling the packaging, please ensure that you have checked the contents of the carton thoroughly against the list of "Supplied accessories" on page 11.

Model No.:

Serial No.:

This apparatus complies with the requirements of Council Directives 89/336/EEC and 73/23/EEC as amended by Council Directive 93/68/EEC.

Dieses Gerät entspricht den Anforderungen der EG-Richtlinien 89/336/EWG und 73/23/EWG mit Änderung 93/68/EWG.

Ce matériel répond aux exigences contenues dans les directives 89/336/CEE et 73/23/CEE modifiées par la directive 93/68/CEE.

Dit apparaat voldoet aan de eisen van de richtlijnen 89/336/EEG en 73/23/EEG, gewijzigd door 93/68/EEG.

Dette udstyr overholder kravene i direktiv nr. 89/336/EEC og 73/23/EEC med tillæg nr. 93/68/EEC.

Quest' apparecchio è conforme ai requisiti delle direttive 89/336/EEC e 73/23/EEC, come emendata dalla direttiva 93/68/EEC.

Αυτή η συσκευή συμμορφώνεται με τις απαιτήσεις των οδηγιών του Συμβουλίου 89/336/EOK και 73/23/EOK όπως τροποποιήθηκαν από την οδηγία του Συμβουλίου 93/68/EOK.

Este equipamento obedece às exigências das directivas 89/336/CEE e 73/23/CEE, na sua versão corrigida pela directiva 93/68/CEE.

Este aparato satisface las exigencias de las Directivas 89/336/CEE y 73/23/CEE, modificadas por medio de la 93/68/CEE.

Denna utrustning uppfyller kraven enligt riktlinjerna 89/336/EEC och 73/23/EEC så som kompletteras av 93/68/EEC.

Dette produktet oppfyller betingelsene i direktivene 89/336/EEC og 73/23/EEC i endringen 93/68/EEC.

Tämä laite täyttää direktiivien 89/336/EEC ja 73/23/EEC vaatimukset, joita on muutettu direktiivillä 93/68/EEC.

Bu cihaz Konsey Direktifi 93/68/EEC tarafından düzeltilen 89/336/EEC ve 73/23/EEC Konsey Direktiflerinin gerekliliklerine uygundur.

Tento přístroj je v souladu s požadavky směrnic rady 89/336/EEC a 73/23/EEC, tak jak byly upraveny směrnicí rady 93/68/EEC.

See seade on vastavuses Nõukogu Direktiivis nr 89/336/EEC ja 73/23/EEC esitatud nõuetega, vastavalt Nõukogu Direktiivis nr 93/68/EEC esitatud parandustele

Ez a készülék megfelel a Tanács által kiadott, 89/336/EGK és 73/23/EGK Irányelveknek és az utóbbi módosító 93/68/EGK Irányelvnek

Ši ierice atbilst tehnikam prasibam pec 89/336/EEC un 73/23/EEC direktivam papildinats ar direktivu 93/68/EEC.



Šis prietaisas atitinka ES Tarybos direktyvu 89/336/EEC ir 73/23/EEC patikslintos direktyvos 93/68/EEC reikalavimus.

To urządzenie spełnia wymagania dyrektyw 89/336/EEC i 73/23/EEC wraz z poprawkami dyrektywy 93/68/EEC.

Tento přístroj je v súlade s požiadavkami smerníc rady 89/336/EEC a 73/23/EEC tak ako boli upravené smernicou rady 93/68/EEC.

Ta aparat je v skladu z zahtevami Direktiv Sveta 89/336/EEC in 73/23/EEC kot je navedeno v dopolnilu k Direktivi Sveta 93/68/EEC.

SPECIAL NOTE FOR USERS IN THE U.K.

The mains lead of this product is fitted with a non-rewireable (moulded) plug incorporating a 13A fuse. Should the fuse need to be replaced, a BSI or ASTA approved BS 1362 fuse marked  or  and of the same rating as above, which is also indicated on the pin face of the plug, must be used.

Always refit the fuse cover after replacing the fuse. Never use the plug without the fuse cover fitted.

In the unlikely event of the socket outlet in your home not being compatible with the plug supplied, cut off the mains plug and fit an appropriate type.

DANGER:

The fuse from the cut-off plug should be removed and the cut-off plug destroyed immediately and disposed of in a safe manner.

Under no circumstances should the cut-off plug be inserted elsewhere into a 13A socket outlet, as a serious electric shock may occur.

To fit an appropriate plug to the mains lead, follow the instructions below:

WARNING:

THIS APPARATUS MUST BE EARTHED.

IMPORTANT:

The wires in this mains lead are coloured in accordance with the following code:

Green-and-yellow : Earth
Blue : Neutral
Brown : Live

As the colours of the wires in the mains lead of this apparatus may not correspond with the coloured markings identifying the terminals in your plug proceed as follows:

- The wire which is coloured green-and-yellow must be connected to the terminal in the plug which is marked by the letter E or by the safety earth symbol  or coloured green or green-and-yellow.
- The wire which is coloured blue must be connected to the terminal which is marked with the letter N or coloured black.
- The wire which is coloured brown must be connected to the terminal which is marked with the letter L or coloured red.

IF YOU HAVE ANY DOUBT, CONSULT A QUALIFIED ELECTRICIAN.

The supplied CD-ROM contains operation instructions in English, German, French, Swedish, Spanish, Italian, Dutch, Portuguese, Chinese (Traditional Chinese and Simplified Chinese), Korean and Japanese. Carefully read through the operation instructions before operating the projector.

Die mitgelieferte CD-ROM enthält Bedienungsanleitungen in Englisch, Deutsch, Französisch, Schwedisch, Spanisch, Italienisch, Niederländisch, Portugiesisch, Chinesisch (Traditionelles Chinesisch und einfaches Chinesisch), Koreanisch und Japanisch. Bitte lesen Sie die Bedienungsanleitung vor der Verwendung des Projektors sorgfältig durch.

Le CD-ROM fourni contient les instructions de fonctionnement en anglais, allemand, français, suédois, espagnol, italien, néerlandais, portugais, chinois (chinois traditionnel et chinois simplifié), coréen et japonais. Veuillez lire attentivement ces instructions avant de faire fonctionner le projecteur.

Den medföljande CD-ROM-skivan innehåller bruksanvisningar på engelska, tyska, franska, svenska, spanska, italienska, holländska, portugisiska, kinesiska (traditionell kinesiska och förenklad kinesiska), koreanska och japanska. Läs noga igenom bruksanvisningen innan projektorn tas i bruk.

El CD-ROM suministrado contiene instrucciones de operación en inglés, alemán, francés, sueco, español, italiano, holandés, portugués, chino (chino tradicional y chino simplificado), coreano y japonés. Lea cuidadosamente las instrucciones de operación antes de utilizar el proyector.

Il CD-ROM in dotazione contiene istruzioni per l'uso in inglese, tedesco, francese, svedese, spagnolo, italiano, olandese, portoghese, cinese (cinese tradizionale e cinese semplificato), coreano e giapponese. Leggere attentamente le istruzioni per l'uso prima di usare il proiettore.

De meegeleverde CD-ROM bevat handleidingen in het Engels, Duits, Frans, Zweeds, Spaans, Italiaans, Nederlands, Portugees, Chinees (Traditioneel Chinees en Vereenvoudigd Chinees), Koreaans en Japans. Lees de handleiding zorgvuldig door voor u de projector in gebruik neemt.

O CD-ROM fornecido contém instruções de operação em Inglês, Alemão, Francês, Sueco, Espanhol, Italiano, Holandês, Português, Chinês, (Chinês Tradicional e Chinês Simplificado), Coreano e Japonês. Leia cuidadosamente todas as instruções de operação antes de operar o projetor.

附送之CD-ROM光碟中，有用英文、德文、法文、瑞典文、西班牙文、意大利文、荷蘭文、葡萄牙文、中文（繁體中文和簡體中文）、韓國文和日文所寫的使用說明書。在操作本投影機之前，請務必仔細閱讀整本使用說明書。

附送之CD-ROM光碟中，有用英文、德文、法文、瑞典文、西班牙文、意大利文、荷兰文、葡萄牙文、中文（繁体中文和简体中文）、韩国文和日文所写的使用说明书。在操作本投影机之前，请务必仔细阅读整本使用说明书。

제공된 CD-ROM에는 영어, 독일어, 프랑스어, 스웨덴어, 스페인어, 이탈리아어, 네덜란드어, 포르투갈어, 중국어(번체자와 간체자), 한국어, 일본어로 작성된 조작 설명서가 수록되어 있습니다. 프로젝터를 조작하기 전에 조작 지침을 상세하게 숙지하십시오.

本機に付属のCD-ROMには、英語・ドイツ語・フランス語・スウェーデン語・スペイン語・イタリア語・オランダ語・ポルトガル語・中国語（繁体字・簡体字）・韓国語・日本語の取扱説明書が収録されています。本機をご使用の前に、この取扱説明書をよくお読みください。

Before using the projector, please read this operation manual carefully.

Introduction

ENGLISH

There are two important reasons for prompt warranty registration of your new SHARP Projector, using the REGISTRATION CARD packed with the projector.

1. WARRANTY

This is to assure that you immediately receive the full benefit of the parts, service and labor warranty applicable to your purchase.

2. CONSUMER PRODUCT SAFETY ACT

To ensure that you will promptly receive any safety notification of inspection, modification, or recall that SHARP may be required to give under the 1972 Consumer Product Safety Act, PLEASE READ CAREFULLY THE IMPORTANT "LIMITED WARRANTY" CLAUSE.

U.S.A. ONLY

WARNING: High brightness light source. Do not stare into the beam of light, or view directly. Be especially careful that children do not stare directly into the beam of light.



WARNING: To reduce the risk of fire or electric shock, do not expose this product to rain or moisture.

See bottom of projector.

	CAUTION RISK OF ELECTRIC SHOCK. DO NOT REMOVE SCREWS EXCEPT SPECIFIED USER SERVICE SCREW.	
CAUTION: TO REDUCE THE RISK OF ELECTRIC SHOCK, DO NOT REMOVE COVER. NO USER-SERVICEABLE PARTS EXCEPT LAMP UNIT. REFER SERVICING TO QUALIFIED SERVICE PERSONNEL.		



The lightning flash with arrowhead symbol, within an equilateral triangle, is intended to alert the user to the presence of uninsulated "dangerous voltage" within the product's enclosure that may be of sufficient magnitude to constitute a risk or electric shock to persons.



The exclamation point within a triangle is intended to alert the user to the presence of important operating and maintenance (servicing) instructions in the literature accompanying the product.

WARNING: FCC Regulations state that any unauthorized changes or modifications to this equipment not expressly approved by the manufacturer could void the user's authority to operate this equipment.

U.S.A. ONLY

INFORMATION

This equipment has been tested and found to comply with the limits for a Class A digital device, pursuant to Part 15 of the FCC Rules. These limits are designed to provide reasonable protection against harmful interference when the equipment is operated in a commercial environment. This equipment generates, uses, and can radiate radio frequency energy and, if not installed and used in accordance with the operation manual, may cause harmful interference to radio communications. Operation of this equipment in a residential area is likely to cause harmful interference, in which case the user will be required to correct the interference at his own expense.

U.S.A. ONLY

The enclosed computer cable must be used with the device. The cable is provided to ensure that the device complies with FCC Class A verification.

U.S.A. ONLY

WARNING:

This is a Class A product. In a domestic environment this product may cause radio interference in which case the user may be required to take adequate measures.

WARNING:

The cooling fan in this projector continues to run for about 90 seconds after the projector enters the standby mode. During normal operation, when putting the projector into standby mode always use the STANDBY button on the projector or on the remote control. Ensure the cooling fan has stopped before disconnecting the power cord. DURING NORMAL OPERATION, NEVER TURN THE PROJECTOR OFF BY DISCONNECTING THE POWER CORD. FAILURE TO OBSERVE THIS WILL RESULT IN PREMATURE LAMP FAILURE.

PRODUCT DISPOSAL

This projector utilizes tin-lead solder, and a pressurized lamp containing a small amount of mercury. Disposal of these materials may be regulated due to environmental considerations. For disposal or recycling information, please contact your local authorities or, if you are located in the United States of America, the Electronic Industries Alliance: www.eiae.org.

Caution Concerning Lamp Replacement

See "Replacing the Lamp" on page 93.

This SHARP projector uses a DMD panel. This very sophisticated panel contains 786,432 pixels (micromirrors). As with any high technology electronic equipment such as large screen TVs, video systems and video cameras, there are certain acceptable tolerances that the equipment must conform to.

This unit has some inactive pixels within acceptable tolerances which may result in inactive dots on the picture screen. This will not affect the picture quality or the life expectancy of the unit.

- DLP™ (Digital Light Processing) and DMD™ (Digital Micromirror Device) are trademarks of Texas Instruments, Inc.
- Microsoft® and Windows® are registered trademarks of Microsoft Corporation in the United States and/or other countries.
- PC/AT is a registered trademark of International Business Machines Corporation in the United States.
- Adobe® Reader® is a trademark of Adobe Systems Incorporated.
- Macintosh® is a registered trademark of Apple Computer, Inc. in the United States and/or other countries.
- All other company or product names are trademarks or registered trademarks of their respective companies.
- Some IC chips in this product include confidential and/or trade secret property belonging to Texas Instruments. Therefore you may not copy, modify, adapt, translate, distribute, reverse engineer, reverse assemble or discompile the contents thereof.

How to Read This Operation Manual

- In this operation manual, the illustrations and on-screen displays are simplified for explanation. This may differ from the actual on-screen display.

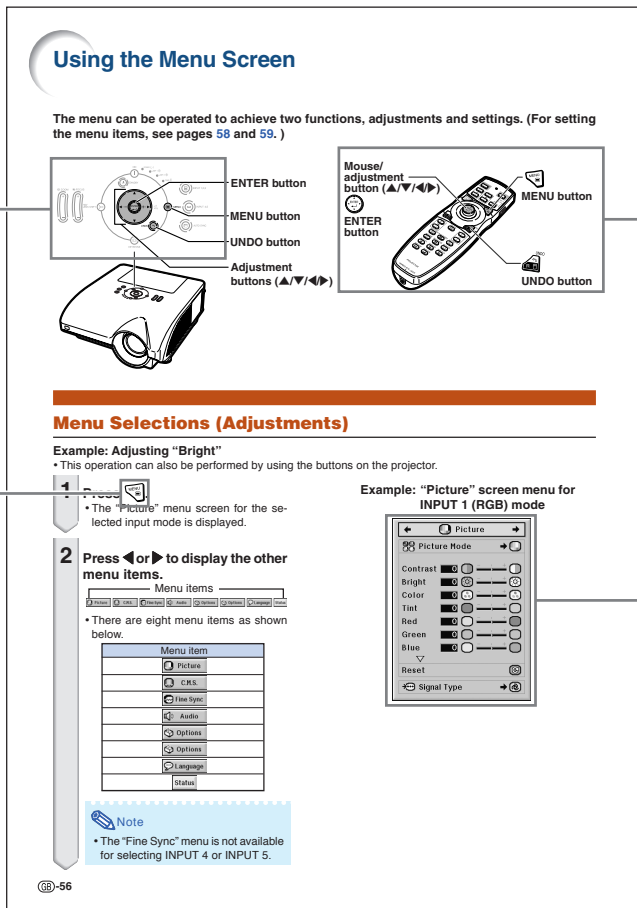

InfoIndicates safeguards when using the projector.

NoteIndicates additional information for setting up and operating the projector.

For Future Reference

Maintenance

➔ **Page 90**

Troubleshooting

➔ **Pages 99 and 100**

Index

➔ **Page 104**

Contents

Preparing

Introduction

How to Read This Operation Manual	3	Using the Remote Control	17
Contents	4	Usable Range	17
IMPORTANT SAFEGUARDS	7	Inserting the Batteries	17
How to Access the PDF Operation Manuals ...	10	Using the Remote Control with a Signal Cable ..	18
Accessories	11	Switching the Remote Control Mode	18
Part Names and Functions	13	Using the Remote Control as a Wireless Computer Mouse	19

Quick Start

Quick Start	20
--------------------------	-----------

Setup

Setting Up the Projector	22
Setting Up the Projector	22
Projecting a Reversed Image	23

Connections

Connections	24	Connecting to Video Equipment That Has a DVI Output Terminal with a DVI Digital Cable...	31
INPUT/OUTPUT Terminals and Connectable Main Equipment	24	Connecting to RGB Video Equipment with a 5 RCA RGB Cable	32
Samples of Cables for Connection	25	Connecting to Video Equipment That Has Component Output Terminals	33
Connecting to a Computer	27	Connecting with an S-video Cable or a Compos- ite Video Cable	34
Connecting with the RGB Cable... ..	27	Controlling the Projector by a Computer ...	35
Connecting with a 5 BNC to 15-pin D-sub Cable... ..	28	Connecting to a Monitor That Has an RGB Input Terminal	36
Connecting with a DVI Digital Cable... ..	29	Connecting to an Amplifier or Other Audio Equipment	36
Connecting to Video Equipment	30		
Connecting to Video Equipment That Has an HDMI Output Terminal with a DVI to HDMI Cable	30		

Using

Basic Operation

Turning the Projector On/Off	37	Adjusting the Volume	46
Image Projection	38	Turning off the Sound Temporarily	46
Shifting the Lens	38	Displaying an Enlarged Portion of an Image	46
Using the Adjustment Feet	39	Freezing a Moving Image	47
Adjusting the Focus	40	Selecting the Picture Mode	47
Adjusting the Projected Image Size	40	Resize Mode	48
Correcting Trapezoidal Distortion	41	Displaying the Black Screen	50
Switching the Input Mode	45	Displaying and Setting the Break Timer	50

Useful Features

Menu Items	51	Using the “Options (1)” Menu	74
Using the Menu Screen	56	Displaying Dual Pictures (Pict in Pict)	74
Menu Selections (Adjustments)	56	Setting the Resize Mode	74
Menu Selections (Settings)	58	Shifting the Projected Image Vertically (Digital Shift)	75
Picture Adjustment (“Picture” menu)	60	Setting On-screen Display	75
Selecting the Picture Mode	60	Setting the Video System	76
Adjusting the Image	60	Capturing Projected Images	76
Adjusting the Color Temperature	61	Selecting the Background Image	77
Emphasizing the Contrast	61	Selecting the Startup Image	77
Selecting the Progressive Mode	62	Eco Mode	78
Reducing Image Noise (DNR)	62	Detecting the Input Signals Automatically	78
Signal Type Setting	63	Auto Power Off Function	79
Color Management System		System Lock Function	79
 (“C. M. S.” menu)	64	Helpful Functions Set during Installation	
Selecting the Color Reproduction Mode	64	 (“Options (2)” menu)	82
Selecting the Target Color	64	Setting a Password	82
Setting the Brightness of the Target Color	65	Checking the Lamp Life Status	83
Setting the Chromatic Value of the Target Color ...	65	Setting the Lamp Mode	83
Setting the Hue of the Target Color	66	Reversing/Inverting Projected Images	84
Resetting User-defined Color Settings	66	Controlling Multiple Projectors with the One Remote Control	84
Overview of All Color Settings	67	Shortcut to Make Projector Stack Settings	85
Computer Image Adjustment		Locking the Operation Buttons on the Projector ...	85
 (“Fine Sync” menu)	68	Bypassing Unused Input Selections	86
Adjusting the Computer Image	68	Selecting the Transmission Speed (RS-232C)	86
Saving Adjustment Settings	68	Monitor Output Settings	87
Selecting Adjustment Settings	69	LAN/RS232C Setting	87
Special Mode Setting	69	Service Mode	88
Checking the Input Signal	70	Returning to the Default Settings	88
Auto Sync Adjustment	70	Using the Other Menus (“Language” and	
Auto Sync Display Function	71	 “Status” menus)	89
Audio Adjustment (“Audio” menu)	72	Selecting the On-screen Display Language	89
Adjusting the Audio	72	Overview of All Menu Settings	89
Setting the Audio Output Type	72		
Speaker Setting	73		

Reference

Appendix

Maintenance	90	Computer Compatibility Chart	97
Maintenance Indicators	91	Troubleshooting	99
Regarding the Lamp	93	For SHARP Assistance	101
Lamp	93	Specifications	102
Caution Concerning the Lamp	93	Glossary	103
Replacing the Lamp	93	Index	104
Removing and Installing the Lamp Unit	94		
Resetting the Lamp Timer	96		

The optional lenses are introduced on page 12. Please purchase the lens for your desired usage.

IMPORTANT SAFEGUARDS

CAUTION: Please read all of these instructions before you operate this product and save these instructions for later use.

Electrical energy can perform many useful functions. This product has been engineered and manufactured to assure your personal safety. BUT IMPROPER USE CAN RESULT IN POTENTIAL ELECTRICAL SHOCK OR FIRE HAZARDS. In order not to defeat the safeguards incorporated in this product, observe the following basic rules for its installation, use and servicing.

1. Read Instructions

All the safety and operating instructions should be read before the product is operated.

2. Retain Instructions

The safety and operating instructions should be retained for future reference.

3. Heed Warnings

All warnings on the product and in the operating instructions should be adhered to.

4. Follow Instructions

All operating and use instructions should be followed.

5. Cleaning

Unplug this product from the wall outlet before cleaning. Do not use liquid cleaners or aerosol cleaners. Use a damp cloth for cleaning.

6. Attachments

Do not use attachments not recommended by the product manufacturer as they may cause hazards.

7. Water and Moisture

Do not use this product near water—for example, near a bath tub, wash bowl, kitchen sink, or laundry tub; in a wet basement; or near a swimming pool; and the like.

8. Accessories

Do not place this product on an unstable cart, stand, tripod, bracket, or table. The product may fall, causing serious injury to a child or adult, and serious damage to the product. Use only with a cart, stand, tripod, bracket, or table recommended by the manufacturer, or sold with the product. Any mounting of the product should follow the manufacturer's instructions, and should use a mounting accessory recommended by the manufacturer.

9. Transportation

A product and cart combination should be moved with care. Quick stops, excessive force, and uneven surfaces may cause the product and cart combination to overturn.



10. Ventilation

Slots and openings in the cabinet are provided for ventilation to ensure reliable operation of the product and to protect it from overheating, and these openings must not be blocked or covered. The openings should never be blocked by placing the product on a bed, sofa, rug, or other similar surface. This product should not be placed in a built-in installation such as a bookcase or rack unless proper ventilation is provided or the manufacturer's instructions have been adhered to.

11. Power Sources

This product should be operated only from the type of power source indicated on the marking label. If you are not sure of the type of power supply to your home, consult your product dealer or local power company. For products intended to operate from battery power, or other sources, refer to the operating instructions.

12. Grounding or Polarization

This product is provided with one of the following types of plugs. If the plug should fail to fit into the power outlet, please contact your electrician.

Do not defeat the safety purpose of the plug.

- Two-wire type (mains) plug.
- Three-wire grounding type (mains) plug with a grounding terminal.
This plug will only fit into a grounding type power outlet.

13. Power-Cord Protection

Power-supply cords should be routed so that they are not likely to be walked on or pinched by items placed upon or against them, paying particular attention to cords at plugs, convenience receptacles, and the point where they exit from the product.

14. Lightning

For added protection for this product during a lightning storm, or when it is left unattended and unused for long periods of time, unplug it from the wall outlet and disconnect the cable system. This will prevent damage to the product due to lightning and power-line surges.

15. Overloading

Do not overload wall outlets, extension cords, or integral convenience receptacles as this can result in a risk of fire or electric shock.

16. Object and Liquid Entry

Never push objects of any kind into this product through openings as they may touch dangerous voltage points or short-out parts that could result in a fire or electric shock. Never spill liquid of any kind on the product.

17. Servicing

Do not attempt to service this product yourself as opening or removing covers may expose you to dangerous voltage or other hazards. Refer all servicing to qualified service personnel.

18. Damage Requiring Service

Unplug this product from the wall outlet and refer servicing to qualified service personnel under the following conditions:

- When the power-supply cord or plug is damaged.
- If liquid has been spilled, or objects have fallen into the product.
- If the product has been exposed to rain or water.
- If the product does not operate normally by following the operating instructions. Adjust only those controls that are covered by the operating instructions, as an improper adjustment of other controls may result in damage and will often require extensive work by a qualified technician to restore the product to normal operation.
- If the product has been dropped or damaged in any way.
- When the product exhibits a distinct change in performance, this indicates a need for service.

19. Replacement Parts

When replacement parts are required, ensure that the service technician has used replacement parts specified by the manufacturer or have the same characteristics as the original part. Unauthorized substitutions may result in fire, electric shock, or other hazards.

20. Safety Check

Upon completion of any service or repairs to this product, ask the service technician to perform safety checks to determine that the product is in proper operating condition.

21. Wall or Ceiling Mounting

This product should be mounted to a wall or ceiling only as recommended by the manufacturer.

22. Heat

This product should be situated away from heat sources such as radiators, heat registers, stoves, or other products (including amplifiers) that produce heat.

Ensure that you read the following safeguards when setting up your projector.

Caution concerning the lamp unit

- Potential hazard of glass particles if lamp ruptures. In case of lamp rupture, contact your nearest Sharp Authorized Projector Dealer or Service Center for replacement. See “Replacing the Lamp” on page 93.

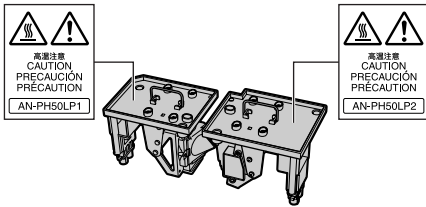

Caution concerning the setup of the projector

- For minimal servicing and to maintain high image quality, SHARP recommends that this projector be installed in an area free from humidity, dust and cigarette smoke. When the projector is subjected to these environments, the vents and lens must be cleaned more often. As long as the projector is regularly cleaned, use in these environments will not reduce the overall operation life of the unit. Internal cleaning should only be performed by a Sharp Authorized Projector Dealer or Service Center.

Do not set up the projector in places exposed to direct sunlight or bright light.

- Position the screen so that it is not in direct sunlight or room light. Light falling directly on the screen washes out the colors, making viewing difficult. Close the curtains and dim the lights when setting up the screen in a sunny or bright room.

The projector may be safely tilted to a maximum angle of 9 degrees.

- Placement should be within 9 degrees of horizontal. If you have application requiring tilt angle exceeding 9 degrees, please check with your local Sharp sales office.

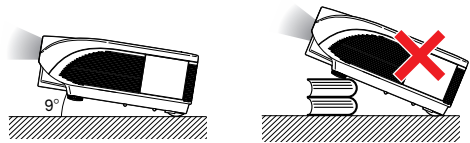

Warning about placing the projector in a high position

- When placing the projector in a high position, ensure to secure it carefully to avoid personal injury caused by the projector falling down.

Do not subject the projector to hard impact and/or vibration.

- Take care with the lens so as not to hit or damage the surface of the lens.

Rest your eyes occasionally.

- Continuously watching the screen for long hours will cause eye strain. Ensure to occasionally rest your eyes.

Avoid locations with extremes of temperature.

- The operating temperature of the projector is from 41°F to 104°F (+5°C to +40°C).
- The storage temperature of the projector is from -4°F to 140°F (-20°C to +60°C).

Do not block the intake and exhaust vents.

- Allow at least 11 ¹³/₁₆ inches (30 cm) of space between the exhaust vent and the nearest wall or obstruction.
- Ensure that the intake vents and the exhaust vent are not obstructed.
- If the cooling fan becomes obstructed, a protection circuit will automatically put the projector into standby mode to prevent overheat damage. This does not indicate a malfunction (See pages 91 and 92.). Remove the projector power cord from the wall outlet and wait at least 10 minutes. Place the projector where the intake and exhaust vents are not blocked, plug the power cord back in and turn on the projector. This will return the projector to the normal operating condition.

Caution regarding usage of the projector

- When using the projector, ensure not to subject it to hard impact and/or vibration, as this can result in damage. Take extra care with the lens. If you are not to use the projector for a long time, ensure to unplug the power cord from the wall outlet, and disconnect any other cables connected to it.
- Do not use the projector while holding the lens.
- When storing the projector, ensure to attach the lens cap to the projector. (See page 13.)
- Do not expose the projector to direct sunlight or near heat sources. The projector may change color or become deformed.

Other connected equipment

- When connecting a computer or other audio-visual equipment to the projector, make the connections AFTER unplugging the power cord of the projector from the AC outlet and turning off the equipment to be connected.
- Please read the operation manuals of the projector and the equipment to be connected for instructions on how to make the connections.

Using the projector in other countries

- The power supply voltage and the shape of the plug may vary depending on the region or country you are using the projector in. When using the projector overseas, ensure to use an appropriate power cord for the country you are in.

Temperature monitor function

- If the projector starts to over-heat due to setup problems or blockage of the air vents, “” and “TEMP.” will illuminate in the lower left corner of the picture. If the temperature continues to rise, the lamp will turn off, the temperature warning indicator on the projector will blink, and after a 90-second cooling-off period the projector will enter the standby mode. Refer to “Maintenance Indicators” on page 91 for details.



Info

- The cooling fan regulates the internal temperature, and its performance is automatically controlled. The sound of the fan may change during projector operation due to changes in the fan speed. This does not indicate malfunction.
- Do not unplug the power cord during projection or cooling fan operation. This can cause damage due to rise in internal temperature, as the cooling fan also stops.

Optional lens installation

- Be sure to have service personnel install the optional lenses.



How to Access the PDF Operation Manuals

PDF operation manuals in several languages are included in the CD-ROM, so that you can work with the projector. To utilize these manuals, you need to install Adobe® Reader® on your computer (Windows® or Macintosh®).

Please download Adobe® Reader® from the Internet (<http://www.adobe.com>).

Accessing the PDF manuals

For Windows®:

- ① Insert the CD-ROM in the CD-ROM drive.
- ② Double click the “My Computer” icon.
- ③ Double click the “CD-ROM” drive.
- ④ **When you want to view the operation manual**
 - 1) Double click the “MANUALS” folder.
 - 2) Double click the language (name of the folder) that you want to view.
 - 3) Double click the “PH50” pdf file to access the projector manuals.

When you want to view the setup guide

- 1) Double click the “SETUP” folder.
- 2) Double click the language (name of the folder) that you want to view.
- 3) Double click the “S_PH5” pdf file to access the setup guide.

For Macintosh®:

- ① Insert the CD-ROM in the CD-ROM drive.
- ② Double click the “CD-ROM” icon.
- ③ **When you want to view the operation manual**
 - 1) Double click the “MANUALS” folder.
 - 2) Double click the language (name of the folder) that you want to view.
 - 3) Double click the “PH50” pdf file to access the projector manuals.

When you want to view the setup guide

- 1) Double click the “SETUP” folder.
- 2) Double click the language (name of the folder) that you want to view.
- 3) Double click the “S_PH5” pdf file to access the setup guide.



Info

- If the desired pdf file cannot be opened by double clicking the mouse, start Adobe® Reader® first, then specify the desired file using the “File”, “Open” menu.

SETUP GUIDE

Refer to the “SETUP GUIDE” contained on the supplied CD-ROM for details.

Setting up the Screen	2
Screen Size and Projection Distance	3
Connecting Pin Assignments	10
RS-232C Specifications and Commands ...	12
Setting up the Projector Network	
Environment	17
Controlling the Projector via LAN	23

Setting the Projector Using	
RS-232C or Telnet	28
Controlling the Projector Using	
RS-232C or Telnet	31
Stack Projection	38
Video Wall Projection	41
Troubleshooting	50
Dimensions	53

Supplied accessories



Remote control
9NK5041808700



Two R-6 batteries
("AA" size, UM/SUM-3, HP-7 or similar)

Power cord*

(1)

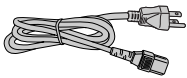

For U.S., Canada, etc.
(12' (3.6 m))
9NK3090152800

(2)

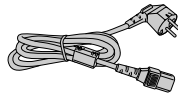

For Europe, except U.K.
(6' (1.8 m))
9NK3090152700

(3)

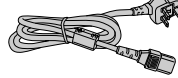

For U.K., Hong Kong
and Singapore
(6' (1.8 m))
9NK3090152900

(4)

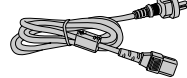

For Australia, New
Zealand and Oceania
(6' (1.8 m))
9NK3090152600

* Use the power cord that corresponds to the wall outlet in your country.

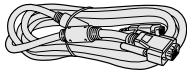

RGB cable
(9'10" (3.0 m))
9NK3080431000



Remote mouse receiver
(5'3" (1.6 m))
9NK3790197000

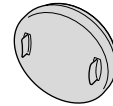

Cap for the standard zoom lens
9NK3797200400

Projector manual and
technical reference
CD-ROM
9NK3532094500

Operation manual
(this manual)
9NK5010011800

Optional accessories

■ Cable

3 RCA to 15-pin D-sub cable (9'10" (3.0 m)) AN-C3CP2

■ Lamp

Lamp unit 1 AN-PH50LP1
Lamp unit 2 AN-PH50LP2

Note

- Some of the optional accessories may not be available depending on the region. Please check with your nearest Sharp Authorized Projector Dealer or Service Center.

Optional lenses

■ Lens		Projection distance for 100" screen size
Fixed wide lens (× 0.8)	AN-PH10EX	5'4" (1.6 m)
Wide-zoom lens (× 1.5 – 1.8)	AN-PH20EZ	10' – 12' (3.0 m – 3.7 m)
Standard zoom lens (× 1.8 – 2.2) (attached to XG-PH50X)	AN-PH30EZ	12' – 14'8" (3.7 m – 4.5 m)
Tele-zoom lens (× 2.25 – 3.00)	AN-PH40EZ	15' – 20' (4.6 m – 6.1 m)
Tele-zoom lens (× 3.0 – 4.5)	AN-PH50EZ	20' – 30' (6.1 m – 9.1 m)
Tele-zoom lens (× 4.5 – 7.0)	AN-PH60EZ	30' – 46'8" (9.1 m – 14.2 m)

No lens is attached to XG-PH50X-NL. The standard zoom lens is attached to XG-PH50X. The optional lenses from Sharp are also available for specialized application. Please see your nearest Sharp Authorized Projector Dealer for details on all the lenses. (Refer to the lens operation manual when using a lens.) Also, ensure to have service personnel install the optional lenses.

Throw Distance

The graph below is for 100 inches (254 cm) screen with 4:3 normal mode.

Screen

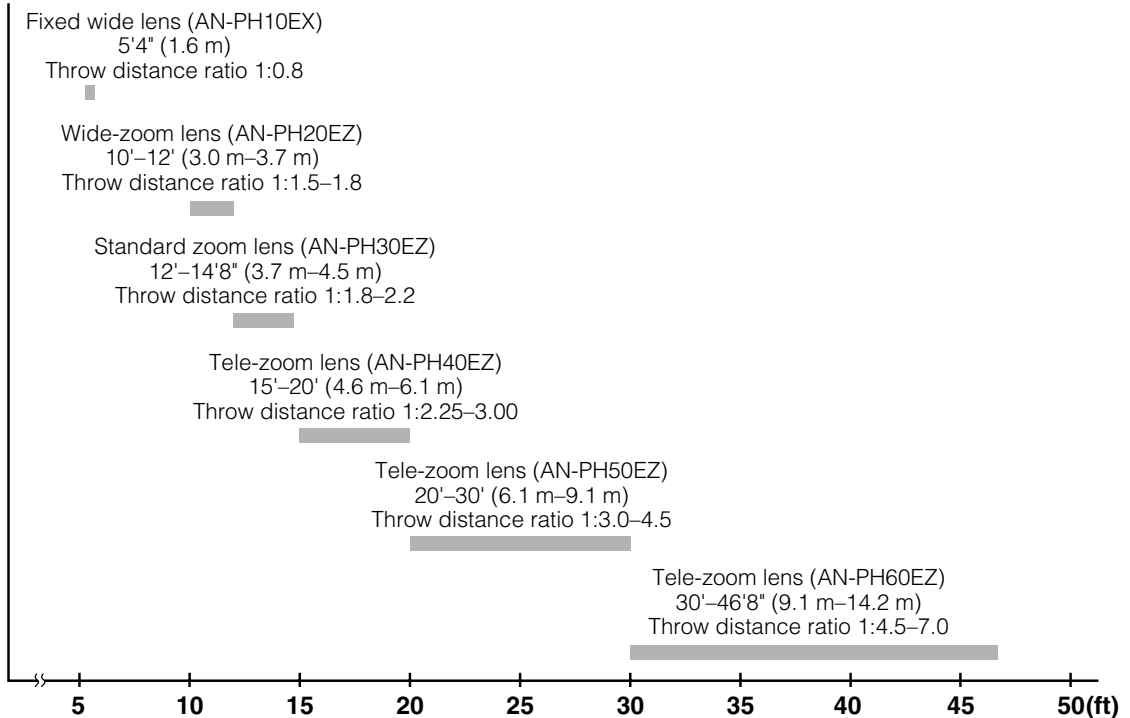

Part Names and Functions

Numbers in refer to the main pages in this operation manual where the topic is explained.

Projector

Top View

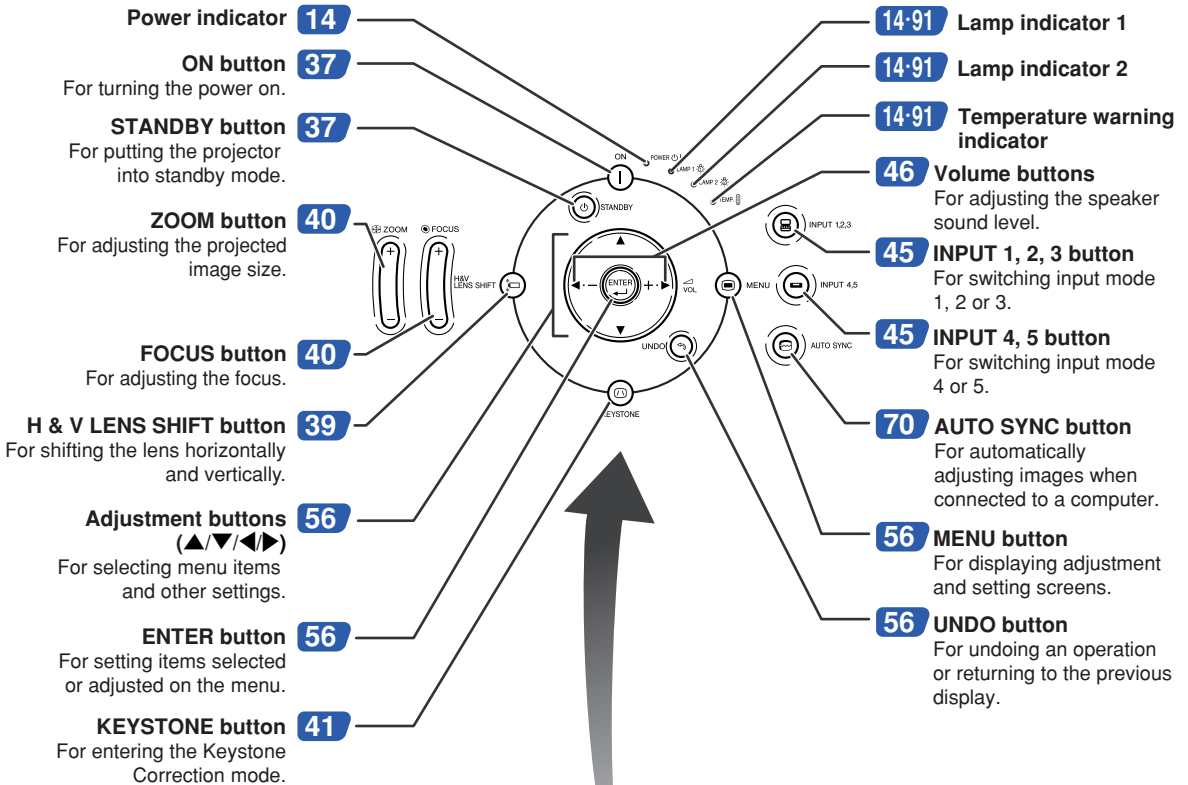

Front View

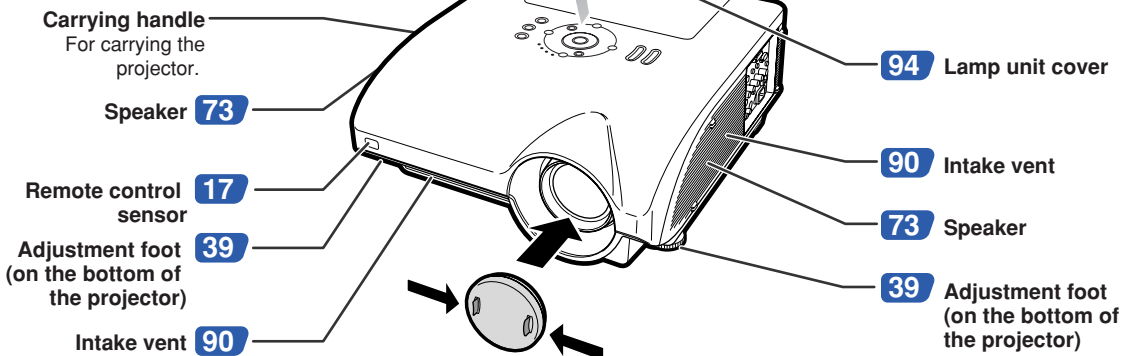

- **Attaching the lens cap**
Push the lens cap on until it clicks into position.
- **Removing the lens cap**
Pull the lens cap directly outward.

About the Indicators on the Projector

Power indicator

Red on ... Normal (Standby)
Green on ... Normal (Power on)
Red blinks ... The intake vent cover is open.
(See page 90.)

Lamp indicators 1, 2

Green on ... Normal
Green blinks ... The lamp is warming up.
Red on ... The lamp has been shut down abnormally or needs to be changed. (See page 91.)

Temperature warning indicator

Off ... Normal
Red blinks/on ... The internal temperature is abnormally high. (See page 91.)

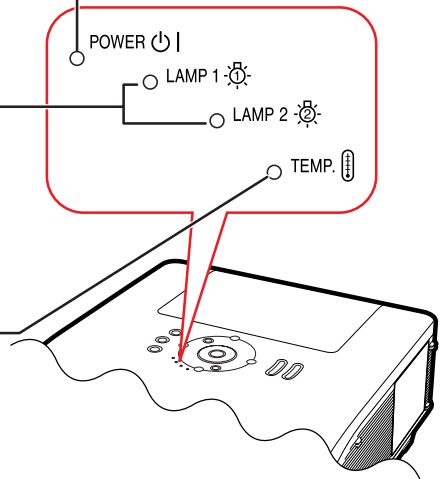

Numbers in refer to the main pages in this operation manual where the topic is explained.

Projector (Side View)

Terminals Refer to “INPUT/OUTPUT Terminals and Connectable Main Equipment” on page 24.

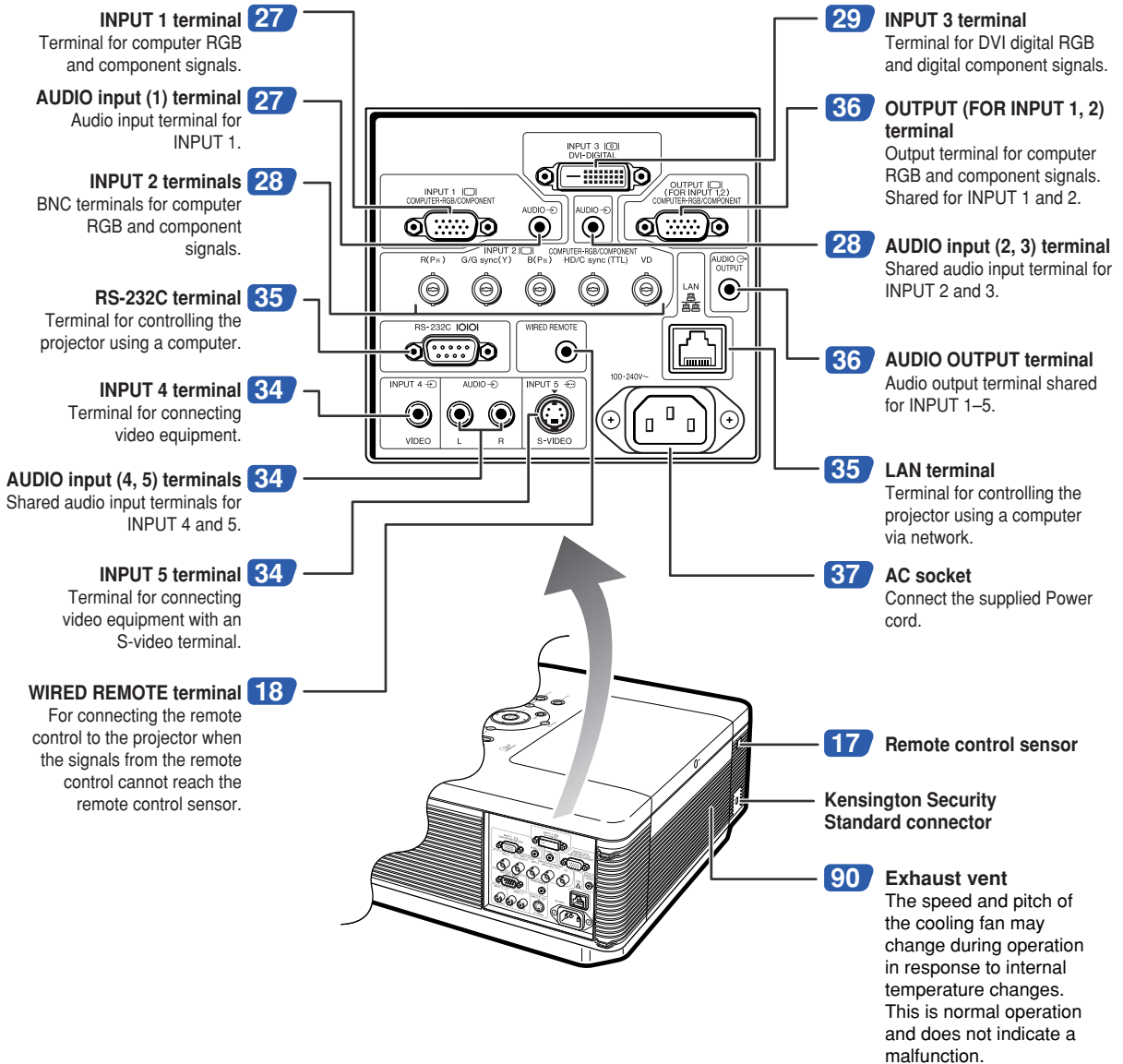

Using the Kensington Lock

- This projector has a Kensington Security Standard connector for use with a Kensington MicroSaver Security System. Refer to the information that came with the system for instructions on how to use it to secure the projector.

Numbers in refer to the main pages in this operation manual where the topic is explained.

Remote Control

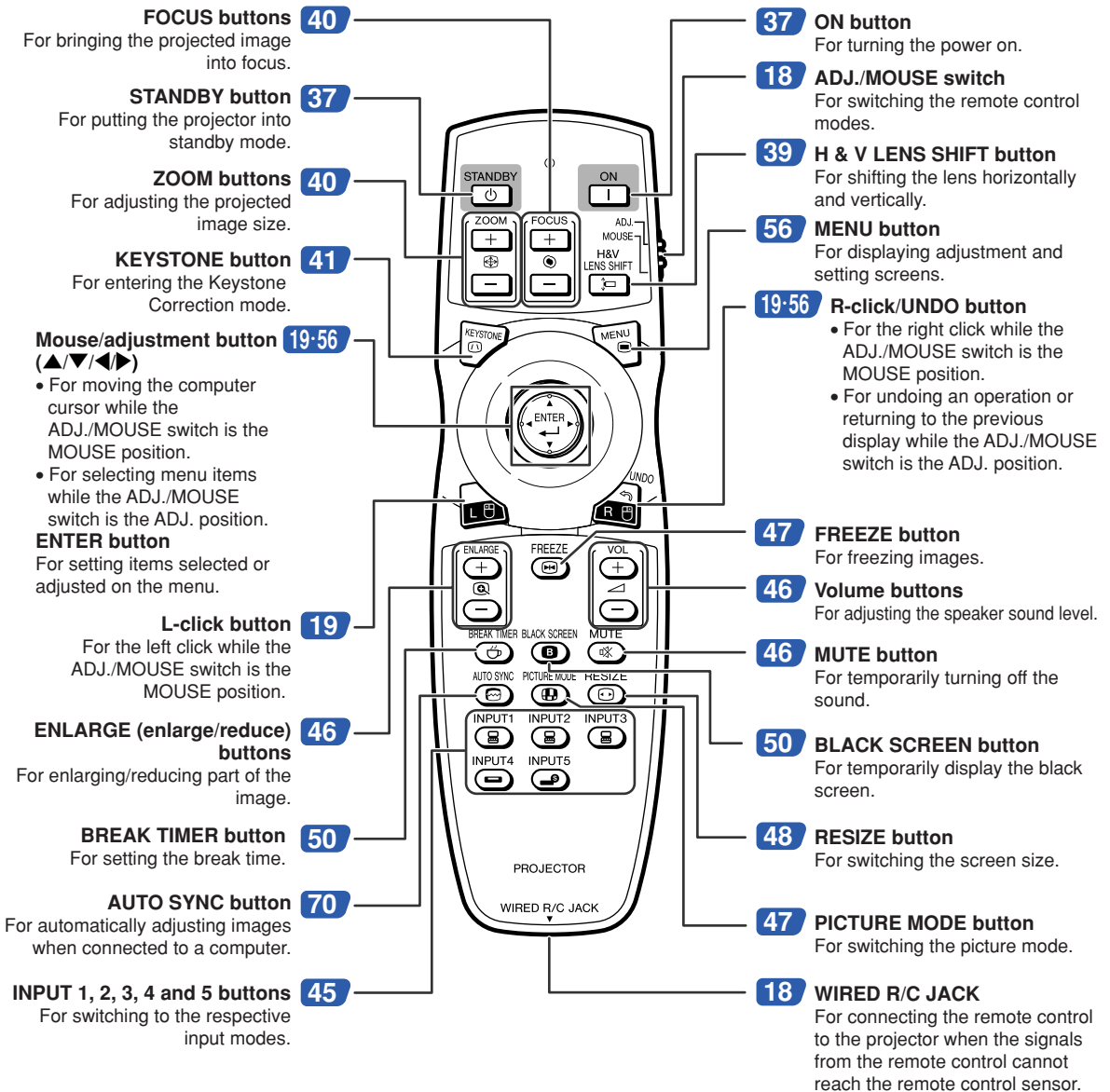

Note

- All the buttons on the remote control, except the mouse/adjustment button and the ADJ./MOUSE switch, are made of luminous material that is visible in the dark. Visibility will diminish over time. Exposure to light will recharge the luminous buttons.

Using the Remote Control

Usable Range

The remote control can be used to control the projector within the ranges shown in the illustration.

Note

- The signal from the remote control can be reflected off a screen for easy operation. However, the effective distance of the signal may differ depending on the screen material.

When using the remote control:

- Ensure not to drop, expose to moisture or high temperature.
- The remote control may malfunction under a fluorescent lamp. In this case, move the projector away from the fluorescent lamp.

Inserting the Batteries

The batteries (two R-6 batteries ("AA" size, UM/SUM-3, HP-7 or similar)) are supplied in the package.

1 Press the tab and lift open the battery cover in the direction of the arrow.

2 Insert the batteries.

- Insert the batteries making sure the polarities correctly match the \oplus and \ominus marks inside the battery compartment.

3 Insert the tabs on the end of the battery cover into their slots and press the cover into position.

Front View

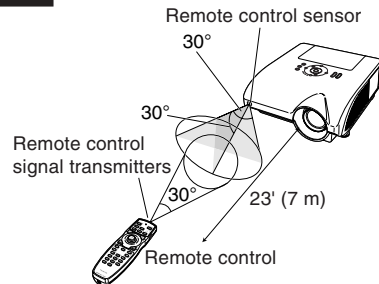

Rear View

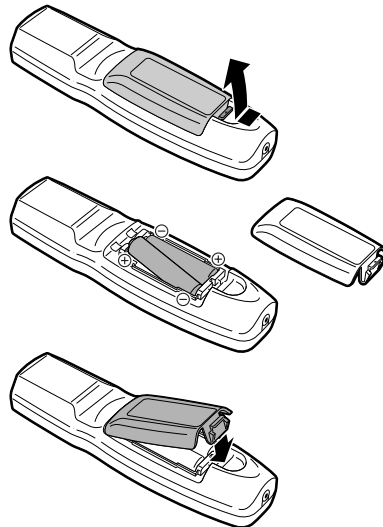
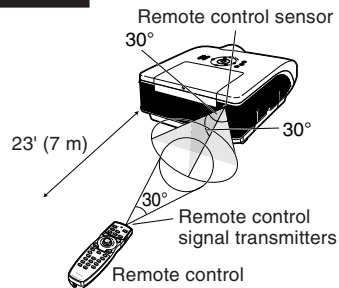

Incorrect use of the batteries may cause them to leak or explode. Please follow the precautions below.

⚠ Caution

- Insert the batteries making sure the polarities correctly match the \oplus and \ominus marks inside the battery compartment.
- Batteries of different types have different properties, therefore do not mix batteries of different types.
- Do not mix new and old batteries.
This may shorten the life of new batteries or may cause old batteries to leak.
- Remove the batteries from the remote control once they have run out, as leaving them in can cause them to leak. Battery fluid from leaked batteries is harmful to skin, therefore ensure to first wipe them and then remove them using a cloth.

- The batteries included with this projector may run down in a short period, depending on how they are kept. Ensure to replace them as soon as possible with new batteries.
- Remove the batteries from the remote control if you will not be using the remote control for a long time.

Using the Remote Control with a Signal Cable

When the signals from the remote control cannot be reached due to the range or positioning of the projector, you can connect the remote control to the projector with a $\phi 3.5$ mm minijack cable (commercially available or available as Sharp service part QCNWGA038WJPZ).

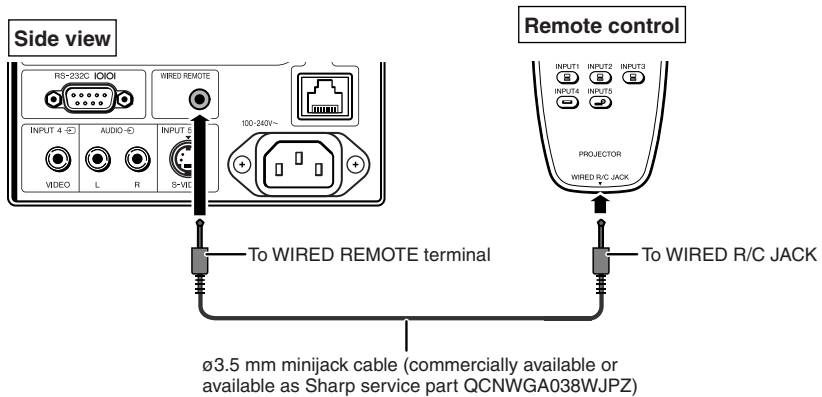

Switching the Remote Control Mode

The remote control has two functions. One is projector control and the other is wireless computer mouse. Slide the ADJ./MOUSE switch on the remote control to other side compatible to the desired usage.

Projector control

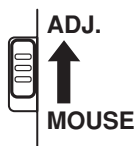

Wireless computer mouse

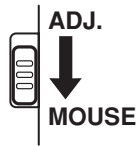

Info

- When using the remote control as the wireless computer mouse, connect the supplied remote mouse receiver to the computer. (See page 19.)

Using the Remote Control as a Wireless Computer Mouse

When connecting the supplied remote mouse receiver to the computer, you can use the remote control as the wireless computer mouse.

1 Connect the supplied remote mouse receiver to the USB terminal on the computer.

2 Slide the ADJ./MOUSE switch on the remote control to the MOUSE position.



3 Use the mouse function.
• Point the remote control at the remote mouse receiver.

■ When moving the cursor

Press ▲/▼/◀/▶.





■ When left-clicking

Press .

■ When right-clicking

Press .

■ When your computer supports only a one-click mouse (such as Macintosh®)

Press  or . ( and  have common function.)

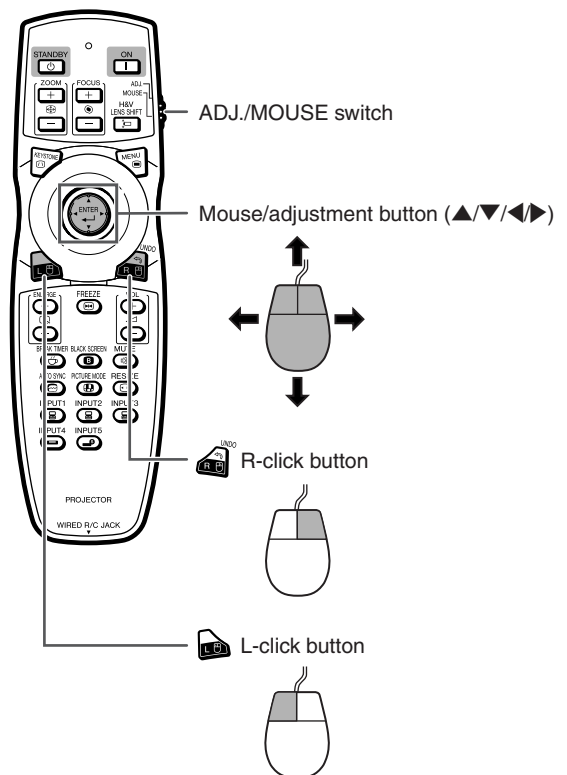
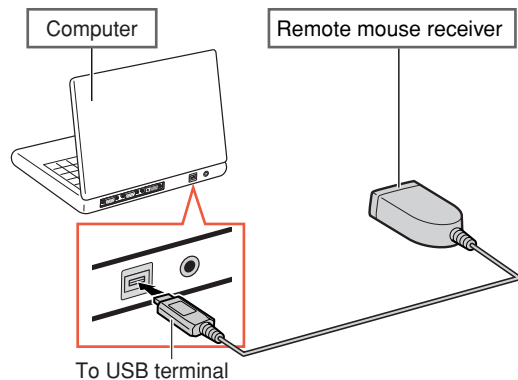
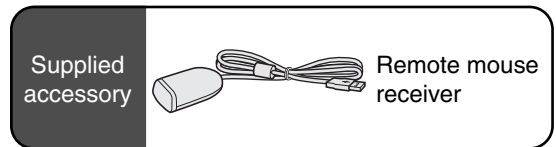

Note

- This function only works with the Microsoft® Windows® OS and Mac OS®. However, this function does not work with the following operation systems that do not support USB.
 - Versions earlier than Windows® 95.
 - Versions earlier than Windows® NT4.0.
 - Versions earlier than Mac OS® 8.5.
- Confirm that the computer recognizes the USB connection.
- While the remote control is connected to the projector with a signal cable, you cannot use the wireless computer mouse function.

Quick Start

This section shows the basic operation (projector connecting with the computer). For details, see the page described below for each step.

Setup and Projection

In this section, connection of the projector and the computer is explained using one example.

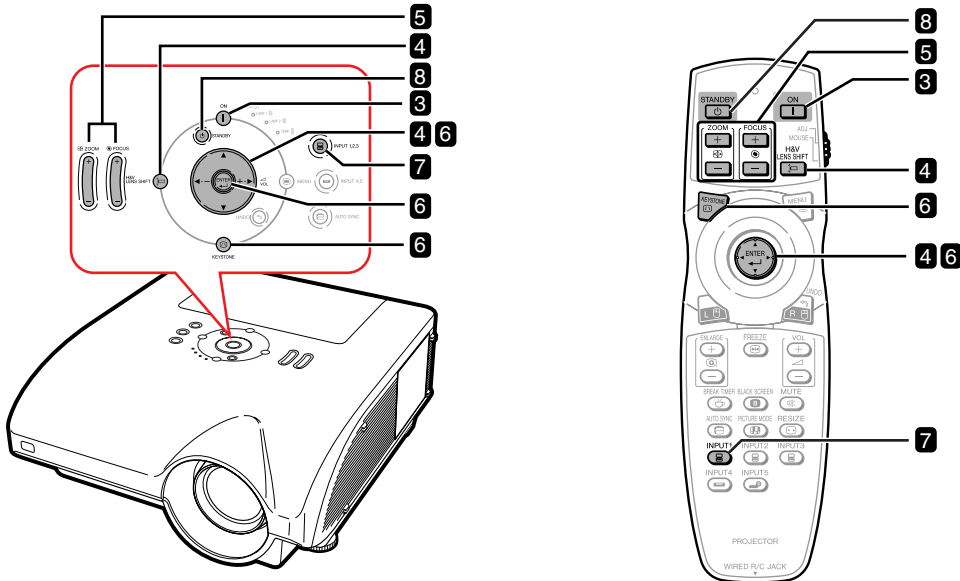

1. Place the projector facing a screen

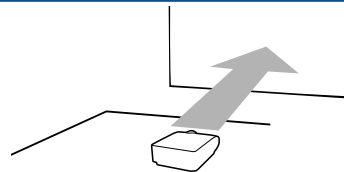

➔ Page 22

2. Connect the projector to the computer and plug the power cord into the AC socket of the projector

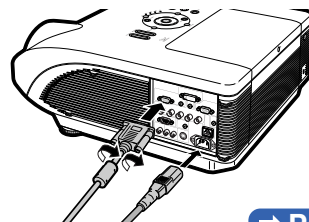

When connecting equipment other than the computer, see pages 30—36.

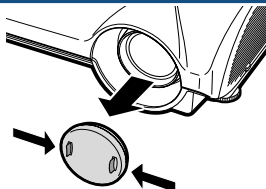

➔ Pages 27, 37

3. Remove the lens cap and turn the projector on









Press  on the projector or  on the remote control.

➔ Page 37

4. Adjust the angle

Adjust the projector angle

- Shift the lens horizontally and vertically.



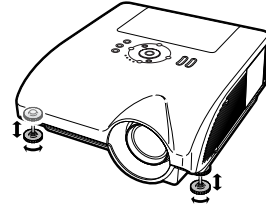

- 1 Press  on the projector or  on the remote control.
- 2 Press , ,  or  on the projector or the remote control.

- Adjust the projector angle by rotating the adjustment feet.













➔ Pages 38, 39

5. Adjust the focus and the zoom

- 1 Press  on the projector or  on the remote control to adjust the focus.
- 2 Press  on the projector or  on the remote control to adjust the zoom.

➔ Page 40

6. Correcting the image distortion due to the projection angle

- 1 Press  on the projector or  on the remote control.
- 2 Press  on the projector or  on the remote control.
- 3 Press , ,  or  to move the position for the upper left of the image.
- 4 Press  or  to set the position.
- 5 Repeat the same procedure with the positions for the upper right, lower right and lower left of the image.

- When the position of the lower left is set, the correction is made and the display disappears.

➔ Page 41

7. Select the input mode

Press  on the projector or  on the remote control to select the "INPUT 1" mode.

▼ On-screen Display (RGB)







- When pressing  on the projector, input mode switches in order of : INPUT 1 → INPUT 2 → INPUT 3.

Pressing  on the projector switches between "INPUT 4" and "INPUT 5".

- When using the remote control, press  /  /  /  /  to switch the input mode.

➔ Page 45

8. Turn the power off

Press  on the projector or  on the remote control. While the confirmation message is displayed, press  or  again.

▼ On-screen Display

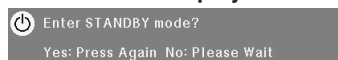

- Disconnect the power cord from the AC outlet after the cooling fan stops.

➔ Page 37

Setting Up the Projector

Setting Up the Projector

Position the projector perpendicular to the screen with the projector's feet flat and level to achieve an optimal image.

Note

- The projector lens should be centered in the middle of the screen. If the horizontal line passing through the lens center is not perpendicular to the screen, the image will be distorted, making viewing difficult.
- For an optimal image, position the screen so that it is not in direct sunlight or room light. Light falling directly on the screen washes out the colors, making viewing difficult. Close the curtains and dim the lights when setting up the projector in a sunny or bright room.

Standard Setup (Front Projection)

- Place the projector at the required distance from the screen according to the desired picture size. (For details, refer to "SETUP GUIDE" contained on the supplied CD-ROM.)

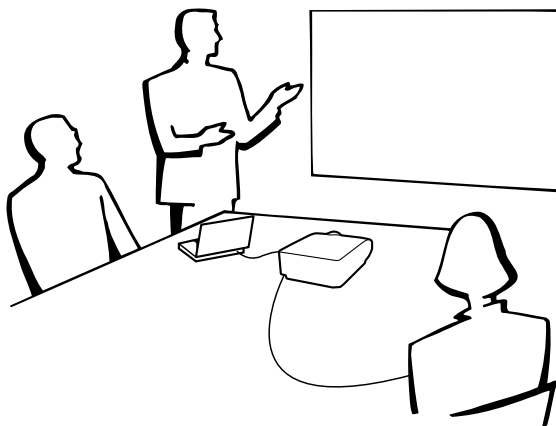

Indication of the Projection Image Size and Projection Distance

For details, refer to "SETUP GUIDE" contained on the supplied CD-ROM.

Example : NORMAL Mode (4:3) for the standard zoom lens (AN-PH30EZ)

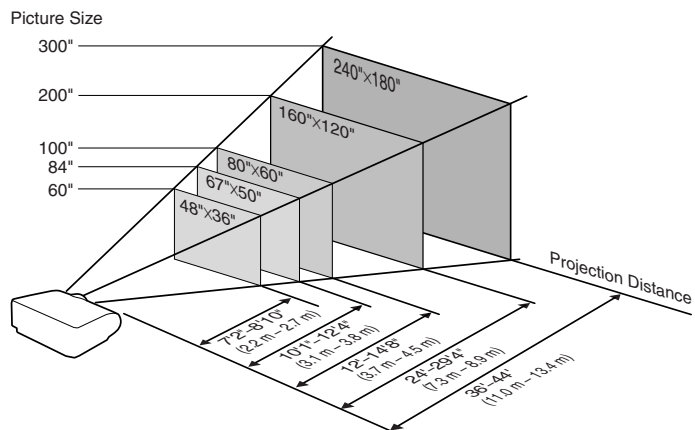

Projecting a Reversed Image

Projection from behind the Screen

- Place a translucent screen between the projector and the audience.
- Reverse the image by setting “Rear” in the “PRJ Mode” menu. (See page 84.)

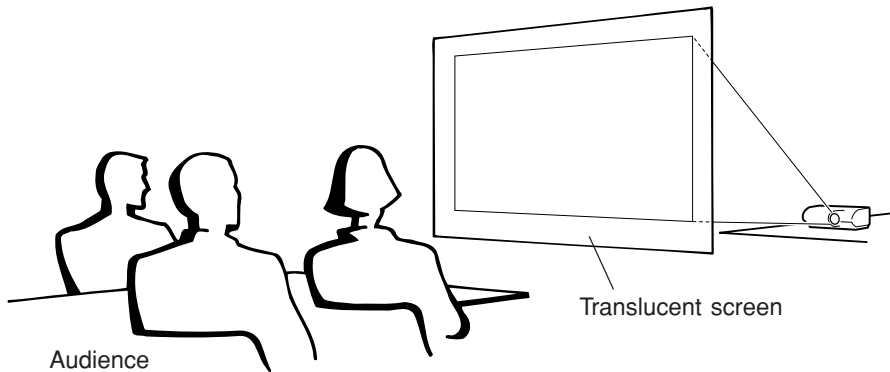

Projection Using a Mirror

- Place a mirror (normal flat type) in front of the lens.
- When the translucent screen is placed between the mirror and audience, set to “Front” in the “PRJ Mode” menu. (See page 84.)
- When the mirror is placed on the audience side, set to “Rear” in the “PRJ Mode” menu. (See page 84.)

Set to “Front”

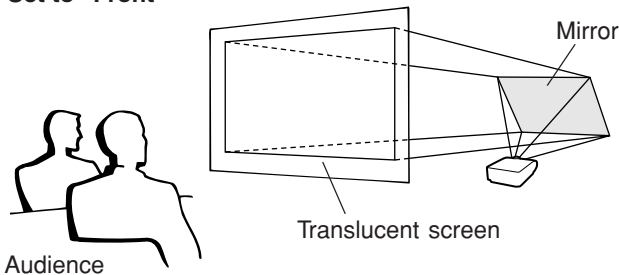

Set to “Rear”

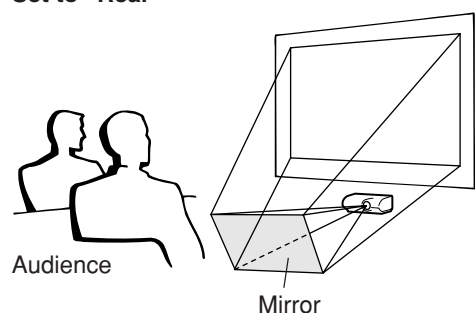

Info

- When using a mirror, ensure that both the projector and the mirror are carefully placed so the projected light does not shine into the eyes of the audience.

Ceiling-mount Setup

- It is recommended that you use the optional Sharp ceiling-mount bracket for this installation.
Before mounting the projector, contact your nearest Sharp Authorized Projector Dealer or Service Center to obtain the recommended ceiling-mount bracket (sold separately).
 - AN-PHCM20 ceiling-mount bracket, its AN-EP101AP extension tube (for the U.S.A.).
 - AN-NV6T ceiling-mount bracket, its AN-TK201 and AN-TK202 extension tubes (for countries other than the U.S.A.).
- Invert the image by setting “Ceiling + Front” in “PRJ Mode”. See page 84 for use of this function.

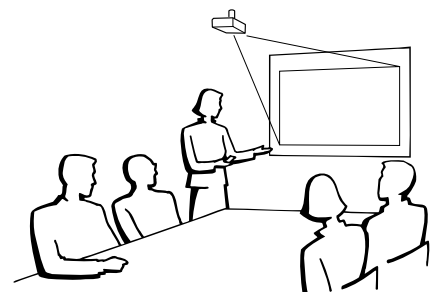



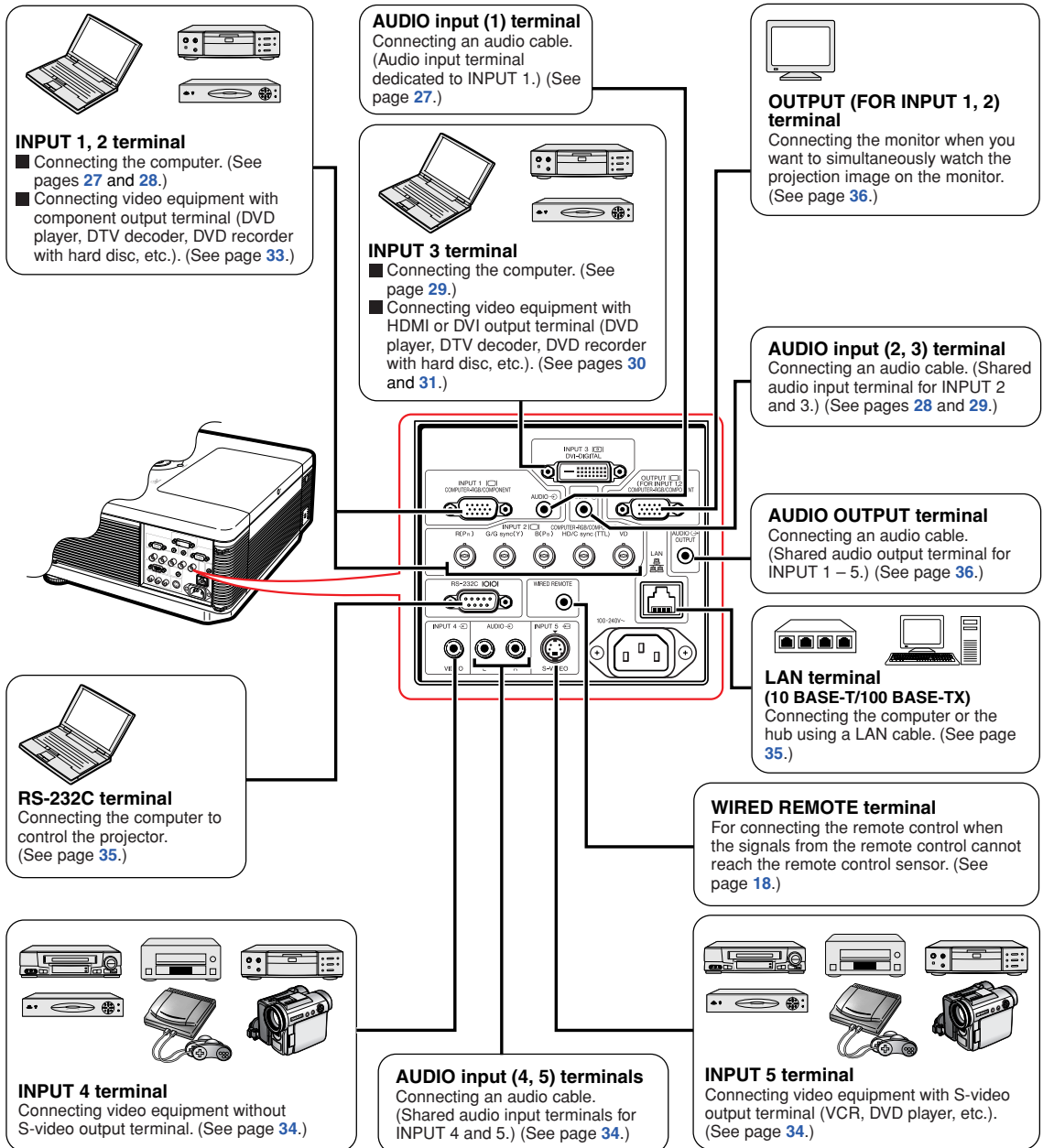

INPUT/OUTPUT Terminals and Connectable Main Equipment



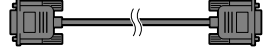
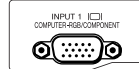
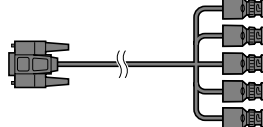
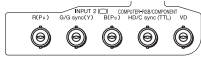
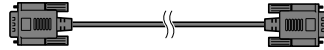
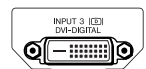
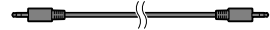

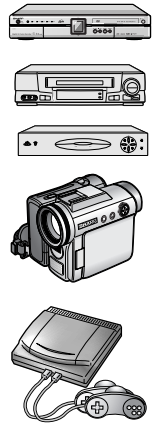
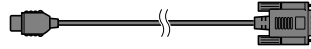
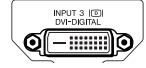
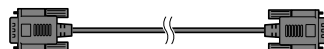
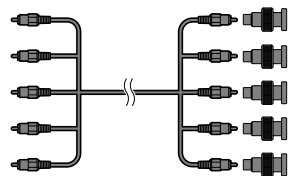
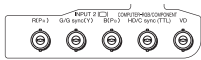
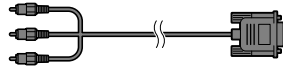
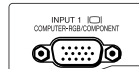
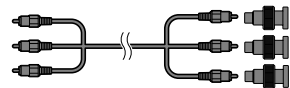





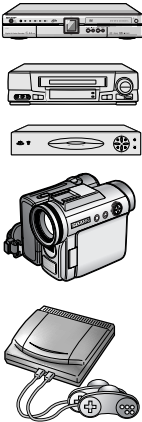
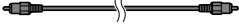

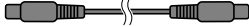
Samples of Cables for Connection

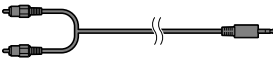
- For more details of connection and cables, refer to the operation manual of the connecting equipment.
- You may need other cables or connectors not listed below.

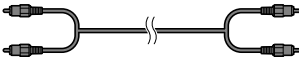
Equipment	Terminal on connected equipment	Cable	Terminal on the projector
	RGB output terminal	RGB cable (supplied) 	INPUT 1 
		5 BNC to 15-pin D-sub cable (commercially available) 	INPUT 2 
	DVI digital video output terminal	DVI Digital cable (commercially available) 	INPUT 3 
	Audio output terminal	ø3.5 mm stereo or mono audio cable (commercially available or available as Sharp service part QCNWGA038WJPZ) 	AUDIO (for INPUT 1)  AUDIO (for INPUT 2, 3) 
	HDMI output terminal	DVI to HDMI cable (commercially available) 	INPUT 3 
	DVI digital video output terminal	DVI Digital cable (commercially available) 	
	RGB output terminal	5 RCA RGB cable (commercially available) BNC to RCA adaptors (commercially available) 	INPUT 2 
	Component video output terminal	3 RCA to 15-pin D-sub cable (optional: AN-C3CP2) 	INPUT 1 
		BNC to RCA adaptors (commercially available) Component video cable (commercially available) 	INPUT 2 

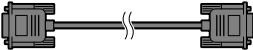
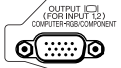
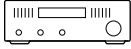
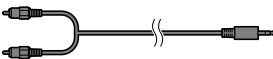
Samples of Cables for Connection

Equipment	Terminal on connected equipment	Cable	Terminal on the projector
Audio-visual equipment 	Video output terminal	Video cable (commercially available) 	INPUT 4 
	S-video output terminal	S-video cable (commercially available) 	INPUT 5 
	Audio output terminal	ø3.5 mm stereo minijack to RCA audio cable (commercially available) 	AUDIO (for INPUT 1)  AUDIO (for INPUT 2, 3) 
RCA audio cable (commercially available) 		AUDIO (for INPUT 4, 5) 	
Monitor 	RGB input terminal	RGB cable (supplied or commercially available) 	OUTPUT 
Amplifier 	Audio input terminal	ø3.5 mm stereo minijack to RCA audio cable (commercially available) 	AUDIO OUTPUT 

Connecting to a Computer

Before connecting, ensure the power cord of the projector from the AC outlet is unplugged, and that the devices to be connected are turned off. After making all connections, turn on the projector and then the other devices. When connecting a computer, ensure that it is the last device to be turned on after all the connections are made.

Ensure the operation manuals of the devices to be connected have been read before making connections.

Note

- See page 97 “Computer Compatibility Chart” for a list of computer signals compatible with the projector. Use with computer signals other than those listed may cause some of the functions to not work.
- Connecting computers other than the recommended types may result in damage to the projector, the computer, or both.
- A Macintosh adaptor may be required for use with some Macintosh computers. Contact your nearest Macintosh Dealer.
- **Depending on the computer you are using, an image may not be projected unless the signal output setting of the computer is switched to the external output.** Refer to the computer operation manual for switching the computer signal output settings.

Connecting with the RGB Cable

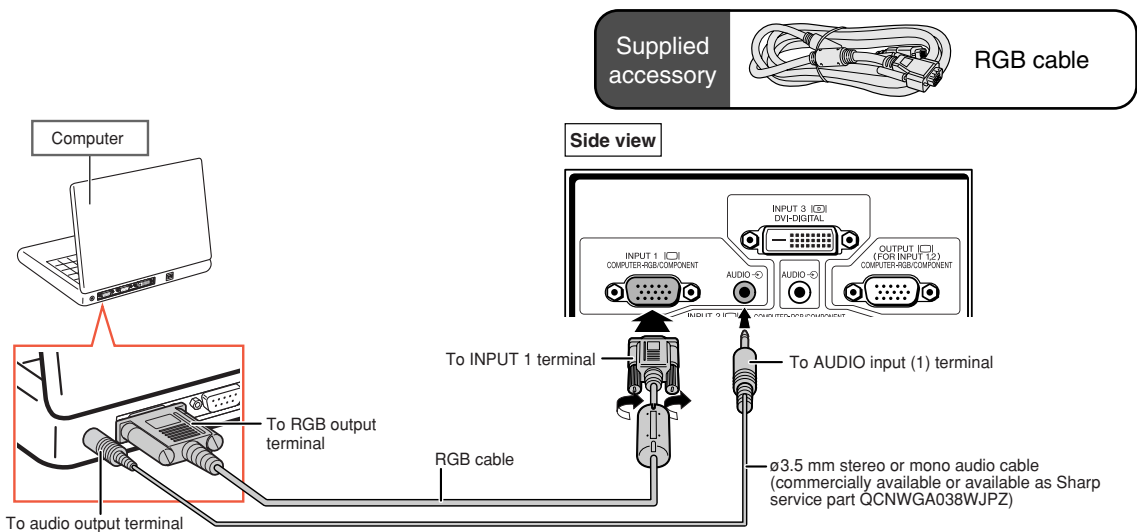

Note

- With this connection, the projector is not compatible to the sync on green signals.
- When using the Ø3.5 mm mono audio cable, the volume level will be half of when using the Ø3.5 mm stereo audio cable.

“Plug and Play” function (when connecting to a 15-pin terminal)

- This projector is compatible with VESA-standard DDC 1/DDC 2B. The projector and a VESA DDC compatible computer will communicate their setting requirements, allowing for quick and easy setup.
- Before using the “Plug and Play” function, **ensure to turn on the projector first and the connected computer last.**

Note

- The DDC “Plug and Play” function of this projector operates only when used in conjunction with a VESA DDC compatible computer.

Connecting with a 5 BNC to 15-pin D-sub Cable

The projector employs a 5 BNC computer input to prevent deterioration of image quality. When connecting the input terminals on the projector to the computer directly, connect the R (P_R), G/G sync (Y), B (P_B), HD/C sync and VD cables of the 5 BNC to 15-pin D-sub cable (commercially available) to the INPUT 2 terminals on the projector.

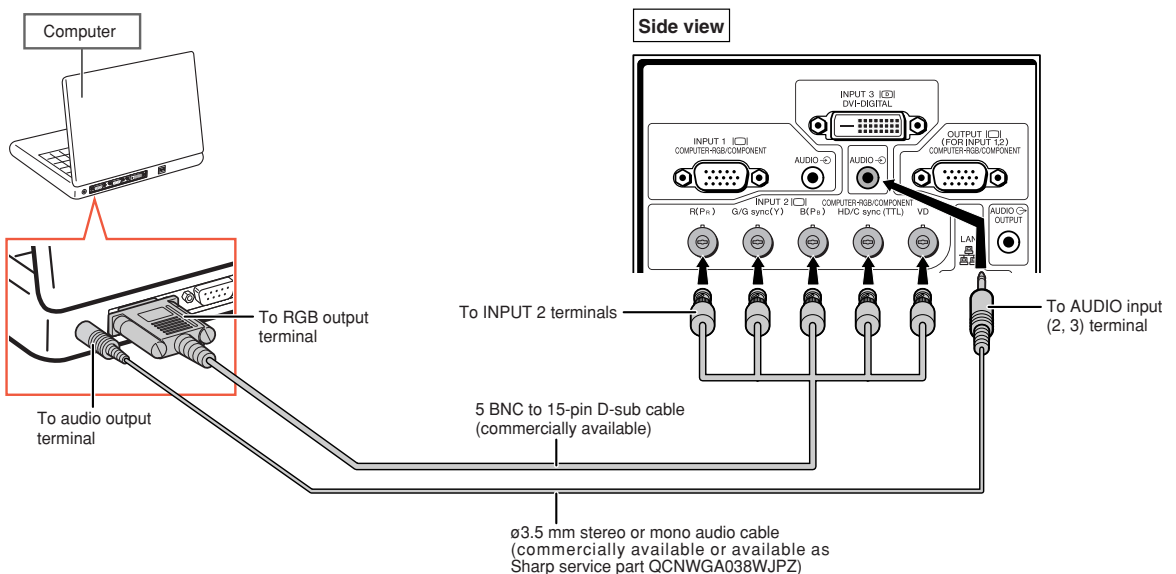

Note

- When connecting the projector to a compatible computer other than a PC (VGA/SVGA/XGA/SXGA/UXGA) or Macintosh (i.e. Workstation), a separate cable may be needed. Please contact your dealer for more information.
- When using the 0.35 mm mono audio cable, the volume level will be half of when using the 0.35 mm stereo audio cable.
- The HD/C sync terminal is only for TTL signal.

Connecting with a DVI Digital Cable

The projector employs the DVI digital input terminal for direct input of digital video signals from a computer.

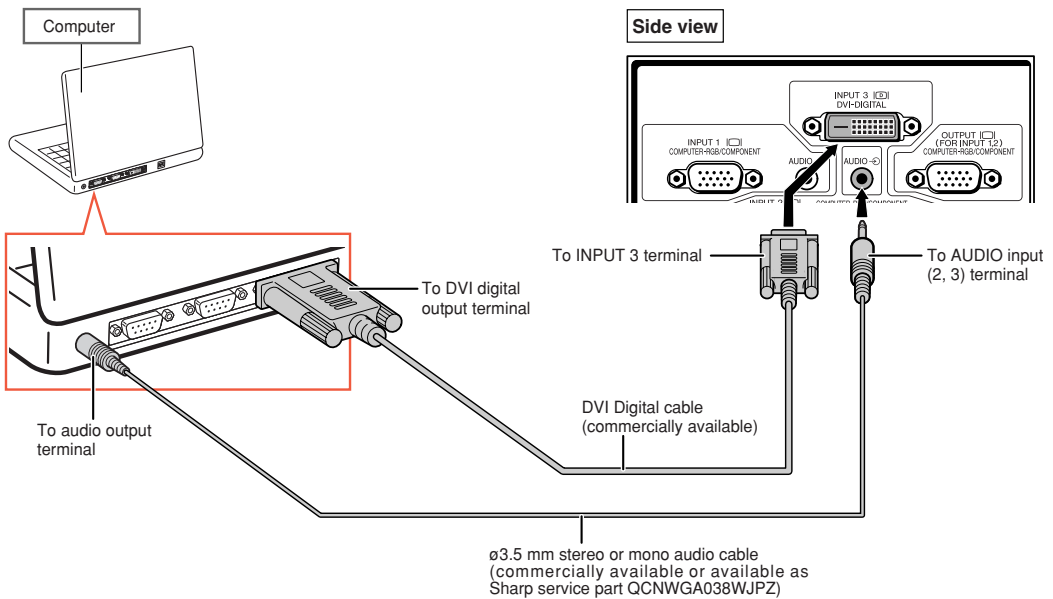

Note

- When connecting the projector to a computer in this way, select "D. PC RGB" for "Signal Type" in the "Picture" menu.
- When using the ø3.5 mm mono audio cable, the volume level will be half of when using the ø3.5 mm stereo audio cable.

Connecting to Video Equipment

Before connecting, ensure the power cord of the projector from the AC outlet is unplugged, and that the devices to be connected are turned off. After making all connections, turn on the projector and then the other devices.

The projector has a DVD digital terminal, computer-RGB/component terminal, S-video terminal and video terminal for video input. Refer to the listed illustrations on how to connect audio-visual equipment.

If your audio-visual equipment has an RGB output terminal or component output terminal, use the computer-RGB/component terminals (INPUT 1 or 2) on the projector for video connection.

Connecting to Video Equipment That Has an HDMI Output Terminal with a DVI to HDMI Cable

Use a DVI to HDMI cable when connecting HDMI video equipment such as DVD players to the INPUT 3 terminal.

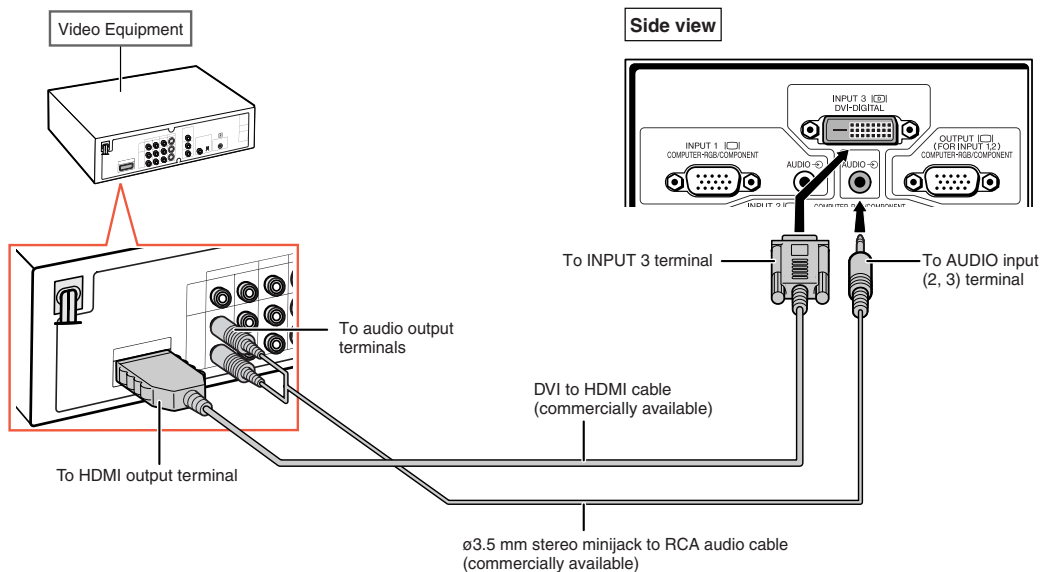

Note

- Select the input signal type of the video equipment. See page 63.
- While the projector is connected to video equipment that has an HDMI output terminal, only the video signal can be input to the projector. (Connect the AUDIO input (2, 3) terminal for audio input.)

Connecting to Video Equipment That Has a DVI Output Terminal with a DVI Digital Cable

Use a DVI Digital cable when connecting video equipment with the DVI output terminal such as DVD players to the INPUT 3 terminal.

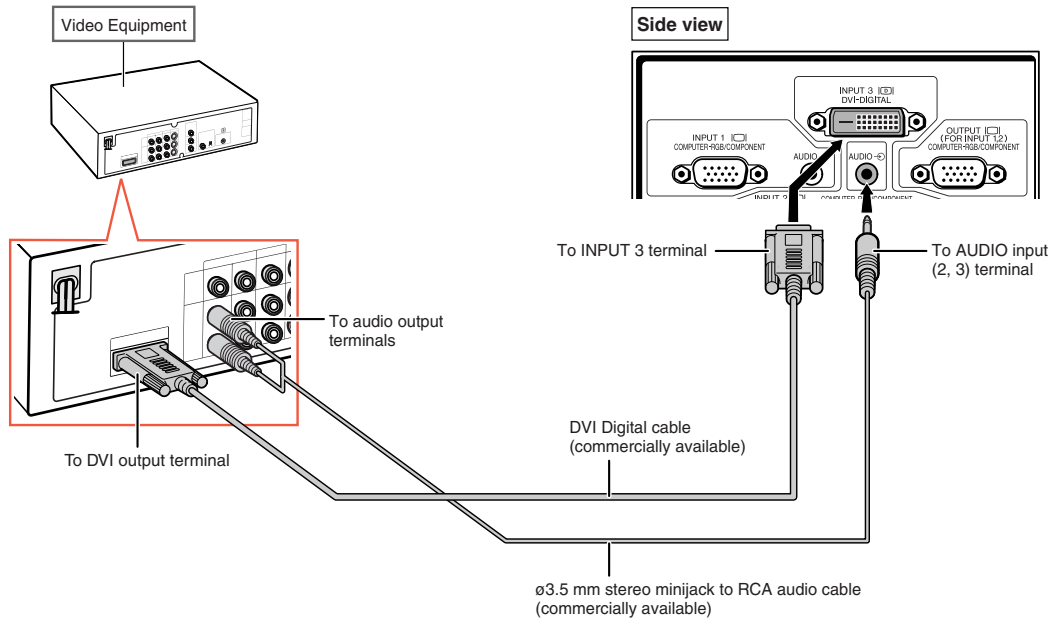

Note

- Select the input signal type of the video equipment. See page 63.

Connecting to RGB Video Equipment with a 5 RCA RGB Cable

Use a 5 RCA RGB cable when connecting the RGB video equipment such as DVD players and DTV* decoders to the INPUT 2 terminals.

* DTV is the umbrella term used to describe the new digital television system in the United States.

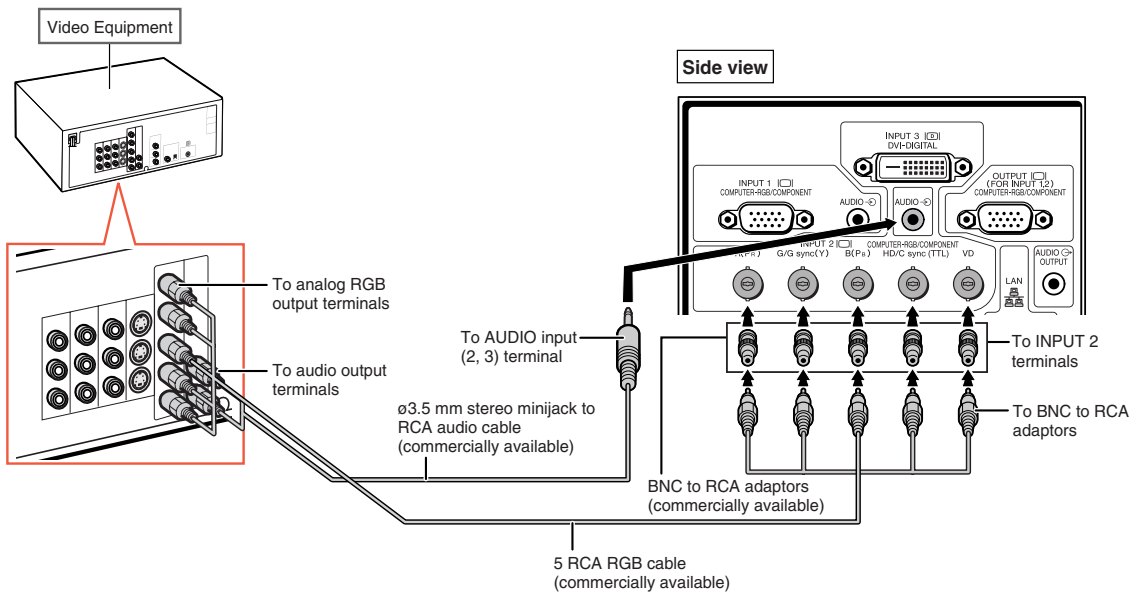

Note

- When connecting the projector to the video equipment in this way, select "RGB" for "Signal Type" in the "Picture" menu. See page 63.
- The HD/C sync and VD terminals may be used depending on the specifications of the DTV decoder connected to this projector. Please refer to the operation manual of the DTV decoder for details.
- The HD/C sync terminal is only for TTL signal.

Connecting to Video Equipment That Has Component Output Terminals

When connecting the video equipment that has component output terminals to the INPUT 1 terminal, use the 3 RCA to 15-pin D-sub cable (optional: AN-C3CP2).

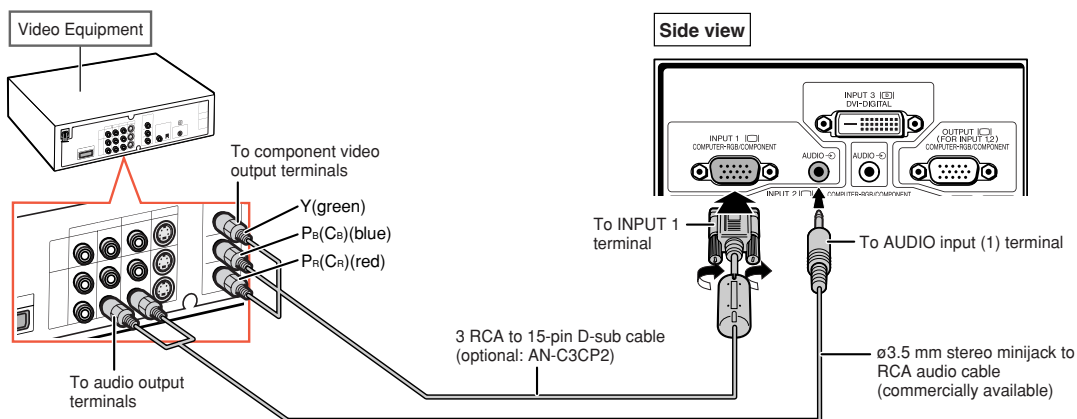

When connecting the video equipment that has component output terminals to the INPUT 2 terminals, use the BNC to RCA adapters (commercially available).

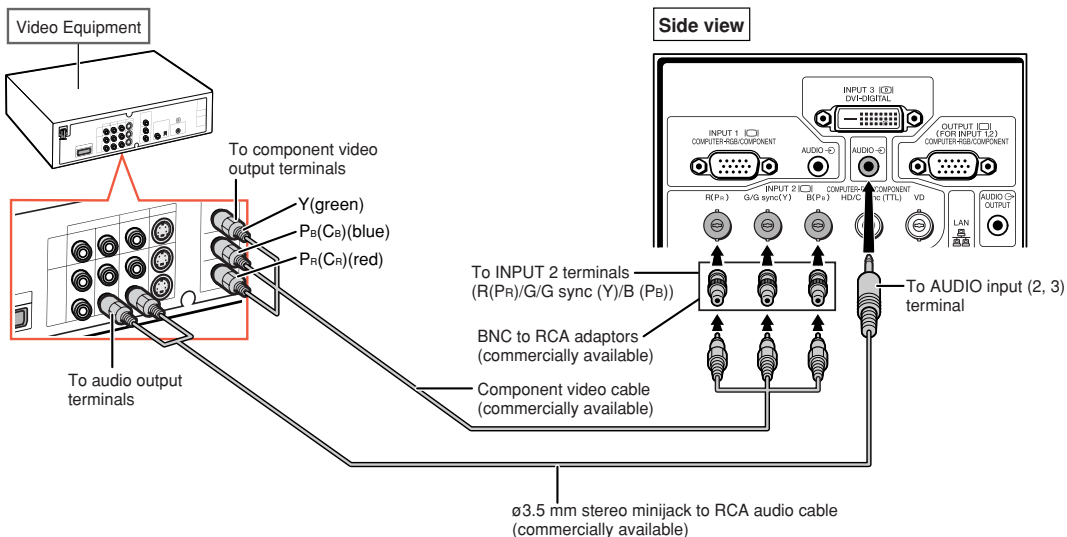

Note

- 0.5 mm stereo minijack to RCA audio cable (commercially available) is required for audio input.
- Select “480P/525P” or “576P/625P” for “Special Modes” on the “Fine Sync” menu, if necessary. (See page 69.)
- When you connect video equipment with a 21-pin RGB output (Euro-scart) to the projector, use a commercially available cable that fits in the projector terminal you want to connect.
- The projector does not support RGBC signals via the Euro-scart.

Connecting with an S-video Cable or a Composite Video Cable

Connect the video equipment to the INPUT 4 or 5 terminal using the S-video cable or composite video cable (commercially available).

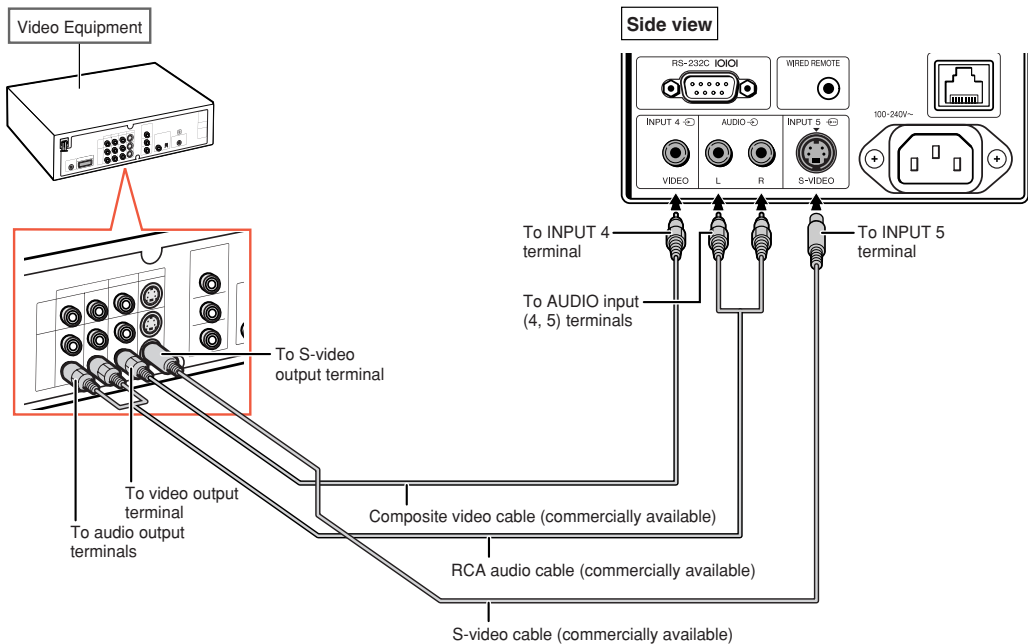

Note

- The S-video signal input to the S-VIDEO terminal is separated into color and luminance signals for realizing a higher-quality image.
- An RCA audio cable (commercially available) is required for audio input.
- When you connect video equipment with a 21-pin RGB output (Euro-scart) to the projector, use a commercially available cable that fits in the projector terminal you want to connect.

Controlling the Projector by a Computer

When the RS-232C terminal on the projector to the RS-232C serial terminal on the computer, or when the LAN terminal on the projector to the LAN terminal on the computer, the computer can be used to control the projector. Refer to the “SETUP GUIDE” contained on the supplied CD-ROM for details.

When connecting to a computer using an RS-232C serial control cable

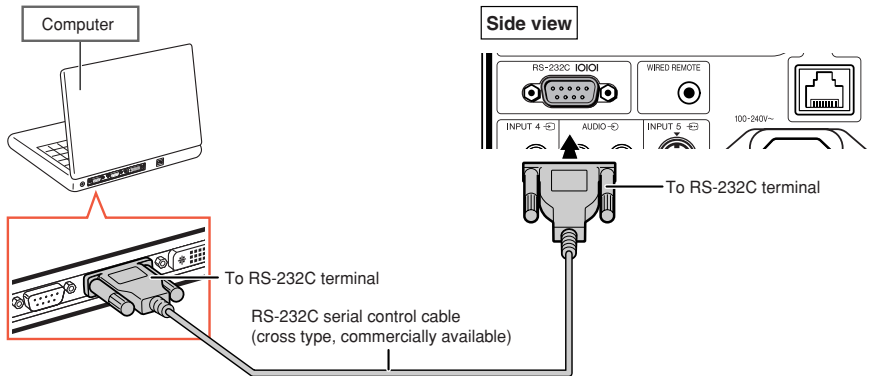

Note

- The RS-232C function may not operate if your computer terminal is not correctly set up. Refer to the operation manual of the computer for details.
- Refer to “SETUP GUIDE” contained on the supplied CD-ROM for the RS-232C specifications and commands.

Info

- Do not connect the RS-232C cable to a terminal other than the RS-232C terminal on the computer. This may damage your computer or projector.
- Do not connect or disconnect an RS-232C serial control cable to or from the computer while it is on. This may damage your computer.

When connecting to the LAN terminal using a LAN cable

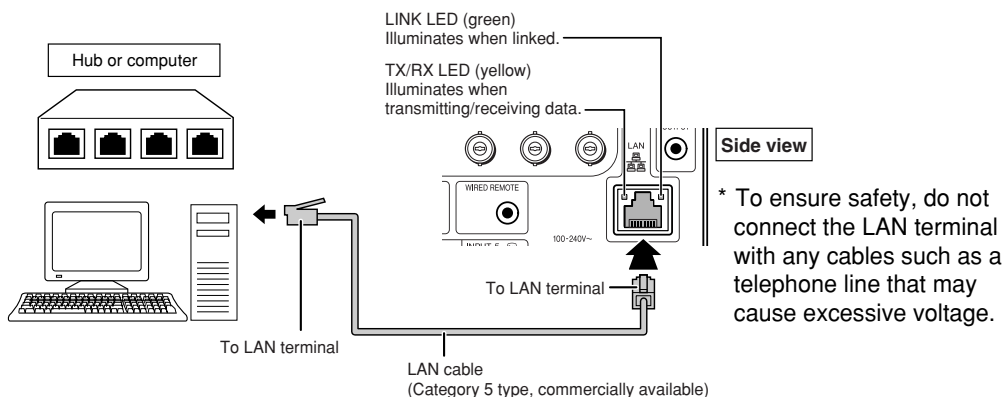

Note

- When connecting to a hub, use **straight-through** Category 5 (CAT.5) type cable (commercially available).
- When connecting to a computer, use **cross-over** Category 5 (CAT.5) type cable (commercially available).

Connecting to a Monitor That Has an RGB Input Terminal

You can display computer images on a monitor using the RGB cables.

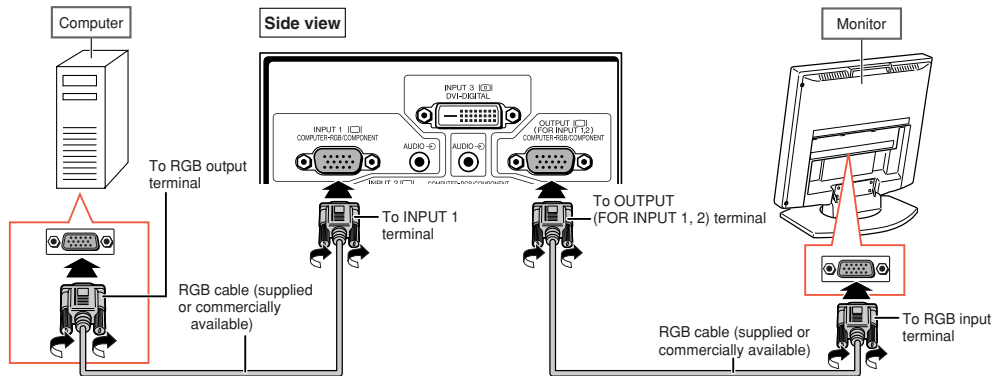

Note

- RGB signals and component signals input from the INPUT 1 or INPUT 2 terminals can be output to the monitor.
- For inputting video signals from the INPUT 1 terminal, another RGB cable (commercially available) is required.

Connecting to an Amplifier or Other Audio Equipment

Audio signals input from equipment connected to each audio input terminal of the projector can be output to audio equipment.

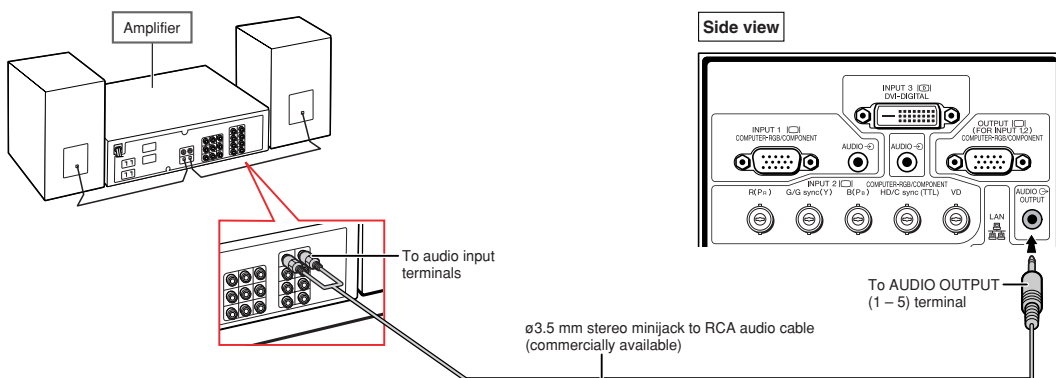

Note

- ø3.5 mm stereo minijack to RCA audio cable (commercially available) is required for audio input.
- When turning off the power in the case of connecting an amplifier or other audio equipment, first turn off the power of the amplifier and then turn off the power of the projector.
- By using external audio components, the volume can be amplified for better sound.
- For details on Variable Audio Output (VAO) and Fixed Audio Output (FAO), see page 72.



Turning the Projector On/Off

Connecting the Power Cord

Plug the supplied power cord into the AC socket on the rear of the projector.

Turning the Projector On

Before performing the steps in this section, connect any equipment that you use with the projector. (See pages 27—36.)



Remove the lens cap and press  on the projector or  on the remote control.

- The power indicator illuminates green.
- After the lamp indicator illuminates, the projector is ready to start operation.
- When System Lock is set, the keycode input screen appears. Enter the right keycode to start projection. See page 79 for details.

Note

- The lamp indicator illuminates or blinks, indicating the status of the lamp.
 - Green:** The lamp is ready.
 - Blinking green:** The lamp is warming up.
 - Red:** The lamp is shut down abnormally or the lamp should be replaced.
- When switching on the projector, a slight flickering of the image may be experienced within the first minute after the lamp has been illuminated. This is normal operation as the lamp's control circuitry is stabilizing the lamp output characteristics. This does not indicate malfunction.
- If the projector is put into standby mode and immediately turned on again, the lamp may take some time to illuminate.

Turning the Power Off (Putting the Projector into Standby Mode)

1 Press  on the projector or  on the remote control, then press that button again while the confirmation message is displayed, to put the projector into standby mode.

2 Unplug the power cord from the AC outlet after the cooling fan stops.

Supplied accessory

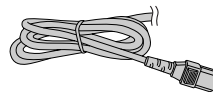

Power cord

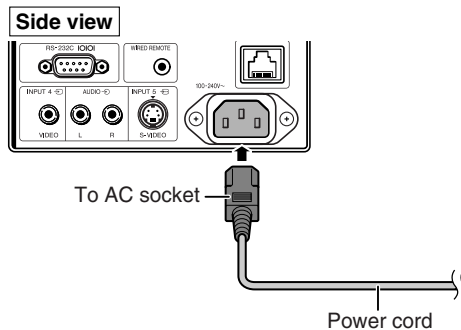

Info

- English is the factory preset language. If you want to change the on-screen display to another language, change the language according to the procedure on page 89.

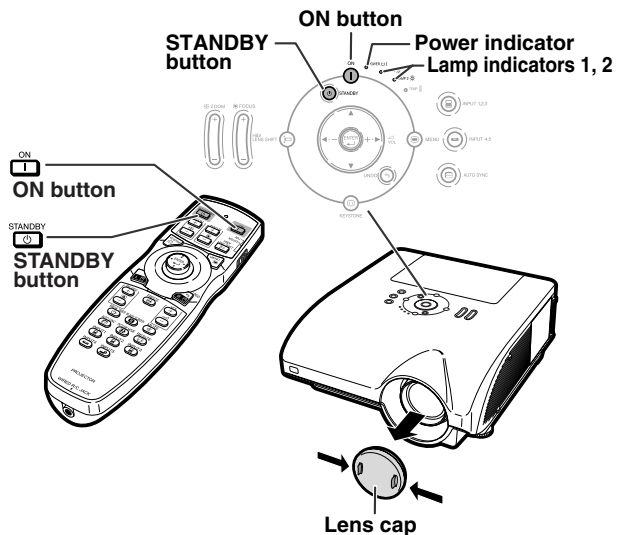

▼On-screen Display



Enter STANDBY mode?

Yes: Press Again No: Please Wait

Info

- Do not unplug the power cord during projection or cooling fan operation. The cooling fan in this projector continues to run for about 90 seconds after the projector enters the standby mode. This can cause damage due to rise in internal temperature, as the cooling fan also stops.

Shifting the Lens

In addition to the zoom function and adjustment of projection angle using the adjustment feet, you can adjust the position of the projection using the lens shift function. This is a useful function in cases such as when the screen can not be moved.

When moving upward or downward

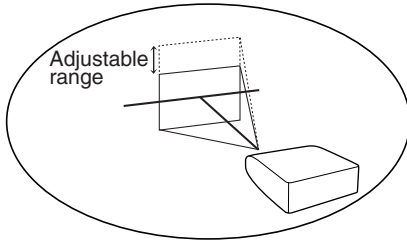

When moving in the left and right direction

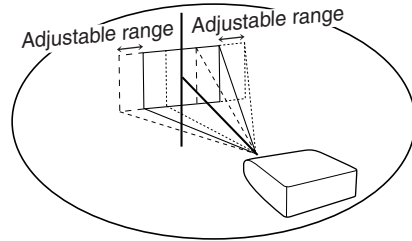

Adjustable range

The adjustable range is shown below.

Horizontal range: $\pm 15\%$

Vertical range: $+50\%$ (to the upper side)

The adjustable range has limitations even within the range shown above.

The image can be adjusted as shown on the diagram.

While the image is set to the upper left or upper right of the adjustable range, the corner of the image is masked with a shadow.

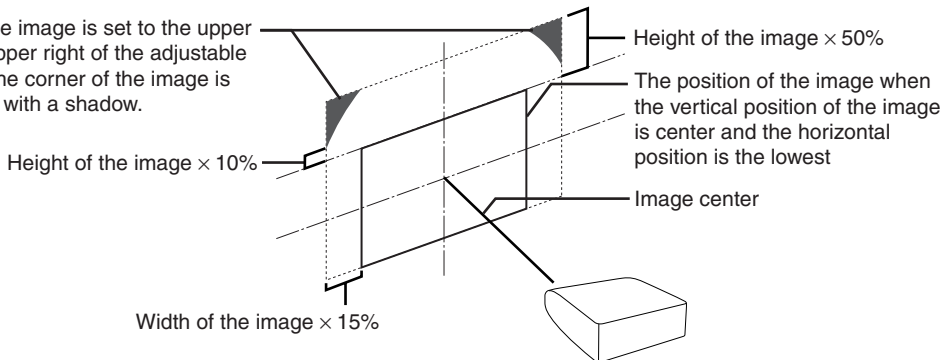

Note

- The adjustable range for the AN-PH10EX optional lens is different from the shown above. See the AN-PH10EX operation manual for details.

1 Press **H&V LENS SHIFT** on the projector or **H&V LENS SHIFT** on the remote control.

- Pressing **ENTER** on the projector or **ENTER** on the remote control displays the test pattern. Checking the test pattern is useful for more accurate adjustment.

▼On-screen Display

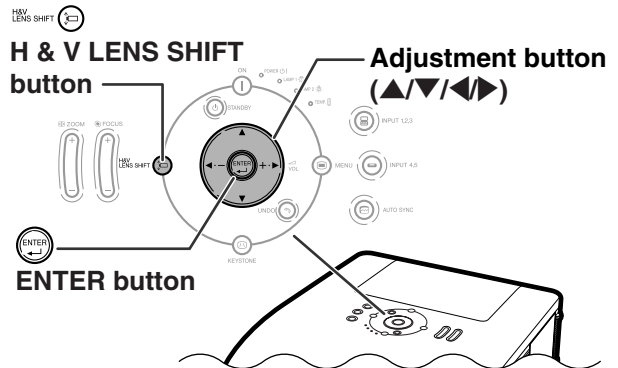
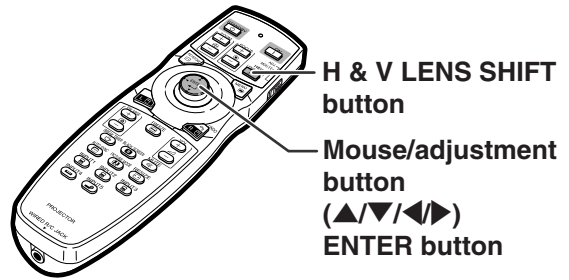
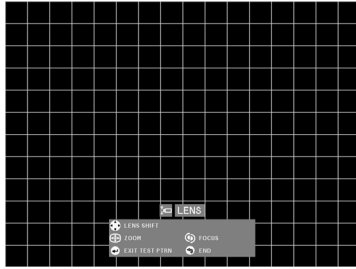

2 Press **▲, ▼, ◀ or ▶** on the projector or the remote control to adjust the image position.

Using the Adjustment Feet

- When the position of the projected image cannot be adjusted with the lens shift function, use the adjustment feet to adjust the projected angle.
- The height of the projector can be adjusted using the adjustment feet when the screen is located higher than the projector, the screen is inclined or when the installation site is slightly inclined.
- Install the projector so that it is as perpendicular to the screen as possible.

1 While lifting the projector, rotate the adjustment feet.



- The projector is adjustable up to approximately 9 degrees.

2 Lower the projector, and then rotate the adjustment feet for the fine adjustment.

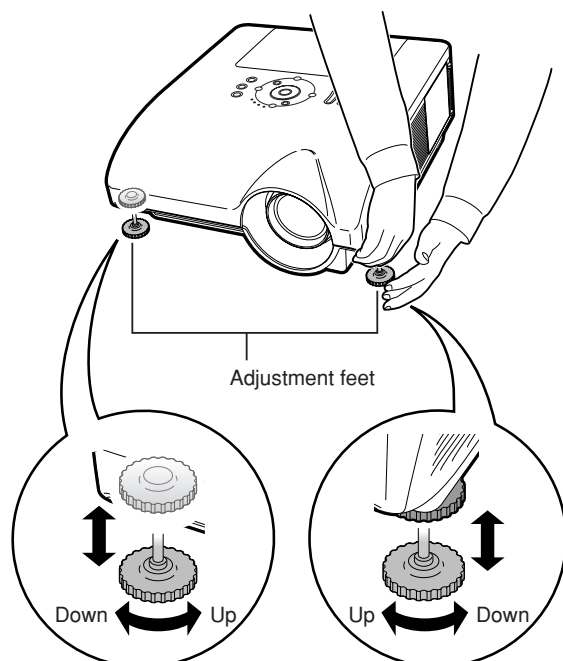
- When lowering the projector, be careful not to get your fingers caught in the area between the adjustment feet and the projector.



Adjusting the Focus

Press  on the projector or  on the remote control to adjust the focus.



▼On-screen Display

 LENS

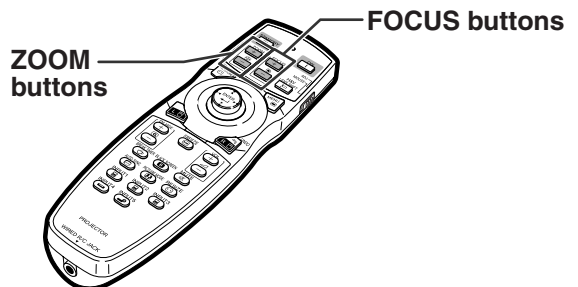
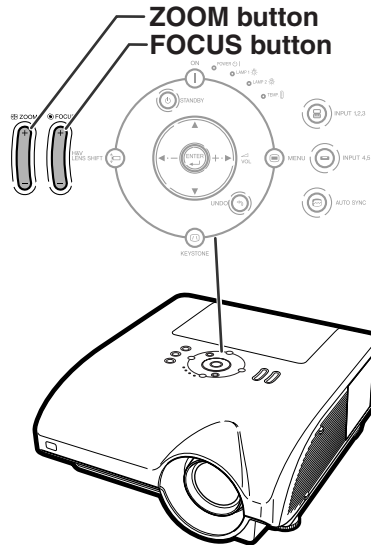
 LENS SHIFT	
 ZOOM	 FOCUS
 TEST PTRN	 END



Adjusting the Projected Image Size

Press  on the projector or  on the remote control to adjust the projected image size.

▼On-screen Display

 LENS

 LENS SHIFT	
 ZOOM	 FOCUS
 TEST PTRN	 END

Note

- After you have pressed the FOCUS buttons or the ZOOM buttons on the remote control or the projector, you can display the test pattern by pressing the ENTER button. The test pattern is useful for making more accurate adjustments.
- For fine adjustments, when pressing the H & V LENS SHIFT buttons, the FOCUS buttons or the ZOOM buttons, the projected image moves a small amount toward the desired direction for approximately one second. Hold down the buttons to move the projected image quickly.

Correcting Trapezoidal Distortion



When the image is projected either from the top or from the bottom towards the screen at an angle, the image becomes distorted trapezoidally. The function for correcting trapezoidal distortion is called **Keystone Correction**.

There are the two types of the Keystone Correction.

- 1) "GEOMETRIC ADJUSTMENT" for correcting an image designating the corner of the projected image
- 2) "H & V KEYSTONE"/"IMAGE RESIZING" for correcting an image designating the horizontal and vertical axes

Selecting the Type of the Keystone Correction

Press  on the projector or  on the remote control.

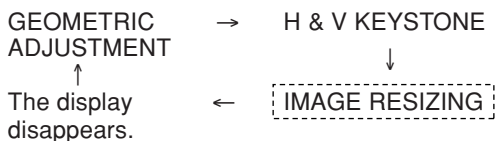

- "GEOMETRIC ADJUSTMENT" will be displayed.
- Each time  or  is pressed, the display toggles as follows:



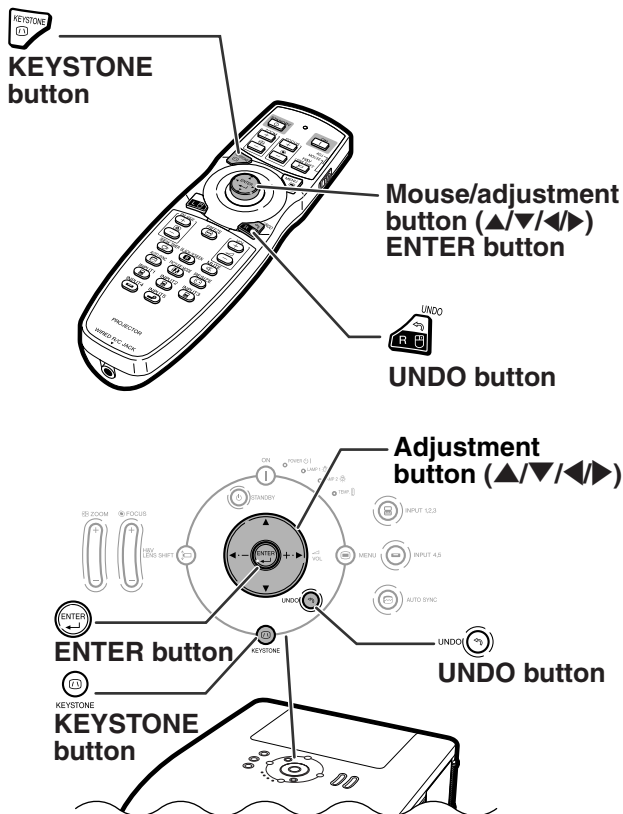







GEOMETRIC ADJUSTMENT	For correcting an image designating the corner of the projected image
H & V KEYSTONE	For correcting an image designating the horizontal or vertical axes
IMAGE RESIZING	For correcting the image distortion. Only when "H & V KEYSTONE" is set to the values other than "0", "IMAGE RESIZING" works.









GEOMETRIC ADJUSTMENT

1 Press  on the projector or  on the remote control repeatedly until “GEOMETRIC ADJUSTMENT” is displayed.

2 Press the buttons below to adjust the position, size or focus of the projected image.

- Match screen’s four sides to green test pattern.
- Pressing , ,  or  on the projector or  on the remote control allows you to shift the lens.
- Pressing  on the projector or  on the remote control allows you to adjust the projected image size.
- Pressing  on the projector or  on the remote control allows you to adjust the focus.





3 Press  on the projector or  on the remote control.

4 Press , ,  or  to move the position for the upper left of the image.

- Move the upper left of the yellow frame onto the upper left of the screen.

5 Press  or  to set the position.

6 Repeat the same procedure with the positions for the upper right, lower right and lower left of the image.

- At this time, pressing  on the projector or  on the remote control returns to the previous screen.
- Before correcting the upper left of the image, pressing  or  returns to the reset confirmation screen.
- **When the position of the lower left is set, the correction is made and the display disappears.**

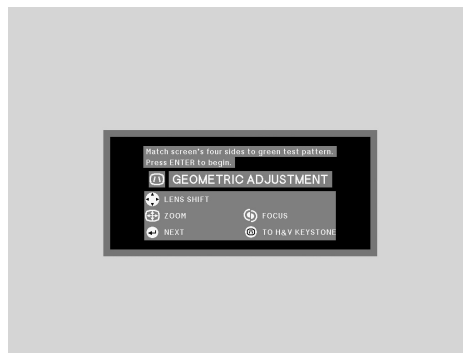

▼ On-screen Display



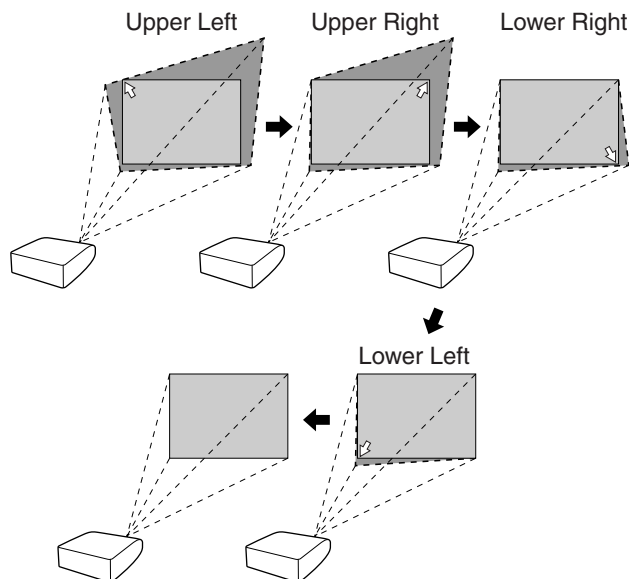



Geometric Adjustment



H & V KEYSTONE

1 Press  on the projector or  on the remote control repeatedly until “H & V KEYSTONE” is displayed.

- When the correction has already been made with “GEOMETRIC ADJUSTMENT”, the confirmation message for resetting the correction before “H & V KEYSTONE” is displayed.

2 Press , ,  or  to move the position for the horizontal or vertical axes.

3 Press  or  to set the position.

- When “H & V KEYSTONE” is set to the values other than “0”, “IMAGE RESIZING” is displayed.

▼On-screen Display

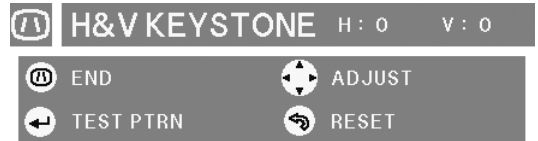

Horizontal Keystone Correction (Adjustment with ◀ / ▶)

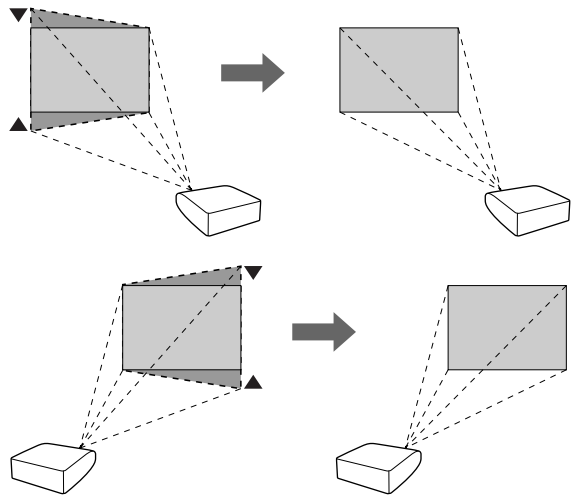

Vertical Keystone Correction (Adjustment with ▲ / ▼)

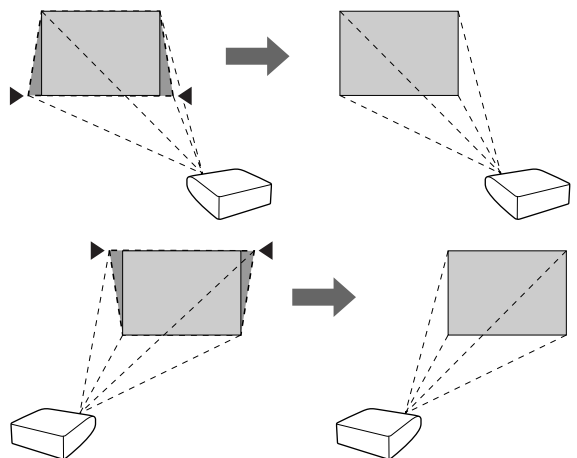



IMAGE RESIZING

Only when “H & V KEYSTONE” is set to the values other than “0”, “IMAGE RESIZING” works.

1 Press  on the projector or  on the remote control repeatedly until “IMAGE RESIZING” is displayed.



2 Press , ,  or  to correct the image distortion.

3 Press  or  to set the position.



▼On-screen Display





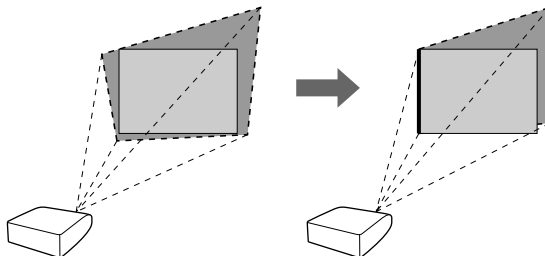

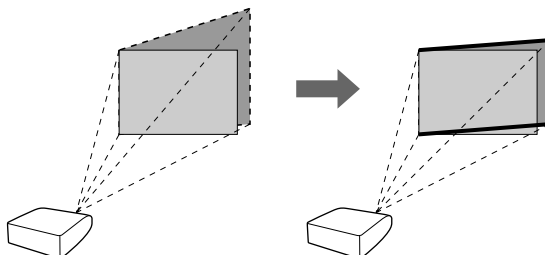

Using H & V KEYSTONE Adjustment When the Image Is Projected Diagonally

1 Press  or  to parallelize the left and right sides of the projected image.



2 Press  or  to parallelize the upper and lower sides of the projected image.



3 Press  on the projector or  on the remote control to display “IMAGE RESIZING” and then press , ,  or  to correct the image distortion.

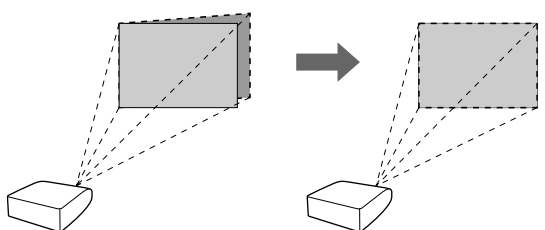

Switching the Input Mode

Select the appropriate input mode for the connected equipment.

Press , , ,  or  on the remote control to select the input mode.

- When pressing  on the projector, the input mode switches in order of :

→ INPUT 1 → INPUT 2 → INPUT 3 →

- When pressing  on the projector, the input mode switches between “INPUT 4” and “INPUT 5”.

Note

- When no signal is received, “NO SIGNAL” will be displayed. When non-supported signal is received, “NOT REG.” is displayed.
- When “Auto Search” of the “Options (1)” menu is set to “ON”, the input mode with signal can automatically be detected and displayed. (See page 78.)
- The input mode is not displayed when “OSD Display” of the “Options (1)” menu is set to “Level A” or “Level B”. (See page 75.)

About the Input mode

INPUT 1/ INPUT 2 (RGB/ component)	Used for projecting images from equipment that sends RGB signals or component signals connected to the INPUT 1 or 2 terminals.
INPUT 3 (digital PC RGB/digital PC compo- nent/digital video RGB/ digital video component)	Used for projecting images from equipment connected to the INPUT 3 terminal.
INPUT 4 (video)	Used for projecting images from equipment connected to the INPUT 4 terminal.
INPUT 5 (S-video)	Used for projecting images from equipment connected to the INPUT 5 terminal.

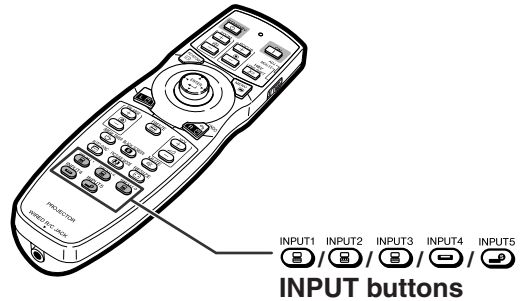



▼ On-screen Display of Input Mode (Example)

When pressing .

INPUT 1/2/3 mode



Using RGB

* The “INPUT 3” display is an example. (When “Signal Type” is set to “D. PC RGB”)

Using component

* The “INPUT 3” display is an example. (When “Signal Type” is set to “D. PC Comp.”)

When pressing .

INPUT 4 mode

Using video







INPUT 5 mode

Using S-video





When “Auto Search” is set to “ON”

- Pressing  or  once displays the current input mode.
- Pressing  or  again starts the automatic input search.

Adjusting the Volume

Press ◀/▶ on the projector or  on the remote control to adjust the volume.

 **Note**

- Pressing  or ◀ will lower the volume.
- Pressing  or ▶ will raise the volume.

Turning off the Sound Temporarily



Press  on the remote control to temporarily turn off the sound.

 **Note**

- Pressing  again will turn the sound back on.

Displaying an Enlarged Portion of an Image

Graphs, tables and other portions of projected images can be enlarged. This is helpful when providing more detailed explanations.

- 1 Press  on the remote control.
 - Enlarges the image.
 - Pressing  or  enlarges or reduces the projected image.

 **Note**

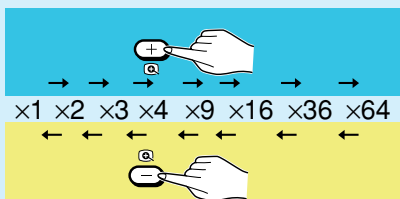

- You can change the location of the enlarged image using ▲, ▼, ◀ and ▶.

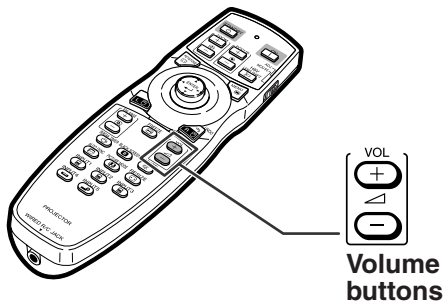

Volume buttons

▼ On-screen Display

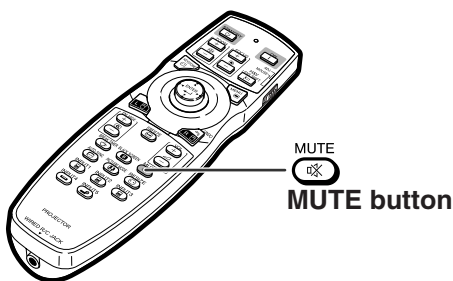

MUTE button

▼ On-screen Display



Mouse/adjustment button (▲/▼/◀/▶)

 / 
ENLARGE (enlarge/reduce) buttons





UNDO button
RESIZE button

2 Press on the remote control to cancel the operation.

- The magnification then returns to $\times 1$.

Note

In the following cases, the image will return to the normal size ($\times 1$).

- When switching the input mode.
- When  has been pressed.
- When the input signal is changed.
- When the input signal resolution and refresh rate (vertical frequency) change.
- When  has been pressed.

Freezing a Moving Image

1 Press on the remote control.

- The projected image is frozen.

2 Press again to return to the moving image from the currently connected equipment.



Selecting the Picture Mode

You can select the suitable picture mode for the projected image, such as movie or video game.

Press on the remote control.

- When pressing  , the picture mode changes in order of

→ STANDARD → PRESENTATION → CINEMA → CUSTOM →

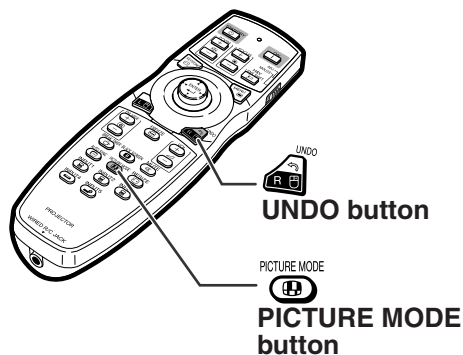



Note

- Press  to return to the “STANDARD” mode.
- This function can also be accessed from the OSD menu (see page 60).

This function allows you to modify or customize the resize mode to enhance the input image. Depending on the input signal, you can choose “NORMAL”, “FULL”, “DOT BY DOT”, “BORDER”, “STRETCH” or “SMART STRETCH” image.

Resize Mode

Press  on the remote control.

- Pressing  changes the display as shown.
- To return to the standard image, press  while “RESIZE” is displayed on the screen.
- This function can also be accessed from the OSD menu (see page 74).

Mouse/adjustment button
(▲/▼/◀/▶)



UNDO button







RESIZE button

COMPUTER

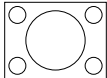
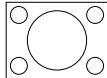
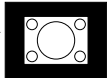
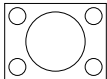
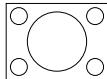
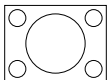
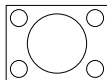
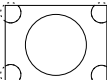
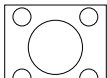
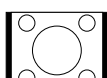
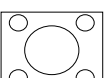
		NORMAL	FULL	DOT BY DOT
4:3 aspect ratio	SVGA (800 × 600)	1024 × 768	—	800 × 600
	XGA (1024 × 768)	1024 × 768	—	—
	SXGA (1280 × 960)	1024 × 768	—	1280 × 960
	UXGA (1600 × 1200)	1024 × 768	—	1600 × 1200
Other aspect ratios	SXGA (1280 × 1024)	960 × 768	1024 × 768	1280 × 1024

- “NORMAL” is fixed when XGA (1024 × 768) signals are entered.

Input signal		Output screen image		
Computer	Image type	NORMAL	FULL	DOT BY DOT
Resolution lower than XGA	 4:3 aspect ratio		—	
XGA	 4:3 aspect ratio		—	—
Resolution higher than XGA	 4:3 aspect ratio		—	
SXGA (1280 × 1024)				

 : Cutout area on which images cannot be projected.
 : Area where the signals are off screen.



VIDEO

		NORMAL	FULL	BORDER	STRETCH	SMART STRETCH
480I, 480P, 576I, 576P, NTSC, PAL, SECAM	4:3 aspect ratio, letter box, squeeze	1024 × 768	—	768 × 576*	1024 × 576*	1024 × 576*
540P	16:9 aspect ratio	—	1024 × 768	—		—
720P, 1035I, 1080I	16:9 aspect ratio	—	—	—		—

• "STRETCH" is fixed when 720P, 1035I or 1080I signals are entered.

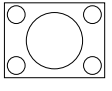
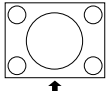
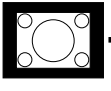
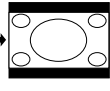
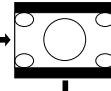
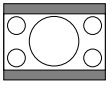
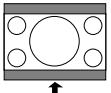
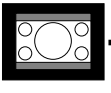
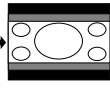
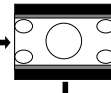
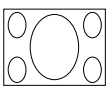
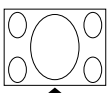
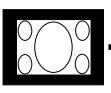
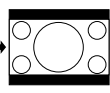
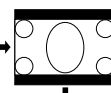
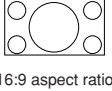
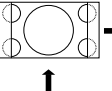
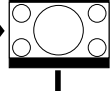
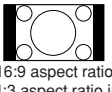
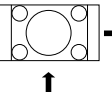
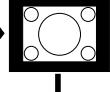
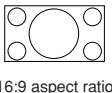
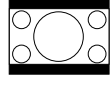

* The "Digital Shift" function can be used with these images.

Input signal		Output screen image				
DTV/video	Image type	NORMAL	FULL	BORDER	STRETCH	SMART STRETCH
480I, 480P, 576I, 576P, NTSC, PAL, SECAM	 4:3 aspect ratio		—			
	 Letter box		—			
	 Squeeze		—			
540P	 16:9 aspect ratio	—			—	—
	 16:9 aspect ratio (4:3 aspect ratio in 16:9 screen)	—			—	—
720P, 1035I, 1080I	 16:9 aspect ratio	—	—	—		—

 : Cutout area on which images cannot be projected.
 : Area on which the image is not included in the original signals.

Displaying the Black Screen

This function allows you to temporarily display the black screen.

- 1 Press  .
- 2 Pressing  again will turn the projected image back on.

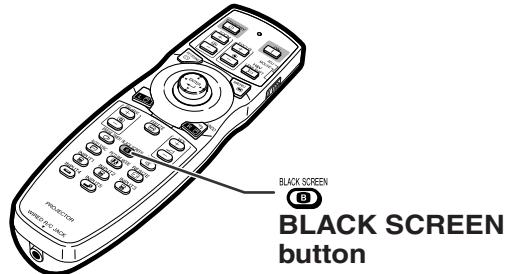



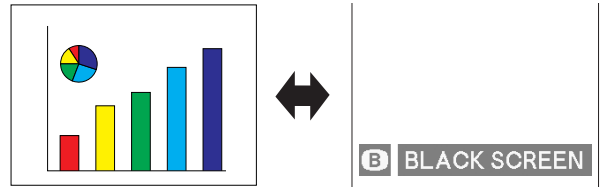







▼Projected Image



Displaying and Setting the Break Timer

This function allows you to show the remaining time for break during meeting.

- 1 Press  .
- 2 While “” is displayed, press , ,  or  to set the break timer.
 - You can set anywhere between 1 and 60 minutes (in 1 units).
 - The break timer starts to count down as soon as , ,  or  is pressed.

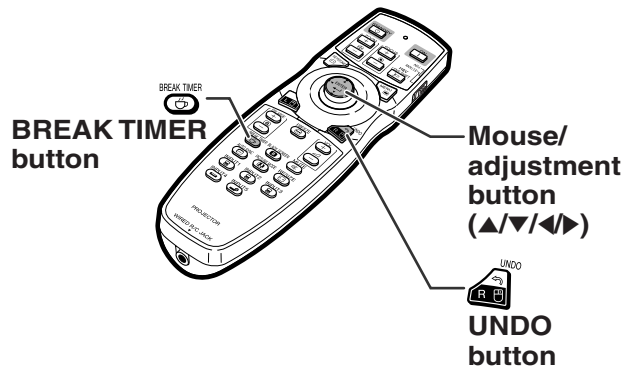

▼On-screen Display



Note

- Pressing  will cancel the break timer.
- Auto Power Off function will be temporarily disabled during the break timer. When no input signal is detected for more than 15 minutes, the projector will automatically enter the standby mode if the break timer has elapsed.
- The break timer will be displayed on the startup image. To change the screen displayed during the break timer, change the setting of “Startup Image” (see page 77).
- When “Slave” is set for “Stack Setting”, the break timer is not displayed. (See page 84.)

Menu Items

The following shows the items that can be set in the projector.

“Picture” menu

INPUT 1 / INPUT 2 / INPUT 3

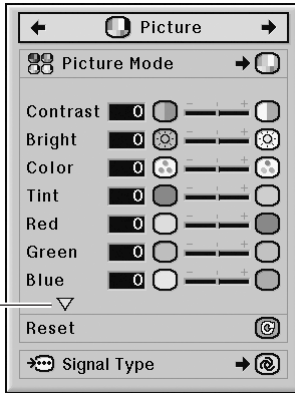

Pressing ∇ displays the items on the lower part of the “Picture” menu.

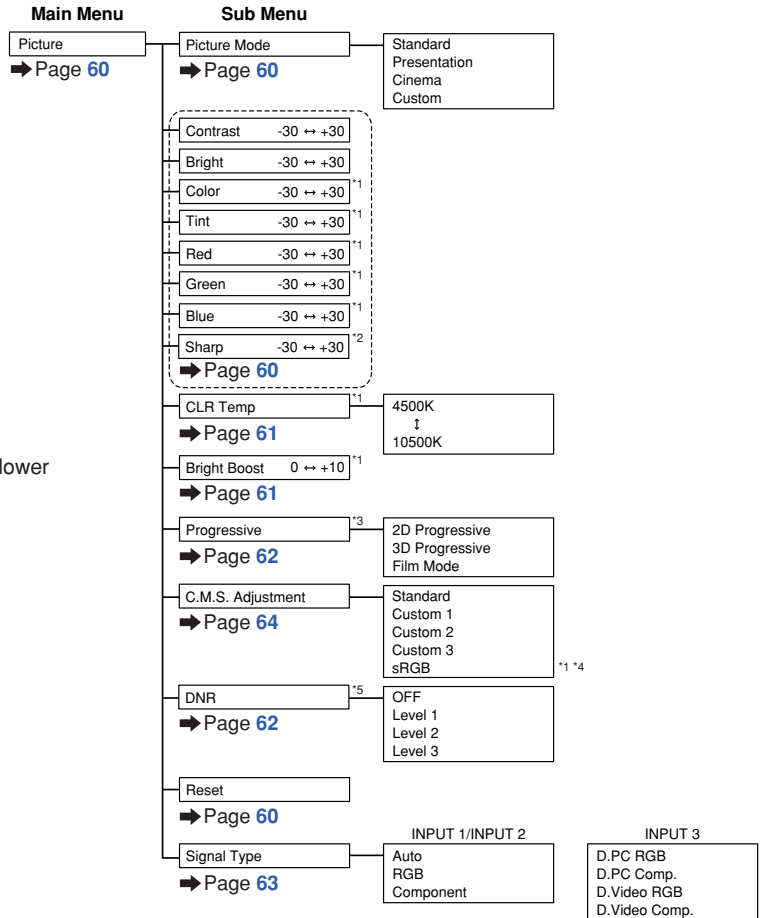
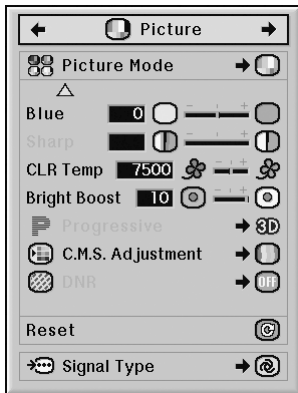

- *1 “Color”, “Tint”, “Red”, “Green”, “Blue”, “CLR Temp” and “Bright Boost” cannot be adjusted when “C. M. S. Adjustment” is set to “sRGB”.
- *2 “Sharp” can be adjusted only when 480I, 480P, 540P, 576I, 576P, 720P, 1035I, or 1080I signal is input.
- *3 “Progressive” can be adjusted only when 480I or 576I signal is input.
- *4 “sRGB” can be selected under the conditions below.
 - When “Signal Type” is set to “RGB”, “D. PC. RGB” or “D. Video RGB”
 - When “Signal Type” is set to “Auto” and the input signal is distinguished as “RGB”.
- *5 “DNR” can be adjusted only when 480I, 480P, 576I or 576P signal is input.

“Picture” menu

INPUT 4 / INPUT 5

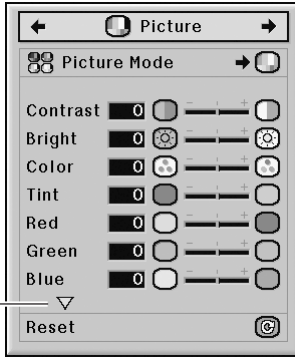

Pressing ∇ displays the items on the lower part of the “Picture” menu.

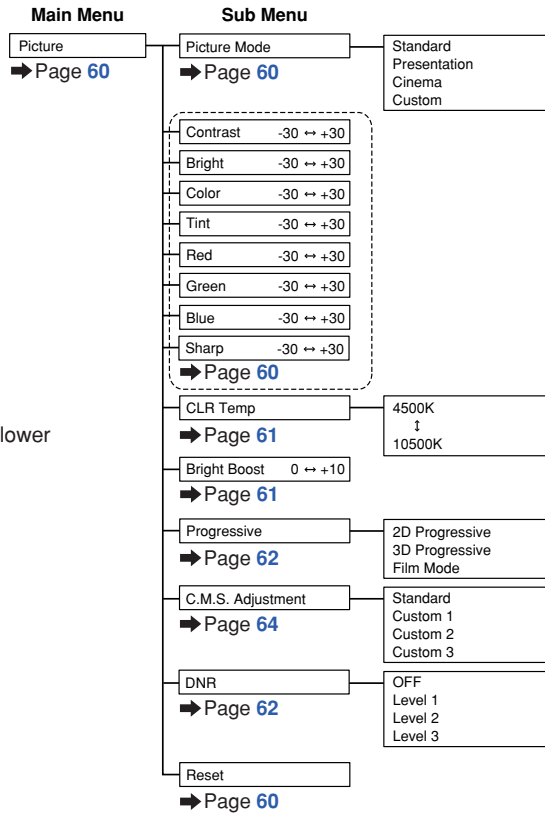
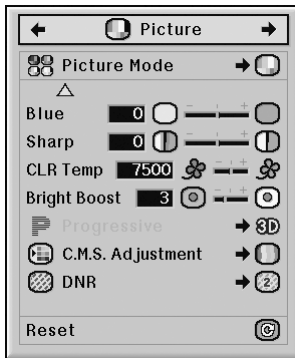

“C.M.S.” menu

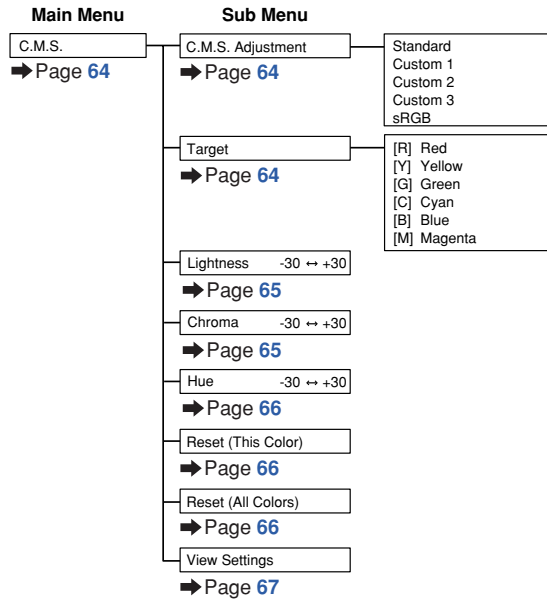
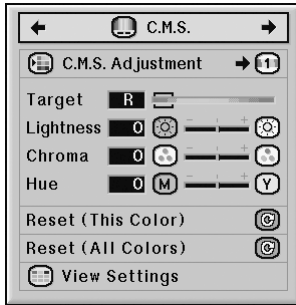

“Fine Sync” menu

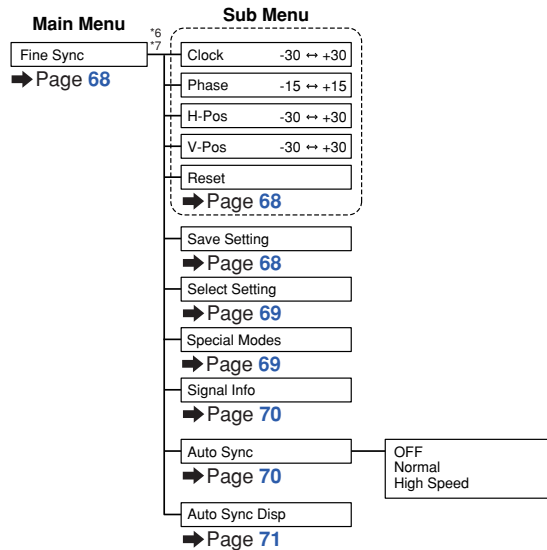
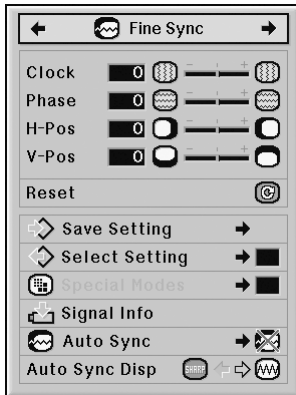

*6 The “Fine Sync” menu is displayed only while the input mode is INPUT 1, INPUT 2 or INPUT 3.

*7 “Clock”, “Phase”, “H-Pos”, “V-Pos”, “Reset”, “Save Setting”, “Select Setting” and “Special Modes” can be adjusted only while the input mode is INPUT 1 or INPUT 2.

“Audio” menu

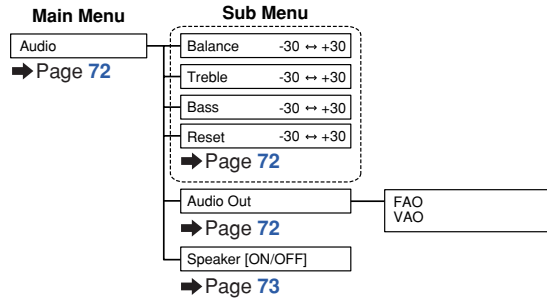
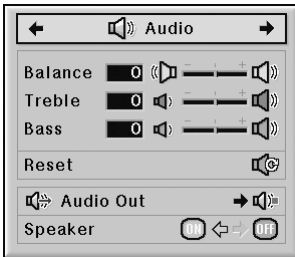

“Options (1)” menu

INPUT 1 / INPUT 2 / INPUT 3

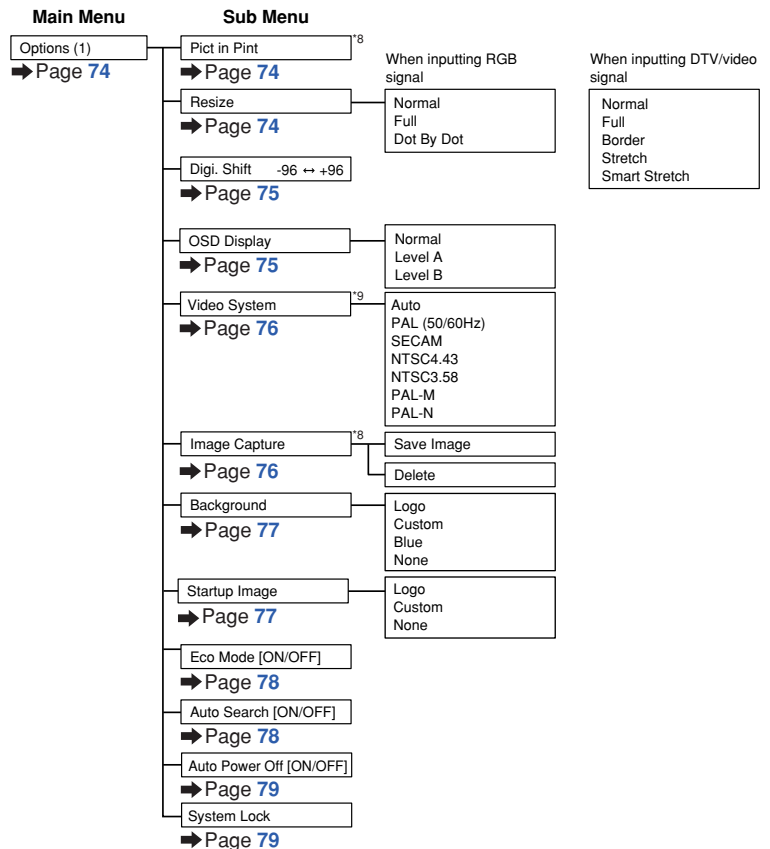
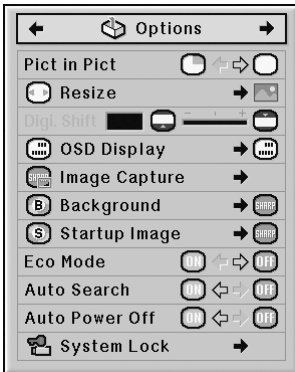

*8 Item when inputting RGB signal through INPUT 1, INPUT 2 or INPUT 3

*9 Item when selecting INPUT 4 or INPUT 5

“Options (2)” menu

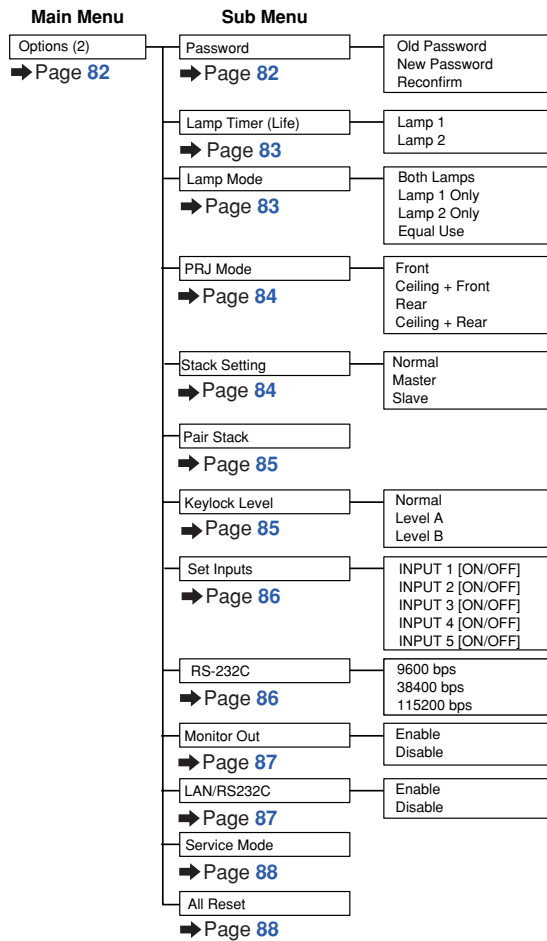
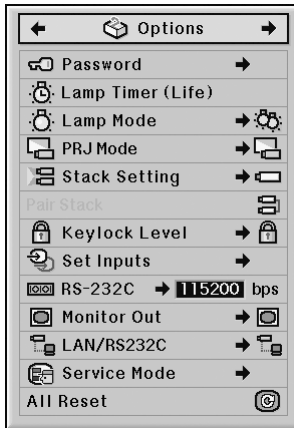

“Language” menu

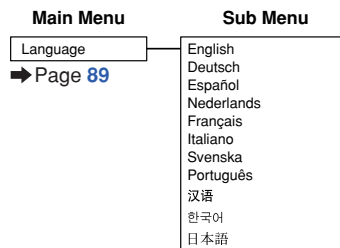

“Status” menu

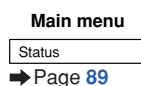

Using the Menu Screen

The menu can be operated to achieve two functions, adjustments and settings. (For setting the menu items, see pages 58 and 59.)

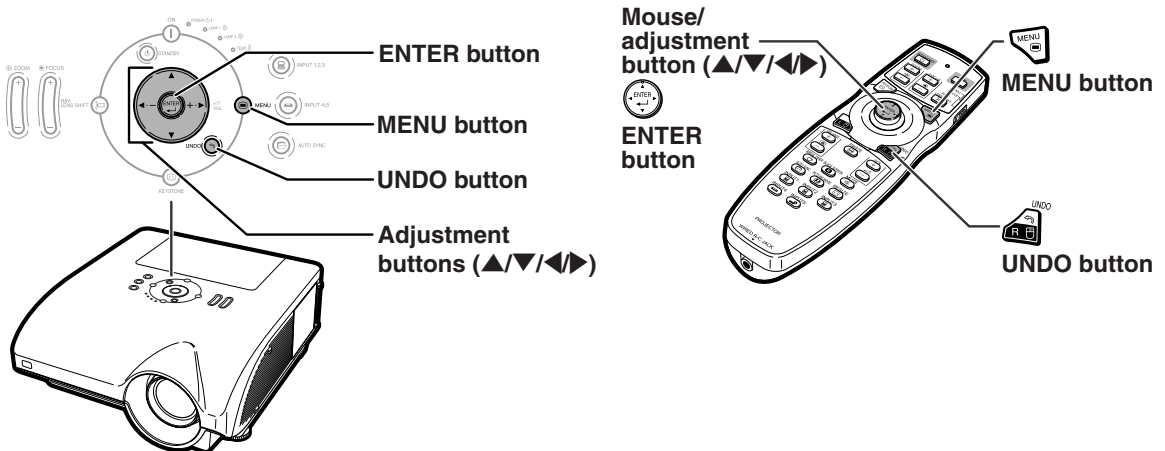

Menu Selections (Adjustments)

Example: Adjusting “Bright”

• This operation can also be performed by using the buttons on the projector.







1 Press .

• The “Picture” menu screen for the selected input mode is displayed.

2 Press  or  to display the other menu items.



• There are eight menu items as shown below.

Menu item
 Picture
 C.M.S.
 Fine Sync
 Audio
 Options
 Options
 Language
Status

Note

• The “Fine Sync” menu is not available for selecting INPUT 4 or INPUT 5.

Example: “Picture” screen menu for INPUT 1 (RGB) mode

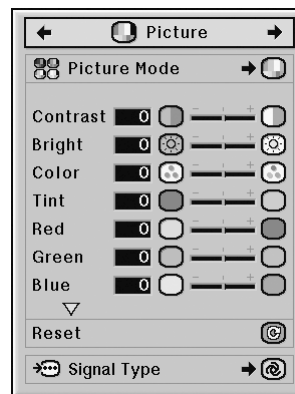

3 Press ▲ or ▼ to select the item you want to adjust.

- Pressing ▼ displays the items on the lower part of the “Picture” menu.

To adjust the projected image while viewing it

Press .

- The selected single adjustment item (e.g. “Bright”) appears instead of the menu.
- When pressing ▲ or ▼, the following item (“Color” after “Bright”) will be displayed.

Note

- Press  to return to the previous screen.

Single adjustment item

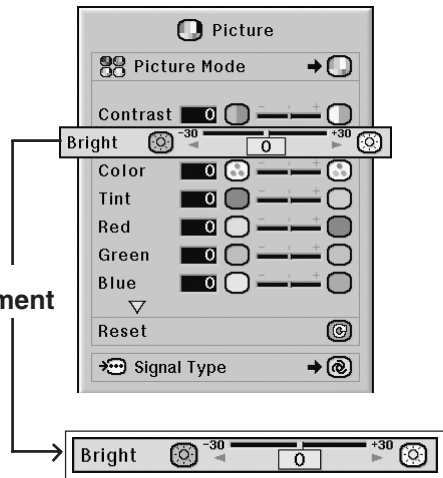

4 Press ◀ or ▶ to adjust the item selected.

- The adjustment is stored.

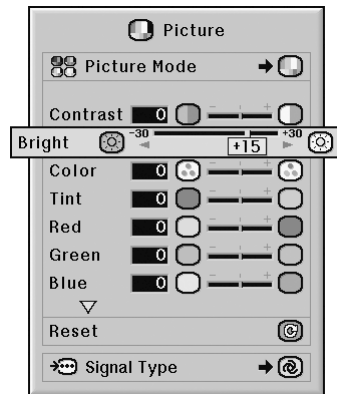

5 Press .

- The menu screen will disappear.

Using the Menu Screen

The menu can be operated to achieve two functions, adjustments and settings. (For adjusting the menu items, see pages 56 and 57.)

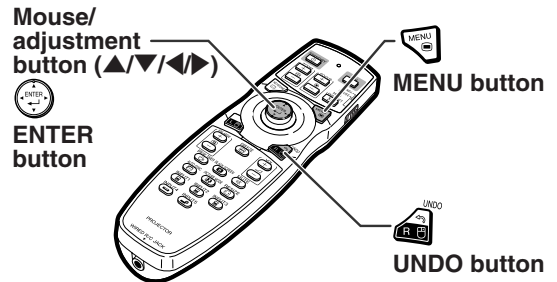

Menu Selections (Settings)

Example: Setting “OSD Display”

- This operation can also be performed by using the buttons on the projector.

1 Press .

- The “Picture” menu screen for the selected input mode is displayed.

Example: “Picture” screen menu for INPUT 1 (RGB) mode

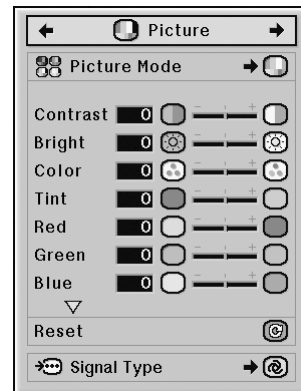

2 Press ◀ or ▶ to display the other menu items.



- There are eight menu items as shown below.

Menu item
Picture
C.M.S.
Fine Sync
Audio
Options
Options
Language
Status

Note

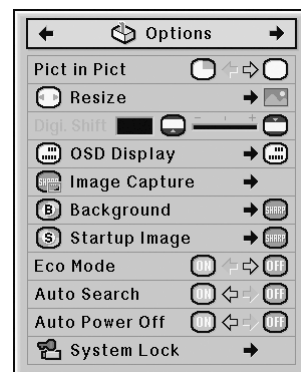

- The “Fine Sync” menu is not available for selecting INPUT 4 or INPUT 5.

Example: “Options (1)” screen menu



3 Press ▲ or ▼ to select the item you want to set.

 **Note**

- Press  to return to the previous screen.
- In some menu, select the icon using .

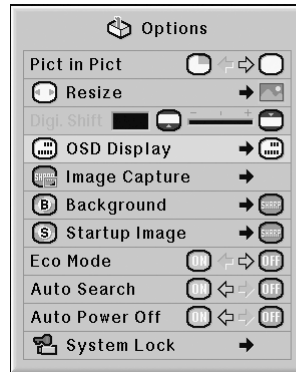

Sub menu

4 Press ► to shift the cursor to the sub menu.

5 Press ▲ or ▼ to select the setting of the item displayed in the sub menu.

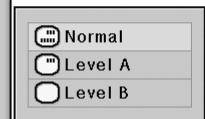
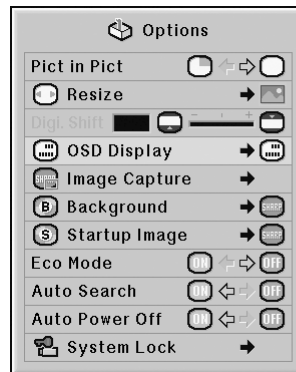

6 Press .

- The selected item is set.

 **Note**

- Some adjustment items will display a confirmation message. When setting an item, press ◀ or ▶ to select “Yes” or “OK”, press .

7 Press .

- The menu screen will disappear.

Picture Adjustment (“Picture” menu)

You can adjust the projector’s picture to your preferences using the “Picture” menu.

Selecting the Picture Mode

This function allows you to select the picture mode in accordance with brightness of the room or content of the image to be projected. In all picture modes, items on the “Picture” menu can be adjusted and saved.

Menu operation ➡ Page 58

Example: “Picture” screen menu for INPUT 1 (RGB) mode

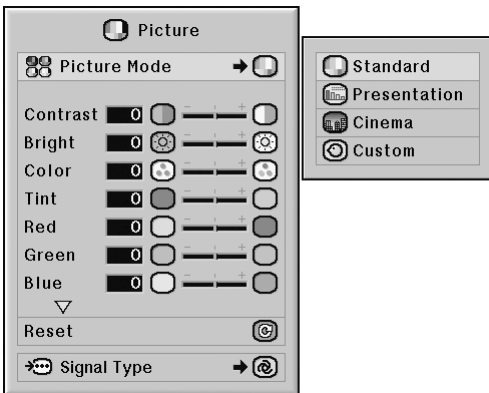

Description of Picture Modes

Selectable items	Description
Standard	For standard image
Presentation	Brightens darker portions of image for more enhanced presentations.
Cinema	Gives greater depth to darker portions of image for a more exciting theater experience.
Custom	The factory preset value is the same as the one of “Standard”. Using the dedicated software allows you to adjust the gamma curve. Visit “ http://sharp-world.com/projector/ ” for details.

Note

- You can also press  on the remote control to select the picture mode. (See page 47.)

Adjusting the Image

Select a picture mode before adjusting the image.

Menu operation ➡ Page 56

Example: “Picture” screen menu for INPUT 1 (RGB) mode

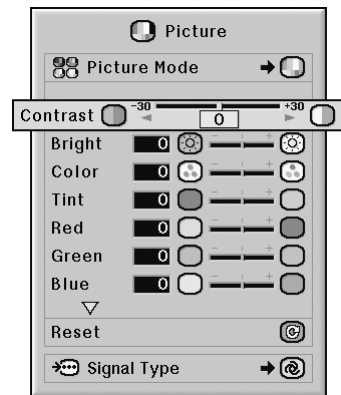

Description of Adjustment Items

Selectable items	Press ◀	Press ▶
Contrast	For less contrast	For more contrast
Bright	For less brightness	For more brightness
Color ^{*1}	For less color intensity	For more color intensity
Tint ^{*1}	For making skin tones purplish	For making skin tones greenish
Red ^{*1}	For weaker red	For stronger red
Green ^{*1}	For weaker green	For stronger green
Blue ^{*1}	For weaker blue	For stronger blue
Sharp ^{*2}	For less sharpness	For more sharpness

*1 “Color”, “Tint”, “Red”, “Green” and “Blue” cannot be adjusted when “C.M.S. Adjustment” on the “C.M.S.” menu is set to “sRGB”. (See page 64.)

*2 “Sharp” can be adjusted only when 480I, 480P, 540P, 576I, 576P, 720P, 1035I or 1080I DTV signal is input during the INPUT 1, 2 or 3 mode; or the input mode is set to INPUT 4 or 5.

Note

- To reset all adjustment items, select “Reset” and press .

Adjusting the Color Temperature

Menu operation ➔ Page 56

Example: “Picture” screen menu for INPUT 1 (RGB) mode

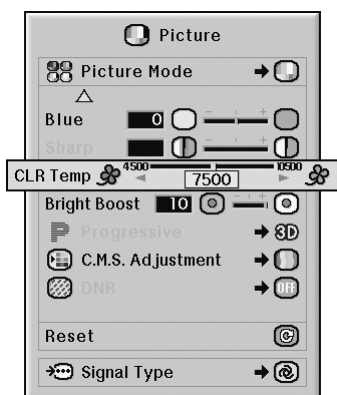

Description of Color Temperature Settings

Selectable items	Description
4500K	For lower color temperature for warmer, reddish incandescent-like images.
↕	↕
10500K	For higher color temperature for cooler, bluish, fluorescent-like images.

Note

- “CLR Temp” cannot be set when “C.M.S. Adjustment” on the “C.M.S.” menu is set to “sRGB”. (See page 64.)

Emphasizing the Contrast

This function emphasizes the bright portions of images to obtain a higher contrast image.

Menu operation ➔ Page 56

Example: “Picture” screen menu for INPUT 1 (RGB) mode

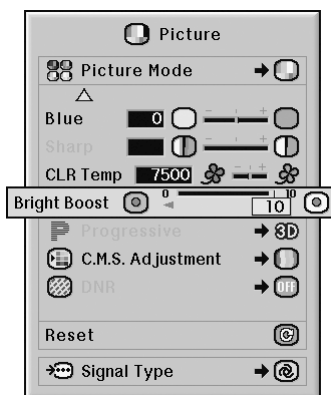

Description of Bright Boost Setting

Press ◀	Press ▶
To improve color reproduction, lower bright boost setting.	To increase brightness, increase bright boost setting.

Note

- “Bright Boost” cannot be set when “C.M.S. Adjustment” on the “C.M.S.” menu is set to “sRGB”. (See page 64.)

Selecting the Progressive Mode

Menu operation ➡ Page 58

Example: “Picture” screen menu for INPUT 1 (RGB) mode

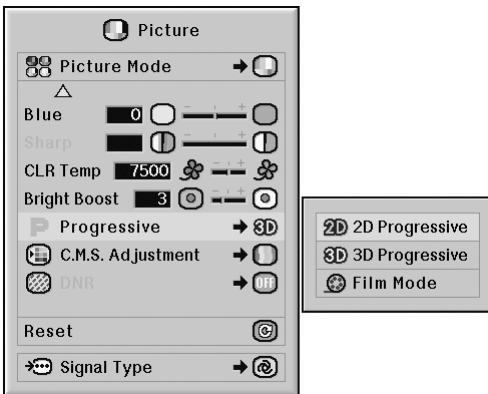

Description of Progressive

Selectable items	Description
2D Progressive	Useful to display fast-moving images such as sports and action films.
3D Progressive	Useful to display relatively slowmoving images such as drama and documentary more clearly.
Film Mode	Reproduces the image of film source* clearly. Displays the optimized image of film transformed with three-two pull down (NTSC and PAL60Hz) or two-two pull down (PAL50Hz and SECAM) enhancement to progressive mode images.

* The film source is a digital video recording with the original encoded as is at 24 frames/second. The projector can convert this film source to progressive video at 60 frames/second with NTSC and PAL60Hz or at 50 frames/second with PAL50Hz and SECAM to play back a high-definition image.

Note

- In NTSC or PAL60Hz, even if the 3D Progressive mode has been set, the three-two pull down enhancement will be enabled automatically when the film source has been entered.
- When the image is blurred or noisy, switch to the optimal mode.
- When using progressive inputs, inputs are directly displayed so that “2D Progressive”, “3D Progressive” and “Film Mode” cannot be selected.

Reducing Image Noise (DNR)

Video digital noise reduction (DNR) provides high quality images with minimal dot crawl and cross color noise.

Menu operation ➡ Page 58

Example: “Picture” screen menu for INPUT 1 (RGB) mode

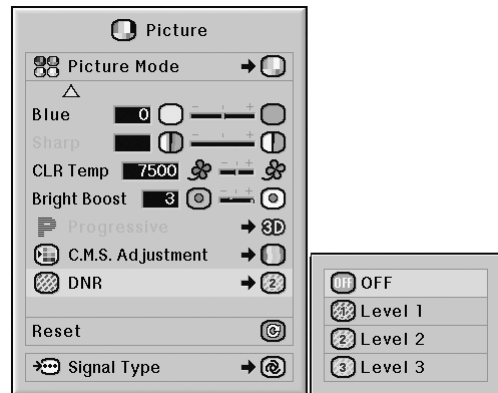

Description of DNR

Selectable items	Description
OFF	DNR does not function.
Level 1-3	Sets the DNR level.

Note

- Set a level so as to view a clearer picture.
- Make sure to set “DNR” to “OFF” in the following cases:**
- When the image is blurry.
 - When the contours and colors of moving images drag.
 - When TV broadcasts with weak signals are projected.

Info

- This function is available for all signals with INPUT 4 and 5.
- This function is available for 480I, 480P, 576I and 576P signals with INPUT 1, 2 and 3.

Signal Type Setting

This function allows you to select the input signal type RGB or component for INPUT 1, INPUT 2 or INPUT 3.

Menu operation ➡ Page 58

Example: “Picture” screen menu for INPUT 1 (RGB) mode

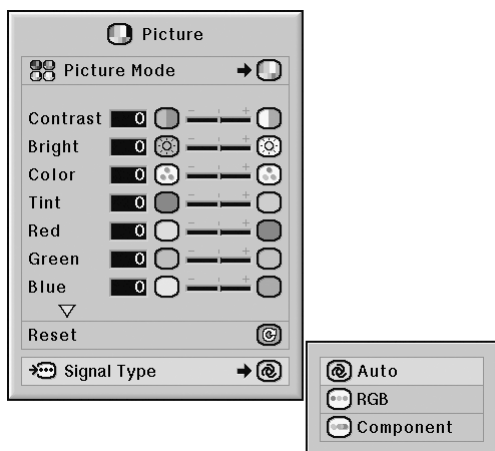

Description of Signal Type Settings

INPUT 1/INPUT 2

Selectable items	Description
Auto	Input signals are automatically recognized as RGB or component.
RGB	Set when RGB signals are received.
Component	Set when component signals are received.

INPUT 3

Selectable items	Description
D. PC RGB	Set when digital PC RGB signals are received from a computer.
D. PC Comp.	Set when digital PC component signals are received from a computer.
D. Video RGB	Set when digital video RGB signals are received from video equipment.
D. Video Comp.	Set when digital video component signals are received from video equipment.

Color Management System (“C. M. S.” menu)

This function allows you to individually adjust the display characteristics of six colors (R: Red, Y: Yellow, G: Green, C: Cyan, B: Blue, M: Magenta).

Selecting the Color Reproduction Mode

This function allows you to select the color reproduction mode for the projected images.

Menu operation ➡ Page 58

Example: “C.M.S.” screen menu

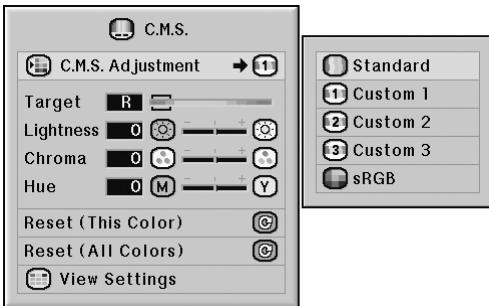

Description of C.M.S. Adjustment

Selectable items	Description
Standard	Standard settings
Custom 1 – 3	“Lightness”, “Chroma” and “Hue” can be adjusted for each of the six colors.
sRGB	A natural tint based on an original image from the computer.

Note

- sRGB is an international standard of color reproduction regulated by the IEC (International Electrotechnical Commission). As the fixed color area has been decided by the IEC, the images are displayed in a natural tint based on an original image, when “C.M.S. Adjustment” is set to “sRGB”.
- You cannot set “Color”, “Tint”, “Red”, “Green”, “Blue”, “CLR Temp”, “Bright Boost” on the “Picture” menu, when “C.M.S. Adjustment” is set to “sRGB”.
- For additional information about the sRGB function, visit “<http://www.srgb.com/>”.

Info

- When “C.M.S. Adjustment” is set to “sRGB”, the projected image may become dark, but this does not indicate a malfunction.

Selecting the Target Color

This function allows you to select the target color for adjusting the display characteristics.

Menu operation ➡ Page 56

Example: “C.M.S.” screen menu

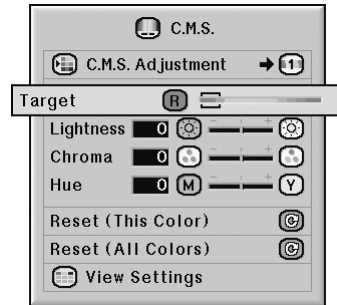

Description of Target Colors

R	Red	C	Cyan
Y	Yellow	B	Blue
G	Green	M	Magenta

Setting the Brightness of the Target Color

This function allows you to set the brightness of the selected target color.

Menu operation ➡ Page 56

Example: "C.M.S." screen menu

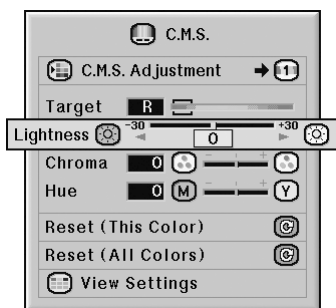

Description of Brightness

Press ◀	Press ▶
For less brightness of the target color	For more brightness of the target color

Setting the Chromatic Value of the Target Color

This function allows you to set the chromatic value of the selected target color.

Menu operation ➡ Page 56

Example: "C.M.S." screen menu

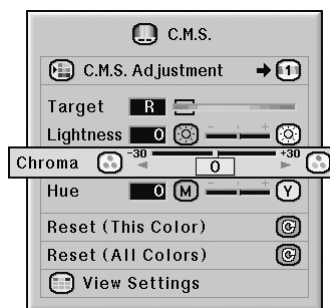

Description of Chromatic Value

Press ◀	Press ▶
For less chromatic value of the target color	For more chromatic value of the target color

Setting the Hue of the Target Color

This function allows you to set the hue of the selected target color.

Menu operation ➡ Page 56

Example: “C.M.S.” screen menu

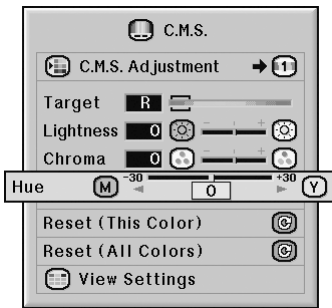

Description of Hue

Press ◀	Press ▶
For stronger red of the target color	For stronger yellow of the target color

Resetting User-defined Color Settings

This function allows you to reset the specific target color or all of the six colors.

Menu operation ➡ Page 56

Example: “C.M.S.” screen menu

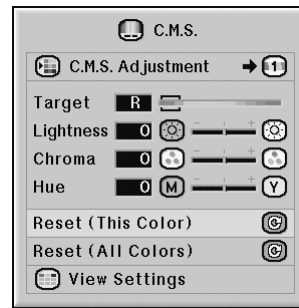

Description of Reset

Selectable items	Description
Reset (This Color)	“Lightness”, “Chroma” and “Hue” of the color selected for “Target” are reset.
Reset (All Colors)	“Lightness”, “Chroma” and “Hue” of all colors are reset.

Overview of All Color Settings

This function allows you to confirm the settings of all the colors.

Menu operation ➡ Page 56

Example: “C.M.S.” screen menu

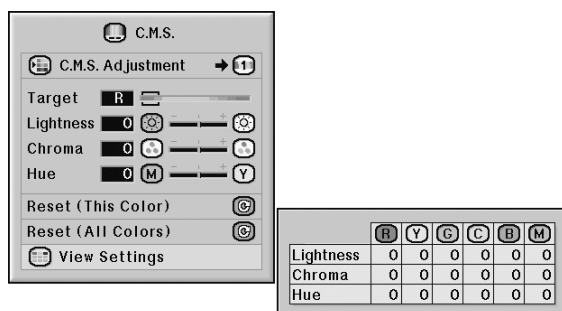

The screenshot shows the "C.M.S." screen menu with the following options and settings:

- C.M.S. Adjustment → 1
- Target: R
- Lightness: 0
- Chroma: 0
- Hue: 0 M
- Reset (This Color)
- Reset (All Colors)
- View Settings

Next to the menu is a table showing the current settings for Lightness, Chroma, and Hue across six color channels (R, Y, G, C, B, M).

	R	Y	G	C	B	M
Lightness	0	0	0	0	0	0
Chroma	0	0	0	0	0	0
Hue	0	0	0	0	0	0

Computer Image Adjustment (“Fine Sync” menu)

You can adjust the computer image, match the computer display mode, and confirm the input signal using the “Fine Sync” menu.

Adjusting the Computer Image

Use the Fine Sync function in case of irregularities such as vertical stripes or flickering in portions of the screen.

Menu operation ➡ Page 56

Example: “Fine Sync” screen menu for INPUT 1 (RGB) mode

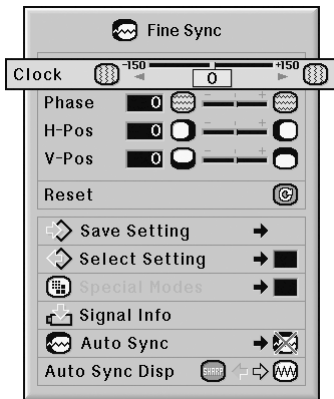

Saving Adjustment Settings

This projector allows you to store up to seven adjustment settings for use with various computers.

Menu operation ➡ Page 58

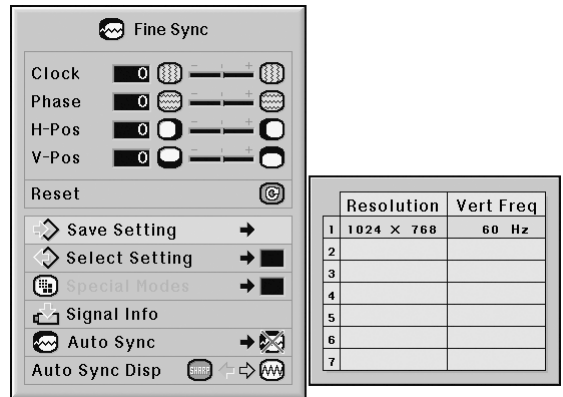

Example: “Fine Sync” screen menu for INPUT 1 (RGB) mode



Description of Adjustment Items

Selectable items	Description
Clock	Adjusts vertical noise.
Phase	Adjusts horizontal noise (similar to tracking on your VCR).
H-Pos	Centers the on-screen image by moving it to the left or right.
V-Pos	Centers the on-screen image by moving it up or down.

Note

- You can automatically adjust the computer image by setting “Auto Sync” on the “Fine Sync” menu to “Normal” or “High Speed”, or pressing  on the projector or  on the remote control. See page 70 for details.
- To reset all adjustment items, select “Reset” and press .

Selecting Adjustment Settings

Adjustment settings stored in the projector can be easily accessed.

Menu operation ➡ Page 58

Example: “Fine Sync” screen menu for INPUT 1 (RGB) mode

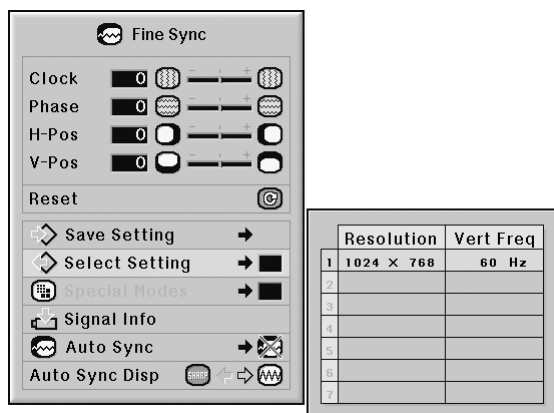

Note

- If a memory has not been set, a resolution and frequency setting will not be displayed.
- When selecting a stored adjustment setting with “Select Setting”, you can set the projector in the stored adjustments.

Special Mode Setting

Ordinarily, the type of input signal is detected and the correct resolution mode is automatically selected. However, for some signals, the optimal resolution mode in “Special Modes” on the “Fine Sync” menu may need to be selected to match the computer display mode.

Menu operation ➡ Page 58

Example: “Fine Sync” screen menu for INPUT 1 (RGB) mode

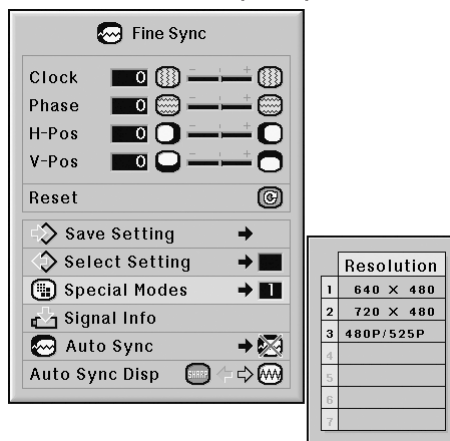

Note

- If your computer displays patterns which repeat every other line (horizontal stripes), flickering may occur which makes the image hard to see.
- See “Checking the Input Signal” on page 70 for information on the currently selected input signal.

Checking the Input Signal

Menu operation ➔ Page 56

Example: “Fine Sync” screen menu for INPUT 1 (RGB) mode

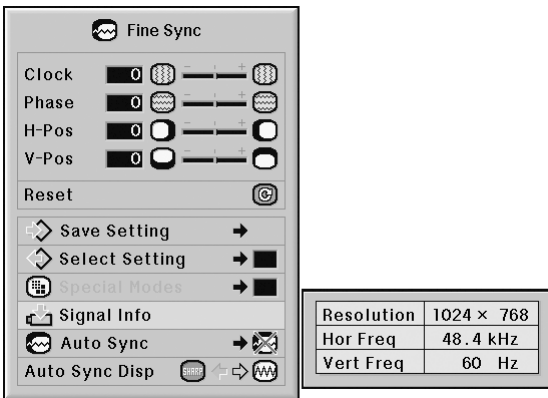

Note

- The projector will display the number of scanned lines available from audio-visual equipment such as a DVD player or Digital Video.
- The projector will display the resolution when connecting the computer.

Auto Sync Adjustment

Used to automatically adjust a computer image.

Menu operation ➔ Page 58

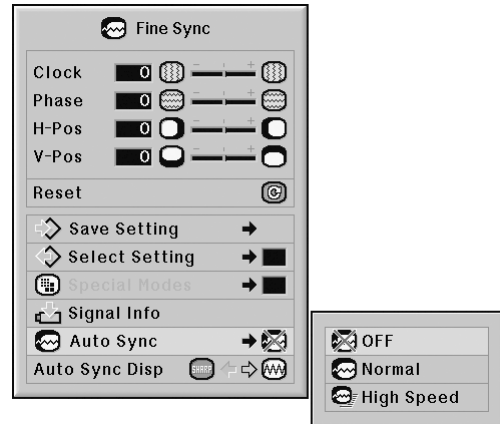

Example: “Fine Sync” screen menu for INPUT 1 (RGB) mode



Description of Auto Sync Adjustment

Selectable items	Description
OFF	Auto Sync adjustment is not automatically performed.
Normal	Auto Sync adjustment will occur when the projector is turned on or when the input signals are switched, when connected to a computer.
High Speed	“Normal” takes more time than “High Speed” for more accurate Auto Sync adjustment.

Note

- Auto Sync adjustment is also performed by pressing  on the projector or  on the remote control.
- The Auto Sync adjustment may take some time to complete, depending on the image of the computer connected to the projector.
- When the optimum image cannot be achieved with Auto Sync adjustment, use manual adjustments. (See page 68.)
- When  is pressed while “Auto Sync” is “OFF” or “High Speed”, Auto Sync will be executed in “High Speed” mode. If the button is pressed again within one minute, Auto Sync will be executed in “Normal” mode.

Auto Sync Display Function

Used to set the display during Auto Sync.

Menu operation ➡ Page 56

Example: “Fine Sync” screen menu for INPUT 1 (RGB) mode

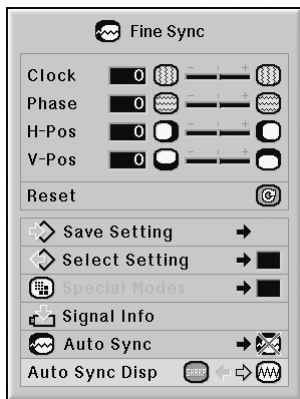

Description of Auto Sync Display

Selectable items	Description
—	The image set as a background image is projected. See page 77.
	The computer image being adjusted is displayed.

Audio Adjustment (“Audio” menu)

You can adjust the projector’s audio to your preferences using the “Audio” menu.

Adjusting the Audio

This function allows you to adjust the projector’s audio.

Menu operation ➡ Page 56

Example: “Audio” screen menu

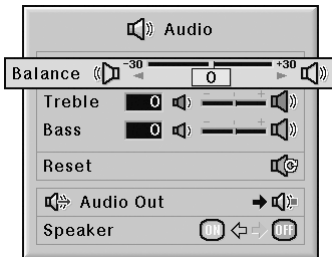

Description of Adjustment Items

Selectable items	Press ◀	Press ▶
Balance	Increased audio from the left speaker	Increased audio from the right speaker
Treble	For weaker treble	For stronger treble
Bass	For weaker bass	For stronger bass

Note

- To reset all adjustment items, select “Reset” and press .

Setting the Audio Output Type

This function determines whether the audio level output from the AUDIO OUTPUT terminal is fixed or variable by linking with VOLUME.

Menu operation ➡ Page 58

Example: “Audio” screen menu

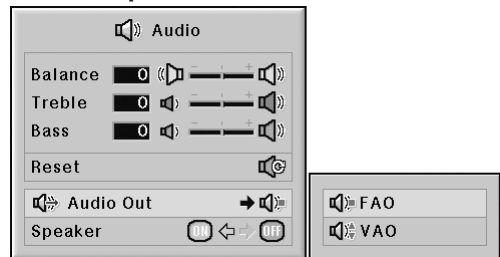

Description of Audio Out Settings

Selectable items	Description
FAO (Fixed Audio Output)	Audio output that does not vary in strength with the volume level of the source projector.
VAO (Variable Audio Output)	Audio output that varies in strength with the volume level of the source projector.

Info

- When “Audio Out” has been set to “VAO”, first make sure to lower the volume of the projector before turning the power on or off and when switching the input.

Note

When the projector is connected to audio equipment:

- It is recommended that “FAO” be selected on “Audio Out”. Because the audio signal from the audio equipment does not vary in strength with the volume level of the projector, you can enjoy better sound.
- When “FAO” be selected on “Audio Out”, video and audio may not synchronize.
 - When connecting audio equipment that has a function for adjusting audio delay time, adjust the delay time for synchronizing video and audio.
 - When the audio equipment does not have such a function and the unsynchronized video and audio bothers you, select “VAO” on “Audio Out”. Selecting “VAO” synchronizes video and audio automatically.

Speaker Setting

This function allows you to turn the audio output of the internal speaker on or off when the projector is connected to an external amplifier.

Menu operation ➡ Page 56

Example: “Audio” screen menu

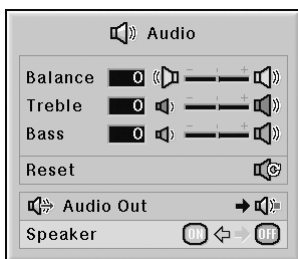

Description of Speaker Settings

Selectable items	Description
ON	The audio signal is output from the internal speaker.
OFF	The audio signal is not output from the internal speaker.

Using the “Options (1)” Menu

You can use the “Options (1)” menu to enhance the usage for the projector.

Displaying Dual Pictures (Pict in Pict)

The Pict in Pict (picture in picture) function allows you to display two pictures on the same screen. You can display the image input from INPUT 4 or 5 as an inset picture overlapping the main picture input from INPUT 1, 2 or 3.

Menu operation ➔ Page 56

Example: “Options (1)” screen menu for INPUT 1 (RGB) mode



Note

- Inset picture can only be displayed in composite video or S-video signal of NTSC/PAL/SECAM.
- The audio of the inset picture will come out of the projector's speakers.
- While the “Pict in Pict” function is working, other functions except the “FREEZE” function cannot be used. The “FREEZE” function only works for the inset picture.
- The “Pict in Pict” function does not work when the following signals are input to the main picture.
 - UXGA/SXGA+/SXGA signal
 - 480I/480P/540P/576I/576P/720P/1035P/1080I signal
 - Interlaced RGB signal
- All signals (when “Resize” is set to “Dot by Dot”)
- No signal (or when the resolution or refresh rate (vertical frequency) of the signal is changed)

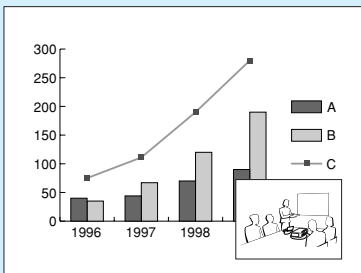

Setting the Resize Mode

Depending on the input signal, you can select the screen image.

Menu operation ➔ Page 58

Example: “Options (1)” screen menu for INPUT 1 (RGB) mode

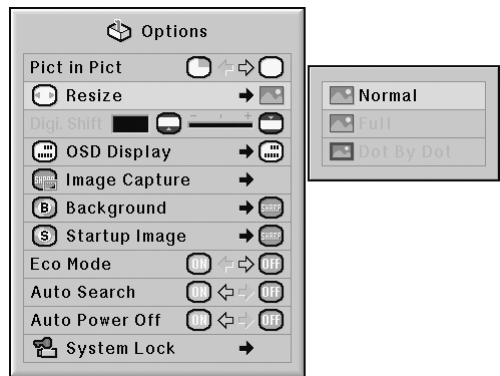

Selectable Items of Resize Mode

When inputting RGB signal	When inputting DTV/video signal
Normal	Normal
Full	Full
Dot By Dot	Border
-	Stretch
-	Smart Stretch

Note

- For details of the Resize mode, see pages 48 and 49.
- You can also press  on the remote control to change the resize mode. (See page 48.)

Shifting the Projected Image Vertically (Digital Shift)

For easier viewing, this function shifts the image projected on the screen up or down eliminating either the upper or lower black band found in 16:9 and other wide aspect ratios.

Menu operation ➡ Page 56

Example: “Options (1)” screen menu for INPUT 1 (RGB) mode

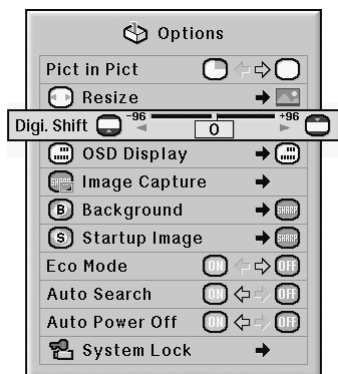

Description of Digital Shift

Press ◀	Press ▶
Shifts the projected image down.	Shifts the projected image up.

Note

- The “Digital Shift” function works with the “BORDER”, “STRETCH” or “SMART STRETCH” image. (See page 49.)

Setting On-screen Display

This function allows you to turn the on-screen messages on or off.

Menu operation ➡ Page 58

Example: “Options (1)” screen menu for INPUT 1 (RGB) mode

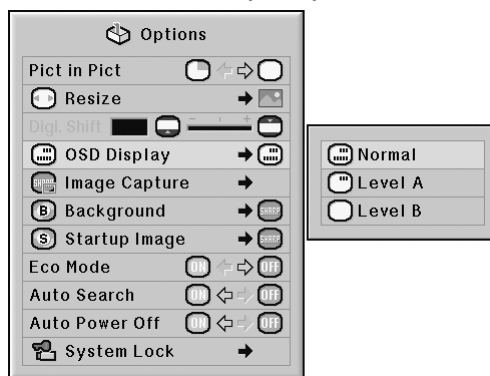

Description of OSD Display Settings

Selectable items	Description
Normal	All on-screen displays are displayed.
Level A	INPUT/VOLUME/MUTE/BLACK SCREEN/FREEZE/AUTO SYNC/ENLARGE/ “An invalid button has been pressed.” are not displayed.
Level B	All on-screen displays are not displayed. (except the menu, H & V LENS SHIFT, KEYSTONE, FOCUS, ZOOM, “All buttons on Projector are locked.” and warning displays)

Note

- While “Keylock Level” is “Level A” or “Level B”, pressing displays “All buttons on Projector are locked.” despite the “OSD Display” setting.

Setting the Video System

The video input system mode is factory preset to “Auto”; however, a clear picture from the connected audio-visual equipment may not be received, depending on the video signal difference. In that case, switch the video signal.

Menu operation ➡ Page 58

Example: “Options (1)” screen menu for INPUT 4 (video) mode

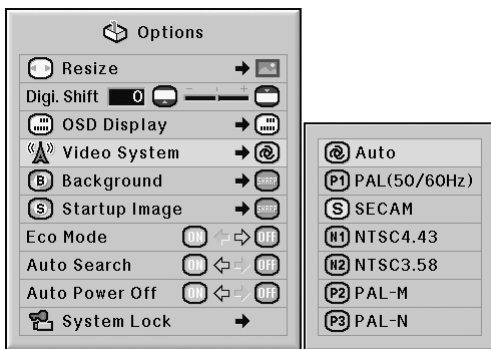

Capturing Projected Images

This projector allows you to capture projected images (RGB signals) and set them as a startup image, or background image when no signals are being received.

Menu operation ➡ Page 58

Example: “Options (1)” screen menu for INPUT 1 (RGB) mode

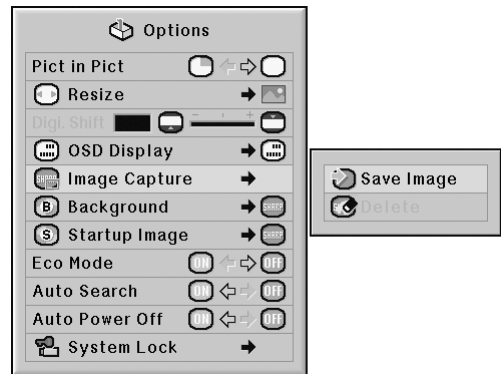

Description of Video Systems

Selectable items	Description
PAL (50/60 Hz)	When connected to PAL video equipment.
SECAM	When connected to SECAM video equipment.
NTSC4.43	When reproducing NTSC signals in PAL video equipment.
NTSC3.58	When connected to NTSC video equipment.

Note

- The video signal can only be set in INPUT 4 or INPUT 5 mode.
- When “Video System” is set to “Auto”, you may not receive a clear picture due to signal differences. Should this occur, switch to the video system of the source signal.
- While “Video System” is set to “Auto”, when PAL-M or PAL-N signal is input, the image from PAL signal will be displayed.

Note

- Only images from XGA (1024 × 768) non-interlace signals in INPUT 1, INPUT 2 or INPUT 3 mode can be captured.
- The saved image is reduced to 256 colors.
- Images from equipment connected to INPUT 4 or INPUT 5 terminal cannot be captured.
- Only one image can be captured and saved.
- The color of images may differ before and after saving if an image is captured on which image adjustment has been performed using the “C.M.S.” function.
- To delete the captured image, select “Delete”, and then press .

Selecting the Background Image

Menu operation ➡ Page 58

Example: “Options (1)” screen menu for INPUT 1 (RGB) mode

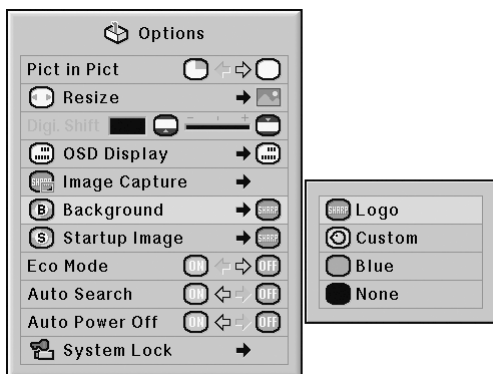

Description of Background Images

Selectable items	Description
Logo	Default image
Custom	User customized image (e.g. company logo)
Blue	Blue screen
None	Black screen

Note

- You can set a captured image as a background image by selecting “Custom”.
- When “Custom” is selected, an image saved using “Image Capture” can be displayed as a background image.

Selecting the Startup Image

Menu operation ➡ Page 58

Example: “Options (1)” screen menu for INPUT 1 (RGB) mode

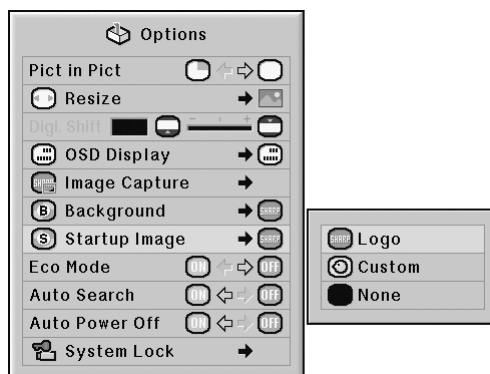

Description of Startup Images

Selectable items	Description
Logo	Default image
Custom	User customized image (e.g. company logo)
None	Black screen

Note

- You can set a captured image as a startup image by selecting “Custom”.
- When “Custom” is selected, an image saved using “Image Capture” can be displayed as a startup image.

Eco Mode

Menu operation ➡ Page 56

Example: “Options (1)” screen menu for INPUT 1 (RGB) mode

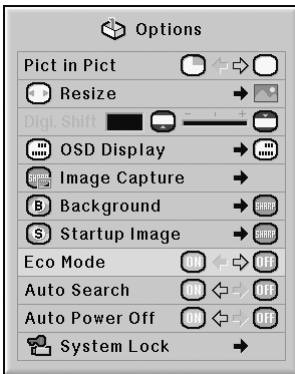

Description of Eco Mode

Selectable items	Brightness	Power consumption (When using AC 100V)	Lamp life
ON	Approx. 80%	Approx. 505 W	Approx. 3,000 hours*
OFF	100%	630 W	Approx. 2,000 hours*

* This is a reference value and is not guaranteed.

Note

- When “Eco Mode” is set to “ON”, the power consumption will decrease and the lamp life will extend. (Projection brightness decreases approximately 20%.)

Detecting the Input Signals Automatically

Menu operation ➡ Page 56

Example: “Options (1)” screen menu for INPUT 1 (RGB) mode

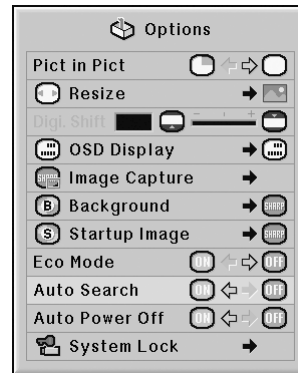

Description of Auto Search

Selectable items	Description
ON	Automatically searches for and switches to the input mode in which signals are being received.
OFF	“Auto Search” does not function.

Note

- While the “Auto Search” function is detecting the input signal, pressing a button on the projector or the remote control stops the “Auto Search” function. After the “Auto Search” function finishes completely, press the desired button.

Auto Power Off Function

Menu operation ➡ Page 56

Example: “Options (1)” screen menu for INPUT 1 (RGB) mode



Description of Auto Power Off

Selectable items	Description
ON	The projector automatically enters the standby mode when no input signal is detected for 15 minutes or longer.
OFF	The “Auto Power Off” function will be disabled.

Note

- When “Auto Power Off” is set to “ON”, 5 minutes before the projector enters the standby mode, the message “Enter STANDBY mode in X min.” will appear on the screen to indicate the remaining minutes.

System Lock Function

This function prevents unauthorized use of the projector. Once this function is activated, users must enter the correct keycode each time the projector is turned on. We suggest you record the keycode in a safe place where only authorized users have access.

Info

- If you lose or forget your keycode, contact your nearest Sharp Authorized Projector Dealer or Service Center (see page 101). Even if the product warranty is valid, the keycode reset will incur a charge.

Menu operation ➡ Page 58

Example: “Options (1)” screen menu for INPUT 1 (RGB) mode

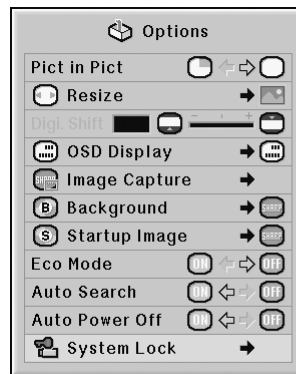

Old Code	- - - -
New Code	- - - -
Reconfirm	- - - -

Setting the keycode

- 1 Select “System Lock” on the “Options (1)” menu, then press ►.
 - A message is displayed.
 - Read this message, and press .
- 2 Press the 4 buttons on the remote control or on the projector to enter the preset keycode in “Old Code”.
 - When setting the keycode for the first time, press ▼ on the projector for four times.

Old Code	■ - - -
New Code	- - - -
Reconfirm	- - - -

Using the “Options (1)” Menu

Note

- If you input a wrong keycode, the cursor returns to the first point of the “Old Code”.
- The preset keycode is 4 ▼ buttons on the projector. If this keycode is set, the keycode input screen does not appear when turning the power on.

3 Press the 4 buttons on the remote control or on the projector to enter the new keycode in “New Code”.

Note

- You cannot use the following buttons for keycode:
 - ON button
 - STANDBY button
 - ENTER button
 - L-click button
 - R-click/UNDO button
 - MENU button
 - ZOOM buttons
 - FOCUS buttons
 - H & V LENS SHIFT button
- **System Lock function recognizes each button on the remote control or on the projector as an individual button, even if they share the same button name. If you set the keycode with the buttons on the projector, use only those buttons on the projector. If you set the keycode with the buttons on the remote control, use only those buttons on the remote control.**

4 Enter the same keycode in “Reconfirm”.

Note

Not displaying the keycode input screen when turning the projector on

- Press ▼ on the projector for four times in steps 2 and 3 above.

When the System Lock is set

- When System Lock is set, the keycode input screen appears after the power is turned on. When it appears, enter the right keycode to start projection. Failure to enter the keycode will cause images not to be projected even when signals are entered to the projector.

Changing the keycode

Old Code	■ - - -
New Code	- - - -
Reconfirm	- - - -

1 Press the 4 buttons on the remote control or on the projector to enter the preset keycode in “Old Code”.

2 Press the 4 buttons on the remote control or on the projector to enter the new keycode in “New Code”.

3 Enter the same keycode in “Reconfirm”.

When the system lock is set

If you have set the system lock, enter the keycode and follow the procedure below to release the system lock.

▼Input screen for keycode

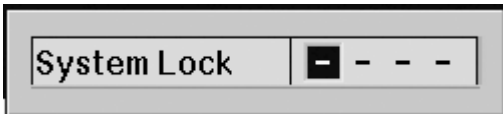

Note

- When System Lock is set, the keycode input screen appears after the power is turned on.
- If no keycode is entered, the image will not be displayed, even if the projector receives the input signal.

1 Press  on the remote control or  on the projector to turn on the projector.

2 When the keycode input screen appears, enter the right keycode to start projection.

Note

- System Lock function recognizes each button on the remote control or on the projector as an individual button, even if they share the same button name. If you set the keycode with the buttons on the projector, use only those buttons on the projector. If you set the keycode with the buttons on the remote control, use only those buttons on the remote control.

Helpful Functions Set during Installation (“Options (2)” menu)

Setting a Password

- There is no factory preset for the password, so the “Options (2)” menu is enabled.
- If you do not want others to operate the “Options (2)” menu, set a password.

Menu operation ➔ Page 58

Example: “Options (2)” screen menu

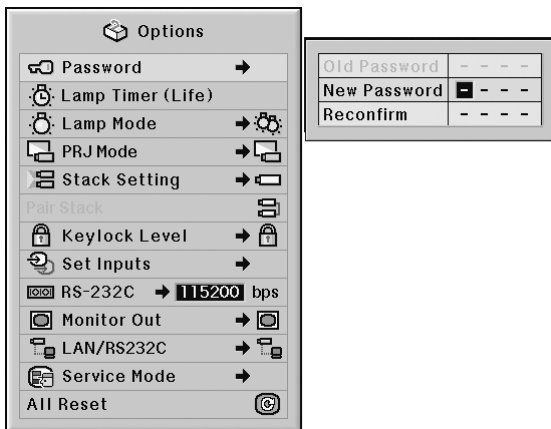

1 Select “Password” from the “Options (2)” menu, and press **▶**.

2 Press **▲** or **▼** to set the first digit in “New Password” and then press **▶**.

3 Enter the remaining 3 digits and press **ENTER**.

4 Enter the same password in “Reconfirm” and press **ENTER**.

Info

- The password must be entered to use the “Options (2)” menu when a password has been set.

Changing the password

Old Password	- - - -
New Password	- - - -
Reconfirm	- - - -

1 Press **▲**, **▼** and **▶** to enter the password in “Old Password” and press **ENTER**.

2 Press **▲**, **▼** and **▶** to set the new password in “New Password” and press **ENTER**.

3 Enter the same 4-digit password in “Reconfirm” and press **ENTER**.

Note

- If you do not want to set a password, leave the fields blank in steps 2 and 3 and press **ENTER**.
- To cancel the password settings, press **ESC**.

If You Forget Your Password

If you forget the password, delete it using the following procedure and set a new password.

Press **ON** → **ENTER** → **ON** → **ENTER** → **ON** → **ENTER** → **ENTER** → **MENU**.

Checking the Lamp Life Status

You can confirm the cumulative lamp usage time and the remaining lamp life (percentage).

Menu operation ➡ Page 56

Example: “Options (2)” screen menu

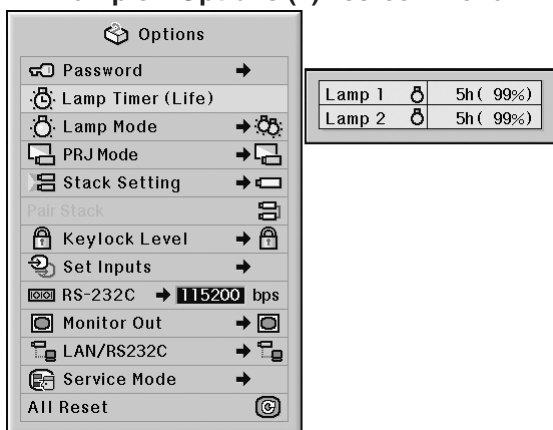

Description of Lamp Timer (Life)

Lamp usage condition	Remaining lamp life	
	100%	5%
Operated exclusively while “Eco Mode” is “ON”.	Approx. 3,000 hours*	Approx. 150 hours*
Operated exclusively while “Eco Mode” is “OFF”.	Approx. 2,000 hours*	Approx. 100 hours*

* This is a reference value and is not guaranteed.

Note

- It is recommended that the lamp be changed when the remaining lamp life becomes 5%.
- The table above indicates rough estimates in the case of using only in each mode shown.
- The lamp life may vary depending on the usage condition.

Setting the Lamp Mode

This function allows you to select the usage of the two lamps installed in the projector.

Menu operation ➡ Page 58

Example: “Options (2)” screen menu

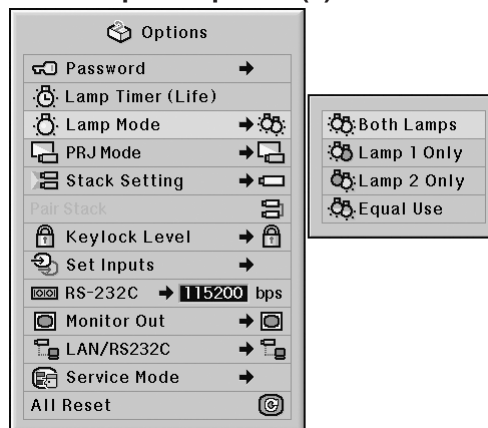

Description of Lamp Mode

Selectable items	Description
Both Lamps	Both lamps are used for greater brightness.
Lamp 1 Only	The lamp 1 is used. When the lamp 1 burns out, the lamp 2 automatically switches in use.
Lamp 2 Only	The lamp 2 is used. When the lamp 2 burns out, the lamp 1 automatically switches in use.
Equal Use	Both lamps are used alternately for certain periods.

Reversing/Inverting Projected Images

This projector is equipped with a reverse/invert image function that allows you to reverse or invert the projected image for various applications.

Menu operation ➡ Page 58

Example: “Options (2)” screen menu

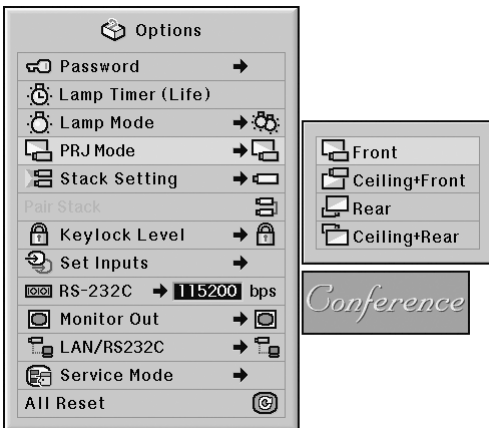

Description of PRJ Modes

Selectable items	Description
Front	Normal image
Ceiling + Front	Inverted image
Rear	Reversed image
Ceiling + Rear	Reversed and inverted image

Note

- This function is used for the reversed image and ceiling-mount setups. (See page 23.)

Controlling Multiple Projectors with the One Remote Control

This function allows you to control multiple projectors with the one remote control during the stack projection or the video wall projection. When using this function, connect the projectors with LAN cables and assign a projector as the master and the other projectors as the slaves. See page 35 for connecting LAN cables.

Menu operation ➡ Page 58

Example: “Options (2)” screen menu

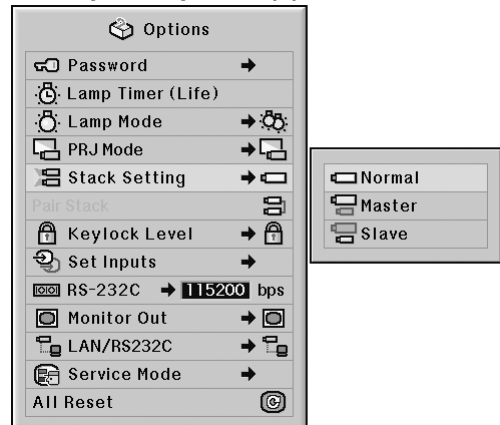

Description of Stack Setting

Selectable items	Description
Normal	The stack setting is not available.
Master	Set the projector as the master.
Slave	Set the projector as the slave.

Note

- When controlling multiple projectors with the one remote control, settings via web browser are required. Refer to the “SETUP GUIDE” contained on the supplied CD-ROM for details.
- Only when controlling two projectors with the one remote control, using “Pair Stack” allows you to skip settings via web browser. (See page 85.)
- When “Slave” is selected on “Stack Setting”, the slave projector cannot be controlled with the remote control. To control the slave projector with the remote control, connect the remote control to the projector. (See page 18.)

Shortcut to Make Projector Stack Settings

Normally, settings via web browser are required for the stack projection. You can skip the settings via web browser by using “Pair Stack”, only when you use the two projectors for the stack projection.

Menu operation ➡ Page 56

Note

- Before setting “Pair Stack”, select “Master” or “Slave” on “Stack Setting”.

Example: “Options (2)” screen menu

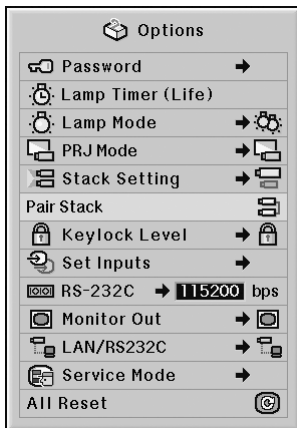

1 Select “Pair Stack” on the “Option (2)” menu, and then press .

- The confirmation screen will be displayed.

2 Select “OK”, and then press .

- The network settings of the projector will change as shown below.

	Master	Slave
IP Address	192.168.150.2	192.168.150.3
Subnet Mask	255.255.255.0	255.255.255.0
Default Gateway	0.0.0.0	0.0.0.0
User Name	(Reset)	(Reset)
Password	(Reset)	(Reset)
Data Port	10002	10002

Locking the Operation Buttons on the Projector



This function can be used to lock the use of certain operation buttons on the projector.

Menu operation ➡ Page 58

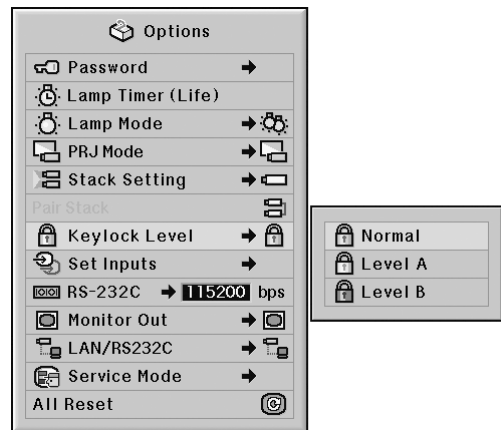
Example: “Options (2)” screen menu



Description of Keylock Level

Selectable items	Description
 Normal	All operation buttons are functional.
 Level A	Only INPUT/VOLUME buttons on the projector are available.
 Level B	All operation buttons on the projector are unavailable.

Bypassing Unused Input Selections

This function allows you to skip the input mode that you rarely use. You can skip the input modes when pressing INPUT 1, 2, 3 button or INPUT 4, 5 button on the projector.

Menu operation ➡ Page 58

Example: “Options (2)” screen menu

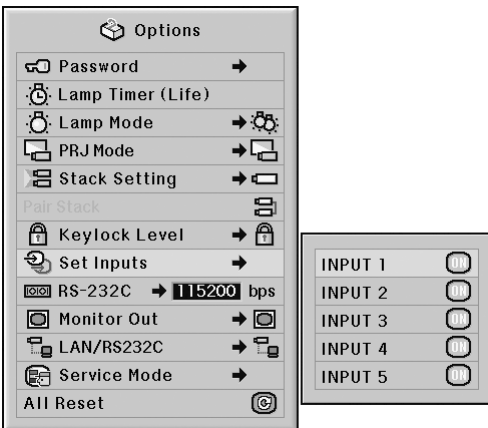

Description of Set Inputs

Selectable items	Description	
INPUT 1—5	ON	Sets the INPUT 1—5 mode selectable respectively.
	OFF	Sets the INPUT 1—5 mode unavailable respectively.

Selecting the Transmission Speed (RS-232C)

Make sure that both the projector and computer are set for the same baud rate.

Menu operation ➡ Page 58

Example: “Options (2)” screen menu

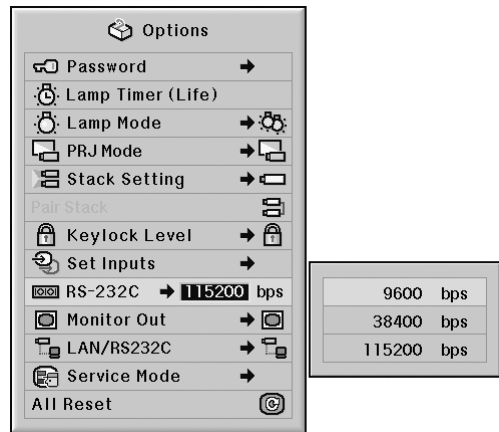

Description of RS-232C

Selectable items	Description
9600 bps	Transmission speed is slow.
38400 bps	
115200 bps	

Note

- Refer to the “SETUP GUIDE” contained on the supplied CD-ROM for RS-232C Specifications and Command Settings.
- Refer to the computer’s operation manual for instructions for setting the computer’s baud rate.

Monitor Output Settings

When the Monitor Out has been set to “Enable”, the monitor output is activated and power is consumed even in the standby mode. It is recommended that the Monitor Out be set to “Disable” when it is not connected. This reduces power consumption when the projector is in the standby mode.

Menu operation ➡ Page 58

Example: “Options (2)” screen menu

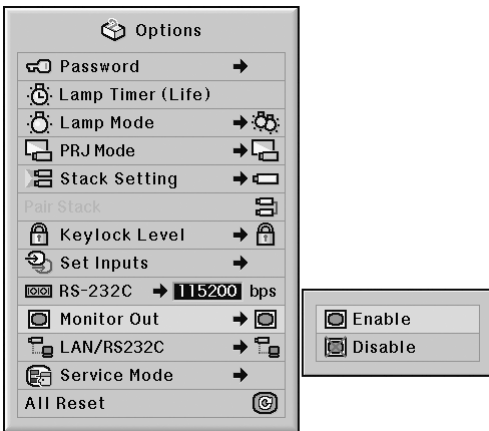

Description of Monitor Out

Selectable items	Description
Enable	The monitor output function is activated even if the projector is in standby mode.
Disable	The monitor output function is switched off when the projector is in standby mode.

LAN/RS232C Setting

When the LAN/RS232C has been set to “Enable”, the LAN/RS232C is activated and power is consumed even in the standby mode. It is recommended that the LAN/RS232C be set to “Disable” when it is not connected. This reduces power consumption when the projector is in the standby mode.

Menu operation ➡ Page 58

Example: “Options (2)” screen menu

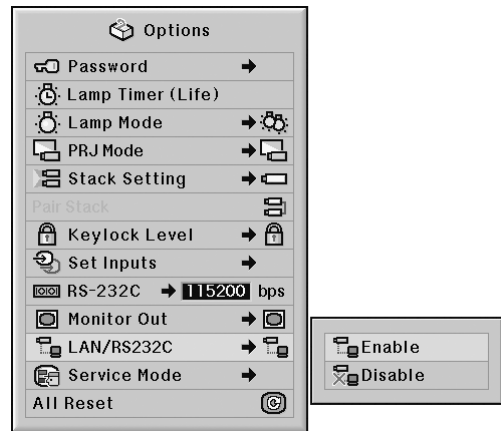

Description of LAN/RS232C

Selectable items	Description
Enable	The LAN/RS232C function is activated even if the projector is in standby mode.
Disable	The LAN/RS232C function is switched off when the projector is in standby mode.

Note

- When you want to control the projector using the LAN/RS232C function, select “Enable.”

Service Mode

Only the service centers use the menu. Do not use the menu.

Example: “Options (2)” screen menu

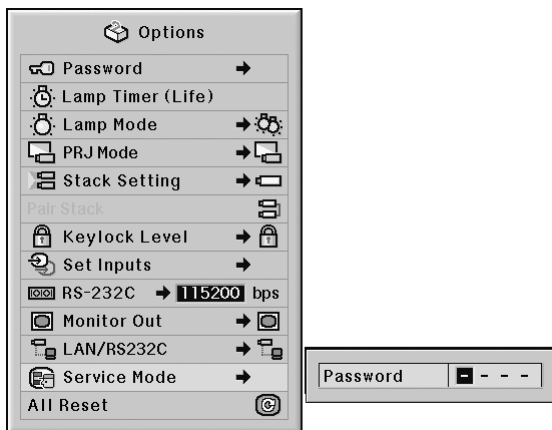

Returning to the Default Settings

This function allows you to initialize the settings you have made in the projector.

Menu operation ➡ Page 56

Example: “Options (2)” screen menu

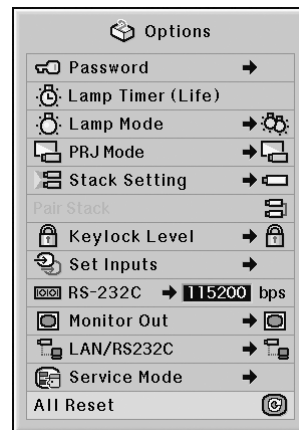

Note

About the network settings

- “IP Address”, “Subnet Mask”, “Default Gateway” and other network setting items are initialized.

The following items or menu cannot be initialized.

- “C. M. S.” menu
 - “Lightness”, “Chroma” and “Hue” respectively saved for Custom 1-3 on the “C.M.S.” menu.
- “Fine Sync” menu
- Special Modes
- “Options (1)” menu
- System Lock
- “Options (2)” menu
- Lamp Timer (Life)
- “Language” menu
- Image stored using “Image Capture”

Using the Other Menus (“Language” and “Status” menus)

Selecting the On-screen Display Language

The projector can switch the on-screen display language among 11 languages: English, German, Spanish, Dutch, French, Italian, Swedish, Portuguese, Chinese, Korean or Japanese.

Menu operation ➡ Page 58

Example: “Language” screen menu



Overview of All Menu Settings

This function can be used to display all the adjusted settings as a list on the screen.

Menu operation ➡ Page 58

Example: “Status” screen menu

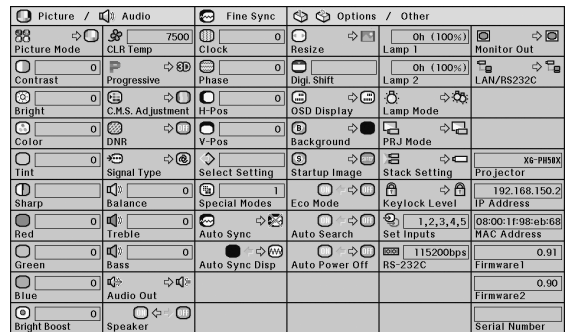

Note

- You can refer to the network information of the projector (the projector name, IP address and Mac address) on the “Status” list.

Description of Network Information

Displayed items	Description
Projector	The projector name is displayed. (Factory preset: XG-PH50X)
IP Address	The IP address set for the projector is displayed. (Factory preset: 192.168.150.2)
MAC Address	The MAC address of the projector is displayed.

- For information on how to change the projector name and IP address, see “SETUP GUIDE” contained in the supplied CD-ROM.

Maintenance

Cleaning the projector

- Ensure the power cord is unplugged before cleaning the projector.
- The cabinet as well as the operation panel is made of plastic. Avoid using benzene or thinner, as these can damage the finish on the cabinet.
- Do not use volatile agents such as insecticides on the projector.

Do not attach rubber or plastic items to the projector for long periods.

The effects of some of the agents in the plastic may cause damage to the quality or finish of the projector.

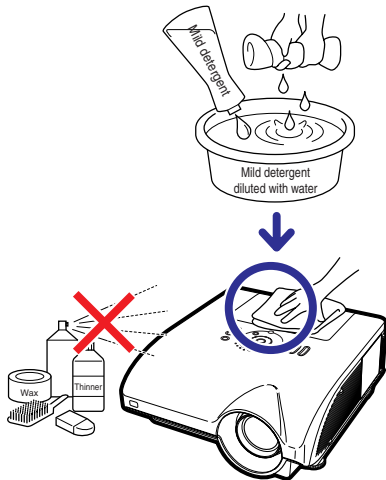

- Wipe off dirt gently with a soft flannel cloth.
 - When the dirt is hard to remove, soak a cloth in a mild detergent diluted with water, wring the cloth well and then wipe the projector.
- Strong cleaning detergents may discolor, warp or damage the coating on the projector. Make sure to test on a small, inconspicuous area on the projector before use.

Cleaning the lens

- Use a commercially available blower or lens cleaning paper (for glasses and camera lenses) for cleaning the lens. Do not use any liquid type cleaning agents, as they may wear off the coating film on the surface of the lens.
- As the surface of the lens can easily get damaged, ensure not to scrape or hit the lens.

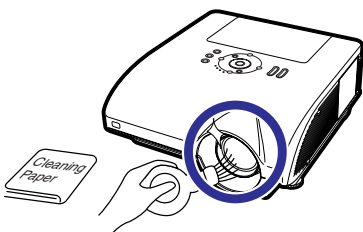

Cleaning the air vents and the intake vent cover

- Use a vacuum cleaner to clean dust from the exhaust vent, the intake vents and the intake vent cover (on the bottom of the projector).

Info

- If you want to clean the air vents and the intake vent cover during projector operation, ensure to press **STANDBY** on the projector or **STANDBY** on the remote control and put the projector into standby mode. After the cooling fan has stopped, unplug the power cord from the AC socket and clean the air vents and the intake vent cover.

Cleaning the exhaust and intake vents

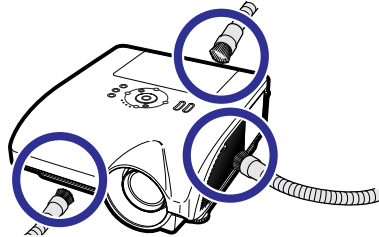

Cleaning the intake vent cover

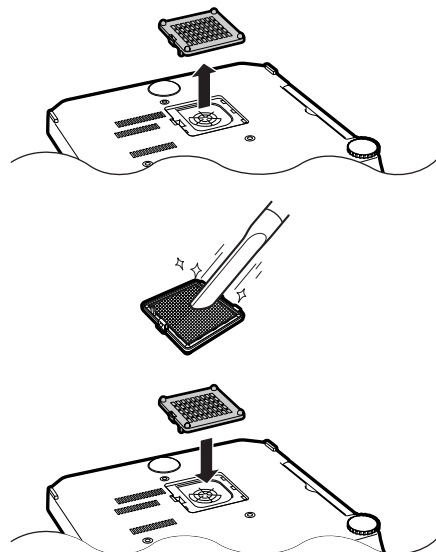

Note

- The air vents and the intake vent cover should be cleaned every 100 hours of use. Clean the air vents and the intake vent cover more often when the projector is used in a dusty or smoky location.
- Ensure the intake vent cover is securely installed. The power will not turn on unless it is correctly installed.

Maintenance Indicators

- The warning lights on the projector indicate problems inside the projector.
- If a problem occurs, either the temperature warning indicator or the lamp indicator will illuminate red, and the projector will enter the standby mode. After the projector has entered the standby mode, follow the procedures given below.

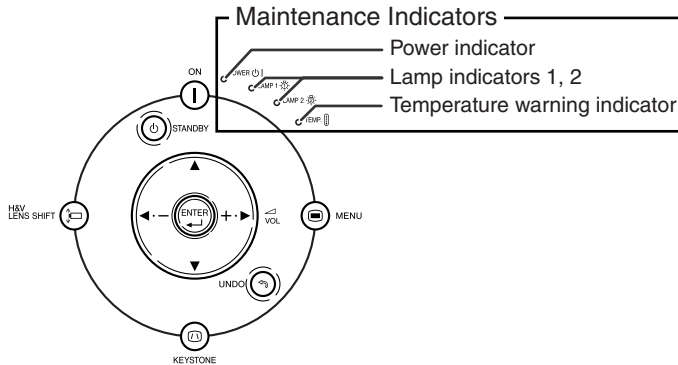

About the temperature warning indicator



If the temperature inside the projector increases, due to blockage of the air vents, or the setting location, "TEMP." will illuminate in the lower left corner of the picture. If the temperature keeps on rising, the lamp will turn off and the temperature warning indicator will blink, the cooling fan will run for a further 90 seconds, and then the projector will enter the standby mode. After "TEMP." appears, ensure to perform the measures described on page 92.

About the lamp indicator



"Change The Lamp. (LAMP 2)" is displayed when the remaining life of the lamp 2 becomes 5% or less.

- When the remaining lamp life becomes 5% or less, "⊗" (yellow) and "Change The Lamp. (LAMP 1/2)" will be displayed on the screen.
- When the percentage becomes 0%, it will change to "⊗" (red), the lamp will automatically turn off. At this time, the lamp indicator will illuminate in red.

If you try to turn on the projector a fourth time without replacing the lamp, the lamp whose life is 0% will not light up.

Maintenance Indicators

	Maintenance indicator		Problem	Cause	Possible solution
	Normal	Abnormal			
Temperature warning indicator	Off	Red on (Standby)	The internal temperature is abnormally high.	<ul style="list-style-type: none"> Blocked air intake Cooling fan break-down Internal circuit failure Clogged air intake Clogged intake vent cover 	<ul style="list-style-type: none"> Relocate the projector to an area with proper ventilation. (See page 9.) Take the projector to your nearest Sharp Authorized Projector Dealer or Service Center for repair. (See page 101.) Clean the air vents and the intake vent cover. (See page 90.)
Lamp indicators 1, 2	Green on (Green blinks when the lamp is warming up.)	Red on	The lamp does not illuminate.	<ul style="list-style-type: none"> The lamp is shut down abnormally. 	<ul style="list-style-type: none"> Disconnect the power cord from the AC outlet, and then connect it again. Carefully replace the lamp. (See page 94.) Take the projector to your nearest Sharp Authorized Projector Dealer or Service Center for repair. (See page 101.) Please exercise care when replacing the lamp.
		Red on (Standby)	Time to change the lamp.	<ul style="list-style-type: none"> Remaining lamp life becomes 5% or less. 	
Power indicator	Green on/ Red on	Red blinks	The power indicator blinks in red when the projector is on.	<ul style="list-style-type: none"> Burnt-out lamp Lamp circuit failure The intake vent cover is open. 	<ul style="list-style-type: none"> Securely install the cover. If the power indicator blinks even when the intake vent cover is securely installed, contact your nearest Sharp Authorized Projector Dealer or Service Center for advice. (See page 101.)

Info

- If the temperature warning indicator blinks and the projector enters the standby mode, the temperature warning indicator starts to illuminate. Check whether any of the ventilation holes are blocked (see page [9](#)) and then try turning the power back on. Wait until the projector has cooled down completely before plugging in the power cord and turning the power back on. (At least 10 minutes.)
- If the power is turned off for a brief moment due to power outage or some other cause while using the projector, and the power supply recovers immediately after that, the lamp indicator will illuminate in red and the lamp may not be lit. In this case, unplug the power cord from the AC outlet, replace the power cord in the AC outlet and then turn the power on again.
- Do not unplug the power cord after the projector has entered the standby mode and while the cooling fan is running. The cooling fan runs for about 90 seconds.

Regarding the Lamp

Lamp

- It is recommended that the lamp units (optional: AN-PH50LP1 and AN-PH50LP2) be replaced when the remaining lamp life becomes 5% or less, or when you notice a significant deterioration in the picture and color quality. The lamp life (percentage) can be checked with the on-screen display. See page 83.
- Purchase a replacement lamp unit of type AN-PH50LP1 and AN-PH50LP2 from your place of purchase, nearest Sharp Authorized Projector Dealer or Service Center.

IMPORTANT NOTE TO U.S. CUSTOMERS:

The lamp included with this projector is backed by a 90-day parts and labor limited warranty. All service of this projector under warranty, including lamp replacement, must be obtained through a Sharp Authorized Projector Dealer or Service Center. For the name of the nearest Sharp Authorized Projector Dealer or Service Center, please call toll-free: 1-888-GO-SHARP (1-888-467-4277).

Hg LAMP CONTAINS MERCURY For State Lamp Disposal Information
www.lamprecycle.org or 1-800-BE-SHARP

U.S.A. ONLY

Caution Concerning the Lamp

- This projector utilizes a pressurized mercury lamp. A loud sound may indicate lamp failure. Lamp failure can be attributed to numerous sources such as: excessive shock, improper cooling, surface scratches or deterioration of the lamp due to a lapse of usage time. The period of time up to failure largely varies depending on the individual lamp and/or the condition and the frequency of use. It is important to note that failure can often result in the bulb cracking.
- When the lamp indicator and on-screen display icon are illuminated, it is recommended that the lamp be replaced with a new one immediately, even if the lamp appears to be operating normally.
- Should the lamp break, the glass particles may spread inside the lamp cage or gas contained in the lamp may be vented into the room from the exhaust vent. Because the gas in this lamp includes mercury, ventilate the room well if the lamp breaks and avoid all exposure to the released gas. In case of exposure to the gas, consult a doctor as soon as possible.
- Should the lamp break, there is also a possibility that glass particles may spread inside of the projector. In such a case, it is recommended you contact your nearest Sharp Authorized Projector Dealer or Service Center to assure safe operation.

Replacing the Lamp

Caution

- Do not remove the lamp unit from the projector right after use. The lamp will be very hot and may cause burn or injury.
 - Wait at least one hour after the power cord is disconnected to allow the surface of the lamp unit to fully cool before removing the lamp unit.
 - **Carefully change the lamp by following the instructions described in this section. *If you wish, you may have the lamp replaced at your nearest Sharp Authorized Projector Dealer or Service Center.**
- * If the new lamp does not illuminate after replacement, take your projector to the nearest Sharp Authorized Projector Dealer or Service Center for repair.

Removing and Installing the Lamp Unit

Info

- Ensure the lamp unit is removed using the handle. Ensure the glass surface of the lamp unit or the inside of the projector are not touched.
- To avoid injury to yourself and damage to the lamp, ensure to carefully follow the steps below.
- Do not loosen other screws except for the lamp unit cover and lamp unit. (Only the silver screws are loosened.)

- 1 Press  on the projector or  on the remote control to put the projector into standby mode.**
 - Wait until the cooling fan stops.

Warning!

- Do not remove the lamp unit from the projector right after use. The lamp and parts around the lamp will be very hot and may cause burn or injury.

- 2 Disconnect the power cord.**
 - Unplug the power cord from the AC socket.
 - Leave the lamp until it has fully cooled down (about 1 hour).

- 3 Remove the lamp unit cover.**
 - Loosen the user service screw (①) that secures the lamp unit cover. Remove the lamp unit cover (②).

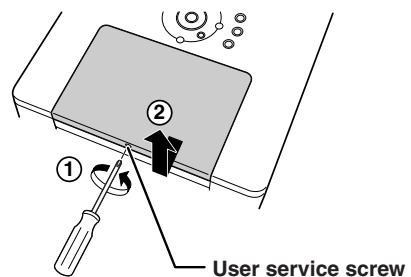
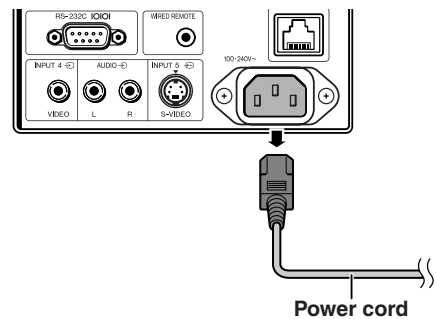
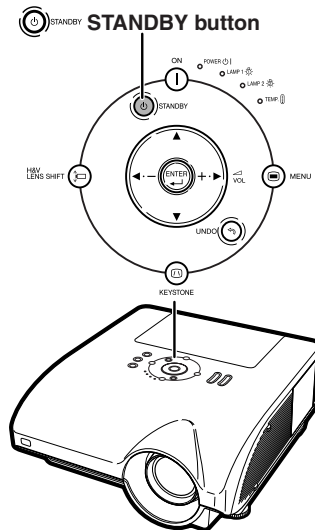
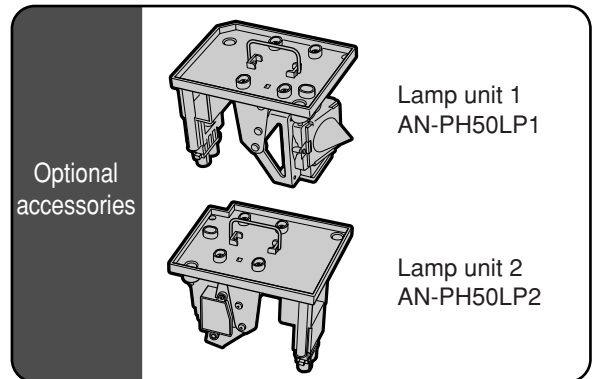

4 Remove the lamp unit.

- Loosen the securing screws (two for each lamp) from the lamp unit. Hold the lamp unit by the handle and pull it in the direction of the arrow. At this time, keep the lamp unit horizontal and do not tilt it.

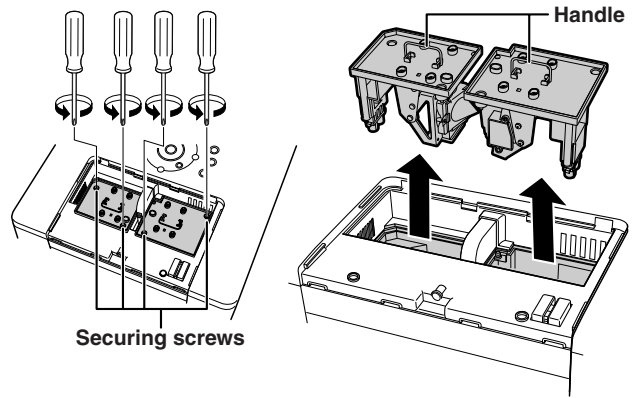

5 Insert the new lamp unit.

- Press the lamp unit firmly into the lamp unit compartment. Fasten the securing screws.
- Be sure that AN-PH50LP1 and AN-PH50LP2 are respective type.

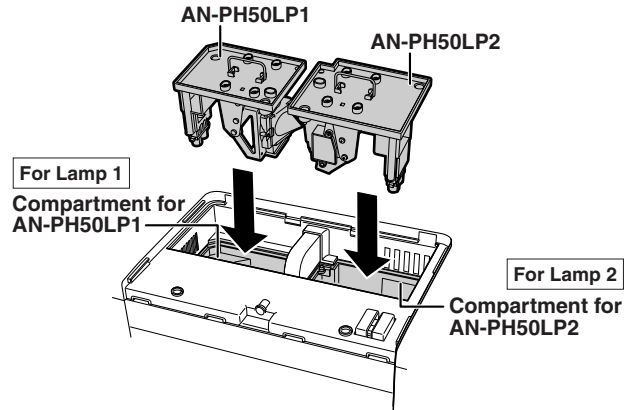

6 Replace the lamp unit cover.

- Align the lamp unit cover and slide it to close. Then tighten the user service screw to secure the lamp unit cover.

Info

- If the lamp unit and lamp unit cover are not correctly installed, the power will not turn on, even if the power cord is connected to the projector.

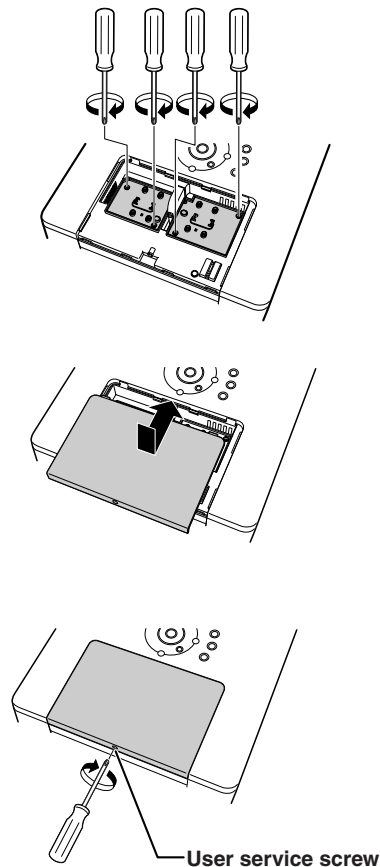

Resetting the Lamp Timer

Reset the lamp timer after replacing the lamp.

Info

- Make sure to reset the lamp timer only when replacing the lamp. If you reset the lamp timer and continue to use the same lamp, this may cause the lamp to become damaged or explode.

1 Connect the power cord.

- Plug the power cord into the AC socket of the projector.

2 Reset the lamp timer.

For Lamp 1

- When you reset the timer for AN-PH50LP1, while simultaneously holding down **H&V LENS SHIFT** and **ENTER**, press **ON** on the projector.
- “LAMP 1 100%” is displayed, indicating that the lamp timer is reset.

For Lamp 2

- When you reset the timer for AN-PH50LP2, while simultaneously holding down **MENU** and **ENTER**, press **ON** on the projector.
- “LAMP 2 100%” is displayed, indicating that the lamp timer is reset.

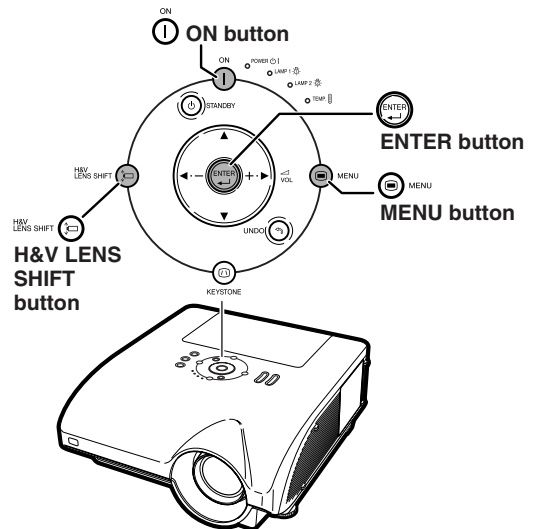
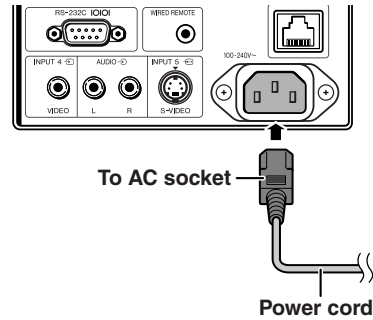

Computer Compatibility Chart

The table below lists signal codes that are compatible with the projector. When the images are distorted or cannot be projected, adjust the output signal of your computer and so forth while referring to the table below.

Computer

- Multiple signal support
Horizontal Frequency: 15–126 kHz
Vertical Frequency: 43–200 Hz
Pixel Clock: 12–230 MHz
Sync signal: Compatible with TTL level
- Compatible with sync on green signal
- UXGA, SXGA+ and SXGA compatible in advanced intelligent compression
- AICS (Advanced Intelligent Compression and Expansion System) resizing technology

The following is a list of modes that conform to VESA. However, this projector supports other signals that are not VESA standards.

PC/MAC/WS	Resolution	Horizontal Frequency (kHz)	Vertical Frequency (Hz)	VESA Standard	DVI Support	Display	
PC	640 × 350	27.0	60			Upscale	
		31.5	70				
		37.9	85	✓			
	27.0	60					
	720 × 350	31.5	70				
		27.0	60		✓		
		31.5	70		✓		
	640 × 400	27.0	60				
		31.5	70		✓		
		37.9	85	✓	✓		
	720 × 400	27.0	60		✓		
		31.5	70		✓		
		37.9	85	✓	✓		
	VGA	640 × 480	26.2	50			
			31.5	60			✓
			34.7	70			
			37.9	72	✓		✓
		37.5	75	✓	✓		
		43.3	85	✓	✓		
		47.9	90				
		53.0	100				
		61.8	120				
		78.5	150				
	SVGA	800 × 600	31.4	50			
			35.1	56	✓		✓
			37.9	60	✓		✓
			44.5	70			
			48.1	72	✓		✓
			46.9	75	✓		✓
			53.7	85	✓		✓
			56.8	90			
			64.0	100			
			77.2	120			
	XGA	1,024 × 768	98.3	150			
			102.1	160			
			125.6	200			
			35.5	43			✓
			40.3	50			
			48.4	60	✓		✓
			56.5	70	✓		✓
58.1			72				
60.0			75	✓	✓		
68.7			85	✓	✓		
73.5	90						
77.2	96						
80.6	100						
98.8	120						
113.2	140						
PC	SXGA	1,152 × 864	54.3	60		✓	Advanced intelligent Compression
			64.0	70			
			64.1	72			
			67.5	75	✓	✓	
			75.7	80			
			77.3	85			
			90.2	100			
			54.8	60			
			65.9	72			
			67.4	74			
	SXGA+	1,280 × 1,024	64.0	60	✓	✓	
			74.6	70			
			78.1	74			
			80.0	75	✓		
			91.1	85	✓		
			108.4	100			
			64.0	60			
			74.7	52			
			75.0	60	✓		
			81.3	65	✓		
UXGA	1,600 × 1,200	87.5	70	✓			
		90.1	72				
		93.8	75	✓			
		106.3	85	✓			
PC/MAC 13"	VGA	640 × 480	34.9	67			Upscale
PC/MAC 19"	XGA	1,024 × 768	48.4	60	✓	✓	True
			60.0	75	✓	✓	
PC/MAC 21"	SXGA	1,280 × 1,024	80.0	75	✓		Advanced intelligent Compression
MAC 16"	SVGA	800 × 600	46.8	75			Upscale
			832 × 624	49.6	75		
MAC 21"	SXGA	1,152 × 870	68.5	75			Advanced intelligent Compression
HP (WS)	1,280 × 1,024	78.1	72				
PC (WS)		60.0	60	✓			
WS	1,280 × 960	85.9	85				
SGI (WS)	SXGA	1,280 × 1,024	53.5	50			Advanced intelligent Compression
WS			76.8	72			
SUN (WS)	1,152 × 900	60.9	66				
		71.9	76				

Computer Compatibility Chart



Note

- This projector may not be able to display images from notebook computers in simultaneous (CRT/LCD) mode. Should this occur, turn off the LCD display on the notebook computer and output the display data in "CRT only" mode. Details on how to change display modes can be found in your notebook computer's operation manual.
- When this projector receives 640 × 350 VESA format VGA signals, "640 × 400" appears on the screen.
- When projecting the RGB interlace signal using INPUT 1/2 with "Signal Type" set to "Auto" or "RGB", the image may not be projected as desired. In this case, select either INPUT 4 (video) or INPUT 5 (S-video).

DTV

Signal	Horizontal Frequency (kHz)	Vertical Frequency (Hz)	DVI Support (Compatible with HDCP)
480I/525I	15.7	60	
480P/525P	31.5	60	✓
540P	33.8	60	
576I/625I	15.6	50	
576P/625P	31.3	50	✓
720P/750P	45.0	60	✓
720P/750P	37.5	50	✓
1035I/1125I	33.8	60	✓
1080I/1125I	33.8	60	✓
1080I/1125I	28.1	50	✓

Troubleshooting

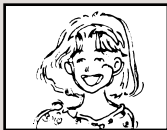
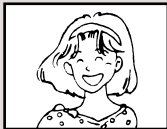
Problem	Check	Page
 No picture and no sound or projector does not start.	• Projector power cord is not plugged into the wall outlet.	37
	• Power to the external connected devices is off.	—
	• The selected input mode is wrong.	45
	• Cables incorrectly connected to side panel of the projector.	27—36
	• Remote control batteries have run out.	17
	• External output has not been set when connecting notebook computer.	27
 Sound is heard but no picture appears.	• Cables incorrectly connected to the side panel of the projector.	27—36
	• “Bright” is set to minimum position.	60
	• The “BLACK SCREEN” function is working.	50
 Color is faded or poor.	• Image adjustments are incorrectly set. (INPUT 1, INPUT 2, INPUT 3 only)	60
	• Input signal type (RGB/Component) is incorrectly set. (INPUT 4, INPUT 5 only)	63
	• Video Input system is incorrectly set.	76
 Picture is blurred; noise appears.	• Adjust the focus.	40
	• The projection distance exceeds the focus range.	22
	(Computer Input only)	
	• Perform “Fine Sync” Adjustments. (“Clock” Adjustment)	68
	• Perform “Fine Sync” Adjustments. (“Phase” Adjustment)	68
• Noise may appear depending on the computer.	—	
 Picture appears but no sound is heard.	• Cables incorrectly connected to side panel of the projector.	27—36
	• Volume is set to minimum.	46
	• The “MUTE” function is working.	46
	• The “Speaker” menu is set to “OFF”.	73
An unusual sound is occasionally heard from the cabinet.	• If the picture is normal, the sound is due to cabinet shrinkage caused by room temperature changes. This will not affect operation or performance.	—
Maintenance indicator illuminates or blinks in red.	• See “Maintenance Indicators”.	91
The projector cannot be turned on or put into the standby mode using the ON or STANDBY button on the projector.	• If the “Keylock Level” menu is set to “Level A” or “Level B”, all or specific buttons on the projector are unavailable. Use the remote control to operate the projector.	85

Problem	Check	Page
All buttons on the projector and the remote control are unavailable.	<ul style="list-style-type: none"> If the “Stack Setting” menu is set to “Slave” and the “Keylock Level” menu is set to “Level B”, all buttons on the projector and the remote control are unavailable. Connect the remote control to the projector, and then use the remote control to operate the projector. 	18 84 85
Picture is green on INPUT 1 or 2 (COMPONENT).	<ul style="list-style-type: none"> Change the input signal type setting. 	63
Picture is pink (no green) on INPUT 1, 2 or 3 (RGB).		
Picture is too bright and whitish.	<ul style="list-style-type: none"> Image adjustments are incorrectly set. 	60
The cooling fan becomes noisy.	<ul style="list-style-type: none"> When temperature inside the projector increases, the cooling fan runs faster. 	—
The lamp does not light up even after the projector turns on.	<ul style="list-style-type: none"> The lamp indicator is illuminating in red. Replace the lamp. 	91
The lamp suddenly turns off during projection.		
The image sometimes flickers.	<ul style="list-style-type: none"> Cables incorrectly connected to the projector or the connected equipment works improperly. If this happens frequently, replace the lamp. 	27—36 94
The lamps take a long time to turn on.	<ul style="list-style-type: none"> The lamps will eventually need to be changed. The lamps have reached the end of its life. Replace the lamps. 	94
Picture is dark.		

This projector is equipped with a microprocessor. Its performance could be adversely affected by incorrect operation or interference. If this should happen, unplug the projector and plug it in again after more than 5 minutes.

For SHARP Assistance

If you encounter any problems during setup or operation of this projector, first refer to the “Troubleshooting” section on pages 99 and 100. If this operation manual does not answer your question, please contact the SHARP Service departments listed below.

U.S.A.	Sharp Electronics Corporation 1-888-GO-SHARP (1-888-467-4277) lcdsupport@sharpsec.com http://www.sharplcd.com	Benelux	SHARP Electronics Benelux BV 0900-SHARPCE (0900-7427723) Nederland 9900-0159 Belgium http://www.sharp.nl http://www.sharp.be http://www.sharp.lu
Canada	Sharp Electronics of Canada Ltd. (905) 568-7140 http://www.sharp.ca	Australia	Sharp Corporation of Australia Pty. Ltd. 1300-135-022 http://www.sharp.net.au
Mexico	Sharp Electronics Corporation Mexico Branch (525) 716-9000 http://www.sharp.com.mx	New Zealand	Sharp Corporation of New Zealand (09) 634-2059, (09) 636-6972 http://www.sharp.net.nz
Latin America	Sharp Electronics Corp. Latin American Group (305) 264-2277 www.servicio@sharpsec.com http://www.siempresharp.com	Singapore	Sharp-Roxy Sales (S) Pte. Ltd. 65-226-6556 ckng@srs.global.sharp.co.jp http://www.sharp.com.sg
Germany	Sharp Electronics (Europe) GMBH 01805-234675 http://www.sharp.de	Hong Kong	Sharp-Roxy (HK) Ltd. (852) 2410-2623 dcmktg@srh.global.sharp.co.jp http://www.sharp.com.hk
U.K.	Sharp Electronics (U.K.) Ltd. 0161-205-2333 cic@sharp-uk.co.uk http://www.sharp.co.uk	Taiwan	Sharp Corporation (Taiwan) 0800-025111 http://www.sharp-scot.com.tw
Italy	Sharp Electronics (Italy) S.P.A. (39) 02-89595-1 http://www.sharp.it	Malaysia	Sharp-Roxy Sales & Service Co. (60) 3-5125678
France	Sharp Electronics France 01 49 90 35 40 hotlineced@sef.sharp-eu.com http://www.sharp.fr	U.A.E.	Sharp Middle East Fze 971-4-81-5311 helpdesk@smef.global.sharp.co.jp
Spain	Sharp Electronica Espana, S.A. 93 5819700 sharplcd@sees.sharp-eu.com http://www.sharp.es	Thailand	Sharp Thebnakorn Co. Ltd. 02-236-0170 svc@stcl.global.sharp.co.jp http://www.sharp-th.com
Switzerland	Sharp Electronics (Schweiz) AG 0041 1 846 63 11 cattaneo@sez.sharp-eu.com http://www.sharp.ch	Korea	Sharp Electronics Incorporated of Korea (82) 2-3660-2002 lcd@sharp-korea.co.kr http://www.sharpkorea.co.kr
Sweden	Sharp Electronics (Nordic) AB (46) 8 6343600 vision.support@sen.sharp-eu.com http://www.sharp.se	India	Sharp Business Systems (India) Limited (91) 11- 6431313 service@sharp-oa.com
Austria	Sharp Electronics (Europe) GMBH Branch Office Austria 0043 1 727 19 123 pogats@sea.sharp-eu.com http://www.sharp.at		

Specifications

Product type	Multimedia Projector
Model	XG-PH50X (standard zoom lens attached)/XG-PH50X-NL (no lens attached)
Video system	NTSC3.58/NTSC4.43/PAL/PAL-M/PAL-N/PAL-60/SECAM/ DTV480I/DTV480P/DTV540P/DTV576I/DTV576P/DTV720P/DTV1035I/DTV1080I
Display method	Single Chip Digital Micromirror Device™ (DMD™) by Texas Instruments
DMD panel	Panel size: 0.7" No. of dots: 786,432 dots (1,024 [H] × 768 [V])
Standard zoom lens	1.2 × electric zoom/focus lens, F1.8–F2.0, f = 25.6–31.3 mm (standard equipment with XG-PH50X)
Projection lamp	250 W × 2
Component input (INPUT 1)/ output (OUTPUT) signal	15-pin mini D-sub connector Y: 1.0 Vp-p, sync negative, 75 Ω terminated P _B : 0.7 Vp-p, 75 Ω terminated P _R : 0.7 Vp-p, 75 Ω terminated
Horizontal resolution	750 TV lines (DTV720P)
Component input (INPUT 2) signal	BNC connector Y: 1.0 Vp-p, sync negative, 75 Ω terminated P _B : 0.7 Vp-p, 75 Ω terminated P _R : 0.7 Vp-p, 75 Ω terminated
RGB input (INPUT 1/2)/output (OUTPUT) signal	15-pin mini D-sub connector, 5 BNC connector: RGB separate/composite sync (TTL)/sync on green type analog input: 0–0.7 Vp-p, positive, 75 Ω terminated Horizontal sync. signal: TTL level (positive/negative) or composite sync (Apple only) Vertical sync. signal: Same as above
RGB digital input signal (INPUT 3)	DVI connector (24-pin), RGB (digital), 250 –1,000 mV, 50 Ω (Compatible with HDCP)
Video input signal (INPUT 4)	RCA connector: VIDEO, composite video, 1.0 Vp-p, sync negative, 75 Ω terminated
S-video input signal (INPUT 5)	4-pin mini DIN connector Y (luminance signal): 1.0 Vp-p, sync negative, 75 Ω terminated C (chrominance signal): Burst 0.286 Vp-p, 75 Ω terminated
Audio input signal	ø3.5 mm stereo minijack, RCA terminal 0.5 Vrms, more than 22 kΩ
Audio output signal (AUDIO OUTPUT 1–5)	ø3.5 mm minijack 0.5 Vrms, less than 2.2 kΩ
RS-232C terminal	9-pin D-sub connector
LAN terminal	8-pin RJ-45 modular connector
Pixel clock	12–230 MHz
Vertical frequency	43–200 Hz
Horizontal frequency	15–126 kHz
Audio output	3.0 W (stereo)
Speaker system	4.5 cm round × 2
Rated voltage	AC 100–240 V
Input current	6.3 A (AC 100 V)–2.6 A (AC 240 V)
Rated frequency	50/60 Hz
Power consumption	630 W (when “Eco Mode” is “OFF”)/505 W (when “Eco Mode” is “ON”) with AC 100 V 600 W (when “Eco Mode” is “OFF”)/485 W (when “Eco Mode” is “ON”) with AC 240 V
Power consumption (standby)	0.75 W (AC 100 V) – 1.25 W (AC 240 V) (When “Monitor Out” and “LAN/RS232C” are set to “Disable”.)
Heat dissipation	2,370 BTU/hour (when “Eco Mode” is “OFF”)/1,900 BTU/hour (when “Eco Mode” is “ON”) with AC 100 V 2,260 BTU/hour (when “Eco Mode” is “OFF”)/1,825 BTU/hour (when “Eco Mode” is “ON”) with AC 240 V
Operating temperature	41°F to 104°F (+5°C to +40°C)
Storage temperature	–4°F to 140°F (–20°C to +60°C)
Cabinet	Plastic
I/R carrier frequency	38 kHz
Dimensions (approx.)	16 5/32" × 7 3/32" × 18 35/64" (410 (W) × 180 (H) × 471 (D) mm) (main body only) 16 5/32" × 7 37/64" × 18 35/64" (410 (W) × 192.1 (H) × 471 (D) mm) (including adjustment foot and projecting parts)
Weight (approx.)	XG-PH50X: 32.7 lbs. (14.8 kg) XG-PH50X-NL: 30.0 lbs. (13.6 kg)
Replacement parts	Lamp unit (AN-PH50LP1/AN-PH50LP2), Remote control (9NK5041808700), Power cord for U.S., Canada, etc. (9NK3090152800), Power cord for Europe, except U.K. (9NK3090152700), Power cord for U.K., Hong Kong and Singapore (9NK3090152900), Power cord for Australia, New Zealand and Oceania (9NK3090152600), RGB cable (9NK3080431000), Remote mouse receiver (9NK3790197000), Cap for the standard zoom lens (9NK3797200400), Projector manual and technical reference CD-ROM (9NK3532094500), Operation manual (9NK5010011800)

As a part of policy of continuous improvement, SHARP reserves the right to make design and specification changes for product improvement without prior notice. The performance specification figures indicated are nominal values of production units. There may be some deviations from these values in individual units.

Advanced intelligent compression (Page 97)

High quality resizing of lower and higher resolution images to fit the projector's native resolution.

Aspect ratio (Page 48)

Width and height ratio of an image. The normal aspect ratio of a computer and video image is 4:3. There are also wide images with an aspect ratio of 16:9 and 21:9.

Auto Sync (Page 70)

Optimizes projected computer images by automatically adjusting certain characteristics.

Background (Page 77)

Initial setting image projected when no signal is being output.

Border (Page 49)

Projects a 4:3 image fully within a 16:9 screen by keeping the aspect ratio at 4:3.

Clock (Page 68)

Clock adjustment is used to adjust vertical noise when clock level is incorrect.

CLR Temp (Color temperature) (Page 61)

Function that can be used to adjust the color temperature to suit the type of image input to the projector. Decrease the color temperature to create warmer, reddish images for natural flesh tones, or increase to create cooler, bluish images for a brighter picture.

C.M.S. (Color Management System) (Page 64)

Function allows you individually adjust the display characteristics of six colors (R: Red, Y: Yellow, G: Green, C: Cyan, B: Blue, M: Magenta)

Dot by Dot (Page 48)

Mode that projects images in their native resolution.

Keylock Level (Page 85)

Mode that can lock the operation of projector buttons to prevent unauthorized adjustment.

Keystone Correction (Page 41)

Function to digitally correct a distorted image when the projector is set up at an angle, smoothens out jaggies on keystone images and compresses the image not only horizontally but vertically keeping the 4:3 aspect ratio.

Phase (Page 68)

Phase shift is a timing shift between isomorphic signals with the same resolution. When phase level is incorrect, the projected image typically displays horizontal flicker.

Pict in Pict (Page 74)

The Pict in Pict (picture in picture) function allows you to display two pictures on the same screen. You can display the image input from a video as an inset picture overlapping the main picture input from a computer.

Picture Mode (Page 60)

Image quality enhancement function that offers a richer image by brightening the darker portions of the image without altering the brightness of the brighter portions. You can select four different modes: STANDARD, PRESENTATION, CINEMA and CUSTOM.

Progressive (Page 62)

The progressive display projects a smoother video image. You can select three different modes: 2D Progressive, 3D Progressive and Film Mode.

Resize (Page 48)

Allows you to modify or customize the picture display mode to enhance the input image. You can select six different modes: NORMAL, FULL, DOT BY DOT, BORDER, STRETCH and SMART STRETCH.

Shifting the lens (Page 38)

Function to adjust the position of the projected image for the position of the screen by shifting the lens horizontally and vertically.

Smart Stretch (Page 49)

Projects the image fully in a 16:9 screen by enlarging only the surrounding areas while keeping the aspect ratio in the middle part of the image at 4:3.

sRGB (Page 64)

An international standard of color reproduction regulated by the IEC (International Electrotechnical Commission). As the fixed color area has been decided by the IEC, the color changes according to DLP features, so that the images are displayed in a natural tint based on an original image, when "C.M.S. Adjustment" is set to "sRGB".

Stack Setting (Page 84)

Setting for the stack projection that allows you to increase the brightness of an image by stacking multiple projectors and projecting same image simultaneously. You can control projectors for the stack projection by assigning a projector as the master and the other projectors as the slaves.

Stretch (Page 49)

Mode that stretches the 4:3 image horizontally to display it fully on a 16:9 screen.

System Lock (Page 79)

If the "Keycode" set in the projector is not correctly entered, the projector will not operate even if signals are entered.

AC socket	37	Lamp unit cover	94
ADJ./MOUSE switch	18	LAN terminal	35
Adjustment buttons	56	LAN/RS232C	87
Adjustment feet	39	Language	89
Advanced intelligent compression	97	L-click button	19
Aspect ratio	48	Lens cap	13
Audio	72	MENU button	56
AUDIO input (1) terminal	27	Monitor Out	87
AUDIO input (2, 3) terminal	28	Mouse button	19
AUDIO input (4, 5) terminal	34	MUTE button	46
Audio Out	72	Normal	48
AUDIO OUTPUT terminal	36	ON button	37
Auto Power Off	79	Options (1)	74
Auto Search	78	Options (2)	82
Auto Sync (Auto Sync adjustment)	70	OSD Display	75
AUTO SYNC button	70	OUTPUT (FOR INPUT 1, 2) terminal	36
Auto Sync Disp	71	Pair Stack	85
Background	77	Password	82
BLACK SCREEN button	50	Phase	68
Border	49	Pict in Pict	74
BREAK TIMER button	50	Picture	60
Bright Boost	61	Picture Mode	60
C.M.S. (Color Management System)	64	PICTURE MODE button	47
C.M.S. Adjustment	64	Power cord	37
Carrying handle	13	Power indicator	14
Clock	68	PRJ mode	84
CLR Temp (Color Temperature)	61	Progressive	62
Digi. Shift	75	R-click button	19
DNR	62	Remote control	17
Dot By Dot	48	Remote control sensor	17
Eco Mode	78	Remote mouse receiver	19
ENLARGE buttons	46	Resize	48
ENTER button	56	RESIZE button	48
Exhaust vent	90	RGB cable	27
Fine Sync	68	RS-232C	86
FOCUS buttons	40	RS-232C terminal	35
FREEZE button	47	Save Setting	68
Geometric adjustment	42	Select Setting	69
H & V keystone	43	Service Mode	88
H & V LENS SHIFT button	39	Set Inputs	86
Image Capture	76	Signal Info	70
Image resizing	44	Signal Type	63
INPUT 1 – 5 modes	45	Smart Stretch	49
INPUT 1 terminal	27	Speaker	73
INPUT 2 terminals	28	Special Modes	69
INPUT 3 terminal	29	sRGB	64
INPUT 4 terminal	34	Stack Setting	84
INPUT 5 terminal	34	STANDBY button	37
INPUT buttons	45	Startup Image	77
Intake vent	90	Status	89
Kensington Security Standard connector	15	Stretch	49
Keycode	79	System Lock	79
Keylock Level	85	Temperature warning indicator	91
KEystone button	41	UNDO button	56
Keystone Correction	41	Video System	76
Lamp	93	Volume buttons	46
Lamp indicators 1, 2	91	WIRED R/C JACK	18
Lamp Mode	83	WIRED REMOTE terminal	18
Lamp Timer (Life)	83	ZOOM buttons	40

Free Manuals Download Website

<http://myh66.com>

<http://usermanuals.us>

<http://www.somanuals.com>

<http://www.4manuals.cc>

<http://www.manual-lib.com>

<http://www.404manual.com>

<http://www.luxmanual.com>

<http://aubethermostatmanual.com>

Golf course search by state

<http://golfingnear.com>

Email search by domain

<http://emailbydomain.com>

Auto manuals search

<http://auto.somanuals.com>

TV manuals search

<http://tv.somanuals.com>