



FACSIMILE EXPANSION KIT

OPERATION GUIDE

	Page
• BEFORE USING THE FAX FUNCTION.....	6
• BASIC OPERATIONS	16
• ADVANCED TRANSMISSION METHODS	31
• TRANSMISSION USING F-CODES	52
• CONVENIENT METHODS OF USE	64
• PROGRAMMING	66
• TROUBLESHOOTING.....	90
• SYSTEM SETTINGS.....	96
• APPENDIX.....	112

Be sure to become thoroughly familiar with this manual to gain the maximum benefit from the product.

Before installing this product, be sure to read the cautions sections of the Start Guide.

Be sure to keep all operation guides handy for reference including this manual, the Start Guide and Operation Guide for any optional equipment which has been installed.

Telecommunication Line Cable:

Use only the line cable that was provided with the machine.



Notice for Users in Europe

Hereby, SHARP Electronics (Europe) GmbH declares that this Facsimile Expansion Kit MX-FX13 is in compliance with the essential requirements and other relevant provisions of Directive 1999/5/EC.

Par la présente, SHARP Electronics (Europe) GmbH déclare que l'appareil Facsimile Expansion Kit MX-FX13 est conforme aux exigences essentielles et aux autres dispositions pertinentes de la directive 1999/5/CE.

Hiermit erklärt SHARP Electronics (Europe) GmbH, dass sich das Gerät Facsimile Expansion Kit MX-FX13 in Übereinstimmung mit den grundlegenden Anforderungen und den übrigen einschlägigen Bestimmungen der Richtlinie 1999/5/EG befindet.

С настоящето SHARP Electronics (Europe) GmbH декларира, че Facsimile Expansion Kit MX-FX13 отговаря на съществените изисквания и другите приложими изисквания на Директива 1999/5/EC.

SHARP Electronics (Europe) GmbH tímto prohlašuje, že Facsimile Expansion Kit MX-FX13 splňuje základní požadavky a všechna příslušná ustanovení Směrnice 1999/5/ES.

Undertegnede SHARP Electronics (Europe) GmbH erklærer herved, at følgende udstyr Facsimile Expansion Kit MX-FX13 overholder de væsentlige krav og øvrige relevante krav i direktiv 1999/5/EF.

Käesolevaga kinnitab SHARP Electronics (Europe) GmbH seadme Facsimile Expansion Kit MX-FX13 vastavust direktiivi 1999/5/EÜ põhinõuetele ja nimetatud direktiivist tulenevatele teistele asjakohastele sätetele.

ΜΕ ΤΗΝ ΠΑΡΟΥΣΑ SHARP Electronics (Europe) GmbH ΔΗΛΩΝΕΙ ΟΤΙ Facsimile Expansion Kit MX-FX13 ΣΥΜΜΟΡΦΩΝΕΤΑΙ ΠΡΟΣ ΤΙΣ ΟΥΣΙΩΔΕΙΣ ΑΠΑΙΤΗΣΕΙΣ ΚΑΙ ΤΙΣ ΛΟΙΠΕΣ ΣΧΕΤΙΚΕΣ ΔΙΑΤΑΞΕΙΣ ΤΗΣ ΟΔΗΓΙΑΣ 1999/5/ΕΚ.

Por la presente, SHARP Electronics (Europe) GmbH, declara que este Facsimile Expansion Kit MX-FX13 cumple con los requisitos esenciales y otras exigencias relevantes de la Directiva 1999/5/EC.

SHARP Electronics (Europe) GmbH vakuuttaa täten että Facsimile Expansion Kit MX-FX13 tyyppinen laite on direktiivin 1999/5/EY oleellisten vaatimusten ja sitä koskevien direktiivin muiden ehtojen mukainen.

Con la presente SHARP Electronics (Europe) GmbH dichiara che questo Facsimile Expansion Kit MX-FX13 è con-forme ai requisiti essenziali ed alle altre disposizioni pertinenti stabilite dalla direttiva 1999/5/CE.

Alulírott, SHARP Electronics (Europe) GmbH nyilatkozom, hogy a Facsimile Expansion Kit MX-FX13 megfelel a vonatkozó alapvető követelményeknek és az 1999/5/EC irányelv egyéb előírásainak.

Ar šo SHARP Electronics (Europe) GmbH deklarē, ka Facsimile Expansion Kit MX-FX13 atbilst Direktīvas 1999/5/EK būtiskajām prasībām un citiem ar to saistītajiem noteikumiem.

Šiuo SHARP Electronics (Europe) GmbH deklaruoja, kad šis Facsimile Expansion Kit MX-FX13 atitinka esminius reikalavimus ir kitas 1999/5/EB Direktyvos nuostatas.

Hierbij verklaart SHARP Electronics (Europe) GmbH dat het toestel Facsimile Expansion Kit MX-FX13 in overeenstemming is met de essentiële eisen en de andere relevante bepalingen van richtlijn 1999/5/EG.

Niniejszym SHARP Electronics (Europe) GmbH deklaruje że Facsimile Expansion Kit MX-FX13 jest zgodny z zasadniczymi wymaganiami i innymi właściwymi postanowieniami Dyrektywy 1999/5/EC.

Prin prezenta, SHARP Electronics (Europe) GmbH, declară că aparatul Facsimile Expansion Kit MX-FX13 este în conformitate cu cerințele esențiale și cu alte prevederi pertinente ale Directivei 1999/5/CE.

SHARP Electronics (Europe) GmbH tímto vyhlasuje, že Facsimile Expansion Kit MX-FX13 splňuje základné požiadavky a všetky príslušné ustanovenia Smernice 1999/5/ES.

SHARP Electronics (Europe) GmbH izjavlja, da je ta Facsimile Expansion Kit MX-FX13 v skladu z bistvenimi zahtevami in drugimi relevantnimi določili direktive 1999/5/ES.

Härmed intygar SHARP Electronics (Europe) GmbH att denna Facsimile Expansion Kit MX-FX13 står i överensstämmelse med de väsentliga egenskapskrav och övriga relevanta bestämmelser som framgår av direktiv 1999/5/EG.

SHARP Electronics (Europe) GmbH erklærer herved at udstyret Facsimile Expansion Kit MX-FX13 er i samsvar med de grunnleggende krav og øvrige relevante krav i direktiv 1999/5/EF.

This equipment has been designed to work on the British analogue public switched telephone network.

This equipment has been tested according to the pan-European ES 203 021 regulation.

It will operate on all analogue telephone networks which comply with the ES 203 021.

Please contact your dealer or network operator, if you are not sure whether your network operates according to ES 203 021.

INTRODUCTION

Thank you for purchasing this product. This manual only explains the facsimile functions of the product. For safety precautions and general information on using the machine such as loading paper, clearing misfeeds, and handling peripheral units, see the Operation Guide for the machine.

For other functions, see the following manuals as appropriate:

Copier function/Printer function: See the Operation Guide.

Network printer function/Network scanner function: See the "Operation Guide(for Network Expansion kit)" (if the Network Expansion kit option is installed).

The explanations in this manual assume that certain optional peripheral units are installed.

This manual refers to the Reversing single pass feeder as the "RSPF" and the single pass feeder as the "SPF". Unless specific mention is made, both the RSPF and the SPF are referred to simply as "SPF".

The fax function is not available in some countries and regions.

CONNECTING AN EXTENSION PHONE

You can connect a telephone to the machine and use it as an extension phone to place and receive calls like any normal phone. Fax reception can also be activated from an extension phone connected to the machine. (remote operation)



- If you connect a combination telephone/answering machine to the machine, you will not be able to use the answering machine function.
- You can place calls from the phone even during a power failure.

CONNECTING AN EXTENSION PHONE

- 1** Insert the end of the extension phone cord into the extension phone jack on the left side of the machine.

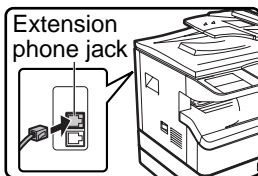

Make sure you hear a "click" sound indicating that the cord is securely connected.

CONTENTS

INTRODUCTION	1
CONNECTING AN EXTENSION PHONE.....	1
TO USE THIS PRODUCT CORRECTLY AS A FACSIMILE.....	4

1

BEFORE USING THE FAX FUNCTION

POINTS TO CHECK AND PROGRAM AFTER INSTALLATION	6
PART NAMES AND FUNCTIONS	7
● OPERATION PANEL	7
● FAX MODE (BASE SCREEN)	9
● AUDITING MODE	10
ORIGINALS.....	11
● ORIGINALS THAT CAN BE FAXED.....	11
PLACING THE ORIGINAL.....	12
● USING THE SPF/RSPF	12
● USING THE DOCUMENT GLASS.....	12
CHECKING THE SIZE OF A PLACED ORIGINAL.....	13
● MANUALLY SETTING THE SCANNING SIZE	13
SELECTING RESOLUTION AND EXPOSURE SETTINGS.....	14
CONVENIENT DIALLING METHODS (AUTO-DIALLING).....	15

2

BASIC OPERATIONS

SENDING A FAX	17
● BASIC PROCEDURE FOR SENDING FAXES.....	17
● TRANSMISSION BY AUTO-DIALLING (RAPID DIALLING AND GROUP DIALLING)	19
● SENDING A FAX BY SPEED DIALLING.....	19
● SEARCHING FOR A PROGRAMMED DESTINATION (USING THE [ADDRESS] KEY)	20
● FAXING A TWO-SIDED ORIGINAL (MX-M182D/MX-M202D/MX-M232D).....	21
● CANCELLING A FAX TRANSMISSION	25
RECEIVING FAXES.....	27
● RECEIVING A FAX.....	27
● FAX PRINT HOLD FUNCTION.....	29

3

ADVANCED TRANSMISSION METHODS

SENDING THE SAME DOCUMENT TO MULTIPLE DESTINATIONS IN A SINGLE OPERATION (BROADCAST TRANSMISSION)	31
● USING BROADCAST TRANSMISSION.....	32
AUTOMATIC TRANSMISSION AT A SPECIFIED TIME (TIMER TRANSMISSION)	33
● SETTING UP A TIMER TRANSMISSION.....	33
TRANSMISSION AND RECEPTION USING THE POLLING FUNCTION.....	35
● USING THE POLLING FUNCTION	36
● USING POLLING MEMORY	38
INCLUDING SENDER INFORMATION ON FAXES	41
FAXING A DIVIDED ORIGINAL (DUAL PAGE SCAN).....	42
ADDING A COVER SHEET/MESSAGE TO A FAX TRANSMISSION.....	43
USING SETTINGS STORED AS A PROGRAM	44
● USING A PROGRAM.....	44
FORWARDING RECEIVED DATA TO A NETWORK ADDRESS (INBOUND ROUTING SETTINGS).....	45
● CONFIGURING THE BASIC SETTINGS.....	45
● SETTINGS THE DESTINATION.....	47
FORWARDING RECEIVED FAXES TO ANOTHER MACHINE WHEN PRINTING IS NOT POSSIBLE (FORWARDING FUNCTION).....	49
● USING THE FORWARDING FUNCTION.....	49
SENDING A FAX DIRECTLY FROM A COMPUTER (PC-Fax)	50

4

TRANSMISSION USING F-CODES

COMMUNICATION BETWEEN MACHINES SUPPORTING F-CODES	52
● BOXES AND SUB-ADDRESSES/PASSCODES REQUIRED FOR F-CODE TRANSMISSION	52
● CREATING A BOX FOR F-CODE TRANSMISSION.....	53

F-CODE POLLING MEMORY..... 54

- HOW F-CODE POLLING MEMORY WORKS54
- USING F-CODE POLLING MEMORY55
- PROCEDURE FOR F-CODE POLLING57

F-CODE CONFIDENTIAL TRANSMISSION ... 59

- F-CODE TRANSMISSION (F-CODE CONFIDENTIAL TRANSMISSION)59
- PRINTING A DOCUMENT RECEIVED TO AN F-CODE CONFIDENTIAL MEMORY BOX61

F-CODE RELAY BROADCAST TRANSMISSION 62

- USING THE F-CODE RELAY BROADCAST FUNCTION (your machine is the relay machine)63
- USING THE F-CODE RELAY REQUEST FUNCTION (your machine requests a relay broadcast)63

5 CONVENIENT METHODS OF USE

CONNECTING AN EXTENSION PHONE..... 64

- USING AN EXTENSION PHONE64
- SETTING THE RECEPTION MODE65

6 PROGRAMMING

PROGRAMMING 66

STORING, EDITING, AND DELETING AUTO DIAL NUMBERS AND PROGRAMS 66

- STORING, EDITING, AND DELETING AUTO-DIAL NUMBERS (RAPID KEYS, SPEED DIAL NUMBERS, AND GROUP KEYS)66
- STORING, EDITING AND DELETING PROGRAMS76

PROGRAMMING, EDITING, AND DELETING F-CODE MEMORY BOXES 78

- PROGRAMMING AN F-CODE MEMORY BOX78

PRINTING LISTS OF PROGRAMMED INFORMATION, SETTINGS, AND COMMUNICATION ACTIVITY 85

ENTERING CHARACTERS..... 86

- CHARACTERS THAT CAN BE ENTERED86
- CHANGING TO ENTRY MODE86
- CHARACTER ENTRY KEYS87
- INITIAL PROCEDURE FOR ENTERING CHARACTERS88

7 TROUBLESHOOTING

WHEN A TRANSACTION REPORT IS PRINTED 90

- INFORMATION APPEARING IN THE TYPE/NOTE COLUMN 90

VIEWING THE COMMUNICATION ACTIVITY REPORT AT REGULAR INTERVALS (Communication activity report) 92

WHEN AN ALARM SOUNDS AND A WARNING MESSAGE IS DISPLAYED 92

- SELF-DIAGNOSTIC FUNCTION 93
- MESSAGES DURING NORMAL OPERATION..... 93

PROBLEMS AND SOLUTIONS 94

8 SYSTEM SETTINGS

- ADMINISTRATOR SETTINGS LIST 96
- ADMINISTRATOR SETTINGS MENU 97

PROCEDURE FOR USING THE SYSTEM SETTINGS 98

- INITIAL PROCEDURE 98

SYSTEM SETTINGS FOR THE FAX FUNCTION.....99

- LIST PRINT/SET 99
- INITIAL SETTING 100
- SENDING FUNCTION 105
- RCV. FUNCTION 108
- POLLING SECURITY 111

9 APPENDIX

SPECIFICATIONS 112

INDEX 113

TO USE THIS PRODUCT CORRECTLY AS A FACSIMILE

Several points must be kept in mind when using this product as a facsimile. Please note the following.

Line connection

Be sure to use the provided telephone line cord to connect the machine to a telephone line jack. Insert one end of the telephone line cord into the LINE jack on the left side of the machine as shown. Insert the other end of the telephone line cord into a telephone line jack.

Insert the plug firmly until you hear a "click".

LINE jack

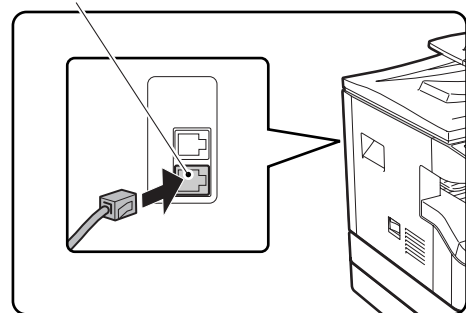

In some countries, an adapter is required to connect the telephone line cable to the wall telephone socket, as shown in the illustration.

For United Kingdom

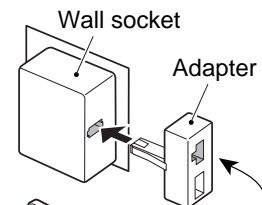

For Australia

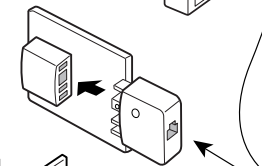

For New Zealand

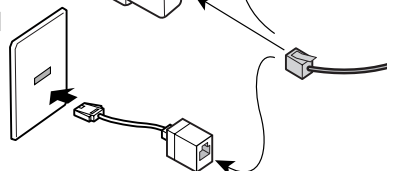

Power switch

Keep the machine power switch turned on at all times. Do not turn off the power. If the power is turned off, the fax function cannot be used.

When the power is off, the machine cannot receive faxes. Before turning off the power, make sure the machine is idle. If the power is turned off while the machine is in operation, a paper jam may occur. If settings are being configured, the settings will be cancelled.

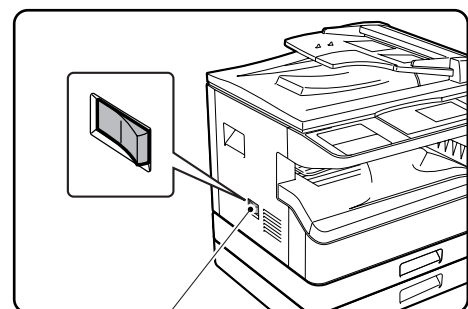

Power switch

Setting the date and time and programming your sender's name and number

Before using the fax function, you must set the date and time and program your sender's name and number in the machine. This procedure is explained in "POINTS TO CHECK AND PROGRAM AFTER INSTALLATION" on page 6 of this manual.

Lithium battery

A lithium battery in the machine is used to retain settings and programmed information such as auto-dial numbers (page 66).

- When the battery dies, settings and programmed information will be lost, so please keep a record of this information. (See "PRINTING LISTS OF PROGRAMMED INFORMATION, SETTINGS, AND COMMUNICATION ACTIVITY" on page 85.)
- The life of the battery is approximately 5 years when the power switch is kept continuously off.
- When the battery dies, please contact your local Sharp dealer or authorised service representative for assistance in disposing of this battery. The machine will not operate once the battery dies.

Please note

In the event of a thunderstorm, remove the power cord from the power outlet to ensure safety. Information will be retained in memory even if the power cord is unplugged.

1

BEFORE USING THE FAX FUNCTION

This chapter contains basic information about using the fax function of the machine. Please read this chapter before using the fax function.

POINTS TO CHECK AND PROGRAM AFTER INSTALLATION

After installing the machine and before using it as a fax machine, check the following points and program the required information.

Set the date and time

The machine has an internal clock. It is important to set the correct date and time because they are used for such features as Timer Transmission (page 33).

The date and time are set in the system settings. (Page 104)

The date and time appear in the display. Make sure the correct date and time appear. If the date and time are wrong, please correct them.

Program the sender's name and sender's number

The name and fax number of the user of the machine is programmed in "OWN PASSCODE SET" (page 101) in the system settings. (Only one name and number can be programmed.)

The programmed name and number are printed at the top of each transmitted fax page. The sender's number is also used as an identification number when you use the Polling function to request transmission from another fax machine (see "USING THE POLLING FUNCTION" on page 36).



You can check your programmed name and number by printing out the "Administrator Settings List" in the system settings. (See "LIST PRINT" on page 99.)

Paper sizes that can be used for fax mode

The machine can use A3, B4, A4, A4R, B5, B5R, A5, 11" x 17", 8-1/2" x 14", 8-1/2" x 11", 8-1/2" x 11"R, and 5-1/2" x 8-1/2"* size paper; however, 11" x 17", 8-1/2" x 14" and 5-1/2" x 8-1/2" size paper cannot be used in fax mode. (Among INCH sizes, only 8-1/2" x 11" and 8-1/2" x 11"R can be used.) (If your machine uses inch-based paper sizes, A3, B4, B5, B5R, and A5 size paper cannot be used in fax mode. (Among AB sizes, only A4 and A4R can be used.)) For this reason, if only paper sizes that can be used in other modes but not in fax mode are loaded in the machine, received faxes cannot be printed. (For other points regarding fax reception, see "RECEIVING FAXES" page 27.)

* A5 (5-1/2" x 8-1/2") size paper can only be loaded in tray 1, regardless of the mode. A5 (5-1/2" x 8-1/2") paper cannot be loaded in tray 2 or in the optional 250-sheet paper feed unit or 2 x 250-sheet paper feed unit.



For the procedures for loading paper in the trays, see the Operation Guide for the machine.

PART NAMES AND FUNCTIONS

OPERATION PANEL

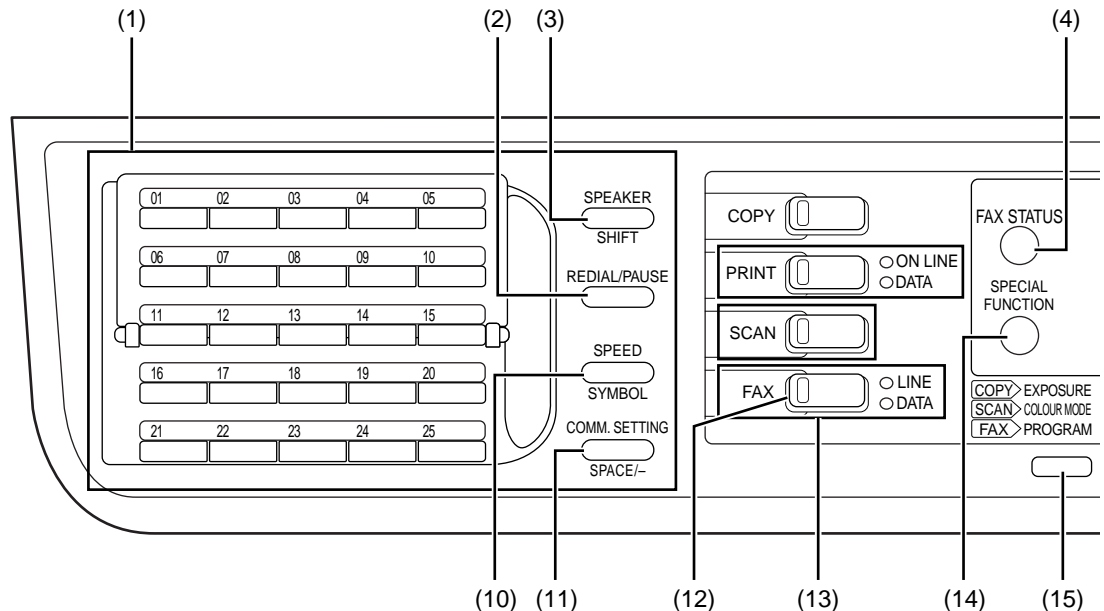

- (1) **Page pallet (page 86)**
- (2) **[REDIAL/PAUSE] key (pages 15)**
This is used to redial the last number dialled, and enter a pause when entering a fax number.
- (3) **[SPEAKER/SHIFT] key (pages 15, 86)**
This is used to dial without lifting an extension phone connected to the machine and to shift between upper and lower case when entering characters.
- (4) **[FAX STATUS] key (page 25)**
This is used to cancel a fax transmission or a stored fax transmission.
- (5) **Display (page 9)**
This key displays the base screen and the function setting screen.
- (6) **[BACK] key**
In a setting or programming screen, this key is used to move back to the previous screen.
- (7) **[OK] key**
This key is used to enter a setting that has been selected with the arrow or other keys (▼▲◀▶).
- (8) **Numeric keys**
These are used to enter fax numbers, sub-addresses, passcodes, and numerical settings. (See "BOXES AND SUB-ADDRESSES/PASSCODES REQUIRED FOR F-CODE TRANSMISSION" on page 52.)
- (9) **[C] key**
This is used to clear a mistake when entering fax numbers, sub-addresses, passcodes, and numerical settings. One digit is cleared each time the key is pressed.
When an original is being scanned, this key can also be used to cancel scanning.
- (10) **[SPEED/SYMBOL] key (pages 15, 88)**
This is used to dial by Speed dialling and to enter a symbol when entering characters.
- (11) **[COMM. SETTING/SPACE/-] key (page 22)**
This is used to switch between memory transmission and direct transmission, and to switch between automatic reception and manual reception. It is also used to enter a space or "-" when entering characters.
- (12) **[FAX] key/FAX indicator/LINE indicator/DATA indicator**
Press to switch to fax mode. The base screen of fax mode will appear in the display.
The LINE indicator lights up during transmission or reception of a fax. When a fax has been received, the DATA indicator blinks. (When there is fax transmission data in memory, the DATA indicator lights up.)

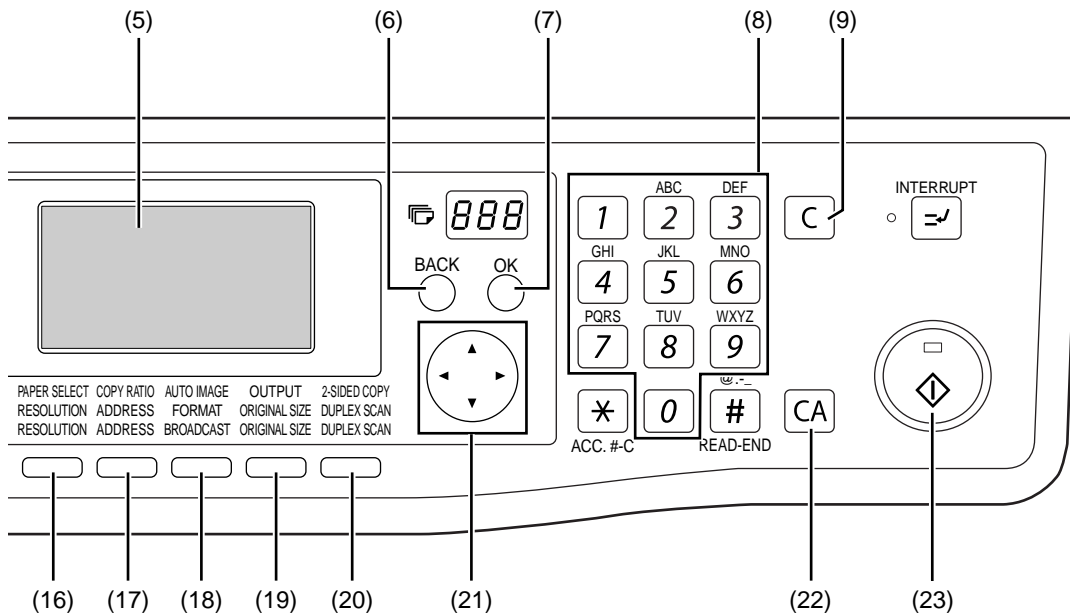

(13) [MODE SELECT] keys (step 1 on page 17)

These are used these keys to change modes.

(14) [SPECIAL FUNCTION] key

This key is used to select a special transmission or reception function, configure function settings, and to store auto-dial numbers.

(15) [PROGRAM] key (page 44)

Press this key to use a program.

(16) [RESOLUTION] key (page 14)

This key is used to select resolution and exposure settings.

(17) [ADDRESS] key (page 20)

This key is used to search for a fax destination that has been stored as an auto-dial number in the address book.

(18) [BROADCAST] key (page 31)

This is used to perform a broadcast transmission.

(19) [ORIGINAL SIZE] key (page 13)

This is used to set the size of the original to be faxed.

(20) [DUPLEX SCAN] key (page 21)

Press this key to use the duplex scan function. (Only on models with a RSPF installed.)

(21) Arrow keys (▼ ▲ ◀ ▶)

These are used to select items and move through pages.

(22) [CA] key

This is used to cancel a transmission or programming operation. When pressed during an operation, the operation is cancelled and the display returns to the base screen described on page 9.

This key is also used to cancel a resolution, paper size, or special function setting that was selected when sending a fax.

(23) [START] key (Ⓢ)

This is used at the following times:

- (1) When starting transmission
- (2) When scanning an original
- (3) When starting manual reception
- (4) When configuring and storing settings



- When the auto power shut-off function is activated, all indicators except the [START] key indicator go off. For the information on the auto power shut-off function, see the Operation Guide for the machine.
- For information on the keys and lights which are used for the copy function and other functions, see "Operation Panel" in the manual for each function.

FAX MODE (BASE SCREEN)

The base screen of fax mode is displayed by pressing the [FAX] key when the print mode, copy mode, or scan mode screen appears.

The base screen of fax mode



(1) Message display

Messages appear here to indicate the current status of the machine.

An icon (E[Ⓜ]) appears to the right side when a confidential fax has been received.

(2) Date and time display

This shows the date and time.

(3) Transmission mode display (page 22)

There are three transmission modes: memory transmission, direct transmission, and manual transmission. This shows the currently selected transmission mode.

(4) Exposure display (page 14)

This shows the exposure for scanning the original that has been selected with the [RESOLUTION] key.

(5) Resolution display (page 14)

This shows the resolution for scanning the original that has been selected with the [RESOLUTION] key.

(6) Free memory display

This shows the percentage of fax memory that is free.

(7) Reception mode display (page 65)

There are two modes for receiving faxes: automatic reception and manual reception. This shows the currently selected reception mode.

(8) Original display (page 13)

This displays an icon to indicate the original scanning mode when an original has been placed.

 : One-sided original scanning in the SPF.

 : Document glass

 : Two-sided original scanning in the RSPF.

This also shows the size of the placed original.



The following functions operate even when copy mode is selected:

- Automatic reception (including F-code confidential reception)
- Timer Transmission
- Memory polled function
- Transmission of stored memory transmission jobs
- Voice calls (voice calls can be answered but not placed).
- Remote reception
- Manual reception
- Relay station function for F-code relay broadcast transmission

AUDITING MODE

Accounts that can transmit faxes (up to 50) can be established and transmission time and other information can be tracked for each account. The Acc. Usage List (page 99) can be printed out which shows the time used for transmission and pages transmitted by each account.

- This function is enabled using "ACCOUNT CONTROL" and "ACCOUNT # SET" in the system settings. (Page 103)

Using auditing mode

When auditing mode is turned on, the account number entry screen is displayed. Enter your account number (five-digit identification number) as explained below before performing a fax operation.

Enter your account number.
ACCOUNT #: -----

1 Enter your account number (five digits) with the numeric keys.

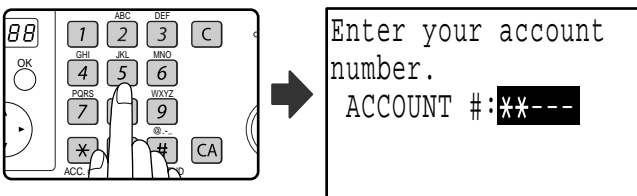

2 When you have completed the fax operation, press the [ACC.#-C] key (*).

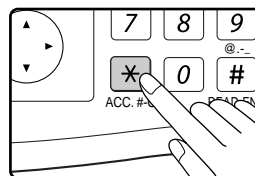

- As the account number is entered, the hyphens "-" change to asterisks "*". If you enter an incorrect digit, press the [C] key and re-enter the correct digit.
- After you enter your account number, the base screen of fax mode appears. (Page 9)

Note

- If you enter an account number for copy mode has also been programmed for fax mode, you can change to fax mode after completing the copy operation and continue with the fax operation without re-entering your account number. If you enter an account number for copy mode that has not been programmed for fax mode, enter your account number for fax mode after you press the [FAX] key to change to fax mode.
- When "ACC. # SECURITY" in the system settings (see the "System settings guide" in the Operation Guide for the machine.) is enabled, the message "Please see your administrator for assistance." will appear for one minute in the event that you enter an incorrect or invalid account number three times in a row. During that time operation of the machine will not be possible.

ORIGINALS

ORIGINALS THAT CAN BE FAXED

Original sizes

	Minimum original size	Maximum original size
Using the SPF/RSPF	A5: 210 mm (width) x 148 mm (length) (8-1/2" (width) x 5-1/2" (length)) A5R: 148 mm (width) x 210 mm (length) (5-1/2" (width) x 8-1/2" (length))	297 mm (width) x 800 mm* (length) (11" (width) x 31-1/2"* (length)) * Long documents can be transmitted
Using the document glass		297 mm (width) x 432 mm (length) (11" (width) x 17" (length))

1



- Originals that are not a standard size (A5, A4, A4R, B4, A3, 8-1/2" x 11", 8-1/2" x 11"R (5-1/2" x 8-1/2", 5-1/2" x 8-1/2"R, 8-1/2" x 11", 8-1/2" x 11"R, 8-1/2" x 14", 11" x 17", A4, A4R if the machine uses inch-based paper sizes)) can also be faxed.
- There are restrictions on originals that can be scanned using the SPF/RSPF. For more information, see "NORMAL COPYING" in the Operation Guide for the machine.

* Long originals

Depending on the resolution setting and the width of the original, there may not be sufficient space in memory to hold a long original. When a long original cannot be entirely scanned, select a lower resolution setting and/or shorten the original.

Scanning area of original

When faxing an original, note that the edges of the original cannot be scanned.

Width of edges that cannot be scanned:
5 mm from top and bottom edges, 6 mm (or less) from left and right edges

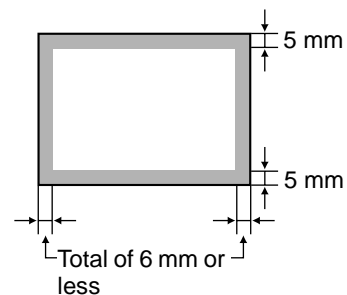

Automatic reduction of faxed document

If the size (width) of the faxed document is greater than the receiving machine's paper size, the size will be automatically reduced.

Faxed document width	Receiving machine's paper width	Size after reduction	Ratio
A3 (11" x 17")	B4 (8-1/2" x 14")	B4 (8-1/2" x 14")	1 : 0.78 (1 : 0.64)
A3 (11" x 17")	A4 (8-1/2" x 11")	A4R (8-1/2" x 11"R)	1 : 0.5 (1 : 0.5)
B4 (8-1/2" x 14")	A4 (8-1/2" x 11")	A4R (8-1/2" x 11"R)	1 : 0.64 (1 : 0.78)

You can turn off automatic reduction. In this case, the left and right edges will not be transmitted. (See "AUTO REDUCE TX" on page 105.)

PLACING THE ORIGINAL

An original can be placed in the SPF/RSPF or on the document glass. Use the SPF/RSPF when faxing a large number of sheet originals. Use the document glass to fax originals that cannot be scanned using the SPF/RSPF such as thick or thin sheet originals, or books or other bound originals.

USING THE SPF/RSPF

- 1 Open the SPF/RSPF, make sure that an original has not been left on the document glass, and then gently close the SPF/RSPF.

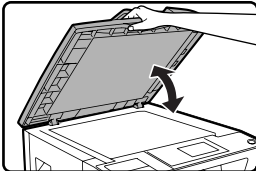

- 2 Adjust the original guides on the document feeder tray to the width of the document.

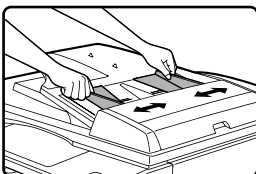

- 3 Align the edges of the document pages and then insert the stack in the document feeder tray so that the first page is face up.

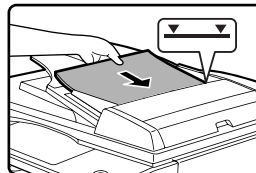

- Insert the originals all the way into the document feeder tray.
- Make sure the stack does not exceed the indicator line (maximum of 40 sheets, or 30 sheets of 90 g/m² (24 lbs.) paper, thickness 4 mm (5/32") or less).



- Do not load originals that are different sizes even if the widths are the same. This may cause misfeeds.
- Use the SPF/RSPF for long originals. The document glass cannot be used.
- When inserting a long original, the original should be in contact with the surface of the document feeder tray. If the original is not in contact with the surface of the document feeder tray, an incorrect original size may be detected.

USING THE DOCUMENT GLASS

- 1 Open the SPF/RSPF, place the original face down on the document glass, and then gently close the SPF/RSPF.

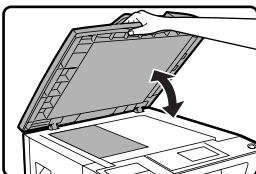

- If auto power shut-off has activated, press the [START] key, wait until the machine has returned to normal operation, and then place the original.
- When transmitting a small original such as a postcard, be sure to press the [ORIGINAL SIZE] key and set the original size. (Page 13)

Regardless of the size of the original, place the original in the far left corner of the document glass. (Align the upper left-hand corner of the original with the tip of the ▲ mark.) Place the original in the appropriate position for its size as shown below.

Document glass scale

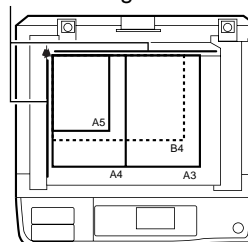

Document glass scale

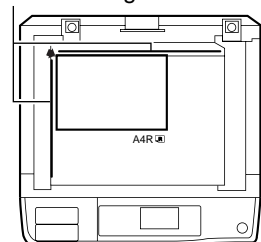

The difference between A4 (8-1/2" x 11") and A4R (8-1/2" x 11"R)

This manual uses both A4 (8-1/2" x 11") and A4R (8-1/2" x 11"R) to indicate paper and original sizes. The "R" is used to distinguish the orientation of originals and paper. ("R" is used for this purpose for other sizes as well.)

[Example] Difference between the orientations of A4 (8-1/2" x 11") size and A4R (8-1/2" x 11"R) size

A4 (8-1/2" x 11") indicates an original placed as follows:

Vertically oriented

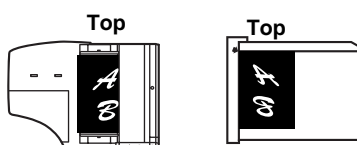

Document feeder tray

Document glass

A4R (8-1/2" x 11"R) indicates an original placed as follows:

Horizontally oriented

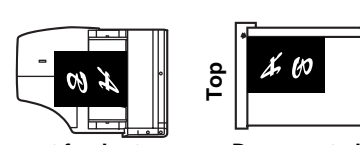



Document feeder tray

Document glass

CHECKING THE SIZE OF A PLACED ORIGINAL

When a standard-size* original is placed, the original size is automatically detected (automatic original detection function) and displayed in the original display. Make sure that the size has been detected correctly.

(1) When an original is placed, an icon appears to indicate the original scanning mode.

-  : One-sided scanning in the SPF.
-  : Scanning on the document glass
-  : Two-sided scanning in the RSPF.

(2) Displays the original size.

If a non-standard size original is placed or if you wish to change the scanning size, follow the steps below to manually set the original scanning size.

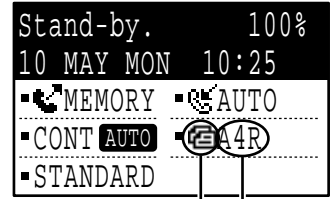

(1) (2)



*Standard sizes

The following sizes are standard sizes: A3, B4, A4, A4R, A5 (11" x 17", 8-1/2" x 14", 8-1/2" x 11", 8-1/2" x 11"R, 5-1/2" x 8-1/2", if the machine uses inch-based paper sizes). If a non-standard size original is loaded (including special sizes), the closest standard size may be displayed, or the original size may not appear at all. In Taiwan, the following standard original sizes are detected by the automatic original detection function: A3, B4, A4, A4R, B5, B5R, A5.

1

MANUALLY SETTING THE SCANNING SIZE

If you load an original that is not a standard size (such as a long original), or if the size is not detected correctly, be sure to press the [ORIGINAL SIZE] key and set the original size manually.

Perform the following steps after placing the original in the document feeder tray or on the document glass (page 12).



If a size is specified that is different from the actual original size when scanning a two-sided original in the RSPF, a scanning error or a cut-off image may result.

1 Press the [ORIGINAL SIZE] key.

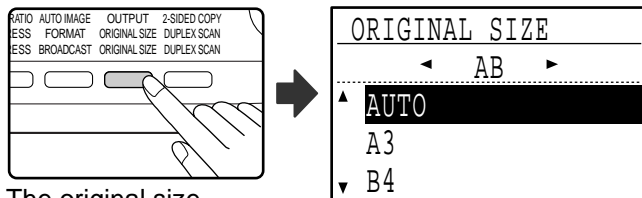

The original size selection screen appears.

2 Select the original size with the [▼] or [▲] key.

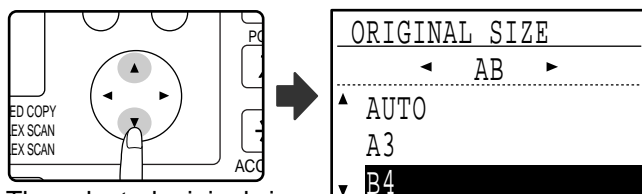

The selected original size is highlighted.

To select an INCH size, press the [▶] key and go to step 4.

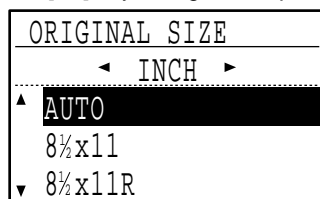
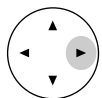

When the [▶] key is pressed, the original size selection screen for INCH sizes appears.

3 Press the [OK] key.

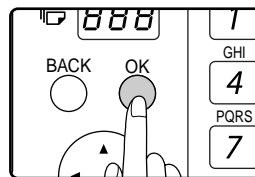

You will return to the base screen and the selected original size will appear in the original display.

Selecting an INCH original size

4 Select the original size with the [▼] or [▲] key.

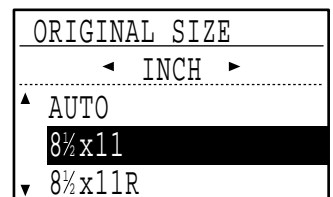

To return to selection of AB original sizes, press the [◀] key and return to step 2.

5 Press the [OK] key.



You will return to the base screen and the selected original size will appear in the original display.



To cancel a manual original scanning size setting, press the [CA] key. If it is not possible to select the actual original size, select a size that is larger than the actual original size. If a smaller size is selected, part of the original will not be transmitted.

SELECTING RESOLUTION AND EXPOSURE SETTINGS

The resolution and exposure can be adjusted to match the size and darkness of text on the original, or for an original such as a photograph. To change the settings, follow the steps below after selecting fax mode and placing the original. (Page 12)

1 Press the [RESOLUTION] key.

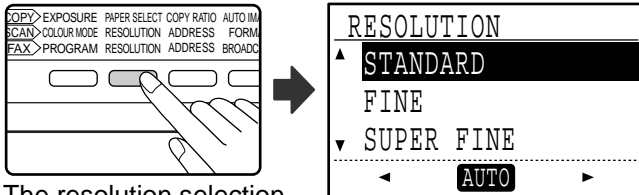

The resolution selection screen will appear.

2 Select the resolution with the [▼] or [▲] key.

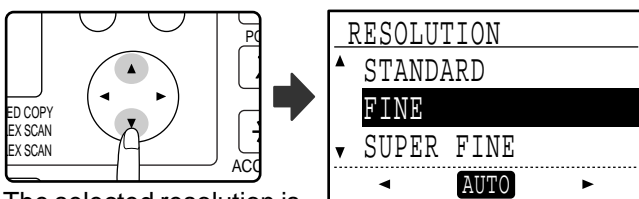

The selected resolution is highlighted.

STANDARD	Use this setting for originals with normal-size text.
FINE	Use this setting for originals with small letters or detailed drawings. The original will be scanned at twice the resolution of Standard.
SUPER FINE	Use this setting for originals with intricate drawings or diagrams. A higher-quality image will be produced than with the Fine setting.
ULTRA FINE	Use this setting for originals with intricate drawings or diagrams. This setting gives the best image quality. However, transmission will take longer than with the other settings.

(FINE/HALF TONE) (S-FINE/HALF TONE) (U-FINE/HALF TONE)	Use halftone if your original is a photograph or has gradations of colour (such as a colour original). This setting will produce a clearer image than "FINE", "SUPER FINE", or "ULTRA FINE" used alone. When halftone is selected, transmission will take longer.
---	---

To set the exposure next, press the [◀] or [▶] key and go to step 4.

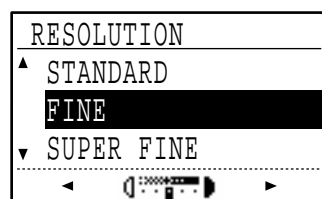
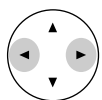

When the [◀] or [▶] key is pressed, the exposure display changes from "AUTO" to a 5-step display.

3 Press the [OK] key.

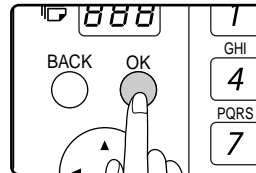

You will return to the base screen and the selected resolution will appear in the resolution display.

4 Select the desired exposure with the [◀] or [▶] key.

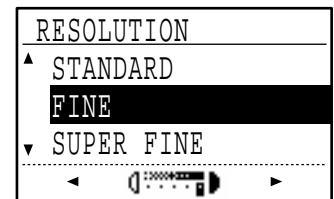
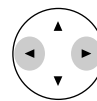

- To select a light setting for a dark original such as a newspaper, press the [◀] key to move the setting toward (1).
- To select a dark setting for a light original such as writing in pencil or faint colour text, press the [▶] key to move the setting toward (5).
- When the exposure setting reaches the left side or the right side, pressing the [◀] or [▶] key changes the exposure display from the 5-step display to "AUTO".

5 Press the [OK] key.



You will return to the base screen and the selected exposure will appear in the exposure display.



- The default resolution setting is "STANDARD" and the default exposure setting is "AUTO". The default settings for the resolution and exposure can be changed in the system settings. (See "RES. CON. SET" on page 105.) When using the document glass to scan multiple original pages, the exposure setting can be changed each time you change pages. When using the SPF/RSPF, the resolution and exposure settings cannot be changed once scanning has begun.
- Even if you send a fax using a high resolution setting such as "FINE", "SUPER FINE", or "ULTRA FINE", some receiving fax machines may print the fax at a lower resolution.
- To cancel a resolution or exposure selection, press the [CA] key.

CONVENIENT DIALLING METHODS (AUTO-DIALLING)

The fax function includes a convenient auto dial feature (Rapid dialling, speed dialling and group dialling). By programming frequently dialled numbers, you can call and send faxes to these locations by means of a simple dialling operation (page 19). There are three types of auto-dialling: Rapid dialling, speed dialling, and group dialling. To program auto-dial numbers, see page 66.

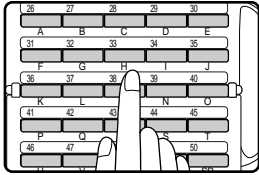
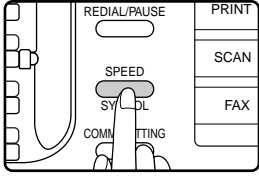
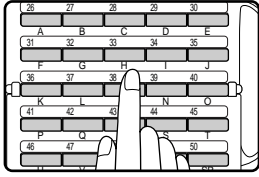
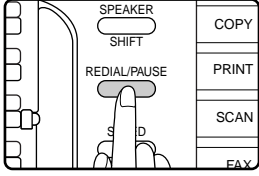
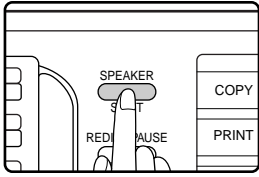
<ul style="list-style-type: none"> Rapid dialling A stored destination can be dialled by simply pressing a Rapid key ([01] to [50]). A name up to 36 characters in length can be programmed for the location (a maximum of 12 characters are displayed). When using F-code transmission, a sub-address and passcode (page 52) can also be programmed. 	 <p>The programmed user names appear.</p>
<ul style="list-style-type: none"> Speed dialling (300 stations) A stored destination can be dialled by pressing the [SPEED] key, entering a 3-digit number (000 to 299), and pressing the [START] key (⊙). A name (maximum 36 characters) can be stored for each destination. When using F-code transmission, a sub-address and passcode (page 52) can also be programmed. 	 <p>The Speed number entry screen appears.</p>
<ul style="list-style-type: none"> Group dialling Multiple Rapid dial and/or Speed dial destinations can be stored in a Rapid key for Group dialling. Destinations can also be stored for Group dialling by entering fax numbers with the numeric keys. This is convenient for communicating with a group of other fax machines. 	 <p>The programmed group names appear.</p>
<ul style="list-style-type: none"> REDIALLING The machine retains the last fax or phone number dialled. This number can be redialled by simply pressing the [REDIAL] key and then the [START] key (⊙). <ul style="list-style-type: none"> If you pressed a numeric key during the previous call, the [REDIAL] key may not dial the correct number. Redialling is not possible to broadcast transmission (page 31), serial polling (page 37), timer transmission (page 33), group dialling (page 19), or F-code transmission (page 59) destinations. 	 <p>The last number dialled is displayed.</p>
<ul style="list-style-type: none"> ON-HOOK DIALLING This feature allows you to dial without lifting an extension phone connected to the machine. Press the [SPEAKER] key, listen for the dial tone through the speaker, and then dial. <ul style="list-style-type: none"> If a person answers, lift the extension phone to answer. (You can only speak to the other party if an extension phone is connected to the machine.) Faxes must be sent manually when using on-hook dialling. (Page 23) On-hook dialling is not possible using a Rapid key that includes a sub-address and passcode, or a group dial key. 	



- A combined total of 50 Rapid dial and group dial keys can be stored, and 300 speed dial destinations can be stored.
- Stored Rapid keys, group keys, and Speed dial destinations can be called up using a search name entered when the key or destination was stored. (Page 20)
- To prevent dialling a wrong number and sending a fax to an incorrect destination, check the message display carefully when you store the number. You can also check stored numbers by printing out the programmed information after storing the number (page 85).

2

BASIC OPERATIONS

This chapter explains the basic procedures for sending and receiving faxes.

There are three basic methods for fax transmission: memory transmission, direct transmission, and manual transmission. When memory transmission is used, the document is temporarily stored in memory before being transmitted. When direct transmission or manual transmission is used, the document is transmitted without being stored in memory. The default transmission setting can be set to "MEMORY TX" or "DIRECT TX" using "SEND MODE" (page 106) in the system settings. To manually switch between "MEMORY TX" and "DIRECT TX", use the [COMM. SETTING] key. (See "Faxing by direct transmission" on page 22.)

The following explanations generally assume that memory transmission is being used.

SENDING A FAX

BASIC PROCEDURE FOR SENDING FAXES

1 Make sure that the machine is in fax mode.

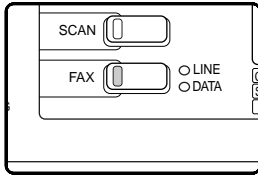

The FAX indicator is lit when the machine is in fax mode. If the indicator is not lit, press the [FAX] key. If auditing mode has been enabled for the fax function in the system settings, a

message will appear prompting you to enter your account number when you switch to fax mode. Enter your account number (5 digits) with the numeric keys. (See "ACCOUNT CONTROL" on page 103.)

2 Place the original(s) in the document feeder tray or on the document glass.

- Using the SPF/RSPF: page 12
- Using the document glass: page 12

If you are using the document glass to send multiple pages, place the first page first.



You cannot place originals both in the SPF/RSPF and on the document glass and send them in a single fax transmission.

3 Check the original size. If the original is not a standard size or the size was not detected correctly, press the [ORIGINAL SIZE] key.

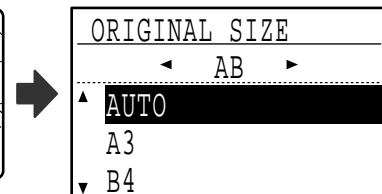
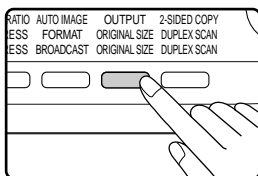

When the [ORIGINAL SIZE] key is pressed, the size selection screen appears. See "MANUALLY SETTING THE SCANNING SIZE" (page 13) to set the original size.

4 If needed, adjust the resolution and exposure settings. (Page 14)

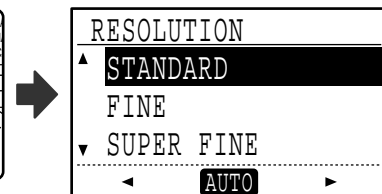
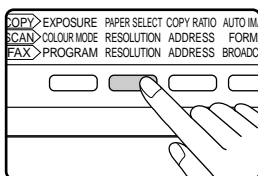

To adjust the resolution and exposure settings, press the [RESOLUTION] key. (See "SELECTING RESOLUTION AND EXPOSURE SETTINGS" on page 14.)

5 Dial the fax number.

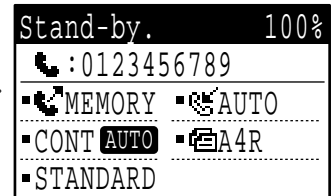
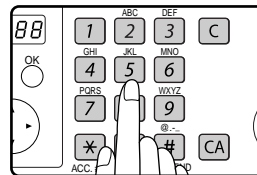

- The entered number appears in the message display. Up to 50 digits can be entered. If you make a mistake, press the [C] key and then enter the correct number.
- Redialling and automatic dialling can also be used (pages 15, 19).

Entering a pause

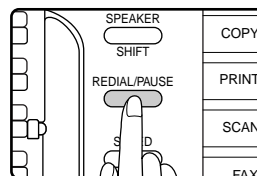

If a pause is necessary when dialling out from a PBX or when dialling an international number, press the [REDIAL] key. (This key functions as a pause key when entering a number.)

If you press the [PAUSE] key once, a hyphen ("-") appears and a 2-second pause* is inserted. After entering a number, you can also press the [PAUSE] key to enter a hyphen and then enter another number using the numeric keys or a Rapid key. (This connects the numbers together, and is called Chain dialling.)

* The duration of each pause can be changed in the system settings. (See "PAUSE TIME" on page 100.)



Group keys cannot be used for chain dialling.

2

Using the SPF/RSPF

6 Press the [START] key (Ⓢ).

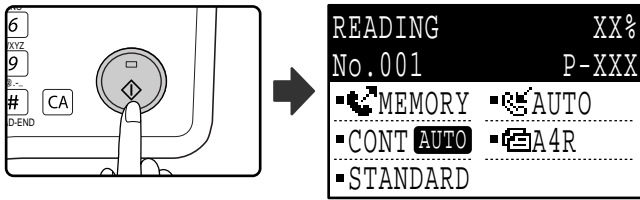

- Scanning begins.
- If the line is free, the machine will dial the receiving machine and begin transmission as soon as the first page is scanned. (Quick online transmission: page 24)
- If there is a previously stored job or a job is in progress, or if the line is being used, all pages of the original are scanned into memory and stored as a transmission job. (This is called memory transmission: the destination is automatically called and the document transmitted after previously stored jobs are completed.)

If scanning is completed normally, the following screen is appears briefly and then the display returns to the base screen.

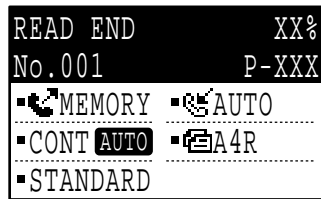

Using the document glass

6 Press the [START] key (Ⓢ).

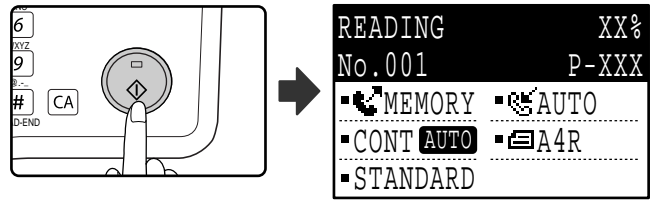

Scanning begins.

7 If you have another page to scan, change pages and then press the [START] key (Ⓢ).

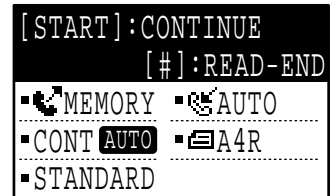

- Repeat this sequence until all pages have been scanned.
- You can change the resolution and exposure settings as needed for each. (page 14)
- If no action is taken for one minute (the [START] key (Ⓢ) is not pressed), scanning automatically ends and the transmission job is stored. (This function can be disabled in the system settings.)

8 After the last page is scanned, press the [READ-END] key (#).

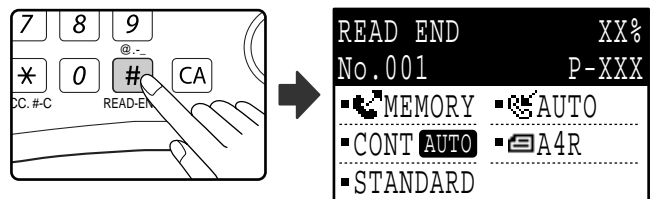

Open the SPF/RSPF and remove the original. When the original is removed or any key operation is performed, the display returns to the base screen. (The destination is automatically called and the document transmitted after any previously stored jobs are completed.)



To cancel transmission

- To cancel transmission while "READING" appears or before the [#] key is pressed, press the [C] or [CA] key. To cancel a transmission job that is already stored, press the [FAX STATUS] key and cancel the job as explained on page 25.
- A job number (3 digits) appears in the display with "READ END" when memory transmission is performed. If you make a note of this number after performing a broadcast transmission, you can use the number to check the results of the transmission in the transaction report or activity report.
- If the power is turned off or a power failure occurs while an original is being scanned in the SPF/RSPF, the machine will stop and an original misfeed will occur. After power is restored, remove the original as explained in "MISFEED IN THE SPF/RSPF" in the Operation Guide for the machine.

TRANSMISSION BY AUTO-DIALLING (RAPID DIALLING AND GROUP DIALLING)

Fax numbers can be dialled by automatic dialling (Rapid dialling and group dialling) instead of pressing the numeric keys. Follow the steps below to send a fax using an auto dial number. To use an auto dial number, the name and fax number of the destination must first be stored. See page 15 for information on auto-dialling and page 66 for information on programming auto-dial destinations.

- 1 Perform steps 1 to 4 of "BASIC PROCEDURE FOR SENDING FAXES" (page 17).**

- 2 Press the Rapid key or group key for the desired destination.**

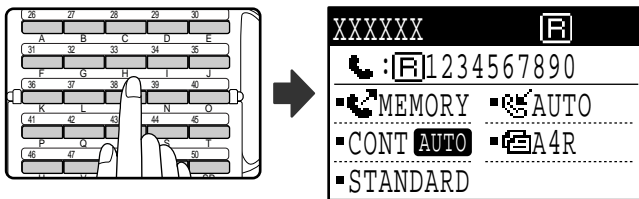

The name programmed for the destination can be displayed by pressing the Rapid key.

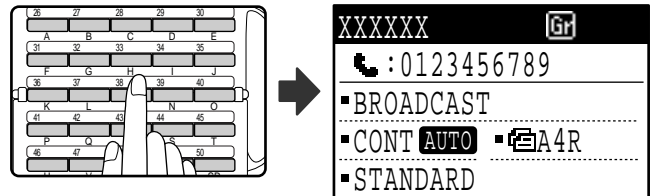

The name programmed for the group can be displayed by pressing the group key.

- 3 Continue from step 6 of "BASIC PROCEDURE FOR SENDING FAXES" (page 18).**

If an original has been placed, scanning of the original will begin automatically without the need to press the [START] key in step 6 on page 18.

SENDING A FAX BY SPEED DIALLING

In addition to Rapid dialling and group dialling, you can also send a fax by pressing the [SPEED] key and entering a 3-digit Speed Dial number. Follow the steps below to send a fax by Speed Dialling. The 3-digit Speed Dial number is entered with the numeric keys when programmed. (See "STORING, EDITING, AND DELETING AUTO DIAL NUMBERS AND PROGRAMS" on page 66.)

- 1 Perform steps 1 to 4 of "BASIC PROCEDURE FOR SENDING FAXES" (page 17).**

- 2 Press the [SPEED] key.**

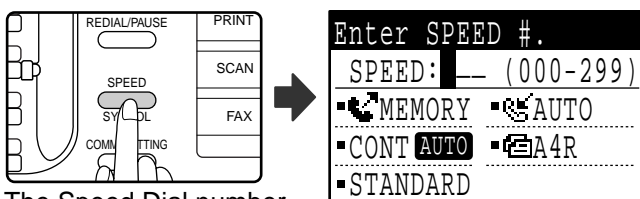

The Speed Dial number entry screen appears.

- 3 Enter the 3-digit Speed Dial number with numeric keys.**

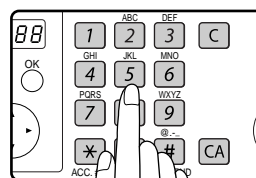

• Enter the 3-digit Speed Dial number entered when the Speed Dial number was programmed. (See step 7 of "Storing Rapid keys and Speed Dial numbers" on page 67.)

- If you make a mistake, press the [C] key and then enter the correct number. If you enter a 3-digit number that is not programmed in the machine, press the [C] key and then enter the correct number. If you do not know the Speed Dial number, print out the "SPEED # LIST". (See "PRINTING LISTS OF PROGRAMMED INFORMATION, SETTINGS, AND COMMUNICATION ACTIVITY" on page 85.)

- 4 Continue from step 6 of "BASIC PROCEDURE FOR SENDING FAXES" (page 18).**



To cancel transmission

- To cancel transmission while "READING" appears or before the [#] key is pressed, press the [C] or [CA] key. To cancel a transmission job that is already stored, press the [FAX STATUS] key and cancel the job as explained on (page 25).
- A job number (3 digits) appears in the display with "READ END" when transmission is performed. If you make a note of this number after performing a broadcast transmission, you can use the number to check the results of the transmission in the transaction report or activity report.

SEARCHING FOR A PROGRAMMED DESTINATION (USING THE [ADDRESS] KEY)

At the time of dialling, you can enter letters to search for a destination stored in a Rapid key, Speed Dial number, or Group key.

1 Perform steps 1 to 4 of "BASIC PROCEDURE FOR SENDING FAXES" (page 17).

2 Press the [ADDRESS] key.

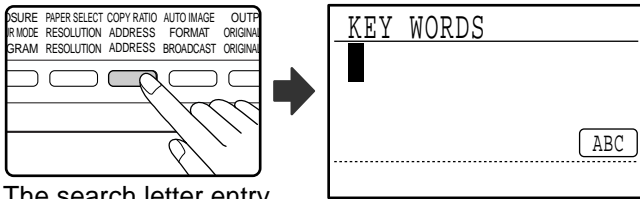

The search letter entry screen appears.

3 Enter the search letters with the letter entry keys (page palette) (you can also skip entry of search letters and go directly to the next step to display the first destination in the address list).

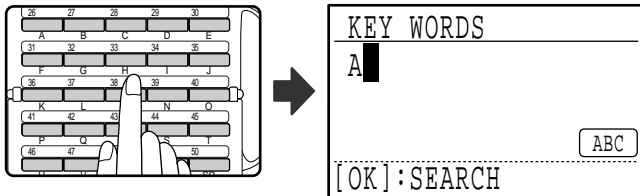

Up to 10 of the following types of characters can be entered.

Upper case letters, lower case letters, numbers, special characters (See "ENTERING CHARACTERS" on page 86.)

Enter numbers with the numeric keys.

4 Press the [OK] key.

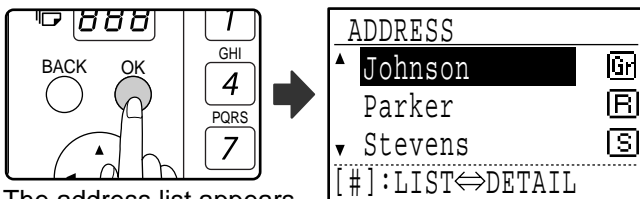

The address list appears.

5 Select the desired destination with the [▼] or [▲] key.

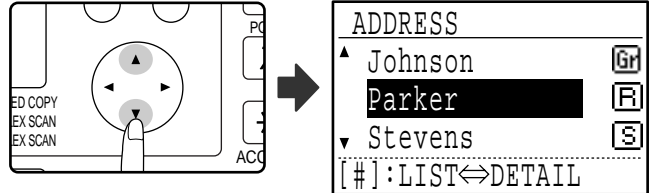

- The search results appear in the following order: upper case letters, lower case letters, special characters, and numbers.
- If not all letters of the destination name appear, press the [#] key to display the full name. Press the [#] key once again to return to the original screen.

6 Press the [OK] key.



The selected destination is entered.

7 Continue from step 6 of "BASIC PROCEDURE FOR SENDING FAXES" (page 18).



- **To cancel transmission**
To cancel transmission while "READING" appears or before the [#] key is pressed, press the [C] or [CA] key. To cancel a transmission job that is already stored, press the [FAX STATUS] key and cancel the job as explained on page 25.
- A job number (3 digits) appears in the display with "READ END" when transmission is performed. If you make a note of this number after performing a broadcast transmission, you can use the number to check the results of the transmission in the transaction report or activity report.

FAXING A TWO-SIDED ORIGINAL (MX-M182D/MX-M202D/MX-M232D)

Follow the steps below to automatically transmit both sides of a two-sided original. (This is only possible on models that have an RSPF installed.)



Do not use an original that is not a standard size (A3, B4, A4, A4R, A5, 8-1/2" x 11", 8-1/2" x 11"R (11" x 17", 8-1/2" x 14", 8-1/2" x 11", 8-1/2" x 11"R, A4, A4R if the machine uses inch-based paper sizes)). Otherwise a scanning error or cut-off image may result.

1 Make sure that the machine is in fax mode.

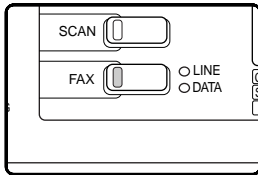

When the machine is in fax mode, the [FAX] key indicator is lit. If the indicator is not on, press the [FAX] key. If auditing mode has been enabled for the fax function in the system settings, a message will appear prompting

you to enter your account number when you switch to fax mode. Enter your account number (five digits) with the numeric keys. (See "ACCOUNT CONTROL" on page 103.)

2 Place the original(s) in the document feeder tray. (See "USING THE SPF/RSPF" on page 12.)

3 Check the original size.

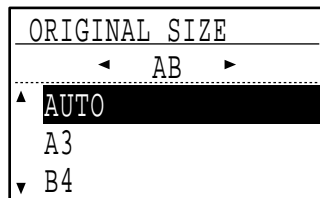
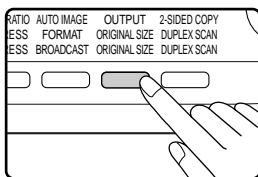

When the [ORIGINAL SIZE] key is pressed, the size selection screen appears. If the original size was not correctly detected, see "MANUALLY SETTING THE SCANNING SIZE" (page 13) and set the correct original size.

4 Press the [DUPLEX SCAN] key.

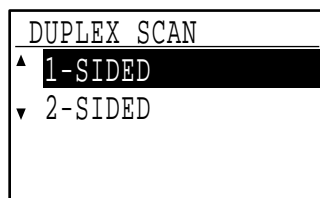
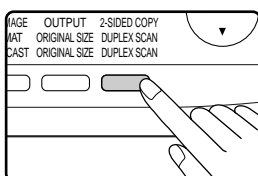

The duplex mode selection screen appears.

5 Select "2-SIDED" with the [▼] or [▲] key.

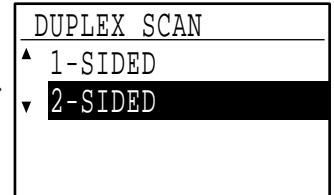
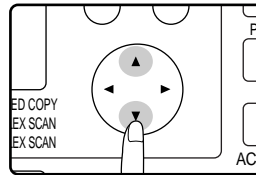

6 Press the [OK] key.

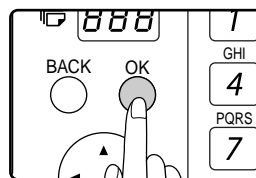

The duplex original type selection screen appears.

7 Select book or tablet for the duplex original type with the [▼] or [▲] key.

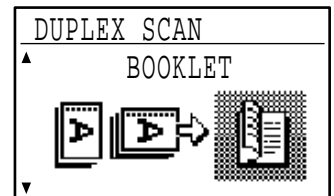
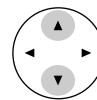

8 Press the [OK] key.

You will return to the base screen and the duplex scanning mode icon will appear.

9 Continue from step 4 of "BASIC PROCEDURE FOR SENDING FAXES" (page 17).



- Booklets and tablets
Two-sided originals that are bound at the side are booklets, and two-sided originals that are bound at the top are tablets.
- Duplex scanning is cancelled when the transmission is completed, or when the [CA] key is pressed.
- Duplex scanning of two-sided originals is only possible when an RSPF is used. Automatic scanning of both sides of an original is not possible when the document glass is used.
- Automatic scanning of both sides of an original longer than A3 (11" x 17") is not possible.
- The image of the back side of the original is rotated 180 degrees if needed at the time of transmission, and thus there is no need to change the orientation at the receiving machine.
- To cancel duplex scanning, select "1-SIDED" in step 5 and then press the [OK] key.
- When duplex scanning is enabled, dual page scan (page 42) cannot be enabled.

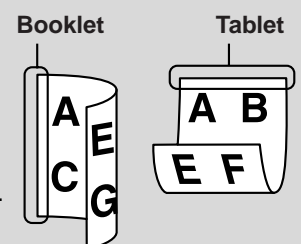

Transmission settings (memory transmission mode and direct transmission mode)

Transmission modes include memory transmission, where the original is temporarily scanned into memory before transmission, and direct transmission, where the original is transmitted directly without being scanned into memory. There are two types of memory transmission: "Storing a transmission" (page 23), where all pages of the original are scanned into memory before transmission begins, and "Quick online transmission" (page 24), where the destination is dialled after the first page is scanned and the remaining pages are transmitted as they are scanned. During a memory transmission, it may happen that the memory becomes full while the originals are being scanned. (See "If the memory becomes full during transmission of a stored transmission job" on page 23 and "If the memory becomes full during a quick online transmission" on page 24.) The number of pages that can be stored in memory varies depending on the content of the pages, the transmission settings, and whether memory has been added. If there are too many pages and memory transmission is not possible, you can press the [COMM. SETTING] key to switch from memory transmission to direct transmission. When direct transmission is used, transmission begins after the current job is completed, allowing you to give priority to a transmission job. As such, direct transmission is a convenient means of performing an interrupt transmission when there are a large number of stored transmission jobs. To switch between memory transmission and direct transmission, see the following "Faxing by direct transmission".



When transmission is performed manually using an extension phone connected to the machine or using on-hook dialling, direct transmission is automatically selected. (Memory transmission is not possible.)

Faxing by direct transmission

1 Perform steps 1 to 4 of "BASIC PROCEDURE FOR SENDING FAXES" (page 17).

2 Press the [COMM.SETTING] key

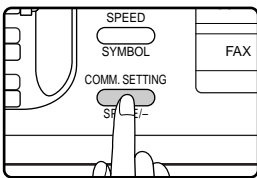

The communication settings screen appears.



The communication settings screen can also be displayed from the function selection screen. Press the [SPECIAL FUNCTION] key to display the special function selection screen, select "COMM. SETTING" with the [▼] or [▲] key, and press the [OK] key.

3 Select "TX" with the [▼] or [▲] key.

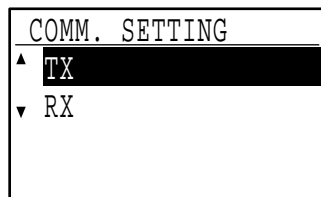
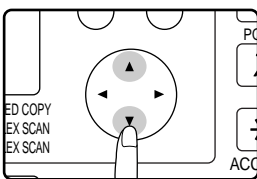

4 Press the [OK] key.

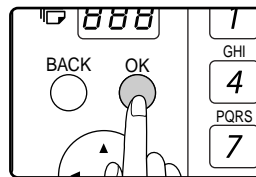

5 Select "DIRECT TX" with the [▼] or [▲] key.

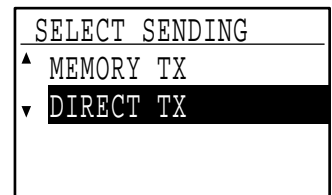

6 Press the [OK] key.



7 Dial the fax number.

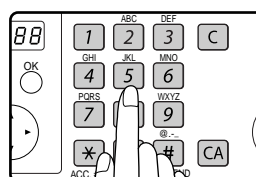

Group dialling cannot be used.

8 Press the [START] key.

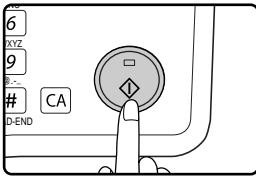

When using the document glass, multiple original pages cannot be transmitted in a single transmission.



- To change from "Direct Transmission" back to "Memory Transmission", select "MEMORY TX" in step 5.
- To cancel a direct transmission, press the [C] key.

Faxing by manual transmission (using the [SPEAKER] key)

1 Perform steps 1 to 4 of "BASIC PROCEDURE FOR SENDING FAXES" (page 17).

2 Press the [SPEAKER] key

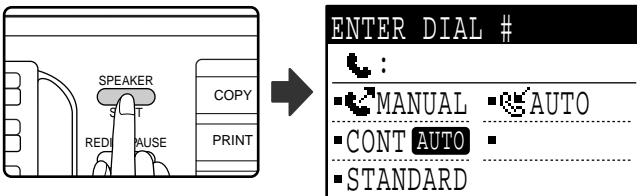

When this key is pressed, a message regarding volume adjustment will appear briefly followed by the dial entry screen. You can adjust the speaker volume (high, middle, or low) by pressing the [▼] or [▲] key. Note that this will not change the volume setting in the system settings. Ringing will be heard from the speaker on the left side of the machine (toward the back) when the [SPEAKER] key is used for dialling.

3 Perform steps 7 and 8 of "Faxing by direct transmission" (page 22 to 23).



- To cancel dialling using the [SPEAKER] key when you need to redial the number or because transmission was interrupted, press the [SPEAKER] key once again.
- As the original is not stored in memory when direct transmission and manual transmission are used, the following functions cannot be used. Broadcast transmission (page 31), timer transmission (page 33), F-code relay broadcast transmission (page 63), redial (page 107), image rotation (page 105), duplex scanning, dual pages, and others.
- When a fax is sent by direct transmission or manual transmission, the fax is sent after the connection with the receiving machine is established.

2

Storing transmission jobs (memory transmission)

When the line is in use, the transmission job is temporarily stored in memory. When the current job and any previously stored jobs are completed, transmission begins automatically. (This is called memory transmission.) This means that transmission jobs can be stored in memory by performing a transmission operation while the machine is occupied with another transmission/reception operation. Up to 50 jobs can be stored in memory at once. After transmission, the scanned document data is cleared from memory. You can check transmission jobs stored in memory in the fax job status screen. (Page 26) Note that depending on the number of pages stored in memory and the transmission settings, it may not be possible to store 50 jobs in memory.

- The procedure for storing a transmission job is the same as the procedure in "BASIC PROCEDURE FOR SENDING FAXES" on page 17.
- If you have not yet pressed the [START] key (Ⓢ), you can cancel a transmission job by pressing the [C] key.
- If you have already pressed the [START] key (Ⓢ), see "Cancelling a stored transmission job" (page 26). If the original is still being scanned after the [START] key (Ⓢ) is pressed, you can press the [C] key to cancel the transmission.
- If you store a transmission job in direct transmission mode, you will not be able to store any further transmission jobs.

After transmission, the scanned document data is cleared from memory. You can check transmission jobs stored in memory in the fax job status screen. (Page 26)

If the memory becomes full during transmission of a stored transmission job

If the memory becomes full while scanning the first page of a document, the transmission job is automatically cancelled. If the memory becomes full while scanning the second page or a following page, scanning stops. In this case, you can either press the [C] key to cancel the transmission, or press the [OK] key to transmit only those pages which were completely scanned.

Quick On-line

When you use the SPF/RSPF to send a multi-page document and there are no previously stored jobs waiting or in progress (and the line is not being used), the machine dials the destination after the first page is scanned and begins transmitting scanned pages while the remaining pages are being scanned. This transmission method is called Quick On-line. When a quick online transmission is being performed, the message display shows "READING" - "DIALLING" - "COMM." - "SENDING" in that order until scanning of the remaining pages is completed. When all pages have been scanned, "READ END" appears before the above messages appear.

If the receiving party is busy, the quick online transmission will change into a stored transmission job (memory transmission). (See "Storing transmission jobs (memory transmission)" on page 23.)

If the memory becomes full during a quick online transmission

If the memory becomes full while scanning the first page of a document, the transmission job is automatically cancelled. If the memory becomes full while scanning the second page or a following page, those pages which were completely scanned will be transmitted.



The machine is initially set (factory setting) to perform Quick On-line transmission. If desired, you can disable this function in the system settings. (See "QUICK ON LINE TX" on page 106.) When an original is transmitted using the following methods, the job will be stored in memory. (Quick On-line transmission will not be performed.)

- Sending a fax from the document glass.
- Broadcast transmission (page 31)
- Timer transmission (page 33)
- F-code transmission (page 52 in Chapter 4)

If the receiving party is busy

If the receiving party is busy, the transmission is temporarily cancelled and then automatically re-attempted after a brief interval. (Two attempts are made at an interval of 3 minutes.*1 *3)

If you do not want the machine to re-attempt the transmission, press the [FAX STATUS] key and cancel the job. (Page 26)

*1 The settings can be changed in the system settings. (See "RECALL SETTING (BUSY)" on page 106.)

*3 Varies depending on country and region.

If a transmission error occurs

If an error occurs that prevents transmission or the receiving machine does not answer the call within 45 seconds*2 *3, the transmission is stopped and then automatically re-attempted later. One attempt is made at an interval of 1 minute.*2) If you do not want the machine to re-attempt the transmission, press the [FAX STATUS] key and cancel the job. (Page 26) This machine also supports error correction mode (ECM) and is set to automatically resend any part of a fax that is distorted due to noise on the line.

*2 The settings can be changed in the system settings. (See "RING TIMEOUT IN AUTO TX" (page 107) and "RECALL SET (ERR)" (page 107).)

*3 Varies depending on country and region.

Image rotation

The machine is initially set to rotate a vertically-placed (⏏) document 90° so that it is oriented horizontally (⏏) before transmission (A4 (8-1/2" x 11") originals are rotated to A4R (8-1/2" x 11"R) and A5R originals are rotated to A5). A4R (8-1/2" x 11"R) originals and A5 originals are not rotated. In Taiwan, B5R originals are also rotated to B5 (however, B5 originals are not rotated). If desired, you can disable the rotation function in the system settings as explained on "ROTATE TX" (page 105).



Place A5 size originals so that they are oriented vertically (⏏). If oriented horizontally, (⏏A5R orientation), press the [ORIGINAL SIZE] key and specify the correct original size (select "A5R") (See "MANUALLY SETTING THE SCANNING SIZE" on page 13.)

CANCELLING A FAX TRANSMISSION

To cancel a transmission that is in progress or a stored transmission job, follow the steps below. A transmission in progress or a stored transmission job is cancelled from the fax status screen. (Printing of a received fax cannot be cancelled.)



To cancel a transmission while the original is being scanned ("READING" appears in the message display) or before the [#] key is pressed ([READ-END] key ([#]) when scanning the original from the document glass), the [C] or [CA] key can be pressed.

Cancelling a fax transmission

1 Press the [FAX STATUS] key.

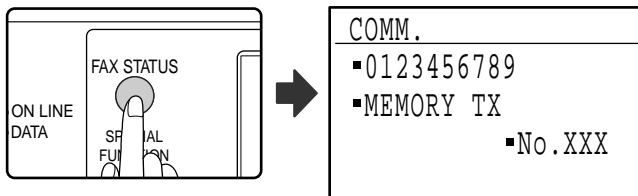

- When a transmission is in progress, the job being transmitted is displayed.
- If the displayed job is not the job that you wish to cancel, it is likely that the job to be cancelled is a stored job waiting for transmission. Press the [BACK] key to display the fax status selection screen and then follow the procedure in "Cancelling a stored transmission job" on page 26 to cancel the job.



When a transmission is not in progress, the following fax status selection screen appears.

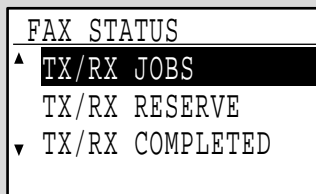

2 Press the [C] key.

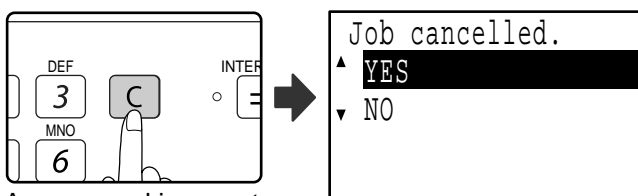

A screen asking you to confirm cancellation of the transmission appears.

3 Press the [OK] key.

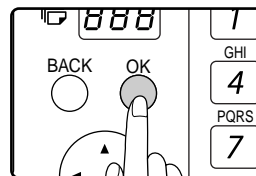

The transmission is cancelled.



- If you do not wish to cancel the transmission, press the [▼] key in the screen of step 2, select "NO", and press the [OK] key.
- You can check cancelled operations in the Activity Report. "CANCEL" will appear in the "TYPE/NOTE" column of the report. Additional information on the display during transmission

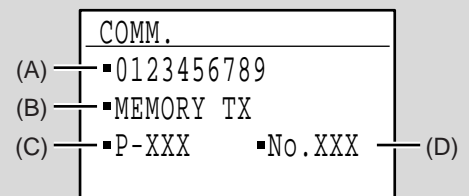

- (A) Destination name
The name of the destination appears if programmed.
- (B) Transmission method name
In the case of a timer transmission, the timer icon "⌚" appears at the beginning of the transmission method name.
- (C) Number of pages currently transmitted
Appears during sending.
- (D) Document number
The document number assigned at the time of scanning in memory transmission mode appears.

2

Cancelling a stored transmission job

If you do not wish to cancel a stored transmission job and only wish to check its status, press the [BACK] key instead of the [C] key in step 4 to exit.

1 Press the [FAX STATUS] key.

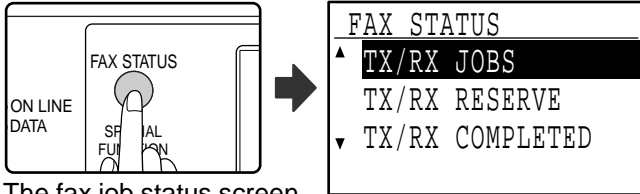

The fax job status screen is displayed.



When a transmission is in progress, the job being transmitted is displayed. Press the [BACK] key to display the fax status selection screen.

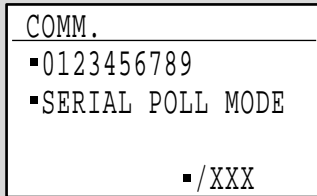

2 Select "TX/RX RESERVE" with the [▼] or [▲] key.

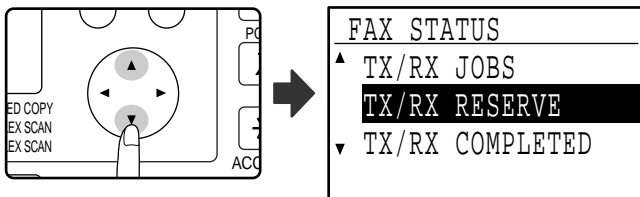

3 Press the [OK] key.

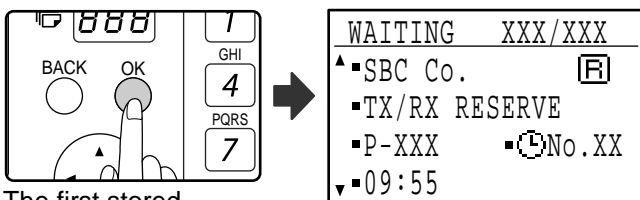

The first stored transmission job appears.

Press the [▼] or [▲] key until the transmission job that you wish to cancel appears.

4 Press the [C] key.

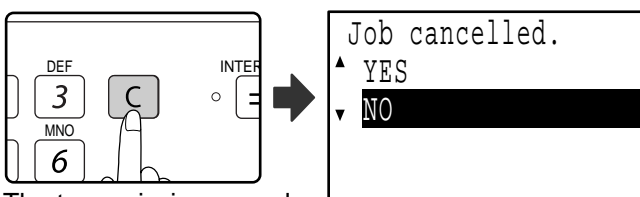

The transmission cancel confirmation screen appears.

5 Select "YES" with the [▼] or [▲] key.

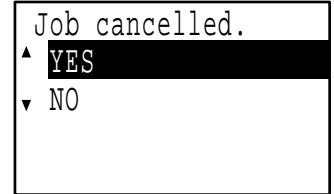

6 Press the [OK] key.



The selected transmission job is cancelled.

If you wish to cancel another transmission job, repeat steps 1 through 6.



You can check cancelled recall mode jobs in the Activity Report. "CANCEL" will appear in the "TYPE/NOTE" column of the report.

Contents of the stored job screen (screen of step 3)

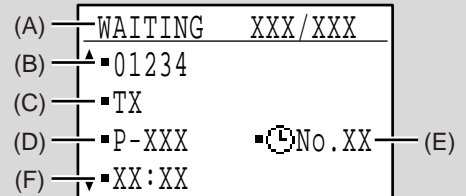

- (A) Current status
"WAITING" will appear next to stored transmission jobs and timer transmission jobs. "RECALL" will appear next to recall mode jobs.
- (B) Destination
The name of the destination appears if programmed.
- (C) Transmission method name
In the case of a timer transmission, the timer icon "⌚" appears at the beginning of the transmission method name.
- (D) Number of pages stored
In the case of a stored transmission job, the document number assigned at the time of scanning appears.
- (E) In the case of a timer transmission, the timer job number appears.
- (F) In the case of a timer transmission, the timer job number appears. "Prepared" will appear for a stored transmission job.

Status of completed jobs

To check the status of completed jobs, select "TX/RX COMPLETED" in step 2 and press the [OK] key in step 3.

RECEIVING FAXES

When another fax machine sends a fax to your machine, your machine will ring*, automatically receive the fax, and begin printing. (This is called automatic reception.)

If you do not wish to have received faxes printed immediately, use the print hold function to hold received faxes in memory for printing at your convenience (all received faxes will be printed at once). To enable this function and print received faxes, see "FAX PRINT HOLD FUNCTION" on page 29.



- You can store a transmission job while fax reception is in progress. (See "Storing transmission jobs (memory transmission)" on page 23.)
- To print received fax pages on both sides of the paper, enable "DUPLEX RECEPTION" (page 109) in the system settings.
- If an extension phone is not connected to the machine, use automatic reception.
- In order to receive faxes, paper must be loaded in the paper tray. See "LOADING PAPER" in the Operation Guide for the machine to load appropriate paper. Incoming faxes will be automatically adjusted to the orientation of the printing paper, so there is no need to load both horizontally (☐) and vertically (≡) oriented paper. However, when a fax smaller than A4 (8-1/2" x 11") is received, the size of paper used to print the fax will differ depending on the orientation (horizontal or vertical) of the original in the sending machine.

RECEIVING A FAX

2

1 The machine will ring* and reception will automatically begin.

The LINE indicator lights up.

*Number of rings

The machine has been set to ring twice before beginning automatic reception. You can change the number of rings to any number from 0 to 9 in the system settings. (See "#OF RINGS AT. RX" on page 108.)

If the number of rings is set to 0, the machine will receive faxes without ringing.

2 Reception ends.

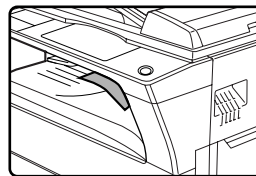

- When reception ends, the machine sounds a beep.
- When the optional job separator tray kit is installed, received faxes are output to the job separator.



The job separator has a sensor that detects when a tray is full. When approximately 100 sheets accumulate in a tray, a message appears in the display and fax printing stops. If this happens, remove the sheets. Printing will resume momentarily.

Earlier output of received data

If a fax cannot be printed because the machine is out of the appropriate paper and another fax is subsequently received that can be printed, the subsequently received fax will be printed before the fax that cannot be printed. This also happens when there are several faxes in memory that cannot be printed.

This function can be disabled in the system settings. (See "EARLIER OUTPUT" on page 110.)

F-code confidential fax reception

When a fax has been received by F-code confidential fax reception, an icon (E^F) will appear in the base screen of fax mode (message display (1) on page 9). The icon also appears in front of the box in the F-code confidential box name screen in the display. (Step 6 on page 61) Print the received fax as explained in "PRINTING A DOCUMENT RECEIVED TO AN F-CODE CONFIDENTIAL MEMORY BOX" (page 61).

If received data cannot be printed

If the machine runs out of paper or toner, or a paper misfeed occurs, or if the machine is printing a print or copy job, received faxes will be held in memory until printing becomes possible. The received faxes are automatically printed when printing is possible. When received faxes are held in memory, the DATA indicator at the upper right of the [FAX] key blinks. You can also use the forwarding function to have another fax machine print the received faxes. (See "FORWARDING FUNCTION" on page 49.)



In order to receive faxes, paper must be loaded in the paper tray. Load appropriate paper as explained in "LOADING PAPER" in the Operation Guide for the machine. The difference between vertically and horizontally oriented A4 and A4R paper (8-1/2" x 11" and 8-1/2" x 11"R paper), is automatically adjusted at the time of reception, so there is no need to load paper in both orientations. However, when a fax smaller than A4 (8-1/2" x 11") is received, the size of paper used to print the fax will differ depending on the orientation (horizontal or vertical) of the original in the sending machine.

- If you wish to use A5 (5-1/2" x 8-1/2") paper to receive faxes, load A5 (5-1/2" x 8-1/2") paper in tray 1 of the machine and set the paper size to A5 (5-1/2" x 8-1/2"). Only tray 1 can be set to A5 (5-1/2" x 8-1/2") size.
- If you receive a fax that is larger than the loaded paper, the system setting uses "RECEIVED DATA PRINT CONDITION" on page 109 to print it out in the following manner:
 - If "REDUCTION" is set up, the image is automatically reduced before printing.*1
 - If "DIVISION" is set up, the image is split onto multiple sheets of paper and printed on them at actual size.*1
 - If "ACTUAL SIZE" is set up, the image is printed at actual size without being split.*2
- *1 If the loaded paper is of the B5 size or less, the received image may not be printed depending upon the width and length of the image data.
- *2 The received image won't be printed until you load the paper larger than the actual size.
- In fax mode, printing is not possible on 11" x 17", 8-1/2" x 14", 5-1/2" x 8-1/2" sizes. (Among INCH sizes, only 8-1/2" x 11" and 8-1/2" x 11"R can be used for printing.) (If your machine uses inch-based paper sizes, A3, B4, B5, B5R, and A5 size paper cannot be used in fax mode. (Among AB sizes, only A4 and A4R can be used for printing.))
- If the paper runs out while a fax is being printed, printing will automatically continue using the closest size of paper in another tray.
- If you change the size of paper loaded in a tray, change the tray's paper size setting.
- Faxes cannot be printed correctly if the actual paper size is different from the paper size setting. Be sure to set the tray's paper size setting to the same paper size as the paper loaded in the tray. For example, if you receive an A3 (11" x 17") size fax when B4 (8-1/2" x 14") paper is loaded in the tray and the tray's paper size setting is A3 (11" x 17"), the fax will be printed on B4 (8-1/2" x 14") paper and part of the image may be cut off. If the paper loaded in the tray is larger than the paper size setting, paper larger than the recognized fax size will be used. (A message prompting you to check the tray's paper size setting will appear.)
- Received faxes cannot be printed on paper inserted in the bypass tray.

FAX PRINT HOLD FUNCTION

Faxes are normally printed as soon as they are received.

This function is used to hold received faxes in memory rather than printing them as they are received. Faxes held in memory are printed manually all at once.

Settings required for fax print hold

If a fax is received when auto power shut-off mode has activated ("POWER ON AND OFF" in the Operation Guide for the machine), the machine returns to normal operation in order to print the fax. For this reason, if faxes are received at regular intervals, auto power shut-off will repeatedly activate and deactivate and less power will be conserved.

If you wish to maximize the benefit of auto power shut-off at night and other times when printing of received faxes is not immediately necessary, enable fax print hold. When fax print hold is enabled, receiving faxes when auto power shut-off has activated will not cause auto power shut-off to deactivate.

It is recommended that you enable and disable fax print hold as needed for your conditions of use; for example, enable fax print hold during the night and disable it during the day.

2



- When fax print hold is enabled and received faxes are held in memory, the DATA indicator above the [FAX] key on the operation panel blinks and a message appears in the display. (When the received faxes are printed, the indicator stops blinking and the message no longer appears.)
- If the remaining free memory reaches 0%, fax reception will no longer be possible. For this reason, it is important to constantly make sure that sufficient free memory remains and frequently print received faxes. The percentage of free memory remaining appears in the base screen of fax mode. (Page 9)

Enabling fax print hold



If fax print hold is prohibited using "DISABLE FAX PRINT HOLD" (page 104) in the system settings, it will not be possible to enable it.

1 In Fax mode, press the [SPECIAL FUNCTION] key.

Begin the following procedure from the base screen of Fax mode.

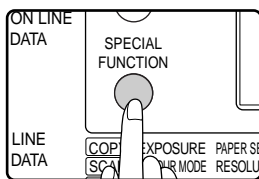

Press the [SPECIAL FUNCTION] key to display the special function menu. (To select fax mode, see step 1 on page 17.)

2 Select "FAX PRINT HOLD" with the [▼] or [▲] key.

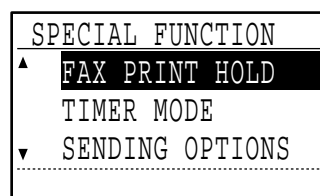
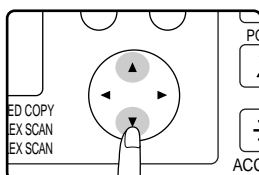

3 Press the [OK] key.

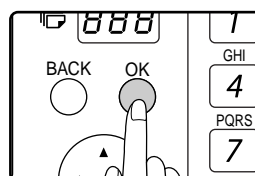

4 Select "SETTING" with the [▼] or [▲] key.

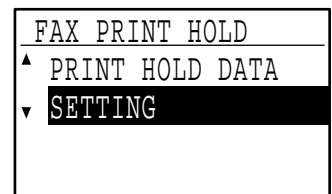
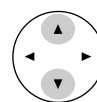

5 Press the [OK] key.



6 Select "ON" with the [▼] or [▲] key.

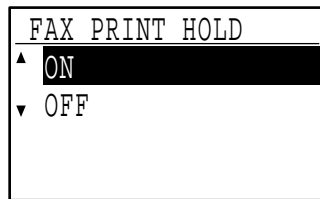
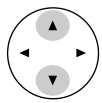

To disable fax print hold, select "OFF".

7 Press the [OK] key.



Printing received faxes held in memory

To print received faxes that are held in memory when fax print hold is enabled, follow the steps below.

1 In Fax mode, press the [SPECIAL FUNCTION] key.

Begin the following procedure from the base screen of Fax mode.

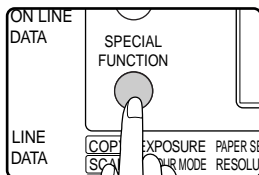

Press the [SPECIAL FUNCTION] key to display the special function menu. (To select fax mode, see step 1 on page 17.)

2 Select "FAX PRINT HOLD" with the [▼] or [▲] key.

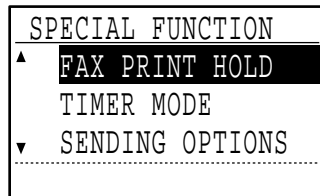
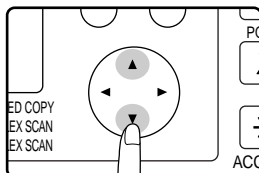

3 Press the [OK] key.

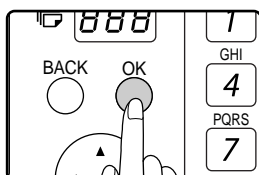

4 Select "PRINT HOLD DATA" with the [▼] or [▲] key.

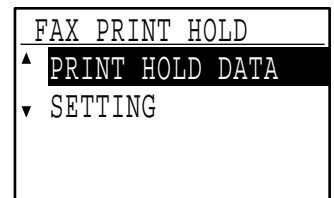

5 Press the [OK] key.



6 Select "PRINT" with the [▼] or [▲] key.

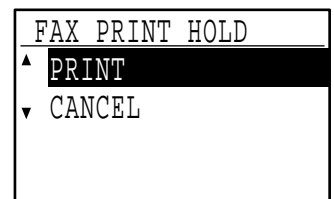

7 Press the [OK] key.



3

ADVANCED TRANSMISSION METHODS

This chapter explains advanced features that are designed for specific purposes and circumstances. Please read those sections that are of interest to you.

SENDING THE SAME DOCUMENT TO MULTIPLE DESTINATIONS IN A SINGLE OPERATION (BROADCAST TRANSMISSION)

This feature is used to send a fax to multiple destinations in a single operation. The original to be transmitted is scanned into memory and then successively transmitted to the selected destinations. This feature is convenient for such purposes as distributing a report to company branches. Up to 200 destinations can be selected. When transmission to all destinations has been completed, the document is automatically cleared from memory.



- If you frequently use broadcasting to send faxes to the same group of destinations, it is convenient to program those destinations into a group key. Group key dialling is an automatic dialling function whereby multiple destinations (Rapid keys, Speed Dial numbers, and full fax numbers entered with the numeric keys) are programmed into a Rapid key. The procedure for programming group keys is explained on page 66.
- When a group key is used to send a fax, the fax is broadcast (transmitted) to the destinations programmed in the group key. For example, if five destinations are programmed in a group key and the key is pressed for a broadcast transmission, the broadcast transmission will have five destinations.

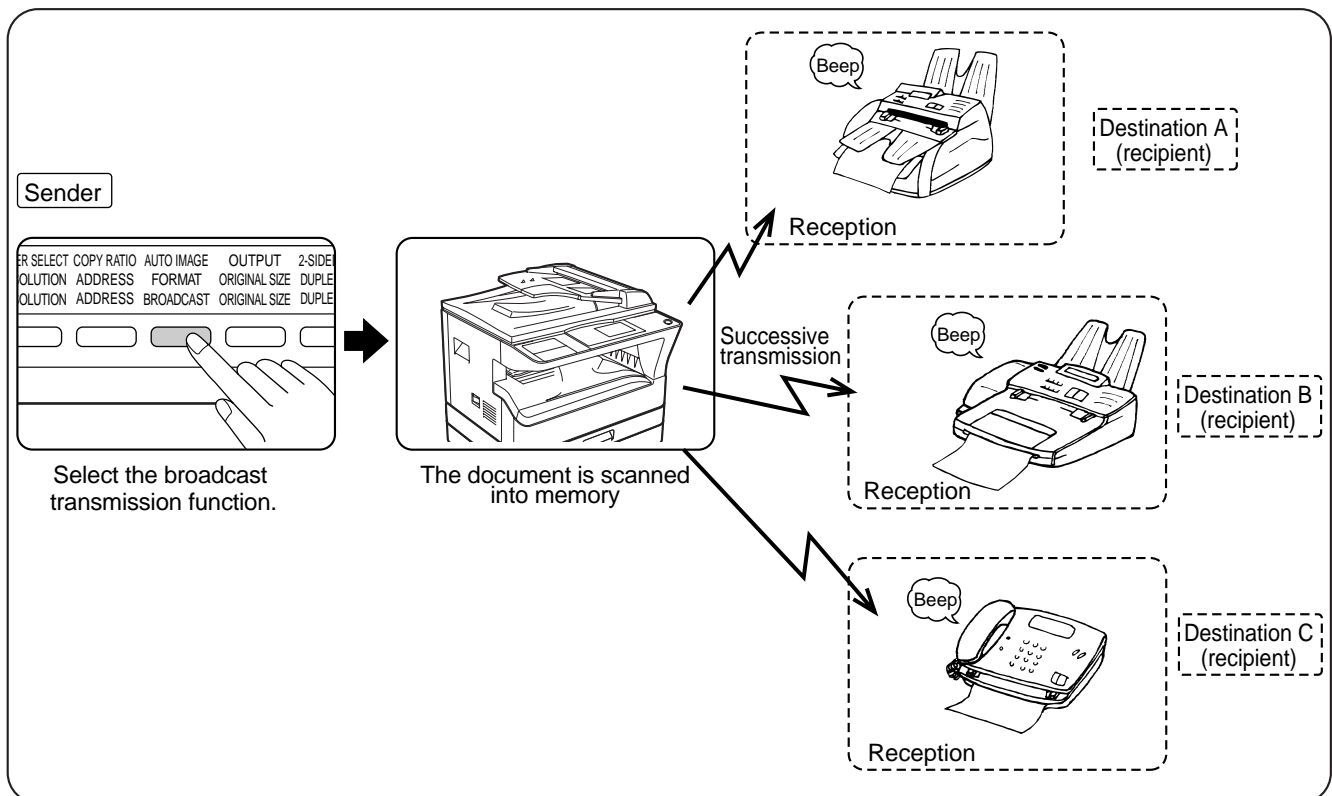

USING BROADCAST TRANSMISSION

1 Perform steps 1 to 4 of "BASIC PROCEDURE FOR SENDING FAXES" (page 17).

2 Press the [BROADCAST] key.

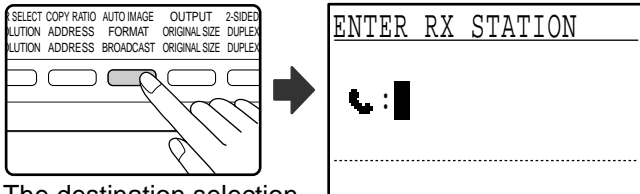

The destination selection screen appears.

3 Enter a full fax number with the numeric keys or press an auto-dial key (Rapid key, Speed Dial number, or group key) to select the first destination. (Page 19)

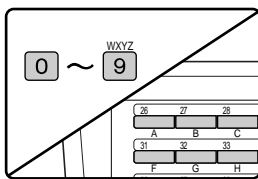

To clear a mistake when entering a full number with the numeric keys, press the [C] key to clear one digit at a time.

A destination selected with a Rapid key, Speed Dial number, or group key is indicated by an icon and a number. To clear an entry, press the [C] key.

4 Press the [OK] key and then select the next destination by entering a full fax number or pressing an auto-dial key.

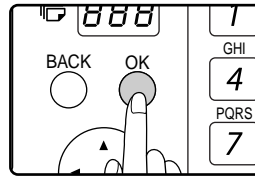

After entering a full number with the numeric keys, press the [OK] key to complete the entry. If you pressed an auto-dial key in step 3, it is not necessary to press the [OK] key. You can immediately press another auto-dial key for the next destination. Repeat steps 3 and 4 to select the remaining destinations.

Note

- If you need to delete a number for which entry has already been completed by pressing the [OK] key, use the [◀] or [▶] key to select the number and then press the [C] key.
- If the selected destinations exceed the display range of the message screen, press the [◀] or [▶] key to scroll through and check the destinations.
- Destinations can also be selected using the address directory and the [REDIAL] key. Note, however, that the [REDIAL] key can only be used to select the first destination (it must be used before any other destinations are selected).
- If you use two group keys that have 50 stations each, the total number of destinations entered will be 100.

5 Continue from step 6 of "BASIC PROCEDURE FOR SENDING FAXES" on page 18.

Note

To cancel a broadcast transmission
To cancel a broadcast transmission when selecting destinations, press the [CA] key. To cancel transmission after the transmission procedure has been completed, follow the procedure in "CANCELLING A FAX TRANSMISSION" (page 25).

AUTOMATIC TRANSMISSION AT A SPECIFIED TIME (TIMER TRANSMISSION)

This feature enables you to set up a transmission or polling operation to be performed automatically at a specified time up to a week in advance. This is convenient when you will be out of the office or for transmission at off-peak nighttime rates. A combined total of 50 timer transmission and memory transmission jobs can be stored.



- After a timer transmission is performed, the information (image, destination, etc.) is automatically cleared from memory.
- To perform a timer transmission, the original must be scanned into memory. It is not possible to leave the original in the SPF/RSPF or on the document glass and have it scanned at the specified time of transmission.
- The date and time is set in the machine using the system settings. (See "DATE & TIME SET" on page 104.)
- Only one polling timer operation can be set up at a time. If you wish to set up multiple timer polling operations, combine the machines to be polled into one serial polling operation with a timer setting (see "Serial polling" on page 37).

SETTING UP A TIMER TRANSMISSION

1 In Fax mode, press the [SPECIAL FUNCTION] key.

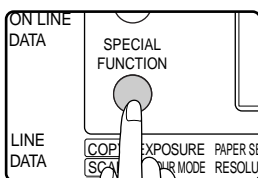

When the [SPECIAL FUNCTION] key is pressed, the special function menu appears. (To select fax mode, see step 1 on page 17.)

2 Select "TIMER MODE" with the [▼] or [▲] key.

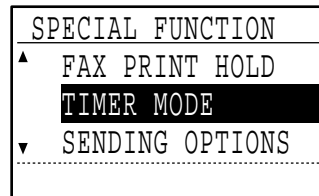
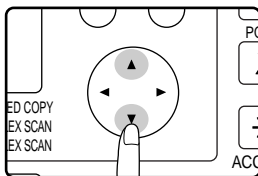

If a time has been specified, a checkmark appears in front of "TIMER MODE". To cancel a specified time, press the [*] key in the above display with "TIMER MODE" highlighted.

3 Press the [OK] key.

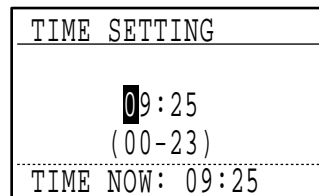
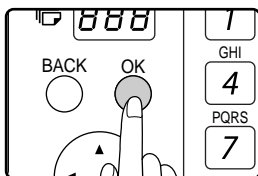

The current time appears in the screen. If the current time is not correct, press the [CA] key to cancel the operation and see "DATE & TIME SET" (page 104) to correct the time setting.

4 Use the numeric keys to select the time at which you want the operation to take place.

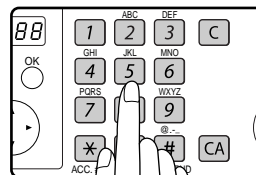

If you need to correct the entered time, use the [◀] key to move back.

3

5 Press the [OK] key.



The specified time is set.

6 Select the day of the week with the [▼] or [▲] key.

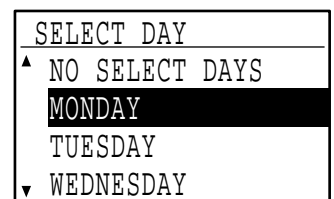

The selected day is highlighted. If you select "NO SELECT DAYS", the transmission will be performed as soon as the specified time arrives. To return to the [TIME SETTING] display, press the [BACK] key.

7 Press the [OK] key.



The selected day is set.

8 Perform the desired fax operation.

The steps that follow will depend on the type of operation.

The following operations can be performed as a timer operation:

- Normal transmission (page 17)
- Broadcast transmission (page 31)
- Polling (page 35)
- Serial polling (page 37)
- F-code polling (page 57)
- F-code confidential transmission (page 59)
- F-code relay request transmission (page 63)



- To cancel a timer operation after the above procedure has been completed, follow the procedure in "CANCELLING A FAX TRANSMISSION" (page 25).
- A timer job number is automatically assigned to the operation. This number can be used to cancel a stored job. (See the note "Contents of the stored job screen (screen of step 3)" on page 26.)
- Other operations can be performed after a timer operation is set up. If another operation is in progress when the specified time arrives, the timer transmission will begin when the job in progress is completed.

TRANSMISSION AND RECEPTION USING THE POLLING FUNCTION

The polling function allows your machine to call a fax machine that has a document ready for transmission and initiate reception of the document. You can also perform the reverse operation: scan a document into the memory of your machine so that another machine can call your machine and initiate reception of the document. Calling the sending machine and asking the sending machine to fax a document is called "polling". Scanning a document into memory and automatically sending it when the receiving machine calls and "polls" your machine is called "polling memory". This function can only be used if the other machine is a Super G3 or G3 machine and supports the polling function.



For information on polling and polling memory using F-codes, see "HOW F-CODE POLLING MEMORY WORKS" (page 54). Normal polling and memory polling are explained in this chapter.

Polling

This function allows your machine to call another fax machine and initiate reception of a document in that machine. A timer setting can also be specified to have the operation take place at night or at another specified time. (See "TIMER TRANSMISSION" on page 33.)

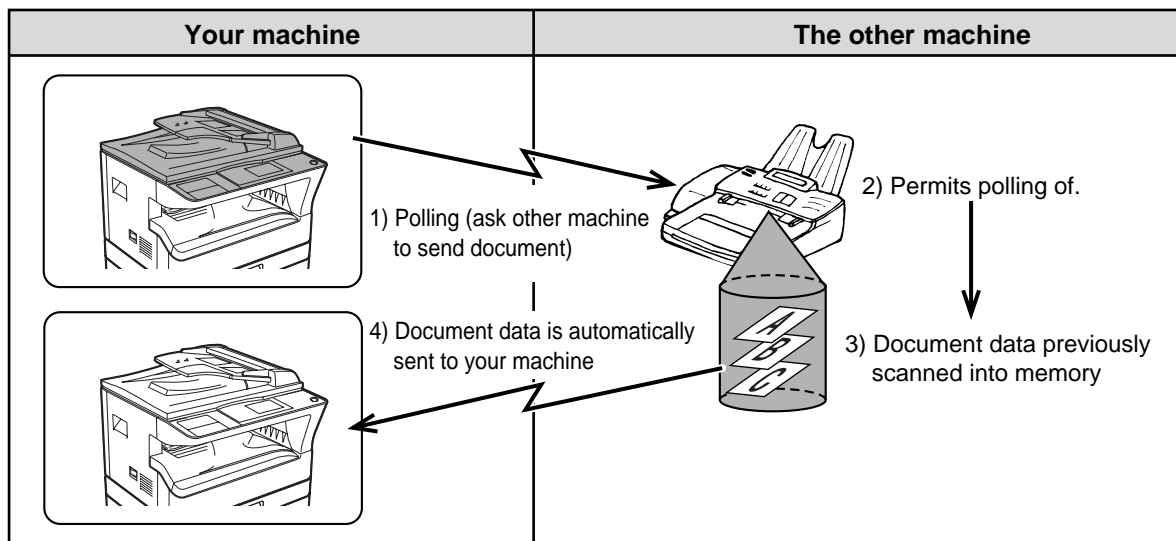

Group keys and the broadcast transmission function (page 31) can be used to successively poll multiple fax machines in a single operation (this is called "serial polling"). Up to 200 machines can be polled. In this case, the sequence of operations in the above diagram is successively repeated for each sending machine selected.



The receiving machine bears the expense (phone charges) of polling transmission.

Polling memory

This feature allows your machine to automatically send a document previously scanned into memory when another machine calls and polls your machine.

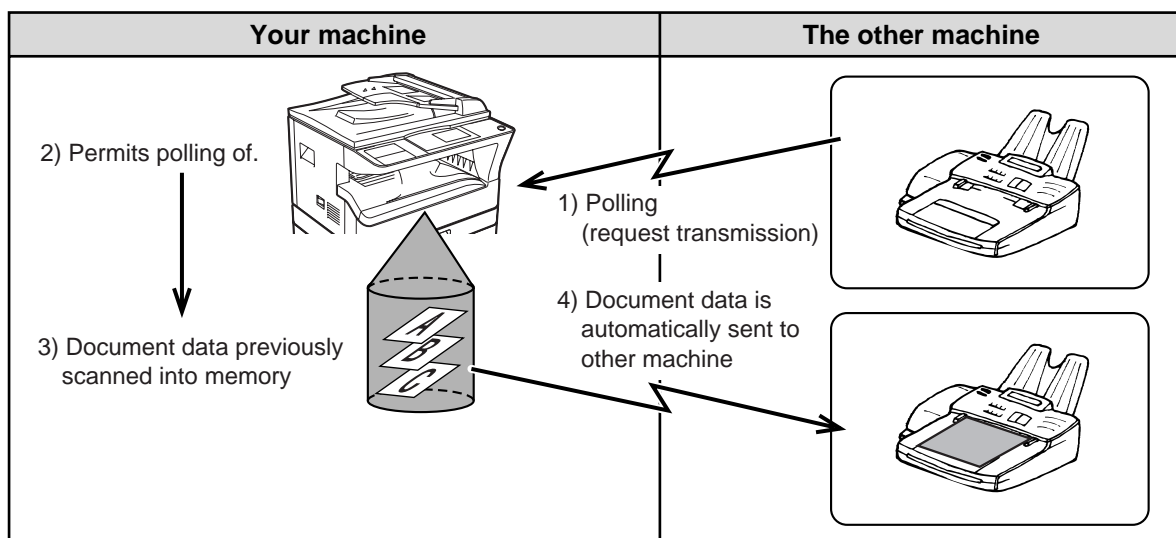

The machine that requests transmission bears the expense (phone charges) of the call.

USING THE POLLING FUNCTION

When used in conjunction with the timer transmission function (page 33), only one polling job can be stored.



If the other machine is using polling security (see "Restricting polling access (polling security)" on page 40), your fax number (sender's number) must be programmed in the system settings (see "OWN PASSCODE SET" on page 101) and your number must also be programmed in the other machine.

1 In Fax mode, press the [SPECIAL FUNCTION] key.

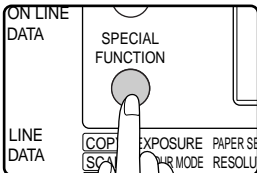

When the [SPECIAL FUNCTION] key is pressed, the special function menu appears. (To select fax mode, see step 1 on page 17.)

2 Select "SENDING OPTIONS" with the [▼] or [▲] key.

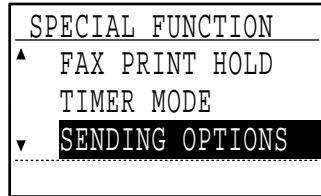
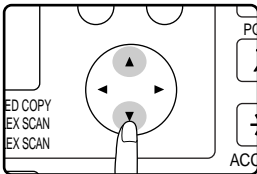

3 Press the [OK] key.

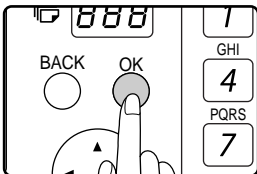

4 Select "POLLING" with the [▼] or [▲] key.

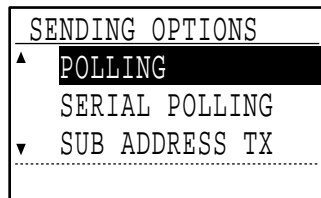
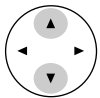

5 Press the [OK] key.



6 Enter the fax number of the other machine with the numeric keys, press a Rapid key, or specify a Speed Dial number (a group key cannot be used).

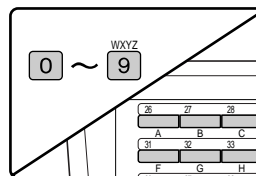

To clear a mistake when entering a full number with the numeric keys, press the [C] key to clear one digit at a time.

A destination selected with a Rapid key or Speed Dial number is indicated by an icon and a number. To clear an entry, press the [C] key.

7 Press the [OK] key.



8 Press the [START] key.

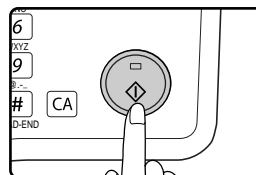

"Polling reservation has been set." appears in the screen. After communicating with the other machine, your machine prints the received fax.



To cancel the operation

During communication: Cancel as explained in "Cancelling a fax transmission" on page 25.
While the job is stored: Cancel as explained in "Cancelling a stored transmission job" on page 26.

Serial polling

When performing serial polling, an auto-dial key that includes a sub-address or passcode (page 52) cannot be selected.

1 Perform steps 1 to 3 of the polling procedure (page 36).

2 Select "SERIAL POLLING" with the [▼] or [▲] key.

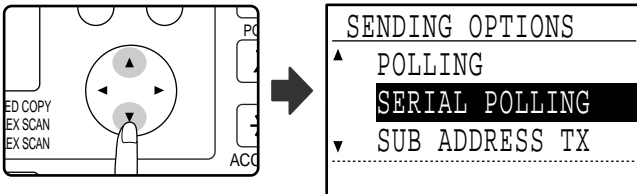

About the steps that follow

See steps 5 to 8 of the polling procedure (page 36). Before pressing the [START] key in step 8, repeat steps 6 and 7 for each machine that you wish to poll. When performing serial polling, a group key can also be used in step 6 on page 36.

USING POLLING MEMORY

This function sends a document previously scanned into memory to a receiving machine when the receiving machine calls and polls your machine. (If desired, you can restrict polling to fax machines whose fax number you have programmed in your machine. See "Restricting polling access (polling security)" on page 40.) The machine has "memory boxes", which are memory used for the regular polling memory function, F-code polling memory, F-code confidential transmission, and F-code relay transmission (see "BOXES AND SUB-ADDRESSES/PASSCODES REQUIRED FOR F-CODE TRANSMISSION" on page 52) The polling memory function explained here uses a memory box called the "PUBLIC BOX".



When using the polling memory function, do not set the reception mode to MANUAL. (See "SETTING THE RECEPTION MODE" on page 65.)

Scanning a document into polling memory (the Public Box)

This section explains how to scan a document into the Public Box. If other documents have already been stored in the Public Box, the new document will be appended to those documents. If the previous documents are no longer needed, they can be replaced.

1 Follow steps 1 to 4 of "BASIC PROCEDURE FOR SENDING FAXES" (page 17) and then follow the steps below.

2 Press the [SPECIAL FUNCTION] key.

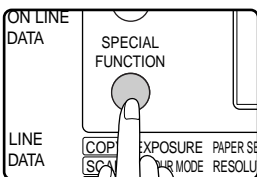

Press the [SPECIAL FUNCTION] key to display the special function menu.

3 Select "ORIGINAL STORE" with the [▼] or [▲] key.

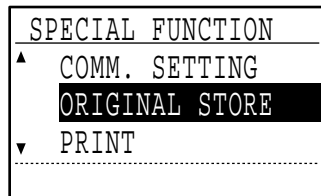
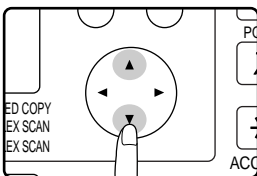

4 Press the [OK] key.

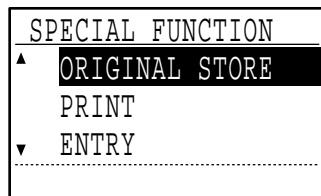
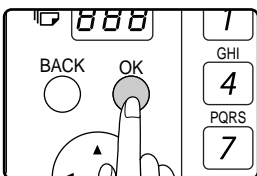

5 Select "MEMORY POLLING" with the [▼] or [▲] key.

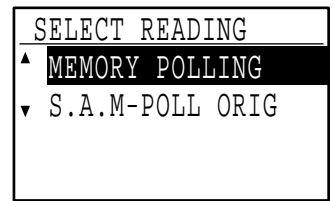

6 Press the [OK] key.



• If there are no previously stored documents in the Public Box, the above screen appears. If the above screen appears, go to step 7.

• If there are previously stored documents in the Public Box, a screen will appear to let you select what action to take.

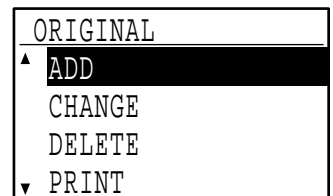

- (1) If you wish to append the new document, select "ADD" with the [▼] or [▲] key, press the [OK] key, and then go to step 7.
- (2) If you wish to replace the previous document with the new document, select "CHANGE" with the [▼] or [▲] key, press the [OK] key, and then go to step 7.

7 Select "1 TIME" or "REPEAT" with the [▼] or [▲] key.

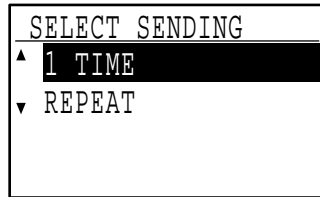
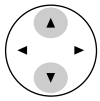

If you select "1 TIME", the document data is automatically cleared from memory after your machine is polled once. If you select "REPEAT", the document data in memory can be used repeatedly. If you selected "ADD" or "CHANGE" in step 6, the transmission settings selected when the previous document was scanned into the Public Box will be replaced by the settings that you will select this time.

8 Press the [OK] key.



9 Press the [START] key (Ⓢ).

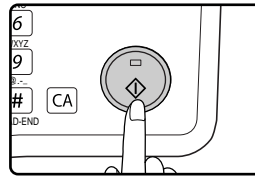

- Scanning begins.
- If you are scanning from the document glass and have another page to scan, change pages and press the [START] key (Ⓢ). Repeat until all pages have been scanned and then press the [#] key.

10 Make sure that the reception mode is set to auto reception.

Transmission begins when the other machine calls and polls your machine.



To cancel scanning

To cancel scanning of a document while scanning is in progress, press the [C] key. To erase the documents in the Public Box, follow the procedure in "Deleting documents from the Public Box" (page 40).

3

Printing documents in the Public Box

To check the document that is stored in the public box, follow these steps to print it out.

1 Follow steps 2 to 6 of "Scanning a document into polling memory (the Public Box)" (page 38) and then follow the steps below.

2 Select "PRINT" with the [▼] or [▲] key.

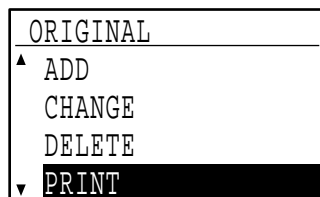
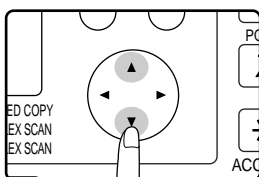

3 Press the [OK] key.

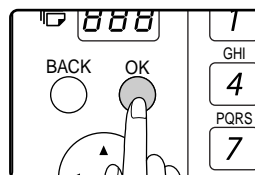

Printing begins automatically.

Deleting documents from the Public Box

This procedure is used to delete documents from the Public Box when they are no longer needed.

1 Follow steps 2 to 6 of "Scanning a document into polling memory (the Public Box)" (page 38) and then follow the steps below.

2 Select "DELETE" with the [▼] or [▲] key.

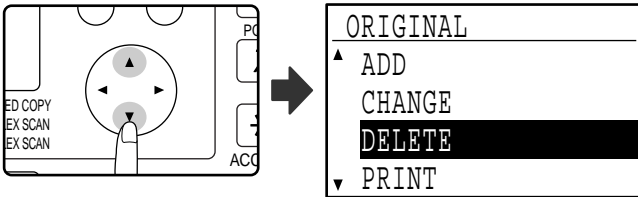

3 Press the [OK] key.

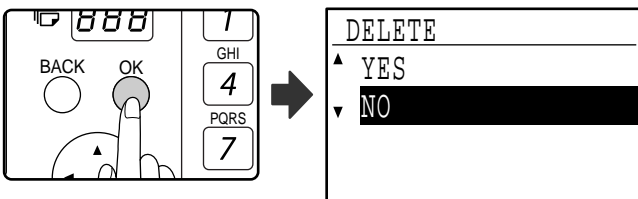

A screen appears asking you to confirm the deletion.

4 Select "YES" with the [▼] or [▲] key.

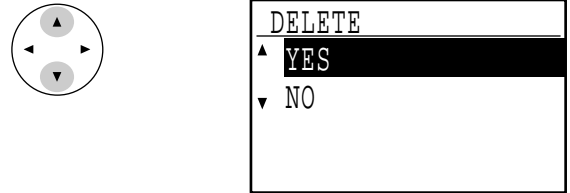

To cancel the deletion, select "NO".

5 Press the [OK] key.



The documents are deleted from the Public Box.



Deletion is not possible while the Public Box is being used.

Restricting polling access (polling security)

If you wish to prevent unauthorised fax machines from polling your machine, enable the polling security function. When this function is enabled, polling permission will only be granted if the fax number of the polling machine (programmed in that machine as the sender's number) matches one of the fax numbers you have programmed in your machine as passcode numbers. Up to 10 fax numbers can be programmed as passcode numbers.

To enable the polling security function and program passcode numbers, see "POLLING PASSCODE # MODE" (page 111) in the system settings.



- If you do not use the polling security function, the document will be sent to any fax machine that polls you.
- To use polling memory with polling security enabled, the sender's number of the polling machine must be programmed in that machine and in your machine.

INCLUDING SENDER INFORMATION ON FAXES

This function prints the date, time, your programmed name, your programmed fax number, and the transmitted page number at the top centre of each page that you fax. All pages that you fax include this information.

Example of fax page printed out by the receiving machine

OCT-22-2011-SAT 03:00 PM	SHARP PLANNING DIV.	FAX No. 0666211221	P. 001/001
↑ (1)	↑ (2)	↑ (3)	↑ (4)

- (1) Date and time: programmed in the system settings (see "DATE & TIME SET" on page 104).
- (2) Sender's name: programmed in the system settings (see "OWN PASSCODE SET" on page 101).
When Auditing mode (page 10) is being used for the fax function and "ACC. NAME PRINT" (page 106) is enabled, the account name* of the account used to perform the transmission is used for the sender's name.
* The account name entered in step 6 of "ACCOUNT # SET" (page 103) in the system settings.
- (3) Sender' number: programmed in the system settings (see "OWN PASSCODE SET" on page 101).
- (4) Transmitted page number: 3-digit number appearing in the format, "page number/total pages". (Only the page number appears if you use manual transmission, direct transmission, or quick on-line transmission.) Printing of the transmitted page number can be disabled in the system settings (see "PAGE COUNTER SET" on page 105).

Position of sender information

You can select whether the sender information is added outside the document data or inside the document data in the system settings (see "PRINT STATION # IN RCVD DATA" on page 106). The factory default setting is outside the document data.

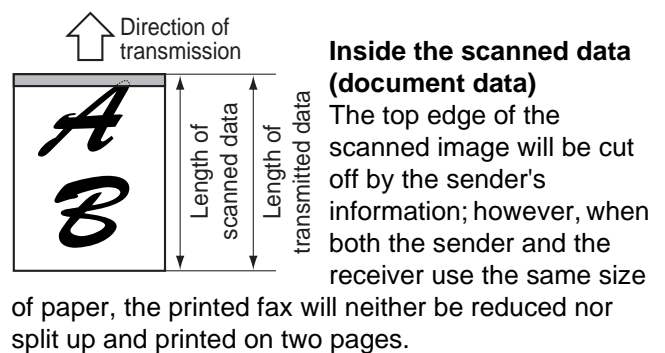
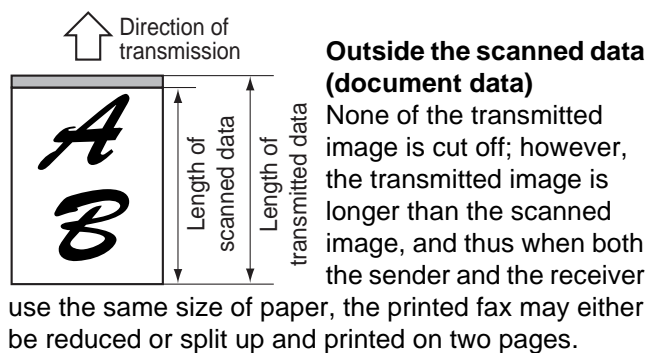

FAXING A DIVIDED ORIGINAL (DUAL PAGE SCAN)

When faxing a book or other bound document, you can use this function to divide the two open pages of the book into two separate fax pages.

This function can only be used when the original is A3, B4, or A4R size (11" x 17" or 8-1/2" x 11"R size if the machine uses inch-based paper sizes) is scanned using the document glass.

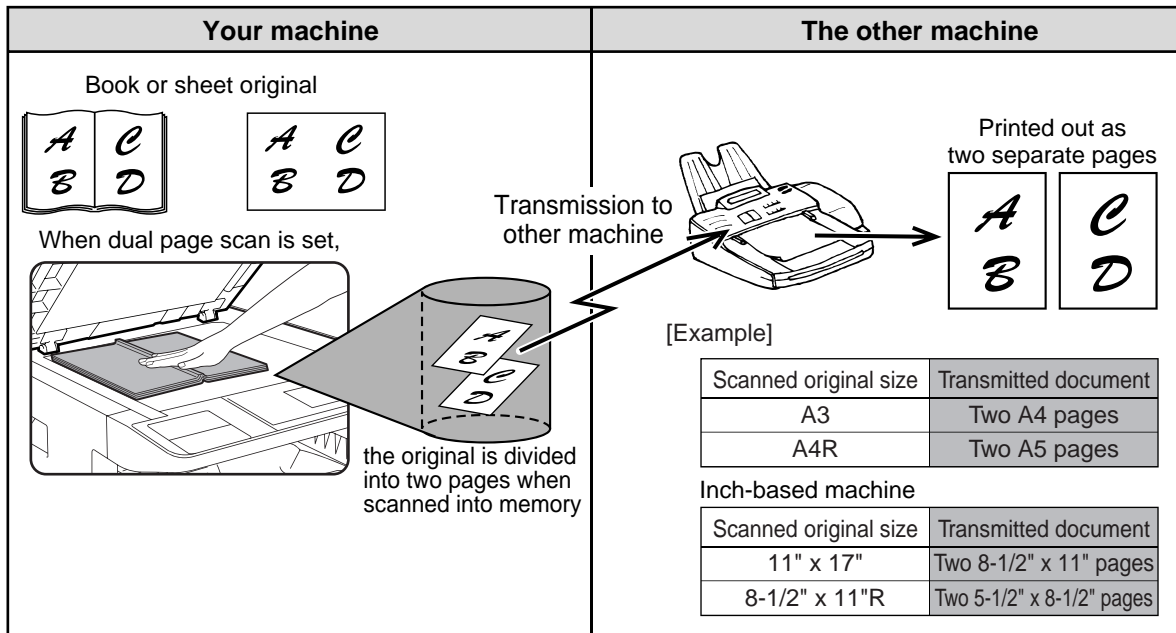

Selecting Dual Page Scan

Follow the steps below and then send the fax.

1 Make sure that the machine is in fax mode

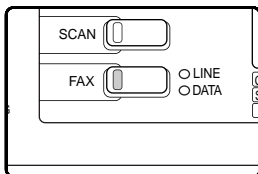

When the machine is in fax mode, the FAX indicator is lit. If the light is not on, press the [FAX] key.

2 Press the [SPECIAL FUNCTION] key.

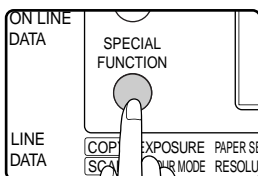

When the [SPECIAL FUNCTION] key is pressed, the special function menu appears.

3 Select "DUAL PAGES" with the [▼] or [▲] key.

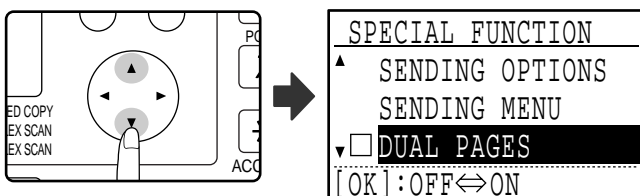

Dual Page Scan is selected when a checkmark appears in the "DUAL PAGES" checkbox. To cancel the selection when a checkmark appears, press the [OK] key in the next step so that a checkmark does not appear.

4 Press the [OK] key.

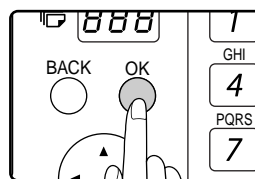

5 Place the original on the document glass (page 12) and perform the transmission operation.

If you have more originals to scan after pressing the [START] key (⏻) and scanning the first original, change originals and press the [START] key (⏻). Repeat until all originals have been scanned. Press the [#] key. (See steps 6 to 8 of "Using the document glass" on page 18.)

ADDING A COVER SHEET/MESSAGE TO A FAX TRANSMISSION

This function automatically attaches an A4 (8-1/2" x 11") cover sheet to your fax transmissions. The cover sheet shows the date and time, the destination name, the sender's name and fax number, and the number of pages in the transmission. A message can also be added to a transmission. One of the following messages can be selected: "CONFIDENTIAL", "PLEASE DISTRIBUTE", "URGENT", "PLEASE CALL BACK", "IMPORTANT".

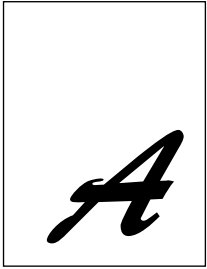
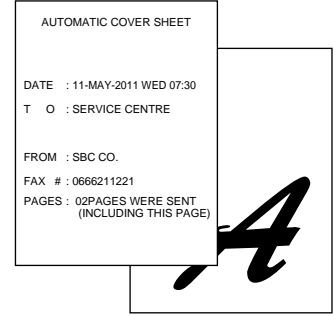
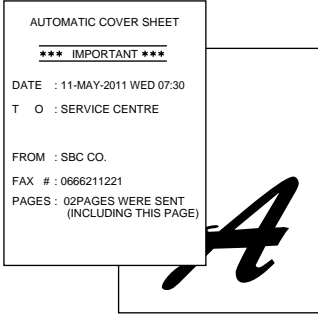
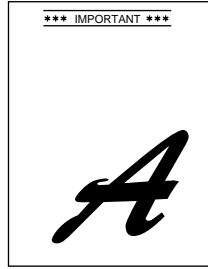
Your machine	The receiving machine		
	Cover sheet / no message	Cover sheet / message	No cover sheet / message
			
Select a cover sheet / message and transmit the fax.	A cover is automatically added and the fax is printed.	The selected message is printed at the top of the cover sheet.	The selected message is printed at the top of the first sheet.

3



- Select this function before each transmission. The selection is only effective for one transmission. After one transmission, the function automatically turns off.
- Before adding a cover sheet, make sure that your sender's name and number have been programmed. (See "OWN PASSCODE SET" on page 101.)
- This function cannot be used when performing a manual transmission, or when using memory polling (page 38), F-code memory polling (page 54), F-code confidential transmission (page 59), or F-code relay request transmission (page 63).
- You can also enable a setting in the system settings to always add a cover sheet to transmissions (see "AUTO COVER SHEET" on page 108).

Selecting a cover sheet / message

1 In Fax mode, press the [SPECIAL FUNCTION] key.

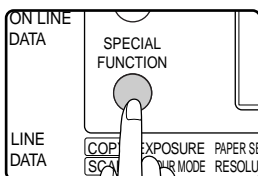

When the [SPECIAL FUNCTION] key is pressed, the special function menu appears. (To select fax mode, see step 1 on page 17.)

2 Select "SENDING MENU" with the [▼] or [▲] key.

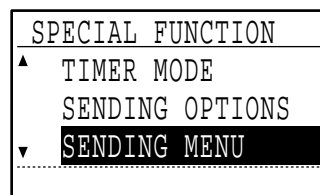
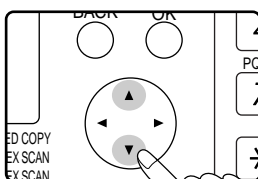

3 Press the [OK] key.

4 To add a cover sheet, select "COVER SHEET" with the [◀] or [▶] key. To add a message, select the desired message with the [▼] or [▲] key.

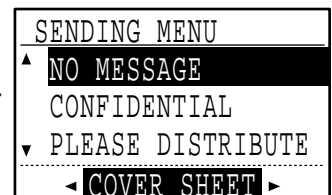
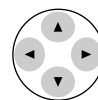

If you do not wish to add a cover sheet, select "NO CVR. SHEET".

If you do not wish to add a message, select "NO MESSAGE".

5 Press the [OK] key.



To cancel the cover sheet selection, press the [*] key instead of the [OK] key in step 3.

USING SETTINGS STORED AS A PROGRAM

This function allows you to store the steps of an operation, including the destination and scanning settings, into a program. This function is convenient when you frequently send documents, such as a daily report, to the same destination. Up to nine programs can be stored.

When storing a program, a name (maximum 36 letters) can be assigned to the program.

For information on storing, editing, and deleting programs, see "STORING, EDITING AND DELETING PROGRAMS" on page 76.

The following settings can be stored in a program:

(1) Transmission method

Normal transmission (page 17), broadcast transmission (page 31), polling (page 35), serial polling (page 37), F-code transmission (page 59), F-code polling (page 57)

(2) Cover sheet / message (page 43)

(3) Resolution and exposure (page 14)

(4) Dual page scan (page 42)

(5) Transmission settings (page 22)

When storing a broadcast transmission or serial polling operation in a program, up to 200 destination fax numbers can be stored.



- A program differs from a timer transmission (page 33) in that it is not cleared from memory after transmission takes place. A program thus allows you to repeatedly perform the same type of transmission. Note, however, that programs do not allow you to establish a timer setting for transmission.
- A setting that can be stored in a program cannot be changed at the time that a program is used for a transmission even if the setting is not stored in the program.
- The only settings that can be selected when using a program are the original size, duplex scanning, and a timer setting.

USING A PROGRAM

1 In fax mode, place the original. (Page 12)

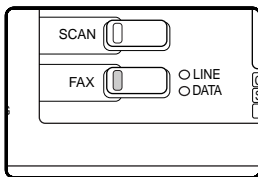

Skip this step if polling, serial polling, or F-code polling is being performed. If you are going to use Dual Page Scan (page 42), place the document on the Document glass.

(To select fax mode, see step 1 on page 17.)

2 Press the [PROGRAM] key.

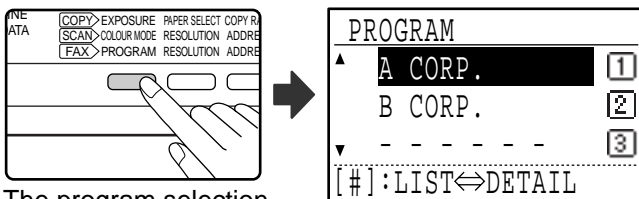

The program selection screen appears.

3 Select the program that you wish to use with the [▼] or [▲] key.

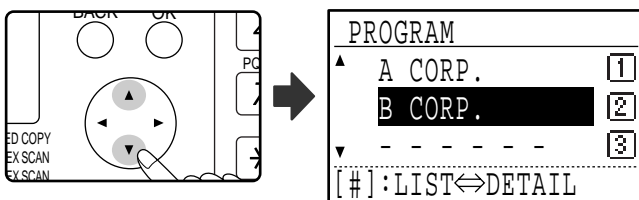

If not all letters of the program name appear, press the [#] key to display all letters. Press the [#] key once again to return to the original screen.

4 Press the [OK] key.

5 If needed, select the original size and other settings, and then press the [START] key (⏻).

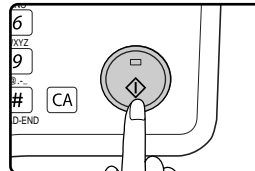

Transmission takes place according to the program.



Select settings that cannot be stored in a program before you press the [START] key (⏻) in step 5. These settings include the original size (see "MANUALLY SETTING THE SCANNING SIZE" on page 13), duplex scanning (see "FAXING A TWO-SIDED ORIGINAL (MX-M182D/MX-M202D/MX-M232D)" on page 21), and a timer setting (see "AUTOMATIC TRANSMISSION AT A SPECIFIED TIME (TIMER TRANSMISSION)" on page 33).

FORWARDING RECEIVED DATA TO A NETWORK ADDRESS (INBOUND ROUTING SETTINGS)

The received fax data can be automatically forwarded to a specified e-mail address. When this function is enabled, you can forward the received data to a specified address without printing it.



- This function is available only when the network expansion kit is installed.
- When a mobile telephone is set as a recipient, data may not be forwarded successfully depending on the type of mobile telephone being used. Check in advance that the data can be sent to the mobile telephone and that it can be displayed correctly.

All Inbound Routing settings are configured in the Web page.

The following explanation assumes that the Web page has been accessed with administrator rights.

To activate Inbound Routing, configure the basic settings before specifying the destination.

CONFIGURING THE BASIC SETTINGS

Configure the basic settings of Inbound Routing.

Enabling the Inbound Routing function

1 In the menu frame, click [Inbound Routing Settings].

3 Click the [Submit] button.

2 Select [Enable] in [Inbound Routing].

Changing the print style of received data

1 In the menu frame, click [Inbound Routing Settings].

3 Click the [Submit] button.

2 Select a print style in [Print Style Setting].

Item	Settings	Description
Inbound Routing	Enable, Disable	Enable or disable the Inbound Routing function.
Print Style Setting	Always Print , Print at Error	Select a print style of received data.

Set a file name for forwarding received data

Select the checkboxes of items used for the file name.

Items Serial Number, Sender Name, Date & Time, Session Page Counter, Unique Identifier, and Characters are assigned to the file name in this order.

To add a desired text string, select the "Characters" checkbox and enter the string in "Preset of Character" using up to 64 characters.

1 In the menu frame, click [Inbound Routing Settings].

3 Click the [Submit] button.

2 Select the item to be used as the file name in "File Name Setting".

Item	Setting (Default)	Description
Serial Number	Not selected	Selecting this checkbox adds the unit serial number to the file name.
Sender Name	Selected	Selecting this checkbox adds the sender name to the file name.
Date & Time	Selected	Selecting this checkbox adds the date and time to the file name.
Session Page Counter	Not selected	Selecting this checkbox adds the counter to the file name.
Unique Identifier	Not selected	Selecting this checkbox adds the unique identifier to the file name.
Characters	Not selected	To add a character string to the file name, select this checkbox and enter the text string in "Preset of Character" using up to 64 characters.
Preset of Character	-	Enter a text string to be used in "Characters" using up to 64 characters.

Setting whether to print the transaction report

Select whether to print the transaction report when forwarding received data.

1 In the menu frame, click [Inbound Routing Settings].

3 Click the [Submit] button.

2 Specify the print condition in "Transaction Report Print Select Setting".

Item	Settings	Description
Transaction Report Print Select Setting	Always Print, Print at Error , Do not Print	Select a print style of the transaction report.

SETTINGS THE DESTINATION

Specify a sending source of received data and forwarding destination e-mail addresses to configure a forwarding table.

Up to 10 forwarding tables can be configured.

For each forwarding table, set the following items:

- Forward Condition (enabling/disabling forwarding, and the conditions to determine forwarding)
- Sender number (fax number)
- Forwarding destinations (e-mail addresses)



- The names of the destination number (Forward destination 1 to 10) cannot be changed.
- Only the e-mail address can be specified for a forwarding destination. FTP, Desktop, and fax number cannot be specified.

Viewing the destination list

1 In the menu frame, click [Inbound Routing Settings].

2 Click [Destination].

The destination list appears.

3

Item	Description
Inbound Routing	Displays whether Inbound Routing function is enabled.
Number	Displays the forwarding destination number (Forward Destination 1 to 10). Each of setup menu is displayed by clicking each number.
Forward Condition	Displays the forward condition of the destination (enabling/disabling and determining the destination setting).
[Delete] button	To delete the forwarding condition stored in a destination number, select the "Number" checkbox of the destination number and click the [Delete] button.
[Clear Checked] button	Clicking this clears all "Number" checkboxes.

Settings the destination

1 In the menu frame, click [Inbound Routing Settings].

2 Click [Destination].

The destination list appears.

3 Click the destination number to be set.

The "Forwarding Destination" screen appears.

4 Select [Enable] in "Forward Condition".

5 In "Forward Condition", select the determining condition for forwarding.

Select [Forward (All)] or [Forward (Sender)].

6 If you wish to forward received data from a specific sender, enter the sender's fax number in "Sender Number".

Enter the fax number using up to 20 digits. To enter the fax number from the fax addresses stored in the machine, click the [Select from Address Book] button. The "Fax Destination" screen appears, and you can select the sender's number from the fax address list.

7 Enter the destination e-mail address in "Forward Destination (Max.5)".

Up to five e-mail addresses can be specified as the destination.

Three types of methods are available for entering the destination. The set e-mail addresses are displayed in "Forwarding Destination Settings".

- Entering an e-mail address directly
Click the [Direct Entry] button. When the "Forwarding Destination Settings (Direct Entry)" appears, enter an e-mail address and click the [Submit] button. The e-mail address can include up to 64 single-byte characters.
- Selecting an e-mail address from the global address book
Click the [Global Address Search] button. The "Global Address Search" screen appears.
You can select an e-mail address from the global address book.
- Selecting an e-mail address from the address book
Click the [Select From Address Book] button. The "Destination List" screen appears, and you can select an e-mail address from the e-mail address list.



To delete a set e-mail address, select the checkbox at the left of the e-mail address you wish to delete, and then click the [Delete] button.

8 Click the [Submit] button.

This stores the setting.

Forward Condition

Item	Settings	Description
Forward Condition	Enable, Disable	Enable or disable the destination to be set in this screen.
	Forward (All) , Forward (Sender)	Select the determination condition for forwarding the received FAX data.

Sender Number

Item	Description
Fax No.	Enter the sender's fax number if you have selected "Forward (Sender)" in "Forward Conditions" setting. Up to 20 digits can be entered.
[Select From Address Book] button	Click this button to select the fax number from the fax addresses stored in this machine.

Forward Destination (Max. 5)

Item	Description
Forwarding Destination Settings	Displays the stored destinations. If no destination is stored, "Not Set" appears.
[Delete] button	Deletes the selected destination.
[Direct Entry] button	Click this button to enter an e-mail address directly.
[Global Address Search] button	Click this button to select an e-mail address from the global address book.
[Select From Address Book] button	Click this button to select an e-mail address from the e-mail address list stored in the machine.

FORWARDING RECEIVED FAXES TO ANOTHER MACHINE WHEN PRINTING IS NOT POSSIBLE (FORWARDING FUNCTION)

When printing is not possible because of a paper, toner, or other problem, you can forward received faxes to another fax machine if that machine has been appropriately programmed in your machine. This function can be conveniently used in an office or other workplace where there is another fax machine connected to a different phone line. When a fax has been received to memory, the DATA indicator above the [FAX] key (see "If received data cannot be printed" on page 28) to blinks.

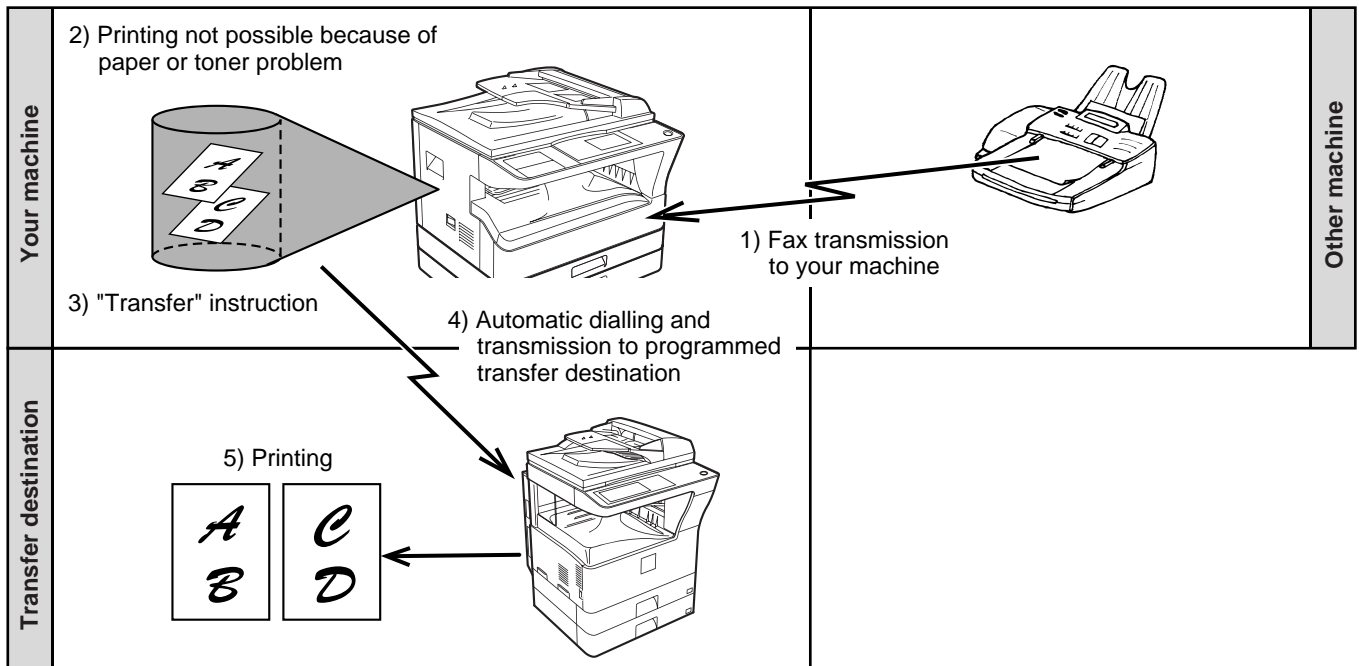

3



- All received faxes are forwarded; a particular fax cannot be selected for forwarding. A fax received to a confidential box (see "F-CODE CONFIDENTIAL TRANSMISSION" on page 59) cannot be forwarded.
- Faxes that have been received to memory by the fax print hold function (page 29) are also forwarded.
- The result of forwarding is indicated in the activity report (see "VIEWING THE COMMUNICATION ACTIVITY REPORT AT REGULAR INTERVALS (Communication activity report)" on page 92).

USING THE FORWARDING FUNCTION

Programming the fax number of the forwarding destination

The number of the forwarding destination is programmed in the system settings (see "RECEIVED DATA FW. STATION SET" on page 110). Only one fax number can be programmed. The forwarding function cannot be used unless a number is programmed.

Forwarding received faxes

1 Make sure that the machine is in fax mode.

When the machine is in fax mode, the FAX indicator is lit. If the light is not on, press the [FAX] key.

2 Press the [SPECIAL FUNCTION] key.

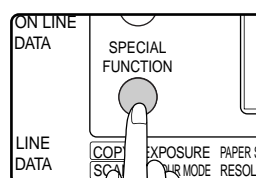

Press the [SPECIAL FUNCTION] key to display the special function menu.

3 Select "RX DATA TRANSFER" with the [▼] or [▲] key.

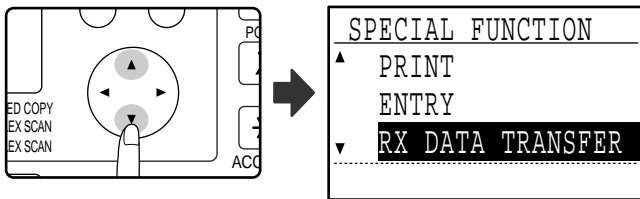

4 Press the [OK] key.

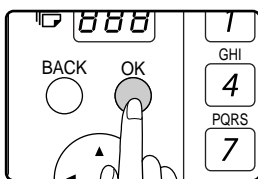

5 Select "TRANSFER" with the [◀] or [▶] key.

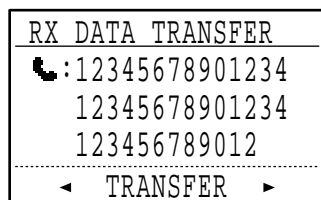
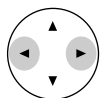

To cancel forwarding, select "NO TRANSFER".

6 Press the [OK] key.



The machine automatically dials the forwarding number programmed in the system settings and begins forwarding the fax or faxes.

Note

- **To cancel a forwarding operation**
Press the [FAX STATUS] key, and then cancel forwarding in the same way as a regular fax transmission. (See "CANCELLING A FAX TRANSMISSION" on page 25.) The fax(es) that was going to be forwarded will return to print standby status in your machine.
- If forwarding is not possible because the other machine is busy or a transmission error occurs, recall attempts will be made according to the recall times setting. If forwarding is still not successful after the set number of recall attempts are made, the fax(es) will return to print standby status in your machine.
- When forwarding is performed, all faxes that have been received in memory to that point are forwarded. The page that was being printed when the problem occurred and all following pages will be forwarded.
- After a fax is forwarded, the fax data is automatically cleared from memory.

SENDING A FAX DIRECTLY FROM A COMPUTER (PC-Fax)

A document in a computer can be transmitted via the machine as a fax. Faxes are sent using the PC-Fax function in the same way as documents are printed. Select the PC-Fax driver as the printer driver on your computer and then select the Print command in the software application. Image data for transmission will be created and sent as a fax.

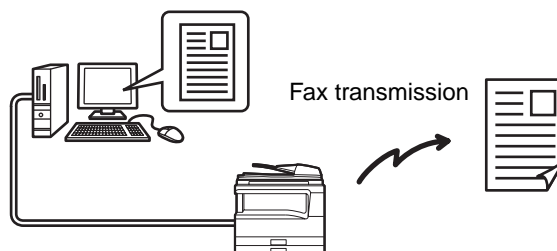

For more information on using the PC-Fax function, see the "Operation Guide" that is installed along with the PC-Fax driver.

Note

- To use the PC-Fax function, the PC-Fax driver must be installed. For more information, see "INSTALLING THE PC-FAX DRIVER (THAT ACCOMPANIES THE MACHINE)" on page 51.
- This function can only be used on a Windows® computer.
- This function can only be used for transmission. Faxes cannot be received to your computer.

INSTALLING THE PC-FAX DRIVER (THAT ACCOMPANIES THE MACHINE)



- The PC-Fax driver uses the printer driver port. Before installing the PC-Fax driver, be sure to install the MFP driver (printer/scanner).
- To install this software, you must have administrator's rights.

1 Insert the "Software CD-ROM" that accompanies the machine into your computer's CD-ROM drive.

2 Click the "Start" button, click "Computer", and then double-click the CD-ROM icon ().

- In Windows XP, click the "start" button, click "My Computer", and then double-click the CD-ROM icon.
- In Windows 2000, double-click "My Computer", and then double-click the CD-ROM icon.

3 Double-click the [Setup] icon ().



If the language selection screen appears after you double click the [Setup] icon, select the language that you wish to use and click the [Next] button. (Normally the correct language is selected automatically.)

4 The "SOFTWARE LICENSE" window will appear. Make sure that you understand the contents of the license agreement and then click the [Yes] button.

5 Read the message in the "Welcome" window and then click the [Next] button.

6 Click the [Custom] button.

When MX-NB12 is installed

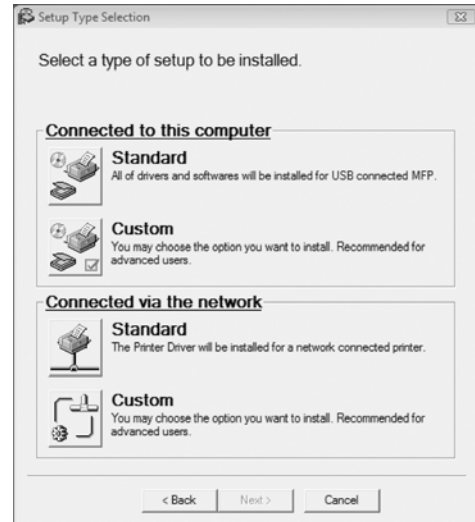

Standard

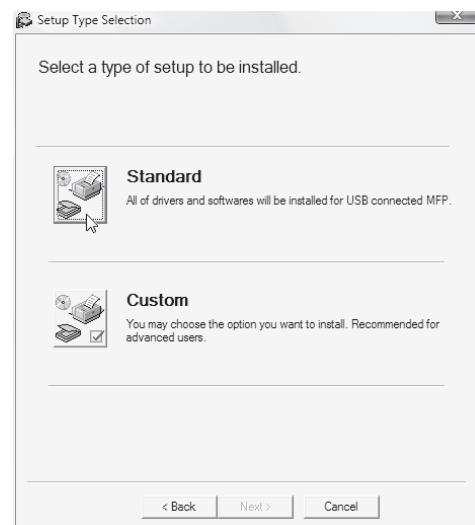

7 Click the [Utility Software] button.

8 Click the [PC-Fax Driver] button.

In the port selection screen that appears when the PC-Fax driver is being installed, select the same port as the Printer driver that is already installed.

9 When installing is finished, click the "Close" button.

3

4

TRANSMISSION USING F-CODES

This chapter explains F-code transmission, which gives you a convenient means of performing advanced operations such as relay broadcast transmission and confidential transmission. Please read those sections that are of interest to you.

COMMUNICATION BETWEEN MACHINES SUPPORTING F-CODES

This machine supports the "F-code" standard as established by the ITU-T*.

Operations such as relay broadcast transmission and confidential transmission previously could only be performed with another Sharp fax machine; however, F-Code communication makes it possible to perform these operations with fax machines of other manufacturers that support F-Code communication.

Before using the functions explained in this chapter, make sure that the other fax machine supports F-Code communication and has the same functions as your machine. (Note that the other machine may use different names for some functions.)

* The ITU-T is a United Nations organization that establishes communications standards. It is a department of the International Telecommunication Union (ITU), which coordinates global telecommunications networks and services.

BOXES AND SUB-ADDRESSES/PASSCODES REQUIRED FOR F-CODE TRANSMISSION

"Boxes" can be created in the memory of fax machines that support F-Code communication. These boxes are used to store faxes received from other machines and documents to be transmitted when a polling request is received. Up to 30 boxes can be created for a variety of purposes, and a name can be assigned to each box. A "sub-address" that indicates the box's location in memory must be programmed, and if desired, a passcode can also be programmed to control access to the box. (A sub-address must be programmed, however, a passcode can be omitted.)

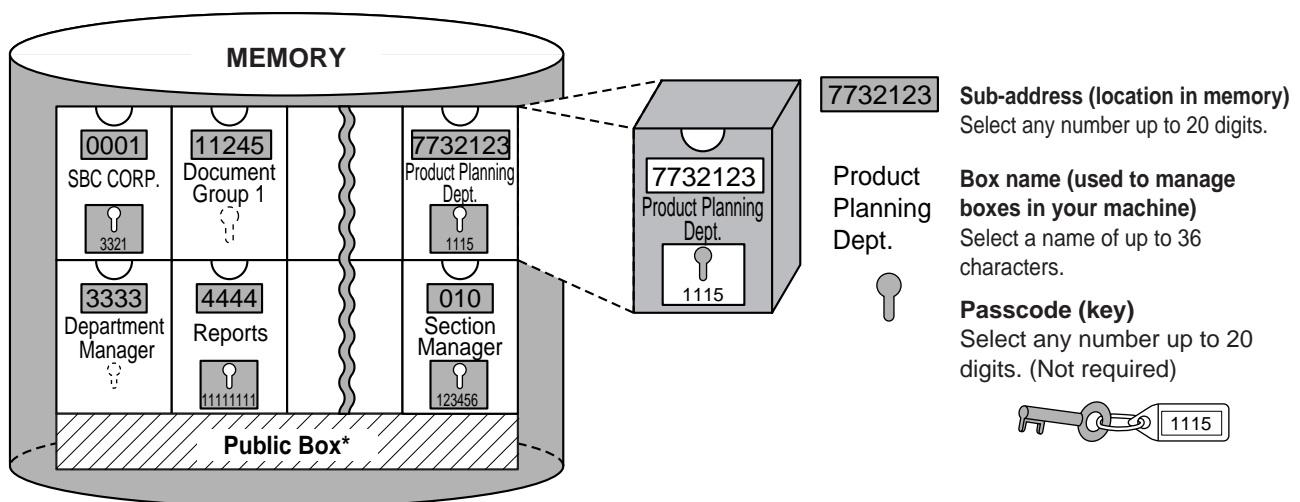

*The public box is used for normal memory polling. (See "USING POLLING MEMORY" on page 38.)

When communication occurs involving a box, the communication will only take place if the sub-address and passcode that the other machine sends match the sub-address and passcode programmed in your machine for that box. Therefore, to allow communication, you must inform the other party of the sub-address and passcode of the box. Likewise, to send a fax to a box in another machine or use polling to retrieve a document from a box, you must know the sub-address and passcode of that box. (Note that assigning names simply makes it easier to manage boxes; you do not need to inform the other party of a box name.) However, you must inform the other party of the sub-address and passcode for a box.

This machine uses the term "sub-address" for the location of the memory box and the term "passcode" for the password that allows communication; however, other fax machines of other manufacturers may use different terms. When asking the other party for a sub-address and passcode, you may find it useful to refer to the 3-character alphabetical terminology used by the ITU-T.

Your machine	ITU-T		
	F-code polling memory box	F-code confidential box	F-code relay broadcast function
Sub-address	SEP	SUB	SUB
Passcode	PWD	SID	SID

CREATING A BOX FOR F-CODE TRANSMISSION

F-code operations that use boxes include F-code polling memory (page 54), F-code confidential transmission (page 59), and F-code relay broadcast transmission (page 62).

A box is created by programming a name for the box, and up to 10 boxes for each operation type can be created.

The information programmed in each box varies slightly depending on the type of operation. For information on programming, editing, and deleting boxes, see "PROGRAMMING, EDITING, AND DELETING F-CODE MEMORY BOXES" on page 78.

After you have programmed a box, inform the other party of the box's sub-address and passcode.



If you attempt to create a box when 10 boxes have already been created for that operation type, a message will appear and you will not be able to create the box. Delete any unused boxes and then create the new box. (See "PROGRAMMING, EDITING, AND DELETING F-CODE MEMORY BOXES" on page 78.)

F-CODE POLLING MEMORY

F-code polling memory allows one fax machine to call another fax machine and initiate reception of a document that has been scanned into the other machine's F-code polling memory box. Calling another machine and initiating reception is called F-code polling, and scanning a document into a memory box for another machine to retrieve by polling is called F-code polling memory. This function is approximately the same as regular polling (page 35); however, it uses an F-code polling memory box and is always protected by means of the sub-address and passcode.

HOW F-CODE POLLING MEMORY WORKS

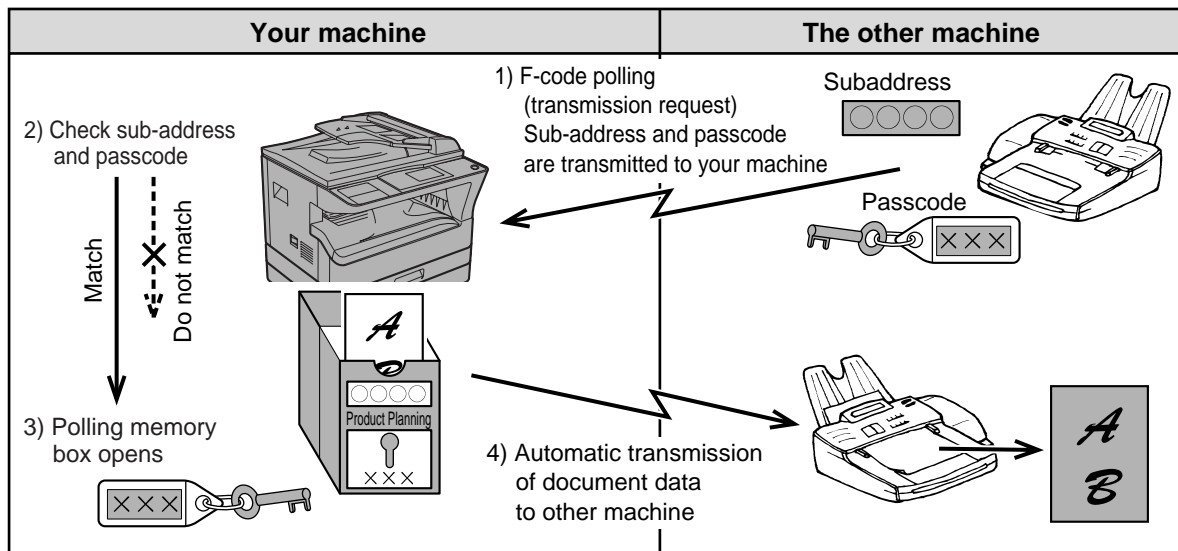

F-code polling (page 57) is when your machine calls another machine and retrieves a document that was scanned into the polling memory box of that machine (the reverse of the above diagram).

Note

- To perform polling or polling memory transmission without using an F-code, see page 35.
- To create an F-code polling memory box, see "PROGRAMMING F-CODE PUBLIC (POLLING MEMORY) BOXES" (page 81) and "Scanning a document into polling memory (the Public Box)" (page 38).
- Unlike regular polling, the other machine's fax number is not used as a passcode for F-code polling memory. The sub-address and passcode of the polling memory box are always used for polling security.
- The receiving machine bears the expense (phone charges) of the transmission.

USING F-CODE POLLING MEMORY

In order for another machine to retrieve a document from your machine, you must first scan the document into the F-code polling memory box.

You can check the document in the memory polling box by printing it out.
(See "Checking and clearing document data in a box" on page 56.)



When using F-code polling memory, do not set the reception mode to manual reception.

Scanning a document into an F-code polling memory box

The procedure for scanning a document into an F-code polling memory box (page 81) is in general the same as "Scanning a document into polling memory (the Public Box)" on page 38.

1 Perform steps 1 through 4 of "Scanning a document into polling memory (the Public Box)" (page 38).

2 Select "S.A.M-POLL ORIG" with the [▼] or [▲] key.

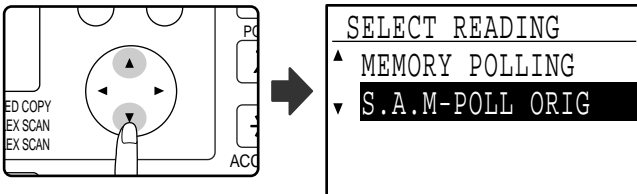

3 Press the [OK] key.

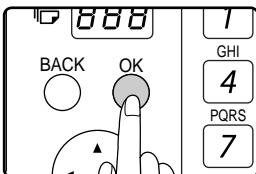

4 Select the name of the polling memory box with the [▼] or [▲] key.

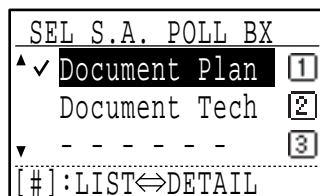
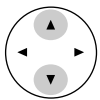

If not all letters of the programmed name appear, press the [#] key to display all letters. Press the [#] key again to return to the previous display.

About the steps that follow

See steps 6 through 10 in "Scanning a document into polling memory (the Public Box)" (pages 38 to 39). Where "public box" (page 38) appears in the procedure, substitute "F-code polling memory box".

Checking and clearing document data in a box

The procedures for checking document data in an F-code polling memory box by printing the data and for clearing the data are generally the same as in "Printing documents in the Public Box" (page 39) and "Deleting documents from the Public Box" (page 40).

1 Perform steps 2 through 4 of "Scanning a document into polling memory (the Public Box)" on page 38.

2 Select "S.A.M-POLL ORIG" with the [▼] or [▲] key.

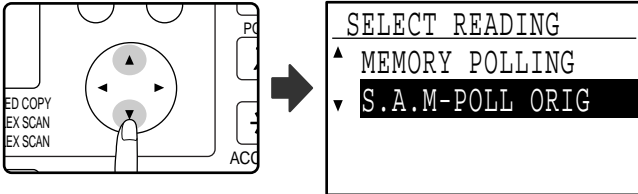

3 Press the [OK] key.

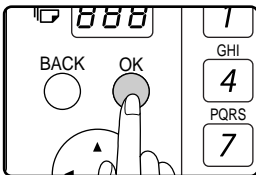

4 Select the name of the F-code memory polling box with the [▼] or [▲] key.

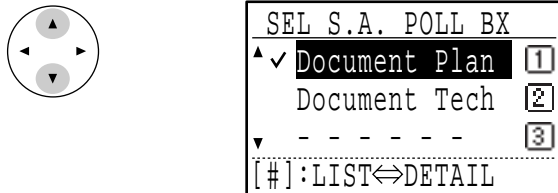

A checkmark appears next to the box name of boxes that have document data.

If not all letters of the programmed name appear, press the [#] key to display all letters. Press the [#] key again to return to the previous display.

5 Press the [OK] key.



6 Select "PRINT" or "DELETE" with the [▼] or [▲] key.

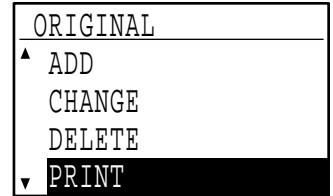

If you selected "PRINT", press the [OK] key to begin printing.

If you selected "DELETE", go to step 7.

7 Press the [OK] key.



A screen appears asking you to confirm the deletion.

8 Select "YES" with the [▼] or [▲] key.



To cancel the deletion, select "NO".

9 Press the [OK] key.



The documents are deleted from the F-code polling memory box.



Deletion is not possible while the box is being used.

PROCEDURE FOR F-CODE POLLING

Make sure that a document has not been placed in the document feeder tray or on the document glass, and then follow the steps below.



- You must know the sub-address (SEP) and passcode (PWD) of the other machine's F-code polling memory box.
- Serial polling (selecting multiple fax machines to be polled using a group key, Rapid keys, and Speed Dial numbers) is not possible when using F-code polling.

1 In Fax mode, press the [SPECIAL FUNCTION] key.

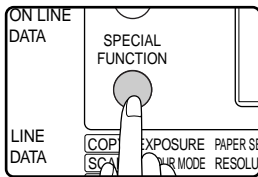

When the [SPECIAL FUNCTION] key is pressed, the special function selection screen appears.
(To select fax mode, see step 1 on page 17.)

2 Select "SENDING OPTIONS" with the [▼] or [▲] key.

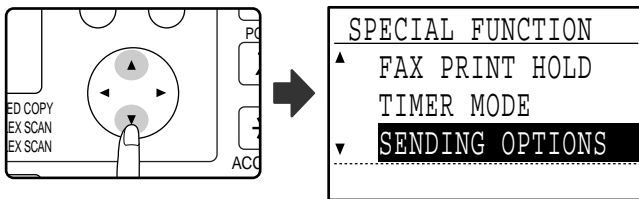

3 Press the [OK] key.

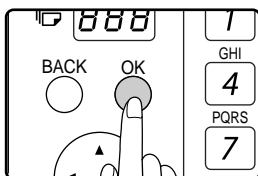

4 Select "SUB ADD POLLING" with the [▼] or [▲] key.

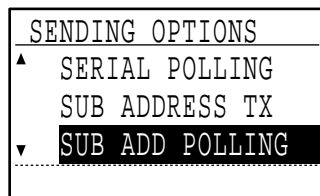
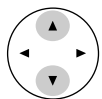

5 Press the [OK] key.



6 Enter the fax number of the other machine with the numeric keys, or press a Rapid key, or dial a Speed Dial number (a group key cannot be used).

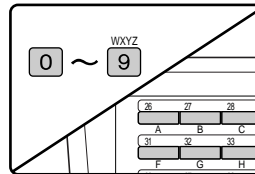

To clear a mistake when entering a number with the numeric keys, press the [C] key to clear one digit at a time.

A destination selected with a Rapid key or Speed Dial number is indicated by an icon and a number. To clear an entry, press the [C] key.

7 Press the [OK] key.



8 Enter the sub-address (up to 20 digits) with the numeric keys.



- Characters that can be entered are numbers, "#", and spaces. However, the initial character cannot be a space.
- If you make a mistake, press the [C] key and re-enter the correct digit(s).
- If you specified a Rapid key or Speed Dial number in step 6 that has a sub-address programmed, the sub-address will appear. Go to the next step without entering a sub-address.

9 Press the [OK] key.



4

10 Enter a passcode (maximum 20 digits) with the numeric keys.



- Characters that can be entered are numbers, "#", and spaces. However, the initial character cannot be a space.
- If you make a mistake, press the [C] key and re-enter the correct digit(s).
- If the other machine has not programmed a passcode, omit the passcode and go to the next step.
- If you specified a Rapid key or Speed Dial number in step 6 that has a passcode programmed, the passcode will appear. Go to the next step without entering the passcode.

11 Press the [OK] key.



12 Press the [START] key (⏻).

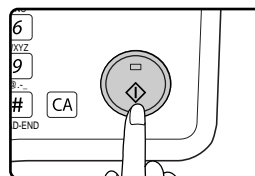

After communicating with the other machine, your machine will print the received document.



To cancel the operation

- During communication: Cancel as explained in "Cancelling a fax transmission" on page 25.
- While the job is stored: Cancel as explained in "Cancelling a stored transmission job" on page 26.
- Only one F-code polling operation with a timer setting (page 33) can be stored.

F-CODE CONFIDENTIAL TRANSMISSION

F-Code confidential transmission provides a secure means of faxing confidential documents. The sub-address and passcode programmed in the box restrict the recipients of the fax, and once received in the box, the fax can only be printed by someone who knows the print passcode.

This function is convenient when sending important documents that you only want a specific person to see, or when multiple departments share a single fax machine.

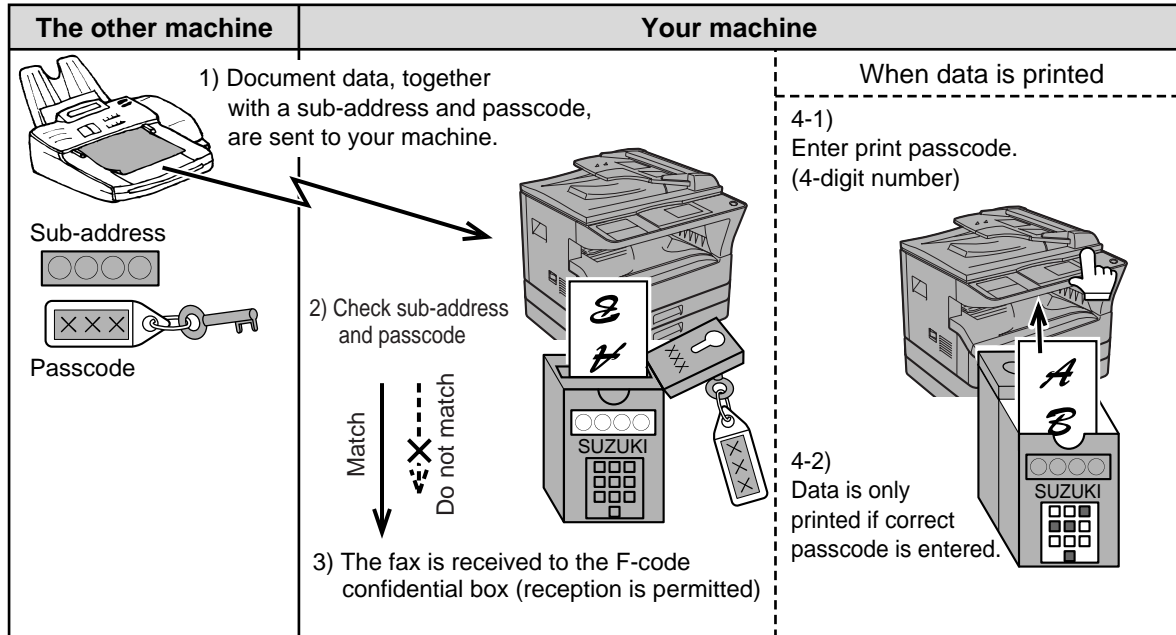

As the above diagram shows, receiving faxes to the machine's F-code confidential memory box is called F-code confidential reception, and sending faxes to another machine's F-code confidential memory box is called F-code confidential transmission.

Note

- This machine does not support Sharp's previous confidential transmission function, which uses the programmed sender's fax number and ID code.
- See pages 78 through 82 for the procedures for creating, editing, and deleting F-code confidential memory boxes.
- Take care not to forget the print passcode that is programmed in the F-code confidential box. If you forget the passcode, consult your Sharp dealer.

F-CODE TRANSMISSION (F-CODE CONFIDENTIAL TRANSMISSION)

To perform F-code confidential transmission, you must enter the sub-address (SUB) and passcode (SID) after the fax number of the receiving machine. (Omit the passcode if the other machine does not use a passcode. To receive a fax sent by F-code confidential transmission (this is called F-code confidential reception), you must inform the sending party of the sub-address (SUB) and passcode (SID) of your confidential box. (Omit the passcode if a passcode is not programmed in the box.)

Note

An F-code confidential transmission can be used in combination with the broadcast transmission function (page 31) or the timer transmission function (page 33), and can be stored as a program (page 76).

F-code confidential transmission

1 Follow steps 1 to 4 of "BASIC PROCEDURE FOR SENDING FAXES" (page 17) and then follow the steps below.

2 Press the [SPECIAL FUNCTION] key.

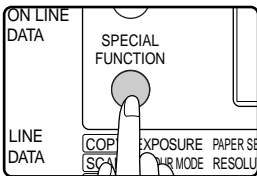

When the [SPECIAL FUNCTION] key is pressed, the special function selection screen appears.

3 Select "SENDING OPTIONS" with the [▼] or [▲] key.

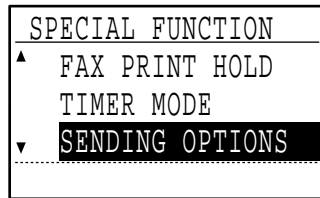
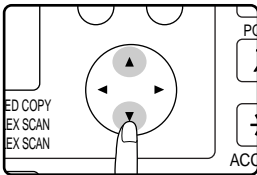

4 Press the [OK] key.

5 Select "SUB ADDRESS TX" with the [▼] or [▲] key.

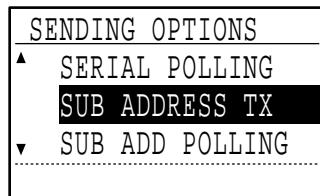
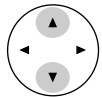

6 Press the [OK] key.

7 Enter the fax number of the other machine with the numeric keys, or press a Rapid key, or dial a Speed Dial number (a group key cannot be used).

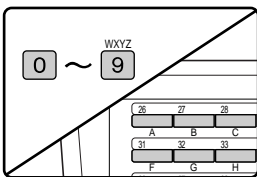

To clear a mistake when entering a number with the numeric keys, press the [C] key to clear one digit at a time.

A destination selected with a Rapid key or Speed Dial number is indicated by an icon and a number. To clear an entry, press the [C] key.

8 Press the [OK] key.

9 Enter the sub-address (maximum 20 digits) with the numeric keys.



- Characters that can be entered are numbers, "#", and spaces. However, the initial character cannot be a space.
- If you make a mistake, press the [C] key and re-enter the correct digit(s).
- If you specified a Rapid key or Speed Dial number in step 7 that has a sub-address programmed, the sub-address will appear. Go to the next step without entering a sub-address.

10 Press the [OK] key.

11 Enter the passcode (maximum 20 digits) with the numeric keys.



- Characters that can be entered are numbers, "#", and spaces. However, the initial character cannot be a space.
- If you make a mistake, press the [C] key and re-enter the correct digit(s).
- If you specified a Rapid key or Speed Dial number in step 7 that has a passcode programmed, the passcode will appear. Go to the next step without entering the passcode.

12 Press the [OK] key.

13 Press the [START] key (⊙).

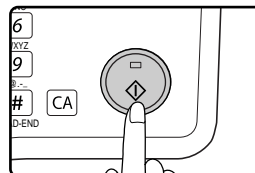

- Scanning begins.
- If you are scanning from the document glass and have another page to scan, change pages and press the [START] key (⊙). Repeat until all pages have been scanned and then press the [#] key.

PRINTING A DOCUMENT RECEIVED TO AN F-CODE CONFIDENTIAL MEMORY BOX

Faxes received in an F-code confidential memory box are printed out by entering the 4-digit print passcode (0000 to 9999) that was programmed when the box was created.



- Make sure that a Transaction Report is set to print out in the system settings so that you will be informed when a confidential document is received. (See "PRINT SELECTION (CONF. RECEPTION)" in "LIST SETTING" on page 99.)
- Faxes received to an F-code confidential memory box are automatically cleared after printing.
- When a new fax is received to an F-code confidential box while a previously received fax is still stored in the box, the new fax is appended after the previous fax.

1 In fax mode, press the [SPECIAL FUNCTION] key.

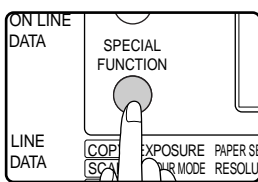

When the [SPECIAL FUNCTION] key is pressed, the special function selection screen appears. (To select fax mode, see step 1 on page 17.)

2 Select "PRINT" with the [▼] or [▲] key.

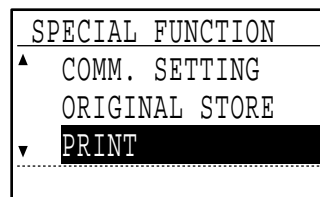
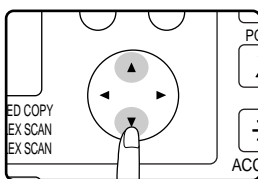

3 Press the [OK] key.

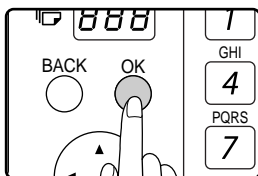

4 Select "CONF. RX DATA" with the [▼] or [▲] key.

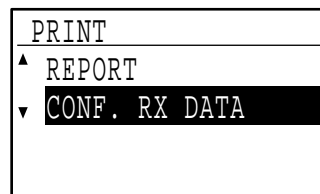
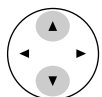

5 Press the [OK] key.



6 Select the name of the F-code confidential box with the [▼] or [▲] key.

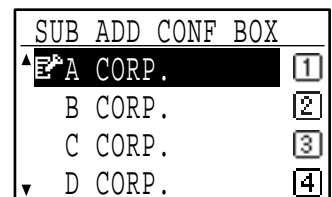

4

An icon (☒) appears next to each box that is holding a received fax.

7 Press the [OK] key.



If no faxes have been received to the F-code confidential box, "No confidential receiving data." will appear briefly.

8 Enter the 4-digit passcode with the numeric keys.

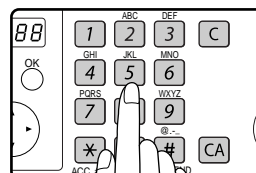

- If you make a mistake, press the [C] key and re-enter the correct digit(s).
- When the 4-digit passcode is correctly entered, printing begins.



If received faxes remain in an F-code confidential memory box, the box cannot be deleted.

F-CODE RELAY BROADCAST TRANSMISSION

The F-Code relay broadcast function allows the machine to act as a relay machine for a broadcast transmission. The end receiving machines are stored in the machine's F-Code relay memory box, and when the machine receives a relay request from another F-Code machine, it will relay the fax to all of the stored end receiving machines. The relay machine and the originating machine that requests the relay transmission must both support F-codes; however, the end receiving machines programmed in the F-code relay broadcast memory box do not need to support F-codes.

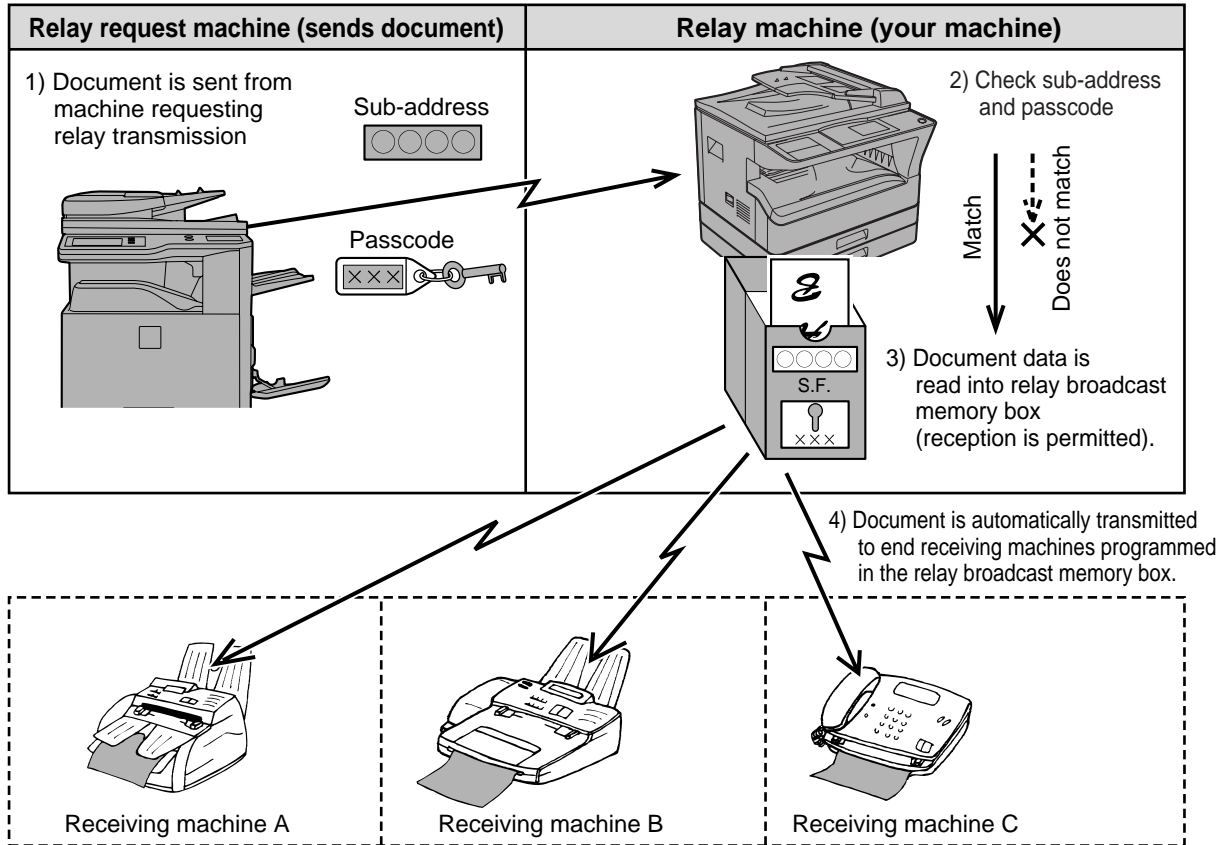

The machine that originally sends the document is called the relay request machine, and the machine that has a memory box containing the end receiving machines and which relays the received document to those machines is called the relay machine.

The relay machine also prints the document sent by the relay request machine.

For example, corporate headquarters in Seattle wants to send the same document to branch offices in San Francisco, Oakland, Berkeley, and San Jose. If the San Francisco office creates a relay broadcast memory box and programs the Oakland, Berkeley, and San Jose offices as end receiving destinations, the overall phone charges will be lower than if the Seattle office uses the regular broadcast transmission function (page 31). If used together with a timer setting (page 33) to take advantage of off-peak rates, the cost of transmission can be further reduced.

Transmission by the relay machine is called "F-code relay broadcast transmission", and transmission from the relay request machine to the relay machine is called "relay request transmission".

Note

- This machine does not support Sharp's previous relay broadcast function, which uses the programmed sender's number and relay ID code.
- Up to 10 F-code relay groups (boxes) can be programmed. A name (up to 36 characters long) and the end receiving machines are programmed in each box. A combined total of 120 end receiving machines can be programmed in all F-code relay groups (boxes). (If 120 end receiving machines are programmed in one F-code relay group, no end receiving machines can be programmed in other F-code relay groups.)
- End receiving machines can be stored using the numeric keys, Rapid keys, Speed Dial numbers, and group keys. Auto-dial destinations that already have a sub-address and passcode programmed cannot be used.
- Only one relay group can be specified when making a relay request. Multiple relay groups cannot be simultaneously selected.
- To create an F-code relay group (box) and store, edit, and delete end receiving machines, see pages 78, 80 and 83. When creating a box, a passcode (SID) can be omitted.
- The relay request machine only bears the expense of sending the document to the relay machine. The relay machine bears the expense of sending the document to each of the end receiving machines.

USING THE F-CODE RELAY BROADCAST FUNCTION (your machine is the relay machine)

When a document is received from a relay request machine, the F-code relay broadcast function transmits the document to the end receiving machines using a memory box only if the sub-address and passcode sent by the relay request machine are correct.

To create, edit, or delete an F-code relay group (box), see pages 78, 80 and 83.

A document received from a relay request machine is initially stored in the box of your machine. Your machine (the relay machine) also prints the document, thus the document is first stored as a print job and then as transmission jobs to each of the programmed end receiving machines. The document data is automatically cleared after transmission to all end receiving machines is completed.

Transmission to the end receiving machines cannot be stopped or cancelled.

USING THE F-CODE RELAY REQUEST FUNCTION (your machine requests a relay broadcast)

Ask the operator of the other F-code machine (the relay machine) to create an F-code relay group (box) that contains the end receiving machines to which you wish to send a fax, and ask for the sub-address (SUB) and passcode (SID) of that box.

When you dial the relay machine to send the fax, enter the sub-address and passcode after the fax number. The fax will be stored in the relay machine's memory box, and the relay machine will call each of the programmed end receiving machines and relay the fax to those machines. (If a passcode (SID) is not programmed in the box, enter only the sub-address when dialling.)

To dial the relay machine, use the same procedure as in "F-CODE TRANSMISSION (F-CODE CONFIDENTIAL TRANSMISSION)" (page 59).

5

CONVENIENT METHODS OF USE

This chapter explains convenient functions that can be used when sending a fax, connecting an extension phone, and other features that expand the scope of use of the fax machine. Please read those sections that are of interest to you.

CONNECTING AN EXTENSION PHONE

You can connect a telephone to the machine and use it as an extension phone to make and receive calls like any normal phone. Fax reception can also be activated from an extension phone connected to the machine. (Remote operation)



If you connect a combination telephone/answering machine to the machine, you will not be able to use the answering machine function.

USING AN EXTENSION PHONE

Using an extension phone for voice calls

An extension phone connected to the machine can be used to place and receive voice calls just like a normal phone.



- If the fax reception mode is set to auto reception, you must lift the phone to answer a call before the machine automatically begins reception. The machine is initially set to answer calls on two rings. The number of rings can be changed to any number from 0 to 9 in the system settings. (See "#OF RINGS AT. RX" on page 108.)
- If you cannot hear a dial tone when you pick up the extension phone, the machine is sending or receiving a fax. Replace the phone.

Activating fax transmission

Place the original on document glass or in the SPF/RSPF, adjust the original size, resolution, and exposure settings as needed, and then follow the steps below.

1 Lift the extension phone and call the receiving party.

2 Press the [START] key (Ⓢ).

3 Select "TX" with the [▼] or [▲] key and then press the [OK] key.

4 Replace the phone.

SETTING THE RECEPTION MODE

The machine normally receives faxes automatically after ringing; however, when an extension phone is connected, you can set the reception mode to MANUAL. This will allow you to talk to the other party first and then receive a fax. This is convenient when you only have one telephone line and receive more voice calls than faxes. You must answer all calls on the extension phone, and activate fax reception after you verify that a call is a fax transmission.

1 Press the [COMM. SETTING] key in the initial state of Fax mode.

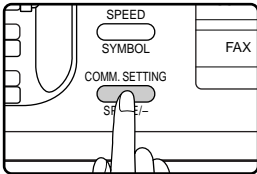

2 Select "RX" with the [▼] or [▲] key.

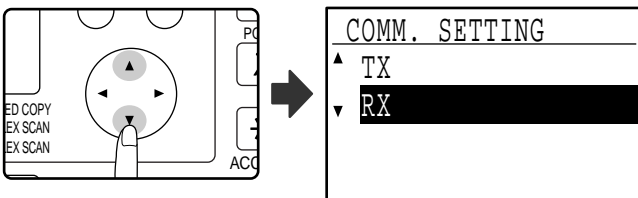

3 Press the [OK] key.

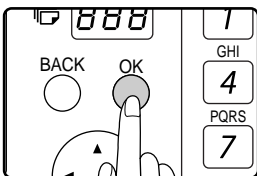

4 Select "AUTO" or "MANUAL" with the [▼] or [▲] key.

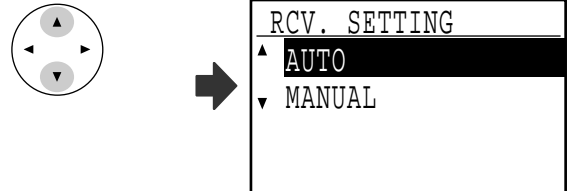

5 Press the [OK] key.



5

Activating fax reception from an extension phone (remote reception)

After receiving a call on the extension phone, you can activate fax reception from the extension phone. This is called "remote reception". After speaking, or when you hear a fax tone through the extension phone, perform the following procedure with the extension phone still lifted. (If you made the call, remote reception will not be possible.)



The following procedure is not possible if you are on a pulse dial line and your extension phone cannot produce tone signals. To find out whether your extension phone can produce tone signals, refer to the manual for your extension phone.

1 If you are on a pulse dial line, set your phone to issue tone signals.

Refer to your phone's manual to set the phone to issue tone signals.
If your phone is already set to issue tone signals, proceed to the next step.

2 Press the **5** key once and the ***** key twice on the extension phone.

Fax reception is activated.

3 Replace the extension phone.



The one-digit number that is used to activate fax reception from an extension phone (initially set to "5") is called the "remote reception number". You can change this number to any number from 0 to 9 in the system settings. (See "REMOTE RECEPTION" on page 102.)

6

PROGRAMMING

This chapter explains the procedures for programming auto dial keys (Rapid keys, Speed Dial numbers, and group keys), programs, and F-code operations, and how to print out lists of programmed information.

PROGRAMMING

Auto dial numbers (Rapid keys, Speed Dial numbers, and group keys), programs, and F-code operations are stored and edited at the operation panel of the machine. This chapter explains how to use the operation panel for these procedures.

STORING, EDITING, AND DELETING AUTO DIAL NUMBERS AND PROGRAMS

This section explains the procedures for storing, editing, and deleting auto-dial numbers (Rapid keys, Speed Dial numbers, and group keys) and programs, which simplify the transmission procedure. To use Rapid keys, Speed Dial numbers, and group keys, see "TRANSMISSION BY AUTO-DIALLING (RAPID DIALLING AND GROUP DIALLING)" on page 19. To use a program, see "USING A PROGRAM" on page 44.

A combined total of 50 Rapid keys and group keys can be stored, 300 Speed Dial numbers, and 9 programs can be stored. If you attempt to store more than this, a warning message will appear. In this case, delete any auto-dial numbers or programs that are no longer needed (see page 73 to delete Rapid keys and Speed Dial numbers, page 75 to delete group keys, and page 77 to delete programs), and then store the new auto-dial number or program.



To cancel a storing, editing, or deleting operation, press the [CA] key. You will return to the base screen.

STORING, EDITING, AND DELETING AUTO-DIAL NUMBERS (RAPID KEYS, SPEED DIAL NUMBERS, AND GROUP KEYS)

Auto dial numbers are stored in the auto dial storing screen. Follow the steps below to display the auto dial storing screen, and then store an auto dial number.

1 In Fax mode, press the [SPECIAL FUNCTION] key.

Begin the following procedure from the base screen of Fax mode.

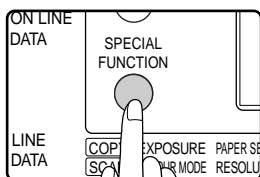

When the [SPECIAL FUNCTION] key is pressed, the function selection menu appears.

(To select fax mode, see step 1 on page 17.)

2 Select "ENTRY" with the [▼] or [▲] key.

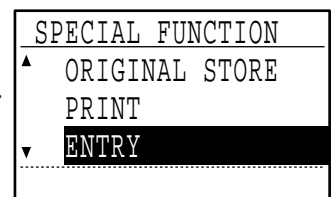
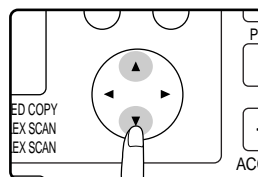

3 Press the [OK] key.

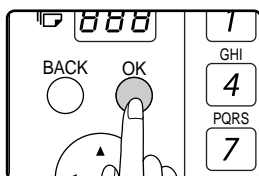

4 Select "DIAL" with the [▼] or [▲] key.

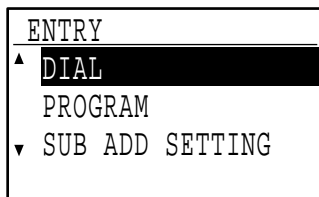
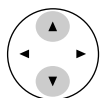

5 Press the [OK] key.



6 Select "RAPID/SPEED", "GROUP", or "CHANGE/DELETE" with the [▼] or [▲] key.

- To store an Rapid key or Speed Dial number, select "RAPID/SPEED" and press the [OK] key. Next, follow the steps in "Storing a Rapid keys and Speed Dial numbers" at right.

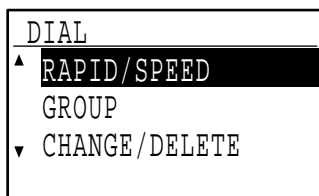

- To store a group key, select "GROUP" and press the [OK] key. Next, follow the steps in "Storing a group key" on page 71.

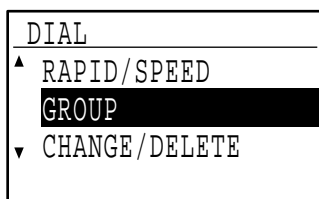

- To edit or delete a Rapid key, Speed Dial number, or group key, select "CHANGE/DELETE" and press the [OK] key. Next, follow the steps in "Editing and deleting auto-dial numbers" on page 72.

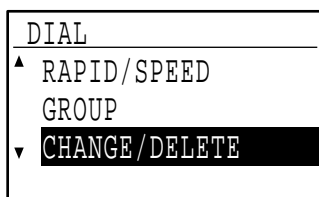

[Storing Rapid keys and Speed Dial numbers]

To store a Rapid key or Speed Dial number, follow steps 1 through 6 on pages 66 to 67 and then follow the steps below.

7 Press a Rapid key ([01] to [50]) or press the [SPEED] key.

- If you are storing a Rapid key, press the Rapid key that you wish to use ([01] to [50]).

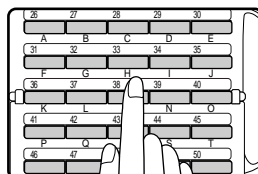

If you press a Rapid key that has already been programmed, a warning message will appear.

- If you are storing a Speed Dial number, press the [SPEED] key and then enter the desired Speed Dial number (000 to 299) with the numeric keys.

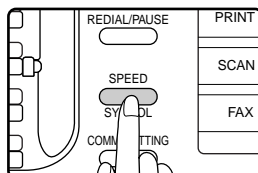

8 Enter the fax number of the destination with the numeric keys.

Example of a Rapid key

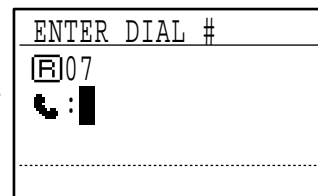
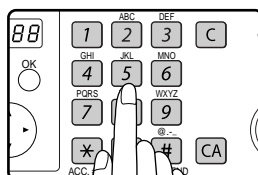

Up to 50 digits can be entered for the fax number. If you need to insert a pause between any of the digits, press the [REDIAL/PAUSE] key. The pause appears as a hyphen (-). To set the duration of the pause, see "PAUSE TIME" (page 100).

6

9 Press the [OK] key.



10 Enter the name of the destination (see "ENTERING CHARACTERS" on page 86.

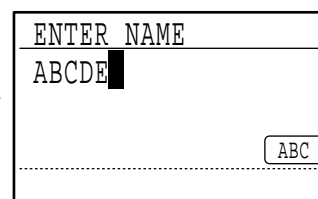
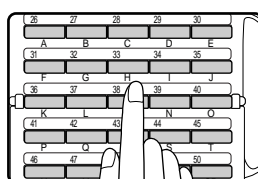

Up to 36 characters can be entered for the name. If you press the [OK] key without entering a name, go directly to step 13. In this case, a destination name will be assigned automatically.

11 Press the [OK] key.



12 Enter search characters (see "ENTERING CHARACTERS" on page 86).

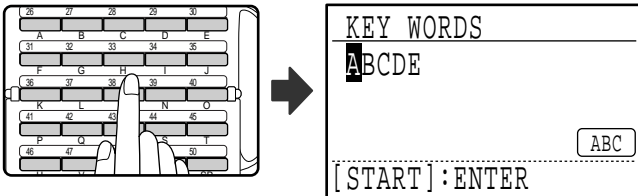

Up to 10 search characters can be entered. Only "Uppercase" characters should be used in "KEY WORD" to arrange the addresses in alphabetical order. The search characters function as a keyword if you need to search for the destination when sending a fax. (Page 20)

13 To finish the storing procedure, press the [START] key (Ⓢ). If you wish to program an option such as an F-code, chain dialing, transmission speed, or international transmission mode, press the [OK] key.

- If you pressed the [START] key (Ⓢ), you will return to step 7. If you wish to store another Rapid key or Speed Dial number, repeat steps 7 to 13. If you have finished storing auto-dial numbers, press the [BACK] key.
- If you pressed the [OK] key, go to the appropriate page for the option that you wish to program.

To program F-code settings, see "F-code settings" which follows. To select "CHAIN DIAL", go to "Chain Dialling" on page 69. To set the "TRANSMISSION SPEED", go to "Transmission speed setting" on page 70. To set the "INTERNATIONAL TRANSMISSION MODE", go to "International transmission mode setting" on page 70.



About the setting options

When storing and editing Rapid keys and Speed Dial numbers, you can also select the setting options below. Chain dialling cannot be combined with any of the other setting options. When you select a setting option, a checkmark appears in the setting option screen.

- F-code A sub-address and passcode can be stored for F-code communication. (See below.)
- Chain Dialling You can enable or disable Chain Dialling for a Rapid key or Speed Dial number. (Page 69)
- Transmission speed You can set the transmission speed to 33,600 bps (maximum speed), 14,400 bps (high speed), 9600 bps (middle speed), or 4800 bps (low speed). The initial setting is 33,600 bps (maximum speed). (Page 70)
- International transmission mode . . . The international transmission mode can be set to "OFF" or one of modes 1 to 3. The initial setting is "OFF". (Page 70)

[F-code settings]

To program F-code settings, complete steps 1 through 13 on pages 66 to 68 and then follow the steps below.

1 Select "SUB ADDRESS" with the [▼] or [▲] key.

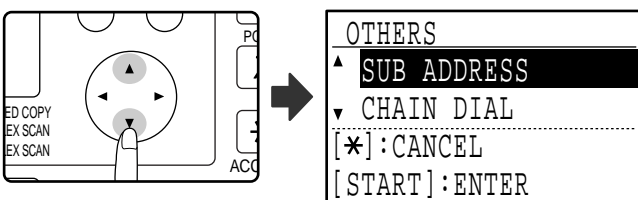

2 Press the [OK] key.

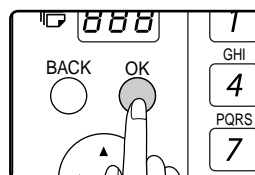

3 Enter a sub-address (maximum 20 digits) with the numeric keys.

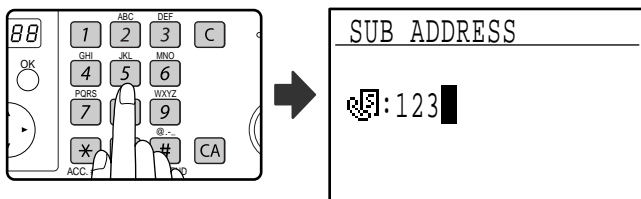

Characters that can be entered are numbers, "*", "#", and spaces. If you make a mistake, press [C] key and then re-enter the correct number.

When this step is referred to in the following procedures, "*", "#", and spaces cannot be entered.

- PROGRAMMING AN F-CODE CONFIDENTIAL BOX (step 11 on page 79)
- Editing an F-code confidential box (step 17 on page 82)
- PROGRAMMING AN F-CODE RELAY GROUP (step 11 on page 80)
- Editing an F-code relay group (step 15 on page 83)
- PROGRAMMING F-CODE PUBLIC (POLLING MEMORY) BOXES (step 11 on page 81)
- Editing an F-code public box (step 15 on page 84)

4 Press the [OK] key.

5 Enter a passcode (maximum 20 digits) with the numeric keys.

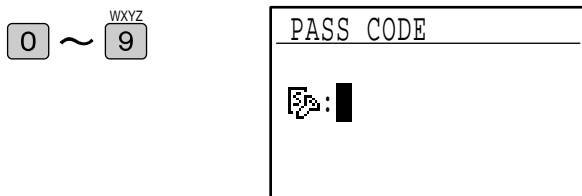

- Characters that can be entered are numbers, "*", "#", and spaces. If you make a mistake, press [C] key and then re-enter the correct number.
- If desired, you can omit the passcode.

When this step is referred to in the following procedures, spaces cannot be entered.

- PROGRAMMING AN F-CODE CONFIDENTIAL BOX (step 12 on page 79)
- Editing an F-code confidential box (step 18 on page 82)
- PROGRAMMING AN F-CODE RELAY GROUP (step 12 on page 80)
- Editing an F-code relay group (step 15 on page 83)
- PROGRAMMING F-CODE PUBLIC (POLLING MEMORY) BOXES (step 12 on page 81)
- Editing an F-code public box (step 15 on page 84)

6 Press the [OK] key.

When you press the [OK] key, you return to the option setting screen and a checkmark appears to the left of "F-CODE".
To cancel the F-code setting, press the [*] key to remove the checkmark.

7 Return to step 13 on page 68.

[Chain Dialling]

To set an auto-dial number as a Chain Dial number, complete steps 1 through 13 on pages 66 to 68 and then follow the steps below.



When a number is set as a Chain Dial number, the destination fax number entered in step 8 on page 67 can be up to 48 digits long.

1 Select "CHAIN DIAL" with the [▼] or [▲] key.

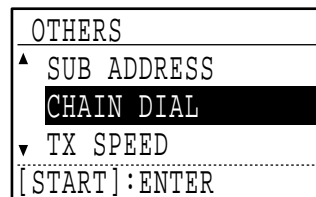

- If checkmark appears to the left of "CHAIN DIAL", it is already selected.
- To exit, press the [START] key (⊙).

2 Press the [OK] key.



3 Select "ON" or "OFF" with the [▼] or [▲] key.

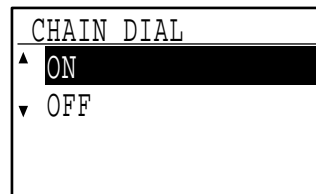

If chain dialling was already selected in step 7 and you wish to cancel the selection, select "OFF".

4 Press the [OK] key.



After you select "ON" and press the [OK] key, you will return to the option setting screen and a checkmark will appear to the left of "CHAIN DIAL".

If you pressed the [*] key, the checkmark will be removed and chain dialling cancelled.

5 Return to step 13 on page 68.

[Transmission speed setting]

To set the transmission speed, complete steps 1 through 13 on pages 66 to 68 and then follow the steps below.



Set the transmission speed only when you know what speed is most suitable, such as when you are sending a fax to a foreign country and telephone line conditions are bad. If you do not know the line conditions, do not change this setting.

1 Select "TX SPEED" with the [▼] or [▲] key.

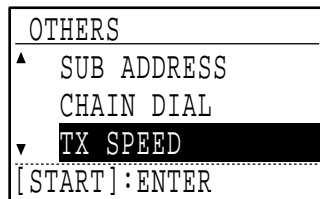
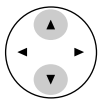

2 Press the [OK] key.



3 Select the desired transmission speed with the [▼] or [▲] key.

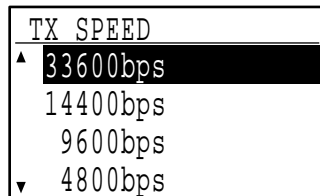
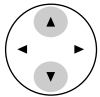

4 Press the [OK] key.



If you select a speed other than 33,600 bps (maximum speed), a checkmark will appear next to "TX SPEED" when you return to the option setting screen. This setting is not effective for polling transmission. To remove the checkmark and return the transmission speed setting to "33,600 bps (maximum speed)", press the [*] key.

5 Return to step 13 on page 68.

[International transmission mode setting]

To set the international transmission mode, complete steps 1 through 13 on pages 66 to 68 and then follow the steps below.



- When sending a fax to a foreign country, telephone line conditions can sometimes distort the fax or interrupt the transmission. Selecting the right international transmission mode can help alleviate these problems.
- If errors frequently occur when sending a fax to a foreign country, try each of modes 1 to 3 and select the mode that enables the best transmission.

1 Select "INTERNATIONAL TX" with the [▼] or [▲] key.

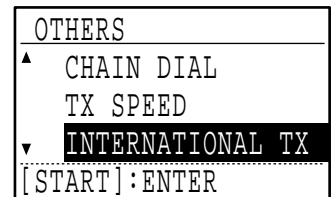
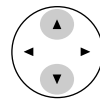

2 Press the [OK] key.



3 Select the desired mode with the [▼] or [▲] key.

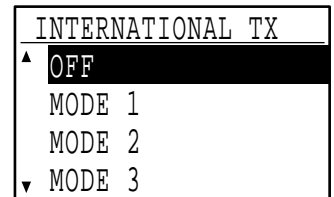
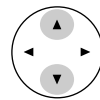

4 Press the [OK] key.



If you select a setting other than "OFF", a checkmark will appear next to "INTERNATIONAL TX" when you return to the option setting screen. To remove the checkmark and return the international transmission mode to "OFF", press the [*] key.

5 Return to step 13 on page 68.

[Storing a group key]

To store a group key, follow steps 1 through 6 on pages 66 to 67 and then follow the steps below.

1 Press a Rapid key ([01] to [50]).

Press the Rapid key ([01] to [50]) that you wish to program as a group key.

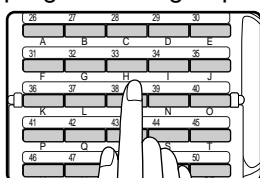

If you press a Rapid key that has already been programmed, a warning message will appear.



Group key dialling is an automatic dialling function where by multiple destinations (Rapid keys, Speed Dial numbers, and full fax numbers entered with the numeric keys) are programmed into a Rapid key. If you frequently send faxes to the same group of destinations using broadcast transmission, which is used to send the same document to multiple destinations in a single operation (page 31), it is convenient to program those destinations into a group key.

2 Enter a group name (see "ENTERING CHARACTERS" on page 86).

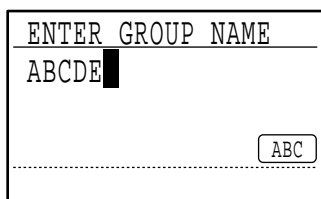
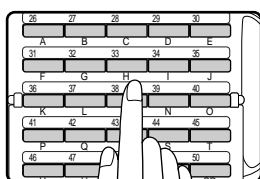

Up to 36 characters can be entered for the name. A group name must be entered.

3 Press the [OK] key.

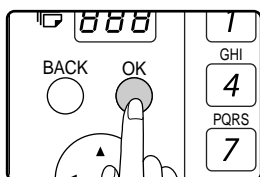

4 Enter search characters (see "ENTERING CHARACTERS" on page 86).

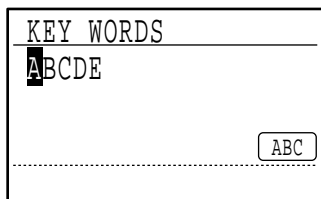
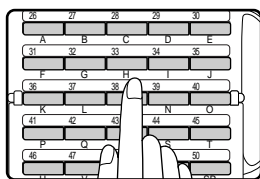

Up to 10 search characters can be entered. The search characters function as a keyword if you need to search for the destination when sending a fax (page 20).

5 Store the destinations using Rapid keys, Speed Dial numbers, and the numeric keys.

- To store a Rapid key, press the Rapid key that you wish to use ([01] to [50]).

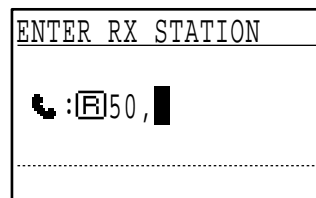
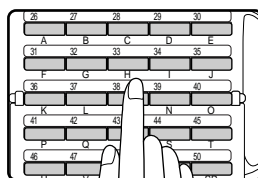

If you press an incorrect key, press the [C] key and then press the correct key.

- To store a Speed Dial number, press the [SPEED] key and then enter the desired Speed Dial number (000 to 299) with the numeric keys.

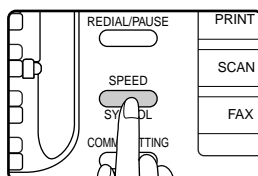

If you press an incorrect key, press the [C] key and then press the correct key.

- You can also enter a destination fax number with the numeric keys. However, in this case, F-code, chain dialling, transmission speed, and international transmission mode options cannot be selected. If you need to select an option for the destination, store the destination in a Rapid key or Speed Dial number and then store the destination in the group key. Up to 50 digits can be entered for the fax number. If you need to insert a pause between any of the digits, press the [REDIAL/PAUSE] key to enter a pause. The pause appears as a hyphen (-). To set the duration of the pause, see "PAUSE TIME" (page 100). When you have finished entering the fax number, press the [OK] key.

6 Repeat step 5 for all of the destinations that you wish to store in the group key.

Up to 150 destinations can be stored in a group key. (However, note that when multiple group keys are programmed, the total number of destinations that can be stored in all group keys is 200.)

7 Press the [START] key (⊙).

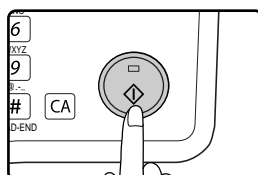

The group key is stored.

[Editing and deleting auto-dial numbers]

To edit or delete an auto-dial number, follow steps 1 through 6 on pages 66 and 67 and then follow the steps below.



A Rapid key or Speed Dial number cannot be edited or cleared in the following cases:

- The Rapid key or Speed Dial number is being used in a transmission in progress or in a stored transmission.
- The Rapid key or Speed Dial number is stored in a group key, program, or F-code relay group.

● Editing a Rapid key or Speed Dial number

1 Select "RAPID/SPEED" with the [▼] or [▲] key.

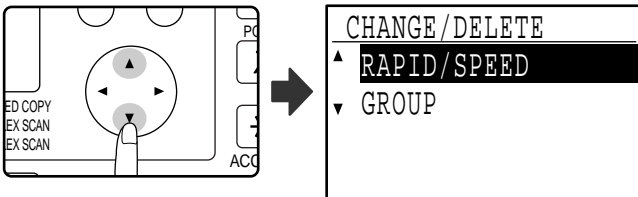

2 Press the [OK] key.

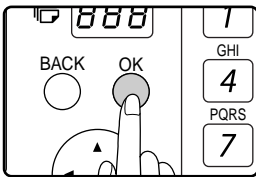

3 Select "CHANGE" with the [▼] or [▲] key.

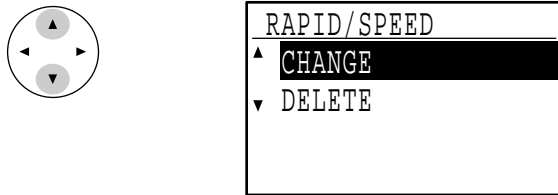

4 Press the [OK] key.



5 Press a Rapid key ([01] to [50]) or the [SPEED] key.

- To edit a Rapid key, press the Rapid key that you wish to edit ([01] to [50]).

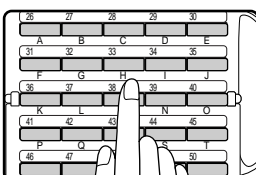

- To edit a Speed Dial number, press the [SPEED] key and then enter the Speed Dial number (000 to 299) that you wish to edit with the numeric keys.

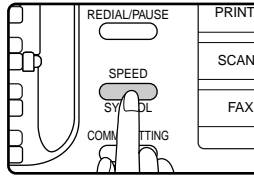

6 Edit the destination fax number with the numeric keys.

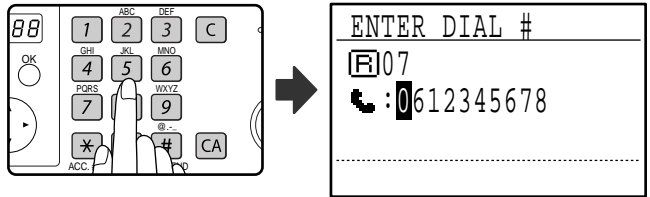

Move the cursor to the digit(s) that you wish to edit with the [◀] or [▶] key, and then enter the correct digit(s) with the numeric keys. To delete a digit, move the cursor to the digit that you wish to delete with the [◀] or [▶] key and then press the [C] key.

7 Press the [OK] key.



8 Edit the name of the destination (see "ENTERING CHARACTERS" on page 86).

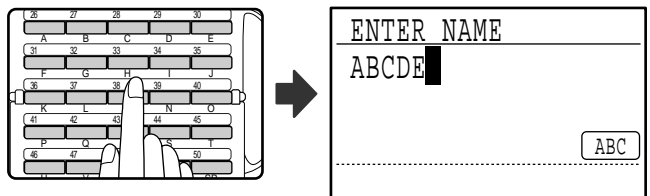

9 Press the [OK] key.



10 Edit the search characters (see "ENTERING CHARACTERS" on page 86).

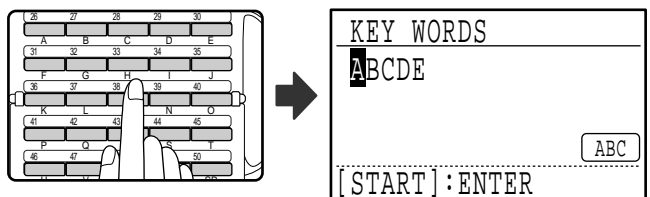

Characters added in step 8 will appear at the end of the previously stored search characters. (Maximum of 10 characters altogether.)

11 To finish the storing procedure, press the [START] key (⊙). If you wish to program an option such as F-code, chain dialling, transmission speed, or international transmission mode, press the [OK] key.

- If you pressed the [START] key (⊙), go to step 5. If you wish to program another Rapid key or Speed Dial number, repeat steps 5 to 11. To exit, press the [BACK] key. Editing to that point will be completed.
- If you pressed the [OK] key, go to the appropriate page for the option that you wish to edit. To program F-code settings, follow the steps in "F-code settings" on pages 68 and 69. To select "CHAIN DIAL", go to "Chain Dialling" on page 69. To set the "TRANSMISSION SPEED", go to "Transmission speed setting" on page 70. To set the "INTERNATIONAL TRANSMISSION MODE", go to "International transmission mode setting" on page 70.

● **Deleting a Rapid key or Speed Dial number**

1 In step 3 on page 72, select "DELETE" with the [▼] or [▲] key.

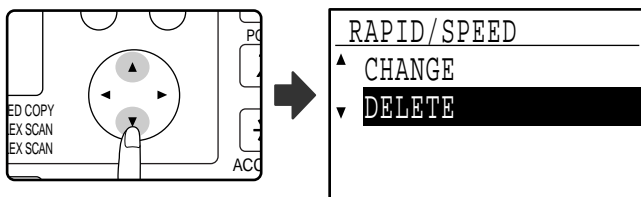

2 Press a Rapid key ([01] to [50]) or the [SPEED] key.

- To delete a Rapid key, press the Rapid key that you wish to delete ([01] to [50]).

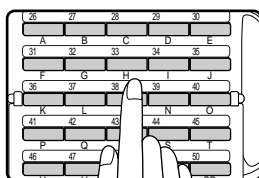

- To delete a Speed Dial number, press the [SPEED] key and then enter the Speed Dial number (000 to 299) that you wish to delete with the numeric keys.

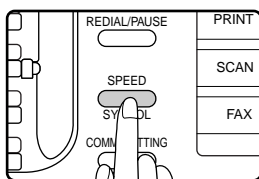

3 Select "DELETE" with the [▼] or [▲] key.

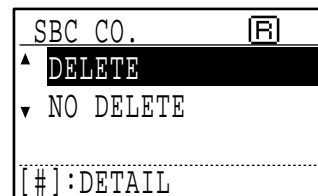

Note If you select "NO DELETE", you can press the [#] key to check the destination name. If you are deleting the destination, check the destination name and then delete the destination.

4 Press the [OK] key.

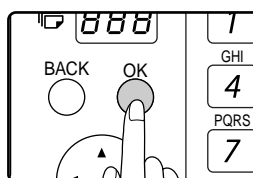

You will return to the screen of step 2. If you wish to delete another Rapid key or Speed Dial number, repeat steps 2 to 4. To exit, press the [BACK] key.

[Editing and deleting group keys]

To edit or delete a group key, follow steps 1 through 6 on pages 66 to 67 and then follow the steps below.



Note A group key cannot be edited or deleted in the following cases.

- The group key is stored in a program or F-code relay group.

● **Editing a group key**

1 Select "GROUP" with the [▼] or [▲] key.

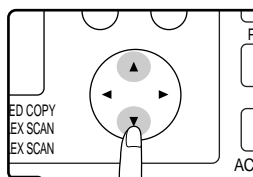

2 Press the [OK] key.

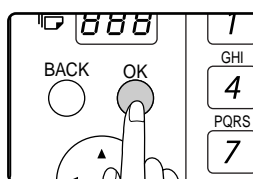

6

3 Select "CHANGE" with the [▼] or [▲] key.

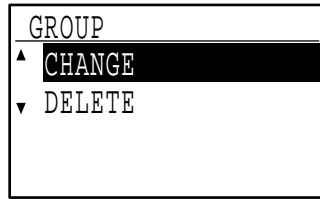
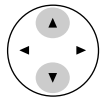

4 Press the [OK] key.



5 Press the group key (one of Rapid keys [01] to [50]) that you wish to edit.

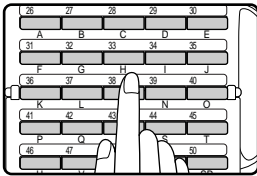

6 Edit the group name (see "ENTERING CHARACTERS" on page 86).

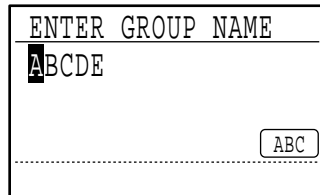
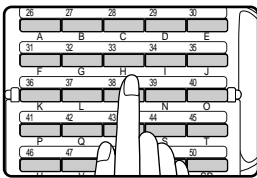

7 Press the [OK] key.



8 Edit the search characters (see "ENTERING CHARACTERS" on page 86).

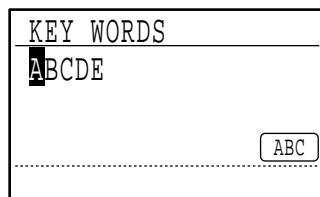
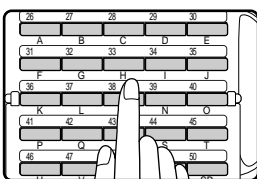

9 Edit the stored information.

- To add a Rapid key or Speed Dial number, enter the Rapid key ([01] to [50]) or Speed Dial number that you wish to add.

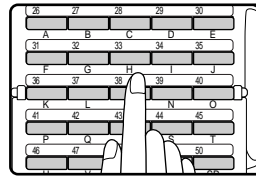

A key or number that is already in the group cannot be added.

- To delete a Rapid key or Speed Dial number, select it with the [◀] or [▶] key and press the [C] key.

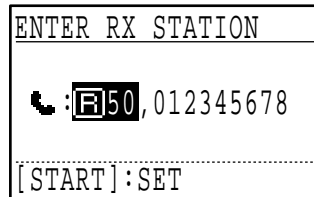

- To delete a number entered with the numeric keys, select a digit of the number with the [◀] or [▶] key and press the [C] key. The entire number including the selected digit will be deleted. To add a number, select the place where you wish to add the number with the [◀] or [▶] key, and then enter the number. When you have finished adding or deleting the number, press the [OK] key.

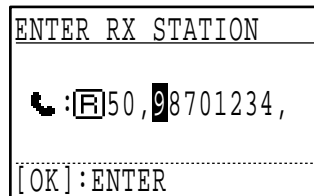

10 When you have finished editing the destinations, press the [START] key (Ⓢ).

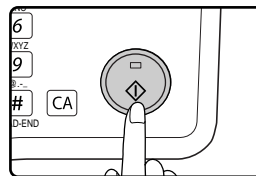

This completes the editing procedure.

● Deleting a group key

- 1** In step 3 on page 74, select "DELETE" with the [▼] or [▲] key.

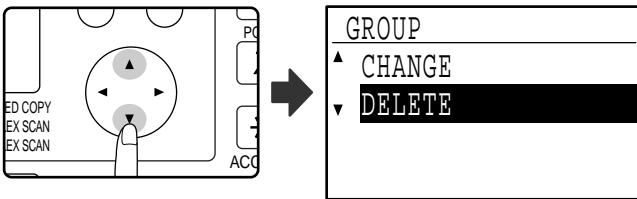

- 2** Press the [OK] key.

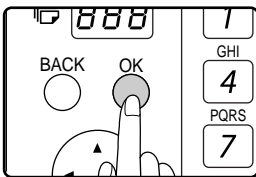

- 3** Press the group key (one of Rapid keys [01] to [50]) that you wish to edit.

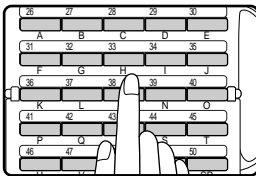

- 4** Select "DELETE" with the [▼] or [▲] key.

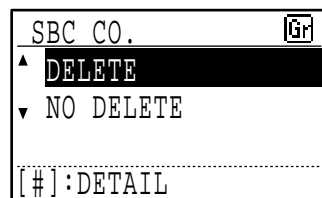
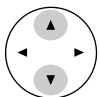

If you select "NO DELETE", you can press the [#] key to check the destination name. If you are deleting the destination, check the destination name and then delete the destination.

- 5** Press the [OK] key.



Return to step 3. If you wish to delete another group key, repeat steps 3 through 5. To exit, press the [BACK] key.

STORING, EDITING AND DELETING PROGRAMS

You can store a transmission method*, cover sheet/message, transmission settings, dual pages, and/or resolution/exposure settings in a program. This will allow you to use the settings for a transmission by means of a simple operation (see "USING A PROGRAM" on page 44).

* Transmission methods: normal transmission, broadcast transmission, polling, serial polling, F-code transmission, F-code polling



An original size setting, screen setting, and timer transmission setting cannot be stored in a program.

To store a program, follow steps 1 through 6 on pages 66 to 67 and then follow the steps below.

1 Select "ENTRY" with the [▼] or [▲] key.

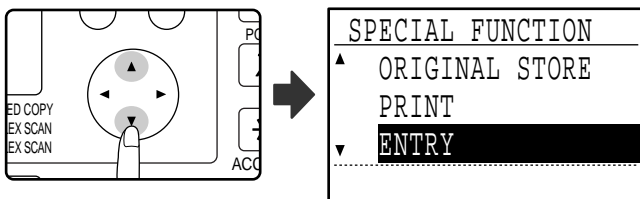

2 Press the [OK] key.

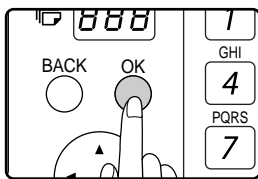

3 Select "PROGRAM" with the [▼] or [▲] key.

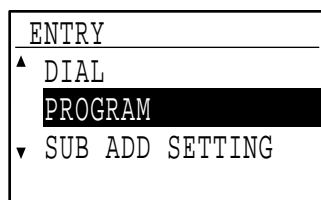
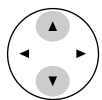

4 Press the [OK] key.

5 Select "ENTER", "CHANGE", or "DELETE" with the [▼] or [▲] key.

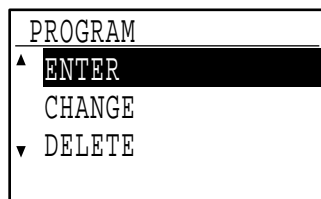
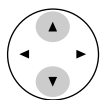

- To edit a program, select "CHANGE" and press the [OK] key. Next, follow the steps in "EDITING PROGRAMS" on page 77.
- To delete a program, select "DELETE" and press the [OK] key. Next, follow the steps in "DELETING PROGRAMS" on page 77.

[STORING A PROGRAM]

6 Select the program that you wish to store with the [▼] or [▲] key.

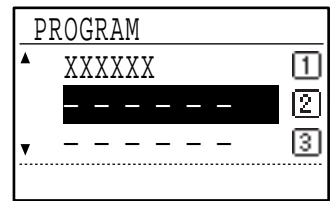

If you select a program that has already been stored, a message appears. Select a program that has not been stored, or clear the program (page 77) and then select it.

7 Press the [OK] key.

8 Enter a program name (see "ENTERING CHARACTERS" on page 86).

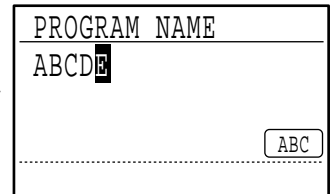
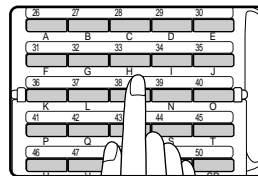

Up to 36 characters can be stored for the name of the program. A program name must be entered.

9 Press the [OK] key.

- To store a program, select "ENTER" and press the [OK] key. Continue from step 6 of "STORING A PROGRAM".

10 Select the program that you wish to store with the [▼] or [▲] key.

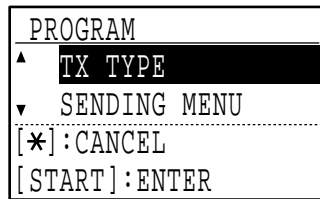
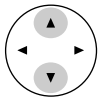

- A transmission method, cover sheet/message, resolution/exposure settings, dual pages, sender's name, and transmission settings can be stored. A transmission method must be stored. The storing procedure cannot be completed unless a transmission method is stored.
- For the procedures for selecting each of the settings, refer to the explanations of the settings.
- To cancel a setting selection, select the setting that you wish to cancel and then press the [*] key.
- Some settings cannot be used in combination with others. If you select a prohibited combination of settings, a message will appear in the display.

11 To continue selecting another setting, press the [OK] key.

When you have finished selecting settings, press the [START] key (⊙). You will return to step 8. If you wish to store another program, repeat steps 8 to 11. To exit, press the [BACK] key in step 8.



You can check the contents of a program (transmission type, destination) by printing the "PROGRAM LIST" (page 85).

[EDITING PROGRAMS]

If you need to edit a previously stored program, follow these steps.

6 Select the program that you wish to edit with the [▼] or [▲] key.

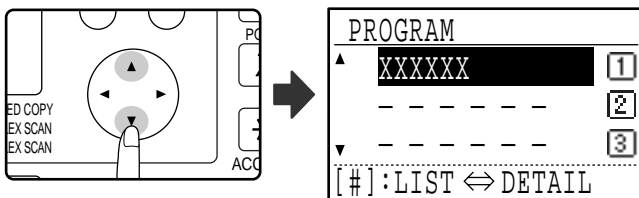

If not all letters of the program name appear, press the [#] key to display all letters. Press the [#] key once again to return to the original screen.

7 Press the [OK] key.

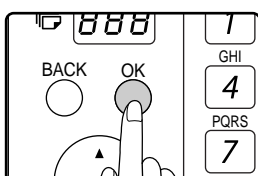

8 Edit the program name (see "ENTERING CHARACTERS" on page 86).

- See step 8 of "STORING A PROGRAM".
- If you do not wish to edit the program name, go to the next step.

9 Press the [OK] key.

10 Select the stored setting that you wish to edit with the [▼] or [▲] key.

- See steps 10 and 11 of "STORING A PROGRAM".
- If you do not wish to edit the stored settings, press the [START] key (⊙) and then press the [BACK] key to exit.

[DELETING PROGRAMS]

Before deleting a program, print the "PROGRAM LIST" to check the contents. (Page 85) To delete a previously stored program, follow these steps:

6 Select the program that you wish to delete with the [▼] or [▲] key.

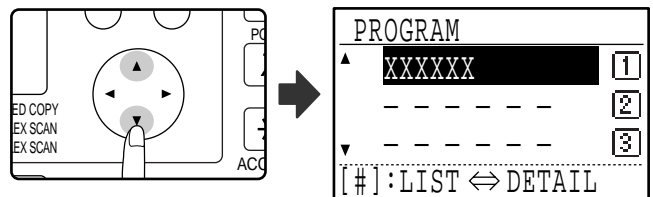

If not all letters of the program name appear, press the [#] key to display all letters. Press the [#] key once again to return to the original screen.

7 Press the [OK] key.

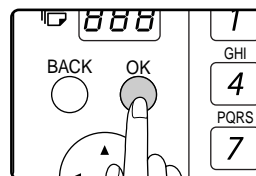

8 Select "DELETE" with the [▼] or [▲] key.

9 Press the [OK] key.

Return to step 6. To delete another program, repeat steps 6 through 8. To exit, press the [BACK] key.

PROGRAMMING, EDITING, AND DELETING F-CODE MEMORY BOXES

The procedure for programming a box for F-code transmission is explained here. There are three types of F-code boxes: F-code public boxes (page 81), F-code confidential boxes (page 79), and F-code relay group boxes (page 80). F-code boxes are programmed, edited, and deleted as explained below.

PROGRAMMING AN F-CODE MEMORY BOX

A box name, sub-address, passcode, and the appropriate functions are programmed in an F-code box.



- When programming a new F-code box, a sub-address that is already programmed in another box cannot be used. However, the passcode can be the same as a passcode used in another box.
- A passcode can be omitted.
- Up to 10 F-code boxes of each type can be programmed. If 10 F-code boxes of one type have already been programmed, a warning message will appear and you will not be able to program a new box. Delete any unused F-code boxes (page 81) and then program the new box.

1 In Fax mode, press the [SPECIAL FUNCTION] key.

Begin the following procedure from the base screen of Fax mode.

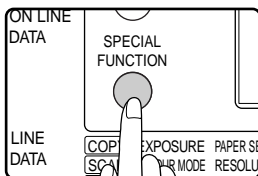

When the [SPECIAL FUNCTION] key is pressed, the function menu screen appears. (To select fax mode, see step 1 on page 17.)

2 Select "ENTRY" with the [▼] or [▲] key.

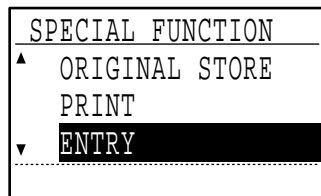
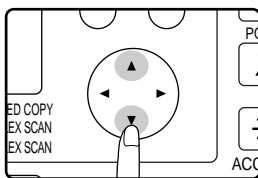

3 Press the [OK] key.

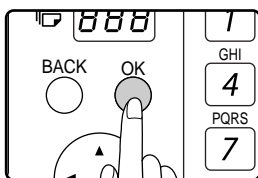

4 Select "SUB ADD SETTING" with the [▼] or [▲] key.

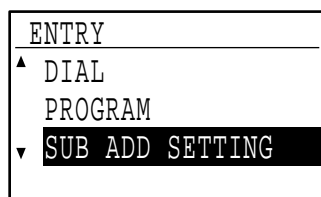
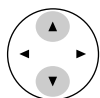

5 Press the [OK] key.



6 Select "S.A. CONF. BOX", "S.A. RELAY GRP", "S.A. MEM POLLING", or "CHANGE/DELETE" with the [▼] or [▲] key.

- To program an F-code confidential box, select "S.A. CONF. BOX" and press the [OK] key. Next, follow the steps in "PROGRAMMING AN F-CODE CONFIDENTIAL BOX" on page 79.
- To program an F-code relay group (box), select "S.A. RELAY GRP" and press the [OK] key. Next, follow the steps in "PROGRAMMING AN F-CODE RELAY GROUP" on page 80.
- To program an F-code public (polling memory) box, select "S.A. MEM POLLING" and press the [OK] key. Next, follow the steps in "PROGRAMMING F-CODE PUBLIC (POLLING MEMORY) BOXES" on page 81.

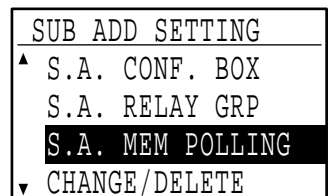
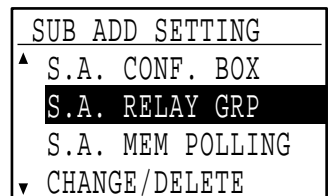
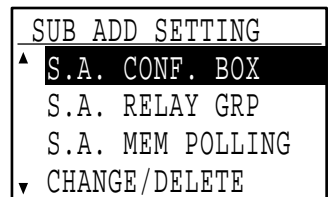

- To edit or delete an F-code confidential box, F-code relay group, or F-code public box, select "CHANGE/DELETE" and then press the [OK] key. Next, follow the steps in "EDITING AND DELETING F-CODE MEMORY BOXES" on page 81.

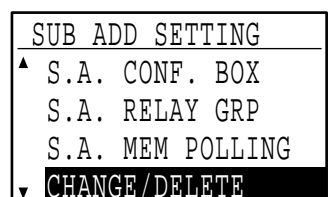

[PROGRAMMING AN F-CODE CONFIDENTIAL BOX]

Follow the steps below to program an F-code confidential reception box. An F-code (sub-address and passcode) for F-code confidential reception and a print passcode to print out received faxes are programmed in each box. Up to 10 boxes can be programmed. To check the contents of a programmed box, print the following list: "PRINT - REPORT - SUB ADD SET LIST". (Page 85)

To program an F-code confidential box, follow steps 1 through 6 on page 78 and then follow the steps below.

7 Select an unused box ("-----") with the [▼] or [▲] key.

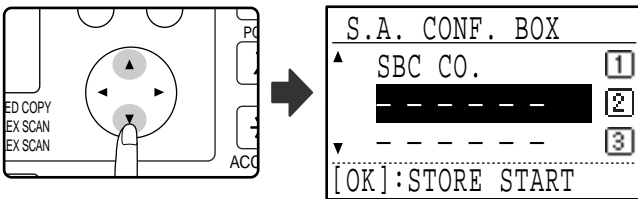

8 Press the [OK] key.

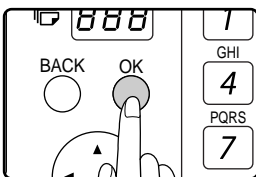

9 Enter a name for the F-code confidential box (see "ENTERING CHARACTERS" on page 86).

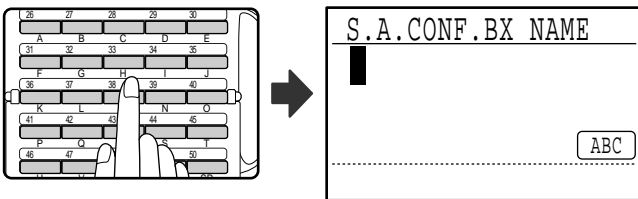

Up to 36 characters can be entered for the name. A box name must be entered.

10 Press the [OK] key.



11 Enter a sub-address (maximum 20 digits) with the numeric keys.

See steps 3 and 4 on page 69.

12 Enter a passcode (maximum 20 digits) with the numeric keys.

See steps 5 and 6 on page 69.

13 Enter the print passcode (4 digits) with the numeric keys.

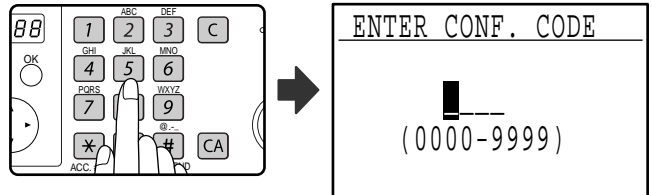

The characters "*" and "#" cannot be used. The print passcode cannot be omitted. Take care not to forget the programmed print passcode. If you forget the passcode, consult your Sharp dealer.

14 Press the [OK] key.



[PROGRAMMING AN F-CODE RELAY GROUP]

This procedure is used to program an F-code relay group box for relay broadcast of a received fax upon receipt of an F-code relay request. Up to 10 boxes can be programmed. An F-code (sub-address and passcode) for reception of an F-code relay request and the destinations to which the fax is to be relayed are programmed in each box. To check the contents of a programmed box, print the following list: "PRINT - REPORT - SUB ADD SET LIST" (page 85). To program an F-code relay group box, follow steps 1 through 6 on page 78 and then follow the steps below.

7 Select an unused box ("-----") with the [▼] or [▲] key.

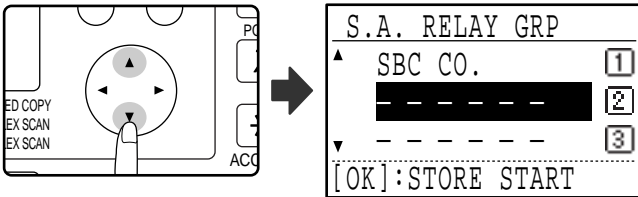

8 Press the [OK] key.

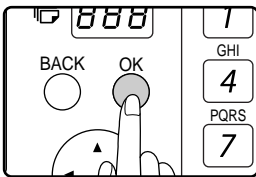

9 Enter a name for the F-code relay group box (see "ENTERING CHARACTERS" on page 86).

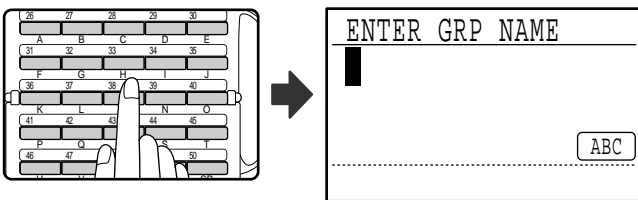

Up to 36 characters can be entered for the name. A box name must be entered.

10 Press the [OK] key.



11 Enter a sub-address (maximum 20 digits) with the numeric keys.

See steps 3 and 4 on page 69.

12 Enter a passcode (maximum 20 digits) with the numeric keys.

See steps 5 and 6 on page 69.

13 Enter the relay destinations. Enter full fax numbers with the numeric keys and/or press auto-dial keys (Rapid keys, Speed Dial numbers, and group keys) to select the destinations (page 19).

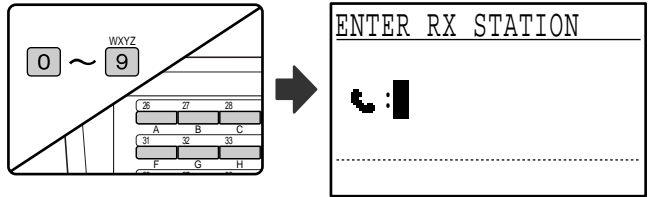

- To clear a mistake when entering a number with the numeric keys, press the [C] key to clear one digit at a time.
- A destination selected with a Rapid key, Speed Dial number, or group key is indicated by an icon and a number. To clear an entry, press the [C] key.

14 Press the [OK] key and then dial the fax number of the next destination or press an auto-dial key.

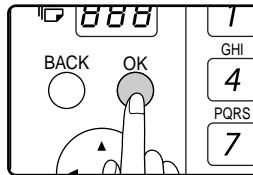

- After entering a full number with the numeric keys, press the [OK] key to complete the entry. If you pressed an auto-dial key in step 13, it is not necessary to press the [OK] key. You can immediately press another auto-dial key for the next destination.
- Repeat steps 13 and 14 until all destinations have been entered.

15 Press the [START] key (Ⓢ) to end the procedure.

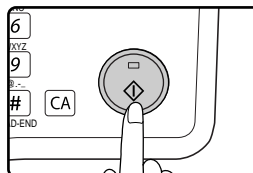

[PROGRAMMING F-CODE PUBLIC (POLLING MEMORY) BOXES]

This setting is used to program a box to store document data for remote transmission when polled by a machine that supports F-Code communication. Up to 10 boxes can be programmed.

To check the contents of a programmed box, print the following list: "PRINT - REPORT - SUB ADD SET LIST" (page 85).

To program an F-code public box, follow steps 1 through 6 on page 78 and then follow the steps below.

7 Select an unused box ("- - - - -") with the [▼] or [▲] key.

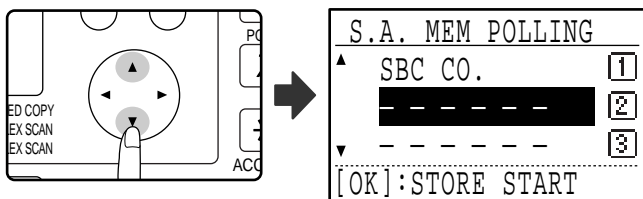

8 Press the [OK] key.

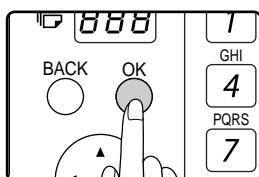

9 Enter a name for the F-code public box (see "ENTERING CHARACTERS" on page 86).

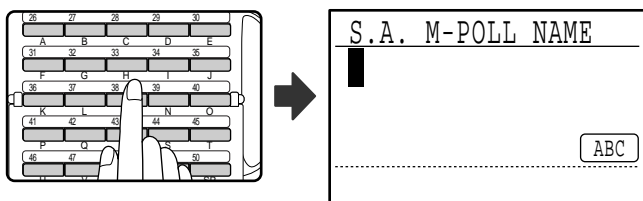

Up to 36 characters can be entered for the name. A box name must be entered.

10 Press the [OK] key.

11 Enter a sub-address (maximum 20 digits) with the numeric keys.

See steps 3 and 4 on page 69.

12 Enter a passcode (maximum 20 digits) with the numeric keys.

See steps 5 and 6 on page 69.

[EDITING AND DELETING F-CODE MEMORY BOXES]

To edit or delete an F-code box (F-code confidential box, F-code relay group box, or F-code public box), follow steps 1 through 6 on page 78 and then follow the steps below.

Note that an F-code confidential box or F-code public box cannot be edited or deleted if it contains document data.

7 Select "S.A. CONF. BOX", "S.A. RELAY GRP", or "S.A. MEM POLLING" with the [▼] or [▲] key.

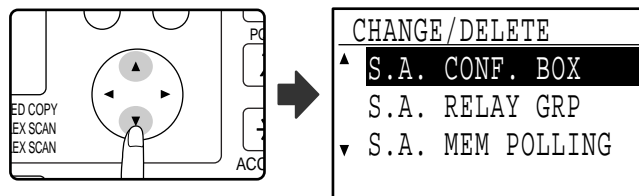

8 Press the [OK] key.

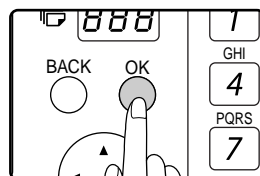

- If you selected "S.A. CONF. BOX" in step 7, follow the steps in "EDITING/DELETING AN F-CODE CONFIDENTIAL BOX" below.
- If you selected "S.A. RELAY GRP" in step 7, follow the steps in "EDITING AND DELETING F-CODE RELAY GROUPS" on page 83.
- If you selected "S.A. MEM POLLING" in step 7, follow the steps in "EDITING/DELETING F-CODE PUBLIC BOXES" on page 84.

[EDITING/DELETING AN F-CODE CONFIDENTIAL BOX]

9 Select "CHANGE" or "DELETE" with the [▼] or [▲] key.

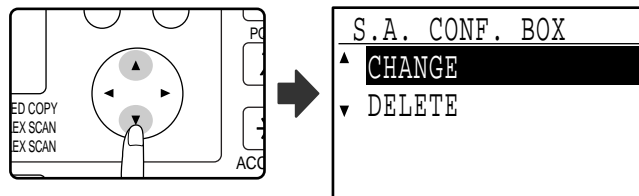

10 Press the [OK] key.

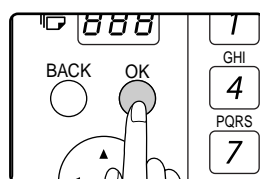

- If you selected "CHANGE" in step 9, follow the steps in "Editing an F-code confidential box" on page 82.
- If you selected "DELETE" in step 9, follow the steps in "Deleting an F-code confidential box" on page 82.

● Editing an F-code confidential box

11 Select the name of the F-code confidential box that you wish to edit with the [▼] or [▲] key.

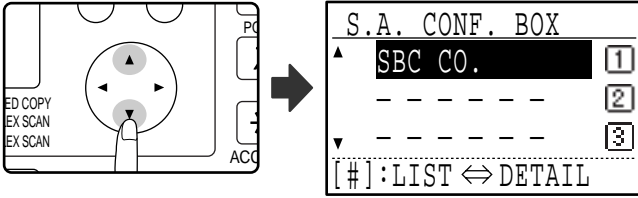

If not all letters of the box name appear, press the [#] key to display all letters. Press the [#] key once again to return to the original screen.

12 Press the [OK] key.

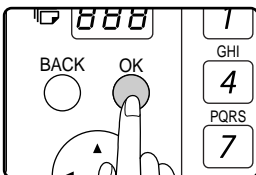

13 Enter the print passcode (4 digits) with the numeric keys.

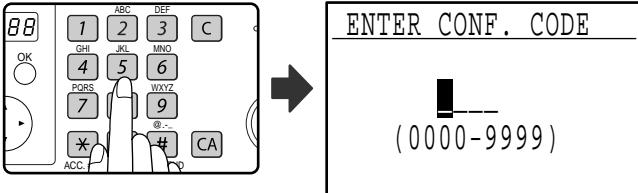

Enter the correct print passcode that was programmed when the confidential box was programmed.

14 Press the [OK] key.

15 Edit the name of the F-code confidential box (see "ENTERING CHARACTERS" on page 86).

- See step 9 on page 79.
- If you do not wish to edit the name, go to the next step.

16 Press the [OK] key.

17 Edit the sub-address (maximum 20 digits) with the numeric keys.

- See steps 3 and 4 on page 69.
- If you do not need to edit the sub-address, press the [OK] key and go to the next step.

18 Edit the passcode (maximum 20 digits) with the numeric keys.

- See steps 5 and 6 on page 69.
- If you do not need to edit the passcode, press the [OK] key and go to the next step.

19 Edit the print passcode (4 digits) with the numeric keys.

- See steps 13 and 14 on page 79.
- If you do not need to edit the print passcode, press the [OK] key.

● Deleting an F-code confidential box

11 Select the name of the F-code confidential box that you wish to delete with the [▼] or [▲] key.

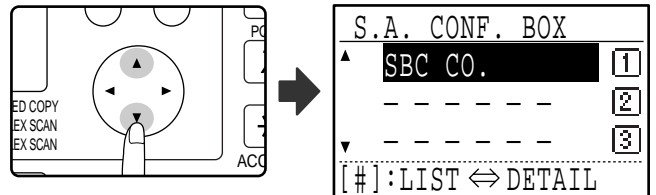

If not all letters of the box name appear, press the [#] key to display all letters. Press the [#] key once again to return to the original screen.

12 Press the [OK] key.

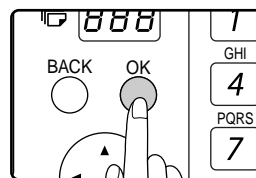

13 Enter the print passcode (4 digits) with the numeric keys.

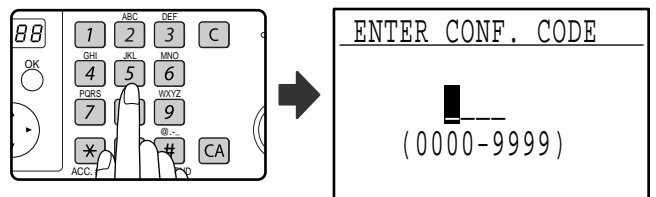

Enter the correct print passcode that was programmed when the confidential box was programmed.

14 Press the [OK] key.

15 Select "DELETE" with the [▼] or [▲] key.

16 Press the [OK] key.

You will return to the screen of step 11. If you wish to delete another box, repeat steps 11 through 14. To exit, press the [BACK] key.

[EDITING AND DELETING F-CODE RELAY GROUPS]

9 Select "CHANGE" or "DELETE" with the [▼] or [▲] key.

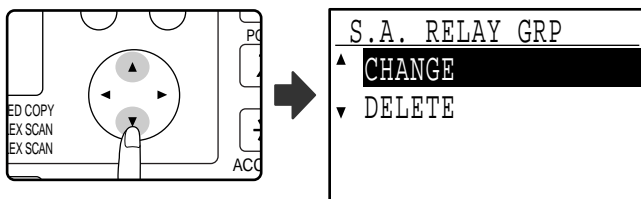

10 Press the [OK] key.

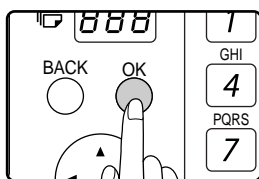

- If you selected "CHANGE" in step 9, follow the steps in "Editing an F-code relay group" which follows.
- If you selected "DELETE" in step 9, follow the steps in "Deleting an F-code relay group" which follows.

● Editing an F-code relay group

11 Select the name of the F-code relay group (box) that you wish to edit with the [▼] or [▲] key.

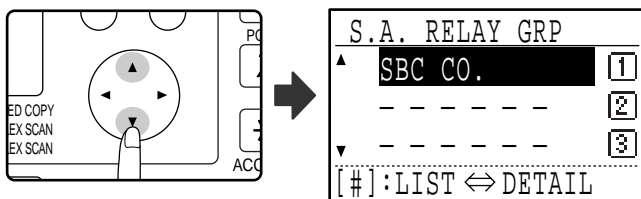

If not all letters of the box name appear, press the [#] key to display all letters. Press the [#] key once again to return to the original screen.

12 Press the [OK] key.

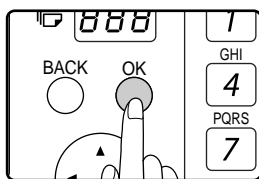

13 Edit the name of the F-code relay group (box) (see "ENTERING CHARACTERS" on page 86).

- See step 9 on page 80.
- If you do not wish to edit the name, go to the next step.

14 Press the [OK] key.



15 Edit the sub-address and passcode (maximum 20 digits) with the numeric keys.

- See steps 3 to 6 on page 69.
- If you do not need to edit the sub-address and passcode, press the [OK] key and go to the next step.

16 Edit the relay destinations.

See steps 13 to 15 on page 80.

● Deleting an F-code relay group

11 Select the name of the F-code relay group (box) that you wish to delete with the [▼] or [▲] key.

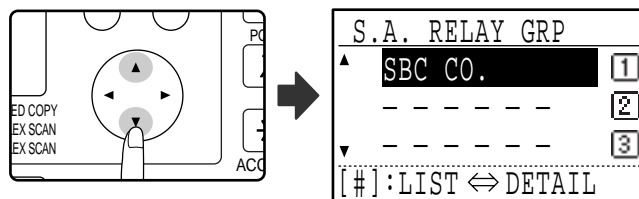

If not all letters of the box name appear, press the [#] key to display all letters. Press the [#] key once again to return to the original screen.

12 Press the [OK] key.

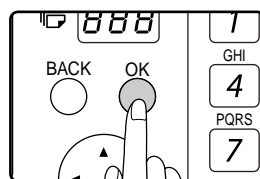

13 Select "DELETE" with the [▼] or [▲] key.

14 Press the [OK] key.



You will return to step 11. If you wish to delete another relay group, repeat steps 11 through 14. To exit, press the [BACK] key.

[EDITING/DELETING F-CODE PUBLIC BOXES]

9 Select "CHANGE" or "DELETE" with the [▼] or [▲] key.

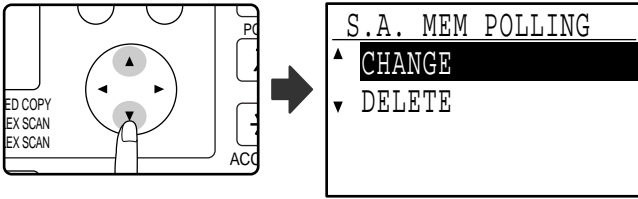

10 Press the [OK] key.

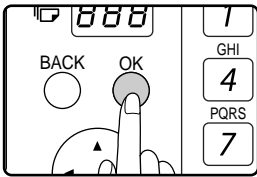

- If you selected "CHANGE" in step 9, follow the steps in "Editing an F-code public box" which follows.
- If you selected "DELETE" in step 9, follow the steps in "Deleting an F-code public box" which follows.

● Editing an F-code public box

11 Select the name of the F-code public box that you wish to edit with the [▼] or [▲] keys.

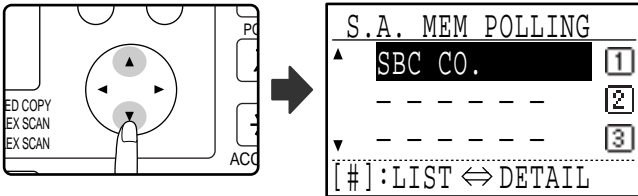

If not all letters of the box name appear, press the [#] key to display all letters. Press the [#] key once again to return to the original screen.

12 Press the [OK] key.

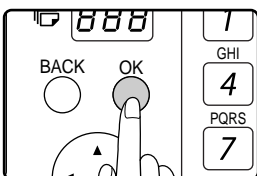

13 Edit the name of the F-code public box (see "ENTERING CHARACTERS" on page 86).

- See step 9 of "PROGRAMMING F-CODE PUBLIC (POLLING MEMORY) BOXES" (page 81).
- If you do not wish to edit the name, go to the next step.

14 Press the [OK] key.



15 Edit the sub-address and passcode (maximum 20 digits) with the numeric keys.

- See steps 3 to 6 on page 69.
- If you do not need to edit the sub-address and passcode, press the [OK] key and go to the next step.

16 Press the [OK] key and then press the [BACK] key to exit.

● Deleting an F-code public box

11 Select the name of the F-code public box that you wish to delete with the [▼] or [▲] keys.

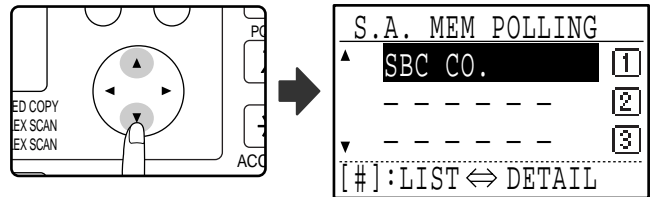

If not all letters of the box name appear, press the [#] key to display all letters. Press the [#] key once again to return to the original screen.

12 Press the [OK] key.

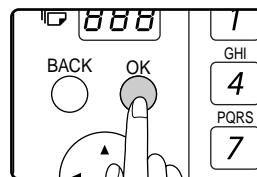

13 Select "DELETE" with the [▼] or [▲] key.

14 Press the [OK] key.



You will return to step 11. If you wish to delete another public box, repeat steps 11 through 14. To exit, press the [BACK] key.

PRINTING LISTS OF PROGRAMMED INFORMATION, SETTINGS, AND COMMUNICATION ACTIVITY

You can print lists showing programmed information, settings, and communication activity. The following lists can be printed.

- **ACTIVITY REPORT:** This report shows information on your most recent transmissions and receptions, including communication time and the other party.
- **TIMER LIST:** This list shows timer transmissions and recall mode jobs.
- **MEM. POLLING LIST:** This list shows information on the documents and settings stored for memory polling and F-code memory polling.
- **RAPID # LIST:** This list shows the information stored in each Rapid key that has been programmed.
- **SPEED # LIST:** This list shows the information stored in each Speed Dial number that has been programmed.
- **GROUP LIST:** This list shows the information stored in each group key that has been programmed.
- **TELEPHONE # LIST:** This list shows the destinations that have been stored in auto dial numbers in the order of their search characters.
- **PROGRAM LIST:** This list shows the contents of each program that has been stored.
- **SUB ADD SET LIST:** This list shows the sub-addresses and passcodes that have been programmed for F-code communication. (Note that print passcodes are not shown in the list.)
- **CONF. RX LIST:** This list shows the confidential box numbers that have received confidential faxes and the number of pages received.
- **INBOUND ROUTING LIST:** This list shows various settings used at the time of inbound routing.

1 In Fax mode, press the [SPECIAL FUNCTION] key.

Begin the following procedure from the base screen of Fax mode.

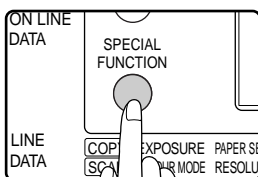

When the [SPECIAL FUNCTION] key is pressed, the function selection menu appears. (To select fax mode, see step 1 on page 17).

2 Select "PRINT" with the [▼] or [▲] key.

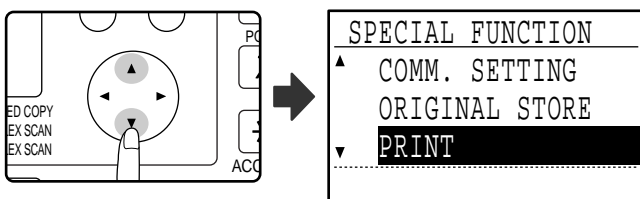

3 Press the [OK] key.

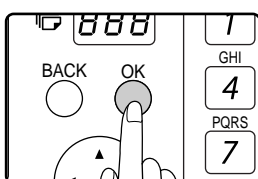

4 Select "REPORT" with the [▼] or [▲] key.

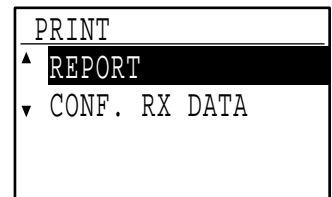

5 Press the [OK] key.



6 Select the list that you wish to print with the [▼] or [▲] key.

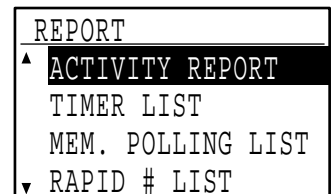

See the explanation of the lists that can be printed above.

7 Press the [OK] key.



- The list is printed (or is stored).
- If the list does not contain any data, it will not be printed.

6

ENTERING CHARACTERS

This section explains how to enter and edit characters for names of rapid dial numbers, Speed Dial numbers, and group keys, as well as account names, program names, and search characters for the address list.

CHARACTERS THAT CAN BE ENTERED

Characters that can be entered for names

The following characters can be entered:

- Up to 36 characters can be entered for a name.
However, up to 18 characters can be entered for an account name or sender's name.
- Upper case alphabet, lower case alphabet, numbers, special characters, symbols

Characters that can be used for search characters

The following characters can be used:

- Up to 10 characters can be entered for search characters.
- Upper case alphabet, lower case alphabet, numbers, special characters



- Search characters are normally the first 10 characters of the name entered for a destination.
- Search characters are used when storing and using auto dial keys and numbers.
- When a destination name includes a symbol, the symbol cannot be stored as a search character.
- Search characters can be edited.

CHANGING TO ENTRY MODE

Open the Rapid key overlay to enter alphabetical characters.

When the Rapid key overlay is open

When the Rapid key overlay is open, characters can be entered. To toggle between upper case and lower case letters, press the [SHIFT] key.

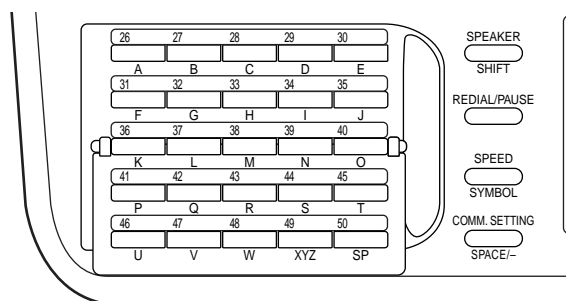

When the Rapid key overlay is closed

Closing the Rapid key overlay stores characters that have been entered to that point.

CHARACTER ENTRY KEYS

To enter characters, use the character entry keys on the operation panel. The characters entered by each key and key functions are as follows.

Character entry key	Characters and function	Character entry key	Characters and function
A	A	[SP]	Use to enter special characters.
B	B	[SHIFT]	Use to toggle between upper case and lower case letters.
C	C	[SYMBOL]	Use to enter symbols.
D	D	[SPACE/-]	Use to enter a space or a hyphen (-). The display toggles between a space and a hyphen each time you press the key.
E	E		
F	F		
G	G		
H	H	Numeric	Use to enter numbers 1 through 0.
I	I	[C] (CLEAR)	Clears the character selected with the cursor.
J	J		
K	K	[▲][▼][◀][▶]	Use to move the cursor vertically and horizontally. Also used to move through screen pages.
L	L		
M	M		
N	N		If you press the [▶] key when a character is not entered, a space will be entered.
O	O		
P	P		
Q	Q		
R	R		
S	S		
T	T		
U	U		
V	V		
W	W		
XYZ	XYZ		



When you wish to enter characters assigned to the same key in succession, press the [▶] key after entering the first character to move the cursor and then enter the next character.

Example: Entering XY

Press the [XYZ] key once, press the [▶] key once to move the cursor, and then press the [XYZ] key twice.

INITIAL PROCEDURE FOR ENTERING CHARACTERS

Entering alphabetical characters (example: TPS)

1 Open the Rapid key overlay.

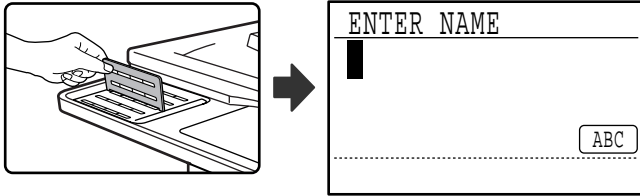

To switch between upper case letters and lower case letters, press the [SHIFT] key.

2 Enter "T", "P" and "S" with the letter keys.

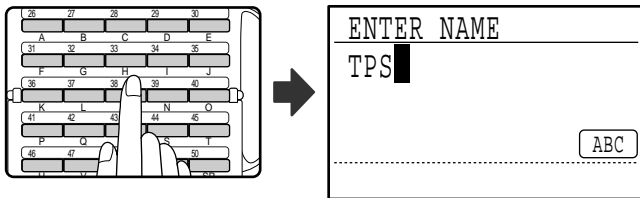

The letters are stored and the cursor moves to the space after the letters.



To change a character, press the [C] key. The character directly to the left of the cursor is cleared. If the cursor is over a character, that character is cleared.

Entering numbers (example: 123)

1 Enter "1", "2", and "3" with the numeric keys.

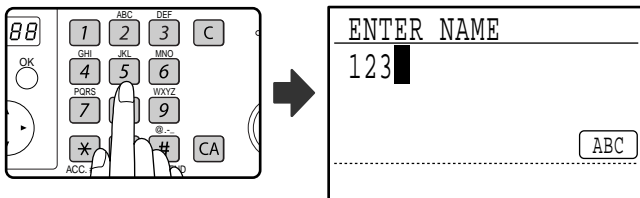

- To change a character, press the [C] key. The character directly to the left of the cursor is cleared.
- If the cursor is over a character, that character is cleared.

Entering symbols

1 Press the [SYMBOL] key.

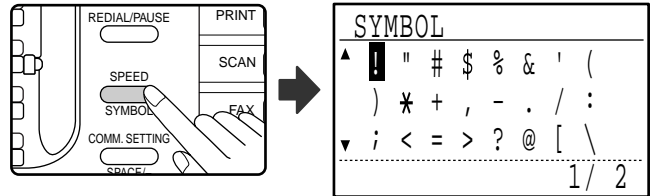

2 Select the symbol that you wish to enter with the [▼][▲][◀][▶] keys.

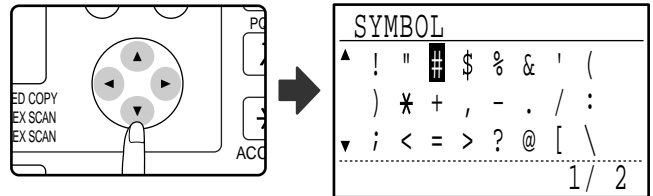

To move to the next page, move the cursor to the bottom line and press the [▼] key. To move back to the previous page, move the cursor to the top line and press the [▲] key. You can also change pages by pressing the [▶] key when the cursor is at the right end of the bottom line, or the [◀] key when the cursor is at the left end of the top line.

3 Press the [OK] key.

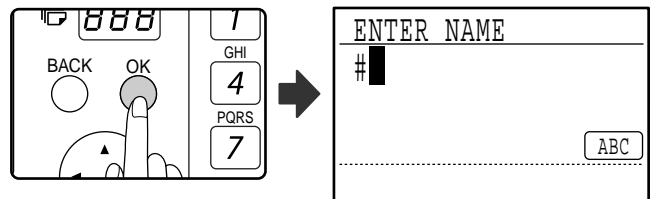

The symbol selected with the cursor is entered and you return to the character entry screen.



If the Rapid key overlay is opened or closed while a symbol is being selected, the symbol currently selected with the cursor is entered and you return to entry mode.

Entering special characters

Special characters are entered with the Rapid key overlay opened.

1 Press the [SP] key.

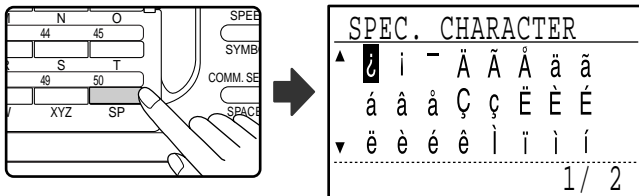

2 Select the special character that you wish to enter with the [▼][▲][◀][▶] keys.

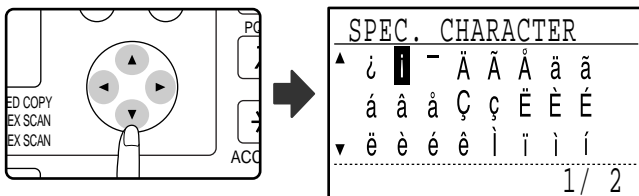

To move to the next page, move the cursor to the bottom line and press the [▼] key. To move back to the previous page, move the cursor to the top line and press the [▲] key. You can also change pages by pressing the [▶] key when the cursor is at the right end of the bottom line, or the [◀] key when the cursor is at the left end of the top line.

3 Press the [OK] key.

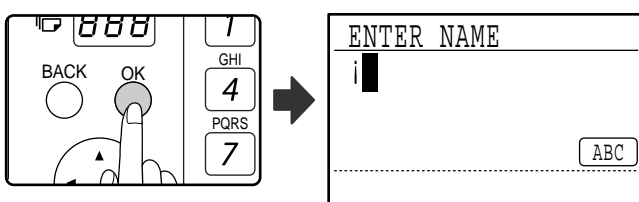

The special character selected with the cursor is entered and you return to the character entry screen.



Note If the Rapid key overlay is closed while a special character is being selected, the special character currently selected with the cursor is entered.

7

TROUBLESHOOTING

This chapter contains information to help you make efficient use of the fax features of the machine, including solutions to common problems.

WHEN A TRANSACTION REPORT IS PRINTED

The machine has been set to automatically print a transaction report to notify you of the result when a transmission is not successful or when the Broadcast transmission function is used.

When transmission is not successful and a transaction report similar to the following is printed, "FOLLOWING DATA CANNOT BE SENT. PLEASE HAND THIS REPORT TO XXX.", read the report and take appropriate action.

The transaction report is set at the factory to print at the times indicated in grey below, however, the times at which the report is printed can be changed in the system settings. (See "LIST SETTING - PRINT SELECTION" on page 99.)

- **Normal transmission:** ALWAYS PRINTS / ERROR ONLY / NEVER PRINTS
- **Broadcast transmission:** ALWAYS PRINTS / ERROR ONLY / NEVER PRINTS
- **Original image print setting*:** ALWAYS PRINTS / ERROR ONLY / NEVER PRINTS
- **Reception:** ALWAYS PRINTS / ERROR ONLY / NEVER PRINTS
- **Confidential reception:** ALWAYS PRINTS / NEVER PRINTS

The Transaction Report shows the date of transmission, the time transmission began, the other party's name, the duration of the operation, the number of pages, the type of transmission, the result, the department, and other information.

* You can select whether or not part of the transmitted original is printed with transaction reports that are printed for normal transmissions and broadcast transmissions.



The list count appears in the "#" column of the Transaction Report and a serial number appears in the FILE column. (These numbers are not related to the transaction.)

INFORMATION APPEARING IN THE TYPE/NOTE COLUMN

Information such as the type of transmission and type of error appears in the TYPE/NOTE column of the Transaction Report or Activity Report (page 92). The following notes may appear.

Sending result	Explanation
OK	Transmission was completed successfully.
BUSY	Transmission was not successful because the line was busy.
CANCEL	A transmission was cancelled while in progress or a stored transmission job was cancelled.
P. FAIL	The power was turned off or a power failure occurred.
NO RX POLL	A polling request was denied because the polling machine did not have its own fax number programmed.
PASS CODE # ERR	A polling request was denied because the other machine's fax number had not been stored as a polling passcode in your machine.
ORIG ERROR	When you attempted to send a fax from the SPF/RSPF in direct transmission mode, a misfeed occurred.
ERRORXXXXXX	Line conditions prevented the transmission from taking place normally. First two digits of transmission error number: Indicates an error code from 00 to 31. Last four digits of transmission error number: A code for use by service technicians.

Sending result	Explanation
XX-XX OK	When group dialling, broadcast transmission, or F-code relay request transmission was performed, xxx- : Indicates total number of transmissions. xxx OK : Indicates completed transmissions.
NO S ADD FUNC	When an F-code transmission was attempted, (1) The other machine did not have the F-code function. (2) An F-code was not programmed in the other machine.
S ADD TX FAIL	When an F-code transmission was attempted, (1) The sub-addresses did not match. (2) The passcodes did not match. (3) An F-code public box was set.
SA POLL ERR	When F-code public box transmission was attempted, (1) The F-code public box specified by the sub-address did not exist. (2) The sub-address specified a box other than an F-code public box.
PASSCODE# ERR	When F-code public box transmission was attempted, (1) The passcodes did not match.

Reception result	Explanation
OK	Reception was completed successfully.
P. FAIL	The power was turned off or a power failure occurred.
MEMORY FULL	The image memory became full during substitute reception to memory.
LENGTH OVER	The transmitted document was over 1500 mm long and therefore could not be received.
NO RX ROLL	When polling was attempted, (1) Your fax number (sender's number) was not programmed in your machine. (2) Your fax number was not programmed as a polling passcode number in the other machine.
RX NO POLL	When polling was attempted, (1) The other machine did not have a polling function. (2) The other machine did not have a document stored in polling memory.
ERRORxx xxxx	Line conditions prevented the reception from taking place normally. First 2 digits of line error code: Error code from 00 to 31. Last 4 digits of line error code: Code for use by service technicians.
XX-XX OK	When serial polling ended normally, xxx- : Indicates total number of transmissions. xxx OK : Indicates completed transmissions.
NO SA POLLING	When F-code polling was attempted, (1) The other machine did not have an F-code polling memory function. (2) An F-code was not programmed in the other machine. (3) The other machine did not have a document stored in polling memory.
SA POL TX ERR	When F-code polling was attempted, (1) The sub-addresses did not match. (2) The passcodes did not match. (3) The other machine's F-code memory boxes were for F-code relay request transmission or for F-code confidential transmission.
S ADD RX FAIL	When F-code reception was attempted, (1) The sub-addresses did not match or were not programmed. (2) The passcodes did not match or were not programmed. (3) An F-code polling memory box was programmed.
JUNK FAX ERR	Fax reception was denied by the reception denial function.

VIEWING THE COMMUNICATION ACTIVITY REPORT AT REGULAR INTERVALS

(Communication activity report)

Your machine keeps a record of the most recent 50 transactions (both transmissions and receptions) that were performed. The record includes the date of the transaction, the other party's name, the duration, and result. You can have the report automatically printed when the number of transactions exceeds 50, or at a specified time. This allows you to check the machine's activity at regular intervals.

The machine is initially set (factory default setting) to not print the report. To have the report printed, change the setting in the system settings. (See "LIST SETTING - AUTO LISTING" on page 99.)



- Refer to the table on "WHEN A TRANSACTION REPORT IS PRINTED" (page 90) for the notes that appear in the TYPE/NOTE column.
- The activity report can also be printed out on demand. (See "PRINTING LISTS OF PROGRAMMED INFORMATION, SETTINGS, AND COMMUNICATION ACTIVITY" on page 85.)

WHEN AN ALARM SOUNDS AND A WARNING MESSAGE IS DISPLAYED

When an error occurs during a transaction, an alarm will sound and a message will appear in the display. If one of the following messages appears, follow the instructions in the table.

Message (alarm sounds)	Meaning of message	Solution	Page
XXXXXX Line error.	An error prevented completion of the transaction.	Try the transaction again.	–
🔧 Maintenance required. Call for service. [OK]:RETURN	It is time for maintenance and inspection.	Contact your dealer.	–
Please return X original(s). [START]:CONTINUE	A misfeed occurred in the SPF/RSPF.	Reload the indicated number of originals.	12
📠 Open TRAY xx and add xxxx paper. [OK]:RETURN	A fax has been received but the paper tray does not have suitable paper.	Add paper.	"LOADING PAPER" in the Operation Guide for the machine
	The paper tray is open.	Close the paper tray.	–
🔧 Remove paper from the output tray and press [OK].	The upper part of the job separator is full of paper.	Remove the paper.	–
	A job separator error occurred.	Press the [CA] key to clear the error.	–
🔧 Clear paper path.	A paper misfeed occurred in the output section.	Remove the misfed paper.	"MISFEED REMOVAL" in the Operation Guide for the machine
🔧 Close the cover.	A machine cover is open.	Close the cover.	–

Message (alarm sounds)	Meaning of message	Solution	Page
⚠ Toner is low.	Toner is low.	Replace the toner cartridge.	"REPLACING THE TONER CARTRIDGE" in the Operation Guide for the machine
⚠ Add toner. Can not copy or print. [OK]:RETURN	There is no toner.	Replace the toner cartridge.	"REPLACING THE TONER CARTRIDGE" in the Operation Guide for the machine
Unfold original and return XX original(s) to the document feeder. [START]:CONTINUE	The detected original size is smaller than the actual original size, or a smaller size has been selected.	Place the originals again and make sure that the size indicated in the display is the same as the actual original size.	–

SELF-DIAGNOSTIC FUNCTION

The machine has a self-diagnostic function that automatically stops operation if a problem occurs in the machine. If a problem occurs in fax mode, the following display appears.

Message display	Action
⚠ Call for service. code:xx xx. Main code Sub code	Turn off the power and then turn it back on. If the error is not cleared, note the 2-digit main code and the 2-digit sub-code and then contact your dealer.

MESSAGES DURING NORMAL OPERATION

Message	Meaning of message
SENT xx% No.001 P-xxx	This appears when a direct transmission ends ("xx" indicates the number of pages).
READING xx% No.001 P-xxx	The original is being scanned into memory (during memory transmission).
Stand-by. 100% 22 AUG FRI 10:25	The machine is in the standby state.
ENTER DIAL #	This appears when the [SPEAKER] key has been pressed.

PROBLEMS AND SOLUTIONS

If you experience a problem with the fax function, first check the following table.

This section describes problems related to the fax function. For problems related to general operation of the machine, see "TROUBLESHOOTING" in the Operation Guide for the machine.

Problem	Check	Solution	Page
The machine does not operate.	Is the machine power switch turned on?	Turn the power switch ON.	"Power switch" on page 4
	Does the display show an error message?	Clear the error as instructed by the message.	"WHEN AN ALARM SOUNDS AND A WARNING MESSAGE IS DISPLAYED" on page 92
Dialling is not possible.	Is the correct dial mode set for your line?	Check your line and set the correct dial mode.	"DIAL MODE" on page 100
	Is the telephone line properly connected?	Check the connections.	"Line connection" on page 4
	Is the machine power switch turned on?	Turn the power switch ON.	"Power switch" on page 4
	Is the machine in fax mode?	Press the [FAX] key to set the machine to fax mode.	"BASIC PROCEDURE FOR SENDING FAXES" on page 17
Cannot send a fax.	Does the receiving fax machine have paper?	Check with the operator of the receiving machine.	-
	Does the receiving machine support G3 transmission?		
	Are the sub-address and passcode correct? (When using F-code transmission)		
	Is the receiving machine ready to receive?		
	Are you using a transmittable original size?	Check the transmittable sizes.	"ORIGINALS THAT CAN BE FAXED" on page 11
	Was the original size detected correctly?	Check size of the original.	"CHECKING THE SIZE OF A PLACED ORIGINAL" on page 13
	The message "Reading cancelled. Please retry sending operation." appears.	If you attempt transmission while the message "Warming-up." appears, the transmission may not take place correctly. Repeat the transmission.	-
The transmitted image prints out blank at the receiving side.	Was the original placed so that the correct side is scanned?	Make sure the original is placed so that the correct side is scanned.	"PLACING THE ORIGINAL" on page 12
	If the receiving machine is using thermal paper, was the thermal paper loaded with the wrong side out?	Check with the operator of the receiving machine.	-

Problem	Check	Solution	Page	
The transmitted image is distorted.	Were line conditions poor due to thunder or another reason?	Try the transmission again.	–	
	Were the resolution and exposure settings suitable?	Check the resolution and exposure settings.	"SELECTING RESOLUTION AND EXPOSURE SETTINGS" on page 14	
White or black lines appear in the transmitted image.	Is the document glass or the scanning glass for the SPF/RSPF (the long, narrow glass) dirty?	Clean the document glass or the scanning glass for the SPF/RSPF.	"ROUTINE MAINTENANCE" in the Operation Guide for the machine	
Transmission does not take place at the specified time.	Is the machine's clock set to the correct time?	Set the clock to the correct time.	"DATE & TIME SET" on page 104	
Printing does not take place after reception.	Does an error message appear regarding adding paper, replenishing toner, or a misfeed? (This means that printing is not possible.)	Restore printing capability as instructed by the display message. Printing will begin.	"WHEN AN ALARM SOUNDS AND A WARNING MESSAGE IS DISPLAYED" on page 92	
	Is forwarding (Inbound Routing function) selected in the Web page for a received fax?	If you need to print a received fax, ask your administrator. When the Inbound Routing function is enabled in the Web pages, received faxes are automatically forwarded to a specified address. If "Print at Error" is selected when Inbound Routing is enabled, received faxes will only be printed when an error occurs.	–	
A received fax prints out blank.	Was the wrong side of the original scanned in the transmitting machine?	Check with the operator of the transmitting machine.	–	
The received image is faint.	Is the original faint?	Ask the other party to re-send the fax using a suitable exposure setting.	–	
The received image is distorted.	Were line conditions poor due to thunder or another reason?	Ask the other party to send the fax again.	–	
Telephone	A dial tone is not heard through the speaker.	Is the volume set to "low"?	Set the speaker volume to "middle" or "high".	"SPEAKER VOLUME" on page 101
	The machine does not ring.	Has the ringer volume been turned off?	Set the ringer volume to "low", "middle", or "high".	"SPEAKER VOLUME" on page 101
	Dialling is not possible.	Is the telephone line properly connected?	Check the connections.	"Line connection" on page 4
		If an extension phone is connected to the machine, has the "EXTENSION TEL" setting been enabled?	Enable this setting.	"EXTENSION TEL" on page 102

8

SYSTEM SETTINGS

The system settings are used by the administrator (administrator of the machine) to customize certain features of the machine to better meet the needs of users.

This section explains system settings for the fax features of the machine. For system settings that are for the copy function, print function, and network scanner function, see the respective manuals for those functions. For system settings for general use of the machine, see the "SYSTEM SETTINGS GUIDE" in the Operation Guide for the machine.

To use the system settings, the administrator password must be entered.

For the initial administrator password set at the factory, see the Start Guide.



The system settings that can be used depend on what peripheral devices have been installed.

ADMINISTRATOR SETTINGS LIST

SYSTEM SETTINGS FOR THE FAX FUNCTION

Setting name	Page
LIST PRINT/SET	
LIST PRINT	99
LIST SETTING	99
INITIAL SETTING	
PAUSE TIME	100
OWN PASSCODE SET	101
SPEAKER VOLUME	101
TX/RX END SOUND	101
TX/RX END SOUND LENGTH	101
EXTENSION TEL	102
DISTINCTIVE RING	102
PBX SETTING	102
REMOTE RECEPTION	102
ACCOUNT CONTROL	103
ACCOUNT # SET	103
DATE & TIME SET	104
AUTO SUMMER TIME SETTING	104
DISABLE FAX PRINT HOLD	104
SENDING FUNCTION	
RES. CON. SET	105
AUTO REDUCE TX	105
ROTATE TX	105
PAGE COUNTER SET	105
SEND MODE	106
QUICK ON LINE TX	106
PRINT STATION # IN RCVD DATA	106
ACC. NAME PRINT	106

Setting name	Page
RECALL SETTING (BUSY)	106
RECALL SET (ERR)	107
RING TIMEOUT IN AUTO TX	107
AUTO COVER SHEET	108
RCV. FUNCTION	
#OF RINGS AT. RX	108
TRAY SELECTION	108
RECEIVED DATA PRINT CONDITION	109
AUTO RCV REDUCE TO REGULAR SIZE	109
DUPLEX RECEPTION	109
8 1/2x11 RX REDUCE PRINT	109
FW. RX DATA	110
RECEIVED DATA FW. STATION SET	110
EARLIER OUTPUT	110
ANTI JUNK FAX	110
ENTER JUNK FAX #	111
POLLING SECURITY	
POLLING SECURITY	111
POLLING PASSCODE # MODE	111

ADMINISTRATOR SETTINGS MENU

The system settings are accessed via the following menu structure.
 Refer to this menu when enabling or disabling the settings that are explained beginning on page 99.
 Some settings contain an additional level of settings (a settings screen).

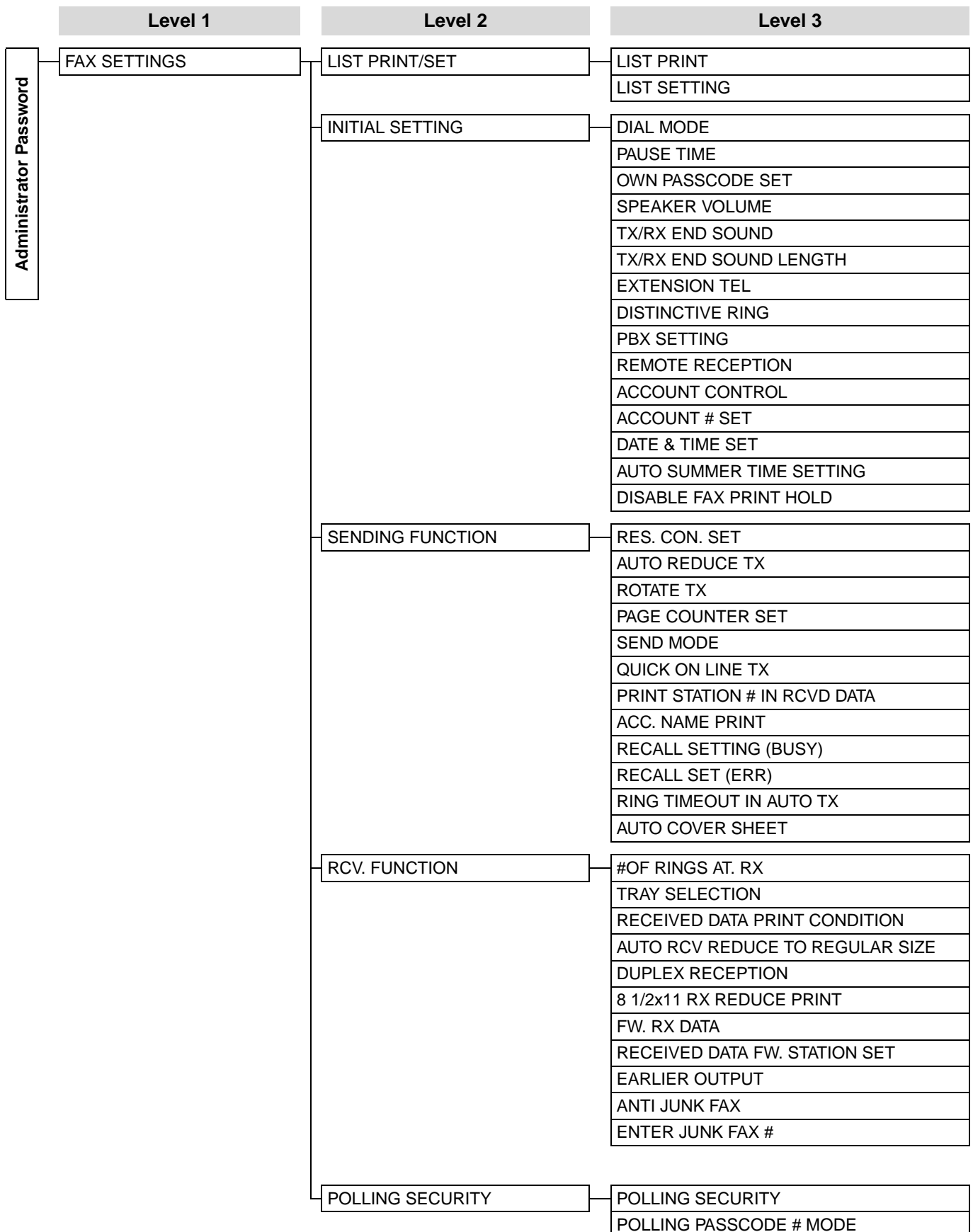

PROCEDURE FOR USING THE SYSTEM SETTINGS

The system settings can be accessed from any mode (copy, fax, print, and scan mode). When the setting is completed, you will return to the previous mode.

- Faxes cannot be sent or received while a system setting is being used.
- A system setting cannot be used while a fax is being sent or received, while a voice call is being made, or while a received fax is being printed.

INITIAL PROCEDURE

1 Press the [SPECIAL FUNCTION] key.

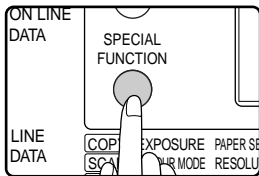

2 Select "SYSTEM SETTINGS" with the [▼] or [▲] key.

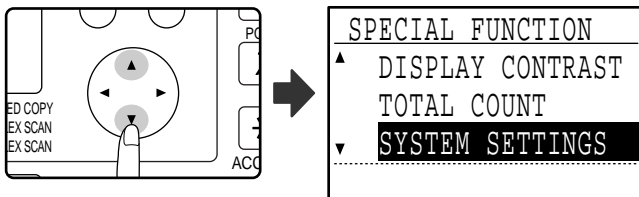

3 Press the [OK] key.

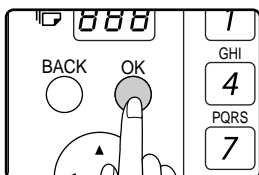

4 Enter the five-digit administrator password with the numeric keys.

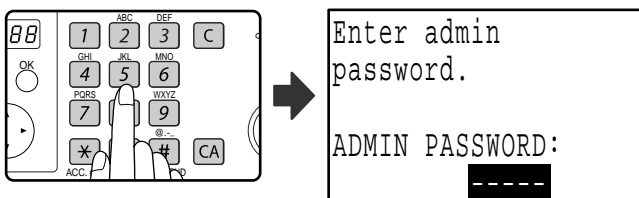

- As you enter each digit, "-" changes to "*".
- If make a mistake, press the [C] key and re-enter the number.
- If this is the first time you are programming the administrator password, enter the factory default code. (See "ADMINISTRATOR PASSWORD NUMBER: FACTORY SETTING" in the Operation Guide for the machine.

5 Select "FAX" with the [▼] or [▲] key.

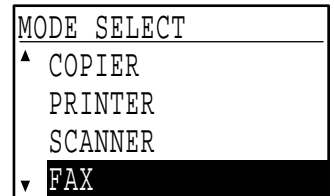

To use a system setting for copy mode, select "COPIER".

6 Press the [OK] key.



7 Select a setting for the desired setting as explained on the following pages.

Settings for the following functions are available:

- LIST PRINT/SET (page 99)
- INITIAL SETTING (page 100)
- SENDING FUNCTION (page 105)
- RCV. FUNCTION (page 108)
- POLLING SECURITY (page 111)

8 Press the [CA] key to exit the settings.



- To move back to the previous screen, press the [BACK] key.
- To cancel a setting before it is completed, press the [CA] key.
- See "ENTERING CHARACTERS" (page 86) for the procedure for entering letters.

SYSTEM SETTINGS FOR THE FAX FUNCTION

LIST PRINT/SET

This setting is used to print lists showing current system settings and other programmed information.

LIST PRINT

- 1 Follow steps 1 through 6 of "INITIAL PROCEDURE" (page 98).
- 2 Select "LIST PRINT/SET" with the [▼] or [▲] key and then press the [OK] key.
- 3 Select "LIST PRINT" with the [▼] or [▲] key and then press the [OK] key.
- 4 Select the desired list with the [▼] or [▲] key and then press the [OK] key.
 - "SYSTEM SET LIST", "JUNK FAX # LIST" or "ACC. USAGE LIST" can be selected.
 - Printing begins when you end the system setting.

SYSTEM SET LIST	This list shows the current system setting settings. It also shows the programmed sender's name, sender's fax number, polling permission numbers, and the fax forwarding number.
JUNK FAX # LIST	This shows the programmed fax numbers from which fax reception is to be blocked. (See "ENTER JUNK FAX #" on page 111.)
ACC. USAGE LIST	This shows the activity (communication time and number of pages) of each account.
INBOUND ROUTING LIST	This list shows various settings used at the time of inbound routing.

LIST SETTING

PRINT SELECTION

This setting is used to select the conditions for printing out transaction reports for normal transmission, broadcast transmission, original print, reception, and confidential reception.

TRANSMISSION	BROADCAST	ORIGINAL IMAGE PRINT SETTING
ALWAYS PRINTS	ALWAYS PRINTS	ALWAYS PRINTS
ERROR ONLY	ERROR ONLY	ERROR ONLY
NEVER PRINTS	NEVER PRINTS	NEVER PRINTS
RECEPTION	CONF. RECEPTION	
ALWAYS PRINTS	ALWAYS PRINTS	
ERROR ONLY	NEVER PRINTS	
NEVER PRINTS		

Normally the settings indicated by shading  above are selected.

- 1 Follow steps 1 through 6 of "INITIAL PROCEDURE" (page 98).
- 2 Select "LIST PRINT/SET" with the [▼] or [▲] key and then press the [OK] key.
- 3 Select "LIST SETTING" with the [▼] or [▲] key and then press the [OK] key.
- 4 Select "PRINT SELECTION" with the [▼] or [▲] key and then press the [OK] key.
- 5 Select the type of transmission with the [▼] or [▲] key and then press the [OK] key. "TRANSMISSION", "BROADCAST", "ORIGINAL IMAGE PRINT SETTING", "RECEPTION" or "CONF. RECEPTION" can be selected.
- 6 Select the desired print setting with the [▼] or [▲] key and then press the [OK] key.
 - If you selected "TRANSMISSION", select "ALWAYS PRINTS", "ERROR ONLY", or "NEVER PRINTS".
 - If you selected "BROADCAST", select "ALWAYS PRINTS", "ERROR ONLY", or "NEVER PRINTS".
 - If you selected "ORIGINAL IMAGE PRINT SETTING", select "ALWAYS PRINTS", "ERROR ONLY", or "NEVER PRINTS".
 - If you selected "RECEPTION", select "ALWAYS PRINTS", "ERROR ONLY", or "NEVER PRINTS".
 - If you selected "CONF. RECEPTION", select "ALWAYS PRINTS" or "NEVER PRINTS".



"ORIGINAL IMAGE PRINT SETTING" is used to have part of the first page of the transmitted document printed on the transaction report. This setting is not effective when the transaction report is set to not print out.

AUTO LISTING

This setting is used to have the activity report that is stored in the machine's memory printed out at regular intervals. You can choose to have the report automatically printed each time the number of stored transactions exceeds 50, or have the report printed at a specified time every day (only once per day). You can also enable both print methods.

The report is normally set to not print out. To have the report automatically printed when the number of stored transactions (the combined total of transmissions and receptions) exceeds 50, select "AUTO PRINT REPT AT LIMIT (50)".

To have the report printed at a specified time, enable "PRINT DAILY AT DESIGNATED TIME" and enter the desired time.

- 1 Follow steps 1 through 6 of "INITIAL PROCEDURE" (page 98).

- 2** Select "LIST PRINT/SET" with the [▼] or [▲] key and then press the [OK] key.
- 3** Select "LIST SETTING" with the [▼] or [▲] key and then press the [OK] key.
- 4** Select "AUTO LISTING" with the [▼] or [▲] key and then press the [OK] key.
- 5** Select "AUTO PRINT REPT AT LIMIT (50)" with the [▼] or [▲] key and then press the [OK] key.
 - The setting is enabled and a checkmark appears in the checkbox.
 - If this procedure is performed when the setting is enabled, the checkmark will be cleared and the setting disabled.
- 6** If you wish to have the activity report printed at regular intervals, go to step 7. If you have finished selecting settings, press the [BACK] key.
- 7** Select "PRINT DAILY AT DESIGNATED TIME" with the [▼] or [▲] key and then press the [OK] key.
- 8** Select "SETTING" with the [▼] or [▲] key and then press the [OK] key.
- 9** Enter the printout time with the numeric keys and press the [OK] key.

If you make a mistake, move the cursor to the incorrect digit with the [◀] or [▶] key (the cursor should be over the digit), and then enter the correct digit.



- After step 9 you will return to step 8. If you need to change the set time, follow steps 8 and 9 to enter the new time.
- To cancel a "PRINT DAILY AT DESIGNATED TIME" setting, follow these steps:
 - (1) Select "CANCEL" in step 8 and then press the [OK] key.
 - (2) Select "CANCEL" with the [▼] or [▲] key and then press the [OK] key.
- If "AUTO PRINT REPT AT LIMIT (50)" is not enabled and the number of recorded transactions exceeds 50, each new transaction will delete the oldest transaction.
- The activity report can also be printed out on demand. (See "PRINTING LISTS OF PROGRAMMED INFORMATION, SETTINGS, AND COMMUNICATION ACTIVITY" on page 85.)

INITIAL SETTING

These settings are used to change the default settings (initially set at the factory) for the various fax functions to settings that better meet your needs.

DIAL MODE

This setting is used to set the appropriate dial mode for the line connected to the machine. Select tone for a tone dial line or pulse for a pulse dial line. Most lines use tone dialling.

- 1** Follow steps 1 through 6 of "INITIAL PROCEDURE" (page 98).
- 2** Select "INITIAL SETTING" with the [▼] or [▲] key and then press the [OK] key.
- 3** Select "DIAL MODE" with the [▼] or [▲] key and then press the [OK] key.
- 4** Select "TONE" or "PULSE" with the [▼] or [▲] key and then press the [OK] key.

Select the appropriate mode for your telephone line type.

PAUSE TIME

This setting is used to select the duration of pauses that are inserted in destination fax numbers. Normally the setting is 2 seconds, which means that each time the [PAUSE] key is pressed when dialling or storing a fax number, a pause of 2 seconds is inserted. The pause time can be set to any number of seconds from 1 to 15.

- 1** Follow steps 1 through 6 of "INITIAL PROCEDURE" (page 98).
- 2** Select "INITIAL SETTING" with the [▼] or [▲] key and then press the [OK] key.
- 3** Select "PAUSE TIME" with the [▼] or [▲] key and then press the [OK] key.
- 4** Enter the pause time in seconds ("01" to "15") with the numeric keys and then press the [OK] key.

If you make a mistake, move the cursor to the incorrect digit with the [◀] or [▶] key (the cursor should be over the digit), and then enter the correct digit.

OWN PASSCODE SET

Use this setting to program the fax number of the machine and the name of the user. The programmed name and number are printed at the top of each fax page you send. The number is also used as a passcode when performing polling reception "USING THE POLLING FUNCTION" (page 36).

You can check your programmed name and number by printing out the "SYSTEM SET LIST". (Page 99)

- A maximum of 20 digits can be stored for the fax number.
- A maximum of 18 letters can be stored for the name.

- 1 Follow steps 1 through 6 of "INITIAL PROCEDURE" (page 98).**
- 2 Select "INITIAL SETTING" with the [▼] or [▲] key and then press the [OK] key.**
- 3 Select "OWN PASSCODE SET" with the [▼] or [▲] key and then press the [OK] key.**
- 4 Select "STORE" with the [▼] or [▲] key and then press the [OK] key.**
- 5 Enter your fax number with the numeric keys and then press the [OK] key.**
 - If you make a mistake, press the [C] key and re-enter the number.
 - To enter "+", press the [*] key.
- 6 Enter your name and then press the [START] key (Ⓢ).**
See "ENTERING CHARACTERS" (page 86) for the procedure for entering letters.



To clear the programmed fax number and name, follow these steps:

- (1) Select "DELETE" in step 4 and then press the [OK] key.
- (2) Select "DELETE" with the [▼] or [▲] key and then press the [OK] key.

SPEAKER VOLUME

This setting is used to adjust the on-hook volume, the ringing volume, the line monitor volume, the TX/RX end sound volume, the original scanning end sound volume, and the tone output volume. All volume settings are initially set to "MIDDLE".

- 1 Follow steps 1 through 6 of "INITIAL PROCEDURE" (page 98).**
- 2 Select "INITIAL SETTING" with the [▼] or [▲] key and then press the [OK] key.**
- 3 Select "SPEAKER VOLUME" with the [▼] or [▲] key and then press the [OK] key.**

- 4 Select name of the volume that you wish to adjust with the [▼] or [▲] key and then press the [OK] key.**
- 5 Select the desired volume level with the [▼] or [▲] key and then press the [OK] key.**
 - "HIGH", "MIDDLE" or "LOW" can be selected for the on hook volume.
 - "HIGH", "MIDDLE", "LOW" or "OFF" can be selected for volumes other than the on hook volume.

TX/RX END SOUND

This setting is used to select the beep pattern that signals the end of transmission or reception. "PATTERN 1", "PATTERN 2" or "PATTERN 3" can be selected.

- 1 Follow steps 1 through 6 of "INITIAL PROCEDURE" (page 98).**
- 2 Select "INITIAL SETTING" with the [▼] or [▲] key and then press the [OK] key.**
- 3 Select "TX/RX END SOUND" with the [▼] or [▲] key and then press the [OK] key.**
- 4 Select "SEND" or "RECEIVE" with the [▼] or [▲] key and then press the [OK] key.**
- 5 Select "PATTERN 1", "PATTERN 2", or "PATTERN 3" with the [▼] or [▲] key and then press the [OK] key.**

Before pressing the [OK] key to store your selection, you can press the [*] key to listen to the selected pattern.

TX/RX END SOUND LENGTH

This setting is used to select the length of the end sound in seconds. Selections are "2.0 sec", "2.5 sec", "3.0 sec", "3.5 sec", and "4.0 sec". "3.0 sec" is normally selected.

- 1 Follow steps 1 through 6 of "INITIAL PROCEDURE" (page 98).**
- 2 Select "INITIAL SETTING" with the [▼] or [▲] key and then press the [OK] key.**
- 3 Select "TX/RX END SOUND LENGTH" with the [▼] or [▲] key and then press the [OK] key.**
- 4 Select the number of seconds with the [▼] or [▲] key and then press the [OK] key.**

EXTENSION TEL

Enable this setting when an extension telephone is connected to the machine. An extension telephone connected to the machine cannot be used until this setting is enabled. The initial setting is enabled.

- 1** Follow steps 1 through 6 of "INITIAL PROCEDURE" (page 98).
- 2** Select "INITIAL SETTING" with the [▼] or [▲] key and then press the [OK] key.
- 3** Select "EXTENSION TEL" with the [▼] or [▲] key and then press the [OK] key.
 - The setting is enabled and a checkmark appears in the checkbox.
 - If this procedure is performed when the setting is enabled, the checkmark will be cleared and the setting disabled.

DISTINCTIVE RING (Varies depending on country and region)

If multiple telephone numbers have been assigned to your telephone line, the number called can be identified by its ringing pattern. By using one number for voice calls and another number for faxes, you can tell which type of call you are receiving by the ringing pattern. You can set your machine to automatically receive faxes when your fax number is called by setting the pattern that corresponds to your fax number. Normally "OFF" is selected.

- 1** Follow steps 1 through 6 of "INITIAL PROCEDURE" (page 98).
- 2** Select "INITIAL SETTING" with the [▼] or [▲] key and then press the [OK] key.
- 3** Select "DISTINCTIVE RING" with the [▼] or [▲] key and then press the [OK] key.
- 4** Select "STANDARD" or "OFF" with the [▼] or [▲] key, and then press the [OK] key.

PBX SETTING

(Varies depending on country and region)

This program is used to have faxes routed to the outside line by default when the unit is connected to a private branch exchange. By default, this program is disabled. To activate the program, touch the PBX CONNECTION checkbox to make a checkmark appear, and then select the method for connecting to an outside line by touching the "FLASH" key or the "ID" key.

If you connect to the outside line by making a register call, select "FLASH". If you connect to the outside line by dialing a number, select "ID". If you select "ID", enter the number that is dialed to connect to the outside line (maximum of 3 digits). The number is entered by touching the entry boxes for each of the digits and using the [▼, ▲] keys to enter the appropriate digit in each box. Be sure to enter the number from the box on the left. Any digit from 0 to 9 can be entered in the left box, and digits 0 to 9 and "-" can be entered in the central and right boxes. If your external line number is two digits, enter "-" in the right box, and if your external line number is one digit, enter "-" in the central and right boxes.

When PBX CONNECTION is enabled, the "R" key appears in the base screen of fax mode. This key can be touched to switch to fax transmission inside your PBX. If the number you are storing in either of these screens is inside your PBX, touch the "R" key before entering the number to have the fax transmission automatically routed to the PBX when the number is dialed.



The "R" key is not available in UK, Belgium and the Netherlands.

REMOTE RECEPTION

(Only when an extension phone is connected)

When a call is received on an extension phone connected to the machine, fax reception can be activated by entering a 1-digit number and pressing [*] twice on the phone's keypad. This 1-digit number is called the remote reception number, and you can set it to any number from "0" to "9". Normally the remote reception number is set to "5".

- 1** Follow steps 1 through 6 of "INITIAL PROCEDURE" (page 98).
- 2** Select "INITIAL SETTING" with the [▼] or [▲] key and then press the [OK] key.
- 3** Select "REMOTE RECEPTION" with the [▼] or [▲] key and then press the [OK] key.
- 4** Enter a new remote number with the numeric keys (0 to 9) and then press the [OK] key.



If a remote number has been previously stored, the newly entered remote number overwrites the old number.

ACCOUNT CONTROL

This setting is used to enable (or disable) auditing mode. Auditing mode is initially disabled. When this setting is enabled, the operator must enter a valid 5-digit account number in order to use the fax function of the machine.

This function also tracks fax communication time and fax pages for each account.

To enable auditing mode, program an account number as explained in "ACCOUNT # SET".

- 1** Follow steps 1 through 6 of "INITIAL PROCEDURE" (page 98).
- 2** Select "INITIAL SETTING" with the [▼] or [▲] key and then press the [OK] key.
- 3** Select "ACCOUNT CONTROL" with the [▼] or [▲] key and then press the [OK] key.
 - The setting (auditing mode) is enabled and a checkmark appears in the checkbox.
 - If this procedure is performed when the setting is enabled, the checkmark will be cleared and the setting disabled.

ACCOUNT # SET

This setting is used to program, delete, and change account numbers for fax mode. Up to 50 account numbers can be programmed.

- Each account number has five digits. When you have finished programming one account number, you can continue programming other account numbers.
- Two methods are available for deleting account numbers: deleting an individual account number and deleting all account numbers.
- To change an account number, enter the account number to be changed and then enter a new account number. After an account number is changed, another account number can be changed.

Programming a new account number

- 1** Follow steps 1 through 6 of "INITIAL PROCEDURE" (page 98).
- 2** Select "INITIAL SETTING" with the [▼] or [▲] key and then press the [OK] key.
- 3** Select "ACCOUNT # SET" with the [▼] or [▲] key and then press the [OK] key.
- 4** Select "ENTER" with the [▼] or [▲] key and then press the [OK] key.
- 5** Enter the new account number (00001 to 99999) with the numeric keys and then press the [OK] key.

If the number is not correct, press the [C] key and re-enter the number.

- 6** Enter an account name (up to 18 characters) and then press the [OK] key.
 - See "ENTERING CHARACTERS" (page 86) for the procedure for entering letters.
 - Press the [OK] key to return to the screen of step 3. To program another account number, repeat steps 5 and 6. To exit, press the [BACK] key in step 5.

Deleting a single account number

- 1** In step 4 of "Programming a new account number", select "DELETE" and then press the [OK] key.
- 2** Select "DELETE 1 ACC." with the [▼] or [▲] key and then press the [OK] key.
- 3** Enter the account number (5 digits) with the numeric keys and then press the [OK] key.
 - If the number is not correct, press the [C] key and re-enter the number.
 - Enter a programmed account number. If you enter an account number that has not been programmed, you will not advance to step 4 when the [OK] key is pressed. To cancel the deletion, press the [BACK] key.
- 4** Select "YES" with the [▼] or [▲] key and then press the [OK] key.
 - Check the account number that appears in the display before deleting it.
 - Press the [OK] key to return to the screen of step 3. To delete another number, repeat steps 3 through 4. To exit, press the [BACK] key in step 3.

Deleting all account numbers

- 1** In step 4 of "Programming a new account number", select "DELETE" and then press the [OK] key.
- 2** Select "DELETE ALL ACC." with the [▼] or [▲] key and then press the [OK] key.
- 3** Select "YES" with the [▼] or [▲] key and then press the [OK] key.

To cancel the deletion, select "NO" and press the [OK] key.

Changing an account number

- 1** In step 4 of "Programming a new account number", select "CHANGE" and press the [OK] key.
- 2** Enter the account number that you wish to change and then the new account number, and press the [OK] key.
 - If you make a mistake, press the [C] key and then enter the correct number.
 - If you enter an account number that has not been programmed, re-enter the correct account number.

3 Enter an account name (up to 18 characters long) and press the [OK] key.

- See "ENTERING CHARACTERS" (page 86) for the procedure for entering letters.
- If you do not wish to change the account name, press the [OK] key.
- Press the [OK] key. You will return to the screen of step 2. To change another number, repeat steps 2 and 3. To exit, press the [BACK] key in step 2.

DATE & TIME SET

This setting is used to set the machine's internal clock to the current date and time.

- 1 Follow steps 1 through 6 of "INITIAL PROCEDURE" (page 98).
- 2 Select "INITIAL SETTING" with the [▼] or [▲] key and then press the [OK] key.
- 3 Select "DATE & TIME SET" with the [▼] or [▲] key and then press the [OK] key.
- 4 Enter the year (2011 to 2062), month (01 to 12), and day (01 to 31) with the numeric keys, and then press the [OK] key.
 - For the year, enter the last two digits of the year.
 - The range of days that can be entered for the selected month is displayed.
- 5 Enter the time in 24-hour format with the numeric keys and press the [OK] key.

Enter a number from 00 to 23 for the hour and a number from 00 to 59 for the minute.



If you make a mistake in step 4 or 5, move the cursor to the mistake with the [◀] or [▶] key and then enter the correct digit.

AUTO SUMMER TIME SETTING

Turn on this setting to have the internal clock automatically move forward and backward at the beginning and end of Summer Time.

The last Sunday in May: 1:00 A.M. → 2:00 A.M.*

The last Sunday in October: 1:00 A.M. → 0:00 A.M.*

* Varies depending on country and region.

- 1 Follow steps 1 through 6 of "INITIAL PROCEDURE" (page 98).
- 2 Select "INITIAL SETTING" with the [▼] or [▲] key and then press the [OK] key.
- 3 Select "AUTO SUMMER TIME SETTING" with the [▼] or [▲] key and then press the [OK] key.
 - The setting is turned on and a checkmark appears in the checkbox.
 - If this procedure is performed when the setting is turned on, the checkmark is cleared and the setting turned off.

DISABLE FAX PRINT HOLD

This setting is used to disable the fax print hold function, which holds received faxes in memory instead of printing them as they are received. (Page 29)
Normally the fax print hold function is disabled.

- 1 Follow steps 1 through 6 of "INITIAL PROCEDURE" (page 98).
- 2 Select "INITIAL SETTING" with the [▼] or [▲] key and press the [OK] key.
- 3 Select "DISABLE FAX PRINT HOLD" with the [▼] or [▲] key and press the [OK] key.
 - The setting (which disables fax print hold) is enabled and a checkmark appears in the checkbox.
 - If this procedure is performed when the setting is enabled, the checkmark will be cleared and the setting disabled (fax print hold is enabled).

SENDING FUNCTION

These settings are used to change the default settings (initially set at the factory) for the various fax transmission functions to settings that better meet your needs.

RES. CON. SET

This setting is used to adjust the exposure level when scanning an original to be faxed. The initial setting is standard resolution and auto exposure mode.

- 1 Follow steps 1 through 6 of "INITIAL PROCEDURE" (page 98).
- 2 Select "SENDING FUNCTION" with the [▼] or [▲] key and then press the [OK] key.
- 3 Select "RES. CON. SET" with the [▼] or [▲] key and press the [OK] key.
- 4 Select the resolution setting with the [▼] or [▲] key and the exposure mode with the [◀] or [▶] key, and then press the [OK] key.

See page 14 for information on selecting the resolution and contrast settings.

AUTO REDUCE TX

This setting is used to have transmitted faxes reduced to match the size of the other machine's printing paper. "AUTO REDUCE TX" is normally enabled. If the setting is disabled, documents are faxed in their original size. Because the size is not adjusted to match the size of the printing paper, part of the received fax may be cut off.

- 1 Follow steps 1 through 6 of "INITIAL PROCEDURE" (page 98).
- 2 Select "SENDING FUNCTION" with the [▼] or [▲] key and then press the [OK] key.
- 3 Select "AUTO REDUCE TX" with the [▼] or [▲] key and then press the [OK] key.
 - "AUTO REDUCE TX" is enabled and a checkmark appears in the checkbox.
 - If this procedure is performed when the setting is enabled, the checkmark will be cleared and the setting disabled.

ROTATE TX

This setting is used to select whether or not an A4, A5R or 8-1/2" x 11" size original that is oriented vertically will be rotated to a horizontal orientation before transmission. Rotation is normally enabled, and vertically oriented originals are rotated counterclockwise. (A4, A5R and 8-1/2" x 11" size originals that are oriented horizontally are not rotated.)

Rotation transmission can be selected separately for different original sizes. To disable a rotation setting, clear the checkbox from the appropriate setting.

- 1 Follow steps 1 through 6 of "INITIAL PROCEDURE" (page 98).
- 2 Select "SENDING FUNCTION" with the [▼] or [▲] key and then press the [OK] key.
- 3 Select "ROTATE TX" with the [▼] or [▲] key and then press the [OK] key.
- 4 Select the desired original size and press the [OK] key.
 - Size selections are A4, A5R and 8-1/2" x 11".
 - When a checkmark appears in the checkbox of the selected original size, rotation transmission is enabled for that size.
 - If the procedure is performed when the setting is enabled, the checkmark will be cleared and the setting disabled.
- 5 To change the setting for another original size, repeat step 4.

PAGE COUNTER SET

This setting lets you select whether page numbers are printed at the top of fax pages by the receiving machine. The normal setting is to have page numbers printed.

- 1 Follow steps 1 through 6 of "INITIAL PROCEDURE" (page 98).
- 2 Select "SENDING FUNCTION" with the [▼] or [▲] key and then press the [OK] key.
- 3 Select "PAGE COUNTER SET" with the [▼] or [▲] key and then press the [OK] key.
 - The setting is enabled (page numbers will be printed) and a checkmark appears in the checkbox.
 - If the procedure is performed when the setting is enabled, the checkmark will be cleared and the setting disabled.



When a fax is sent by memory transmission, the page number and total number of pages appear at the top of each fax page. When a fax is sent by Quick On-line transmission or direct transmission, only the page number appears.

SEND MODE

This setting is used to select whether the default mode for sending faxes is memory transmission or direct transmission. The initial setting is "MEMORY TX".

- 1** Follow steps 1 through 6 of "INITIAL PROCEDURE" (page 98).
- 2** Select "SENDING FUNCTION" with the [▼] or [▲] key and then press the [OK] key.
- 3** Select "SEND MODE" with the [▼] or [▲] key and then press the [OK] key.
- 4** Select "MEMORY TX" or "DIRECT TX" with the [▼] or [▲] key and then press the [OK] key.

QUICK ON LINE TX

This setting is used to select whether or not quick on-line transmission (transmission while original pages are being scanned into memory) takes place when a memory transmission is performed.

If quick on-line transmission is disabled, transmission will not begin until all original pages have been scanned into memory.

Normally quick on-line transmission is enabled. When this function is disabled, transmission will not begin until all pages of the document have been scanned. Note that this setting does not apply to manual transmission. (See "Storing transmission jobs (memory transmission)" on page 23.)

- 1** Follow steps 1 through 6 of "INITIAL PROCEDURE" (page 98).
- 2** Select "SENDING FUNCTION" with the [▼] or [▲] key and then press the [OK] key.
- 3** Select "QUICK ON LINE TX" with the [▼] or [▲] key and then press the [OK] key.
 - Quick on-line is enabled and a checkmark appears in the checkbox.
 - If this procedure is performed when quick on-line is enabled, the checkmark will be cleared and quick on-line disabled.

PRINT STATION # IN RCVD DATA

This setting lets you select the position (inside or outside the original image) of the date and sender's information that are printed at the top of each fax page you send. Normally outside the original image is selected. To have your name and number printed inside the original image, select "IN DATA".

For more detailed information on the position of each setting, see "Position of sender information" (page 41).

- 1** Follow steps 1 through 6 of "INITIAL PROCEDURE" (page 98).
- 2** Select "SENDING FUNCTION" with the [▼] or [▲] key and then press the [OK] key.
- 3** Select "PRINT STATION # IN RCVD DATA" with the [▼] or [▲] key and then press the [OK] key.
- 4** Press the [▼] or [▲] key to select "OUT" or "IN DATA", and then press the [OK] key.

ACC. NAME PRINT

When using auditing mode, this setting determines whether or not the recipient is notified of the sender's account name when a fax is sent. This setting is initially disabled (the recipient is not notified).

- 1** Follow steps 1 through 6 of "INITIAL PROCEDURE" (page 98).
- 2** Select "SENDING FUNCTION" with the [▼] or [▲] key and then press the [OK] key.
- 3** Select "ACC. NAME PRINT" with the [▼] or [▲] key and then press the [OK] key.
 - The setting is enabled and a checkmark appears in the checkbox.
 - This setting is only effective if auditing mode is enabled.
 - If this procedure is performed when the setting is enabled, the checkmark will be cleared and the setting disabled.

RECALL SETTING (BUSY)

This setting is used to set the number of recall attempts and the interval between recall attempts when a transmission is not successful due to the line being busy or other reason.

Normally the machine is set to make 2* recall attempts at intervals of 3* minutes.

If you do not wish to have recalling take place, set the number of attempts to "0" (steps 6 and 7).

* Varies depending on country and region.

- 1** Follow steps 1 through 6 of "INITIAL PROCEDURE" (page 98).
- 2** Select "SENDING FUNCTION" with the [▼] or [▲] key and then press the [OK] key.
- 3** Select "RECALL SETTING (BUSY)" with the [▼] or [▲] key and then press the [OK] key.

If you do not wish to change the recall interval setting, go to step 6.
- 4** Select "RECALL INTERVAL" with the [▼] or [▲] key and then press the [OK] key.

5 Enter the recall interval (01 to 15)* with the numeric keys and then press the [OK] key.

- The recall interval can be set from 1 to 15* minutes.
- After finishing step 5, if you do not wish to change the number of recall attempts, press the [BACK] key to exit.

* Varies depending on country and region.

6 Select "RECALL TIMES" with the [▼] or [▲] key and then press the [OK] key.

7 Enter the number of recall attempts with the numeric keys and then press the [OK] key.

- If you do not wish to have recalling take place, set the number of attempts to "0".



- If you made a mistake in step 5 or step 7, move the cursor to the mistake with the [◀] or [▶] key and enter the correct number.
- Even if this setting is enabled, the machine will not re-attempt the call when a fax is sent by manual transmission.

RECALL SET (ERR)

When sending a fax, this setting is used to select whether or not the machine will automatically re-attempt the call if the transmission fails due to a line error. Normally the machine is set to make 1* recall attempt at intervals of 1* minute.

If you do not wish to have recalling take place, set the number of attempts to "0" (steps 6 and 7).

* Varies depending on country and region.

1 Follow steps 1 through 6 of "INITIAL PROCEDURE" (page 98).

2 Select "SENDING FUNCTION" with the [▼] or [▲] key and then press the [OK] key.

3 Select "RECALL SET(ERR)" with the [▼] or [▲] key and then press the [OK] key.

If you do not wish to change the recall interval setting, go to step 6.

4 Select "RECALL INTERVAL" with the [▼] or [▲] key and then press the [OK] key.

5 Enter the recall interval (00 to 15) with the numeric keys and then press the [OK] key.

- The recall interval can be set from 0 to 15 minutes.
- After finishing step 5, if you do not wish to change the number of recall attempts, press the [BACK] key to exit.

6 Select "RECALL TIMES" with the [▼] or [▲] key and then press the [OK] key.

7 Enter the number of recall attempts with the numeric keys and then press the [OK] key.

- If you do not wish to have recalling take place, set the number of attempts to "0".
- If the recall interval is set to "0", the machine will immediately call again after the connection is broken due to the line error.



- If you made a mistake in step 5, move the cursor to the mistake with the [◀] or [▶] keys and enter the correct number.
- Even if this setting is enabled, the machine will not re-attempt the call when a fax is sent by manual transmission.

RING TIMEOUT IN AUTO TX

When sending a fax by automatic transmission (see "Storing transmission jobs (memory transmission)" on page 23), this setting lets you select the amount of time that the machine waits before breaking the connection when the other machine does not answer your machine's call. If the other machine does not respond within this set time, your machine will automatically break the connection. Time selections are "30 SEC.", "45 SEC." and "60 SEC.". Normally "45 SEC." is selected.*

* Varies depending on country and region.

1 Follow steps 1 through 6 of "INITIAL PROCEDURE" (page 98).

2 Select "SENDING FUNCTION" with the [▼] or [▲] key and then press the [OK] key.

3 Select "RING TIMEOUT IN AUTO TX" with the [▼] or [▲] key and then press the [OK] key.

4 Select the time with the [▼] or [▲] key and then press the [OK] key.

Selections for the call time are "30 SEC.", "45 SEC.", "60 SEC.".*

* Varies depending on country and region.

AUTO COVER SHEET

When this setting is enabled, a cover page is automatically generated and added to each fax transmission. The cover page shows the date, time, destination name, sender's name, sender's fax number, number of pages, and a message if the message function is selected. A cover sheet cannot be added when scanning a document into the public box or F-code public box (polling memory), or when performing polling, F-code relay broadcast transmission, or manual transmission. Normally this setting is disabled (a cover sheet is not added).

- 1** Follow steps 1 through 6 of "INITIAL PROCEDURE" (page 98).
- 2** Select "SENDING FUNCTION" with the [▼] or [▲] key and then press the [OK] key.
- 3** Select "AUTO COVER SHEET" with the [▼] or [▲] key and then press the [OK] key.
- 4** Select "YES" with the [▼] or [▲] key and then press the [OK] key.



If you do not wish cover sheets to be added to transmissions, select "NO" in step 4 and press the [OK] key.

RCV. FUNCTION

These settings are used to change the default settings (initially set at the factory) for the various fax reception functions to settings that better meet your needs.

#OF RINGS AT. RX

When the reception mode is set to auto, this setting is used to select the number of rings on which the machine automatically receives a call and begins fax reception. (See "RECEIVING A FAX" on page 27.) Any number of rings from 0 to 9 can be selected.* Normally "2" is selected.

* Varies depending on country and region.

- 1** Follow steps 1 through 6 of "INITIAL PROCEDURE" (page 98).
- 2** Select "RCV. FUNCTION" with the [▼] or [▲] key and then press the [OK] key.
- 3** Select "#OF RINGS AT. RX" with the [▼] or [▲] key and then press the [OK] key.
- 4** Enter the number of rings (0 to 9) with the numeric keys and then press the [OK] key.

The number of rings can be set to any number from 0 to 9.



If the number of rings is set to 0, the machine will receive faxes without ringing.

#OF RINGS MAN.RX

Even if reception mode is set to manual when the fax is received, this program automatically switches the settings from manual to automatic and initiates reception when the number of ring tones reaches the number set by the program. Any number of rings from 0 to 9 can be selected. Normally "0" is selected.

- 1** Follow steps 1 through 6 of "INITIAL PROCEDURE" (page 98).
- 2** Select "RCV. FUNCTION" with the [▼] or [▲] key and then press the [OK] key.
- 3** Select "#OF RINGS MAN.RX" with the [▼] or [▲] key and then press the [OK] key.
- 4** Enter the number of rings (0 to 9) with the numeric keys and then press the [OK] key.

The number of rings can be set to any number from 0 to 9.
* Varies depending on country and region.

TRAY SELECTION

This setting is used to select which output trays can be used for received faxes. All output trays are initially enabled.

- 1** Follow steps 1 through 6 of "INITIAL PROCEDURE" (page 98).
- 2** Select "RCV. FUNCTION" with the [▼] or [▲] key and then press the [OK] key.
- 3** Select "TRAY SELECTION" with the [▼] or [▲] key and then press the [OK] key.
- 4** Select the tray that you wish to enable with the [▼] or [▲] key and then press the [OK] key.
 - The selected tray is enabled and a checkmark appears in the checkbox.
 - If this procedure is performed when the tray is enabled, the checkmark will be cleared and the tray disabled.
- 5** To enable another tray, repeat step 4. To exit, press the [BACK] key.



- The trays that can be enabled will vary depending on the options that are installed.
- The trays cannot all be disabled.

RECEIVED DATA PRINT CONDITION

This setting determines the selection condition for paper when printing received documents. Select one of the three conditions below. "REDUCTION" is normally selected.

- "REDUCTION"
Each received image is printed at actual size when possible. When not possible, the image is automatically reduced before printing.
- "DIVISION"
Each received image is printed at actual size. If necessary, the image is split onto multiple sheets of paper.
- "ACTUAL SIZE"
The received fax image is printed at its actual size (without dividing it onto multiple sheets of paper). If the same size of paper or larger paper is not loaded, the fax will be received in memory and **will not be printed until a suitable size of paper is loaded.**

- 1 Follow steps 1 through 6 of "INITIAL PROCEDURE" (page 98).**
- 2 Select "RCV. FUNCTION" with the [▼] or [▲] key and then press the [OK] key.**
- 3 Select "RECEIVED DATA PRINT CONDITION" with the [▼] or [▲] key and then press the [OK] key.**
- 4 Select "REDUCTION", "DIVISION" or "ACTUAL SIZE" with the [▼] or [▲] key and then press the [OK] key.**

AUTO RCV REDUCE TO REGULAR SIZE

When you receive a fax that includes the sender's name and number, the received image is slightly larger than the standard size*. This setting lets you select whether or not the received image is automatically reduced before printing to fit the standard size. Normally this setting is enabled.

* Standard sizes are sizes such as A4 and B5.

- 1 Follow steps 1 through 6 of "INITIAL PROCEDURE" (page 98).**
- 2 Select "RCV. FUNCTION" with the [▼] or [▲] key and then press the [OK] key.**
- 3 Select "AUTO RCV REDUCE TO REGULAR SIZE" with the [▼] or [▲] key and then press the [OK] key.**
 - The setting is enabled and a checkmark appears in the checkbox.
 - If this procedure is performed when the setting is enabled, the checkmark will be cleared and the setting disabled.



- If this setting is disabled (no reduction) and the received data print condition is set to division, the image may be clipped.
- If auto receive reduce is disabled, an image larger than the standard size will be cut off. However, the image will be clearer because it will be printed at the same size as the original.

DUPLEX RECEPTION

(Only on models with the two-sided printing function)

This setting is used to select whether or not received faxes are printed on both sides of the paper. When two-sided printing is enabled and a fax that is two pages or longer is received (the pages must be the same size), the fax will be printed on both sides of the paper.

- 1 Follow steps 1 through 6 of "INITIAL PROCEDURE" (page 98).**
- 2 Select "RCV. FUNCTION" with the [▼] or [▲] key and then press the [OK] key.**
- 3 Select "DUPLEX RECEPTION" with the [▼] or [▲] key and then press the [OK] key.**
 - The setting is enabled (two-sided printing will take place) and a checkmark appears in the checkbox.
 - If the procedure is performed when the setting is enabled, the checkmark will be cleared and the setting disabled.

8 1/2x11 RX REDUCE PRINT

This setting is used to select whether received 8-1/2" x 11"R-size faxes are reduced. When an 8-1/2" x 11"R fax is received, part of the document is normally cut off. This setting can be turned on to have 8-1/2" x 11"R faxes reduced to fit on A4R paper. The setting is initially turned off.

- 1 Follow steps 1 through 6 of "INITIAL PROCEDURE" (page 98).**
- 2 Select "RCV. FUNCTION" with the [▼] or [▲] key and then press the [OK] key.**
- 3 Select "8 1/2x11 RX REDUCE PRINT" with the [▼] or [▲] key and then press the [OK] key.**
 - The setting is turned on and a checkmark appears in the checkbox.
 - If this procedure is performed when the setting is turned on, the checkmark is cleared and the setting turned off.
 - Reduction takes place when the setting is turned on, and does not take place when the setting is turned off.



If this setting is turned off, part of the image may be cut off.

FW. RX DATA

This setting is used to select whether or not received faxes are forwarded to a fax machine programmed as explained in "RECEIVED DATA FW. STATION SET" (page 110) in the event that the machine cannot print the faxes. The setting is initially disabled.

- 1 Follow steps 1 through 6 of "INITIAL PROCEDURE" (page 98).**
- 2 Select "RCV. FUNCTION" with the [▼] or [▲] key and then press the [OK] key.**
- 3 Select "FW. RX DATA" with the [▼] or [▲] key and then press the [OK] key.**
 - The setting is enabled and a checkmark appears in the checkbox.
 - If the procedure is performed when the setting is enabled, the checkmark will be cleared and the setting disabled.



This setting only operates when the fax number of the machine that is to receive the forwarded faxes is programmed.

RECEIVED DATA FW. STATION SET

When a problem prevents the machine from printing a received fax, the fax forwarding function (page 49) can be used to forward the received fax to another fax machine. Use this setting to program the fax number of the destination fax machine. Only one fax number can be programmed (maximum of 50 digits). To specify an F-code confidential box in the destination fax machine, enter the sub-address and passcode after the fax number in steps 6 and 7 below.

- 1 Follow steps 1 through 6 of "INITIAL PROCEDURE" (page 98).**
- 2 Select "RCV. FUNCTION" with the [▼] or [▲] key and then press the [OK] key.**
- 3 Select "RECEIVED DATA FW. STATION SET" with the [▼] or [▲] key and then press the [OK] key.**
- 4 Select "STORE" with the [▼] or [▲] key and then press the [OK] key.**
- 5 Enter the forwarding fax number with the numeric keys and then press the [OK] key.**
- 6 Enter the sub-address with the numeric keys and then press the [OK] key.**

If you do not need to specify an F-code confidential box in the destination fax machine, press the [OK] key without entering anything.

- 7 Enter the passcode with the numeric keys and then press the [OK] key.**

If you do not need to specify an F-code confidential box in the destination fax machine, press the [OK] key without entering anything.



To delete the number, follow these steps:

- (1) Select "DELETE" in step 4 and then press the [OK] key.
- (2) Select "DELETE" with the [▼] or [▲] key and then press the [OK] key.

EARLIER OUTPUT

When a received fax cannot be printed because the machine is out of appropriate paper and a fax is subsequently received that can be printed, this setting determines whether the subsequent fax is printed before the fax that cannot be printed. The setting is initially enabled (the subsequent fax is printed first).

- 1 Follow steps 1 through 6 of "INITIAL PROCEDURE" (page 98).**
- 2 Select "RCV. FUNCTION" with the [▼] or [▲] key and then press the [OK] key.**
- 3 Select "EARLIER OUTPUT" with the [▼] or [▲] key and then press the [OK] key.**
 - The setting is enabled (the subsequent fax is printed first) and a checkmark appears in the checkbox.
 - If the procedure is performed when the setting is enabled, the checkmark will be cleared and the setting disabled.

ANTI JUNK FAX

When this setting is enabled, reception from fax numbers programmed using the "ENTER JUNK FAX #" program will be blocked. This program is normally disabled.

- 1 Follow steps 1 through 6 of "INITIAL PROCEDURE" (page 98).**
- 2 Select "RCV. FUNCTION" with the [▼] or [▲] key and then press the [OK] key.**
- 3 Select "ANTI JUNK FAX" with the [▼] or [▲] key and then press the [OK] key.**
 - The setting is enabled and a checkmark appears in the checkbox.
 - If this procedure is performed when the setting is enabled, the checkmark will be cleared and the setting disabled.

ENTER JUNK FAX

This setting is used to program fax numbers from which you wish to block reception. Up to 50 fax numbers can be stored (maximum of 20 digits each). To block reception from the programmed fax numbers, the "ANTI JUNK FAX" setting must be enabled.

- 1** Follow steps 1 through 6 of "INITIAL PROCEDURE" (page 98).
- 2** Select "RCV. FUNCTION" with the [▼] or [▲] key and then press the [OK] key.
- 3** Select "ENTER JUNK FAX #" with the [▼] or [▲] key and then press the [OK] key.
- 4** Select "ENTER" with the [▼] or [▲] key and then press the [OK] key.
- 5** Enter a 2-digit control number from 01 to 50 with the numeric keys to identify the fax number that will be entered in the next step, and then press the [OK] key.
- 6** Enter the fax number that you wish to block with the numeric keys, and then press the [OK] key.



To delete a number, follow these steps:
Before deleting a number, use the "LIST PRINT" setting on (page 99) to check the control number that identifies the fax number (01 to 50) that you wish to delete. The control number must be entered to delete the fax number. (The fax number will not appear in the display. If the wrong control number is accidentally entered, a fax number other than the fax number that you wish to delete will be deleted.)

- (1) Select "DELETE" in step 4 and then press the [OK] key.
- (2) Select the 2-digit control number (01 to 50) that identifies the fax number that you wish to delete with the [▼] or [▲] key and then press the [OK] key.
- (3) Select "DELETE" with the [▼] or [▲] key and then press the [OK] key.

POLLING SECURITY

These settings are used for the public box for regular polling memory. Note that they do not apply to F-code polling memory. (See "USING POLLING MEMORY" page 38.)

POLLING SECURITY

When performing polling memory (see "Polling security" on page 40), this setting is used to select whether any machine will be allowed to poll your machine, or only machines that have been programmed in your machine. Normally this setting is enabled.

- 1** Follow steps 1 through 6 of "INITIAL PROCEDURE" (page 98).
- 2** Select "POLLING SECURITY" with the [▼] or [▲] key and then press the [OK] key.
- 3** Select "POLLING SECURITY" with the [▼] or [▲] key and then press the [OK] key.
 - The setting is enabled and a checkmark appears in the checkbox.
 - If this procedure is performed when the setting is enabled, the checkmark will be cleared and the setting disabled.

POLLING PASSCODE # MODE

When "POLLING SECURITY" is enabled, use this setting to program (or delete) the fax numbers of the machines that are allowed to poll your machine. Programmed fax numbers are called passcodes. Up to 10 fax numbers can be programmed. To check the programmed numbers, print the "SYSTEM SET LIST" (page 99).

- 1** Follow steps 1 through 6 of "INITIAL PROCEDURE" (page 98).
- 2** Select "POLLING SECURITY" with the [▼] or [▲] key and then press the [OK] key.
- 3** Select "POLLING PASSCODE # MODE" with the [▼] or [▲] key and then press the [OK] key.
- 4** Select "ENTER" with the [▼] or [▲] key and then press the [OK] key.
- 5** Enter a 2-digit control number from 01 to 10 with the numeric keys to identify the passcode that will be entered in the next step, and then press the [OK] key.
If you make a mistake, move the cursor to the mistake with the [◀] or [▶] keys and enter the correct number.
- 6** Enter the passcode number (up to 20 digits) and then press the [OK] key.
If you make a mistake, press the [C] key and then re-enter the correct number.



To clear a passcode number, follow these steps:

- (1) Select "DELETE" in step 4 and then press the [OK] key.
- (2) Enter the control number that identifies the number you wish to clear, and then press the [OK] key.
- (3) Select "DELETE" with the [▼] or [▲] key and then press the [OK] key.

9

APPENDIX

This chapter contains the specifications of the fax function and the index.

SPECIFICATIONS

For information on power requirements, power consumption, dimensions, weight, and other specifications that are common to all features of the machine, see "SPECIFICATIONS" in the "Start Guide".

Applicable telephone line	Public switched telephone network
Compression method	MH, MR, MMR, JBIG
Transmission mode	Super G3, G3 (this machine can only communicate with fax machines that support the G3 or Super G3 standard)
Scanning method	Flatbed CCD
Scanning resolution (supports ITU-T standards)	8 x 3.85 lines/mm (Standard) 8 x 7.7 lines/mm (Fine, Fine-Halftone) 8 x 15.4 lines/mm (Super Fine, Super Fine - Halftone) 16 x 15.4 lines/mm (Ultra Fine, Ultra Fine - Halftone)
Printing method	Electrophotography
Transmission speed	33.6 kbps down to 2.4 kbps Automatic fallback
Transmission time* ¹	2 seconds (Super G3 mode / 33.6 kbps, JBIG), 6 seconds (G3 ECM mode / 14.4 kbps, JBIG)
Paper size	A3 to A5, 8-1/2" x 11" (Inch-based machine: 11" x 17" to 5-1/2" x 8-1/2", A4)
Effective recording width	293 mm max. (A3 printing) or 11.5" max. (11" x 17" printing)
Transmittable original size	A3 to A5 (Inch-based machine: 11" x 17" to 5-1/2" x 8-1/2") Refer to "Image rotation" (page 24) for transmission of A5 size documents.
Effective scanning width	Maximum 297 mm (11.7")
Halftone transmission	Yes (256 levels)
Contrast adjustment	Automatic (5 levels by manual adjustment)
Extension telephone connection	Possible (1 telephone)
Auto-dialling	A combined total of 50 Rapid dial and group dial keys can be stored; 300 speed dial destinations can be stored.
Timer Transmission	Yes
Program function	Yes (9 programs)
F-code support	Yes (can transmit and receive SUB/SEP (sub-address) and SID/PWD (passcode) signals)
Auto document feeding	Yes (maximum of 40 sheets, 30 sheets of 90 g/m ² (24 lbs.) paper, or total stack thickness of 4 mm (5/32") or less)
Image memory	16 MB
Error Correction Mode (ECM)	Yes

*¹ Transmission speed is for an A4 or 8-1/2" x 11" document with approximately 700 characters at standard resolution (8 x 3.85 lines/mm) sent in high speed mode (33.6 kbps (JBIG) or 14.4 kbps (JBIG)). This is only the time required to transmit the image information; the time required to send protocol signals is not included. Actual transmission times will vary depending on the contents of the document, the receiving machine type, and telephone line conditions.

Some discrepancies may exist in the illustrations and content due to improvements to the machine.

INDEX

Symbols / Numbers

#of rings at. RX	108
8 1/2x11 RX reduce	109

A

Acc. name print	106
Account # set	103
Account control	103
Account number	10
Advanced transmission methods	
- Broadcast transmission.....	31
- Cover sheet/message function	43
- Dual page scan	42
- Forwarding function	49
- Own number sending.....	41
- Timer transmission.....	33
Alarm sounds	92
Anti junk fax.....	110
Auditing mode	10
Auto cover sheet	108
Auto listing.....	99
Auto rcv reduce to regular size	109
Auto reduce TX	105
Auto-dialling	15, 19
Automatic reduction function.....	11

B

Base screen	9
Boxes	52
Broadcast transmission.....	31

C

Cancelling	
- F-code polling	58
- Forwarding	50
- Polling	36
- Transmission.....	25
Cancelling a fax transmission	25
Cancelling a stored transmission job	26
Clearing document data	
- F-code public (polling memory) boxes	56
Communication activity	92
Communication activity report.....	92
Connecting an extension phone.....	64
Contents.....	2

D

Date & time set.....	104
Date and time.....	6
DIAL MODE	100
Direct transmission.....	22
Disable fax print hold.....	104
DISTINCTIVE RING.....	102
Document glass	12
Dual mode.....	100
Dual page scan	42
Duplex reception	109

E

Earlier output.....	27,110
ECM	24
Editing/deleting	
- F-code confidential boxes	81
- F-code public (polling memory) boxes	84
- F-code relay groups	83
- Group keys.....	73
- Programs.....	76
- Rapid keys	72
- Speed dial numbers	72
End sound length	101
Enter junk fax #	111
Entering characters	86
Exposure, selecting.....	14
Extension phone connection	64

F

Fax mode	9
Fax print hold	29
Fax transmission	
- Direct transmission.....	22
- Rotate TX.....	105
- Speed dialling.....	19
- Storing transmission jobs (memory transmission).....	23
Faxing a two-sided original	21
F-code confidential transmission	
- F-code confidential reception.....	59
- F-code confidential transmission.....	59
F-code polling memory	
- F-code polling.....	57
- F-code polling memory.....	54
F-code relay broadcast transmission	
- F-code relay broadcast transmission	63
- F-code relay request transmission	63
Forwarding destination.....	49
Forwarding function.....	49
Fw. RX data	110
Fw. station set	110

G

Group dialling	15
----------------------	----

I

Image rotation	24
Inbound routing settings.....	45
Initial setting	100

L

Line connection	4
LINE STATUS indicator	27
Lithium battery.....	4
Long originals.....	11

M	Memory transmission	23	R	Rapid dialling.....	15
O	On-hook dialling	15	Rcv. function	108	
Operation panel.....	7	Read-end	18	Recall set (err).....	107
Original size	13	Recall setting (busy).....	106	Received data print condition	109
Original sizes.....	11	Receiving party is busy	24	Reception	27
Own number sending	41	- Automatic reception	27	- Remote reception.....	65
Own passcode set.....	101	Redialling	15	Relay machine	62
P	Page counter set.....	105	Relay request machine	62	
Paper sizes	6	Remote reception.....	65, 102	Res. con. set	103
Passcode	50	Resolution, selecting	14	Ring timeout in auto TX.....	108
Pause	17, 100	Rotate TX	105		
PC-Fax	4	S	Scanning area of original	11	
Placing the original.....	12	Searching for a destination	20	Self-diagnostic function	93
Polling function.....	35	Send mode	106	Sender information.....	41
Polling memory	36, 39	Sender's name	6	Sender's number	6
Polling passcode numbers		Sending a fax	17	Sending function	105
- Deleting	111	Sending function	105	Serial polling.....	37
- Programming	111	Serial polling.....	37	Speaker volume	101
Polling security.....	40,111	Specifications	112	SPF	12
Power switch	4	Standard sizes	13	Storing transmission jobs	23
Print passcode	79	Storing transmission jobs	23	Sub-address.....	52
Print selection.....	99	System settings.....	96		
Print station # in rcvd data.....	106	T	Timer transmission.....	33	
Printing		Transaction report	90	Transmission	
- Acc. usage list.....	99	Transmission		- Auto-dialling	19
- Activity report	85, 99	- Auto-dialling	19	- Cancelling	25
- Conf. RX list.....	85	- Cancelling	25	- Image rotation	24
- F-code confidential boxes	61	- Image rotation	24	- Quick on-line transmission	24
- F-code public (polling memory) boxes	56	- Quick on-line transmission	24	- Two-sided original.....	21
- Junk fax # list	99	Transmission error	24	Transmission settings	22
- Mem. polling list	85	Transmission settings	22	Tray selection.....	108
- Public (polling memory) boxes.....	39	Tray selection.....	108	TX/RX end sound.....	101
- System set list.....	99	TX/RX end sound.....	101	Type/note column.....	90
- Timer list	85	Type/note column.....	90		
- Transaction report.....	90, 99	U	Using an extension phone for voice calls	64	
Problems and solutions.....	94	Warning messages	92		
Programming					
- F-code confidential boxes	79				
- F-code public (polling memory) boxes	81				
- F-code relay groups	80				
- F-code settings	68				
- Group keys.....	71				
- Programs	76				
- Rapid keys	67				
- Speed dial numbers	67				
Programs.....	44				
Q	Quick on line TX.....	106			
Quick on-line transmission.....	24				

INDEX BY PURPOSE

Advanced transmission methods

Broadcast transmission.....	31
Cover sheet/message function.....	43
Dual page scan	42
Forwarding function.....	49
Own number sending	41
Polling function	
- Polling	36
- Polling memory	38
Programs.....	44
Timer Transmission.....	33

Entering characters

Alphabetical characters.....	88
Numbers.....	88
Special characters.....	89
Symbols	88

Faxes, sending and receiving

Cancelling a fax transmission	25
Dialling methods	
- Group dialling.....	15
- On-hook dialling	15
- Rapid dialling	15
- Redialling	15
- Speed dialling	15
Receiving faxes	
- Activating fax reception from an extension phone ..	65
- Basic procedure for receiving faxes	27
Sending faxes	
- Basic procedure for sending faxes.....	17
- Faxing a two-sided original	21
- Placing the original.....	12

Preparations

Connecting to the telephone line.....	4
Program the sender's name.....	100
Program the sender's number.....	100
Set the date and time	104

Printing

List.....	99
Programmed information/settings	85
Report	85

Programming/settings

Deleting	
- F-code confidential boxes	82
- F-code public (polling memory) boxes	84
- F-code relay groups	83
- Group keys.....	75
- Programs.....	77
- Rapid keys	73
- Speed Dial numbers.....	73
Editing	
- F-code confidential boxes	82
- F-code public (polling memory) boxes	84
- F-code relay groups	83
- Group keys.....	73
- Programs.....	77
- Rapid keys	72
- Speed Dial numbers.....	72
Exposure setting	14
Original scanning size	13
- Programming	
- F-code confidential boxes	79
- F-code public (polling memory) boxes	81
- F-code relay groups	80
- F-code settings.....	68
- Group keys.....	71
- Programs.....	76
- Rapid key	67
- Speed Dial numbers.....	67
Resolution setting.....	14

Transmission using F-codes

F-code confidential transmission.....	59
F-code polling.....	57
F-code polling memory.....	54
F-code relay broadcast transmission	62

Troubleshooting

Alarm sounds	92
Communication activity report, viewing	92
Problems and solutions.....	94
Receiving party is busy	24
Transaction report is printed	90
Transmission error occurs.....	24
Warning message is displayed	92

WARNING:

This is a Class A product. In a domestic environment this product may cause radio interference in which case the user may be required to take adequate measures.

SHARP ELECTRONICS (Europe) GmbH
Sonninstraße 3, D-20097 Hamburg

SHARP®

SHARP CORPORATION

Free Manuals Download Website

<http://myh66.com>

<http://usermanuals.us>

<http://www.somanuals.com>

<http://www.4manuals.cc>

<http://www.manual-lib.com>

<http://www.404manual.com>

<http://www.luxmanual.com>

<http://aubethermostatmanual.com>

Golf course search by state

<http://golfingnear.com>

Email search by domain

<http://emailbydomain.com>

Auto manuals search

<http://auto.somanuals.com>

TV manuals search

<http://tv.somanuals.com>