

SHARP

MICRO COMPONENT SYSTEM

MODEL

XL-UH2080H

OPERATION MANUAL

COMPACT
disc
DIGITAL AUDIO

MP3



SAVING ENERGY
STAND-BY POWER
CONSUMPTION **0.6w**

USB
PLAYBACK

R-D-S

Thank you for purchasing this SHARP product.

To obtain the best performance from this product, please read this manual carefully. It will guide you in operating your SHARP product.

XL-UH2080H Micro component system consisting of XL-UH2080H (main unit) and CP-UH2080H (speaker system).

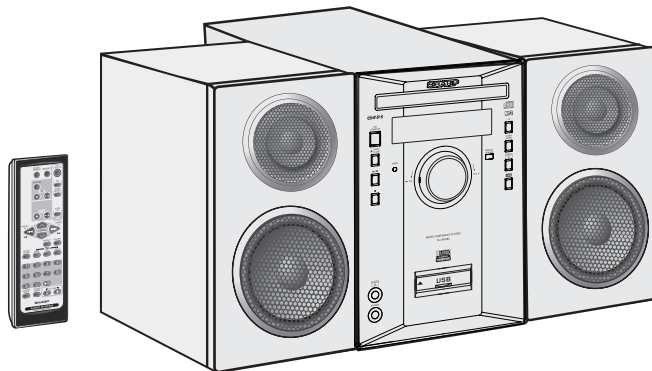

CD-R/RW
Playable

Note:

This product is not compatible with MTP and AAC file systems.

SHARP CORPORATION

Special notes

WARNINGS

- When the ON/STAND-BY button is set at STAND-BY position, mains voltage is still present inside the unit. When the ON/STAND-BY button is set at STAND-BY position, the unit may be brought into operation by the timer mode or remote control.
- This unit contains no user serviceable parts. Never remove covers unless qualified to do so. This unit contains dangerous voltages, always remove mains plug from the socket before any service operation and when not in use for a long period.
- To prevent fire or shock hazard, do not expose this appliance to dripping or splashing. No objects filled with liquids, such as vases, shall be placed on the apparatus.
- Do not turn the volume on to full at switch on and listen to music at moderate levels. Excessive sound pressure from earphones and headphones can cause hearing loss.

Note for users in Australia:

Copyright may exist in material you wish to record. Copying or broadcasting such material without permission of the relevant licensees or owners of the copyright is prohibited by law. SHARP is not in a position to authorise the copying or broadcasting of copyright materials and nothing in this OPERATION MANUAL should be implied as giving that authority.

For other countries:

Audio-visual material may consist of copyrighted works which must not be recorded without the authority of the owner of the copyright. Please refer to the relevant laws in your country.

CAUTIONS

- This product is classified as a CLASS 1 LASER product.
- This unit contains a low power laser device. To ensure continued safety do not remove any cover or attempt to gain access to the inside of the product. Refer all servicing to qualified personnel.

Special Note

Supply of this product does not convey a license nor imply any right to distribute content created with this product in revenue-generating broadcast systems (terrestrial, satellite, cable and/or other distribution channels), revenue-generating streaming applications (via Internet, intranets and/or other networks), other revenue-generating content distribution systems (pay-audio or audio-on-demand applications and the like) or on revenue-generating physical media (compact discs, digital versatile discs, semiconductor chips, hard drives, memory cards and the like). An independent license for such use is required. For details, please visit <http://mp3licensing.com>.
MPEG Layer-3 audio coding technology licensed from Fraunhofer IIS and Thomson.

Accessories

Please confirm that only the following accessories are included.

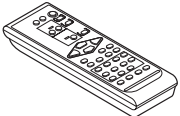
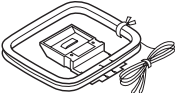
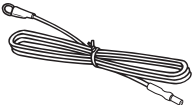
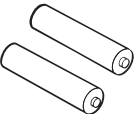
 <p>Remote control × 1</p>	 <p>AM loop aerial × 1</p>
 <p>FM aerial × 1</p>	 <p>“AA” size battery (UM/SUM-3, R6, HP-7 or similar) × 2</p>

Contents

XL-UH2080H

■ General Information	Page
Precautions	4
Controls and indicators	5 - 7
■ Preparation for Use	
System connections	8 - 10
Remote control	11
■ Basic Operation	
General control	12
Setting the clock (Remote Control only)	13
■ CD or MP3/WMA disc Playback	
Listening to a CD or MP3/WMA disc	14 - 15
Advanced CD or MP3/WMA disc playback	16 - 18
MP3/WMA folder mode (only for MP3/WMA files)	18 - 20
■ USB Memory Playback	
Listening to USB mass storage device / MP3 Player	20 - 21
To remove USB memory device	22
Advanced USB playback	22 - 23
■ Radio	
Listening to the radio	23 - 25
■ Advanced Features	
Using the Radio Data System (RDS)	25 - 30
Timer and sleep operation (Remote Control only)	30 - 33
Enhancing your system	34 - 35
■ References	
Troubleshooting chart	35 - 37
Maintenance	37
Specifications	37 - 38

Precautions

■ General

- Please ensure that the equipment is positioned in a well-ventilated area and ensure that there is at least 10 cm (4") of free space along the sides, top and back of the equipment.

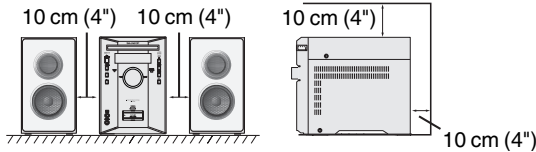

- Use the unit on a firm, level surface free from vibration.

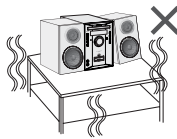

- Keep the unit away from direct sunlight, strong magnetic fields, excessive dust, humidity and electronic/electrical equipment (home computers, facsimiles, etc.) which generate electrical noise.



- Do not place anything on top of the unit.
- Do not expose the unit to moisture, to temperatures higher than 60°C (140°F) or to extremely low temperatures.
- If your system does not work properly, disconnect the AC power lead from the wall socket. Plug the AC power lead back in, and then turn on your system.
- In case of an electrical storm, unplug the unit for safety.

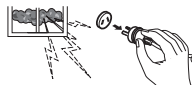

- Hold the AC power plug by the head when removing it from the wall socket, as pulling the lead can damage internal wires.
- The AC power plug is used as a disconnect device and shall always remain readily operable.
- **Do not remove the outer cover, as this may result in electric shock. Refer service to your local SHARP service facility.**

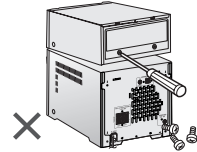

- The ventilation should not be impeded by covering the ventilation openings with items, such as newspapers, tablecloths, curtains, etc.
- No naked flame sources, such as lighted candles, should be placed on the apparatus.
- Attention should be drawn to the environmental aspects of battery disposal.
- This unit should only be used within the range of 5°C - 35°C (41°F - 95°F).

Warning:

The voltage used must be the same as that specified on this unit. Using this product with a higher voltage other than that which is specified is dangerous and may result in a fire or other type of accident causing damage. SHARP will not be held responsible for any damage resulting from use of this unit with a voltage other than that which is specified.

■ Volume control

The sound level at a given volume setting depends on speaker efficiency, location, and various other factors. It is advisable to avoid exposure to high volume levels. Do not turn the volume on to full at switch on. Listen to music at moderate levels. Excessive sound pressure from earphones and headphones can cause hearing loss.

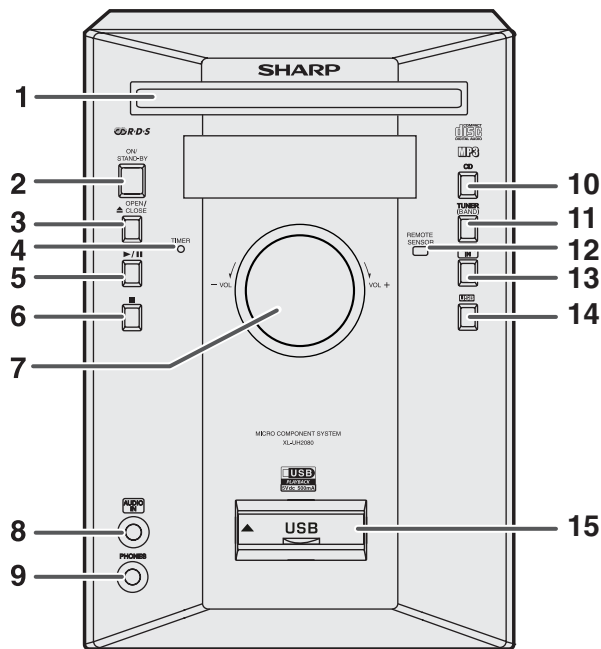

■ Front panel

Reference page

1. Disc Tray	14
2. On/Stand-by Button	12, 13, 14, 24, 32
3. Disc Tray Open/Close Button	14
4. Timer Indicator	32
5. Disc or USB Play or Pause Button	15, 16
6. Disc Stop Button	16, 17
7. Volume Control	12
8. Audio In Socket	34
9. Headphones Socket	34
10. CD Button	14
11. Tuner (Band) Button	23
12. Remote Sensor	11
13. Audio In Button	34
14. USB Button	21
15. USB Terminal	22

Controls and indicators (continued)

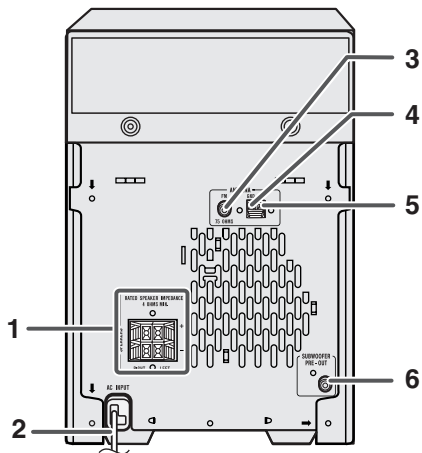
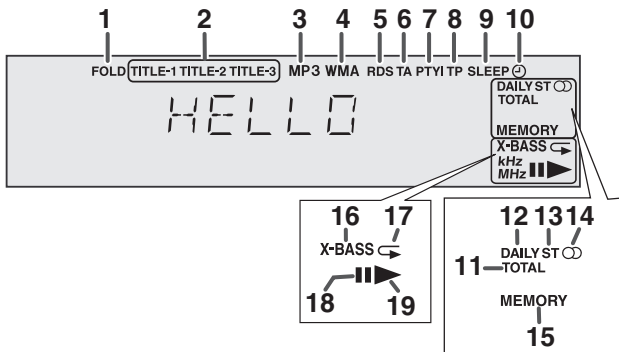

■ Display

	Reference page
1. MP3/WMA Folder Indicator	19, 21
2. MP3/WMA Title Indicators	20
3. MP3 Indicator	15
4. WMA Indicator	15
5. RDS Indicator	25, 26
6. Traffic Announcement Indicator	25
7. Dynamic PTY Indicator	25
8. Traffic Programme Indicator	25
9. Sleep Indicator	33
10. Timer Play Indicator	32
11. MP3/WMA Total Indicator	21
12. Daily Timer Indicator	31
13. FM Stereo Mode Indicator	24
14. FM Stereo Receiving Indicator	24
15. Memory Indicator	17
16. Extra Bass Indicator	12
17. Disc or USB Repeat Play Indicator	16
18. Disc or USB Pause Indicator	15
19. Disc or USB Play Indicator	15

■ Rear panel

	Reference page
1. Speaker Terminals	9
2. AC Power Lead	10
3. FM 75 Ohms Aerial Socket	9
4. AM Aerial Earth Terminal	9
5. AM Loop Aerial Terminal	9
6. Subwoofer Pre-output Socket	35

■ Speaker system

1. Tweeter
2. Woofer
3. Bass Reflex Duct
4. Speaker Wire

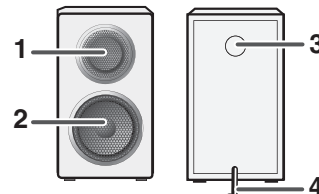

System connections

Make sure to unplug the AC power lead before making any connections

■ Aerial connection (see page 9)

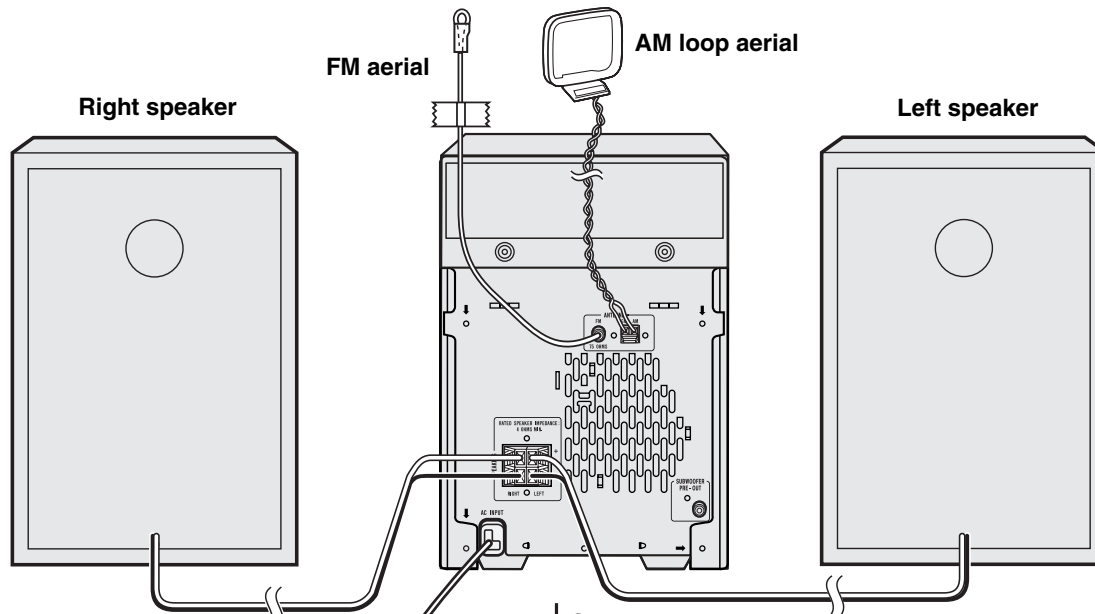

■ Speaker connection (see page 9)

Wall socket
(AC 220 - 240V ~ 50Hz)

■ AC power connection (see page 10)

■ Aerial connection

Supplied FM aerial:

Connect the FM aerial wire to the FM 75 OHMS socket and position the FM aerial wire in the direction where the strongest signal can be received.

Supplied AM loop aerial:

Connect the AM loop aerial to the AM and GND (Earth) terminals. Position the AM loop aerial for optimum reception. Place the AM loop aerial on a shelf, etc., or attach it to a stand or a wall with screws (not supplied).

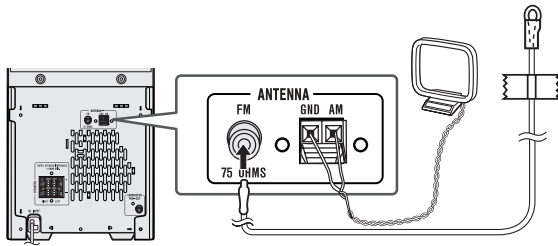

Note:

Placing the aerial on the unit or near the AC power lead may cause noise pickup. Place the aerial away from the unit for better reception.

Installing the AM loop aerial:

< Assembling >

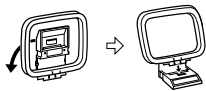

< Attaching to the wall >

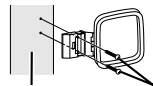

Wall Screws (not supplied)

■ Speaker connection

Connect the black wire to the minus (-) terminal, and the red wire to the plus (+) terminal.

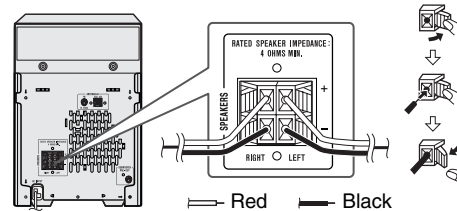

Caution:

- Use speakers with an impedance of 4 ohms or more, as lower impedance speakers can damage the unit.
- Do not mistake the right and the left channels. The right speaker is the one on the right side when you face the unit.
- **Do not let the bare speaker wires touch each other.**
- Do not allow any objects to fall into or to be placed in the bass reflex ducts.
- Do not stand or sit on the speakers. You may be injured.

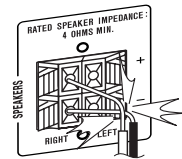

Incorrect

System connections (continued)

■ AC power connection

After checking all the connections have been made correctly, plug the AC power lead of this unit into the wall socket. If you plug in the unit first, the unit will enter the demonstration mode.

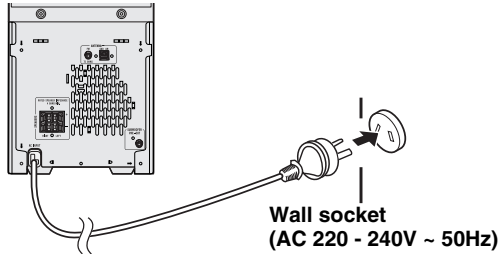

Note:

Unplug the AC power lead from the wall socket if the unit will not be in use for a prolonged period of time.

■ Demonstration mode

The first time the unit is plugged in, the unit will enter the demonstration mode. You will see words scroll.

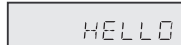

To cancel the demonstration mode:

When the unit is in the power stand-by mode (demonstration mode), press the X-BASS/DEMO button on the remote control. The unit will enter the low power consumption mode.



To return to the demonstration mode:

When the unit is in the power stand-by mode, press the X-BASS/DEMO button on the remote control again.

Note:

When the power is on, the X-BASS/DEMO button can be used to select the extra bass mode.

■ External FM aerial

Use an external FM aerial if you require better reception. Consult your dealer.

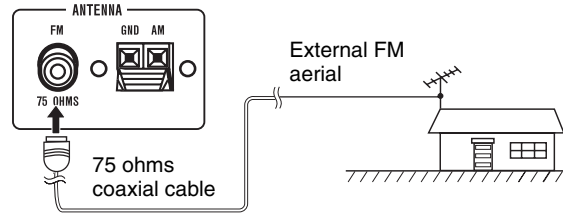

Note:

When an external FM aerial is used, disconnect the supplied FM aerial wire.

■ Battery installation

- 1 Open the battery cover.
- 2 Insert the supplied batteries according to the direction indicated in the battery compartment.

When inserting or removing the batteries, push them towards the ⊖ battery terminals.

- 3 Close the cover.

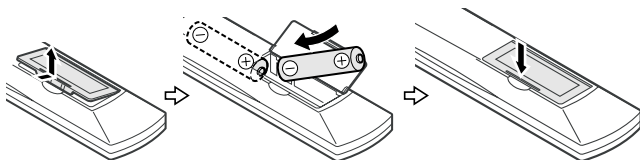

Precautions for battery use:

- Replace all old batteries with new ones at the same time.
- Do not mix old and new batteries.
- Remove the batteries if the unit will not be used for long periods of time. This will prevent potential damage due to battery leakage.

Caution:

- Do not use rechargeable batteries (nickel-cadmium battery, etc.).
- Installing the batteries incorrectly may cause the unit to malfunction.
- Batteries (battery pack or batteries installed) shall not be exposed to excessive heat such as sunshine, fire or the like.

Battery removal:

Open the battery cover and pull up the battery to take out.

Notes concerning use:

- Replace the batteries if the operating distance is reduced or if the operation becomes erratic. Purchase 2 "AA" size batteries (UM/SUM-3, R6, HP-7 or similar).
- Periodically clean the transmitter on the remote control and the sensor on the unit with a soft cloth.
- Exposing the sensor on the unit to strong light may interfere with operation. Change the lighting or the direction of the unit if this occurs.
- Keep the remote control away from moisture, heat, shock, and vibrations.

■ Test of the remote control

Check the remote control after checking all the connections (see pages 8 - 10).

Point the remote control directly at the remote sensor on the unit.

The remote control can be used within the range shown below:

Press the ON/STAND-BY button. Does the power turn on? Now, you can enjoy the music.

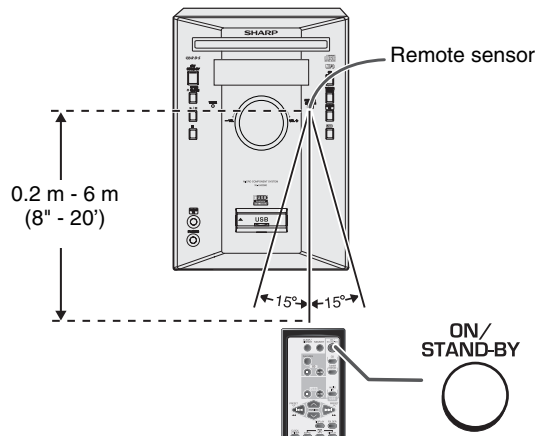

General control

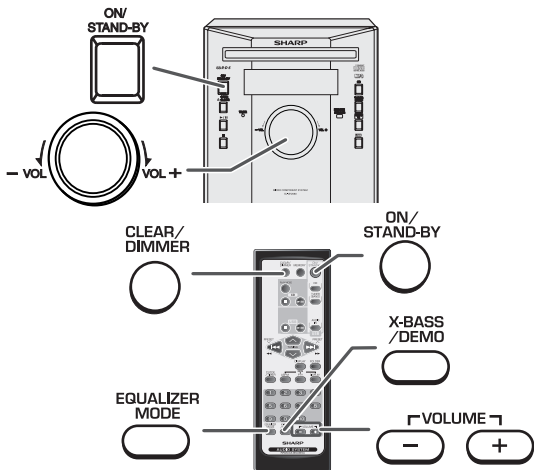

■ To turn the power on

Press the ON/STAND-BY button to turn the power on.

After use:

Press the ON/STAND-BY button to enter the power stand-by mode.

■ Illumination light control

When the unit's power is turned on, the ring around the volume control lights up. To turn on/off the light, hold down the CLEAR/DIMMER button on the remote control for more than 2 seconds.

■ Volume auto fade-in

If you turn off and on the main unit with the volume set to 27 or higher, the volume starts at 16 and fades in to the last set level.

■ Volume control

Main unit operation:

When the VOLUME control is turned clockwise, the volume will increase. When it is turned anti-clockwise, the volume will decrease.

Remote control operation:

Press the VOLUME (+ or -) button to increase or decrease the volume.



■ Bass control

When the power is first turned on, the unit will enter the extra bass mode which emphasises the bass frequencies, and "X-BASS" will appear. To cancel the extra bass mode, press the X-BASS/DEMO button on the remote control.

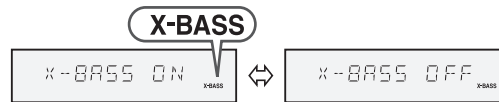

■ Equaliser

When the EQUALIZER MODE button is pressed, the current mode setting will be displayed. To change to a different mode, press the EQUALIZER MODE button repeatedly until the desired sound mode appears.

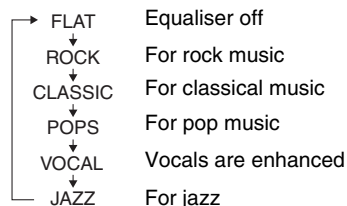

Setting the clock (Remote Control only)

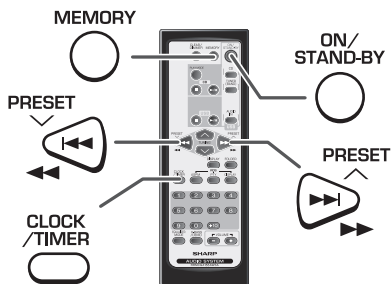

In this example, the clock is set for the 24-hour (0:00) display.

- 1** Press the ON/STAND-BY button to turn the power on.
- 2** Press the CLOCK/TIMER button.
- 3** Within 10 seconds, press the ◀◀◀◀ or ▶▶▶▶ button to select "CLOCK", and press the MEMORY button.



- 4** Press the ◀◀◀◀ or ▶▶▶▶ button to select 24-hour or 12-hour display and then press the MEMORY button.

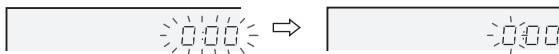

- "0:00" → The 24-hour display will appear. (0:00 - 23:59)
- ↓
- "AM 12:00" → The 12-hour display will appear. (AM 12:00 - PM 11:59)
- ↓
- "AM 0:00" → The 12-hour display will appear. (AM 0:00 - PM 11:59)

- 5** Press the ◀◀◀◀ or ▶▶▶▶ button to adjust the hour and then press the MEMORY button.



Press the ◀◀◀◀ or ▶▶▶▶ button once to advance the time by 1 hour. Hold it down to advance continuously.

- 6** Press the ◀◀◀◀ or ▶▶▶▶ button to adjust the minutes and then press the MEMORY button.



Press the ◀◀◀◀ or ▶▶▶▶ button once to advance the time by 1 minute. Hold it down to change the time in 5-minute intervals.

To confirm the time display:

[When the unit is in the stand-by mode]

Press the CLOCK/TIMER button.

The time display will appear for about 10 seconds.

[When the power is on]

Press the CLOCK/TIMER button.

Within 10 seconds, press the ◀◀◀◀ or ▶▶▶▶ button to display the time.

The time display will appear for about 10 seconds.

Note:

The "CLOCK" will appear or time will flash to confirm the time display when the AC power supply is restored after a power failure or unplugging the unit. If incorrect, readjust the clock as follows.

To readjust the clock:

Perform "Setting the clock" from step 1. If the "CLOCK" does not appear in step 3, step 4 (for selecting the 24-hour or 12-hour display) will be skipped.

To change the 24-hour or 12-hour display:

- 1 Clear all the programmed contents. [Refer to "Factory reset, clearing all memory" on page 36 for details.]
- 2 Perform "Setting the clock" from step 1 onwards.

Listening to a CD or MP3/WMA disc

This system can play back a standard CD, CD-R/RW in the CD format and CD-R/RW with MP3 or WMA files, but cannot record on them. Some audio CD-R and CD-RW discs may not be playable due to the state of the disc or the device that was used for recording.

MP3:

MP3 is a form of compression. It is an acronym which stands for MPEG Audio Layer 3.

MP3 is a type of audio code which is processed by significant compression from the original audio source with very little loss in sound quality.

- This system supports MPEG 1 Layer 3, MPEG 2 Layer 3, and VBR files.
- During VBR file playback, time counter in the display may differ from its actual playback time.
- Bitrate which is supported by MP3 is 32 ~ 320 kbps.

WMA:

WMA files are Advanced System Format files that include audio files which are compressed with Windows Media Audio codec. WMA is developed by Microsoft as an audio format file for Windows Media Player.

- "MP3" and "WMA" indicator will light up after the unit reads information on an MP3 or WMA disc.
- Bitrate which is supported by WMA is 64 ~ 160 kbps.

Auto power on function:

When you press any of the following buttons, the unit turns on.

- CD button (main unit and remote control): The unit turns on and the "CD" function is activated.
- CD ► / || button on the remote control: The unit turns on and CD playback starts (regardless of the last function).
- ► / || button on the main unit: The unit turns on and playback of the last function starts (CD, TUNER, AUDIO IN, USB).

Auto power off function:

In the stop mode of CD, MP3 or WMA operation, the main unit enters the stand-by mode after 15 minutes of inactivity.

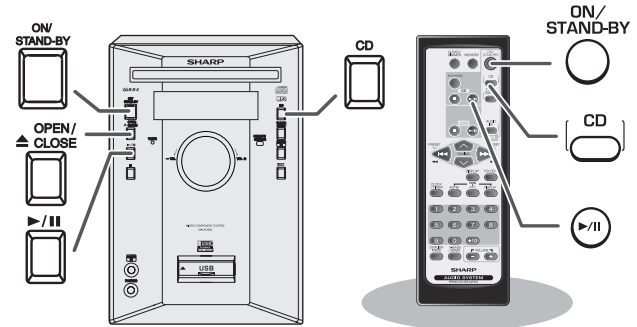

- 1 Press the ON/STAND-BY button to turn the power on.**
- 2 Press the CD button.**
- 3 Press the ▲ OPEN/CLOSE button to open the disc tray.**
- 4 Place the disc on the disc tray, label side up.**
Be sure to place 8 cm (3") disc in the middle of the disc tray.

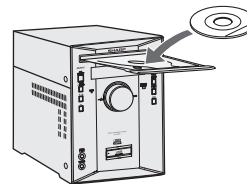

12 cm (5")

8 cm (3")



Continued to the next page

5 Press the ▲ OPEN/CLOSE button to close the disc tray.

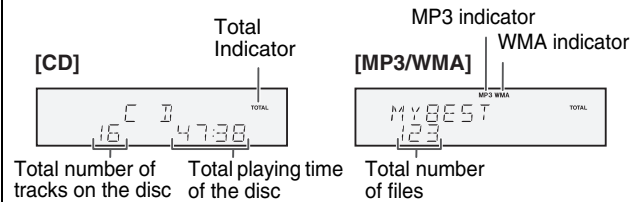

- Due to the structure of the disc information, it takes longer to read an MP3/WMA disc than a normal CD (approximately 20 to 90 seconds).

6 Press the ► / || button to start playback.



- After the last track is played, the unit will stop automatically.

To remove the discs:

In the stop mode, press the ▲ OPEN/CLOSE button.

Caution:

- Do not place two discs in one disc tray.
- Do not play discs of special shapes (heart, octagon, etc). It may cause malfunctions.
- Do not push the disc tray whilst it is moving.
- If the power fails whilst the tray is open, wait until the power is restored.
- If TV or radio interference occurs during CD operation, move the unit away from the TV or radio.

■ Various disc functions

Function	Main unit	Remote control	Operation
Play 			Press in the stop mode.
Stop 			Press in the playback mode.
Pause 			Press in the playback mode. Press the ► / button to resume playback from the paused point.
Track up/ Track down	—		Press in the playback or stop mode. If you press the button in the stop mode, press the ► / button to start the desired track.
Fast forward/ Fast reverse	—		Press and hold down in the playback mode. Release the button to resume playback.

Notes for CD or MP3/WMA disc:

- When the end of the last track is reached during fast forward, "END" will appear on the display and CD operation will be paused. When the beginning of the first track is reached during fast reverse, the unit will enter the playback mode.
- Rewritable multi-session discs with unfinished writing, can still be played.

Advanced CD or MP3/WMA disc playback

■ Direct track search

By using the direct search buttons, the desired tracks on the current disc can be played.

Use the direct search buttons on the remote control to select the desired track whilst playing the selected disc.



Selected track number

- The direct search buttons allow you to select up to number 9.
- When selecting number 10 or higher, use the "+10" button.

A. For example, to choose 13

- 1 Press the "+10" button once.
- 2 Press the "1" button.
- 3 Press the "3" button.

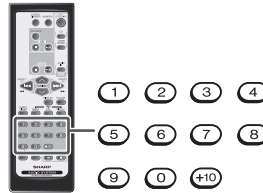

B. For example, to choose 130

- 1 Press the "+10" button twice.
- 2 Press the "1" button.
- 3 Press the "3" button.
- 4 Press the "0" button.

Notes:

- A track number higher than the number of tracks on the disc cannot be selected.
- During random play, direct search is not possible.

To stop playback:

Press the **■** (CD **■**) button.

■ Repeat play

Repeat play can play one track, all tracks or a programmed sequence continuously.

To repeat one track:

Press the PLAY MODE button once.
Press the **▶ / ||** button.

To repeat all tracks:

Press the PLAY MODE button twice.
Press the **▶ / ||** button.

To repeat desired tracks :

Perform steps 1 - 6 in "Programmed play" section on page 19 and then press the PLAY MODE button once.
Press the **▶ / ||** button.



To cancel repeat play:

Press the PLAY MODE button again until "G" disappears.

■ Random play

The tracks on the disc can be played in random order automatically.

To random play all tracks:

Press and hold down PLAY MODE button on the remote control. Press the ► / || button.

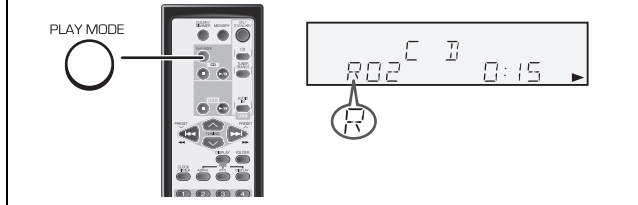

To cancel random play:

Press the PLAY MODE button.

"R" will disappear.

Notes:





- If you press the ►|| button during random play, you can move to the track selected next by the random operation. On the other hand, the ◀◀ button does not allow you to move to the previous track. The beginning of the track being played will be located.
- In random play, the unit will select and play tracks automatically. (You cannot select the order of the tracks.)

Caution:

After performing repeat or random play, be sure to press the ■ (CD ■) button. Otherwise, the disc will play continuously.

■ Programmed play

You can choose up to 32 selections for playback in the order you like.

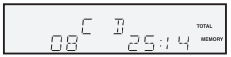
<p>1 Whilst in the stop mode, press the MEMORY button on the remote control to enter the programming save mode.</p>	<p style="text-align: center;">MEMORY</p>  
<p>2 Press the direct search buttons on the remote control to select the desired track.</p>	 <p style="text-align: center;">Selected track number</p> <p>You can also select a track by pressing the ◀◀ or ►► button.</p>
<p>3 Press the MEMORY button to save the track number.</p>	
<p>4 Repeat steps 2 - 3 for other tracks. Up to 32 tracks can be programmed.</p> <p>If you make a mistake, the programmed tracks can be cleared by pressing the CLEAR/DIMMER button.</p>	
<p>5 Press the ■ (CD ■) button.</p> <p>The total number in memory will appear.</p>	
<p>6 Press the ► / button to start playback.</p>	

Advanced CD or MP3/WMA disc playback (continued)

To clear the programmed selections:

Press the CLEAR/DIMMER button on the remote control whilst the "MEMORY" indicator is flashing.

Each time the button is pressed, one track will be cleared, beginning with the last track programmed.



To cancel the programmed play mode:

Whilst in the stop mode and the "MEMORY" indicator is lit, press the CLEAR/DIMMER button on the remote control. The "MEMORY" indicator will disappear and all the programmed contents will be cleared.

Adding tracks to the programme:

If a programme has been previously stored, the "MEMORY" indicator will be displayed. Then follow steps 1 - 6 to add tracks. The new tracks will be stored after the last track of the previous programme.

To check which tracks are programmed:

Whilst the unit is stopped in the programmed play mode, press the ◀◀ or ▶▶ button.

MP3/WMA folder programmed:

Only tracks in the same folder can be select. Select which folder to be programmed before entering programme mode. (refer page 20 to select folder)

Notes:

- When a disc ejected, the programme is automatically cancelled.
- Even if you press the ON/STAND-BY button to enter the stand-by mode or change the function from CD to another, the programmed selections will not be cleared.
- During the programme operation, random play is not possible.

MP3/WMA folder mode (only for MP3/WMA files)

To play back MP3/WMA (Windows Media Audio) file

There are many music sites on the internet that you can download MP3/WMA (Windows Media Audio) music files. Follow the instructions from the website on how to download the music files. You can then play back these downloaded music files by burning them to a CD-R/RW disc.

- Your downloaded song/files are for personal use only. Any other usage of the song without owner's permission, is against the law.

■ About folder playback order

If MP3/WMA files are recorded in several folders, a folder number will be set to each folder automatically.

These folders can be selected by the FOLDER button on the remote control. If there is no supported file formats inside the selected folder, the folder is skipped and the next folder will be selected.

Example: How to set folder number if MP3/WMA format files are recorded as below figure.

1. ROOT folder is set as folder 1.
2. As for folders inside ROOT folder (Folder A and Folder B), the folder which is recorded earlier on the disc will be set as folder 2 and folder 3.
3. As for folder inside Folder A (Folder C and Folder D), the folder which is recorded earlier on the disc will be set as folder 4 and folder 5.
4. Folder E that is inside Folder D will be set as folder 6.

- The folder and file order information which is recorded on the disc depends on the writing software. There maybe possibilities that this unit will playback the files not according to our expected playback order.
- For CD MP3/WMA, 512 numbers of folders and files inclusives of the folders which have non playable files can be read.

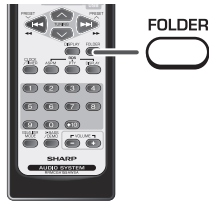

Folder mode on/off can be operated by the FOLDER button on the remote control. Files that are played when folder mode is set to the on position, may differ from those played back when folder mode is turned off.

Folder Mode Off case:

All the files starting from the selected file will be played back. If file 3 inside Folder C is selected, all the files starting from file 3 will be played back until file 10 of Folder E.

Folder Mode On case:

All the files inside the selected folder will be played back. In case Folder D is selected, file 6, 7 and 8 will be played back. File 9 and 10 in Folder E will not be played back.

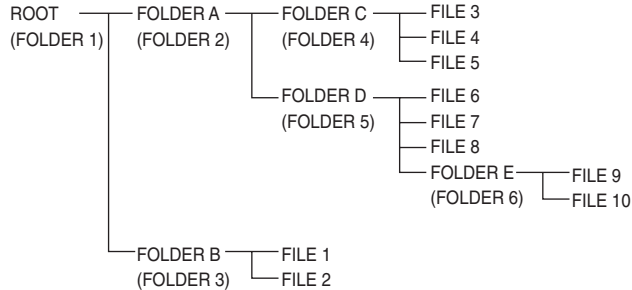

■ Procedure to play back MP3/WMA disc with folder mode on

To play back CD-R/RW.

1 Press the CD button, and load an MP3/WMA disc.

- After disc is loaded, disc info will be displayed.

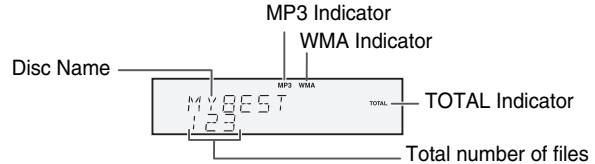

2 Press the FOLDER button, and press the TUNING (∨ or ^) button to select desired playback folder. (Folder mode on)

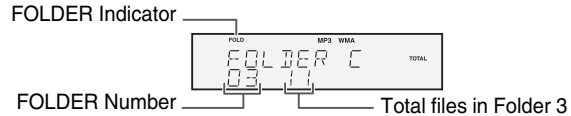

3 Select desired file to be played back by pressing the <<<< or >>>> button.



MP3/WMA folder mode (only for MP3/WMA files) (continued)

4 Press the ► / || (CD ► / ||) button.

Playback will start and file name will be displayed.

- Title, Artist & Album name are displayed if they are recorded on the disc.
- Display content can be changed by pressing the DISPLAY button.

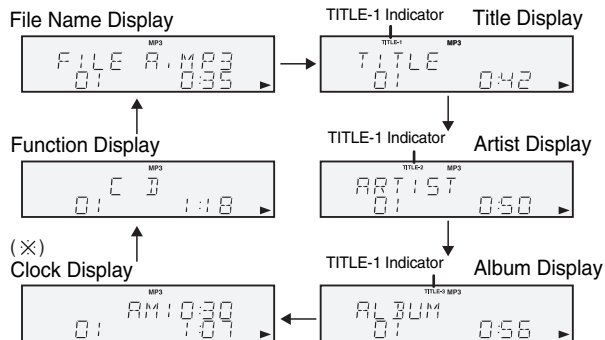

In case of playback with the folder mode on, press the TUNING (∨ or ∧) button, and the folder can be selected even though it is in playback/pause mode.

It will continue playback/pause mode in the 1st track of the selected folder.

(⊗) Only appears when clock is already set.

Note:

If "NO SUPPORT" is displayed, it means "Copyright protected WMA file" or "Not supported playback file" is selected.

Listening to USB mass storage device / MP3 Player

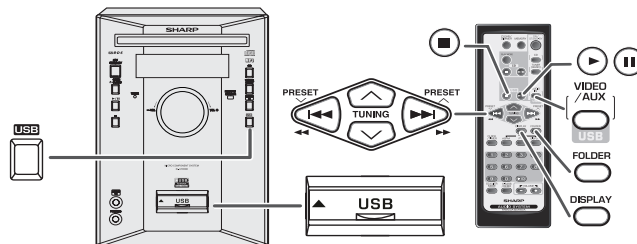

Note:

This product is not compatible with MTP and AAC file systems.

■ To play back USB/MP3 Player with Folder mode off

- 1 Press the USB button, and push up the USB door. Connect the USB Memory device that has MP3/WMA format files on the unit.

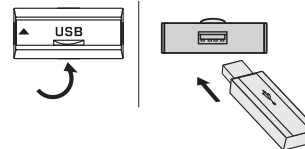

When the USB memory is connected to the main unit, the device information will be displayed.

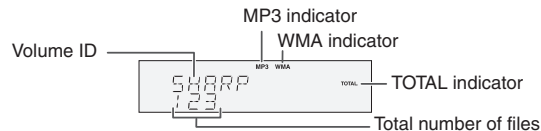

- 2 Select desired file to be played back by pressing the ◀◀ or ▶▶ button.



3 Press the ► / || (USB ► / ||) button.

Playback will start and the file name will be displayed.

- Title, Artist & Album name are displayed if they are recorded in the USB memory device.
- Display content can be changed by pressing the DISPLAY button.

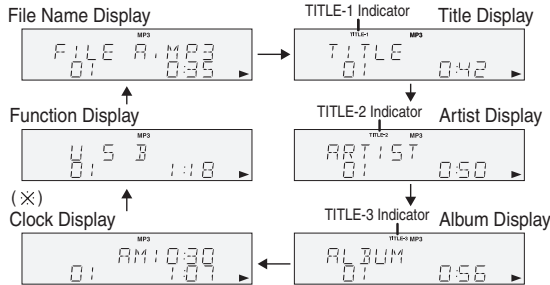

(⊗) Only appears when clock is already set.

Note:

To pause playback:
Press the USB ► / || button.

Auto power off function:

In the stop mode of USB operation, the main unit enters the stand-by mode after 15 minutes of inactivity.

■ To play back USB/MP3 Player with Folder mode on

1 Press the AUDIO IN/USB (USB) button, and push up the USB door. Connect the USB Memory device that has MP3/WMA format files on the unit.

When the USB memory is connected to the main unit, the device information will be displayed.

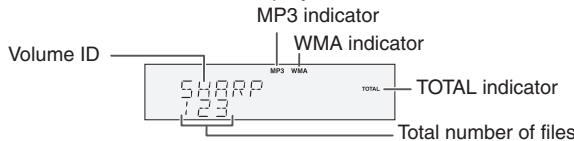

2 Press the FOLDER button, and press the TUNING (∨ or ∧) button to select desired playback folder.

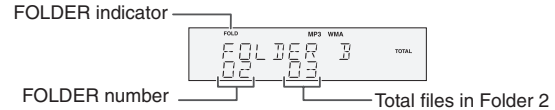

- To start playback with folder mode on, go to step 4.
- To change the playback folder, press the TUNING (∨ or ∧) button to select another folder.

3 Select desired file to be played back by pressing the ◀◀ or ▶▶ button.

4 Press the ► / || (USB ► / ||) button.

Playback will start and the file name will be displayed.

- Title, Artist & Album name are displayed if they are recorded in the USB memory device.
- Display content can be changed by pressing the DISPLAY button.

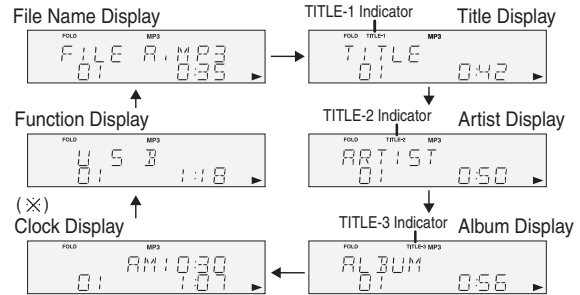

(⊗) Only appears when clock is already set.

Note:

To pause playback:
Press the USB ► / || button.

Auto power off function:

In the stop mode of USB operation, the main unit enters the stand-by mode after 15 minutes of inactivity.

To remove USB memory device

- 1 Press the **USB** button to stop playback. Then press the **USB** button again and wait until "UNPLUG OK" is displayed.

Always remove the USB memory device after "UNPLUG OK" appears on the display. Improper removal of the USB memory device may cause irregularities such as continuous appearance of "READING FILES". Should this happen, turn off the unit and then turn it on again.

- 2 Disconnect USB memory device from the USB terminal.

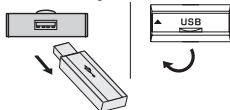

Notes:

- SHARP will not be held liable for the loss of data whilst the USB memory device is connected to the audio system.
- Files compressed in MP3 and / or WMA format can be played back when connected to the USB terminal.
- This USB memory's format supports FAT 16 or FAT 32.
- SHARP cannot guarantee that all USB memory devices will work on this audio system.
- USB cable is not recommended for use in this audio system to connect to USB memory device. Use of the USB cable will affect the performance of this audio system.
- This USB memory cannot be operated via USB hub.
- The USB terminal in this unit is not intended for a PC connection but is used for music streaming with a USB memory device.
- External HDD-storage cannot be played back via USB terminal.
- If the data inside the USB memory is large, it may take longer time for the data to be read.
- This product can play WMA and MP3 files. It will automatically detect the file type being played. If unplayable file is played on this product, "NO SUPPORT" is indicated and the file will be automatically skipped. This will take a few seconds. If abnormal indications appear on the display due to the unspecified file, turn off the unit and then turn it on again.
- This product relates to USB mass storage devices and MP3 players. It may however face some irregularities due to various unforeseen reasons from some devices. Should this happen, turn off the unit and then turn it on again.
- The USB port is intended for direct connection to a USB memory device without any cable.

Advanced USB playback

Repeat play

Repeat play can play all tracks sequence continuously.

To repeat all tracks:

Press the PLAY MODE button.
Press the **▶ / ||** button.



To cancel repeat play:

Press the PLAY MODE button again until "◀" will disappear.

Random play

The tracks can be played in random order automatically.

To random play all tracks:

Press and hold down PLAY MODE button on the remote control.
Press the **▶ / ||** button.

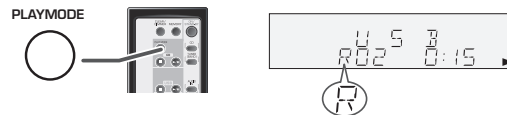

To cancel random play:

Press the PLAY MODE button.
"R" will disappear.

Notes:

- If you press the **▶▶** button during random play, you can move to the track selected next by the random operation. On the other hand, the **◀◀** button does not allow you to move to the previous track. The beginning of the track being played will be located.
- In random play, the unit will select and play tracks automatically. (You cannot select the order of the tracks.)

Note:

(✕) When folder mode is on, the selected play mode can be used for the files in the selected folder only.

Notes:

- This unit only supports “MPEG-1 Audio Layer-3” format. (Sampling Frequency is 32, 44.1, 48kHz) “MPEG-2 Audio Layer-3”, “MPEG-2.5 Audio Layer-3” and MP1, MP2 format are not supported.
- Programme playback for USB memory is not available.
- Playback order for MP3 files may differ sometimes depending on the writing software used during file download.
- Bitrate which is supported by MP3 is 32~320 kbps, WMA is 64~160 kbps.
- For MP3/WMA files, please put “.MP3” “.WMA” extension. Files cannot be played back if there is no MP3/WMA extension.
- Playlists are not supported on this unit.
- This unit can display Folder Name or File Name up to 32 characters.
- Maximum total number of MP3/WMA files is 65280. Maximum total number of folders is 255 inclusive of root directory. Folders which have non playable files also counted.
- The display playback time may not be displayed correctly when playing back a variable bitrate file.
- Time display cannot be changed by the DISPLAY button.
- The ID3TAG information supported are TITLE, ARTIST and ALBUM only.
- Title name, artist name and album name can be displayed by pressing the DISPLAY button during file playback or pause mode.
- WMA meta tag also supports title, artist and album name which are recorded in WMA files.
- Copyright protected WMA files cannot be played back.

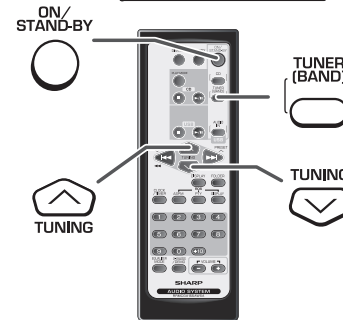
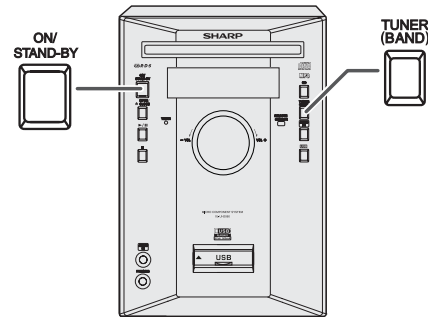

Auto power on function:

When you press any of the following buttons, the unit turns on.

- TUNER (BAND) button (main unit and remote control): The unit turns on and the “TUNER” function is activated.
- ► / || button on the main unit: The unit turns on and playback of the last function starts (CD, TUNER, AUDIO IN, USB).

Note:

This product can receive FM stereo/FM monaural and AM monaural broadcasts. Am stereo broadcasts will not be played in stereo.

Listening to radio (continued)

■ Tuning

- 1** Press the ON/STAND-BY button to turn the power on.
- 2** Press the TUNER (BAND) button repeatedly to select the desired frequency band (FM or AM).
- 3** Press the TUNING (∨ or ∧) button on the remote control to tune in to the desired station.

Manual tuning:

Press the TUNING (∨ or ∧) button as many times as required to tune in to the desired station.

Auto tuning:

When the TUNING (∨ or ∧) button is pressed for more than 0.5 seconds, scanning will start automatically and the tuner will stop at the first receivable broadcast station.

Notes:

- When radio interference occurs, auto scan tuning may stop automatically at that point.
- Auto scan tuning will skip weak signal stations.
- To stop the auto tuning, press the TUNING (∨ or ∧) button again.
- When an RDS (Radio Data System) station is tuned in, the frequency will be displayed first, and then the RDS indicator will light up. Finally, the station name will appear.
- Full auto tuning can be achieved for RDS stations "ASPM", see page 26.

To receive an FM stereo transmission:

Press the TUNER (BAND) button to select stereo mode and "ST" indicator will be displayed.

- "∞" will appear when an FM broadcast is in stereo.
- If the FM reception is weak, press the TUNER (BAND) button to extinguish the "ST" indicator. The reception changes to monaural, and the sound becomes clearer.

FM stereo mode indicator



FM stereo receiving indicator

■ Memorising a station

You can store 40 AM and FM stations in memory and recall them at the push of a button. (Preset tuning)

- 1** Perform steps 1 - 3 in "Tuning" on page 24.
- 2** Press the MEMORY button to enter the preset tuning saving mode.



- 3** Within 30 seconds, press the PRESET (∧ or ∨) button to select the preset channel number.

Store the stations in memory, in order, starting with preset channel 1.

- 4** Within 30 seconds, press the MEMORY button to store that station in memory.



If the "MEMORY" and preset number indicators disappear before the station is memorised, repeat the operation from step 2.

- 5** Repeat steps 1 - 4 to set other stations, or to change a preset station.

When a new station is stored in memory, the station previously memorised for that preset channel number will be erased.

Note:

The backup function protects the memorised stations for a few hours should there be a power failure or the AC power lead become disconnected.

Using the Radio Data System (RDS)

■ To recall a memorised station

Press the PRESET (^ or v) button for less than 0.5 seconds to select the desired station.

■ To scan the preset stations

The stations saved in memory can be scanned automatically. (Preset memory scan)

- 1 Press the PRESET (^ or v) button for more than 0.5 seconds. The preset number will flash and the programmed stations will be tuned in sequentially, for 5 seconds each.
- 2 Press the PRESET (^ or v) button again when the desired station is located.

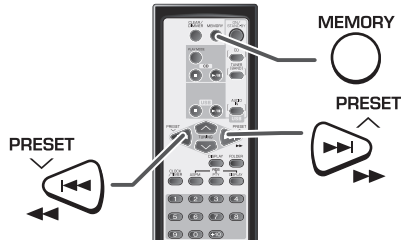

■ To erase entire preset memory

- 1 Press the ON/STAND-BY button to enter the stand-by mode.
- 2 Whilst pressing down the ■ button, press the TUNER (BAND) button until "TUNER CLEAR" appears.



RDS is a broadcasting service which a growing number of FM stations provide. These FM stations send additional signals along with their regular programme signals. They send their station names, and information about the type of programme such as sport, music, etc.

When tuned to an RDS station, "RDS" and the station name will be displayed.

"TP" (Traffic Programme) will appear on the display when the received broadcast carries traffic information, and "TA" (Traffic Announcement) will appear whilst a traffic information is on air.

"PTY" (Dynamic PTY Indicator) will appear whilst the Dynamic PTY station is received.

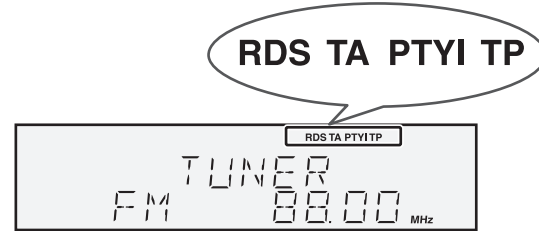

You can control the RDS by using the buttons on the remote control only.

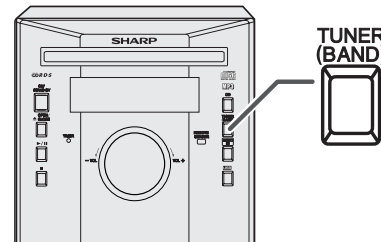

Using the Radio Data System (RDS) (continued)

■ Information provided by RDS

Each time the RDS DISPLAY button is pressed, the display will switch as follows:

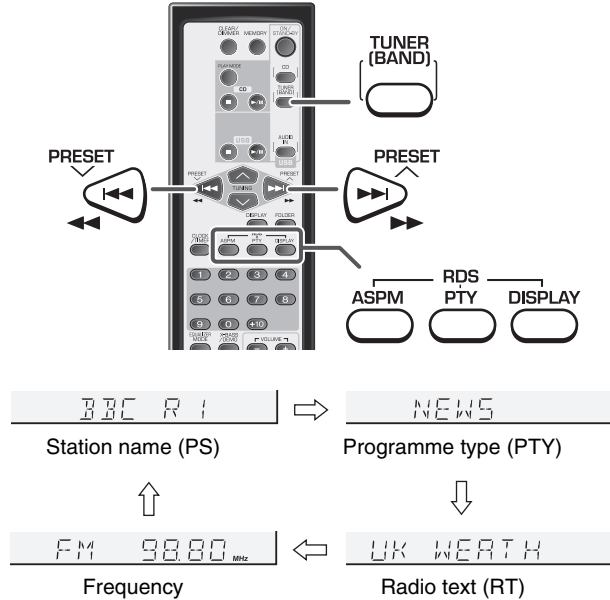

When you are tuning in to a station other than an RDS station or to an RDS station which sends weak signal, the display will change in the following order:

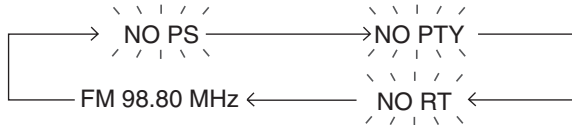

■ Using the Auto Station Programme Memory (ASPM)

Whilst in the ASPM operation mode, the tuner will automatically search for new RDS stations. Up to 40 stations can be stored. If you have already stored some stations in memory, the number of new stations you can store will be less.

- 1 Press the TUNER (BAND) button to select the FM band.**
- 2 Press and hold down the RDS ASPM button on the remote control for at least 3 seconds.**
 - 1 After "ASPM" has flashed for about 4 seconds, scanning will start (87.50 - 108.00 MHz).
 - 2 When an RDS station is found, "RDS" will appear for a short time and the station will be stored in memory.
 - 3 After scanning, the number of stations stored in memory will be displayed for 4 seconds, and then "END" will appear for 4 seconds.

To stop the ASPM operation before it is complete:

Press the RDS ASPM button whilst it is scanning for stations. The stations which are already stored in memory will be kept there.

Notes:

- If the same station is broadcasting on different frequencies, the strongest frequency will be stored in memory.
- Any station which has the same frequency as the one stored in memory will not be stored.
- If 40 stations have already been stored in memory, the scan will be aborted. If you want to redo the ASPM operation, erase the preset memory.
- If no station have been stored in memory, "END" will appear for about 4 seconds.
- If the RDS signals are very weak, station names may not be stored in memory.

To erase all of the contents of preset memory:

- 1 Press the ON/STAND-BY button to enter the power stand-by mode.
- 2 Whilst pressing down the **■** button, press the TUNER (BAND) button until "TUNER CLEAR" appears.
- After performing this operation, all of the preset memory information will be erased.

To store a station name again if the wrong name was stored in memory:

It may be impossible to store station names in memory using the ASPM function if there is lots of noise or if the signal is too weak. In this case, perform as follows.

- 1 Press the PRESET (^ or v) button to check whether the names are correct.
- 2 If you find a wrong name during receiving the station, wait until the correct name is displayed and then press the MEMORY button.
- 3 Within 30 seconds, press the MEMORY button whilst the preset channel number is flashing.
- The new station name has been stored in memory correctly.

Notes:

- The same station name can be stored in different channels.
- In a certain area or during certain time periods, the station names may temporarily be different.

■ Notes for RDS operation

If any of the following events occur, it does not mean that the unit is faulty:

- "PS", "NO PS" and a station name appear alternately, and the unit does not operate properly.
- If a particular station is not broadcasting properly or a station is conducting tests, the RDS reception function may not work properly.
- When you receive an RDS station whose signal is too weak, information like the station name may not be displayed.
- "NO PS", "NO PTY" or "NO RT" will flash for about 5 seconds, and then the frequency will be displayed.

Notes for radio text:

- The first 10 characters of the radio text will appear for 4 seconds and then they will scroll across the display.
- If you tune in to an RDS station which is not broadcasting any radio text, "NO RT" will be displayed when you switch to the radio text position.
- Whilst radio text data is received or when the text contents change, "RT" will be displayed.

Using the Radio Data System (RDS) (continued)

■ To recall stations in memory

To specify programmed types and select stations (PTY search):

You can search a station by specifying the programme type (news, sports, traffic programme, etc. ... see pages 29 - 30) from the stations in memory.

1 Press the TUNER (BAND) button to select the FM band.

2 Press the RDS PTY button on the remote control.

SELECT ↔ PTY TI

“SELECT” and “PTY TI” will appear alternately for about 6 seconds.

3 Within 6 seconds, press the PRESET (^ or v) button to select the programme type.

NEWS

Each time the button is pressed, the programme type will appear. If the button is held down for more than 0.5 seconds, the programme type will appear continuously.

4 Whilst the selected programme type is flashing (within 6 seconds), press the RDS PTY button again.

NEWS → SEARCH

After the selected programme type has been lit for 2 seconds, “SEARCH” will appear, and the search operation will start.

Notes:

- If the display has stopped flashing, start again from step 2. If the unit finds a desired programme type, the corresponding channel number will flash for about 4 seconds, and then the station name will flash for 7 seconds, which will remain lit.
- If you want to listen to the same programme type of another station, press the RDS PTY button whilst the channel number or station name is flashing. The unit will look for the next station.
- If no station can be found, “NOT FOUND” will appear for 4 seconds.

If you select the traffic programme:

If you select the traffic programme (TP) in step 3, “TP” will appear. (This does not mean that you can listen to the traffic information at that time.)

When the traffic information is broadcast, “TA” will appear.

To specify station names and select stations manually:

You can select a station by specifying the name (BBC R1, BBC R2, etc.) from the stations stored in memory.

Before starting this operation, you must store one or more station names in memory.

- 1 Press the TUNER (BAND) button to select the FM band.
- 2 Press the PRESET (^ or v) button on the remote control to select a desired station.
- 3 The station name will be displayed for 6 seconds. Then the display will change.

Descriptions of the PTY (Programme Type) codes, TP (Traffic Programme)TA (Traffic Announcement).

You can search for and receive the following PTY, TP and TA signals.

NEWS	Short accounts of facts, events and publicly expressed views, reportage and actuality.
AFFAIRS	Topical programme expanding or enlarging upon the news, generally in different presentation style or concept, including debate, or analysis.
INFO	Programmes whose purpose is to impart advice in the widest sense.
SPORT	Programme concerned with any aspect of sport.
EDUCATE	Programme intended primarily to educate, of which the formal element is fundamental.
DRAMA	All radio plays and serials.
CULTURE	Programmes concerned with any aspect of national or regional culture, including language, theatre, etc.
SCIENCE	Programmes about the natural sciences and technology.
VARIED	Used for mainly speech-based programmes usually of light-entertainment nature, not covered by other categories. Examples include: quizzes, panel games, personality interviews.
POP M	Commercial music, which would generally be considered to be of current popular appeal, often featuring in current or recent record sales charts.
ROCK M	Contemporary modern music, usually written and performed by young musicians.
EASY M	Current contemporary music considered to be "easy-listening", as opposed to Pop, Rock or Classical, or one of the specialised music styles, Jazz, Folk or Country. Music in this category is often but not always, vocal, and usually of short duration.

LIGHT M	Classical music for general, rather than specialist appreciation. Examples of music in this category are instrumental music, and vocal or choral works.
CLASSICS	Performances of major orchestral works, symphonies, chamber music, etc., and including Grand Opera.
OTHER M	Musical styles not fitting into any of the other categories. Particularly used for specialist music of which Rhythm & Blues and Reggae are examples.
WEATHER	Weather reports and forecasts and meteorological information.
FINANCE	Stock Market reports, commerce, trading, etc.
CHILDREN	For programmes targeted at a young audience, primarily for entertainment and interest, rather than where the objective is to educate.
SOCIAL	Programmes about people and things that influence them individually or in groups. Includes: sociology, history, geography, psychology and society.
RELIGION	Any aspect of beliefs and faiths, involving a God or Gods, the nature of existence and ethics.
PHONE IN	Involving members of the public expressing their views either by phone or at a public forum.
TRAVEL	Features and programmes concerned with travel to near and far destinations, package tours and travel ideas and opportunities. Not for use for announcements about problems, delays, or roadworks affecting immediate travel where TP/TA should be used.
LEISURE	Programmes concerned with recreational activities in which the listener might participate. Examples include, Gardening, Fishing, Antique collecting, Cooking, Food & Wine, etc.
JAZZ	Polyphonic, syncopated music characterised by improvisation.

Using the Radio Data System (RDS) (continued)

COUNTRY	Songs which originate from, or continue the musical tradition of the American Southern States. Characterised by a straightforward melody and narrative story line.
NATION M	Current Popular Music of the Nation or Region in that country's language, as opposed to International "Pop" which is usually US or UK inspired and in English.
OLDIES	Music from the so-called "golden age" of popular music.
FOLK M	Music which has its roots in the musical culture of a particular nation, usually played on acoustic instruments. The narrative or story may be based on historical events or people.
DOCUMENT	Programme concerned with factual matters, presented in an investigative style.
TEST	Broadcast when testing emergency broadcast equipment or receivers.
ALARM !	Emergency announcement made under exceptional circumstances to give warning of events causing danger of a general nature.
NONE	No programme type (receive only).
TP	Broadcasts which carry traffic announcements.
TA	Traffic announcements are being broadcast.

Timer and sleep operation (Remote Control only)

Timer playback:

The unit turns on and plays the desired source (CD, TUNER, USB, AUDIO IN) at a preset time.

This unit has 2 types of timer: ONCE TIMER and DAILY TIMER.

Once timer: Once timer play works for one time only at a preset time.

Daily timer: Daily timer play works at the same preset time every day.

For example, set the timer as a wake-up call every morning.

Using the once timer and daily timer in combination:

For example, use the once timer to listen to a radio programme, and use the daily timer to wake up.

- 1 Set the daily timer (pages 30 - 33).
- 2 Set the once timer (pages 30 - 33).

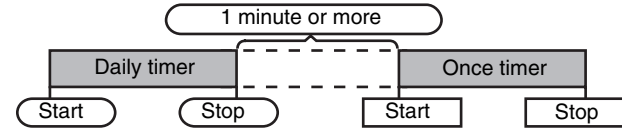

Note:

When the setting times for daily timer and once timer overlap, the once timer takes priority. Allow an interval of at least 1 minute between operations.

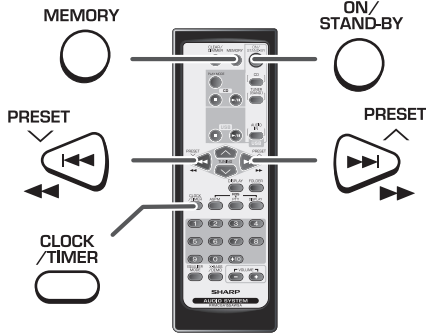

■ Timer playback

Before setting timer:

- 1 Check that the clock is set to the correct time (refer to page 13). If it is not set, you cannot use the timer function.
- 2 For timer playback: Load disc to be played.



- 1 Press the ON/STAND-BY button to turn the power on.
- 2 Press the CLOCK/TIMER button.
- 3 Within 10 seconds, press the <<<< or >>>> button to select "ONCE" or "DAILY", and press the MEMORY button.



Set the clock to the correct time if "ONCE" or "DAILY" does not appear.

- 4 Within 10 seconds, press the <<<< or >>>> button to select "ONCE SET" or "DAILY SET", and press the MEMORY button.



- 5 Press the <<<< or >>>> button to adjust the hour and then press the MEMORY button.



The illustrations show the timer playback setting in the daily timer mode.

- 6 Press the <<<< or >>>> button to adjust the minutes and then press the MEMORY button.



- 7 Set the time to finish as in steps 5 and 6 above.

- 8 Switch input with the <<<< or >>>> button, and then press the MEMORY button.

To select the timer playback source: CD, TUNER, USB or AUDIO IN.

- When you select the tuner, select a station by pressing the <<<< or >>>> button, and then press the MEMORY button.
- If a station has not been programmed, "NO PRESET" will be displayed and timer setting will be cancelled.

Timer and sleep operation (Remote Control only) (continued)

- 9 Adjust the volume using the VOLUME control, and then press the MEMORY button.**

Do not turn the volume up too high.

- 10 Press the ON/STAND-BY button to enter the power stand-by mode.**

The "TIMER" indicator lights up and the unit is ready for timer playback.

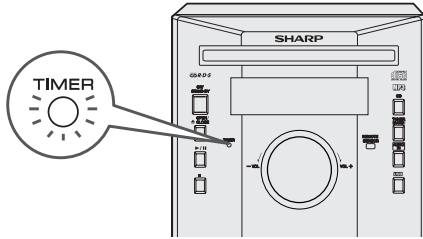

- 11 When the preset time is reached, playback will start.**

The volume will increase gradually until it reaches the preset volume.

- 12 When the timer end time is reached, the system will enter the power stand-by mode automatically.**

Once timer:

The timer will be cancelled.
The "r" indicator will blink during timer playback.

Daily timer:

The timer will operate at the same time every day. It will continue until the daily timer setting is cancelled. Cancel the daily timer when it is not in use.
The "DAILY r" indicator will blink during timer playback.

Notes:

- When performing timer playback using another unit connected to the USB or AUDIO IN socket, select "USB" or "AUDIO IN" in step 8. This unit will turn on or enter the power stand-by mode automatically. However, the connected unit to AUDIO IN socket will not turn on or off.
- To stop the timer playback, follow step "Cancelling the timer setting in the timer stand-by mode".

Checking the timer setting in the timer stand-by mode:

- 1 Press the CLOCK/TIMER button.
- 2 Within 10 seconds, press the ◀◀ ◀◀ or ▶▶ ▶▶ button to select "ONCE" or "DAILY", and press the MEMORY button.
- 3 Within 10 seconds, press the ◀◀ ◀◀ or ▶▶ ▶▶ button to select "ONCE CALL" or "DAILY CALL", and press the MEMORY button. The unit returns to the timer stand-by mode after displaying the settings in order.

Cancelling the timer setting in the timer stand-by mode:

- 1 Press the CLOCK/TIMER button.
- 2 Within 10 seconds, press the ◀◀ ◀◀ or ▶▶ ▶▶ button to select "ONCE" or "DAILY", and press the MEMORY button.
- 3 Within 10 seconds, press the ◀◀ ◀◀ or ▶▶ ▶▶ button to select "ONCE OFF" or "DAILY OFF", and press the MEMORY button. Timer will be cancelled (the setting will not be cancelled).



Reusing the memorised timer setting:

The timer setting will be memorised once it is entered. To reuse the same setting, perform the following operations.

- 1 Turn the power on and press the CLOCK/TIMER button.
- 2 Within 10 seconds, press the ◀◀ ◀◀ or ▶▶ ▶▶ button to select "ONCE" or "DAILY", and press the MEMORY button.
- 3 Within 10 seconds, press the ◀◀ ◀◀ or ▶▶ ▶▶ button to select "ONCE ON" or "DAILY ON", and press the MEMORY button.
- 4 Press the ON/STAND-BY button to enter the power stand-by mode.

■ Sleep operation

The radio, compact disc and USB can be turned off automatically.

1	Play back the desired sound source.
2	Press the CLOCK/TIMER button.
3	Within 10 seconds, press the ◀◀◀◀ or ▶▶▶▶ button to select "SLEEP", and press the MEMORY button. 
4	Press the ◀◀◀◀ or ▶▶▶▶ button to select the time. (Maximum: 3 hours - Minimum: 1 minute) <ul style="list-style-type: none"> ● 3 hours - 5 minutes → 5-minute intervals ● 5 minutes - 1 minute → 1-minute intervals
5	Press the MEMORY button. "SLEEP" will appear. 
6	The unit will enter the power stand-by mode automatically after the preset time has elapsed. The volume will be turned down 1 minute before the sleep operation finishes.

To confirm the remaining sleep time:

- 1 Whilst "SLEEP" is indicated, press the CLOCK/TIMER button.
- 2 Within 10 seconds, press the ◀◀◀◀ or ▶▶▶▶ button to select "SLEEP X : XX".
 "X : XX" is sleep remaining time.
 - The remaining sleep time is displayed for about 10 seconds.
 - You can change the remaining sleep time whilst it is displayed by pressing the MEMORY button (steps 4 - 5).

To cancel the sleep operation:

Press the ON/STAND-BY button whilst "SLEEP" is indicated.

To cancel the sleep operation without setting the unit to the stand-by mode, proceed as follows.

- 1 Whilst "SLEEP" is indicated, press the CLOCK/TIMER button.
- 2 Within 10 seconds, press the ◀◀◀◀ or ▶▶▶▶ button to select "SLEEP OFF", and press the MEMORY button.

■ To use timer and sleep operation together

Sleep and timer playback:

For example, you can fall asleep listening to the radio and wake up to CD in the next morning.

- 1 Set the sleep time (see left, steps 1 - 5).
- 2 Whilst the sleep timer is set, set the timer playback (steps 2 - 10, pages 30 - 32).

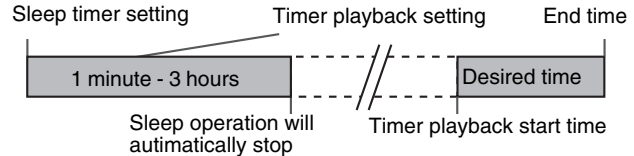

Enhancing your system

The connection lead is not included. Purchase a commercially available lead as shown below.

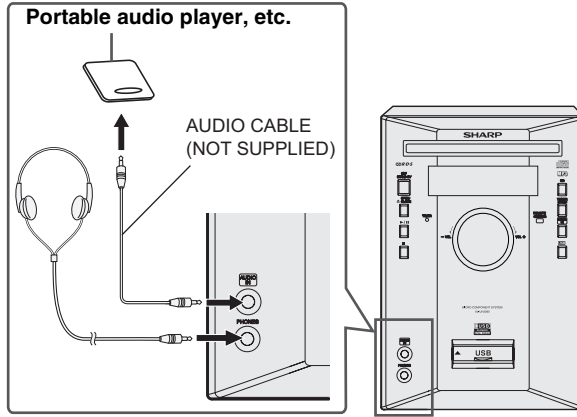

Auto power on function (AUDIO IN):

When you press any of the following buttons, the unit turns on.

- AUDIO IN button (main unit and remote control): The unit turns on and the "AUDIO IN" function is activated.
- ► / || button on the main unit: The unit turns on and playback of the last function starts (CD, TUNER, AUDIO IN, USB).

■ Listening to the playback sounds of Portable Audio Player, etc.

1 Use a connection lead to connect the Portable Audio Player etc. to the AUDIO IN socket.

When using video equipment, connect the audio output to this unit and the video output to a television.

2 Press the ON/STAND-BY button to turn the power on.

3 Press the AUDIO IN button.

4 Play the connected equipment.

If volume level of the connected device is too high, sound distortion may occur. Should this happen, lower the volume of the connected device.

If volume level is too low, increase the volume of the connected device.

Note:

To prevent noise interference, place the unit away from the television.

■ Headphones

- Do not turn the volume on to full at switch on. Listen to music at moderate levels. Excessive sound pressure from earphones and headphones can cause hearing loss.
- Before plugging in or unplugging the headphones, reduce the volume.
- Be sure your headphones have a 3.5 mm (1/8") diameter plug and impedance between 16 and 50 ohms. The recommended impedance is 32 ohms.
- Plugging in the headphones disconnects the speakers automatically. Adjust the volume using the VOLUME control.

■ Subwoofer connection

When a commercially available subwoofer with a built-in amplifier is connected to this unit, you can enjoy sound with emphasised bass. Connect an RCA lead from a commercially available speaker with a built-in amplifier to the SUBWOOFER PRE-OUT socket.

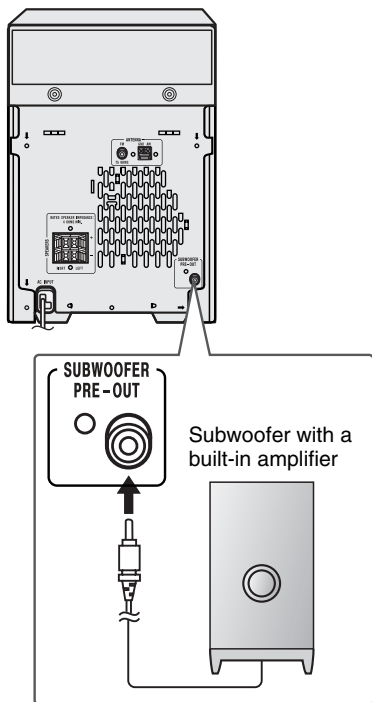

Many potential problems can be resolved by the owner without calling a service technician. If something is wrong with this product, check the following before calling your authorised SHARP dealer or service centre.

■ General

Symptom	Possible cause
<ul style="list-style-type: none"> ● The clock is not set to the correct time. 	<ul style="list-style-type: none"> ● Did a power failure occur? Reset the clock. (Refer page 13)
<ul style="list-style-type: none"> ● When a button is pressed, the unit does not respond. 	<ul style="list-style-type: none"> ● Set the unit to the power stand-by mode and then turn it back on. ● If the unit still malfunctions, reset it. (Refer page 36)
<ul style="list-style-type: none"> ● No sound is heard. 	<ul style="list-style-type: none"> ● Is the volume level set to "0"? ● Are the headphones connected? ● Are the speaker wires disconnected?

■ CD player

Symptom	Possible cause
<ul style="list-style-type: none"> ● Playback does not start. ● Playback stops in the middle or is not performed properly. 	<ul style="list-style-type: none"> ● Is the disc loaded upside down? ● Does the disc satisfy the standards? ● Is the disc distorted or scratched?
<ul style="list-style-type: none"> ● Playback sounds are skipped, or stopped in the middle of a track. 	<ul style="list-style-type: none"> ● Is the unit located near excessive vibrations? ● Is the disc very dirty? ● Has condensation formed inside the unit?

Troubleshooting chart (continued)

■ Remote Control

Symptom	Possible cause
<ul style="list-style-type: none"> The remote control does not operate. 	<ul style="list-style-type: none"> Is the AC power lead of the unit plugged in? Is the battery polarity correct? Are the batteries dead? Is the distance or angle incorrect? Does the remote control sensor receive strong light?

■ Tuner

Symptom	Possible cause
<ul style="list-style-type: none"> The radio makes unusual noises continuously. 	<ul style="list-style-type: none"> Is the unit placed near the TV or computer? Is the FM aerial or AM loop aerial placed properly? Move the aerial away from the AC power lead if it's located nearby.

■ USB

Symptom	Possible cause
<ul style="list-style-type: none"> Device cannot detect. 	<ul style="list-style-type: none"> Is there any MP3/WMA file available? Does the device properly connected? Does it MTP device? Does the device contain AAC file only?
<ul style="list-style-type: none"> Playback does not start. 	<ul style="list-style-type: none"> Is it the copyright protected WMA file? Is it the false MP3 file?
<ul style="list-style-type: none"> Time display not correct. File Name display not correct. 	<ul style="list-style-type: none"> Does Variable Bitrate file being playback? The File Name had written in Chinese or Japanese character?

■ Condensation

Sudden temperature changes, storage or operation in an extremely humid environment may cause condensation inside the cabinet (CD pickup, etc.) or on the transmitter on the remote control. Condensation can cause the unit to malfunction. If this happens, leave the power on with no disc in the unit until normal playback is possible (about 1 hour). Wipe off any condensation on the transmitter with a soft cloth before operating the unit.

■ If problem occurs

When this product is subjected to strong external interference (mechanical shock, excessive static electricity, abnormal supply voltage due to lightning, etc.) or if it is operated incorrectly, it may malfunction.

If such a problem occurs, do the following:

- Set the unit to the stand-by mode and turn the power on again.
- If the unit is not restored in the previous operation, unplug and plug in the unit, and then turn the power on.

Note:

If neither operation above restores the unit, clear all the memory by resetting it.

■ Factory reset, clearing all memory

- Press the ON/STAND-BY button to enter the power stand-by mode.
- Whilst pressing down the ■ button, press the CD button until "CLEAR ALL" appears.



Caution:

This operation will erase all data stored in memory including clock, timer settings, tuner preset, and CD programme.

■ Before transporting the unit

Remove CD from the unit. Make sure there is no CD in the disc tray. Then, set the unit to the power stand-by mode. Carrying the unit with disc left inside can damage the unit.

Specifications

■ Care of compact discs

Compact discs are fairly resistant to damage, however mistracking can occur due to an accumulation of dirt on the disc surface. Follow the guidelines below for maximum enjoyment from your CD collection and player.

- Do not write on either side of the disc, particularly the non-label side from which signals are read. Do not mark this surface.
- Keep your discs away from direct sunlight, heat, and excessive moisture.
- Always hold the CDs by the edges. Fingerprints, dirt, or water on the CDs can cause noise or mistracking. If a CD is dirty or does not play properly, clean it with a soft, dry cloth, wiping straight out from the centre, along the radius.

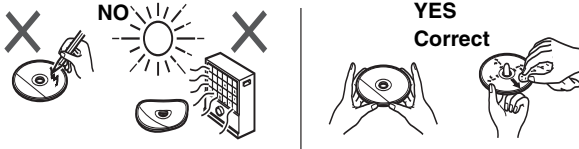

Maintenance

■ Cleaning the CD pickup lens

In order to ensure proper operation of the CD player, preventative maintenance (cleaning of the laser pickup lens) should be performed periodically. Lens cleaners are commercially available. Contact your local CD software dealer for options.

■ Cleaning the cabinet

Periodically wipe the cabinet with a soft cloth and a diluted soap solution, then with a dry cloth.

Caution:

- Do not use chemicals for cleaning (petrol, paint thinner, etc.). It may damage the cabinet finish.
- Do not apply oil to the inside of the unit. It may cause malfunctions.

As part of our policy of continuous improvement, SHARP reserves the right to make design and specification changes for product improvement without prior notice. The performance specification figures indicated are nominal values of production units. There may be some deviations from these values in individual units.

■ General

Power source	AC 220 - 240V ~ 50Hz
Power consumption	Power on: 40 W Power stand-by: 0.6 W (*)
Dimensions	Width: 180 mm (7 - 1/16") Height: 260 mm (10 - 2/8") Depth: 273 mm (10 - 6/8")
Weight	4.0 kg (8.8 lbs.)

(*) This power consumption value is obtained when the demonstration mode is cancelled in the power stand-by mode. Refer to page 10 to cancel the demonstration mode.

■ Amplifier

Output power	PMPO : 128 W MPO : 64 W (32 W + 32 W) (10% T.H.D.) RMS: 64 W (32 W + 32 W) (10% T.H.D.) RMS: 40 W (20 W + 20 W) (1% T.H.D.)
Output terminals	Speakers: 4 ohms Headphones: 16 - 50 ohms (recommended: 32 ohms) Subwoofer pre-out (audio signal): 150 mV/10 k ohms at 70 Hz
Input terminals	Audio In (Audio signal): 250 mV/47 k ohms

Specifications (continued)

■ CD player

Type	Single disc multi-play compact disc player
Signal readout	Non-contact, 3-beam semiconductor laser pickup
D/A converter	Multi bit D/A converter
Frequency response	20 - 20,000 Hz
Dynamic range	90 dB (1 kHz)

■ Tuner

Frequency range	FM: 87.5 - 108 MHz AM: 522 - 1,620 kHz
------------------------	---

■ Speaker

Type	2-way type speaker system 5 cm (2") tweeter 10 cm (4") woofer
Maximum input power	64 W
Rated input power	32 W
Impedance	4 ohms
Dimensions	Width: 130 mm (5 - 1/2") Height: 260 mm (10 - 1/4") Depth: 164.5 mm (6 - 1/2")
Weight	1.75 kg (3.90 lbs.) / each

■ USB

USB host interface	<ul style="list-style-type: none"> ● Complies with USB 1.1 (Full Speed)/ 2.0 Mass-Storage-Class. ● Support Bulk only and CBI protocol.
Support file	<ul style="list-style-type: none"> ● MPEG 1 Layer 3 ● WMA (Non DRM)
Bitrate support	<ul style="list-style-type: none"> ● MP3 (32 ~ 320 kbps) ● WMA (64 ~ 160 kbps)
Other	<ul style="list-style-type: none"> ● Maximum total number of MP3/WMA files is 65280. ● Maximum total number of folders is 255 INCLUSIVE of root directory. (Folders which have non playable files also counted.) ● The ID3TAG information supported are TITLE, ARTIST and ALBUM only. ● Support ID3TAG version 1 and version 2.
File system support	<ul style="list-style-type: none"> ● Support USB devices with Microsoft Windows/DOS/FAT 12/ FAT16/ FAT 32. ● 2 kbyte block length for sector.

SHARP

FOR LOCATION ENQUIRIES WITHIN

AUSTRALIA

REGARDING YOUR LOCAL

SHARP APPROVED SERVICE CENTRE

VISIT OUR WEBSITE AT

www.sharp.net.au

OR CALL SHARP CUSTOMER CARE

1300 135 022

(LOCAL CALL COST APPLY WITHIN AUSTRALIA)

SHARP CORPORATION OF AUSTRALIA PTY LTD

SHARP

FOR LOCATION ENQUIRIES WITHIN

NEW ZEALAND

REGARDING YOUR LOCAL

SHARP APPROVED SERVICE CENTRE

VISIT OUR WEBSITE AT

www.sharp.net.nz

CONTACT YOUR SELLING DEALER/RETAILER

OR CALL

SHARP CUSTOMER SERVICES

TELEPHONE: 09 573 0111

FACSIMILE: 09 573 0113

SHARP CORPORATION OF NEW ZEALAND LIMITED

SPform019(JUNE 2004)

SHARP

WARRANTY

Consumer Electronic Products

Congratulations on Your Purchase!

This Sharp product is warranted against faults in materials and manufacture for a period of twelve(12) months from the date of original purchase.

If service is required during the warranty period, please contact your nearest Sharp Approved Service Centre. These repairs would be carried out at no charge to the owner, subject to the conditions specified herein.

The owner is responsible for any transportation and insurance costs if the product has to be returned for repair.

This warranty does not extend to accessories or defects or injuries caused by or resulting from causes not attributable to faulty parts or the manufacture of the product, including but not limited to, defect or injury caused by or resulting from misuse, abuse, neglect, accidental damage, improper voltage, liquid spillage, vermin infestation, software, or any alterations made to the product which are not authorised by Sharp.

Please retain your sales documentation, as this should be produced to validate a warranty claim.

This warranty is in addition to and in no way limits, varies or excludes any express and implied rights and remedies under any relevant legislation in the country of sale.

IMPORTANT DO NOT RETURN THIS DOCUMENT TO SHARP

For your reference, please enter the particulars of your purchase below and retain, with your purchase documentation.

Model No. _____ Date of Purchase _____

Serial No. _____ Retailer _____

SHARP
SHARP CORPORATION OF
AUSTRALIA PTY. LIMITED
AGN 140 000 038 1405
1 Huntingwood Drive
Huntingwood NSW 2148
SHARP CORPORATION OF
NEW ZEALAND LIMITED
59 Hugo Johnson Drive
Peterson, Auckland
SHARP (A)NE-2204

IMPORTANT NOTICE: This warranty applies only to products sold in Australia & New Zealand

SHARP

SHARP CORPORATION

TINSEA252AWZZ

08E R MW ①

Free Manuals Download Website

<http://myh66.com>

<http://usermanuals.us>

<http://www.somanuals.com>

<http://www.4manuals.cc>

<http://www.manual-lib.com>

<http://www.404manual.com>

<http://www.luxmanual.com>

<http://aubethermostatmanual.com>

Golf course search by state

<http://golfingnear.com>

Email search by domain

<http://emailbydomain.com>

Auto manuals search

<http://auto.somanuals.com>

TV manuals search

<http://tv.somanuals.com>