

**SHINDAIWA OWNER'S/OPERATOR'S MANUAL**  
**DH254 HEDGE TRIMMER**



**WARNING!**

Minimize the risk of injury to yourself and others! Read this manual and familiarize yourself with the contents. Always wear eye and hearing protection when operating this unit.

X7502864301  
06/10

**shindaiwa**®

## Introduction

The Shindaiwa DH254 Hedge Trimmer has been designed and built to deliver superior performance and reliability without compromise to quality, comfort, or durability.

Shindaiwa high performance engines represent the leading edge of air-cooled engine technology, delivering exceptionally high power at remarkable low displacement and weight. As an owner/operator, you'll soon discover for yourself why Shindaiwa is simply in a class by itself!

### IMPORTANT!

The information contained in this manual describes units available at the time of publication.

While every attempt has been made to give you the very latest information about your Shindaiwa product, there may be some differences between your DH254 hedge trimmer and what is described here.

Echo Inc. reserves the right to make changes to products without prior notification, and without obligation to make alterations to units previously manufactured.



### WARNING!

The engine exhaust from this product contains chemicals known to the State of California to cause cancer, birth defects or other reproductive harm.

## Attention Statements



### DANGER!

A statement preceded by the triangular attention symbol and the word "DANGER" contains information that should be acted upon to prevent serious injury or death.



### WARNING!

A statement preceded by the triangular Attention Symbol and the word "WARNING" contains information that should be acted upon to prevent serious bodily injury.

### CAUTION!

A statement preceded by the word "CAUTION" contains information that should be acted upon to avoid damaging your unit.

### IMPORTANT!

A statement preceded by the word IMPORTANT is one that possesses special significance.

### NOTE:

A statement preceded by the word "NOTE" contains information that is handy to know and may make your job easier.



Read and follow this operators manual. Failure to do so could result in serious injury.



Wear eye and hearing protection at all times during the operation of this unit.



The blades are SHARP! Handle with care.

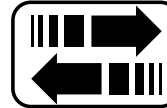

Keep hands clear of the cutter blades when starting the engine.



**WARNING!** Surface can be hot. Always wear gloves when handling this unit.

### IMPORTANT!

The operational procedures described in this manual are intended to help you get the most from your unit, and to protect you and others from harm. These procedures are guidelines for safe operation under most conditions, and are not intended to replace any safety rules and/or laws that may be in force in your area.

If you have questions regarding your DH254 hedge trimmer, or if you do not understand something in this manual, your Shindaiwa dealer will be glad to assist you. You may also contact Shindaiwa, at the address printed on the back of this manual.

## Contents

	PAGE		PAGE		PAGE
Introduction .....	2	Emission Control .....	6	Starting the Engine .....	10
Attention Statements .....	2	Unit Description .....	6	Stopping the Engine .....	11
General Safety Instructions .....	3	Assembly .....	7	Maintenance and Adjustments .....	12
Safety and Equipment Labels .....	5	Mixing Fuel .....	8	Long Term Storage.....	18
Specifications.....	5	Filling the Fuel Tank .....	9	Troubleshooting Guide .....	19
				Warranty Statement.....	22

# General Safety Instructions

## Work Safely

Shindaiwa hedge trimmers operate at very high speeds and can do serious damage or injury if they are misused or abused. *Never allow a person without training or instruction to operate your unit!*



### WARNING!

Never make unauthorized attachment installations.

## Stay Alert

You must be physically and mentally fit to operate this unit safely.



### WARNING!



Never operate power equipment of any kind if you are tired or if you are under the influence of alcohol, drugs, medication or any other substance that could affect your ability or judgement.



### WARNING!

#### Minimize the Risk of Fire!

**ALWAYS** check unit for fuel leaks before use. Check for leaks around fuel tank cap while refueling. If fuel leaks are found immediately stop using the unit. Fuel leaks must be repaired before using unit.

**ALWAYS** move the unit to a place well away from a fuel storage area or other readily flammable materials before starting the engine.

## WORK SAFELY!

**Always** wear close-fitting clothing. Gloves offer added protection and are strongly recommended. Do not wear clothing or jewelry that could get caught in machinery.

**Never** allow children to use the unit. Avoid operating near bystanders.

**Always** wear eye, ear, and hand protection while operating this unit!

**Always** operate with both hands firmly gripping the unit.

**Always** stop the engine before removing branches or debris from the cutters! Never allow the cutters to contact buildings or other hard objects!

**Never** operate this unit if the safety guard has been removed or damaged!

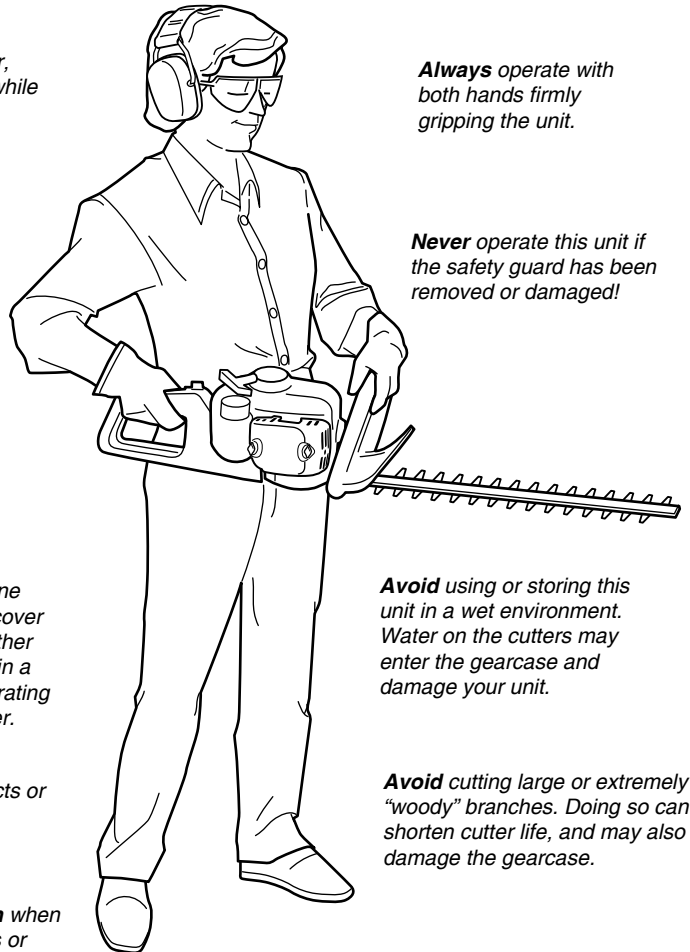

**Always** stop the engine and install the blade cover before moving to another work site, and maintain a firm footing while operating or carrying the trimmer.

**Avoid** using or storing this unit in a wet environment. Water on the cutters may enter the gearcase and damage your unit.

**Never** cut metal objects or wire with the blade.

**Avoid** cutting large or extremely "woody" branches. Doing so can shorten cutter life, and may also damage the gearcase.

**Use extreme caution** when operating near fences or electric wiring.

**Always** keep proper footing and do not overreach. Maintain your balance at all times during operation.

Figure 1

## Operating Precautions



### WARNING!

- Never transport the hedge trimmer or leave it unattended with the engine running. An engine that's running could be accidentally accelerated causing the blades to oscillate.
- Make sure that the blade cover is in place when transporting or storing the hedge trimmer.
- Always make sure that the cutter attachment and all handles and guards are properly installed and firmly tightened before operation.
- Inspect for broken, missing or improperly installed parts or attachments.
- Never use a cracked or warped cutter or cutter bar: replace it with a serviceable one and make sure it fits properly.
- Make sure there are no missing or loose fasteners, and that the stop switch and throttle controls are working properly.
- Make sure there is always good ventilation when operating the hedge trimmer. Fumes from engine exhaust can cause serious injury or death. Never run the engine indoors!
- Never smoke or light fires near the hedge trimmer. Keep the unit away from excessive heat. Engine fuel is very flammable and fire could lead to serious personal injury or property damage.
- Make sure the cutters are correctly adjusted before operating the hedge trimmer (see the section "Blades" for cutter adjustment procedures). Never attempt cutter adjustment with the engine running!
- Before starting the engine, make sure the cutter is not contacting anything.
- Always confirm safe operation when using the machine.
- Immediately stop the engine with the stop switch if the machine suddenly begins to vibrate or shake.
- Always stop the engine immediately and check for damage if you strike a foreign object or if the machine becomes tangled. Do not operate with broken or damaged equipment.
- When cutting a branch that is under tension, be alert for spring-back so that you will not be struck by the moving branch.
- If a cutter should bind fast in a cut, shut off the engine immediately. Push the branch or tree to ease the bind and free the cutter.
- Always stop the engine and allow it to cool before refueling. Avoid overfilling and wipe off any fuel that may have spilled.
- To reduce fire hazard, keep the engine and muffler free of debris, leaves, or excessive grease
- Keep a Solid Stance. Maintain footing and balance at all times. Do not stand on slippery, uneven or unstable surfaces. Do not work in odd positions or on ladders. Do not over reach.



### WARNING!

Hedge Clipper blades are very sharp. Touching them may lead to severe personal injury. Avoid touching blades whenever possible, and always wear gloves to protect hands

### CAUTION!

- Always maintain the hedge trimmer according to this owner's manual and follow the recommended scheduled maintenance.
- Never modify or disable any of the hedge trimmer's safety devices. Doing so may cause damage and lead to personal injury
- Always use genuine Shindaiwa parts and accessories when repairing or maintaining this machine.
- Do not make unauthorized modifications to the hedge trimmer or its components.
- Keep the cutters sharp and properly adjusted.
- Never allow the engine to run at high speed without a load. Doing so could damage the engine.
- When transporting the hedge trimmer in a vehicle, tie it down securely to prevent fuel spillage or damage to the machine.
- Always stop the engine and allow it to cool before refueling. Avoid overfilling and wipe off any fuel that may have spilled.
- Never place flammable material close to the engine muffler and never run the engine without the spark arrestor screen in place.
- Always clear your work area of trash or hidden debris to help ensure good footing.
- Keep the hedge trimmer as clean as possible. Keep it free of loose vegetation, mud, etc.



### WARNING!

Inspect front and rear handles for damaged or loose attachments before use. **NEVER** operate a hedge trimmer with damaged or loose handles.

## Safety Equipment and Labels

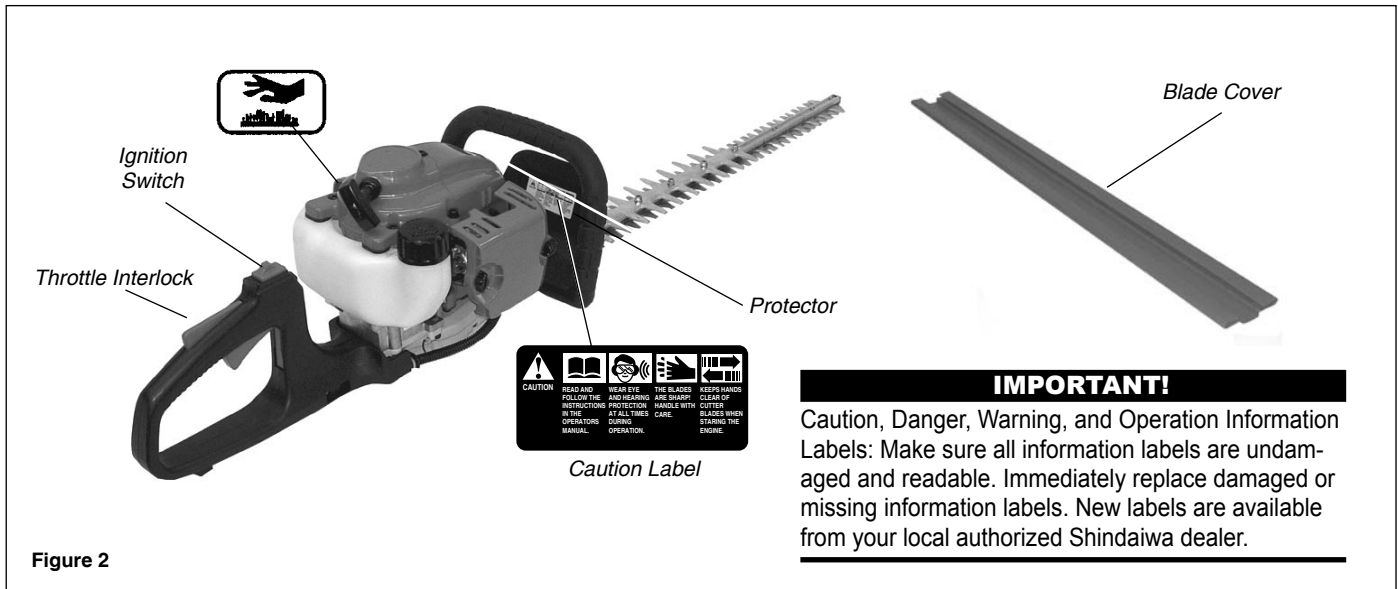

Figure 2

## Specifications

Model	DH254-24	DH254-30
Engine Type	4-cycle, horizontal cylinder, air cooled	
Engine Bore x Stroke	34mm x 27mm (1.34 x 1.06 in)	
Engine Displacement	24.5cc (1.5 in <sup>3</sup> )	
Unit Weight, Less Fuel	6.0 kg (13.2 lb)	6.2 kg (13.7 lb)
Unit Dimensions (LxWxH)	1100 x 255 x 230 mm (43.31 x 9.65 x 9.06 in)	1220 x 255 x 230 mm (48.03 x 9.65 x 9.06 in)
Fuel Tank Capacity	0.55 liter/ 18.6 oz.	
Fuel/oil ratio	50:1 with *ISO-L-EGD or JASO FD class engine Oil	
Carburetor	Diaphragm type	
Ignition	Electronic	
Spark Plug	NGK CMR5H	
<i>Electrode Gap</i>	0.6 mm/ .024 in.	
<i>Torque</i>	16.7 - 18.6 N·m / 148-165 in · lbf	
Air Cleaner	Foam pre-filter; main filter: dry element	
Muffler Type	Spark arrestor muffler or spark arrestor muffler with catalyst	
Starting Method	Recoil type	
Stopping Method	Slide switch, grounding type	
Blade Length	610 mm (24.02 in)	740 mm (29.13 in)
Blade Type	Double-blade cutting action: double-edged blade	
Clutch Type	Centrifugal clutch, dry-type	
Gear Type	Spur gears	
Gear Lubrication	Lithium-based grease	
Standard Equipment	Rear handle with integral controls, anti-vibe mountings, front handle with guard, spark plug wrench and blade scabbard (cover)	
Engine Speed	3,000 RPM	
Clutch Engagement Speed	4,100 RPM	
Wide Open Throttle Speed (W.O.T.)	10,500 RPM	

Specifications are subject to change without notice.

### IMPORTANT!

This spark ignition system complies with the Canadian standard ICES-002.

## Emission Control (Exhaust & Evaporative)

### EPA 2010 and Later and/or C.A.R.B. TIER III

The emission control system for the engine is EM/TWC (Engine Modification and 3-way Catalyst) and for the fuel tank the Control System is EVAP (Evaporative Emissions) or N (for nylon tank). Evaporative emission may be applicable to California models only.

**EMISSION CONTROL INFORMATION**  
ENGINE FAMILY: [E]EHXS.0454KA DISPLACEMENT: 45.0cc  
EMISSION COMPLIANCE PERIOD = 300 HOURS  
THIS ENGINE MEETS U.S. EPA EXH/EVP REGS FOR MODEL YEAR [E][\*][\*][\*]  
REFER TO OWNER'S MANUAL FOR MAINTENANCE SPECIFICATIONS AND ADJUSTMENTS.  
**YAMABIKO CORP.** [E] [E] [E] [E]

**EMISSION CONTROL INFORMATION**  
ENGINE FAMILY: [E]EHXS.0214KG DISPLACEMENT: 21.2cc  
EMISSION COMPLIANCE PERIOD = 300 HOURS  
THIS ENGINE MEETS \*\*\*\* U.S. EPA EXH/EVP AND CALIFORNIA EXH AND EVP EMISSION REGULATIONS FOR S.O.R.E.  
REFER TO OWNER'S MANUAL FOR MAINTENANCE SPECIFICATIONS AND ADJUSTMENTS.  
**YAMABIKO CORP.** [E] [E] [E] [E]

**An Emission Control Label** is located on the unit. (This is an EXAMPLE ONLY; information on label varies by engine FAMILY).

#### PRODUCT EMISSION DURABILITY (EMISSION COMPLIANCE PERIOD)

The 300 hour emission compliance period is the time span selected by the manufacturer certifying the engine emissions output meets applicable emissions regulations, provided that approved maintenance procedures are followed as listed in the Maintenance Section of this manual.

## Unit Description

Familiarize yourself with your machine and its various components. Understanding your machine helps ensure top performance, long service life, and safer operation.

### Prior to use

Before using this product, please make sure you have all the components required for a complete unit:

- Unit assembly
- Kit with this manual and tool kit for routine maintenance.
- Cutter blade cover

Carefully inspect all components for damage.

### IMPORTANT!

The terms "left," "left-hand," and "LH"; "right," "right-hand," and "RH"; "front" and "rear" refer to directions as viewed by the operator during normal operation of this product.



### WARNING!

Do not make unauthorized modifications or alterations to this machine or any of its components or accessories.

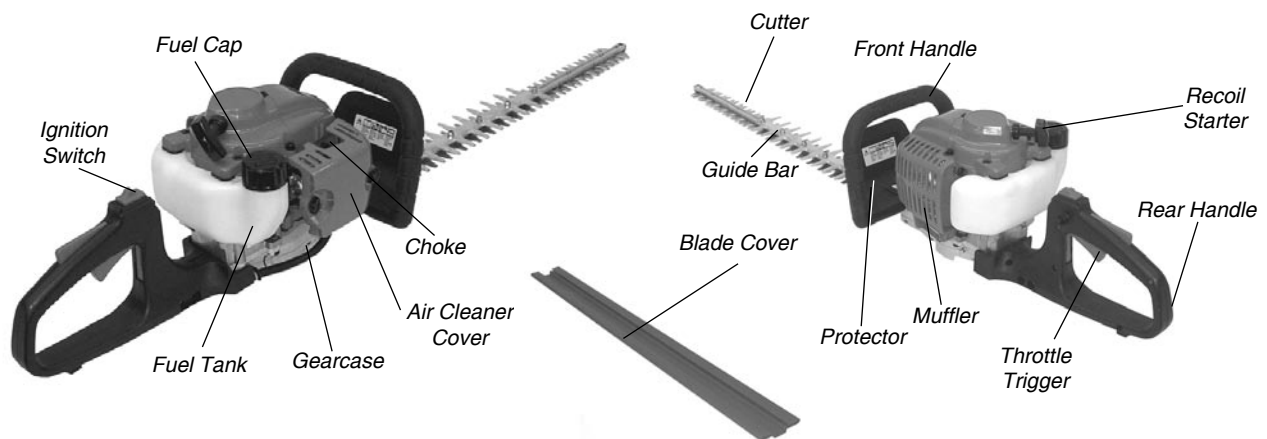

Figure 3

## Assembly

### NOTE:

For normal cutting, Shindaiwa strongly recommends the blade stiffener be installed. In extreme conditions, such as commercial cutting, or when cutting thick and/or dense branches, efficiency may be increased by trimming without the blade stiffener.

Tools required: 8 mm socket and extension, 4 mm hex wrench



### WARNING!

Hedge Clipper blades are very sharp. Touching them may lead to severe personal injury. Avoid touching blades whenever possible, and always wear gloves to protect hands.

## Blade Stiffener Removal

1. Move stop switch to stop position.
2. Disconnect spark plug wire.



### WARNING!

Hedge clipper blades are very sharp. Touching them may lead to severe personal injury. Use a socket and extension when removing locknuts in order to keep hands at a safe distance from sharp blades.

3. Remove seven (7) blade stiffener locknuts (A).
4. Remove blade stiffener.

### NOTE:

Assure blade bolts (B) are tightened securely.

5. Install first, second, third locknuts (C) closest to handle. Retain remaining 4 locknuts for future use.

### NOTE:

Use new locknuts every other time blade stiffener is installed or removed.

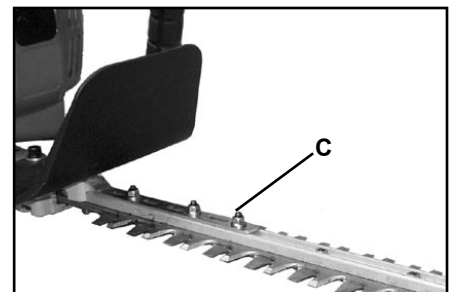
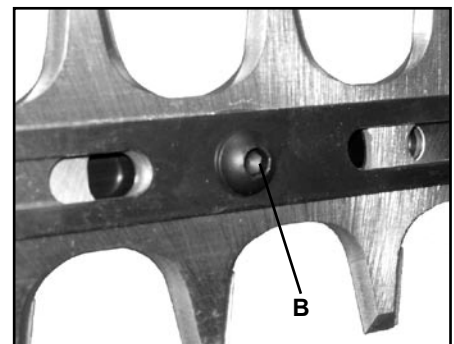
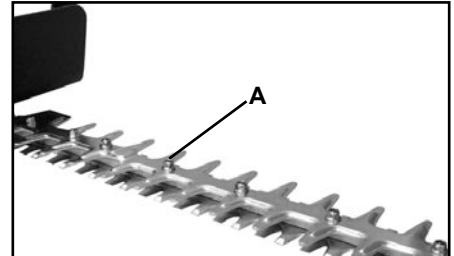
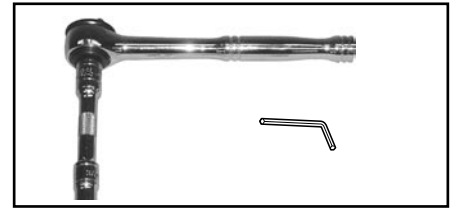

## Install Blade Stiffener

1. Move stop switch to stop position.
2. Disconnect spark plug wire.



### WARNING

Hedge clipper blades are very sharp. Touching them may lead to severe personal injury. Use a socket and extension when removing locknuts in order to keep hands at a safe distance from sharp blades.

3. Remove first three (3) locknuts (C) closest to handle.
4. Install blade stiffener.

#### NOTE:

Assure blade bolts (B) are tightened securely.

5. Secure blade stiffener with seven (7) locknuts (A).

#### IMPORTANT!

If blade stiffener is damaged or show signs of wear, replace it.

#### NOTE:

Use new locknuts every other time blade stiffener is installed or removed.

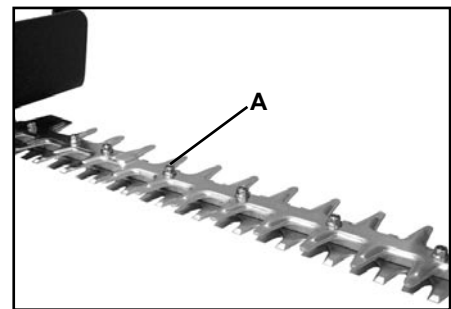
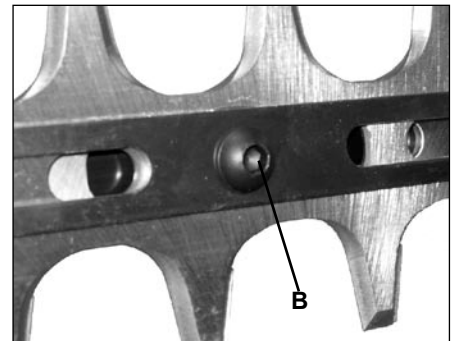
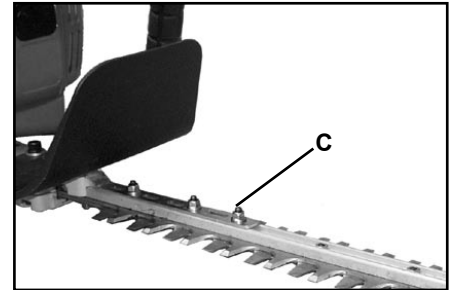

## Mixing Fuel



### WARNING!

Alternative fuels, such as E15 (15% ethanol), E-85 (85% ethanol) or any fuels not meeting Shindaiwa requirements are **NOT** approved for use in Shindaiwa gasoline engines. Use of alternative fuels may cause performance problems, loss of power, overheating, fuel vapor lock, and unintended machine operation, including, but not limited to, improper clutch engagement. Alternative fuels may also cause premature deterioration of fuel lines, gaskets, carburetors and other engine components.

### Fuel Requirements

**Gasoline** - Use 89 Octane [R+M/2] (mid grade or higher) gasoline known to be good quality. Gasoline may contain up to 10% Ethanol (grain alcohol) or 15% MTBE (methyl tertiary-butyl ether). Gasoline containing methanol (wood alcohol) is **NOT** approved.

**Hybrid 4™ Mixture Oil** - Engine oil meeting ISO-L-EGD (ISO/CD 13738) and J.A.S.O. M345/FD standards must be used. Shindaiwa highly recommends using Shindaiwa Red Armor™ engine oil in all Shindaiwa Hybrid 4™ engines to protect the engine from harmful carbon build up, maintain engine performance, and increase engine life. Shindaiwa Red Armor™ engine oil exceeds ISO-L-EGD and J.A.S.O. M345/FD performance requirements. Engine problems due to inadequate lubrication caused by failure to use an ISO-L-EGD (ISO/CD 13738) and J.A.S.O. M345/FD certified oil will void the engine warranty.

#### IMPORTANT!

Shindaiwa Red Armor™ engine oil may be mixed at 50:1 ratio for application in all Shindaiwa engines sold in the past, regardless of ratio specified in those manuals.



### IMPORTANT!

Stored fuel ages. Do not mix more fuel than you expect to use in thirty (30) days, ninety (90) days when a fuel stabilizer is added. Use of unmixed, improperly mixed, or stale fuel, may cause hard starting, poor performance, or severe engine damage and void the product warranty. Read and follow instructions in the Long Term Storage section of this manual.

### Examples of 50:1 mixing quantities

Fuel to Oil Mix - 50:1 Ratio			
U.S.		METRIC	
GAS	OIL	GAS	OIL
Gallons	Fl. oz.	Liter	cc.
1	2.6	4	80
2	5.2	8	160
5	13	20	400

## Handling Fuel



### DANGER

Fuel is VERY flammable. Use extreme care when mixing, storing or handling or serious personal injury may result.

- Use an approved fuel container.
- DO NOT smoke near fuel.
- DO NOT allow flames or sparks near fuel.
- Fuel tanks/cans may be under pressure. Always loosen fuel caps slowly allowing pressure to equalize.
- NEVER refuel a unit when the engine is HOT or RUNNING!
- DO NOT fill fuel tanks indoors. ALWAYS fill fuel tanks outdoors over bare ground.
- DO NOT overfill fuel tank. Wipe up spills immediately.
- Securely tighten fuel tank cap and close fuel container after refueling.
- Inspect for fuel leakage. If fuel leakage is found, do not start or operate unit until leakage is repaired.
- Move at least 3m (10 ft.) from refueling location before starting the engine.

### Mixing Instructions

1. Fill an approved fuel container with half of the required amount of
2. gasoline.
3. Add the proper amount of engine oil to gasoline.
4. Close container and shake to mix oil with gasoline.
5. Add remaining gasoline, close fuel container, and remix.

### IMPORTANT!

Spilled fuel is a leading cause of hydrocarbon emissions. Some states may require the use of automatic fuel shut-off containers to reduce fuel spillage.

### After use

- DO NOT store a unit with fuel in its tank. Leaks can occur. Return unused fuel to an approved fuel storage container.

## Filling the Fuel Tank



### WARNING!

#### Minimize the Risk of Fire

- NEVER smoke or light fires near the engine.
- ALWAYS stop the engine and allow it to cool before refueling.
- ALWAYS Wipe all spilled fuel and move at least 3 meters (10 feet) from the fueling point and source before starting.
- NEVER place flammable material close to the engine muffler.
- NEVER operate the engine without the muffler and spark arrester screen in place and in good working condition.

### FUEL IS HIGHLY FLAMMABLE.

- ALWAYS store gasoline in a container approved for flammable liquids.
- ALWAYS inspect the unit for fuel leaks before each use. During each refill, check that no fuel leaks from around the fuel cap and/or fuel tank. If fuel leaks are evident, stop using the unit immediately. Fuel leaks must be repaired before using the unit.
- ALWAYS move the unit at least 3 meters (10 feet) away from a fuel storage area or other readily flammable materials before starting the engine.

**Storage** - Fuel storage laws vary by locality. Contact your local government for the laws affecting your area. As a precaution, store fuel in an approved, airtight container. Store in a well-ventilated, unoccupied building, away from sparks and flames.

### IMPORTANT!

Stored fuel may separate. ALWAYS shake fuel container thoroughly before each use.

1. Place the unit on a flat, level surface.
2. Clear any dirt or other debris from around the fuel filler cap.

### CAUTION!

Slowly remove the fuel cap only after stopping the engine

3. Remove the fuel cap, and fill the tank with clean, fresh fuel.
4. Reinstall the fuel filler cap and tighten firmly.
5. Wipe away any spilled fuel before starting engine.

# Starting Procedure

## IMPORTANT!

Engine ignition is controlled by a two-position on-off switch mounted on the throttle body. This switch is typically labeled “I” for ON and “O” for OFF.



### WARNING!

The attachment will operate immediately when the engine starts, and could result in possible serious injury. Keep movable parts of the attachment away from objects that could become entangled or thrown, and surfaces that could cause loss of control.



### WARNING!

Never start the engine from the operating position.

### NOTE:

The blade cover is used for transportation and storage. Remove blade cover before using the unit.

1. Slide the ignition switch to the “I” (ON) position. See Figure 4.
2. Set the throttle trigger to the “fast idle”:
  - a. Depress and hold the throttle lock, then squeeze the throttle trigger.
  - b. Depress and hold the fast idle button.
  - c. Release the throttle trigger and throttle lock, then release fast idle button.
3. Prime the carburetor by repeatedly depressing the carburetor primer bulb until clear fuel can be seen flowing through the transparent primer bulb.

## IMPORTANT!

The primer system only pushes fuel through the carburetor. Repeatedly pressing the primer bulb will not flood the engine with fuel.

### 4. (Cold engine only)

Choke the engine by moving the choke lever *forward* to the closed” position. See Figure 7.

## Cranking the Engine

1. Place the unit on the ground. Grip the engine cover with your left hand and the starter handle with your right hand (shown).
2. Pull the starter handle slowly toward you until you feel the starter mechanism engage.
3. Start the trimmer by pulling the starting handle rapidly outward.

### CAUTION!

**The recoil starter can be easily damaged by abuse!**

- Always engage the starter before attempting to crank the engine.
- Never pull the starter cord to its full length.
- Always rewind the starter cord slowly.

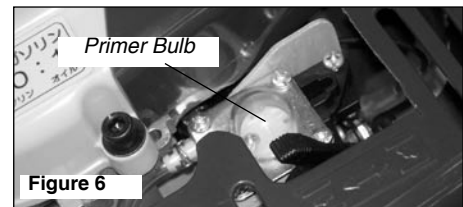
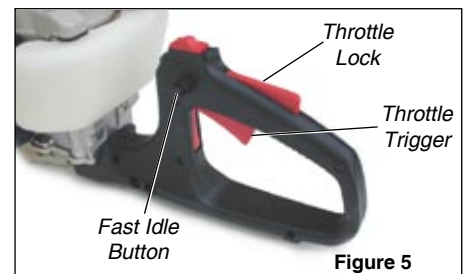
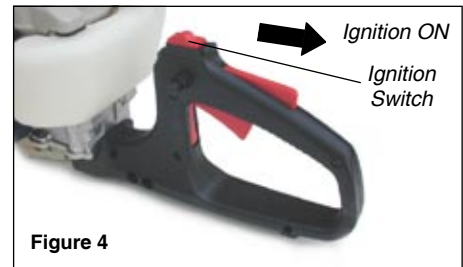

### When the motor starts...

1. Open the choke by moving the choke lever backward (toward the fuel tank).
2. If the engine does not continue to run, repeat the appropriate cranking procedures for a cold or warm engine. When the engine starts, clear excess fuel from the combustion chamber by accelerating the engine several times with the throttle lever.
3. Operating the throttle will automatically disengage the fast idle setting.



#### **WARNING!**

The cutting attachment will move when the engine accelerates!

### If the Engine Does Not Start

- Repeat the appropriate starting procedure for a cold or warm engine.
- If the engine still fails to start, use the procedures for “Starting a flooded engine.”

### Operation

- Squeezing the throttle increases engine speed, causing the clutch to engage and operate the cutters.
- Releasing the throttle decreases engine speed, causing the cutters to slow, and then stop altogether as the clutch disengages.
- Use a sweeping motion when cutting, and vary throttle settings often.
- Avoid cutting material larger than 1.3 cm in diameter.

### Starting a Flooded Engine



#### **WARNING!**

Burn danger from hot engine!

### Starting A Flooded Engine

1. Slide the ignition switch to the “I” (ON) position.
2. Open the choke, put the throttle lever in the full throttle position, then clear excess fuel from the combustion chamber by cranking the engine several times.
3. If the engine still fails to start or fire, refer to the troubleshooting flow chart at the end of this manual.

### Stopping the Engine

1. Cool the engine by allowing it to idle for 2–3 minutes.
2. Move the ignition switch to the “O” or STOP position. See Figure 11.



Figure 11

## Maintenance and Adjustments

### IMPORTANT!

Maintenance, replacement or repair of emission control devices and systems may be performed by any repair establishment or individual; however, warranty repairs must be performed by a dealer or service center authorized by ECHO, Inc. . The use of parts that are not equivalent in performance and durability to authorized parts may impair the effectiveness of the emission control system and may have a bearing on the outcome of a warranty claim.

#### NOTE:

Using non-standard replacement parts could invalidate your Shindaiwa warranty.

### Air Filter

The H4 engine that powers your Shindaiwa model is a hybrid 4-stroke engine. As a hybrid, the engine is lubricated by oil mixed with the gasoline and air from the carburetor that moves through and around the internal parts of the engine in a similar way that a 2-stroke engine is lubricated. Without the heavy duty 2-stage air filter equipped on all H4 engines, dust and dirt could also move through the engine, decreasing engine life, increasing valve wear and the need for more frequent valve adjustments. To keep your H4 engine strong and reliable, Shindaiwa recommends that you check and service the air filter as instructed in the 10-Hour Maintenance section that follows.

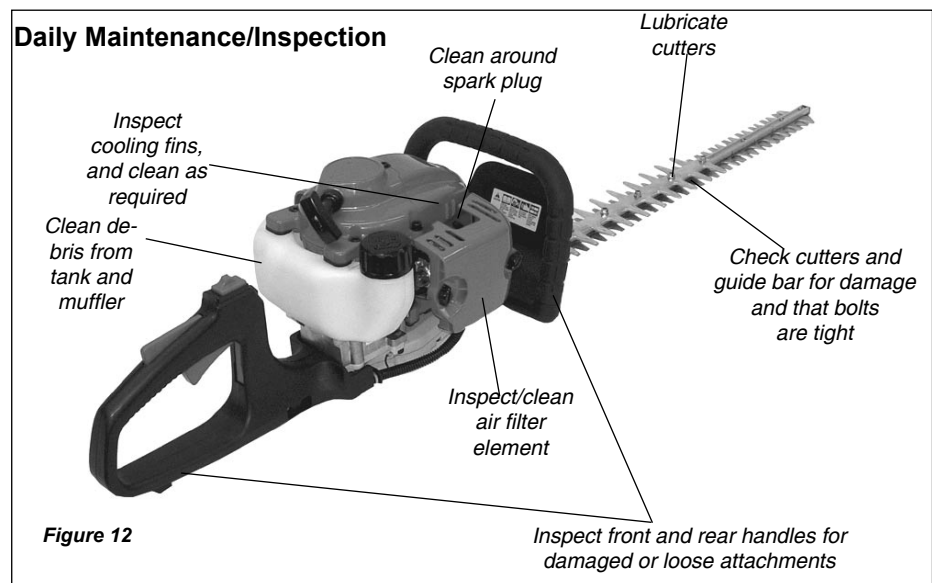
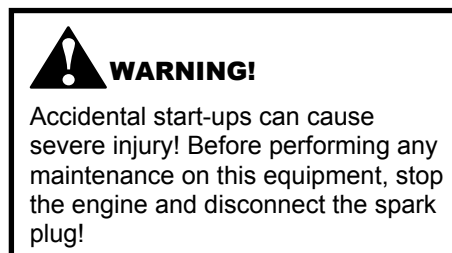

1. Remove all grass clippings and dirt from the hedge trimmer.
  - Remove any compacted debris from around the fuel tank and/or muffler.
  - Inspect the engine cooling fins for clogging, and clean as necessary.
  - Clean under the cylinder cover and around the spark plug. Inspect the air filter element for clogging, clean as necessary.
2. Check for loose, damaged, or missing components, and repair as necessary.
3. Lubricate the cutters with oil before use, and after refueling.
4. Check the cutters for damage and make sure all bolts are tight.

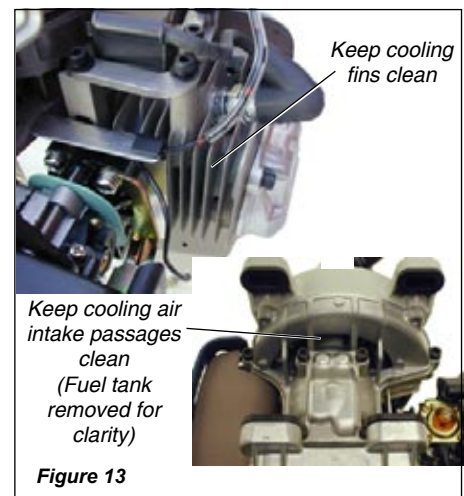
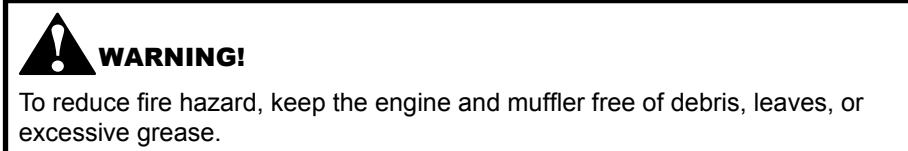

## Throttle Cable Free Play

If the unit does not return to idle speed or doesn't reach full rpm, the throttle trigger free play may need to be adjusted as follows:

1. Measure free play at the end of the throttle trigger. Throttle trigger free play should be approximately 5-7 mm (0.2-0.275"). See Figure 14.
2. If adjustment is necessary, remove the air cleaner cover by loosening the two thumbscrews. Turn the cable adjustment fitting in or out until throttle trigger free play is approximately 5-7 mm (0.2-0.275").
3. Replace the air cleaner cover, and tighten the cover retaining screws securely.

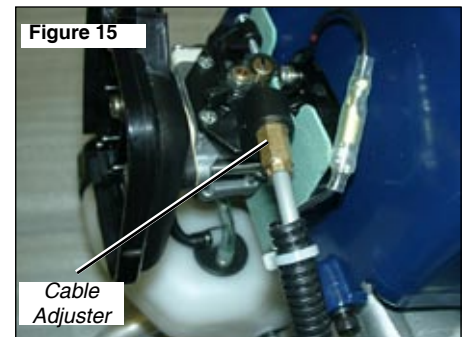

## 10-Hour Maintenance

(more frequently in dusty conditions)

1. Remove the air cleaner cover by loosening the two thumbscrews. See Figure 16A.
2. Remove and inspect the pre-filter. If the pre-filter is torn or otherwise damaged, replace it with a new one. See Figure 16B.
3. Clean the pre-filter with soap and water. Let dry before reinstalling.
4. Inspect the air cleaner element. If the element is damaged or distorted, replace it with a new one.
5. Tap filter gently on a hard surface to dislodge debris from element or use compressed air from the inside to blow debris out and away from the air filter element.



### IMPORTANT!

Direct the air stream at the inside face of the filter only!

6. Install the filter element, pre-filter and cover in the reverse order of removal.

### CAUTION!

Never operate the unit if the air cleaner assembly is damaged or missing!





## 10/15-Hour Maintenance

Every 10 to 15 hours of operation:

- Remove and clean the spark plug. Adjust the spark plug electrode gap to 0.6 mm (0.024 in). If the spark plug must be replaced, use only an NGK CMR5H or equivalent resistor type spark plug of the correct heat range. See Figure 17.

### NOTE:

The NGK CMR5H also meets the requirements for electro magnetic compliance (EMC).

### CAUTION!

Before removing the spark plug, clean the area around the plug to prevent dirt and debris from getting into the engine's internal parts.

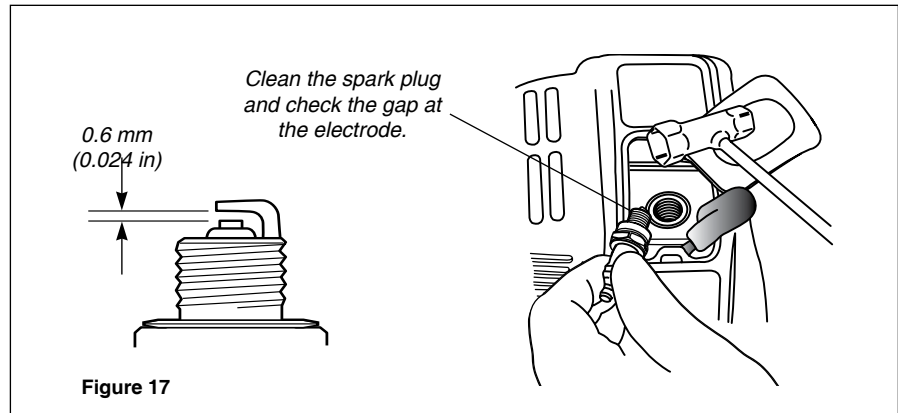

Figure 17

## 50-Hour Maintenance

Every 50 hours of operation  
(more often in dusty or extreme conditions)

- Remove and clean the cylinder cover and clean grass and dirt from the cylinder fins.

### CAUTION!

Make sure you do not pierce the fuel line with the end of the hooked wire. The line is delicate and can be damaged easily.

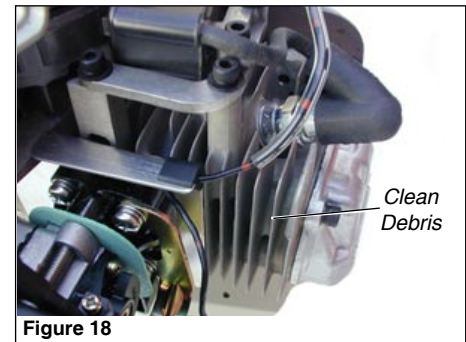

Figure 18

- Use a wire hook to extract the fuel filter from inside the fuel tank. (Figure 19). Inspect the fuel filter element. If it shows signs of contamination from debris, replace it with a genuine Shindaiwa replacement fuel filter element. Before reinstalling the filter, inspect the fuel line. If you discover damage or deterioration, the unit should be removed from service until it can be inspected by a Shindaiwa-trained service technician.

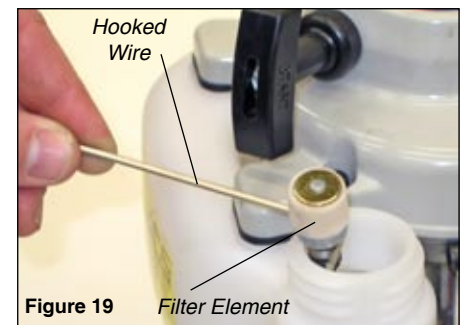

Figure 19

## Gearcase Lubrication

### Every 20 Hours



Figure 20 Gearcase Grease Fitting  
VIEWED FROM THE BOTTOM

Top off gearcase grease level by using a lever-type grease gun to force 1–2 strokes of high quality lithium-based grease through the gearcase grease fitting.

### Every 100 Hours (or before long-term storage)

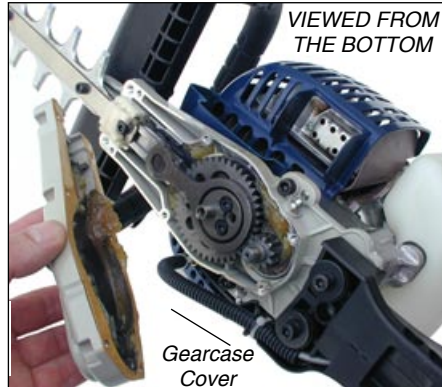

Figure 21

Remove the gearcase cover, and use solvent and a soft brush to remove all old grease from the gearcase. To refill, hand-pack the gearcase with approximately 40–50 grams of high quality lithium-based grease (50–70% of capacity). **DO NOT OVERFILL!**

#### CAUTION!

- Over-lubricating may cause the gearcase to run slower than normal and may also cause leakage from excess grease.

## Blades

Standard blades require no periodic adjustments. Make sure all blade shoulder bolts are tight and in good condition.

- Clean blades and apply a light coating of oil to all metal surfaces. Vegetable oils may be used to protect sensitive plants from spotting.

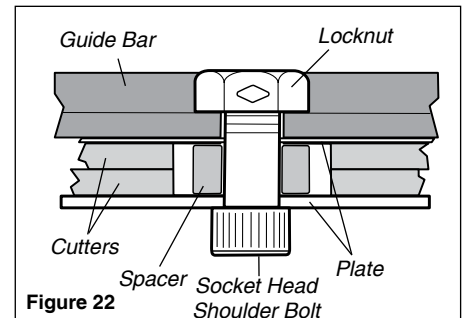

Figure 22

## 135-Hour or Annual Maintenance

- Combustion chamber should be decarbonized, and the valve clearance should be adjusted. It is highly recommended that this is done by a Shindaiwa-trained service technician.
- Replace the spark plug annually: Use only NGK CMR5H or equivalent resistor type spark plug of the correct heat range. Set spark plug electrode gap to 0.6 mm.

#### NOTE:

The NGK CMR5H also meets the requirements for electro magnetic compliance (EMC).

#### CAUTION!

- Performing a valve adjustment incorrectly may cause hard starting and/or can damage the unit. Refer to the Service Manual for complete valve adjustment procedure and torque specifications.
- If you are unfamiliar with this engine or uncomfortable with this procedure, Consult with an authorized Shindaiwa servicing dealer.

## Valve Adjustment

1. Remove cylinder cover, rocker arm cover, and set piston at TDC-compression.
2. Loosen adjuster locknut so that the 2.5 mm Allen socket head adjustment screw can turn freely.
3. Insert feeler gauge .004 (0.10 mm) for both intake and exhaust; between valve stem tip and rocker arm.
4. Turn adjustment screw (clockwise = tighter, counter-clockwise = looser) until feeler gauge is almost snug. Back off just enough to allow gauge to slip out with limited resistance.
5. While holding adjustment screw in place with Allen driver, tighten locknut with wrench.
6. Turn engine over several times, and return to TDC-compression. Recheck with proper feeler gauge to make sure clearance adjustment did not change as a result of tightening locknut. Readjust as necessary.
7. Replace rocker arm cover gasket to assure proper sealing and install cover.

### **IMPORTANT!**

If new gasket is not available and/or old gasket is not damaged, old gasket may be reused. Never use cracked or damaged gaskets!

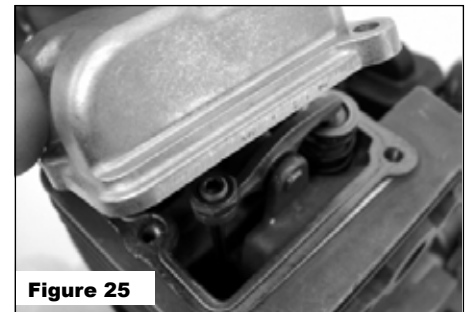
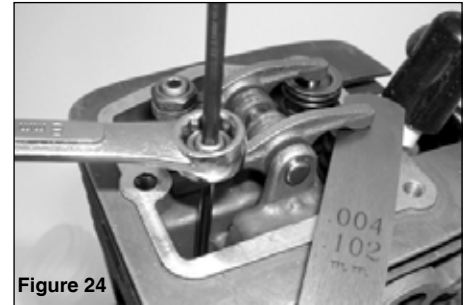
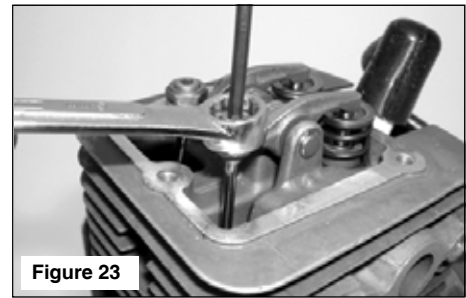



## Spark Arrester Screen Maintenance

If the engine becomes sluggish and low on power, check and clean the spark arrester screen.



### WARNING!

Never operate the unit with a damaged or missing muffler or spark arrester! Operating with a missing or damaged spark arrester is a fire hazard and could also damage your hearing.

1. With a 4 mm hex wrench remove the 3 engine cover screws and the engine cover. See Figure 26.
2. With a 4 mm hex wrench remove the 3 muffler bolts and the muffler. See Figure 26.
3. With a small flat bladed screwdriver remove the 2 screws holding the spark arrester screen and cover to the muffler. See Figure 26.
4. Remove the screen and clean it with a stiff bristle brush.
5. Inspect the cylinder exhaust port for any carbon buildup.

### IMPORTANT!

If you note excessive carbon buildup, consult with an authorized Shindaiwa servicing dealer.

6. Reassemble the spark arrester, muffler and engine cover in the reverse order of disassembly.

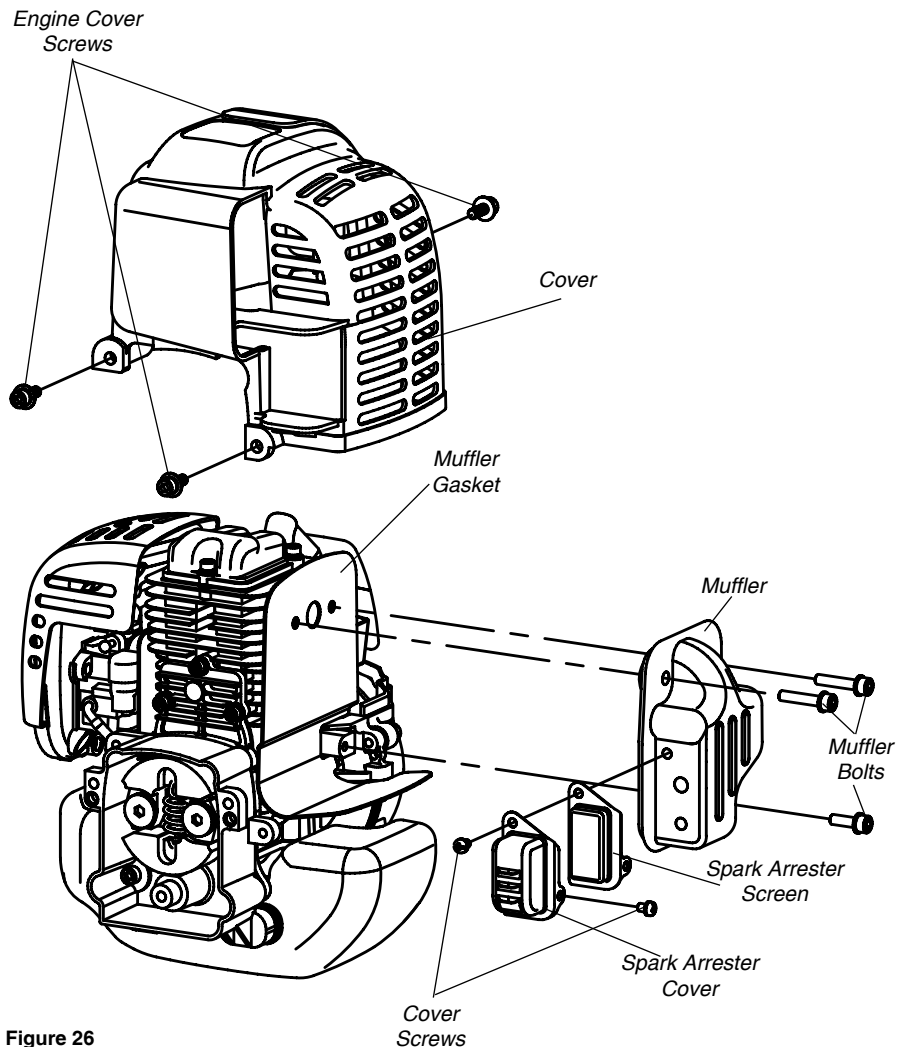

Figure 26

## Carburetor Adjustment

### Engine Break-In

New engines must be operated a minimum duration of two tanks of fuel break-in before carburetor adjustments can be made. During the break-in period your engine performance will increase and exhaust emissions will stabilize. Idle speed can be adjusted as required.

### High Altitude Operation

This engine has been factory adjusted to maintain satisfactory starting, emission, and durability performance up to 1,100 feet above sea level (ASL) (96.0 kPa). To maintain proper engine operation and emission compliance above 1,100 feet ASL the carburetor may need to be adjusted by an authorized Shindaiwa service dealer.

### IMPORTANT!

If the engine is adjusted for operation *above* 1,100 feet ASL, the carburetor must be re-adjusted when operating the engine *below* 1,100 feet ASL, otherwise severe engine damage may result.

### NOTE:

Every unit is run at the factory and the carburetor is set in compliance with emission regulations. Carburetor adjustments, other than idle speed, must be performed by an authorized Shindaiwa dealer.

The engine **must** return to idle speed whenever the throttle lever is released. Idle speed is adjustable, and **must** be set low enough to permit the engine clutch to disengage the cutters.

### Idle Speed Adjustment

1. Start the engine, and then allow it to idle 2–3 minutes until warm.
2. If the cutters move when the engine is at idle, reduce idle speed by turning the idle adjustment screw counterclockwise.
3. If a tachometer is available, adjust idle. Check Specifications page for correct idle speed.
4. Carburetor fuel mixture adjustments are preset at the factory and cannot be adjusted or serviced in the field.

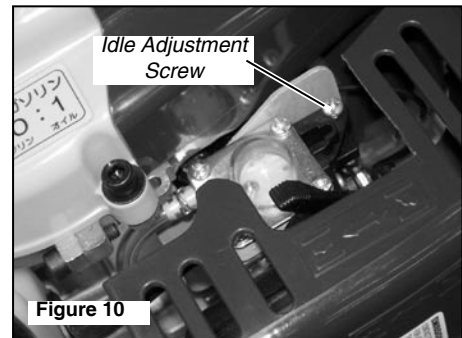

Figure 10



### WARNING!

The cutters must NEVER engage at engine idle speeds! If the idle speed cannot be adjusted by the above procedure, return the trimmer to your Shindaiwa dealer for inspection.

## Long Term Storage

Whenever the unit will not be used for 30 days or longer, use the following procedures to prepare it for storage:

- Clean external parts thoroughly and apply a light coating of oil to all metal surfaces.
- Drain all the fuel from the carburetor and the fuel tank.

To do so:

1. Prime the primer bulb until no more fuel is passing through.
2. Start and run the engine until it stops running.
3. Repeat steps 1 and 2 until the engine will no longer start.

### CAUTION!

Gasoline stored in the carburetor for extended periods can cause hard starting, and could also lead to increased service and maintenance costs.

### IMPORTANT!

All stored fuels should be stabilized with a fuel stabilizer such as STA-BIL™.

### NOTE:

Damage resulting from stale or contaminated fuel is not covered by the Shindaiwa warranty policy.

- Remove the spark plug and pour about 1/4 oz. of engine oil into the cylinder through the spark plug hole. Slowly pull the recoil starter 2 or 3 times so oil will evenly coat the interior of the engine. Reinstall the spark plug.
- Before storing the unit, repair or replace any worn or damaged parts.
- Remove the air cleaner element from the carburetor and clean it thoroughly with soap and water. Let dry and reassemble the element.
- Store the unit in a clean, dust-free area.

# Troubleshooting Guide

## ENGINE DOES NOT START OR HARD TO START

What To Check	Possible Cause	Remedy
Vaporlock.	Engine hot/heat soaked. Low fuel quality.	Let cool completely and restart. Refill with fresh, clean unleaded gasoline with a pump octane of 89 or higher mixed with an air cooled engine oil that meets or exceeds ISO-L-EGD and/or JASO FD classified oils at 50:1 gasoline/oil ratio.
Valve adjustment.	Valve clearance too tight. Valve clearance too loose.	Consult with an authorized Shindaiwa servicing dealer. Adjust valves.

## ENGINE DOES NOT START

What To Check	Possible Cause	Remedy
Does the engine crank? NO	Faulty recoil starter. Fluid in the crankcase. Internal damage.	Consult with an authorized Shindaiwa servicing dealer.
YES		
Good compression? NO	Loose spark plug. Excess wear on cylinder, piston, rings.	Tighten and re-test. Consult with an authorized Shindaiwa servicing dealer.
YES		
Does the tank contain fresh fuel of the proper grade? NO	Fuel incorrect, stale, or contaminated; mixture incorrect.	Refill with fresh, clean unleaded gasoline with a pump octane of 89 or higher mixed with an air cooled engine oil that meets or exceeds ISO-L-EGD and/or JASO FD classified oils at 50:1 gasoline/oil ratio.
YES		
Is fuel visible and moving in the return line when priming? NO	Check for clogged fuel filter and/or vent. Priming pump not functioning properly.	Replace fuel filter or vent as required. Re-start. Consult with an authorized Shindaiwa servicing dealer.
YES		
Is there spark at the spark plug wire terminal? NO	The ignition switch is in "O" (OFF) position. Shorted ignition ground. Faulty ignition unit.	Move switch to "I" (ON) position and re-start. Consult with an authorized Shindaiwa servicing dealer.
YES		
Check the spark plug.	If the plug is wet, excess fuel may be in the cylinder. The plug is fouled or improperly gapped. The plug is damaged internally or of the wrong size.	See "Starting a Flooded Engine" Clean and gap the spark plug. Check the Specifications section for the correct plug and gap for your unit. Restart. Replace the spark plug. Check the Specifications section for the correct plug and gap for your unit. Restart.

# Troubleshooting Guide (continued)

## LOW POWER OUTPUT

What To Check	Possible Cause	Remedy
<p>Is the engine overheating?</p>	Operator is overworking the unit.	Use a lower throttle setting.
	Carburetor mixture is too lean.	Consult with an authorized Shindaiwa servicing dealer.
	Improper fuel ratio.	Refill with fresh, clean unleaded gasoline with a pump octane of 89 or higher mixed with an air cooled engine oil that meets or exceeds ISO-L-EGD and/or JASO FD classified oils at 50:1 gasoline/oil ratio.
	Fan, fan cover, cylinder fins dirty or damaged.	Clean, repair or replace as necessary.
	Carbon deposits on the piston or in the muffler.	Consult with an authorized Shindaiwa servicing dealer.
<p>Engine is rough at all speeds. May also have black smoke and/or unburned fuel at the exhaust.</p>	Clogged air cleaner element.	Service the air cleaner element.
	Loose or damaged spark plug.	Tighten or replace the spark plug. Check the <i>Specifications</i> section for the correct plug and gap for your unit.
	Air leakage or clogged fuel line.	Repair or replace fuel filter and/or fuel line.
	Water in the fuel.	Refill with fresh, clean unleaded gasoline with a pump octane of 89 or higher mixed with an air cooled engine oil that meets or exceeds ISO-L-EGD and/or JASO FD classified oils at 50:1 gasoline/oil ratio.
	Piston seizure.	Consult with an authorized Shindaiwa servicing dealer.
	Faulty carburetor and/or diaphragm.	
<p>Engine is knocking.</p>	Overheating condition.	Consult with an authorized Shindaiwa servicing dealer.
	Improper fuel.	Refill with fresh, clean unleaded gasoline with a pump octane of 89 or higher mixed with an air cooled engine oil that meets or exceeds ISO-L-EGD and/or JASO FD classified oils at 50:1 gasoline/oil ratio.
	Carbon deposits in the combustion chamber.	Consult with an authorized Shindaiwa servicing dealer.

## Troubleshooting Guide (continued)

### ADDITIONAL PROBLEMS

Symptom	Possible Cause	Remedy
Poor acceleration.	<ul style="list-style-type: none"> <li>Clogged air filter.</li> <li>Clogged fuel filter.</li> <li>Lean fuel/air mixture.</li> <li>Idle speed set too low.</li> </ul>	<ul style="list-style-type: none"> <li>Clean the air filter.</li> <li>Replace the fuel filter.</li> <li>Consult with an authorized Shindaiwa servicing dealer.</li> <li>Adjust idle. Check <i>Specifications</i> page for correct idle speed.</li> </ul>
Engine stops abruptly.	<ul style="list-style-type: none"> <li>Ignition switch turned off.</li> <li>Fuel tank empty.</li> <li>Water in the fuel.</li> <li>Clogged fuel filter.</li> <li>Shorted spark plug or loose terminal.</li> <li>Ignition failure.</li> <li>Piston seizure.</li> </ul>	<ul style="list-style-type: none"> <li>Reset the switch and re-start.</li> <li>Refill with fresh, clean unleaded gasoline with a pump octane of 89 or higher mixed with an air cooled engine oil that meets or exceeds ISO-L-EGD and/or JASO FD classified oils at 50:1 gasoline/oil ratio.</li> <li>Replace fuel filter.</li> <li>Clean or replace spark plug. Check the <i>Specifications</i> section for the correct plug and gap for your unit. Tighten the terminal.</li> <li>Replace the ignition unit.</li> <li>Consult with an authorized Shindaiwa servicing dealer.</li> </ul>
Engine difficult to shut off.	<ul style="list-style-type: none"> <li>Ground (stop) wire is disconnected, or switch is defective.</li> <li>Overheating due to incorrect spark plug.</li> <li>Overheated engine.</li> </ul>	<ul style="list-style-type: none"> <li>Test and replace as required.</li> <li>Replace the spark plug. Check the <i>Specifications</i> section for the correct plug and gap for your unit. Restart.</li> <li>Idle engine until cool.</li> </ul>
Top of engine is getting dirty and oily.	<ul style="list-style-type: none"> <li>Valve cover is leaking.</li> </ul>	<ul style="list-style-type: none"> <li>Consult with an authorized Shindaiwa servicing dealer.</li> </ul>
Engine will not idle down.	<ul style="list-style-type: none"> <li>Idle set too high.</li> <li>Engine has an air leak.</li> </ul>	<ul style="list-style-type: none"> <li>Adjust idle. Check <i>Specifications</i> page for correct idle speed.</li> <li>Consult with an authorized Shindaiwa servicing dealer.</li> </ul>
Cutting attachment moves at engine idle.	<ul style="list-style-type: none"> <li>Engine idle too high.</li> <li>Broken clutch spring or worn clutch spring boss.</li> </ul>	<ul style="list-style-type: none"> <li>Adjust idle. Check <i>Specifications</i> page for correct idle speed.</li> <li>Replace spring/shoes as required, check idle speed.</li> </ul>
Excessive vibration.	<ul style="list-style-type: none"> <li>Loose attachment holder.</li> <li>Warped or damaged attachment.</li> <li>Loose gearcase.</li> <li>Bent main shaft/worn or damaged bushings.</li> </ul>	<ul style="list-style-type: none"> <li>Inspect and re-tighten holders securely.</li> <li>Inspect and replace attachment as required.</li> <li>Tighten gearcase securely.</li> <li>Inspect and replace as necessary.</li> </ul>
Cutting attachment will not move.	<ul style="list-style-type: none"> <li>Shaft not installed in powerhead or gearcase.</li> <li>Broken shaft.</li> <li>Damaged gearcase.</li> </ul>	<ul style="list-style-type: none"> <li>Inspect and reinstall as required.</li> <li>Consult with an authorized Shindaiwa servicing dealer.</li> </ul>

**SHINDAIWA LIMITED WARRANTY STATEMENT FOR  
PRODUCT SOLD IN USA AND CANADA BEGINNING 01/01/2010**

**ECHO, INC'S RESPONSIBILITY**

ECHO Incorporated's (ECHO, INC.) Limited Warranty, provides to the original purchaser that this Shindaiwa product is free from defects in material and workmanship. Under normal use and maintenance from date of purchase, ECHO, INC. agrees to repair or replace at its discretion, any defective product free of charge at any authorized Shindaiwa servicing dealer within listed below application time periods, limitations and exclusions. **THIS LIMITED WARRANTY IS ONLY APPLICABLE TO SHINDAIWA PRODUCTS SOLD BY AUTHORIZED SHINDAIWA DEALERS. IT IS EXTENDED TO THE ORIGINAL PURCHASER ONLY, AND IS NOT TRANSFERABLE TO SUBSEQUENT OWNERS EXCEPT FOR EMISSION RELATED PARTS.** Repair parts and accessories replaced under this warranty are warranted only for the balance of the original unit or accessory warranty period. Any damage caused by improper installation or improper maintenance is not covered by this warranty. All parts or products replaced under warranty become the property of ECHO, INC. This warranty is separate from the Emission control warranty statement supplied with your new product. Please consult the Emission Control Warranty Statement for details regarding emission related parts. For a list of Authorized Shindaiwa Dealers refer to [WWW.SHINDAIWA.COM](http://WWW.SHINDAIWA.COM) or call **1-877-986-7783**.

**OWNER'S RESPONSIBILITY**

To ensure trouble free warranty coverage it is important that you register your Shindaiwa equipment on-line at [WWW.SHINDAIWA.COM](http://WWW.SHINDAIWA.COM) or by filling out the warranty registration card supplied with your unit. Registering your product confirms your warranty coverage and provides a direct link if we find it necessary to contact you.

The owner shall demonstrate reasonable care and use, and follow preventative maintenance, storage, fuel and oil usage as prescribed in the operator's manual. Should a product difficulty occur, you must, at your expense, deliver or ship your Shindaiwa unit to an authorized Shindaiwa servicing dealer for warranty repairs (within the applicable warranty period), and arrange for pick-up or return of your unit after the repairs have been made. For your nearest authorized Shindaiwa servicing dealer, call Shindaiwa's Dealer Referral Center, at 1-877-986-7783 or you can locate a Shindaiwa servicing dealer at [WWW.SHINDAIWA.COM](http://WWW.SHINDAIWA.COM). Should you require assistance or have questions concerning Shindaiwa's Warranty Statement, you can contact our Consumer Product Support Department at 1-800-673-1558 or contact us through the web at [WWW.SHINDAIWA.COM](http://WWW.SHINDAIWA.COM).

**PRODUCT WARRANTY PERIOD**

**RESIDENTIAL APPLICATION**

- **2 YEAR WARRANTY** - Units for residential, or non-income producing use will be covered by this limited warranty for **two (2) years** from date of purchase.

**EXCEPTIONS:**

- For engine powered products, the electronic ignition module, flexible drive cable, and solid drive shaft are warranted for the **life\*** of the product on parts only.
- Cutting attachments such as, but not limited to, bars, chains, sprockets, tines, blades, Power Broom™, belts, and nylon trimmer heads for residential or non-income producing use will be covered for failures due to defects in material or workmanship for a period of **60 days** from original product purchase date. Any misuse from contact with concrete, rocks, or other structures is not covered by this warranty.
- Multipurpose Tool Attachments carry the same warranty duration as the units they are designed to fit.

**COMMERCIAL APPLICATION**

- **90 DAY WARRANTY** - All Chain Saws and Cut-Off Saws for commercial, institutional, agricultural, industrial, or income producing use will be covered by this limited warranty for **90 Days** from the date of purchase.
- **2 YEAR WARRANTY** - Units for commercial, institutional, agricultural, industrial, or income producing use will be covered by this limited warranty for **two (2) years** from the date of purchase.

**EXCEPTIONS:**

- For engine powered products, the electronic ignition module, flexible drive cables, and solid drive shafts are warranted for the **life\*** of the product on parts only.
- Cutting attachments such as, but not limited to, bars, chains, sprockets, tines, blades, Power Broom™, belts, and nylon trimmer heads for commercial, institutional, agricultural, industrial, rental, or income producing will be covered for failures due to defects in material or workmanship for a period of **30 days** from original product purchase date. Any misuse from contact with concrete, rocks, or other structures is not covered by this warranty.
- Multipurpose Tool Attachments carry the same warranty duration as the units they are designed to fit.

**RENTAL APPLICATION - 90 DAYS WARRANTY**

- Units for rental use will be covered against defects in material and workmanship for a period of 90 days from the date of purchase.

\* ECHO INC's liability under the "Lifetime" coverage is limited to furnishing parts specified under the PRODUCT WARRANTY PERIOD section of this warranty statement for "**Life**" free of charge for a period of ten (10) years after the date of the complete unit's final production.

## **PURCHASED REPAIR PARTS AND ACCESSORIES**

- 90-day all applications

## **ATTENTION ENGINE POWERED PRODUCT OWNERS**

This Shindaiwa engine powered product is a quality-engineered unit which has been manufactured to exact tolerances to provide superior performance. To help ensure the performance of the unit, it is required to use engine oil which meets the ISO-L-EGD Standard per ISO/CD 13738 and JASO M345/FD Standards. Shindaiwa Red Armor™ and Shindaiwa One™ are a premium engine oil specifically formulated to meet ISO-L-EGD (ISO/CD 13738) and JASO M345/FD Standards. The use of engine oils designed for other applications, such as for outboard motors or lawnmowers can result in severe engine damage, and will void your engine limited warranty.

### **THIS WARRANTY DOES NOT COVER DAMAGE CAUSED BY:**

- Lack of lubrication or engine failure, due to the use of engine oils that do not meet the ISO-L-EGD (ISO/CD 13738) and JASO M345/FD Standards. Shindaiwa Red Armor™ and Shindaiwa One™ Engine Oil meets the ISO-L-EGD and JASO M345/FD Standard. Emission related parts are covered for 2 years regardless of engine oil used, per the statement listed in the EPA or California Emission Control Warranty Explanation.
- Damage caused by use of gasohol, containing methanol (wood alcohol), or gasoline containing less than 89 octane. Only use gasoline which contains 89 octane or higher. Gasohol which contains a maximum 10% ethanol (grain alcohol) or 15% MTBE (methyl/tertiary/butyl/ether) is also approved. The prescribed mixing ratio of gasoline to oil is listed on the Shindaiwa oil label and covered in your operator's manual.
- Engine damage caused by use of ether or any starting fluids.
- Damage caused by tampering with engine speed governor or emission components, or running engines above specified and recommended engine speeds as listed in your operator's manual.
- Operation of the unit with improperly maintained/removed cutting shield or removed/damaged air filter.
- Damage caused by dirt, pressure or steam cleaning the unit, salt water, corrosion, rust, varnish, abrasives, and moisture.
- Defects, malfunctions or failures resulting from abuse, misuse, neglect, modifications, alterations, normal wear, improper servicing, or use of unauthorized attachments.
- Incorrect storage procedures, stale fuel, including failure to provide or perform required maintenance services as prescribed in the operator's manual. Preventative maintenance as outlined in the operator's manual is the customer's responsibility.
- Failures due to improper set-up, pre-delivery service or repair service by anyone other than authorized Shindaiwa servicing dealer during the warranty period.
- Certain parts and other items are not warranted, including but not limited to: lubricants, starter cords, and engine tune-ups.
- Use of spark plugs other than those meeting performance and durability requirements of the OEM spark plug listed in the Operator's Manuals.
- Overheating or carbon scoring failures due to restricted, clogged exhaust port or combustion chamber, including damage to spark arrester screen.
- Adjustments after the first (30) thirty days and beyond, such as carburetor adjustment and throttle cable adjustment.
- Damage to gears or gear cases caused by contaminated grease or oil, use of incorrect type or viscosity of lubricants, and/or failure to comply with recommended grease or oil change intervals.
- Damage caused by pump or sprayer running dry, pumping or spraying caustic or flammable materials, or lack of or broken strainers.
- Additional damage to parts or components due to continued use after operational problem or failure occurs. Should operational problem or failure occur, the product should not be used, but delivered as is to an authorized Shindaiwa servicing dealer.

It is a dealer's and/or customer's responsibility to complete and return the warranty registration card supplied with your Shindaiwa product or by visiting [WWW.SHINDAIWA.COM](http://WWW.SHINDAIWA.COM). Your receipt of purchase including date, model and serial number must be maintained and presented to an authorized Shindaiwa servicing dealer for warranty service. Proof of purchase rests solely with the customer. Some states do not allow limitations on how long an implied warranty lasts, so the above limitations may not apply to you. Some states do not allow the exclusion or limitation of incidental or consequential damages, so you may also have other specific legal rights which vary from state to state. This limited warranty is given by ECHO Incorporated, 400 Oakwood Rd., Lake Zurich, IL 60047.

### **DISCLAIMER OF IMPLIED WARRANTIES**

This limited warranty is in lieu of all other expressed or implied warranties, including any warranty of FITNESS FOR A PARTICULAR PURPOSE OR USE and any implied warranty of **MERCHANTABILITY** otherwise applicable to this product. ECHO, INC. and its affiliated companies shall not be liable for any special incidental or consequential damage, including lost profits. There are no warranties extended other than as provided herein. This limited warranty may be modified only by ECHO, INC.

**99922201031  
06/2010**

**ECHO INCORPORATED EMISSION CONTROL WARRANTY STATEMENT  
FOR ECHO AND SHINDAIWA BRANDS**

The Environmental Protection Agency (EPA) and the California Air Resources Board (C.A.R.B.) and ECHO Incorporated (ECHO Inc.) are pleased to explain the emission control system warranty on your 2010 and later equipment/small off-road engine (SORE). New equipment/SORE must be designed, built and equipped to meet stringent EPA and C.A.R.B. anti-smog standards. ECHO Inc. must warrant the emission control system on your equipment/SORE for the periods of time listed below, provided there has been no abuse, neglect or improper maintenance of your equipment/SORE. Your emission control system may include parts such as: carburetor, fuel-injection system, ignition system, catalytic converter/muffler, fuel tank, fuel feed lines, fuel cap assembly, spark plug, air filters, and other associated components. Where a warrantable condition exists, ECHO Inc will repair your equipment/SORE at no cost to you including diagnosis, parts and labor. The Emission Control System warranty is extended to the original owner including all subsequent owners.

**MANUFACTURER'S WARRANTY COVERAGE:**

The emission control system is warranted for 2 years or the length of the ECHO Inc. warranty, whichever is longer. If any emission-related part on your equipment is defective, the part will be repaired or replaced by ECHO Inc. or its Authorized Service Representative.

**OWNER'S WARRANTY RESPONSIBILITIES:**

As the equipment/SORE owner, you are responsible for the performance of the required maintenance listed in your Operator's Manual. ECHO Inc. recommends that you retain all receipts covering maintenance on your equipment/SORE however, ECHO Inc. cannot deny warranty solely for the lack of receipts or for your failure to ensure the performance of all scheduled maintenance. As the equipment/SORE owner, you should be aware that ECHO Inc. may deny you warranty coverage if your equipment/SORE or a part has failed due to abuse, neglect, improper maintenance or unapproved modifications.

You are responsible for presenting your equipment/SORE to an ECHO Inc. authorized service representative as soon as a problem exists. The warranty repairs should be completed in a reasonable amount of time, not to exceed 30 days. If a warrantable condition exists and there is no Authorized Dealer within 100 miles, ECHO Inc. will pay to ship the unit to the nearest authorized dealer. If you have questions regarding your warranty coverage, you should contact ECHO Inc. at 1-800-673-1558, web site WWW.ECHO-USA.COM or contact Shindaiwa at 1-877-986-7783, web site WWW.SHINDAIWA.COM.

**WHAT DOES THIS WARRANTY COVER?**

ECHO Inc. warrants that your equipment/SORE was designed, built and equipped to conform with applicable EPA and C.A.R.B. emissions standards and that your equipment/SORE is free from defects in material and workmanship that would cause it to fail to conform with applicable requirements for 2 years or the length of the ECHO Inc. warranty, whichever is longer. The warranty period begins on the date the product is purchased by an end user.

**HOW WILL A COVERED PART BE CORRECTED?**

If there is a defect in a part covered by this warranty, any ECHO Inc. Authorized Service Dealer will correct the defect. You will not have to pay anything to have the part adjusted, repaired or replaced. This includes any labor and diagnosis for warranted repairs performed by the dealer. In addition, engine parts not expressly covered under this warranty but whose failure is a result of a failure of a covered part will be warranted.

**WHAT PARTS ARE COVERED?**

Any applicable emission related part not scheduled for "required maintenance" will be repaired or replaced within the warranty period. The repaired or replaced part will be warranted for the remaining ECHO Inc. warranty period.

Any warranted part that is scheduled only for regular inspection in the written instructions supplied is warranted for the warranty period stated above. Any such part repaired or replaced under warranty will be warranted for the remaining ECHO Inc. warranty period.

Any emission related part scheduled for replacement during "required maintenance" is warranted for the period of time prior to the first scheduled replacement point for that part. Any such part repaired or replaced under warranty shall be warranted for the remainder of the period prior to the first scheduled replacement point for that part.

Any manufacturer-approved replacement part may be used in the performance of any warranty maintenance or repairs on emission related parts, and must be provided without charge if the part is still under warranty.

Any replacement part that is equivalent in performance and durability may be used in non-warranty maintenance or repairs, and shall not reduce the warranty obligations of the manufacturer.

Throughout the equipment/SORE warranty period, ECHO Inc. will maintain a supply of warranted parts sufficient to meet the expected demand for such parts.

**SPECIFIC EMISSION RELATED WARRANTED PARTS:**

- Electronic Ignition System
- Catalytic Converter / Muffler Assembly
- Choke
- Fuel Tank
- Air Filter
- Spark Plug
- Carburetor (complete assembly or replaceable components)
- Fuel-Injection Assembly (or replaceable components)
- Fuel Cap Assembly
- Fuel Feed Line (and associated clamps/connectors as applicable)

**WHAT IS NOT COVERED?**

Any failure caused by abuse, neglect, improper maintenance, unapproved modifications, use of unapproved add-on parts/modified parts or unapproved accessories.

This Emission Control Warranty is valid only for the U.S.A., its Territories, and Canada.

**99922201033  
01/2010**









## **Servicing Information**

### **Parts/Serial Number**

Genuine Shindaiwa Parts and Assemblies for your Shindaiwa products are available only from an Authorized Shindaiwa Dealer. When you do need to buy parts **always** have the Model Number, Type and Serial Number of the unit with you. You can find these numbers on the engine. For future reference, write them in the space provided below.

Model No. \_\_\_\_\_ SN. \_\_\_\_\_

### **Service**

Service of this product during the warranty period must be performed by an Authorized Shindaiwa Service Dealer. For the name and address of the Authorized Shindaiwa Service Dealer nearest you, ask your retailer or call: 1-877-986-7783. Dealer information is also available on WWW.SHINDAIWA.COM. When presenting your unit for Warranty service/repairs, proof of purchase is required.

### **Consumer Product Support**

If you require assistance or have questions concerning the application, operation or maintenance of this product you may call the Shindaiwa Consumer Product Support Department at 1-877-986-7783 from 8:30 am to 4:30 pm (Central Standard Time) Monday through Friday. Before calling, please know the model and serial number of your unit.

### **Warranty Registration**

To ensure trouble free warranty coverage it is important that you register your Shindaiwa equipment by filling out the warranty registration card supplied with your unit. Registering your product confirms your warranty coverage and provides a direct link if we find it necessary to contact you.

### **Additional or Replacement Manuals**

**Replacement Operator and Parts Catalogs** are available from your Shindaiwa dealer or at WWW.SHINDAIWA.COM or by contacting the Consumer Product Support Department (1-877-986-7783). Always check WWW.SHINDAIWA.COM for updated information.

# **shindaiwa<sup>®</sup>**

ECHO Incorporated.  
400 Oakwood Road  
Lake Zurich, IL 60047-1564 U.S.A.  
Telephone: 1-877-986-7783  
Fax: 1-847-540-8416  
www.shindaiwa.com

Yamabiko Corporation  
7-2 Suehirocho 1-Chome, Ohme,  
Tokyo, 198-8760, Japan  
Phone: 81-428-32-6118  
Fax: 81-428-32-6145

## Free Manuals Download Website

<http://myh66.com>

<http://usermanuals.us>

<http://www.somanuals.com>

<http://www.4manuals.cc>

<http://www.manual-lib.com>

<http://www.404manual.com>

<http://www.luxmanual.com>

<http://aubethermostatmanual.com>

Golf course search by state

<http://golfingnear.com>

Email search by domain

<http://emailbydomain.com>

Auto manuals search

<http://auto.somanuals.com>

TV manuals search

<http://tv.somanuals.com>