

# PRICE LIST

OF

# PARTS



**MACHINES Nos. 114-1,  
114-2 and 114-20**

---

**THE SINGER MANUFACTURING COMPANY**

# INSTRUCTIONS FOR ORDERING

---

In ordering from this list, use **ONLY** the part **NUMBER** in the **FIRST** column.

The number stamped on a Sewing Machine part is in every case the number of the single part only.

Every combination of parts sent out as such has its specific number, which, although not stamped on the parts, must be used when ordering the combination.

Each number always indicates the **SAME PART** in whatever list it appears, or for whatever machine.

The letters after some of the numbers indicate the style of finish only, as follows:

- A. Hardened, Polished and Plated.
- B. Polished and Plated.
- C. Hardened only.
- D. Polished only.
- E. Soft, not Polished.
- F. . . . .
- G.
- H. Blued.
- J. Plated only.
- K. Hardened and Plated.
- L. Brass or Gilt.
- M. Oxidized.
- P. Japanned.

These letters **MUST BE USED** when they appear in the list, and **AFTER** the number *as* in the list.

In this series

- 1 to 1500 and 50001 to 51500 are Screw Numbers.
- 1501 to 1800 are Nut Numbers.
- 1801 to 2000 are Roller Numbers.
- 2001 to 50000 and 52001 and upward are numbers of Machine Parts.

The figures in the second column refer only to the plates, illustrating the parts, and are **NOT TO BE USED** in ordering.

Parts marked with an asterisk (\*) are furnished only when repairs are made at factory.

NO.	PLATE	NAME	EACH
39222	6977	Belt Shifter.....	\$ 25
39223	6976	“ “ Clamp.....	25
1255D	6976	“ “ “ Screw.....	04
39238	3747	Button Clamp (left) with 9311 and 17723	1 00
39239	3747	“ “ (right) with 9311 and 17723	1 00
39240	3747	“ “ Arm with 17711 and 17714	3 00
17710	6978	“ “ “ Hinge Plate.....	35
1176D	6978	“ “ “ “ “ Screw....	04
17711	6979	“ “ “ Hook.....	10
1175E	6978	“ “ Hinge Screw.....	04
59710	6979	“ “ Lifter.....	1 00
190D	6990	“ “ “ Screw.....	03
39241	6978	“ “ Pressure Spring.....	50
17713	6978	“ “ “ “ Bracket	1 00
1177D	6978	“ “ “ “ “ “	
		Screw.....	04
17714	6978	Button Clamp Pressure Spring Guide Block.....	15
1178D	6978	Button Clamp Pressure Spring Screw....	06
39242	6978	“ “ “ Spreader.....	40
17714	6979	“ “ “ “ “ Hinge	
50237F	6979	“ “ “ “ “ “	
		Screw.....	02
1180D	6979	Button Clamp Spreader Lever Locking Thumb Screw.....	08
17718	6979	Button Clamp Spreader Lever Locking Thumb Screw Washer.....	01
1182E	6978	Button Clamp Spreader Screw.....	02
39243	6978	“ “ “ “ Spring.....	05
207F	6978	“ “ “ “ “ Screw	02
7071	6990	“ “ “ “ “ “	
		Washer.....	01
17720	6979	Button Clamp Spreader Steady Pin.....	01
39244	3747	“ “ “ Spring (left) for flat buttons.....	25
39245	3747	Button Clamp Spring (right) for flat buttons.....	25
39246	6978	Button Clamp Spring (left) for stud back buttons.....	35
39247	6978	Button Clamp Spring (right) for stud back buttons.....	35
229D	6978	Button Clamp Spring Screw.....	02
9311	3747	“ “ “ “ Steady Pin per 100	10
39248	6979	“ “ “ Stop with two 17720.....	75
1183D	6979	“ “ “ “ Screw.....	04
17723	6979	“ “ “ Stud.....	05

NO.	PLATE	NAME	EACH
1650c	6982	Feed Across Connection Adjusting Stud Nut (right).....	\$ 03
62116	6982	Feed Across Knuckle Joint.....	1 00
17728	6982	“ “ “ “ Connection.....	1 00
1184E	6982	“ “ “ “ “ “.....	07
59713	6984	Hinge Screw.....	3 50
17730	6982	Feed Across Lever with 1185c and 50150c “ “ “ “ Ball Stud.....	30
1185c	6982	“ “ “ “ “ “ Set Screw....	03
59714	—	Feed Across Lever complete, Nos. 59713, 59715 and 59721.....	6 00
59715	6983	Feed Across Lever Extension with 1952 and 51814.....	2 50
59716	6983	Feed Across Lever Extension Disengaging Eccentric.....	60
59717	6983	Feed Across Lever Extension Disengaging Eccentric Connection.....	40
999D	6983	Feed Across Lever Extension Disengaging Eccentric Connection Hinge Screw....	05
59718	6983	Feed Across Lever Extension Disengaging Eccentric Connection.....	03
193D	6983	Feed Across Lever Extension Disengaging Eccentric Connection Spring Screw....	03
238D	6983	Feed Across Lever Extension Disengaging Eccentric Connection Stop Screw.....	02
227D	6983	Feed Across Lever Extension Disengaging Eccentric Pin.....	01
59719	6983	Feed Across Lever Extension Disengaging Eccentric Shaft.....	10
59720	6983	Feed Across Lever Extension Disengaging Handle.....	25
2273	6983	Feed Across Lever Extension Disengaging Handle Pin.....	01
51814	6983	Feed Across Lever Extension Guiding Roller and Screw Stud.....	25
59721	6983	Feed Across Lever Extension Hinge Pin	03
50150c	6991	“ “ “ “ “ “ “ “ Set Screw.....	02
59722	6984	Feed Across Lever Extension Position Arm.....	1 50
2022	6983	Feed Across Lever Extension Position Arm Pin.....	01
59723	6983	Feed Across Lever Extension Position Arm Support.....	50
1404D	6983	Feed Across Lever Extension Position Arm Support Screw.....	05

NO.	PLATE	NAME	EACH
59728	6989	Feed Cam Shaft.....	\$ 1 80
1653c	6999	“ “ “ Nut.....	10
59729	6988	“ Plate (thick).....	15
17923	6988	“ “ (thin) for round bottom buttons.....	15
18445	6989	Feed Plate Carrier Bar.....	1 00
62123	—	“ “ “ “ 18445 with 934d, 1094F, 1195E, 17743, 18368, 62118, 62119, two 7476 and four 17806.....	4 15
59730	6987	Feed Plate Carrier Bar Pivot Block.....	40
50306d	6987	“ “ “ “ “ “ Screw.....	10
18368	6987	“ “ “ “ Plate.....	10
934d	6987	“ “ “ “ “ Screw.....	02
1654c	6988	“ “ Nut.....	04
17806	6988	“ “ Position Stud.....	05
1195E	6988	“ “ Screw Stud.....	02
17742	6984	“ Regulator with 1953.....	2 00
62117	6984	“ “ Bracket with 17732 and three 160d.....	5 00
*17732	—	Feed Regulator Bracket Cap.....	50
160d	6998	“ “ “ “ Screw.....	04
8589	6988	“ “ “ Dowel Pin.....	03
1177d	6978	“ “ “ Screw.....	04
17744	6987	“ “ Hinge Stud.....	30
17743	6987	“ “ Post.....	50
1953	6988	“ “ “ “ “ “ “ “ with 1655c and 14017.....	45
1655c	6985	Feed Regulator Roller and Screw Stud Nut.....	04
14017	6985	Feed Regulator Roller and Screw Stud Nut Washer.....	05
1190c	6987	Feed Regulator Stop Screw.....	02
17745	6987	“ “ Swivel.....	70
1191d	6987	“ “ Thumb Screw.....	08
59731	6990	Knife.....	40
62124	6975	“ Bar with 62130 and two 3021.....	1 75
62125	6990	“ “ Cap.....	25
164d	6990	“ “ “ Screw.....	04
62126	6990	“ “ Connection with 17917.....	75
190d	6990	“ “ “ “ Screw.....	03
7071	6990	“ “ “ “ Washer.....	01
17915	6990	“ “ “ Slide Block.....	25
17917	—	“ “ “ “ “ “ 17915 with 17916.....	40
17916	6990	Knife Bar Connection Slide Block Stud..	15
59734	6990	“ “ Driving Lever with 223F and 59735.....	1 40

## PARTS FOR MACHINE NO. 114-1

NO.	PLATE	NAME	EACH
1095F	6991	Looper Shaft Eccentric Connection Stud Cap Screw . . . . .	\$ 04
1259c	6991	Looper Shaft Eccentric Connection Stud Set Screw . . . . .	03
624c	6991	Looper Shaft Eccentric Set Screw . . . . .	03
62134	6991	" " Slide Block . . . . .	1 50
62135	6991	" " " " Cap . . . . .	40
1186c	6991	" " " " " Screw . . . . .	04
34418	6991	" Washer . . . . .	01
59756	6989	Needle Bar with 1072F . . . . .	60
39203	6992	" " Connecting Link . . . . .	40
377c	6992	" " " " " Hinge Screw . . . . .	12
1518E	6992	" " " " " " " . . . . .	04
2052	6992	Nut . . . . .	04
2052	6992	Needle Bar Connecting Stud with 155c . . . . .	25
155c	6992	" " " " " Set Screw . . . . .	03
59757	6992	" " Crank Wheel with 448c and 1293c . . . . .	75
1293c	6992	Needle Bar Crank Wheel Position Screw . . . . .	10
448c	6992	" " " " " Set Screw . . . . .	03
59758	6993	" " Guard . . . . .	"
59759	6993	" " Cam with two 465c . . . . .	75
465c	6991	" " " Set Screw . . . . .	02
2273	6983	" " Pin . . . . .	01
59760	6989	" " Shaft . . . . .	60
59761	6993	" " " " " Collar with two 465c . . . . .	15
465c	6991	" " " " " Set Screw . . . . .	02
59762	6993	" " " " " Crank with 51812 and two 465c . . . . .	80
51812	6993	Needle Guard Shaft Crank Roller and Stud . . . . .	20
465c	6991	Needle Guard Shaft Crank Set Screw . . . . .	02
59763	6993	" " " " " End Bearing . . . . .	1 50
59764	6989	" " " " " " Bracket . . . . .	50
2022	6983	" " " " " " " . . . . .	"
965d	6993	Dowel Pin . . . . .	01
965d	6993	Needle Guard Shaft End Bearing Bracket Screw . . . . .	04
1480H	6993	Needle Guard Shaft End Bearing Cap Screw . . . . .	07
59765	6993	Needle Guard Shaft Spring . . . . .	10
59766	6993	" " " " " Collar with 624c . . . . .	15
624c	6991	Needle Guard Shaft Spring Collar Set Screw . . . . .	03
233D	6995	Needle Guard Shaft Spring Screw . . . . .	02
1072F	6993	" Set Screw . . . . .	02

NO.	PLATE	NAME	EACH
39343	6981	Stop Cam Interlocking Rod Case Spring (flat).....	\$ 25
430c	6994	Stop Cam Interlocking Rod Case Spring Adjusting Screw.....	04
1520e	6994	Stop Cam Interlocking Rod Case Spring Adjusting Screw Nut.....	03
39344	6994	Stop Cam Interlocking Rod Case Spring Bracket with 430c and 1520e.....	25
1186f	6991	Stop Cam Interlocking Rod Case Spring Bracket Screw.....	04
1786I	6994	Stop Cam Interlocking Rod Case Stop Stud.....	20
1254c	6998	Stop Cam Interlocking Rod Case Stop Stud Screw Bushing.....	20
1508E	6999	Stop Cam Interlocking Rod Case Stop Stud Screw Bushing Lock Nut.....	06
17862	6994	Stop Cam Interlocking Rod Case Stop Stud Spring.....	05
59771	6994	Stop Cam Interlocking Rod Case Wearing Block.....	75
		Block Screw.....	03
17863	6994	Stop Cam Interlocking Rod Spring.....	05
17864	6994	" " " " Stop.....	15
1318b	6994	" " " " " Screw.....	04
2012	6988	" " Pin.....	01
1206c	6994	" " Screw.....	10
2102	6995	Tension Disc.....	05
1560c	6995	" Regulating Thumb Nut.....	04
50148c	6995	" Screw Stud.....	15
42336	6995	" Spring.....	05
13915	6995	" " Bushing.....	05
10145	6995	" Thread Guide.....	01
59772	6995	Thread Eyelet (head of arm).....	03
233d	6995	" " " " " Set Screw.....	02
1743d	6979	" Nipper Adjusting Thumb Nut.....	10
59773	6995	" " Body.....	35
624c	6991	" " " Set Screw.....	03
59774	6995	" " Cam with two 50150c.....	75
50150c	6991	" " " Set Screw.....	02
2921	6995	" " Disc.....	05
12162	6995	" " " Guide Pin.....	01
62169	6979	" " " Spring.....	05
59775	6995	" " Eyelet.....	50
1527d	6995	" " Lock Nut.....	03
59776	6995	" " Stud with 13538.....	25
13538	6995	" " " Position Pin.....	02

NO.	PLATE	NAME	EACH
17872	6994	Trip Lever.....	\$ 80
1196c	6998	" " Hinge Screw.....	12
17873	6994	" " Spring.....	05
1182E	6978	" " " Screw.....	02
17874	6987	Tripping Point.....	25
190b	6990	" " " Screw.....	03

## MACHINE NO. 114-2

FOR CLOTHING, SHIRTWAISTS, ETC. MAKES CROSSED STITCHES IN  
FOUR HOLE BUTTONS, AND CAN BE ADJUSTED FOR TWO  
HOLE AND BAR BUTTONS. MAKES TWENTY-ONE  
STITCHES INCLUDING THE FASTENING  
STITCHES

This Machine is the same as No. 114-1 with the following  
exceptions:

NO.	PLATE	NAME	EACH
62161	6986	Feed Cam with 1192c, two each 190b, 17874, 62138 and four 208b, in place of 62122.....	\$13 35



NO.	PLATE	NAME	EACH
1253c	6976	Arm Shaft (upright) Gear (upper) Set	
		Screw.....	\$ 03
18498	6975	Belt Cover.....	30
59795	6977	“ “ Bracket with 184E and 59796.	75
184E	6998	“ “ “ Screw Stud.....	02
59796	6988	“ “ “ Stud.....	10
217F	6998	“ “ Screw.....	03
39222	6977	“ Shifter.....	25
39223	6976	“ “ Clamp.....	25
1255D	6976	“ “ “ Screw.....	04
62140	7000	Clamp with 1220E and 17928.....	2 50
62141	7000	“ Arm with 17714 and 62142.....	75
17710	6978	“ “ Hinge Plate.....	35
1176D	6978	“ “ “ “ Screw.....	04
62142	7000	“ “ Hook.....	10
59710	6979	“ Lifter.....	1 00
190D	6990	“ “ Screw.....	03
17928	7000	“ Position Stud.....	10
17712	7001	“ Pressure Spring.....	50
17713	6978	“ “ “ Bracket.....	1 00
11771, 6978		“ “ “ “ “ Screw.....	04
17714	6978	“ “ “ Guide Block.....	15
1178D	6978	“ “ “ Screw.....	06
1220D	7000	“ Screw Stud.....	04
1656D	7000	“ Thumb Nut.....	10
62143	—	Clamp complete, Nos. 1656D, 62140 and 62141.....	3 33
*62101	—	Cloth Plate.....	1 50
62102	6980	“ “ Guide Block (left).....	50
742F	6980	“ “ “ “ “ Screw.....	05
1547D	6980	“ “ “ “ “ “ Nut.....	03
62103	6980	“ “ “ “ (right).....	25
3021	6980	“ “ “ “ “ Rivet,	
		per 100.....	25
190D	6990	Cloth Plate Screw.....	03
62104	6980	“ “ Stop.....	10
26770	6980	“ “ “ Rivet.....	01
62105	6975	Cloth Plate complete, Nos. 742F, 1547D, 26770, 62101 to 62104 and two 3021..	2 45
*62144	—	Cylinder.....	22 50
62145	7002	“ Bottom Cover.....	1 00
62108	6981	“ End Cover.....	35
62146	—	“ “ “ 62108 with 1034D, 62110 to 62113, 62145 and two each 1345D and 1477D.....	2 40
62110	6980	Cylinder End Cover Bracket.....	40
62111	6980	“ “ “ “ Hinge Pin..	01

NO.	PLATE	NAME	EACH
1187E	6982	Feed Across Regulator Adjusting Stud...	\$ 22
1676c	6982	" " " " " Nut	05
17738	6982	" " " " " "	
		Washer.....	05
17739	6982	Feed Across Regulator Adjusting Stud Sleeve.....	25
1188d	6998	Feed Across Regulator Hinge Screw.....	25
62152	7001	" " " Link.....	50
1189E	7001	" " " " Screw Stud..	10
62153	7001	" " " " Stud.....	15
62154	7003	" Cam with 1192c, three each 190b, 17874, 62138 and six 208d.....	13 35
18415	6987	Feed Cam Driving Worm with 1441c and 1442c.....	2 70
1442c	6987	Feed Cam Driving Worm Position Screw.	04
1441c	6987	" " " " Set Screw.....	04
17797	6977	" " " " Wheel with 453c	2 70
3012	6988	" " " " " Pin.....	01
453c	6987	" " " " " Set Screw	02
18384	6988	" " Pin.....	02
62155	7002	" " Shaft.....	1 80
1653c	6999	" " Nut.....	10
39358	7004	" Plate.....	50
18445	6989	" " Carrier Bar.....	1 00
18445	6989	" " " " 18445 with 934b, 1094F, 1195E, 17743, 18368, 62149, 62150, two 7476 and four 17806.....	4 10
59730	6987	Feed Plate Carrier Bar Pivot Block	40
50306D	6987	" " " " " "	
		Screw.....	10
18368	6987	Feed Plate Carrier Bar Plate.....	10
934D	6987	" " " " " Screw.....	02
1654c	6988	" " Nut.....	04
17806	6988	" " Position Stud.....	05
1195E	6988	" " Screw Stud.....	02
62157	7002	" Regulator with 1953.....	2 00
62148	7002	" " Bracket with 39310 and three 160D.....	5 00
*39310	—	Feed Regulator Bracket Cap.....	50
160D	6998	" " " " Screw.....	04
8589	6988	" " " Dowel Pin.....	03
1177D	6978	" " " Screw.....	04
17744	6987	" " Hinge Stud.....	30
17743	6987	" " Post.....	50
1953	6988	" " Roller and Screw Stud with 1655c and 14017.....	45

NO.	PLATE	NAME	EACH
50150c	6991	Looper Driving Shaft Coupling Set Screw	\$ .02
59707	6976	“ “ “ Gear with two 1253c.....	75
59747	6992	Looper Driving Shaft Gear Cover.....	15
190D	6990	“ “ “ “ “ Screw..	03
1253c	6976	“ “ “ “ Set Screw....	03
59748	6991	“ “ “ Universal Joint....	40
50150c	6991	“ Set Screw.....	02
62158	7002	“ Shaft with 50150c and 59742....	50
59745	6991	“ “ Collar with two 465c.....	15
465c	6991	“ “ “ Set Screw.....	02
59746	6991	“ “ Coupling with two 50150c..	25
50150c	6991	“ “ “ Set Screw.....	02
59750	6991	“ “ Eccentric with two 624c...	1 00
62132	6991	“ “ “ Connection with 59752 and two 171E.....	1 00
*59752	—	Looper Shaft Eccentric Connection Cap	—
171E	6991	“ “ “ “ “ Screw.....	03
62133	6991	Looper Shaft Eccentric Connection Stud	..
1095F	6991	Looper Shaft Eccentric Connection Stud Cap Screw.....	04
1259c	6991	Looper Shaft Eccentric Connection Stud Set Screw.....	03
624c	6991	Looper Shaft Eccentric Set Screw.....	02
62134	6991	“ “ Slide Block.....	1 50
62135	6991	“ “ “ “ Cap.....	40
1186c	6991	“ “ “ “ “ Screw....	04
34418	6991	“ Washer.....	01
59756	6989	Needle Bar with 1072E.....	60
39203	6992	“ “ Connecting Link.....	40
377c	6992	“ “ “ “ Hinge Screw	12
1518E	6992	“ “ “ “ “ “ Nut.....	04
2052	6992	Needle Bar Connecting Stud with 155c..	25
155c	6992	“ “ “ “ Set Screw..	03
59757	6992	“ “ Crank Wheel with 448c and 1293c.....	75
1293c	6992	Needle Bar Crank Wheel Position Screw.	10
448c	6992	“ “ “ “ Set Screw.....	03
59758	6993	“ Guard.....	1 25
59759	6993	“ “ Cam with two 465c.....	75
465c	6991	“ “ “ Set Screw.....	02
2273	6983	“ “ Pin.....	01
59760	6989	“ “ Shaft.....	60
59761	6993	“ “ “ Collar with two 465c	15

NO.	PLATE	NAME	EACH
62136	6977	Stop Cam Interlocking Rod Case with 59771 and two 193F.....	\$ 4 00
59769	6977	Stop Cam Interlocking Rod Case Bracket	5 35
62137	—	Stop Cam Interlocking Rod Case Bracket complete, Nos. 1182E, 1196c, 1204E, 1254c, 1262c, 1318d, 1508E, 1662c, 17853, 17855, 17859, 17861 to 17864, 17872, 17873, 39222, 39223, 39343, 39344, 59769, 62136 and two each 898d, 1186F and 1255d.....	14 25
21828	6976	Stop Cam Interlocking Rod Case Bracket Dowel Pin.....	05
50307D	6998	Stop Cam Interlocking Rod Case Bracket Screw.....	06
1204E	6998	Stop Cam Interlocking Rod Case Hinge Screw.....	10
17859	6977	Stop Cam Interlocking Rod Case Socket Joint.....	50
898D	6998	Stop Cam Interlocking Rod Case Socket Joint Cap Screw.....	04
39343	6994	Stop Cam Interlocking Rod Case Spring (flat).....	25
430c	6994	Stop Cam Interlocking Rod Case Spring Adjusting Screw.....	04
1520E	6994	Stop Cam Interlocking Rod Case Spring Adjusting Screw Nut.....	03
39344	6994	Stop Cam Interlocking Rod Case Spring Bracket with 430c and 1520E.....	25
1186F	6991	Stop Cam Interlocking Rod Case Spring Bracket Screw.....	04
17861	6994	Stop Cam Interlocking Rod Case Stop Stud.....	20
1254c	6998	Stop Cam Interlocking Rod Case Stop Stud Screw Bushing.....	20
1508E	6999	Stop Cam Interlocking Rod Case Stop Stud Screw Bushing Lock Nut.....	06
17862	6994	Stop Cam Interlocking Rod Case Stop Stud Spring.....	05
59771	6994	Stop Cam Interlocking Rod Case Wearing Block.....	75
193F	6983	Stop Cam Interlocking Rod Case Wearing Block Screw.....	03
17863	6994	Stop Cam Interlocking Rod Spring.....	05
17864	6994	" " " " " Stop.....	15
1318D	6994	" " " " " Screw..	04
3012	6988	" " Pin.....	01
1206c	6994	" " Screw.....	10

NO.	PLATE	NAME	EACH
62172	6979	Thread Take-up Roller Pin.....	\$ 03
62173	6979	Thread Take-up complete, Nos. 337D, 42808, 62170 and 62171.....	75
691F	6990	Thread Take-up Screw.....	04
39452	6979	“ Wiper Body.....	50
39453	6979	“ “ “ Finger.....	50
330D	6979	“ “ “ “ Screw.....	02
1207D	6979	“ “ “ Hinge Screw.....	04
59787	6979	“ “ “ Support.....	20
641C	6979	“ “ “ “ Set Screw..	03
39455	6979	“ “ “ Wire.....	10
39456	6979	“ “ “ “ Clamp.....	10
1302D	6979	“ “ “ “ “ Screw..	02
62139	6997	Throat Plate.....	2 25
59799	6997	“ “ Needle Guard.....	50
1484F	6997	“ “ “ “ Screw.....	03
691F	6990	“ “ Screw.....	04
59790	6997	“ “ Thread Retainer.....	75
1481F	6997	“ “ “ “ Screw.....	03
17872	6994	Trip Lever.....	80
17873	6994	“ “ Spring.....	05
1182E	6978	“ “ “ Screw.....	02
17874	6987	Tripping Point.....	25
190D	6990	“ “ Screw.....	03



## STAND FOR ELECTRIC MOTOR

NO.	PLATE	NAME	EACH
46616	7012	Starting Treadle complete, Nos. 4879, 4881 to 4883, 46614 and 46615.....	\$ 90
46642	7012	Treadle Support.....	75
46643	—	“ “ 46642 with two 46616 and four 1177E.....	2 70
780E	6998	Treadle Support Bolt with 1600E.....	03
1600E	6999	“ “ “ Nut.....	02
25086	7012	Wrench for 780 and 1510.....	10
25283	—	Stand (iron work) complete, for electric motor, Nos. 25086, 46613, 46643, two each 780E, 25064 and four 506E.....	—

## TRIMMINGS FOR STAND NO. 25283

NO.	PLATE	NAME	EACH
62163	7012	Machine Base with wood screw 1¾ in. No. 1385E, 27253 and four 134D.....	\$ 3 50
1385E	7011	Machine Base Bolt with 1524E.....	03
1524E	7011	“ “ “ Nut.....	02
27253	7011	“ “ “ Washer.....	10
134D	7011	“ “ “ Screw.....	05
5970	—	Presser Bar Lifting Lever Chain, length 26 in. to 35 in.....	1 00
NOTE: When ordering 5670 give length required.			
6439	—	Starting Lever Chain, length 36 in. to 45 in.....	20
NOTE: When ordering 6439 give length required.			
62164	7011	Starting Lever Chain Pulley for 62163... ..	40
694E	7011	“ “ “ “ Screw.....	15
46644	7012	Table Support with three wood screws 1¾ in. No. 14.....	75
62165	7012	Table Work Clamp.....	50
20093	7012	“ “ “ Hanger with two wood screws 1 in. No. 10.....	10
62166	7011	Table Work Clamp Spring.....	20
62167	7010	“ “ “ “ Arm with 361C.....	25
361C	7010	“ “ “ “ Set Screw.....	05
62168	7010	“ “ “ “ Bracket with two wood screws 1 in. No. 10.....	30

## OBSOLETE PARTS

NO.	PLATE	NAME	EACH
59741	6993	Looper with 34418, use 62162.....	\$ 60
1609D	6995	Thread Nipper Adjusting Thumb Nut for 59778.....	10
59786	6993	Thread Take-up.....	30
59789	6993	Throat Plate Needle Guard, use 59799...	25



PLATE 3747—FULL SIZE

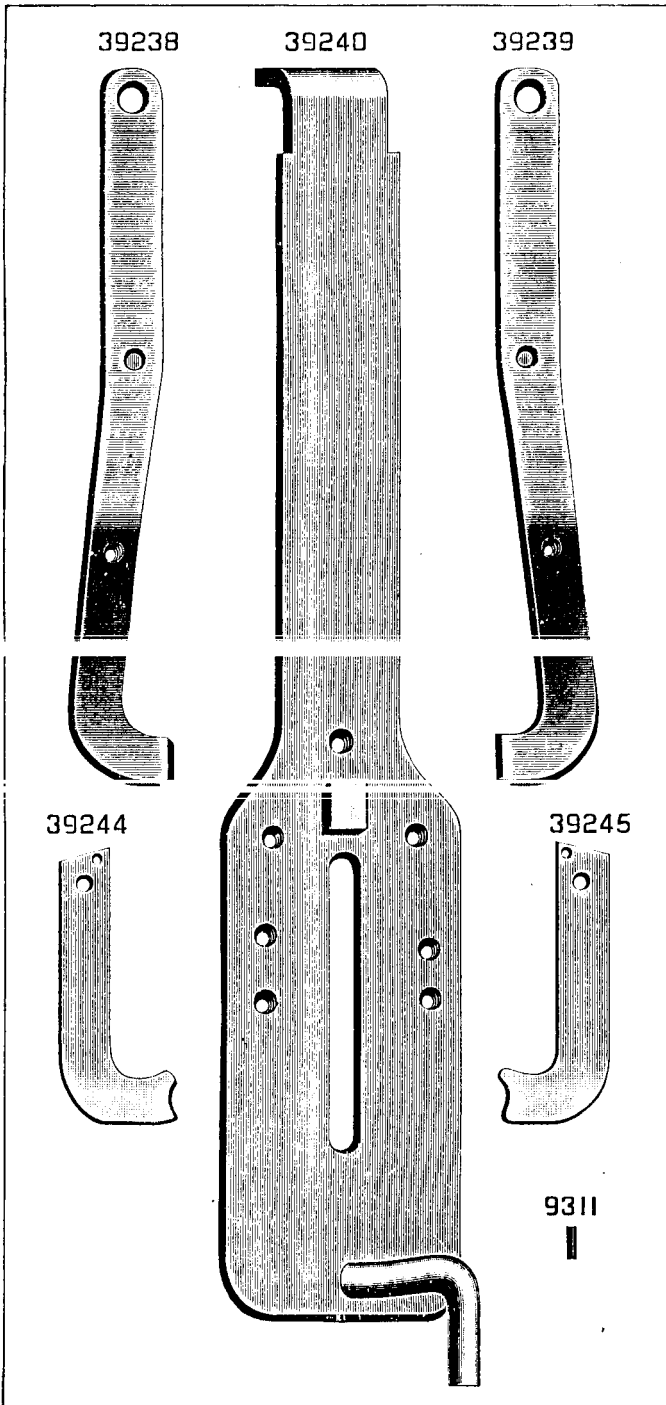
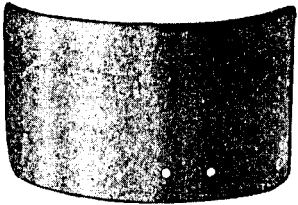

PLATE 6975—ONE-FOURTH SIZE

59702



18498



62124



62105

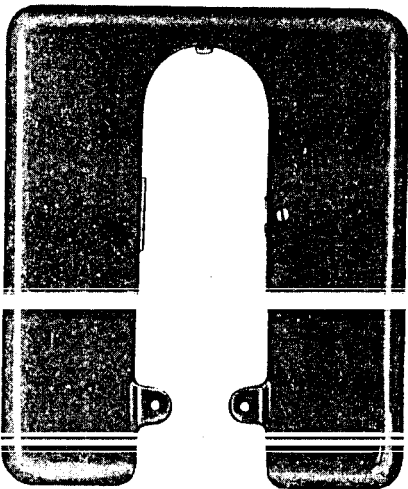
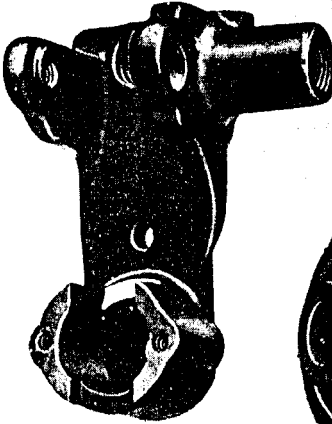

PLATE 6977—ONE-HALF SIZE

59769



17859



62136



17797

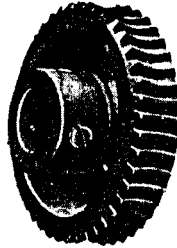

59795

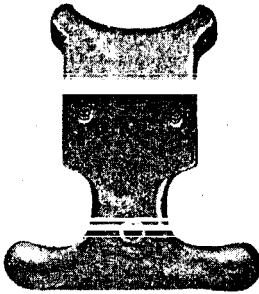

39222



17848



17942

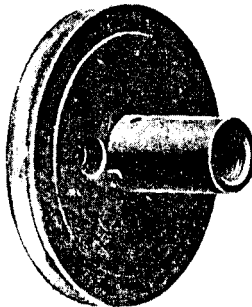

17941

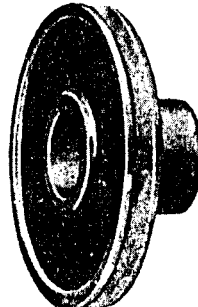

PLATE 6979—FULL SIZE

39248



1180



17717

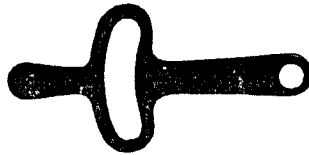

17723



59710

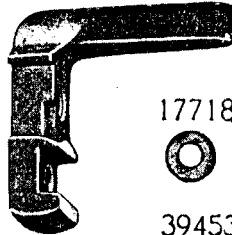

50237



17720



17718



330



39453

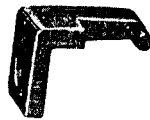

1183



59787



39452



39455



17711



641



1207



1302



39456



62173

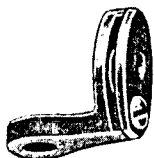

62171



42808



1743



337



62172



62169



PLATE 6981—ONE-HALF SIZE

59711

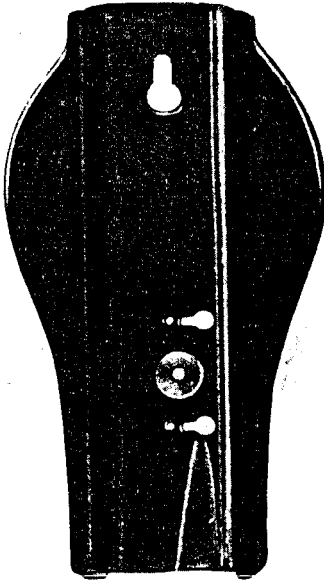

17843



39343



62108

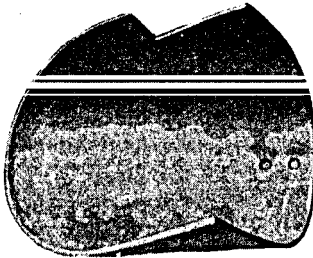

17703



62107

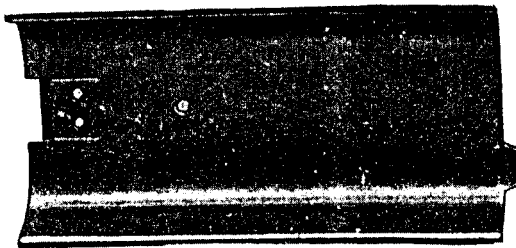

PLATE 6983—FULL SIZE

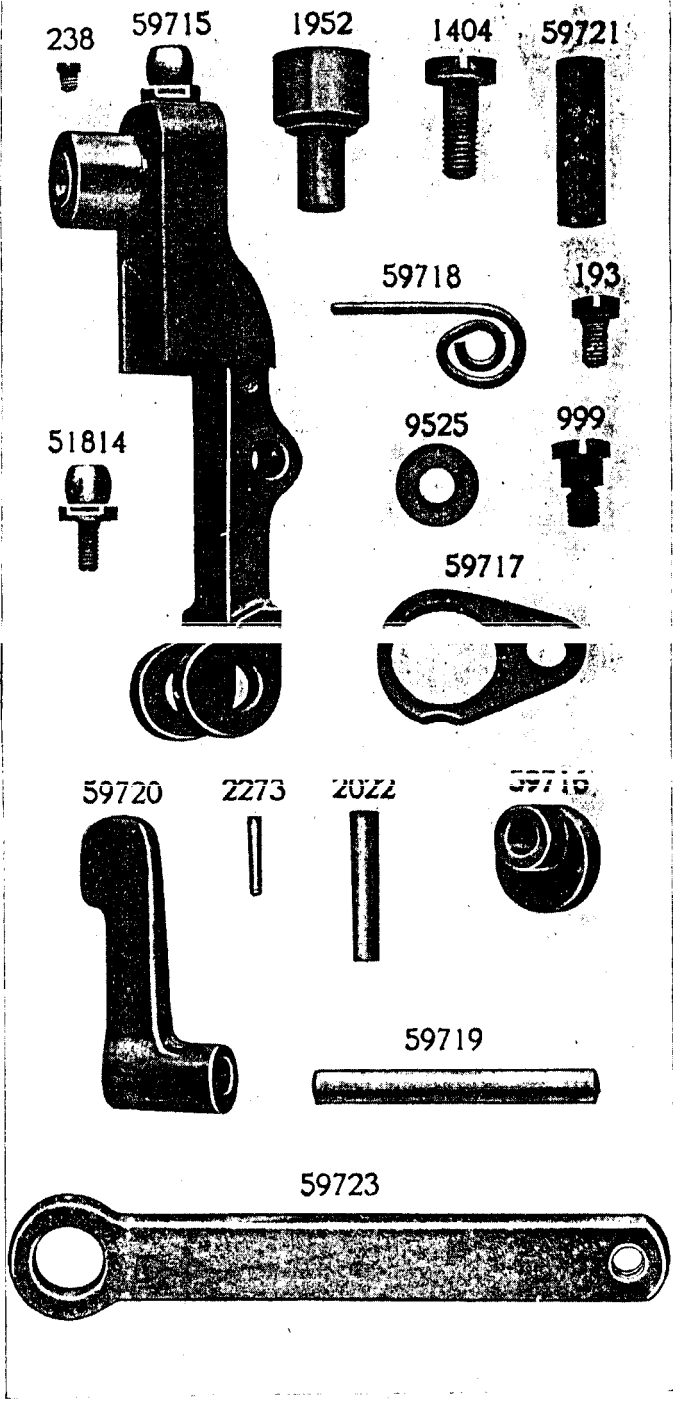
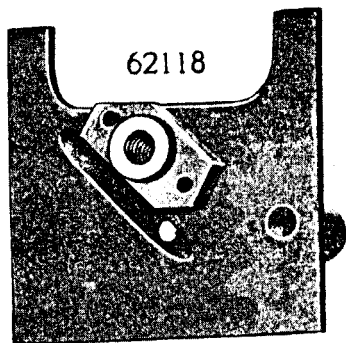

PLATE 6985—FULL SIZE



1094



7476

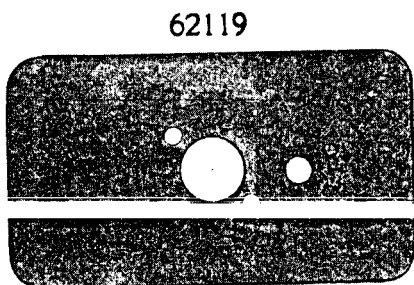

1774



50324



62121

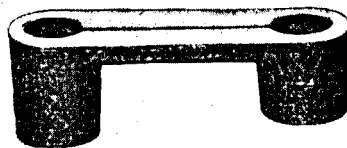

14017



1655



PLATE 6987—FULL SIZE

18415

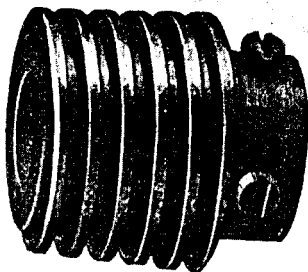

1442



1441



453



1192



59724



17743



1191



17744



17745



1190



59730



50306



934



18368



17874



62138





PLATE 6989—ONE-HALF SIZE

59760



59749



2058



59756



18445



59764

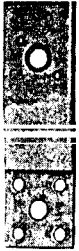
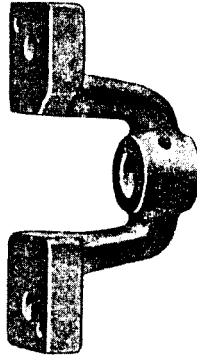

8414



59728



PLATE 6991—FULL SIZE

62162

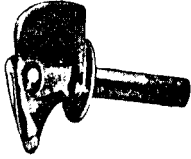

624



59750



34418



62134

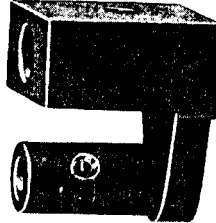

62132

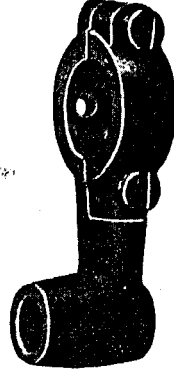

1259



62133



62131



1095



447



171



59743



59748



59746

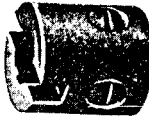

50150



465



59745



62135

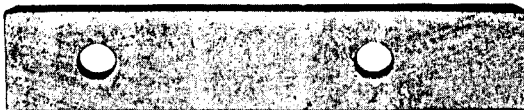

1186

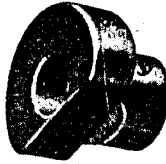

PLATE 6993—FULL SIZE

59758



59759



59761



59762

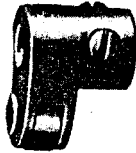

51812



59766



965



59765



59763

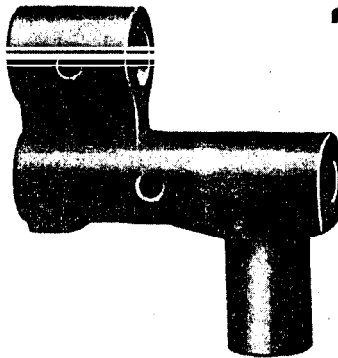

1480



1072



59789

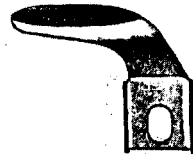

59786



59741

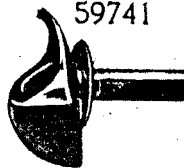
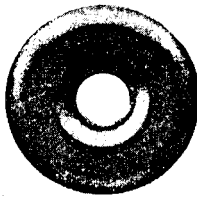

PLATE 6995—FULL SIZE

50148



2102



42336



1560



13915



59772

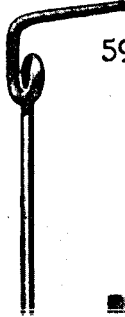

59776



2026



59773



10145



233



13538



2921

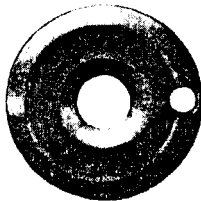

13540



59775



13539



59774

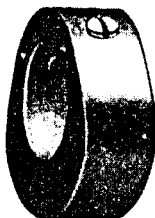

12162



1609



1527



PLATE 6997—FULL SIZE

62139

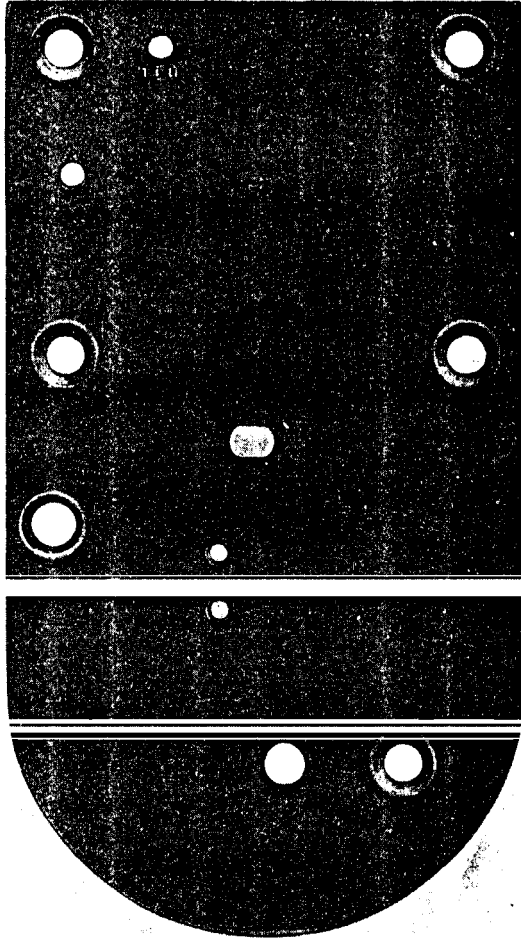

59799



59790



1484



PLATE 6999—FULL SIZE

1653

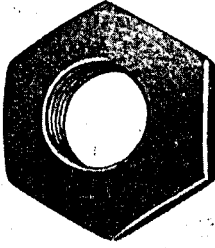

1508



1600

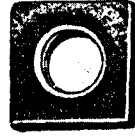

1662



1681



1510

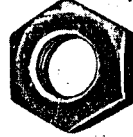
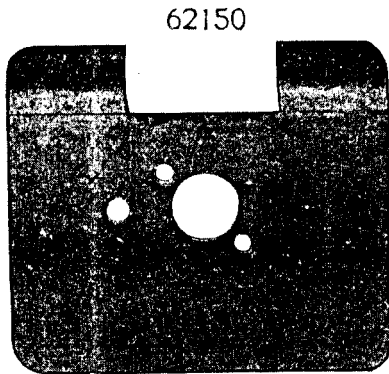
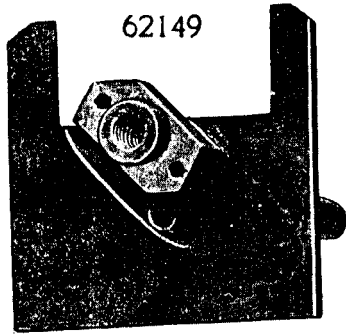

PLATE 7001—FULL SIZE



62154

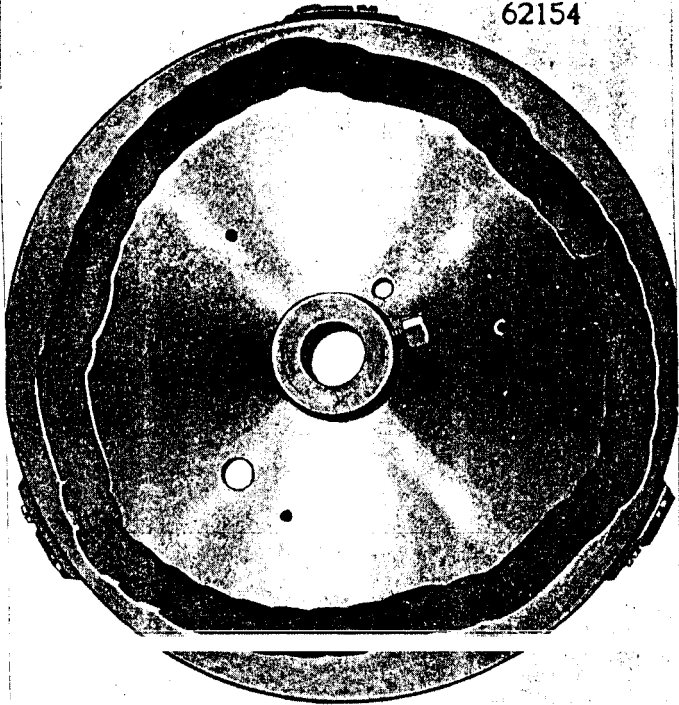



PLATE 7005—ONE-FOURTH SIZE

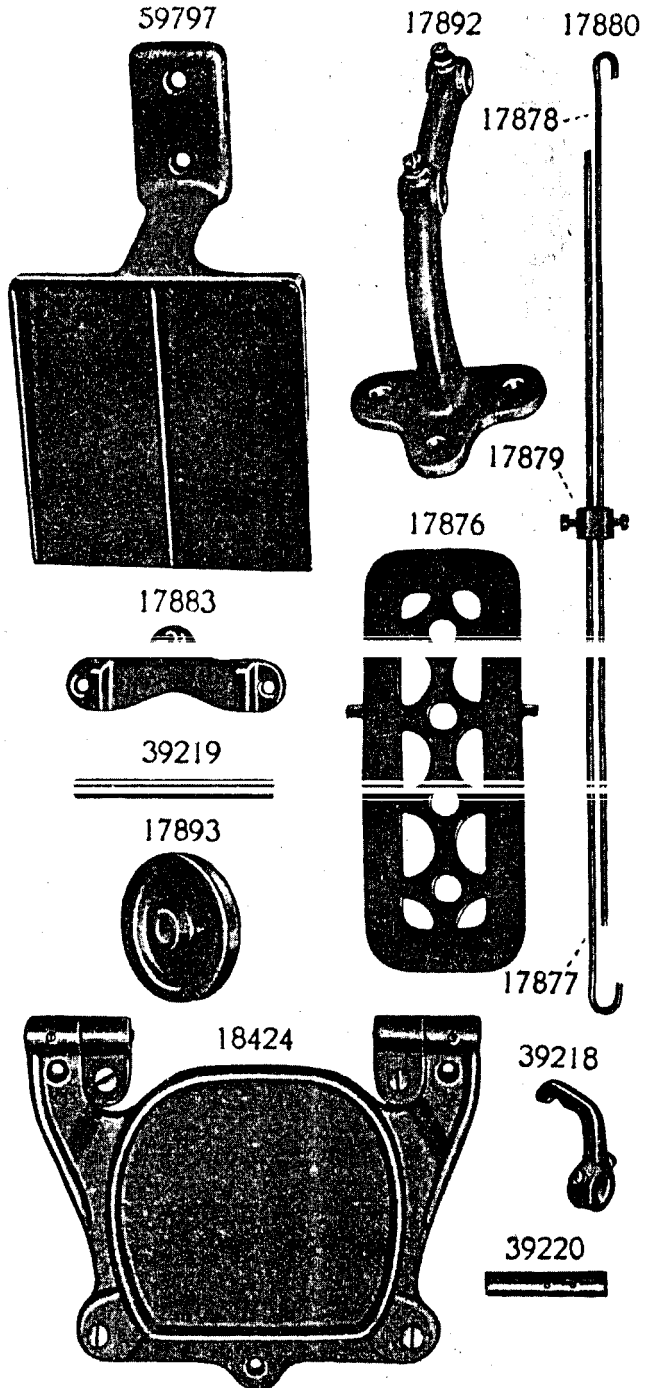

PLATE 7007—ONE-HALF SIZE

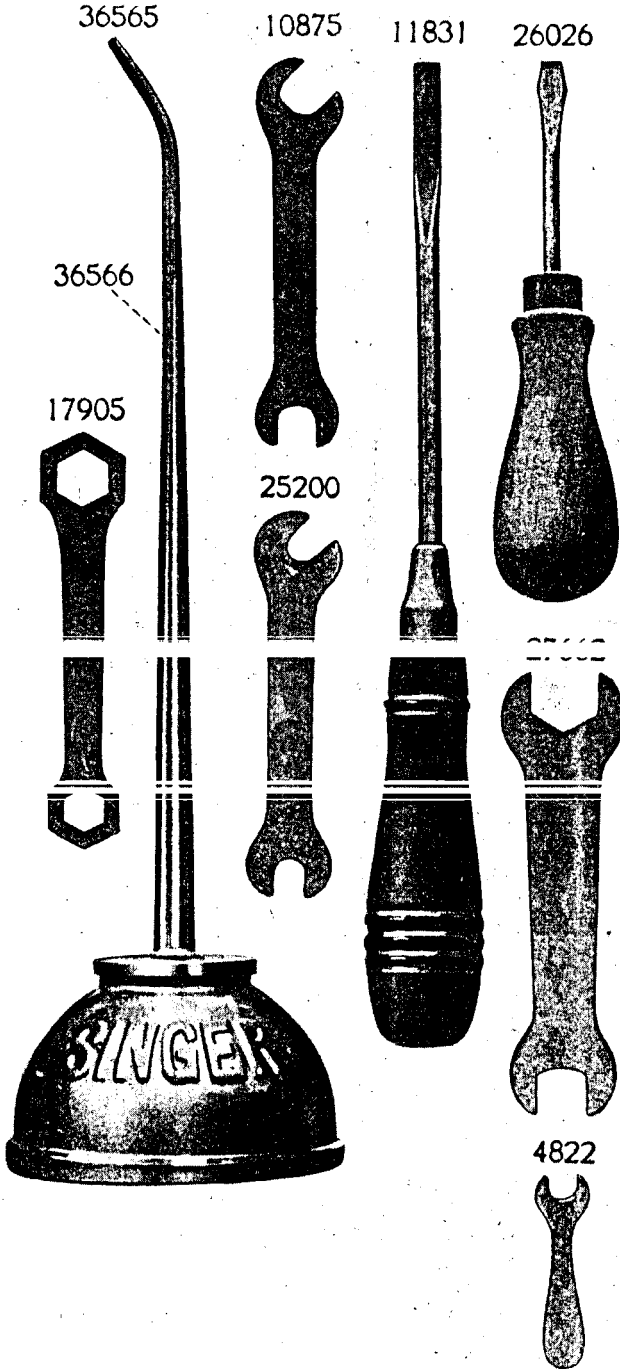

PLATE 7009—FULL SIZE

39492



160



39495



15261



237



52598



176



39497



50351



426



1099



454



448



1120



39493

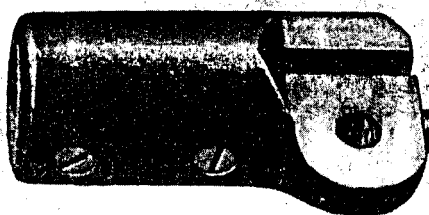
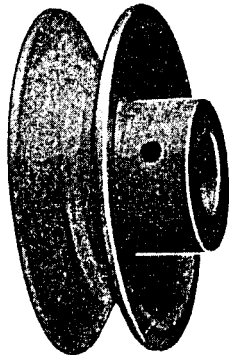
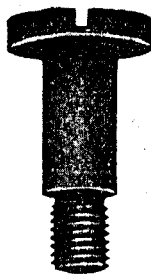

PLATE 7011—FULL SIZE

62164



694



27253

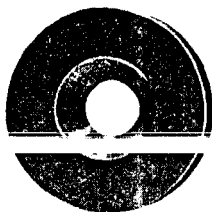

1385



62166



134

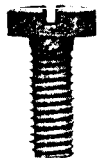

1524



## Free Manuals Download Website

<http://myh66.com>

<http://usermanuals.us>

<http://www.somanuals.com>

<http://www.4manuals.cc>

<http://www.manual-lib.com>

<http://www.404manual.com>

<http://www.luxmanual.com>

<http://aubethermostatmanual.com>

Golf course search by state

<http://golfingnear.com>

Email search by domain

<http://emailbydomain.com>

Auto manuals search

<http://auto.somanuals.com>

TV manuals search

<http://tv.somanuals.com>