



CE

Instruction manual

8219-3218-01

SH 60

STIGA

1

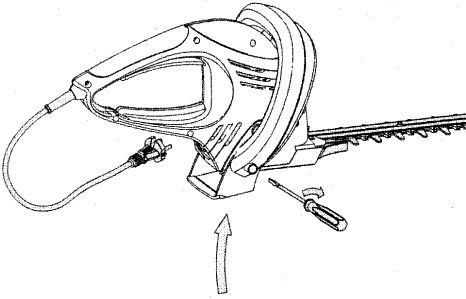

2

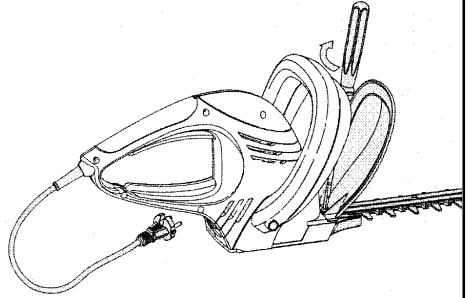

3

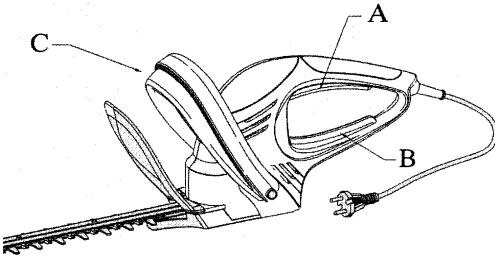

4

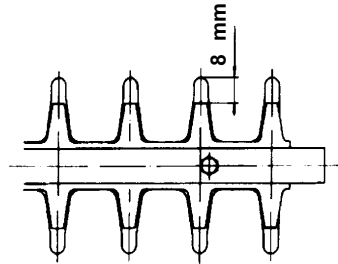

5

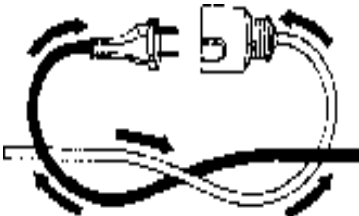

6

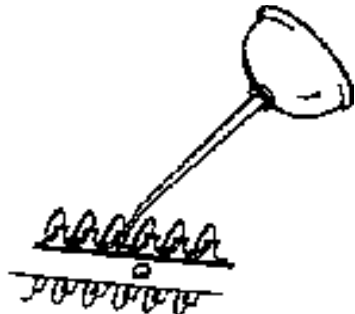

7

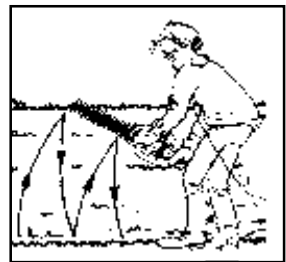
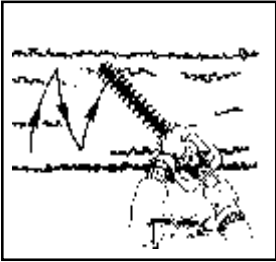

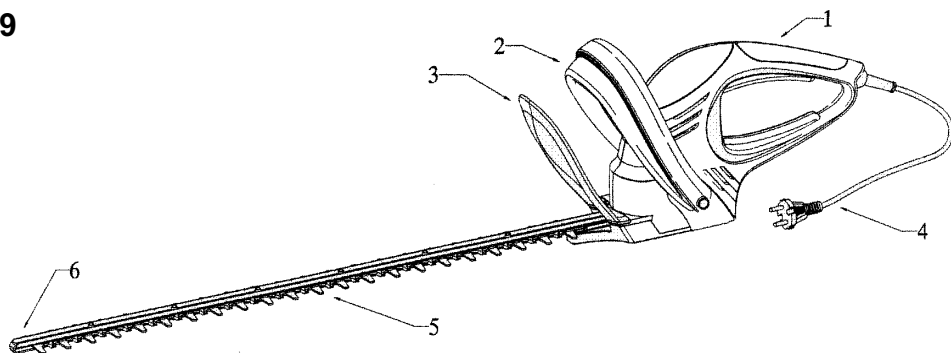
**S**

- 1+2 Handtag(1) + Bygelhandtag(2)
& Strömbrytare
- 3 Skyddskåpa
- 4 Elektrisk sladd med kontakt
- 5 Skyddsskena för knivbladen
- 6 Skyddskåpa

SF

- 1+2 Kahva(1) + Lenkki kahva(2)
& Strömbrytare
- 3 Skyddskåpa
- 4 Elektrisk sladd med kontakt
- 5 Skyddsskena för knivbladen
- 6 Skyddskåpa

NL

- 1+2 Bedrijfschakelaar
(2-hand bediening)
- 3 Beschermschild
- 4 Netleiding met stekker
- 5 Veiligheidsmesbalk
- 6 Aanstootbeveiliging

GB

- 1+2 Operating Switches
(two-hand operation)
- 3 Hand Guard
- 4 Power Cord
- 5 Blade Safety Rail
- 6 Impact Protector

CZ

- 1+2 Rukojet s okrouhloú ochranou (1) +
Oblouková rukojet (2) s bezpečnostním
spínacem
- 3 Ochranný štít
- 4 Prívodní kabel se zástrčkou
- 5 Bezpečnostní nosníky nozu
- 6 Ochrana proti nárazu

N

- 1+2 Håndtak(1) + Bøylehåndtag(2)
& Bryter
- 3 Skjerm
- 4 Hoveledning med støpsel
- 5 Sikkerhetsskinne for knivblad
- 6 Beskyttelse mot støt

DK

- 1+2 Håndtag(1) + Bøjehåndtag(2)
& Afbryder
- 3 Værn
- 4 El-ledning med stik
- 5 Klingeværn
- 6 Støddæmper

D

- 1+2 Griff (1) und Bügelgriff (2)
mit Sicherheitsschalter
- 3 Schutzschild
- 4 Netzleitung mit Stecker
- 5 Sicherheitsmesserbalken
- 6 Anstoßschutz

F

- 1+2 Interrupteur
(maniement à 2 mains)
- 3 Bouclier de protection
- 4 Câble de secteur avec connecteur
- 5 Couteaux de sécurité
- 6 Butée de protection

PL

- 1+2 Uchwyt z przełącznikiem (1)+ Uchwyt
kablakowy z przełącznikiem (2) bezpie-
czeństwa
- 3 Tarcza ochronna
- 4 Kabel przyłączeniowy z wtyczka
- 5 Belka z nozami
- 6 Ochrona przed uderzaniem

Illustrasjon og forklaring av symboler
Piktogramillustration og forklaring
Illustration och förklaring av piktogramen
Symbolien selitykset
Afbeelding en toelichting van de pictogrammen
Abbildung und Erklärung der Piktogramme
Pictogram illustration and explanation
Représentation et explication des pictogrammes
Vyobrazení a vysvětlivky k typovému štítku
Ilustracja i objaśnienia piktogramów



1



2



3



4



5

S

- 1 Bär alltid ögon- och hörselskydd!
- 2 Varning!
- 3 Läs bruksanvisningen före användning!
- 4 Använd inte detta eldrivna redskap i fuktig väderlek!
- 5 Ta genast bort kontakten om sladden skadas eller går av!

SF

- 1 Käytä aina allmä- ja kuulosuojaimia!
- 2 Varoituis!
- 3 Lue käyttöohjeet ennen käyttöä!
- 4 Älä käytä tätä sähkökäyttöistä työvälinettä märällä ilmalla!
- 5 Irrota pistoke välittömästi, jos verkkojohto on vaurioitunut tai katkennut!

NL

- 1 Gehoor- en oogbeveiliging dragen!
- 2 Waarschuwing!
- 3 Leest U de gebruiksaanwijzing, a.u.b.
- 4 Dit elektrowerktuig niet aan de regen onderwerpen!
- 5 Bij beschadiging of doorsnijden van de aansluitingsleiding dadelijk de stekker uittrekken!

GB

- 1 Wear eye and ear protection!
- 2 Warning!
- 3 Read the instruction manual !
- 4 Do not use tool in under wet weather conditions!
- 5 Unplug immediately if the power cord or plug becomes damaged !

CZ

- 1 Používejte ochranu zraku a sluchu!
- 2 POZOR!
- 3 Čtěte návod k použití !
- 4 Nepoužívejte zařízení ve vlhku!
- 5 Okamžitě odpojte zařízení od sítě v případě, že je přírodní kable poškozen nebo přerušen!

N

- 1 Bruk alltid øye- og hørselsvern!
- 2 Advarsel!
- 3 Les bruksanvisningen før bruk!
- 4 Ikke bruk dette elektriske redskapet i fuktig vær!
- 5 Trekk øyeblikkelig støpselet ut hvis ledningen er skadet!

DK

- 1 Brug altid beskyttelsesbriller og høreværn !
- 2 Advarsel!
- 3 Læs instruktionerne, inden maskinen tages i brug!
- 4 Brug ikke dette elektriske apparat i fugtigt vejr!
- 5 Tag stikket ud, hvis ledningen bliver beskadiget eller klippet over!

D

- 1 Augen- und Gehörschutz tragen!
- 2 Warnung!
- 3 Gebrauchsanweisung lesen!
- 4 Dieses Elektrowerkzeug nicht dem Regen aussetzen
- 5 Bei Beschädigung oder Durchschneiden der Anschlußleitung sofort Stecker ziehen!

F

- 1 Porter des protections des yeux et des oreilles!
- 2 Attention!
- 3 Lisez l'instruction de service!
- 4 Ne pas laisser cet outil électrique sous la pluie!
- 5 En cas de détérioration ou section du câble retirer immédiatement la prise!

PL

- 1 Nosić ochronniki słuchu i okulary ochronne.
- 2 Uwaga!
- 3 Przed użyciem przeczytać instrukcję obsługi.
- 4 Nie dopuszczać do kontaktu z wilgocią.
- 5 Odlączyć z sieci jeśli przewód połączeniowy jest uszkodzony lub przecięty

Hedge Trimmer

ENGLISH

1. Introducing the hedgetrimmer

Technical data		SH 60
Operating Voltage	V~	230
Nominal Frequency	Hz	50
Nominal Consumption	W	600
Mains Safety Fuse	A	16
Cutting movements	min ⁻¹	2400
Shear length	mm	600
Cutting Thickness	mm	27
Weight (without flex)	kg	3,6

Noise Pressure Level: L_{pA} 89 dB (A) according to EN 50144
Vibration: <2,5 m/s² according to EN 50144

2. General safety instructions

Machine noise information regulation 3, GSGV: the noise pressure level at the place of work can exceed 85 dB(A). In such cases the operator will require noise protection (e.g. wearing of ear protectors). **Attention:** Noise protection ! Please observe the local regulations when operating your device.

Interference suppressed in accordance with EN 55014, EN 61000-3-2:95, EN 61000-3-3:95 .

We reserve the right to make changes to the technical specifications. The hedge trimmers are constructed in line with the latest regulations in accordance with DIN-EN 50144-1 and DIN-EN 50144-2-15 and conform fully to equipment safety law regulations.



General safety instruction

Usage of hedge trimmer always involves a risk of accidents, therefore please observe the relevant accident prevention instructions.

The machine has been constructed according to the latest technology and in accordance with the recognised technical safety regulations. Nevertheless, use of the machine can involve risks to the user or third persons, and can cause damage to the machine or other objects.

Attention: Using electric power tools, you must observe following fundamental safety instructions to protect yourself against electric shock, against danger of injuries and danger of fire. Read all these instructions before using the hedge trimmer and observe them. Keep these

safety instructions at a safe place.

Use the machine in a safety conscious manner for suitable applications in a technically perfect condition only and with due regard to the operating instructions! **Immediately rectify or have rectified any faults which could adversely affect safety!**

This machine may cause serious injuries. Please read the instruction manual carefully as to the correct handling, the preparations, the maintenance and the proper use of the hedgetrimmer. Familiarize yourself with the machine before the first use and also have yourself introduced to practical use of the machine.



3. Application

The machine is only intended for trimming hedges. Use for any other purpose constitutes inappropriate use. The manufacturer / supplier is not liable for any injury and/or damage arising from inappropriate use. This risk is the sole responsibility of the user. Appropriate use of the machine also includes adherence to the operating instructions and compliance with the servicing and maintenance instructions.

Always keep the operating instructions close at hand during operation!

4. Safety instruction

1. Always disconnect the plug from the mains socket before carrying out any work on the equipment, before cleaning and before moving the equipment.



2. The use of hedge trimmers involves certain risks. Attention: Danger! Rotating machinery.

3. The hedge trimmer should always be held with both hands.

4. Before using the equipment clear the working area of any foreign objects and be aware of foreign objects during operation of the machine! If the machine becomes jammed e.g. by thick branches, switch off and disconnect the machine from the mains socket before investigating and rectifying the cause of the jam. Take special care when switching the machine on again.



5. Check the flex and all connections for any visible faults before using the machine (plug disconnected). Do not use a faulty flex.

6. Keep the flex away from the cutting area.



7. Do not use the trimmer in wet weather and do not use it to cut wet hedges. Do not wash down the device with water. Do not use any high-pressure cleaning devices or steam jet devices for cleaning

8. Carry the trimmer by the handles provided and keep hands away from the cutting blades.

9. In line with agricultural Trade Association Regulations only persons over the age of 17 may work on their own with electric hedge trimmers. Use is permitted for persons over 16 years if the work is carried out under the supervision of adults.

10. We would recommend that safety clothing is worn during the work and that eyes, ears, hair, hands and feet are fully protected. Protective gloves should also be worn.



11. Ensure that the motor of your hedge shears can not be switched on by mistake when you put it down after work or when you are going to clean the device. Never forget to unplug the mains supply!

12. Check the cutting unit regularly for damage and if damage is discovered, the cutting unit should be properly repaired.

13. Be aware of your responsibility as user towards third parties in the working area.

14. The trimmer must be properly checked

and serviced. If the blades get damaged they should only be exchanged in pairs. In the event of damage from impact, specialist's inspection is essential.

15. Only use extension leads which have been authorised for outside use. These flexes must not be lighter than PVC covered flex conforming to 227 IEC 53. They must be water spray protected. Damaged cables of this unit are only to be replaced by a service station designated by the manufacturer as special tools are necessary. Equipment which will be used in different outside locations should be connected via residual-current - operated current breakers.

16. Ensure that the equipment is stored safely after use in such a way that the blade cannot be touched.

17. When using the equipment, hold it securely with both hands, stand firmly and ensure that you have sufficient working space. There should be no people, animals or objects within the working area. Select the cutting height so that the blade does not make contact with the ground and you can operate the equipment from a secure position.

18. Take care when transporting the equipment (only with blade cover!).

19. For initial use of the hedge trimmer we would recommend that in addition to reading the operating instructions, you also seek a practical demonstration from an expert.

20. Always ensure that all protective devices and handles are properly fitted. Never attempt to use an incomplete machine.

21. The use of the hedgetrimmer is to be avoided if other persons, above all children, are within the working area.

22. Familiarize yourself with the working area and pay attention to possible dangers which you might not be able to hear due to the noise of the machine.

5. Before use

Mounting the bow-type handle (Fig. 1)

If there are screws fixed to the mounting points, remove these first. Then, remove the shear protector and put the bow-type handle from the front (as shown in Fig. 1) over the shearing system, and put it into the relief of the hedge shears' hou-

sing. (If necessary, pull the lower ends of the handle slightly apart.) Take care that you do not squeeze the two parts of the bow-type handle. To fasten the bow-type handle screw the two included screws through the openings in the handle into the threaded holes of the housing and fasten them tightly. After fastening the handle, remove the transportation protection (scotch tape).

Protection shield (Fig. 2)

If screws are fastened to the bottom plate, remove these. Fasten the hand protector with the two included screws to the bottom plate.

Power connection

The machine can only be connected to a single-phase a.c. current connection. The machine is protectively insulated in accordance with classification II of VDE 0740 and can therefore be connected to sockets without earth connections. Before using the machine ensure that the mains current agrees with the operating voltage data on the machine's identification plate.

Power circuit breaker:

Machines which will be used in different outside locations must be connected to a Power circuit breaker.

Securing the extension lead (Fig. 5)

Only use extension leads suitable for outside use. The cross section of the wire (max. length of extension cord: 75m) must be at least 1,5 mm². Secure the equipment flex to the extension lead by means of a loop (Fig. 5).

Extension leads longer than 30 m will reduce the performance of the machine.

6. Instructions for use of the equipment

Do not use the trimmer in rain or for cutting wet hedges!

Check the hedge trimmer flex and its connections before each and every use for visible signs of damage (disconnect the power plug)! Do not use a faulty flex.

Gloves:

Protective gloves must be worn when using the hedge trimmer.

7. Maintenance

Always disconnect the plug from the power socket before commencing any work on the machine.

Important: Always clean and oil the blades after prolonged use of the hedge trimmer. This will greatly affect the life of the equipment. Damaged cutting units must be properly repaired immediately. Clean the shearing blades with a dry cloth or – in case of heavier dirt – with a brush.

Attention: Danger of injury! Oiling of the blades should ideally be carried out using an environmentally friendly lubricant (Fig. 6).

Sharpening of the blades

The blades generally do not need servicing and do not require reshaping if used correctly. In order to prevent injuries caused by the blades when not in use, the sharpened cutting blade should be covered by the blade cover (Fig. 4). The blades cannot be sharpened by the user without opening the equipment and the safety mechanism. Reshaping of the blades can therefore only be carried out at a specialist workshop.

Changing the blades

Only correct installation of the blades will guarantee problem-free operation and function of the above mentioned safety feature of the blades. Changing of the blades should therefore only be carried out at a specialist workshop.

8. Holding the hedge trimmer when in use

(Fig. 7)

This equipment will enable you to cut or trim bushes and hedges easily and comfortably.

Trimming of hedges

- Young shoots are best cut in a scythe movement.
- Older and stronger hedges are best cut in a sawing movement.
- Branches, which are too thick for the hedge trimmer, should be cut with a saw.
- Sides of hedges should be cut upwards in a taper.

In order to achieve an even height

- Fix a guide line at the required height.
- Cut evenly over this guide line.

9. Optimum safety

The 5 special features two-hand safety switch, quick blade stop, protective cover, blade safety rail and impact protector are fitted to provide the hedge trimmer with optimum safety features.

Two-hand safety switch (Fig. 3)

To switch on the hedge shears one of the switch bars on the hand grip (A or B) and the switch on the bow-type handle (C) must be held down. If one of the switches is released, the shearing blades will stop after ca. 0.2 seconds.

Expanded working height: If you want to reach higher or if you to above your head's height (see Fig. 8), you should take care of the following:



Attention: Take care to have a secure and safe standing position when working with your hedge shears in order to avoid slipping and injury. Always keep the shearing blades away from your body.

Quick blade stop

In order to avoid injuries through cuts, the blade will stop in max. 0.2 sec. when one of the two switches is released.

Blade safety rail (Fig. 4)

The cutting blade set back from the blade housing reduces the risk of injuries due to unintentional body contact. As soon as the hedge trimmer is switched off, the sharp cutting blades will stop - due to safety reasons - exactly under the cover rail in order to reduce the risk of injuries during transport.

Impact protector (Fig. 9)

The extended guide rail prevents unpleasant shocks (blade recoil) being transmitted to the operator due to impact with solid objects (wall, ground etc.).

Gear protection feature

If solid objects are caught in the cutting blade and jam the motor, switch off the machine at once, disconnect the power plug from the power socket, remove the object and continue with the work.

The equipment is also fitted with an overload cut-out, which protects the gears against mechanical damage in the event of blade jams.

10. Storing the trimmer after use

The hedge shears must be stored such that there is no danger of injuries being caused to persons by the cutting blades!

Important note: The shearing blades should be cleaned after each use. (see also Section 7, Maintenance). This will considerably increase the service life of the device. Please use a lubricator

that is not harmful to the environment, e. g. our service spray. Then put the shears in their case with the cutting blades first.

11. Repair service

Repairs to electric power tools should only be carried out by specialist electrical personnel.

NL

EG-Conformiteitsverklaring
overeenkomstig EG-machinerichtlijn **98/37/EG**



Wij, **STIGA AB, SE-57328 - TRANÅS / SWEDEN**, verklaren enig in verantwoording, dat het product Hegggeschaar **SH 60** (EHT 600 Profi), waarop deze verklaring betrekking heeft, beantwoordt aan de van toepassing zijnde fundamentele veiligheids en gezondheidseisen van de Richtlijn **98/37/EG** (EG-machinerichtlijn), **89/336/EEG** (EMV-Richtlijn), **73/23/EEG** (neerspanningsrichtlijn) en **2000/14/EG** (geluidsrichtlijn). Voor de desbetreffende tenuitvoerlegging van de in de Richtlijnen genoemde veiligheids- en gezondheidseisen is rekening gehouden met de volgende normen en/of technische specificaties: **EN 774, EN 50144-1, EN 50144-2-15, EN 55014-1, EN 55014-2, EN 61000-3-2, EN 61000-3-3**.

Gemeten geluidsvermogensniveau * 96 db (A) * De bevoegde dienst: DPLF, D-34114 Kassel
Gegarandeerd geluidsvermogensniveau * 98 db (A)

Tranås, 22.03.2002

Åke Winbladh, Teknisk Direktör.

D

EG-Konformitätserklärung
entsprechend der EG-Maschinenrichtlinie **98/37/EG**



Wir, **STIGA AB, SE-57328 - TRANÅS / SWEDEN**, erklären in alleiniger Verantwortung, daß das Produkt Heckenscherer **SH 60** (EHT 600 Profi), auf das sich diese Erklärung bezieht, den einschlägigen Sicherheits- und Gesundheitsanforderungen der EG-Richtlinie **89/336/EEG** (EMV-Richtlinie), **73/23/EEG** (Niederspannungsrichtlinie), **98/37/EG** (EG-Maschinenrichtlinie) und **2000/14/EG** (Geräuschrictlinie) entspricht. Zur sachgerechten Umsetzung der in den EG-Richtlinien genannten Sicherheits- und Gesundheitsanforderungen wurden folgende Normen und/oder technische Spezifikation(en) herangezogen: **EN 774, EN 50144-1, EN 50144-2-15, EN 55014-1, EN 55014-2, EN 61000-3-2, EN 61000-3-3**.

gemessener Schalleistungspegel * 96 dB (A) * Benannte Stelle: DPLF, D-34114 Kassel
garantierter Schalleistungspegel * 98 dB (A)

Tranås, 22.03.2002

Åke Winbladh, Teknisk Direktör.

GB

EC Declaration of Conformity
according to EU Guideline of Machines **98/37/EG**



We, **STIGA AB, SE-57328 - TRANÅS / SWEDEN**, declare under our sole responsibility that the product Hedge Trimmer **SH 60** (EHT 600 Profi), to which this declaration relates correspond to the relevant basic safety and health requirements of Directives **98/37/EG** (Guideline of Machines) **89/336/EEC** (EMV-Guideline), **73/23/EEC** (Low Voltage Guideline) and **2000/14/EC** (Noise Directive). incl. modifications. For the relevant implementation of the safety and health requirements mentioned in the Directives, the following standards and/or technical specification(s) have been respected: **EN 774, EN 50144-1, EN 50144-2-15, EN 55014-1, EN 55014-2, EN 61000-3-2, EN 61000-3-3**.

measured acoustic capacity level * 96 dB(A) * Competent institution: DPLF, D-34114 Kassel
guaranteed acoustic capacity level * 98 dB(A)

Tranås, 22.03.2002

Åke Winbladh, Teknisk Direktör.

F

Déclaration de Conformité pour la CE
conforme à la directive CE sur les machines **98/37/EG**



Nous, **STIGA AB, SE-57328 - TRANÅS / SWEDEN**, déclarons sous notre seule responsabilité que les produits Taille-Haie **SH 60** (EHT 600 Profi), faisant l'objet de la déclaration sont conformes aux prescriptions fondamentales en matière de sécurité et de santé stipulées dans les Directives de la CEE **98/37/EG** (directive CE sur les machines), **89/336/CEE** (directive EMV), **73/23/CEE** (directive de basse tension) **2000/14/CE**. (directives en matière de bruit). Pour mettre en pratique dans les règles de l'art les prescriptions en matière de sécurité et de santé stipulées dans les Directives de la CEE, il a été tenu compte des normes et/ou des spécifications techniques suivantes: **EN 774, EN 50144-1, EN 50144-2-15, EN 55014-1, EN 55014-2, EN 61000-3-2, EN 61000-3-3**.

Niveau sonore mesuré * 96 dB (A) * Service compétent: DPLF, D-34114 Kassel
Niveau sonore garanti * 98 dB (A)

Tranås, 22.03.2002

Åke Winbladh, Teknisk Direktör.

NL

Garantievoorwaarden

Voor dit elektrisch apparaat geven wij onafhankelijk van de verplichtingen die de handelaar volgens de koopovereenkomst ten opzichte van de eindafnemer heeft, als volgt garantie:

De garantieperiode bedraagt 24 maanden en begint bij de overdracht, welke door een originele koopbon bewezen moet kunnen worden. Bij commerciële toepassing alsook bij verhuur is de garantie beperkt tot 6 maanden. Uitgezonderd van de garantie zijn de slijtbare onderdelen en de schades die ontstaan zijn door het gebruik van verkeerde accessoires, door reparaties met onderdelen die niet origineel bij dit apparaat horen, door gebruik van geweld, door slag en breuk, alsook door opzettelijke overbelasting van de motor. Inruil op basis van de garantie heeft enkel betrekking op de defecte onderdelen, niet op complete apparaten. Reparaties die met de garantie samenhangen, mogen alleen worden verricht door goedgekeurde werkplaatsen of door de klantenservice van de fabriek. Bij reparaties door anderen vervalt de garantie.

Portokosten, verzendkosten en bijkomende kosten komen ten laste van de koper.

D

Garantiebedingungen

Für dieses Elektrowerkzeug leisten wir unabhängig von den Verpflichtungen des Händlers aus dem Kaufvertrag gegenüber dem Endabnehmer wie folgt Garantie:

Die Garantiezeit beträgt 24 Monate und beginnt mit der Übergabe die durch Originalkaufbeleg nachzuweisen ist. Bei kommerziellem Einsatz sowie Verleih reduziert sich die Garantiezeit auf 6 Monate. Ausgenommen von der Garantie sind Verschleißteile und Schäden die durch Verwendung falscher Zubehörteile, Reparaturen mit Nichtoriginalteilen, Gewaltanwendungen, Schlag und Bruch sowie mutwillige Motorüberlastung entstanden sind. Garantieaustausch erstreckt sich nur auf defekte Teile, nicht auf komplette Geräte. Garantiereparaturen dürfen nur von autorisierten Werkstätten oder vom Werkskundendienst durchgeführt werden. Bei Fremdeingriff erlischt die Garantie.

Porto, Versand- und Nachfolgekosten gehen zu Lasten des Käufers.

GB

Warranty

For this electric tool, the company provides the end user - independently from the retailer's obligations resulting from the purchasing contract - with the following warranties:

The warranty period is 24 months beginning from the hand-over of the device which has to be proved by the original purchasing document. For commercial use and use for rent, the warranty period is reduced to 6 months. Wearing parts and defects caused by the use of not fitting accessories, repair with parts that are no original parts of the manufacturer, use of force, strokes and breaking as well as mischievous overloading of the motor are excluded from this warranty. Warranty replacement does only include defective parts, not complete devices. Warranty repair shall exclusively be carried out by authorized service partners or by the company's customer service. In the case of any intervention of not authorized personnel, the warranty will be held void.

All postage or delivery costs as well as any other subsequent expenses will be borne by the customer.

F

Conditions de garantie

Indépendamment des obligations ressortant du contrat de vente conclu par le fournisseur avec le consommateur final, nous accordons pour cet appareil électrique la garantie suivante :

La période de garantie est de 24 mois et entre en vigueur à la remise de l'outil qui sera justifiée par présentation du bon d'achat original. En cas d'utilisation commerciale ou de location, la période de garantie se limite à 6 mois. Les pièces d'usure et les dommages dus à l'utilisation de pièces non conformes, à des réparations effectuées avec des pièces non originales, à l'exercice de la force, à des coups, une destruction ou une surcharge intentionnelle du moteur sont exclus de la garantie. Les échanges sous garantie ne concernent que les pièces défectueuses et non les appareils complets. Les réparations sous garantie ne peuvent être effectuées que par des ateliers autorisés ou par le service après-vente de l'usine. La garantie s'éteint en cas d'intervention étrangère au fournisseur agréé.

Les frais de port, d'expédition et autres frais annexes sont à la charge du client.

Free Manuals Download Website

<http://myh66.com>

<http://usermanuals.us>

<http://www.somanuals.com>

<http://www.4manuals.cc>

<http://www.manual-lib.com>

<http://www.404manual.com>

<http://www.luxmanual.com>

<http://aubethermostatmanual.com>

Golf course search by state

<http://golfingnear.com>

Email search by domain

<http://emailbydomain.com>

Auto manuals search

<http://auto.somanuals.com>

TV manuals search

<http://tv.somanuals.com>