

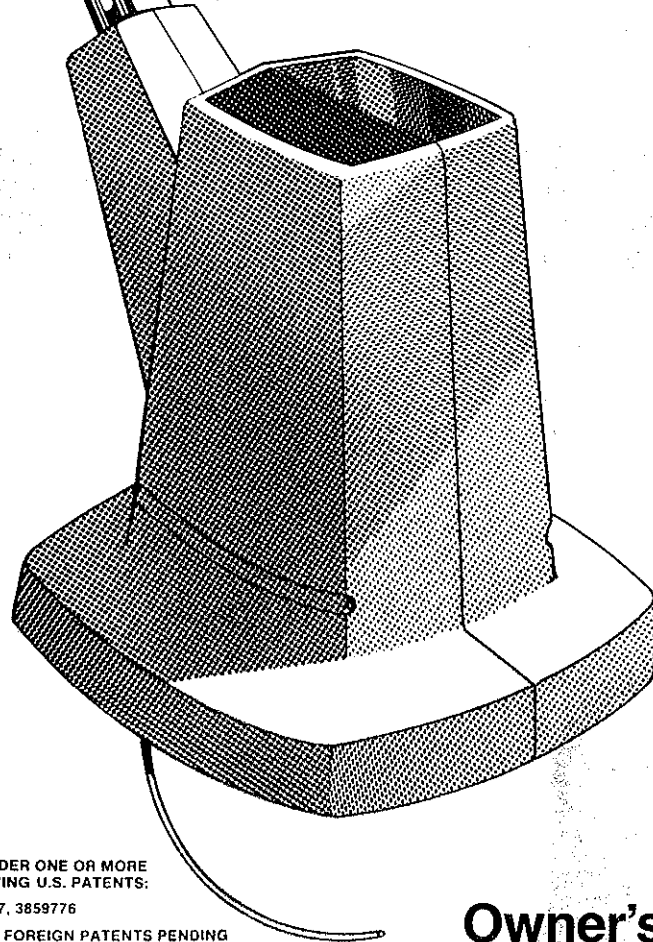

# WEED EATER

TRADEMARK ®

NEEDIE® model 507  
16" trimmer/edger



PROTECTED UNDER ONE OR MORE  
OF THE FOLLOWING U.S. PATENTS:  
3826068, 3708967, 3859776  
OTHER U.S. AND FOREIGN PATENTS PENDING

## Owner's Manual

88-029

This Product is Listed by  
UNDERWRITERS LABORATORIES INC.  
and Bears the Mark:



R0177

## NOTICE

**THIS MANUAL CONTAINS VERY IMPORTANT INFORMATION REGARDING SAFETY, ASSEMBLY, OPERATION, AND CARE OF YOUR WEED EATER TRIMMER. PLEASE READ IT CAREFULLY BEFORE OPERATING.**



WEED EATER, INC. P.O. Box 37287, Houston, Texas 77036  
©Copyright 1976 Weed Eater, Inc.

## SAFETY PRECAUTIONS

1. Use only those accessories and attachments that come packed with the unit. The use of any other accessory or attachment may create a potential hazard.
2. Use only identical replacement parts when servicing the unit. These parts are available from your Weed Eater dealer. Repair or replace damaged electrical cord.
3. Avoid dangerous environments. Do not use the unit in damp or wet locations.
4. Do not use in the rain.
5. Dress properly. Do not wear loose clothing or jewelry that could be caught in the moving parts of the unit. It is recommended that the operator wear safety goggles, rubber gloves and footwear when working outdoors.
6. Keep children away. Onlookers should be kept at a safe distance from the work area, at least 30 feet.
7. Do not use this unit for any jobs other than those for which it is intended.
8. **WARNING.** To prevent shock hazard, use only an extension cord suitable for outdoor use. When selecting an extension cord, it is recommended that a minimum No. 16-gauge wire be used up to 100 feet and a No. 14-gauge wire be used for distances greater than 100 feet.
9. To prevent disconnection of the unit's power cord from the extension cord during operation, join the two together as shown in the operation instructions.
10. Avoid unintentional starting. Do not carry a plugged-in unit with your finger on the switch.
11. Do not abuse the electrical cord. Never carry the unit by the cord or yank the cord when disconnecting it from the receptacle. Keep cord away from heat, oil and sharp edges.
12. Do not force the unit. It will do the job better and safer at the rate for which it is designed to be used.
13. Do not overreach. Keep proper footing and balance at all times.
14. Always cut to the left side of the unit so that trimmings and debris will be thrown away from you.
15. Inspect the area to be cut and remove all debris that could become entangled in the cutting head. Also remove any objects that the unit may sling during cutting.
16. Disconnect the unit from the power supply when not in use, before servicing or when changing accessories, such as the spool.

## **SAFETY PRECAUTIONS CONTINUED**

17. When not in use, store the unit indoors in a high, dry or locked place and out of the reach of children.
18. Maintain the unit with care. Always keep the cutting line clipped to the proper length for best and safest performance. Follow instructions for changing accessories carefully.
19. Keep hands and feet clear of the rotating head while unit is in use.
20. Never submerge in water or douse unit to clean it.

## POINTS OF INTEREST

The patented WEED EATER idea of cutting grass with fishing line is revolutionary and has generated many questions from users of our products. We have answered several of the most common questions here. Should you have a question that is not answered here or elsewhere in this manual, please write Customer Service Department, Weed Eater, Inc., P.O. Box 37287, Houston, Texas 77037.

### **How long will the cutting line last?**

The life of the cutting line depends upon the type of surface against which you are cutting. The line is specially-treated for longer wear, but obviously it will wear faster when you are cutting against rocks, bricks, concrete, etc., than it will against wooden fences or trees.

### **Why doesn't my unit have a ground wire?**

Unlike many electrical appliances that have the three-pronged plug with a grounding wire, Weed Eater products are double-insulated for increased safety and do not require the grounding wire. Always use an extension cord of the proper wire gauge as outlined in Item 8 of the "Safety Precautions."

### **What would happen if I allowed the cutting line to exceed the recommended length?**

If the unit is run for any length of time with the line extended beyond the recommended length, motor damage will occur.

### **Can regular fishing line be used?**

Regular fishing line does not go through the special processing that Weed Eater monofilament does. It would give poor cutting performance and wear out very quickly.

### **Can piano wire or some other light wire be used?**

DEFINITELY NOT. When such wire becomes hot, it may break off and become a deadly projectile.

### **Why does the line pull out by itself?**

The line will pull out by itself if it is wound improperly on the spool. Check to be certain that the line is wound in the direction of the arrow on the spool. A worn spool may also cause the line to pull out by itself. Therefore, the spool should be checked regularly and replaced if necessary.

### **Will the cutting line scar a tree or wooden fence?**

Whether or not the line will scar an object depends upon a number of variables including the toughness of the tree bark or the fence. The operator's cutting technique is important to prevent scarring. Realize that *only the very tip* of the cutting line does the actual cutting. Absolutely no advantage is gained by forcing the unit into the work.

## **POINTS OF INTEREST CONTINUED**

### **Will I be cut if the line hits me?**

Extensive testing has proved that Weed Eater line is far safer than conventional metal blades. Should the line strike you, it probably would not cut through your clothing. Should the cutting line come in contact with your skin, it is possible that the skin could be broken. When operating any Weed Eater unit, you should be familiar with the safety precautions in the front of this manual and practice good common sense normally associated with the use of any cutting tool.

### **What is the purpose of the metal line savers?**

The monofilament line generates heat against the rotating head during operation and could "weld" to the exits. This "welding" would cause the cutting line to break frequently and also cause excessive wear at the head exits. The metal line savers are designed to dissipate this heat and thus prevent the "welding" effect.

## ASSEMBLY

You should familiarize yourself with the various parts of your Weed Eater trimmer prior to assembly and operation.

**NOTE:** Carefully inspect your trimmer for possible shipping damage.

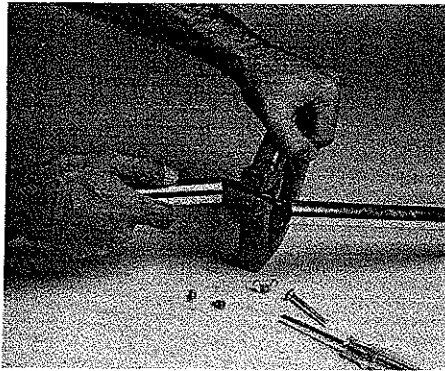
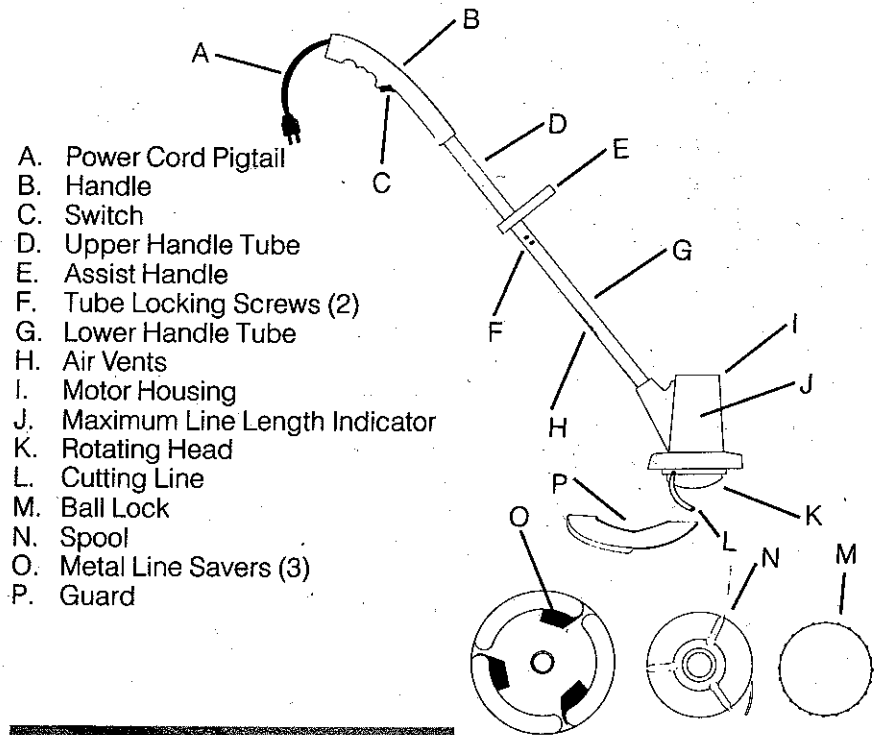

FIGURE 1

1. Insert wiring harness through the slot in the assist handle (Figure 1) and slide it onto the upper handle tube. Insert bolt in assist handle and tighten with wing nut.

**NOTE:** The grip notches on the assist handle should face toward the motor housing.

## ASSEMBLY CONTINUED

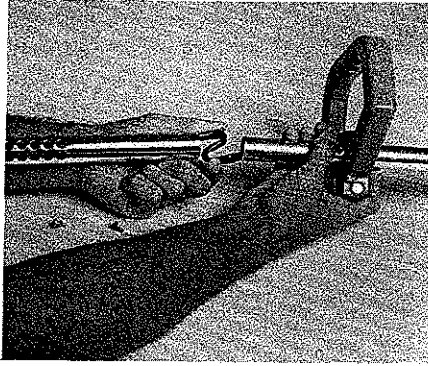

FIGURE 2

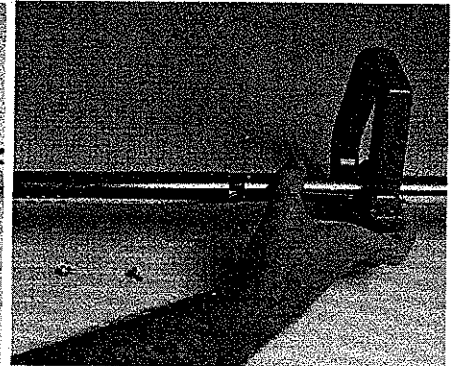

FIGURE 3

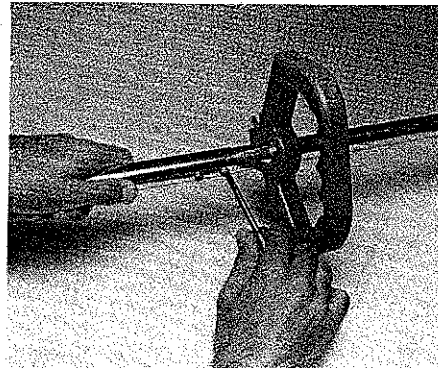

FIGURE 4

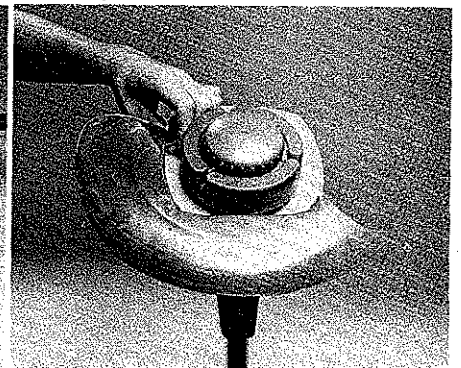

FIGURE 5

2. Form an "S" shape with the excess harness. Figure 2
3. Push the harness and upper handle tube into the lower tube. Figure 3
4. Adjust the two tubes until the locking screw holes align and insert the screws. Tighten the screws with a screwdriver. Figure 4
5. Place the guard with the three mounting tabs on the inside of the bottom flange of the housing. Insert the screws from the inside of the flange. Figure 5. Place the nuts on the outside and tighten.



## OPERATION



FIGURE 6

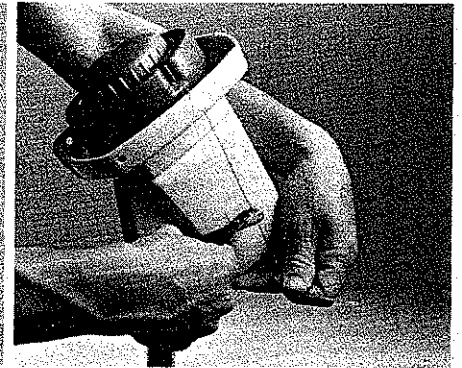

FIGURE 7

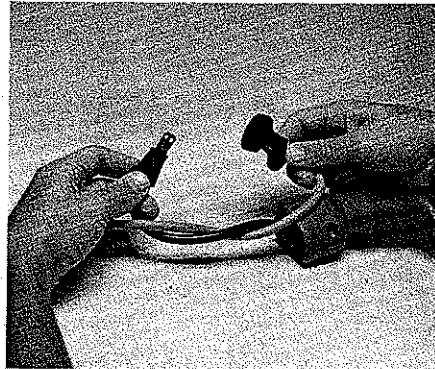

FIGURE 8

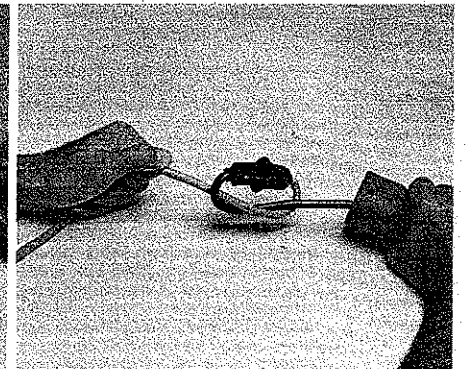

FIGURE 9

1. Before operating the unit, be sure the cutting line is the proper length.
  - A. Hold the rotating head securely with one hand.
  - B. Pull the cutting line up and to the left (counterclockwise) to the next exit in the head. Figure 6
  - C. Holding the line tight, clip off the excess line at the point indicated on the motor housing. Figure 7

**NOTE:** When guard is in place, your line should not extend beyond the outside edge of the guard.

**CAUTION:** Always maintain proper line length to prevent permanent damage to the motor.

2. The power cord pigtail may be secured to your extension cord by tying the two together. Figures 8 and 9

## OPERATION CONTINUED



FIGURE 10

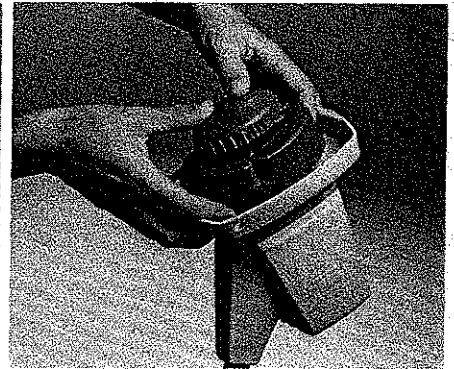

FIGURE 11

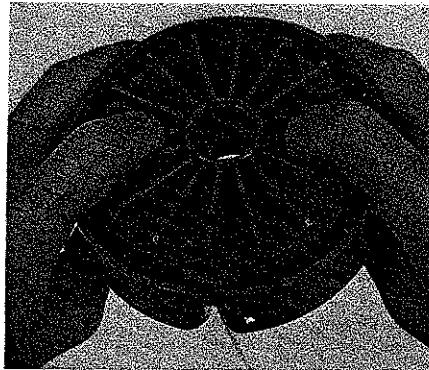

FIGURE 12

3. When it becomes necessary to remove or rewind the line spool, the following procedure should be used.
  - A. Hold the rotating head securely with one hand. With the other hand, turn the ball lock to the left (counterclockwise) and remove. Figure 10
  - B. The hub containing the spool should simply lift off the drive adapter. If you have difficulty removing the hub from the drive adapter, replace the ball lock as illustrated in Figure 11 and lift the hub.
  - C. Push out the spool by applying pressure with your fingers through the two holes located on top of the hub. Figure 12
  - D. To rewind the spool, insert the end of the line in the hole located within the spool and wind in the direction indicated by the arrow on the spool (clockwise).

**NOTE:** The spool may be rewound with line many times. However, some wear is to be expected and therefore the spool should be replaced periodically. Extra cutting line and spools are available from your Weed Eater dealer.

- E. To replace the spool, insert it in the hub on the drive adapter and tighten the ball lock.

## OPERATION CONTINUED

**NOTE:** Spool ridges must align with the exits in the head.

4. Before trimming, inspect your cutting area for wires, cord or other debris that could get tangled in the rotating head.
5. Protective eyewear should be worn to prevent the possibility of dust or clippings being blown into your eyes. Weed Eater safety goggles are available from your dealer.

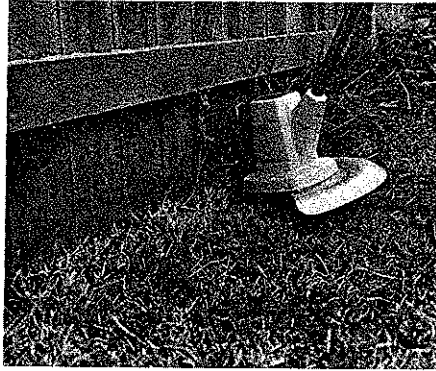

FIGURE 13



FIGURE 14



FIGURE 15



FIGURE 16

6. **TRIMMING:** Always cut to the left side of the unit, using a 30-degree tilt. Figure 13. Cutting to the left will cause clippings to be thrown forward, away from you. If you cut to the right side, clippings will be thrown back toward you. The correct trimming position is illustrated in Figure 14.
7. **MOWING:** Needlé is ideal for use in areas conventional lawn mowers can not reach. The proper position for mowing is shown in Figure 15. In this position the cutting line is parallel to the ground. With practice, this technique will produce as neat a job as a lawn mower. Figure 16.

## OPERATION CONTINUED

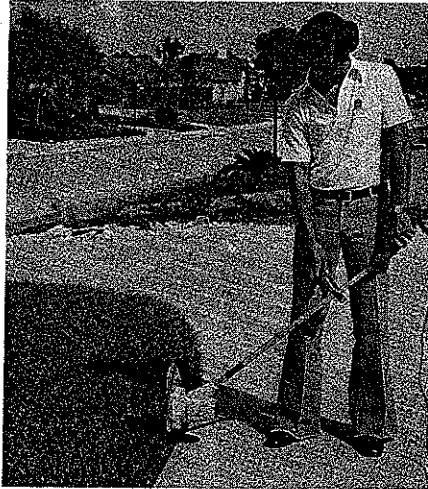

FIGURE 17

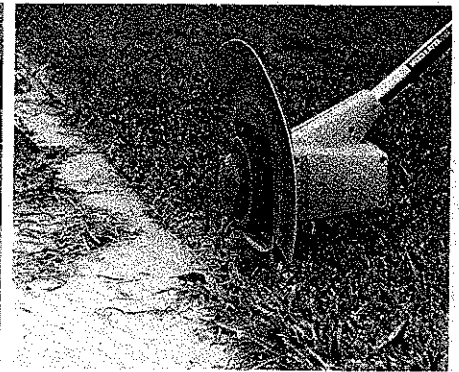

FIGURE 18

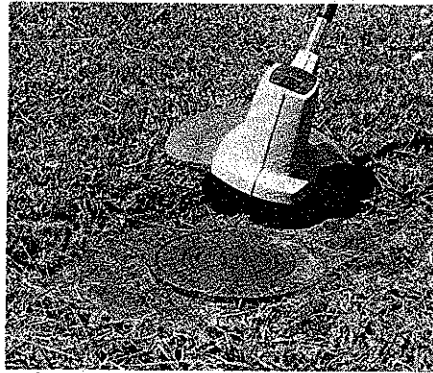

FIGURE 19



FIGURE 20

8. **EDGING:** By adjusting the assist handle to the position shown in Figure 17 your Needle will produce the results illustrated in Figure 18.
9. **SCALPING:** A variation of the trimming technique used to remove all vegetation from around meters, poles, trees, etc. Figure 19.
10. **SWEEPING:** For a fast clean-up you can use your unit to sweep clippings from walks and driveways. Move the unit in a sweeping motion, parallel to the pavement, blowing debris ahead of you as shown in Figure 20.

## OPERATION CONTINUED

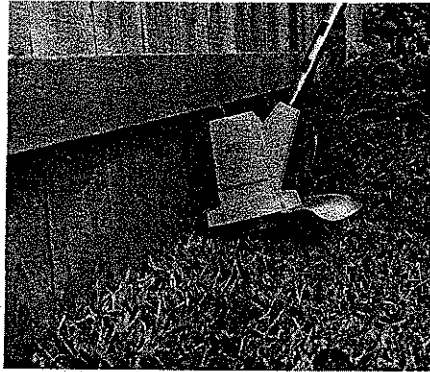

FIGURE 21  
WRONG

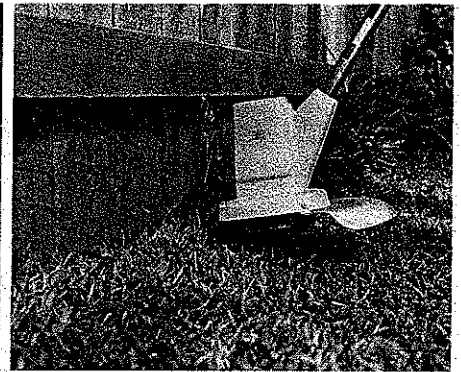
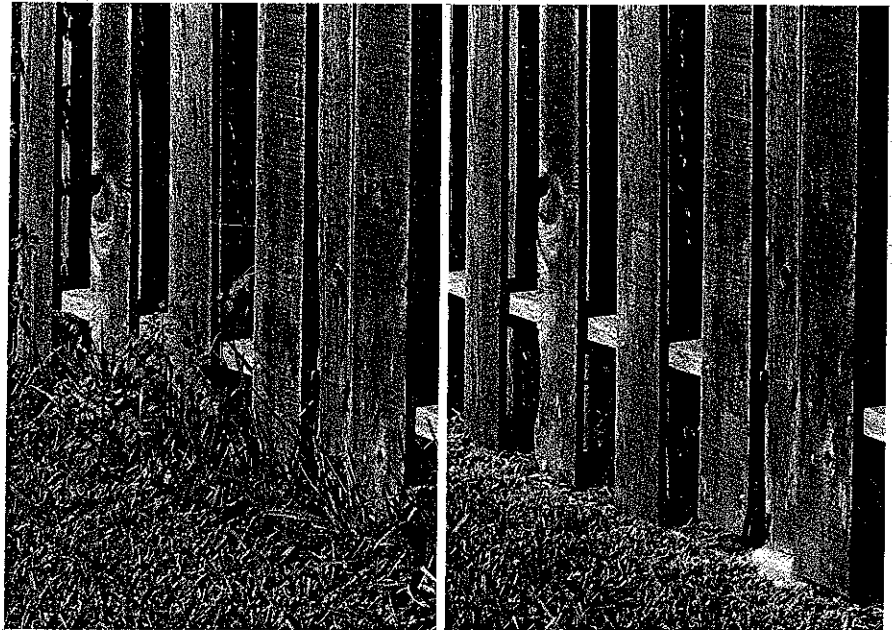

FIGURE 22  
RIGHT

11. Always remember the tip of the line does the cutting. You will achieve better results and reduce excessive line wear by not crowding the head into the cutting area. Do not force the unit. The Needle will trim best at its own pace. The correct and incorrect technique is shown in Figures 21 and 22.

## OPERATION CONTINUED

"Practice makes perfect" is the case with all Weed Eater products, including Needie. The longer you work with it the better you will become at obtaining the results illustrated below.



(BEFORE)

(AFTER)

Don't be overly conservative about using up your cutting line. When cutting efficiency seems to be lessening, check the line. If it is frayed, clip it off. In the long run, you'll be saving yourself a lot of time.

---

## MAINTENANCE

Your Weed Eater trimmer has been designed to give dependable service with a minimum of maintenance.

1. Weed Eater units are equipped with permanently lubricated bearings and therefore, never need oiling.
2. Remove the spool periodically to clean cutting debris from the rotating head.
3. Before operating, always check the unit for possible damage.
4. Keep the air vents free of clippings which may restrict proper ventilation.
5. Grass stains may be removed with a mild detergent solution and sponge.

**CAUTION:** Never use a petroleum based solvent or cleaner. Never submerge or douse with water or other liquid.

# NEEDIE® MODEL 507

## Motor Housing, Handle, Tubes & Head Assembly

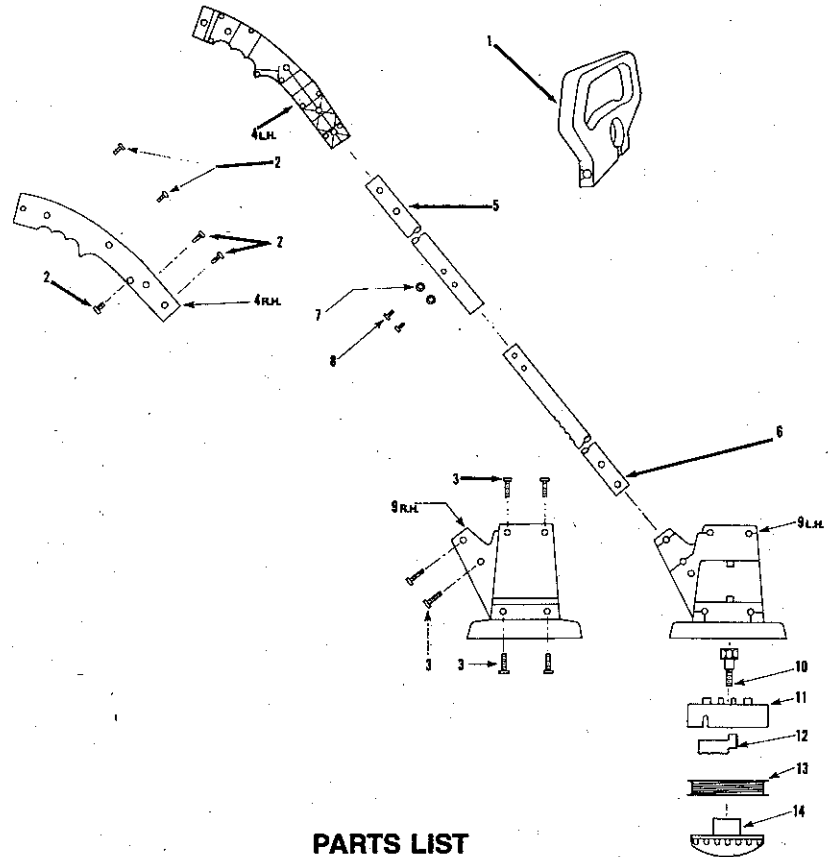

### PARTS LIST

ITEM	P/N	DESCRIPTION	QTY.
1	5079	Assist Handle	1
2	5029	Screw, Pan Head, 8-18 x 5/8"	5
3	5077	Screw, Pan Head, 8-18 x 1"	6
4	5162	Handle Set (offered as set only)	1
5	5078	Tube, Upper	1
6	5080	Tube, Lower	1
7	5036	Washer, Lock	2
8	5101	Screw, Hex Head	2
9	5156	Needie Housing (offered as set only)	1
10	5051	Drive Adapter	1
11	5355	Needie Body	1
12	5357	Line Saver	3
13	5356	Spool, Empty	1
14	5050	Ball Lock	1

Replacement spool (Part number 1049) is available from your Weed Eater dealer.

# NEEDIE® MODEL 507

## Harness Breakdown & Motor Assembly

### PARTS LIST

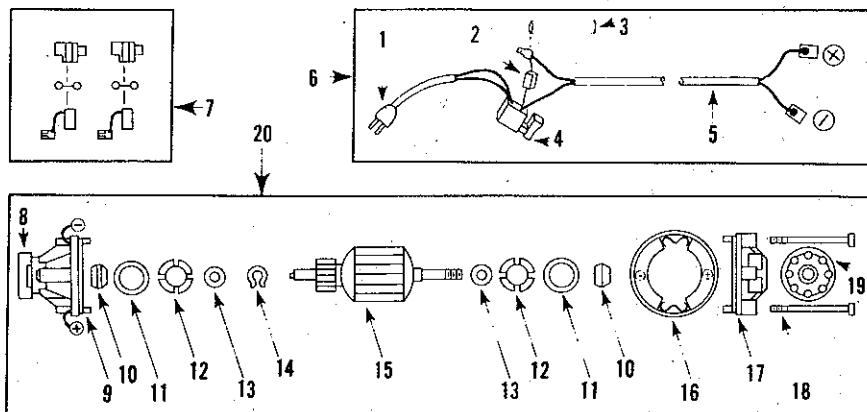

ITEM	P/N	DESCRIPTION	QTY.
1	5028	Plug, Pigtail	1
2	5096	Rectifier, Diode	1
3	5084	Sleeve (insulator)	1
4	5030	Switch	1
5	5083	Harness	1
6	5082	Harness Assembly (complete)	1
7	5441	Brush Kit	1
8	5090	Insulator	1
*9	5092	End Bell, Brush (End bells offered as set only)	1
10	5075	Bearing, Self Align	2
11	5098	Felt Oiler Washer	2
12	5097	Retainer, Bearing	2
13	5100	Washer, Thrust	as needed
14	5135	Retaining Ring	1
15	5089	Armature	1
16	5091	Field Assembly	1
*17	5092	End Bell, Output (offered as set only)	1
18	5099	Screw, Pan Hd., 10x32x3 <sup>1</sup> / <sub>8</sub> "	2
19	5086	Shaft Insulator	1
20	5088	Motor Assembly (complete)	1
*	5092	End Bell Set (without bearings)	
*	5161	End Bell Set (complete)	



## Free Manuals Download Website

<http://myh66.com>

<http://usermanuals.us>

<http://www.somanuals.com>

<http://www.4manuals.cc>

<http://www.manual-lib.com>

<http://www.404manual.com>

<http://www.luxmanual.com>

<http://aubethermostatmanual.com>

Golf course search by state

<http://golfingnear.com>

Email search by domain

<http://emailbydomain.com>

Auto manuals search

<http://auto.somanuals.com>

TV manuals search

<http://tv.somanuals.com>