

# WEED EATER

® Trademark

ENGLISH



Please do not return unit to retailer.  
Por favor, no devuelva el aparato al lugar de compra.  
Veuillez ne pas retourner l'outil au détaillant.  
**1-800-554-6723**  
[www.weedeater.com](http://www.weedeater.com)

## Instruction Manual Manual de Instrucciones Manuel d'Instructions

PE550

ESPAÑOL



### WARNING:

Read and follow all Safety Rules and Operating Instructions before using this product. Failure to do so can result in serious injury.

### ADVERTENCIA:

Lea el manual de instrucciones y siga todas las advertencias e instrucciones de seguridad. El no hacerlo puede resultar en lesiones graves.

### AVERTISSEMENT:

Lire le manuel d'instructions et bien respecter tous les avertissements et toutes les instructions de sécurité. Tout défaut de le faire pourrait entraîner des blessures graves.

---

WEED EATER  
1030 Stevens Creek Road  
Augusta, GA 30907

FRANÇAIS

545117552 Rev. 2 8/2/07 BRW

# SAFETY RULES

**⚠ WARNING:** When using gardening appliances, basic safety precautions must always be followed to reduce the risk of fire and serious injury. Read and follow all instructions. *This power unit can be dangerous!* Operator is responsible for following instructions and warnings on unit and in manual. Read entire instruction manual before using unit! Be thoroughly familiar with the controls and the proper use of the unit. Restrict the use of this unit to persons who have read, understand and will follow the instructions and warnings on the unit and in the manual. Never allow children to operate this unit.



INSTRUCTION  
MANUAL



SAFETY INFORMATION  
ON THE UNIT

## OPERATOR SAFETY

- Dress properly. Always wear safety glasses or similar eye protection when operating, or performing maintenance on your unit (safety glasses are available). Eye protection should be marked Z87.
- Always wear face or dust mask if operation is dusty.
- Always wear heavy, long pants, long sleeves, boots, and gloves. Do not go barefoot or wear sandals.
- Secure hair above shoulder length. Secure or remove loose clothing or clothing with loosely hanging ties, straps, tassels, etc. They can be caught in moving parts.
- Being fully covered also helps protect you from debris and pieces of toxic plants thrown by spinning blade.
- Stay alert. Do not operate when you are tired, ill, upset, or under the influence of alcohol, drugs, or medication. Watch what you are doing; use common sense.
- Wear hearing protection.
- Never start or run inside a closed room, building or other unventilated area. Breathing exhaust fumes can kill.
- Keep handles free of oil and fuel.
- Always use the handle.
- Keep hands and feet away from cutting area.
- Do not attempt to remove cut material nor hold material to be cut when engine is running or when cutting member is moving.
- Make sure spark plug is disconnected when cleaning jammed material from cutting member.
- Never direct discharge of material toward bystanders nor allow anyone near the area of operation. Use care in directing discharge to avoid glass enclosures, automobiles, and the like.





- Don't overreach or stand on unstable support. Keep good footing and balance at all times.

## UNIT SAFETY

- Inspect entire unit before each use. Replace damaged parts. Check for fuel leaks. Make sure all fasteners are in place and securely fastened.
- Maintain the unit according to recommended procedures.
- Throw away blades that are bent, warped, cracked, broken, or damaged in any other way. Replace parts that are cracked, chipped, or damaged before using the unit.
- Use only recommended WEED EATER parts and accessories. Never use wire, wire rope, string, flogging devices, etc.
- Disconnect the spark plug before performing maintenance except carburetor adjustments.
- Be sure the blade stops turning when the engine idles (see CARBURETOR ADJUSTMENTS).
- Remove the blade before making carburetor adjustments. Hold the unit by hand. Do not make carburetor adjustments from the blade side of the unit.
- Keep others away when making carburetor adjustments.
- Never start the unit with the gearbox removed. The clutch can fly off and cause serious injury.
- Have all maintenance and service not explained in this manual performed by an authorized service dealer.

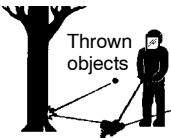
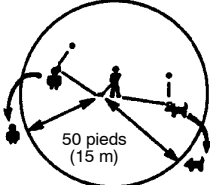
## EDGING SAFETY

- ⚠ WARNING:** Inspect the area to be edged before each use. Remove objects (rocks, broken glass, nails, wire, string, etc.) which can be thrown by the blade or can wrap around the shaft.
- Keep others including children, animals, bystanders, and helpers at least 50 feet (15 meters) away. Stop the unit immediately if you are approached.
  - Hold the unit firmly with both hands.
  - Keep firm footing and balance. Do not overreach or stand on unstable support.
  - Do not attempt to remove cut material nor hold material to be cut when the engine is running or when cutting member is moving.
  - Always keep the wheels and skid in contact with the ground.
  - Keep all parts of your body away from the blade and muffler.
  - Always push the unit slowly over the ground. Stay alert for uneven sidewalks, holes in the terrain, large roots, etc.
  - Use only for jobs explained in this manual.

 <p>Safety Glasses Boots</p>	 <p>Thrown objects</p>	<p><b>WARNING:</b></p> <ul style="list-style-type: none"> <li>Blade can throw objects violently.</li> <li>You can be blinded or injured.</li> <li>Wears safety glasses or similar eye protection.</li> </ul>
 <p>50 pieds (15 m)</p>	<p><b>WARNING:</b></p> <ul style="list-style-type: none"> <li>Hazard zone for thrown objects.</li> <li>Blade can throw objects violently.</li> <li>Others can be blinded or injured.</li> <li>Keep people and animals 50 feet (15 meters) away.</li> </ul>	
<p>Blade rotates momentarily after the trigger is released.</p> 	<p>Allow blade to stop before removing it from the cut.</p> 	<p><b>WARNING:</b></p> <ul style="list-style-type: none"> <li>Blade rotates momentarily after the trigger is released.</li> <li>The blade can seriously cut you or others.</li> <li>Allow blade to stop before removing it from the cut.</li> </ul>
 <p>Instruction Manual</p>	 <p>Safety Labels</p>	<p><b>WARNING:</b></p> <ul style="list-style-type: none"> <li>Read instruction manual.</li> <li>Follow all warnings and instructions.</li> <li>Failure to do so can result in serious injury.</li> </ul>

### FUEL SAFETY

- Mix and pour fuel outdoors and where there are not sparks or flames.
- Always store gasoline in a container approved for flammable liquids.
- Do not smoke or allow smoking near fuel or the unit; do not smoke while using the unit.
- Make sure the unit is properly assembled and in good operating condition.
- Avoid spilling fuel or oil. Wipe up all fuel spills before starting unit.
- Move at least 10 feet (3 meters) away from fueling site before starting engine.
- Stop engine and allow to cool before removing fuel cap.
- Do not store the unit with fuel in the fuel tank; use up fuel left in the carburetor and fuel line by starting the unit and letting it run until it stops.
- Store unit and fuel in an area where fuel vapors cannot reach sparks or open flames from water heaters, electric motors or switches, furnaces, etc.

### TRANSPORTING AND STORAGE

- Do not grasp or hold exposed blade.
- Stop unit before leaving work area.
- Allow unit to cool, run fuel out of the fuel tank, and secure the unit before storing or transporting it in a vehicle.
- Before storing, use up fuel left in the carburetor by starting the unit and letting it run until it stops. Always allow the unit to cool before storage.

- Store unit and fuel in area where fuel vapors cannot reach sparks or open flames from water heaters, electric motors or switches, furnaces, etc.
- Store unit so blade cannot accidentally cause injury.
- Store unit out of reach of children.

If situations occur which are not covered in this manual, use care and good judgment. If you need assistance, call 1-800-554-6723.

**SPECIAL NOTICE:** This unit is not equipped with a temperature limiting muffler and spark arresting screen which meets the requirements of California Codes 4442 and 4443. All U.S. forest land and the states of California, Idaho, Maine, Minnesota, New Jersey, Oregon, and Washington require by law that many internal combustion engines be equipped with a spark arrestor screen. If you operate in a locale where such regulations exist, you are legally responsible for installing and maintaining the operating condition of these parts. Failure to do so is a violation of the law. If a spark arresting screen is required in your area, contact your authorized service dealer for the correct kit.

**SPECIAL NOTICE:** Exposure to vibrations through prolonged use of gasoline powered hand tools could cause blood vessel or nerve damage in the fingers, hands, and joints of people prone to circulation disorders or abnormal swellings. Prolonged use in cold weather has been linked to blood vessel damage in otherwise healthy people. If symptoms occur such as numbness, pain, loss of

strength, change in skin color or texture, or loss of feeling in the fingers, hands, or joints, discontinue the use of this tool and seek medical attention. An anti-vibration system does not guarantee the avoidance of these problems. Users who operate power tools on a

continual and regular basis must monitor closely their physical condition and the condition of this tool.

## SAVE THESE INSTRUCTIONS

### ASSEMBLY

**WARNING:** If received assembled, repeat all steps to ensure your unit is properly assembled and all fasteners are secure. Examine parts for damage. Do not use damaged parts.

**NOTE:** If you need assistance or find parts missing or damaged, call 1-800-554-6723.

This instruction manual has been developed to help you assemble the unit and to provide its safe operation. It is important that you read the entire manual to become familiar with the unit *before* you begin assembly.

**Read your instruction manual.**

**Tools you will need:**

- Adjustable wrench
- Hex wrench (provided)

#### TUBE ASSEMBLY

**NOTE:** When performing the following step, be sure the handle is aligned as follows: label on top, throttle trigger to the operator's right hand side. *The starter rope and the throttle cable must not wrap around the tube.*

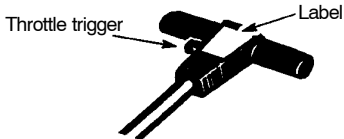

1. Assemble handle tube to the lower tube (it will be necessary to pull some of the starter rope out of the housing).
2. Align the screw holes; insert the screws through the aligned holes.

3. Thread one locknut onto each screw and tighten securely.

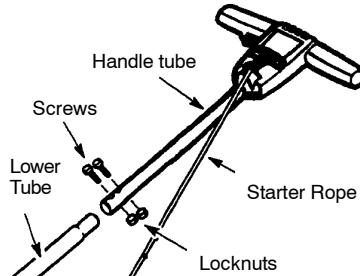

**NOTE:** When performing the following step, be sure the starter rope is not caught under the cable clamp. The starter rope must hang freely to operate properly.

4. Align the cable clamp between the tube screws. Install the cable clamp around the tube and throttle cable.

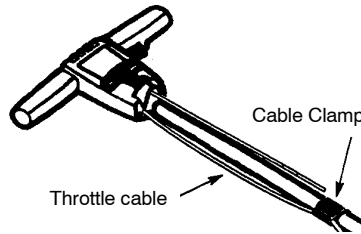

# OPERATION

## KNOW YOUR EDGER

READ THIS INSTRUCTION MANUAL AND SAFETY RULES BEFORE OPERATING YOUR UNIT. Compare the illustrations with your unit to familiarize yourself with the location of the various controls and adjustments. Save this manual for future reference.

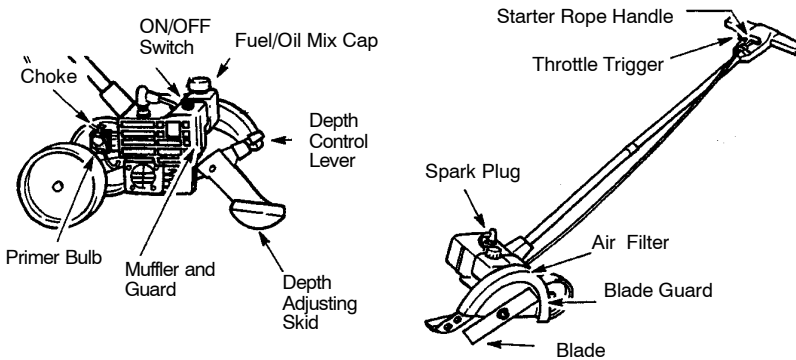

### ON/OFF SWITCH

The ON/OFF switch is used to select the ON or OFF position.

### STARTER ROPE HANDLE

The STARTER ROPE HANDLE is used for starting the engine.

### PRIMER BULB

The PRIMER BULB removes air from the carburetor and fuel lines and fills them with fuel. This allows you to start the engine with fewer pulls on the starter rope. Activate the primer bulb by pressing it and allowing it to return to its original form.

### CHOKE

The CHOKE helps to supply fuel to the engine to aid in cold starting. Activate the choke by moving the choke lever to the FULL CHOKE position. After the engine attempts to start, move

the choke lever to the HALF CHOKE position. Once engine has started, move the choke lever to the OFF CHOKE position.

### THROTTLE TRIGGER

The THROTTLE TRIGGER controls engine speed. It is designed to be activated by the right hand.

### BLADE

The BLADE is designed to cut sod.

### DEPTH ADJUSTING SKID

The DEPTH ADJUSTING SKID sets the depth of the cut.

### DEPTH CONTROL LEVER

The DEPTH CONTROL LEVER regulates the cutting depth. Move the lever backward for full depth edging, forward for half depth edging.

## BEFORE STARTING ENGINE

**WARNING:** Be sure to read the fuel information in the safety rules before you begin. If you do not understand the safety rules, do not attempt to fuel your unit. Call 1-800-554-6723.

## FUELING ENGINE

**WARNING:** Remove fuel cap slowly when refueling.



### HELPFUL TIP

To obtain the correct oil mix ratio, pour 3.2 ounces of 2-cycle synthetic oil into one gallon of fresh gas.

This engine is certified to operate on unleaded gasoline. Before operation, gasoline must be mixed with a good quality synthetic 2-cycle air-cooled engine oil designed to be mixed at a ratio of 40:1. Poulan/Weed Eater brand synthetic oil

is recommended. Mix gasoline and oil at a ratio of 40:1. A 40:1 ratio is obtained by mixing 3.2 ounces (95 ml) of oil with 1 gallon (4 liters) of unleaded gasoline. DO NOT USE automotive oil or boat oil. These oils will cause engine damage. When mixing fuel, follow instructions printed on container. Once oil is added to gasoline, shake container momentarily to assure that the fuel is thoroughly mixed. Always read and follow the safety rules relating to fuel before fueling your unit.

### IMPORTANT

Experience indicates that alcohol blended fuels (called gasohol or using ethanol or methanol) can attract moisture which leads to separation and formation of acids during storage. Acidic gas can damage the fuel system of an engine while in storage. To avoid engine problems, empty the fuel system before storage for 30 days or longer. Drain the gas tank, start the engine and let it run until the fuel lines and carburetor are empty. Use fresh fuel next season. Never use engine or carburetor

cleaner products in the fuel tank or permanent damage may occur. See the STORAGE section for additional information.

### STOPPING YOUR ENGINE

- To stop a running engine, move the switch to the OFF position.
- If engine does not stop, move choke lever to FULL CHOKE position.

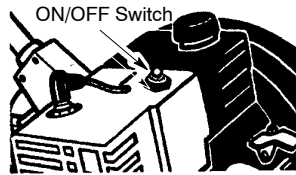

### STARTING YOUR ENGINE

(for location of controls, refer to the KNOW YOUR EDGER section)

- Fuel the engine; then move 10 feet (3 meters) away from the fueling site.

**⚠ DANGER:** The cutting blade will turn when the engine starts.

**⚠ WARNING:** Avoid any contact with the muffler. A hot muffler can cause serious burns.

- Rest the unit on the ground. Support the unit so the blade is off of the ground and away from trees, bushes, onlookers, etc.





**HELPFUL TIP**  
If your engine still does not start after following these instructions, please call 1-800-554-6723.

### STARTING A COLD ENGINE (or a warm engine after running out of fuel)

1. Move the ON/OFF switch to the ON position.
2. Slowly press the primer bulb 6 times.
3. Move choke lever to the FULL CHOKE position.

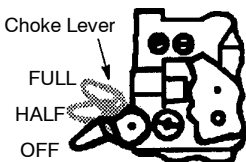

4. Squeeze and hold the throttle trigger. *Keep throttle trigger fully squeezed until the engine runs smoothly.*

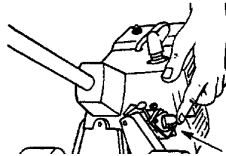

5. Pull starter rope handle sharply until engine sounds as if it is trying to start, but do not pull rope more than 6 times.
6. As soon as engine sounds as if it is trying to start, move choke lever to the HALF CHOKE position.
7. Pull starter rope sharply until engine runs, but no more than 6 pulls. If the engine doesn't start after 6 pulls (at the HALF CHOKE position), move the choke lever to the FULL CHOKE position and press the primer bulb 6 times. Squeeze and hold the throttle trigger and pull the starter rope 2 more times. Move the choke lever to the HALF CHOKE position and pull the starter rope until the engine runs, but no more than 6 pulls. **NOTE:** If engine still doesn't start, it is probably flooded. Proceed to STARTING A FLOODED ENGINE.
8. Once the engine starts, allow it to run 10 seconds, then move the choke lever to OFF CHOKE. Allow the unit to run for 30 more seconds at OFF CHOKE before releasing the throttle trigger. **NOTE:** If engine dies with the choke lever in the OFF CHOKE position, move the choke lever to the HALF CHOKE position and pull the rope until engine runs, but no more than 6 pulls.

### STARTING A WARM ENGINE

1. Move the ON/OFF switch to the ON position.
2. Move the choke lever to the HALF CHOKE position.
3. Squeeze and hold the throttle trigger. *Keep throttle trigger fully squeezed until the engine runs smoothly.*
4. Pull starter rope sharply until engine runs, but no more than 5 pulls.
5. Allow engine to run 10 seconds, then move the choke lever to the OFF CHOKE position. Release the throttle trigger.

**NOTE:** If engine has not started, pull starter rope 5 more pulls. If engine still does not run, it is probably flooded. Proceed to STARTING A FLOODED ENGINE.

### STARTING A FLOODED ENGINE

Flooded engines can be started by placing the choke lever in the OFF CHOKE position; then, pull the rope to clear the engine of excess fuel. This could require pulling the starter handle many times depending on how badly the unit is flooded.

If the unit still doesn't start, refer to TROUBLESHOOTING TABLE or call 1-800-554-6723.

## OPERATING INSTRUCTIONS

### EDGING

As you become familiar with your edger, you will be able to determine your own operating pace. Conditions such as depth of cut and material being cut will regulate the speed and time required for your edging job.

- Allow the engine to warm up for one minute before you begin edging.
- Increase the engine speed before placing the blade in the cut. For best operation, run the engine at full throttle while cutting.
- Keep your edging path straight by aligning the blade guide rib on the rear of the blade guard with the edge of the sidewalk. Keep all wheels flat on the walkway.

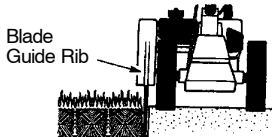

- Always work going away from people and solid objects such as walls, large stones, trees, automobiles, etc.
- Be careful when edging near trees or valuable plants. The high speed metal blade may cut roots and cause damage to the plants.
- If the blade stalls, immediately move the unit rearward slightly to allow the blade to restart. If the blade continues to stall, stop the engine, disconnect the spark plug, and inspect for blockage or damage.
- Always keep the blade area clean. Stop the engine, make sure the blade has completely stopped turning, and disconnect the spark plug before cleaning.

### SETTING THE EDGING DEPTH

**WARNING:** Never attempt to adjust the depth adjusting skid when the engine is running. Always release the throttle trigger, wait until the blade stops turning, move the

ON/OFF switch to the OFF position, and disconnect spark plug before making adjustments. Your edger is equipped with several edging depths. The depth used will depend on your personal edging preference and the condition of the area where the edging operation is to be done.

**NOTE:** If the area to be edged has never been cut or several weeks have passed since the last cut, the first edging should be done at no more than half depth.

#### To set the depth:

- Move the depth control lever forward for shallower edging.
- Move the depth control lever backward for deeper edging.

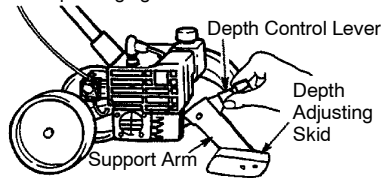

When edging, the trigger handle must be raised until the skid rests on the ground. The trigger handle must be held in the raised position during the entire edging operation to maintain a consistent edging depth.

#### DEPTH ADJUSTING SKID

The surface of the depth adjusting skid will wear over a period of time. This part is reversible to provide a second wear surface.

1. Remove the two mounting screws which hold the skid to the support arm.
2. Rotate the skid 180 degrees.
3. Reinstall the mounting screws.

#### EDGING TIPS

- Inspect unit before each use.
- Inspect the area to be cut before each use.
- Keep unit in front of your body.
- Cut at full throttle.
- Keep the wheels and skid in contact with the ground.
- Always work going away from others.

## MAINTENANCE

**WARNING:** Disconnect the spark plug before performing maintenance except for carburetor adjustments.

#### HELPFUL TIP

**IMPORTANT:** Have all repairs other than the recommended maintenance described in the instruction manual performed by an authorized service dealer.

If any dealer other than an authorized service dealer performs work on the product, WEED EATER may not pay for repairs under warranty. It is your responsibility to maintain and perform general maintenance.

#### GENERAL RECOMMENDATIONS

The warranty on this unit does not cover items that have been subjected to operator abuse or negligence. To receive full value from the warranty, the operator must maintain unit as instructed in this manual. Various adjustments will need to be made periodically to properly maintain your unit.

- Once each year, replace the spark plug, replace air filter element and check blade for wear. A new spark plug and a clean/new air filter element assures proper air/fuel mixture and helps your engine run better and last longer.

#### CHECK FOR DAMAGED OR WORN PARTS

Contact an authorized service dealer for replacement of damaged or worn parts.

- ON/OFF Switch - Ensure ON/OFF switch functions properly by moving the switch to the OFF position and assure the engine stops; then restart engine and continue.
- Fuel Tank - Discontinue use of edger if fuel tank shows signs of damage or leaks.
- Blade Guard - Discontinue use of edger if blade guard is damaged.

### CHECK FOR LOOSE FASTENERS AND PARTS

- Blade nut
- Muffler
- Cylinder shield
- Clutch
- Throttle trigger
- Handle screws
- Fasteners

### INSPECT AND CLEAN UNIT & LABELS

- After each use, inspect complete unit for loose or damaged parts. Clean the unit and labels using a damp cloth with a mild detergent.
- Wipe off unit with a clean dry cloth.

### CLEAN AIR FILTER

A dirty air filter decreases the life and performance of the engine and increases fuel consumption and harmful emissions.

Always clean your air filter after 5 tanks of fuel or 5 hours of operation, whichever comes first. Clean more frequently in dusty conditions. It is advisable to replace your air filter with a new one after every 50 hours of operation, or annually, whichever comes first.

#### To clean filter:

1. Clean the cover and the area around it to keep dirt from falling into the carburetor chamber when the cover is removed.
2. Remove the two screws and the air filter cover from the engine.
3. Remove air filter.

**NOTE:** Do not clean the air filter with gasoline or other flammable solvent to avoid creating a fire hazard or producing harmful evaporative emissions.

4. Clean the air filter using hot soapy water. Rinse with clean cool water. Air dry completely before reinstalling.
5. Lightly oil air filter before installing to improve the efficiency of the air filter. Use 2-cycle engine oil or motor oil (SAE 30).

**NOTE:** Do not soak air filter in oil.

6. Squeeze the air filter to distribute oil and to remove any excess oil.

7. Reinstall air filter in housing.

**CAUTION:** Make sure air filter is fitted in to the corners of the housing to prevent air from

bypassing the filter and to keep dust from entering engine and causing damage.

8. Reinstall air filter cover.

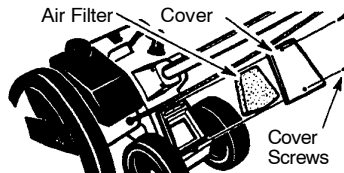

### BLADE MAINTENANCE

**WARNING:** The blade will continue to spin after the engine stops or after the throttle trigger has been released. Make sure the blade has stopped coasting and disconnect the spark plug before performing work on the blade.

**WARNING:** Wear protective gloves when handling or performing maintenance on the blade to help avoid injury.

Always replace a blade that is bent, warped, cracked, broken, or damaged in any other way. Never attempt to straighten and reuse a damaged blade. Use only specified replacement blade.

- The blade is reversible. When the cutting edge on one side becomes worn, turn the blade over.
- Check blade for flatness periodically. Lay the blade on a flat surface to inspect for flatness. Throw away a blade that is not flat.

### REPLACE SPARK PLUG

The spark plug should be replaced each year to ensure the engine starts easier and runs better. Set spark plug gap at 0.025 inches. Ignition timing is fixed, nonadjustable.

1. Twist then pull off the spark plug boot.
2. Remove and discard the spark plug.
3. Replace with Champion RCJ-6Y spark plug and tighten securely with a wrench.
4. Reinstall the spark plug boot.

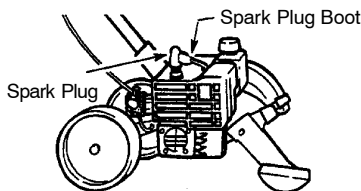



## SERVICE AND ADJUSTMENTS

### BLADE REPLACEMENT

1. To remove the blade, insert a screwdriver into one of the holes in the gearbox; then, remove the blade nut by turning clockwise.

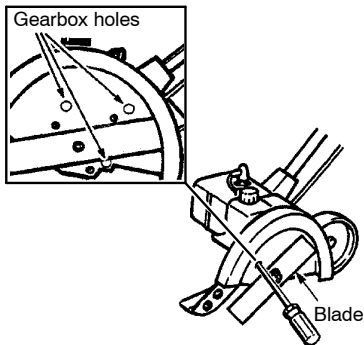

2. Remove the washer and blade from the blade shaft.
3. Align the flat area of the blade opening with the flat side of the shaft. Place the new blade on the shaft.

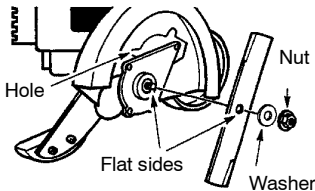

4. Install the washer and nut; turn nut counterclockwise on the blade shaft.
5. Bind blade by inserting a screwdriver into one of the holes in the gearbox; then, firmly tighten nut with a wrench.

### CARBURETOR ADJUSTMENT

**WARNING:** Keep others away when making idle speed adjustments. The blade shaft will be spinning during most of this procedure. Wear your protective equipment and observe all safety precautions. After making adjustments, the blade shaft must not spin at idle speed.

The carburetor has been carefully set at the factory. Adjustments may be necessary if you notice any of the following conditions:

- Engine will not idle when the throttle is released.
- The blade spins at idle.

Keep others away when making idle speed adjustments. Remove the blade before making carburetor idle speed adjustments. Do not make adjustments from the blade side of the unit. Recheck the idle speed after each adjustment. The blade must not spin at idle speed to avoid serious injury to the operator or others. Make adjustments with the unit supported so the blade is off the ground and will not make contact with any object. Hold the unit by hand while running and making adjustments. Keep all parts of your body away from the blade and muffler.

### Idle Speed Adjustment

Allow engine to idle. Adjust speed until engine runs without the blade shaft spinning (idle too fast) or engine stalling (idle speed too slow).

- Turn idle speed screw clockwise to increase engine speed if engine stalls or dies.
- Turn idle speed screw counterclockwise to decrease engine speed if the blade shaft spins at idle speed.

**WARNING:** Recheck the idle speed after each adjustment. The blade shaft must not spin at idle speed to avoid serious injury to the operator or others.

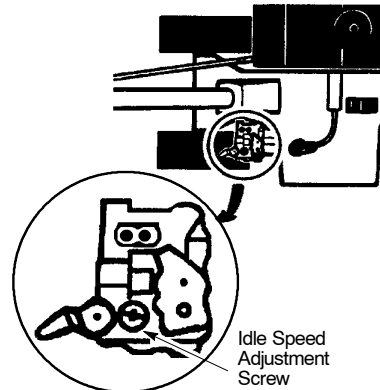

If you require further assistance or are unsure about performing this procedure, contact an authorized service dealer or call 1-800-554-6723.

## STORAGE

**⚠ WARNING:** Perform the following steps after each use:

- Allow engine to cool before storing or transporting.
- Store unit and fuel in a well ventilated area where fuel vapors cannot reach sparks or open flames from water heaters, electric motors or switches, furnaces, etc.
- Store unit with all guards in place. Position unit so that any sharp object cannot accidentally cause injury.
- Store unit and fuel well out of the reach of children.

### SEASONAL STORAGE

Prepare unit for storage at end of season or if it will not be used for 30 days or more.

If your unit is to be stored for a period of time:

- Clean the entire unit before lengthy storage.
- Store in a clean dry area.
- Lightly oil external metal surfaces.

### FUEL SYSTEM

Under FUELING ENGINE in the OPERATION section of this manual, see message labeled IMPORTANT regarding the use of gasoline in your engine.

Fuel stabilizer is an acceptable alternative in minimizing the formation of fuel gum deposits during storage. Add stabilizer to the gasoline in the fuel tank or fuel storage container. Follow the mix instructions found on stabilizer container. Run engine at least 5 minutes after adding stabilizer.



### HELPFUL TIP

*During storage of your gas/oil mixture, the oil will separate from the gas.*

*We recommend that you shake the gas can weekly to insure proper blending of the gas and oil.*

### ENGINE

- Remove spark plug and pour 1 teaspoon of 40:1, 2-cycle engine oil (air cooled) through the spark plug opening. Slowly pull the starter rope 8 to 10 times to distribute oil.
- Replace spark plug with new one of recommended type and heat range.
- Clean air filter.
- Check entire unit for loose screws, nuts, and bolts. Replace any damaged, broken, or worn parts.
- At the beginning of the next season, use only fresh fuel having the proper gasoline to oil ratio.

### OTHER

- Do not store gasoline from one season to another.
- Replace your gasoline can if it starts to rust.

## TROUBLESHOOTING TABLE

**⚠ WARNING:** Always stop unit and disconnect spark plug before performing all of the recommended remedies below except remedies that require operation of the unit.

TROUBLE	CAUSE	REMEDY
Engine will not start or will run only a few seconds after starting.	<ol style="list-style-type: none"> <li>1. ON/OFF switch in OFF position.</li> <li>2. Engine flooded.</li> <li>3. Fuel tank empty.</li> <li>4. Spark plug not firing.</li> <li>5. Fuel not reaching carburetor.</li> <li>6. Compression low.</li> </ol>	<ol style="list-style-type: none"> <li>1. Move ON/OFF switch to the ON position.</li> <li>2. See "Difficult Starting" in Operation Section.</li> <li>2. Fill tank with correct fuel mixture.</li> <li>3. Install new spark plug.</li> <li>4. Check for dirty fuel filter; replace. Check for kinked or split fuel line; repair or replace.</li> <li>5. Contact an authorized service dealer.</li> </ol>
Engine will not idle properly.	<ol style="list-style-type: none"> <li>1. Carburetor requires adjustment.</li> <li>2. Crankshaft seals worn.</li> <li>3. Compression low.</li> </ol>	<ol style="list-style-type: none"> <li>1. See "Carburetor Adjustment" in Service and Adjustments Section.</li> <li>2. Contact an authorized service dealer.</li> <li>3. Contact an authorized service dealer.</li> </ol>
Engine will not accelerate, lacks power, or dies under a load.	<ol style="list-style-type: none"> <li>1. Air filter dirty.</li> <li>2. Spark plug fouled.</li> <li>3. Carburetor requires adjustment.</li> <li>4. Carbon build up.</li> <li>5. Compression low.</li> </ol>	<ol style="list-style-type: none"> <li>1. Clean or replace air filter.</li> <li>2. Clean or replace plug and regap.</li> <li>3. Contact an authorized service dealer.</li> <li>4. Contact an authorized service dealer.</li> <li>5. Contact an authorized service dealer.</li> </ol>
Engine smokes excessively.	<ol style="list-style-type: none"> <li>1. Choke partially on.</li> <li>2. Fuel mixture incorrect.</li> <li>3. Air filter dirty.</li> <li>4. Carburetor requires adjustment.</li> </ol>	<ol style="list-style-type: none"> <li>1. Adjust choke.</li> <li>2. Empty fuel tank and refill with correct fuel mixture.</li> <li>3. Clean or replace air filter.</li> <li>4. Contact an authorized service dealer.</li> </ol>
Engine runs hot.	<ol style="list-style-type: none"> <li>1. Fuel mixture incorrect.</li> <li>2. Spark plug incorrect.</li> <li>3. Carburetor requires adjustment.</li> <li>4. Carbon build-up.</li> </ol>	<ol style="list-style-type: none"> <li>1. See "Fueling Engine" in Operation section.</li> <li>2. Replace with correct plug.</li> <li>3. Contact an authorized service dealer.</li> <li>4. Contact an authorized service dealer.</li> </ol>
Blade turns at idle speed.	<ol style="list-style-type: none"> <li>1. Carburetor requires adjustment.</li> <li>2. Throttle cable binding.</li> <li>3. Clutch requires repair.</li> </ol>	<ol style="list-style-type: none"> <li>1. See "Carburetor Adjustment" in Service and Adjustments Section.</li> <li>2. Replace or repair throttle cable.</li> <li>3. Contact an authorized service dealer.</li> </ol>
Blade stops under a load or does not turn when engine is accelerated.	<ol style="list-style-type: none"> <li>1. Blade not engaged.</li> <li>2. Carburetor requires adjustment.</li> <li>3. Clutch requires repair.</li> </ol>	<ol style="list-style-type: none"> <li>1. Check gearbox.</li> <li>2. Contact an authorized service dealer.</li> <li>3. Contact an authorized service dealer.</li> </ol>

## LIMITED WARRANTY

**WEED EATER** warrants to the original purchaser that each new **WEED EATER** brand gasoline tool or attachment is free from defects in material and workmanship and agrees to repair or replace under this warranty any defective gasoline product or attachment as follows from the original date of purchase.

**2 YEARS**-Parts and Labor, when used for household purposes.

**90 DAYS**-Parts and Labor, when used for commercial, professional, or income producing purposes.

**30 DAYS**-Parts and Labor, if used for rental purposes.

This warranty is not transferable and does not cover damage or liability caused by improper handling, improper maintenance, or the use of accessories and/or attachments not specifically recommended by **WEED EATER** for this tool. Additionally, this warranty does not cover tune-ups, spark plugs, filters, etc., that will wear and require replacement with reasonable use during the warranty period. This warranty does not cover pre-delivery setup or normal adjustments explained in the instruction manual.

THIS WARRANTY GIVES YOU SPECIFIC LEGAL RIGHTS, AND YOU MAY HAVE OTHER RIGHTS WHICH VARY FROM STATE TO STATE.

NO CLAIMS FOR CONSEQUENTIAL OR OTHER DAMAGES WILL BE ALLOWED, AND THERE ARE NO OTHER EXPRESS WARRANTIES EXCEPT THOSE EXPRESSLY STIPULATED HEREIN.

SOME STATES DO NOT ALLOW LIMITATIONS ON HOW LONG AN IMPLIED WARRANTY LASTS OR THE EXCLUSION OR LIMITATIONS OF INCIDENTAL OR CONSEQUENTIAL DAMAGES, SO THE ABOVE LIMITATIONS OR EXCLUSION MAY NOT APPLY TO YOU.

The policy of **WEED EATER** is to continuously improve its products. Therefore, **WEED EATER** reserves the right to change, modify, or discontinue models, designs, specifications, and accessories of all products at any time without notice or obligation to any purchaser.

## U.S. EPA EMISSION CONTROL WARRANTY STATEMENT

**YOUR WARRANTY RIGHTS AND OBLIGATIONS:** The U. S. Environmental Protection Agency and Poulan/WEED EATER are pleased to explain the emissions control system warranty on your year 2005 and later small off-road engine. Poulan/WEED EATER must warrant the emission control system on your small off-road engine for the periods of time listed below provided there has been no abuse, neglect, or improper maintenance of your small off-road engine. Your emission control system includes parts such as the carburetor and the ignition system. Where a warrantable condition exists, Poulan/WEED EATER will repair your small off-road engine at no cost to you. Expenses covered under warranty include diagnosis, parts and labor. **MANUFACTURER'S WARRANTY COVERAGE:** If any emissions related part on your engine (as listed under Emissions Control Warranty Parts List) is defective or a defect in the materials or workmanship of the engine causes the failure of such an emission related part, the part will be repaired or replaced by Poulan/WEED EATER. **OWNER'S WARRANTY RESPONSIBILITIES:** As the small off-road engine owner, you are responsible for the performance of the required maintenance listed in your instruction manual. Poulan/WEED EATER recommends that you retain all receipts covering maintenance on your small off-road engine, but Poulan/WEED EATER cannot deny warranty solely for the lack of receipts or for your failure to ensure the performance of all scheduled maintenance. As the small off-road engine owner, you should be aware that Poulan/WEED EATER may deny you warranty coverage if your small off-road engine or a part

of it has failed due to abuse, neglect, improper maintenance, unapproved modifications, or the use of parts not made or approved by the original equipment manufacturer. You are responsible for presenting your small off-road engine to a Poulan/WEED EATER authorized repair center as soon as a problem exists. Warranty repairs should be completed in a reasonable amount of time, not to exceed 30 days. If you have any questions regarding your warranty rights and responsibilities, you should contact your nearest authorized service center or call Poulan/WEED EATER at 1-800-554-6723. **WARRANTY COMMENCEMENT DATE:** The warranty period begins on the date the small off-road engine is purchased. **LENGTH OF COVERAGE:** This warranty shall be for a period of two years from the initial date of purchase. **WHAT IS COVERED: REPAIR OR REPLACEMENT OF PARTS.** Repair or replacement of any warranted part will be performed at no charge to the owner at an approved Poulan/WEED EATER servicing center. If you have any questions regarding your warranty rights and responsibilities, you should contact your nearest authorized service center or call Poulan/WEED EATER at 1-800-554-6723. **WARRANTY PERIOD:** Any warranted part which is not scheduled for replacement as required maintenance, or which is scheduled only for regular inspection to the effect of "repair or replace as necessary" shall be warranted for 2 years. Any warranted part which is scheduled for replacement as required maintenance shall be warranted for the period of time up to the first scheduled replacement point for that part. **DIAGNOSIS:** The owner shall not be charged for diagnostic labor

which leads to the determination that a warranted part is defective if the diagnostic work is performed at an approved Poulan/WEED EATER servicing center. **CONSEQUENTIAL DAMAGES:** Poulan/WEED EATER may be liable for damages to other engine components caused by the failure of a warranted part still under warranty. **WHAT IS NOT COVERED:** All failures caused by abuse, neglect, or improper maintenance are not covered. **ADD-ON OR MODIFIED PARTS:** The use of add-on or modified parts can be grounds for disallowing a warranty claim. Poulan/WEED EATER is not liable to cover failures of warranted parts caused by the use of add-on or modified parts. **HOW TO FILE A CLAIM:** If you have any questions regarding your warranty rights and responsibilities, you should contact your nearest authorized service center or call Poulan/WEED EATER at

1-800-554-6723. **WHERE TO GET WARRANTY SERVICE:** Warranty services or repairs shall be provided at all Poulan/WEED EATER service centers. Call 1-800-554-6723. **MAINTENANCE, REPLACEMENT AND REPAIR OF EMISSION RELATED PARTS:** Any Poulan/WEED EATER approved replacement part used in the performance of any warranty maintenance or repair on emission related parts will be provided without charge to the owner if the part is under warranty. **EMISSION CONTROL WARRANTY PARTS LIST:** Carburetor, Ignition System: Spark Plug (covered up to maintenance schedule), Ignition Module. **MAINTENANCE STATEMENT:** The owner is responsible for the performance of all required maintenance as defined in the instruction manual.

---

This engine is certified to be emissions compliant for the following use:

- Moderate (50 hours)
- Intermediate (125 hours)
- Extended (300 hours)

## Free Manuals Download Website

<http://myh66.com>

<http://usermanuals.us>

<http://www.somanuals.com>

<http://www.4manuals.cc>

<http://www.manual-lib.com>

<http://www.404manual.com>

<http://www.luxmanual.com>

<http://aubethermostatmanual.com>

Golf course search by state

<http://golfingnear.com>

Email search by domain

<http://emailbydomain.com>

Auto manuals search

<http://auto.somanuals.com>

TV manuals search

<http://tv.somanuals.com>