

IMPORTANT MANUAL Do Not Throw Away

WEED EATER

TRADEMARK ®

OPERATOR'S MANUAL:

⚠ DANGER: Read the Operator's Manual and Follow All Warnings and Safety Instructions. Failure To Do So Can Result in Serious Injury.

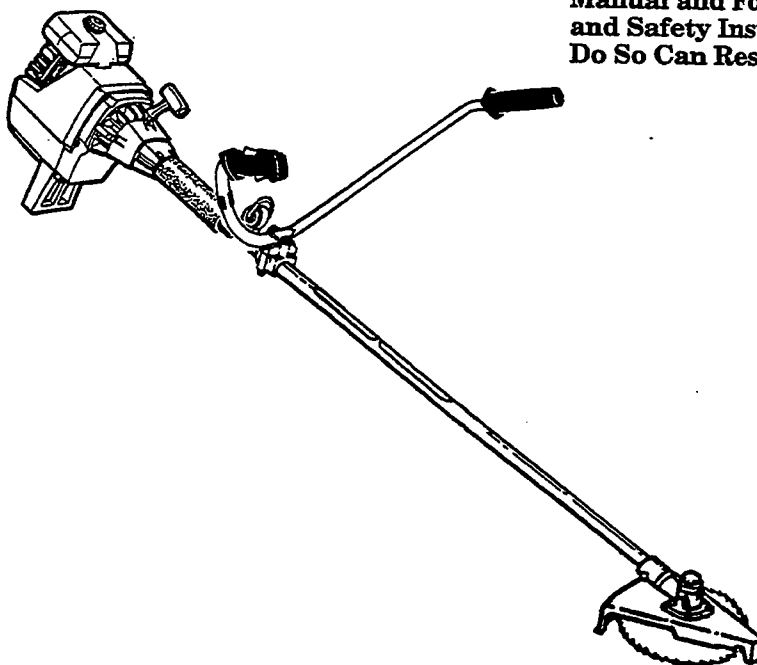

MODEL:

TBC 57

GAS POWERED BLADE/LINE TRIMMER

Always Wear Eye Protection

**CUSTOMER
ASSISTANCE**

1-800-554-6723

SEE BACK COVER FOR DETAILS!

ENGLISH

ESPAÑOL

FRANÇAIS

TABLE OF CONTENTS

<p>WARNINGS AND SAFETY INSTRUCTIONS 3</p> <p>KNOW YOUR UNIT 6</p> <p>ASSEMBLY 7</p> <p>FUELING YOUR ENGINE 10</p> <p>STARTING YOUR ENGINE 11</p>	<p>USING YOUR UNIT AS A LINE TRIMMER 12</p> <p>USING YOUR UNIT AS A BRUSHCUTTER 16</p> <p>ACCESSORIES 17</p> <p>GENERAL MAINTENANCE 19</p> <p>CUSTOMER ASSISTANCE Back Cover</p>
---	---

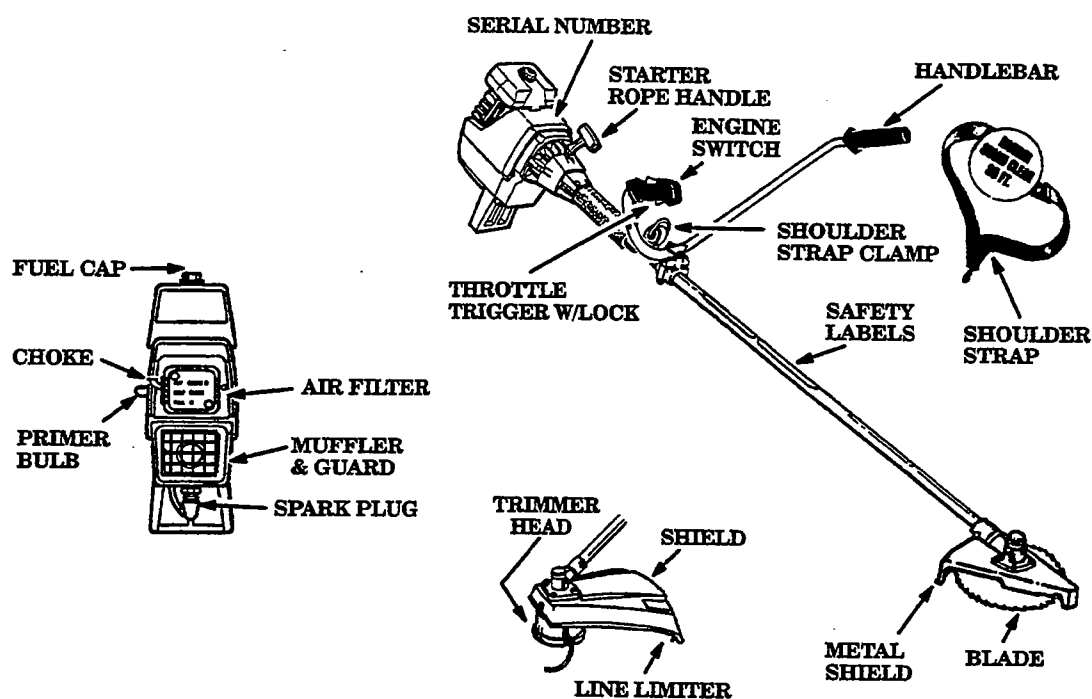

MANUFACTURED UNDER ONE OR MORE OF THE FOLLOWING U.S. PATENTS:
 4,035,912; 4,052,789; 4,112,653; 4,161,820; 4,167,812; 4, 183,138; 4,189,833; 4,211,004;
 4,286,675; 4,362,074; 4,451,983; 4,841,929; 4,940,028; & D324,051. OTHER U.S. AND FOR-
 EIGN PATENTS PENDING.



SPECIAL NOTICE

For users on U.S. Forest Land and in some states, including California (Public Resources Codes 4442 and 4443), Idaho, Maine, Minnesota, New Jersey, Oregon, and Washington: Certain internal combustion engines operated on forest, brush, and/or grass-covered land in the above areas are required to be equipped with a spark arrestor, maintained in effective working order, or the engine must be constructed, equipped, and maintained for the prevention of fire. Check with your state or local authorities for regulations pertaining to these requirements. Failure to follow these requirements is a violation of the law. **This unit is not factory-equipped with a spark arrestor;** however, a spark arrestor is available as an optional part. If a spark arrestor is required in your area, contact your Authorized Service Dealer for the correct kit.

▲ WARNINGS AND SAFETY INSTRUCTIONS

(See Additional Safety Instructions throughout this Manual)

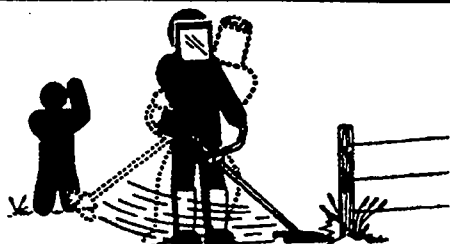
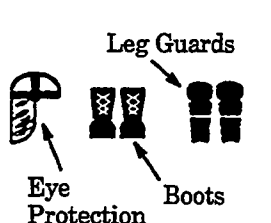
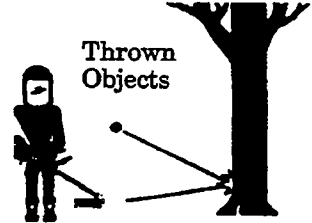
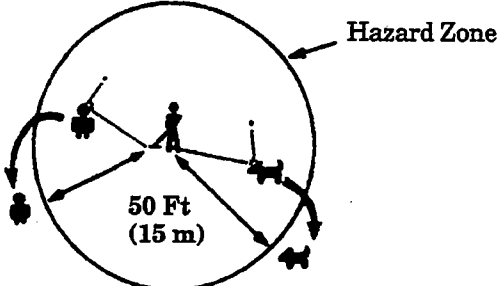
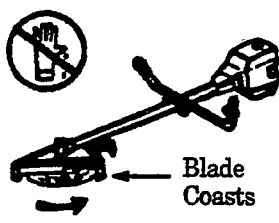
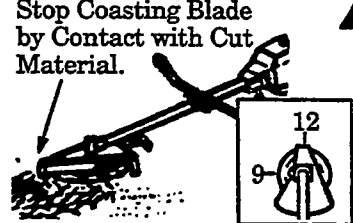
▲ DANGER – THIS POWER TOOL CAN BE DANGEROUS! This unit can cause serious injury including amputation or blindness to the operator and others. The warnings and safety instructions in this manual must be followed to provide reasonable safety and efficiency in using the unit. The operator is responsible for following the warnings and instructions in this manual and on the unit. Read the entire Operator's Manual before assembling and using the unit! Restrict the use of this unit to persons who read, understand, and follow the warnings and instructions in this manual and on the unit.

	<p>▲ DANGER BLADE CAN THRUST VIOLENTLY AWAY FROM MATERIAL IT DOES NOT CUT.</p> <ul style="list-style-type: none"> - BLADE THRUST CAN CAUSE AMPUTATION OF ARMS OR LEGS. - KEEP PEOPLE AND ANIMALS 50 FEET (15 METERS) AWAY.
 <p>Leg Guards Eye Protection Boots</p>  <p>Thrown Objects</p>	<p>▲ WARNING TRIMMER LINE CAN THROW OBJECTS VIOLENTLY.</p> <ul style="list-style-type: none"> - YOU CAN BE BLINDED OR INJURED. - WEAR EYE AND LEG PROTECTION.
 <p>Hazard Zone 50 Ft (15 m)</p>	<p>▲ WARNING HAZARD ZONE FOR THROWN OBJECTS.</p> <ul style="list-style-type: none"> - BLADE/TRIMMER LINE CAN THROW OBJECTS VIOLENTLY. - OTHERS CAN BE BLINDED OR INJURED. - KEEP PEOPLE AND ANIMALS 50 FEET (15 METERS) AWAY.
 <p>Blade Coasts</p>  <p>Stop Coasting Blade by Contact with Cut Material.</p>	<p>▲ WARNING BLADE COASTS AFTER THE THROTTLE IS RELEASED.</p> <ul style="list-style-type: none"> - THE BLADE CAN SERIOUSLY CUT YOU OR OTHERS. - STOP THE BLADE WITH CUT MATERIAL.
 <p>Operator's Manual</p>  <p>Safety Labels</p>	<p>▲ WARNING READ OPERATOR'S MANUAL.</p> <ul style="list-style-type: none"> - FOLLOW ALL WARNINGS AND INSTRUCTIONS. - FAILURE TO DO SO CAN RESULT IN SERIOUS INJURY.
<p>▲ LOOK FOR THIS SYMBOL TO POINT OUT IMPORTANT SAFETY PRECAUTIONS. IT MEANS, "ATTENTION! BE ALERT! YOUR SAFETY IS INVOLVED!"</p>	

WARNINGS AND SAFETY INSTRUCTIONS...(Continued)

▲ OPERATOR SAFETY

- Always wear safety eye protection.
- Always wear heavy, long pants, long sleeves, boots, and gloves. Wearing safety leg guards is recommended. Do not go barefoot or wear sandals, jewelry, short pants, short sleeves, loose clothing, or clothing with loosely hanging ties, straps, tassels, etc.; they can be caught in moving parts. Being fully covered will help protect you from pieces of toxic plants such as poison ivy thrown by blade or trimmer head which could be more of a hazard than touching the plant itself.
- Secure hair so it is above shoulder length.
- Do not operate unit when you are tired, ill, or under the influence of alcohol, drugs, or medication.
- Wear hearing protection if you use the unit for more than 1-1/2 hours per day.
- Never start or run the engine inside a closed room or building. Breathing exhaust fumes can kill.
- Keep handles free of oil and fuel.
- Always use the handlebar and a properly adjusted shoulder strap with a blade. See "Assembly."

▲ UNIT/MAINTENANCE SAFETY

- Look for and replace damaged or loose parts before each use. Look for and repair fuel leaks before use. Keep the unit in good working condition.
- Throw away blades that are bent, warped, cracked, broken, or damaged in any other way. Replace trimmer head parts that are cracked, chipped, broken, or damaged in any other way before using the unit.
- Maintain the unit according to recommended procedures. Keep the blade sharp. Keep the cutting line at the proper length.
- Use only .080" (2 mm) diameter WEED EATER® brand line. Never use wire, rope, string, etc.
- Install the required shield properly before using the unit. Use the metal shield for all weed blade use. Use the plastic shield for all line trimmer use.
- Use only specified blade or trimmer head; make sure it is properly installed and securely fastened.
- Never start engine with clutch shroud removed. The clutch can fly off and cause serious injury.
- Be sure blade or trimmer head stops turning when engine idles.
- Disconnect the spark plug before performing maintenance (except carburetor adjustments).
- Make carburetor adjustments with the lower end supported to prevent the blade or trimmer line from contacting any object. Hold the unit by hand; do not use the shoulder strap for support.
- Keep others away when making carburetor adjustments.
- Use only genuine WEED EATER accessories as recommended for this unit.

If situations occur which are not covered in this manual, use care and good judgment. If you need assistance, contact your Authorized Service Dealer or the CUSTOMER ASSISTANCE HELPLINE at 1-800-554-6723.

- Have all maintenance and service not explained in this manual performed by an Authorized Service Dealer.

▲ FUEL SAFETY

- Mix and pour fuel outdoors.
- Keep away from sparks or flames.
- Use a container approved for fuel.
- Do not smoke or allow smoking near fuel or the unit or while using the unit.
- Wipe up all fuel spills before starting engine.
- Move at least 10 feet (3 meters) away from fueling site before starting engine.
- Stop engine and allow it to cool before removing fuel cap.
- Empty the fuel tank before storing the unit. Use up fuel left in the carburetor by starting the engine and letting it run until it stops.
- Store unit and fuel in an area where fuel vapors cannot reach sparks or open flames from water heaters, electric motors or switches, furnaces, etc.

▲ CUTTING SAFETY

- Inspect the area to be cut before each use. Remove objects (rocks, broken glass, nails, wire, string, etc.) which can be thrown or become entangled in the blade or trimmer head.
- Keep others including children, animals, bystanders, and helpers at least 50 feet (15 meters) away. Stop the engine immediately if you are approached.
- Always keep engine on the right-hand side of your body.
- Hold the unit firmly with both hands.
- Keep firm footing and balance. Do not over-reach.
- Keep blade or trimmer head below waist level.
- Do not raise the engine above your waist.
- Keep all parts of your body away from blade, trimmer head, and muffler when engine is running.
- Cut from your right to your left.
- Use only for jobs explained in this manual.

▲ TRANSPORTING AND STORAGE

- Stop the unit before carrying.
- Keep the muffler away from your body.
- Allow engine to cool and secure unit before storing or transporting it in a vehicle.
- Empty the fuel tank before storing or transporting the unit. Use up fuel left in the carburetor by starting the engine and letting it run until it stops.
- Store unit and fuel in an area where fuel vapors cannot reach sparks or open flames from water heaters, electric motors or switches, furnaces, etc.
- Store unit so the blade or line limiter cannot accidentally cause injury. The unit can be hung by the bracket below engine or by drive shaft housing.
- Store the unit out of reach of children.

SAFETY NOTICE

Exposure to vibrations through prolonged use of gasoline powered hand tools could cause blood vessel or nerve damage in the fingers, hands, and joints of people prone to circulation disorders or abnormal swellings. Prolonged use in cold weather has been linked to blood vessel damage in otherwise healthy people. If symptoms occur such as numbness, pain, loss of strength, change in skin color or texture, or loss of feeling in the fingers, hands or joints, discontinue the use of this tool and seek medical attention. An anti-vibration system does not guarantee the avoidance of these problems. Users who operate power tools on a continual and regular basis must monitor closely their physical condition and the condition of this tool.

KNOW YOUR UNIT

A. INTRODUCTION

Your tool is a versatile product developed for large lawns and to make short work of a variety of lawn care tasks -- trimming, scalping, mowing, and sweeping.

Special Features Include:

- 18" Cutting Path
- TAP-N-GO® Trimmer Head
- Heavy Duty Precision Clutch®
- 30cc Engine
- 8" Brush Blade

B. UNPACKING INSTRUCTIONS

1. After removing the contents from the carton, check parts against the Carton Contents list.
2. Examine the parts for damage. Do not use damaged parts.
3. Notify your WEED EATER dealer immediately if a part is missing or damaged.

NOTE: It is normal to hear the fuel filter rattle in an empty fuel tank.

C. CARTON CONTENTS

DESCRIPTION	QTY
● Engine	1
● Drive Shaft Assembly w/Safety Label	1
* ● Metal Shield	1
● Plastic Shield	1
* ● 8" Brush Blade	1
* ● Trimmer Head	1
● Handlebar with Throttle Trigger Assembly	1
● Shoulder Strap w/Warning	1
● Operator's Manual	1
● Loose Parts Bag	1

** LOOSE PARTS BAG CONTENTS:

● Cover - Handlebar	1
* ● Retention Plate	1
● Hex Wrench - 5/32"	1
● Hex Wrench - 3/16"	1
A. Hex Socket Screw	2
B. Screw	4
C. Screw	6
D. Hex Nut	2
* E. Flange Hex Nut	1
* F. Beveled Washer	1
* G. Flat Washer	1
H. Grass Washer	1

*** ⚠ WARNING**
Parts marked with * are critical and must be supplied by your WEED EATER dealer. Failure to use the proper parts can cause the blade to fly off and seriously hurt you or others.

D. HARDWARE USAGE

HARDWARE SHOWN
ACTUAL SIZE

NOTE: This Hardware is packaged in the Plastic Bag. Refer to the Hardware reference letters below during assembly.

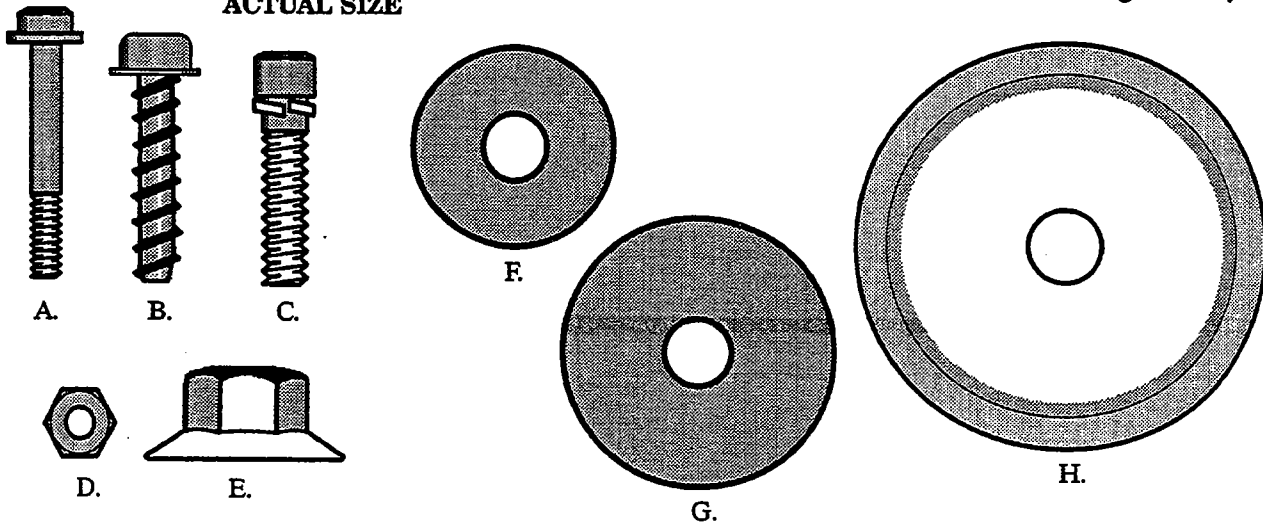

Figure 1

ASSEMBLY

(If tool is received assembled, repeat all steps in this section to be sure assembly is correct and is adjusted for the operator.)

A. PREPARATION

This Operator's Manual is designed to help you assemble the tool and to provide its safe operation. It is important that you read the entire manual to become familiar with the tool *before* you begin assembly. If you have any questions or need further assistance, call our CUSTOMER ASSISTANCE HELPLINE at 1-800-554-6723.

1. Read your Operator's Manual

2. Tools you will need:

- Small Hex Wrench (provided)
- Large Hex Wrench (provided)
- Adjustable Wrench

B. ASSEMBLY STEPS

NOTE: Hardware referred to in the following sections are shown in actual size in Figure 1.

1. TUBE

- a. Place screws "A." into the holes on the front shroud as shown in Figure 2.
- b. Position locknuts "D." in lower holes.
- c. Hold locknuts "D." in place; tighten screws with small hex wrench (provided) just enough to hold hardware together.
- d. Remove the packing cover from the straight end of the tube if so equipped. Your unit may not have a packing cover.

NOTE: Make sure the drive shaft does not fall out of the tube. Dirt on the shaft will significantly reduce the life of the unit. If the drive shaft falls out of the tube, clean, re-lubricate, and re-install. See "Drive Shaft Lubrication" in the Maintenance section.

- e. Align the bottom groove on the tube with the ridge on the lower wall of the engine opening.
- f. Turn the arbor shaft at the bottom of the tube as necessary to align the square end of the shaft with the square hole inside the front opening of the engine. Figure 2 (inset).
- g. Firmly push tube into the engine opening until the nose cone contacts the foam grip. Figure 2.
- h. Tighten screws "A." alternately with the hex wrench until secure. Figure 2.

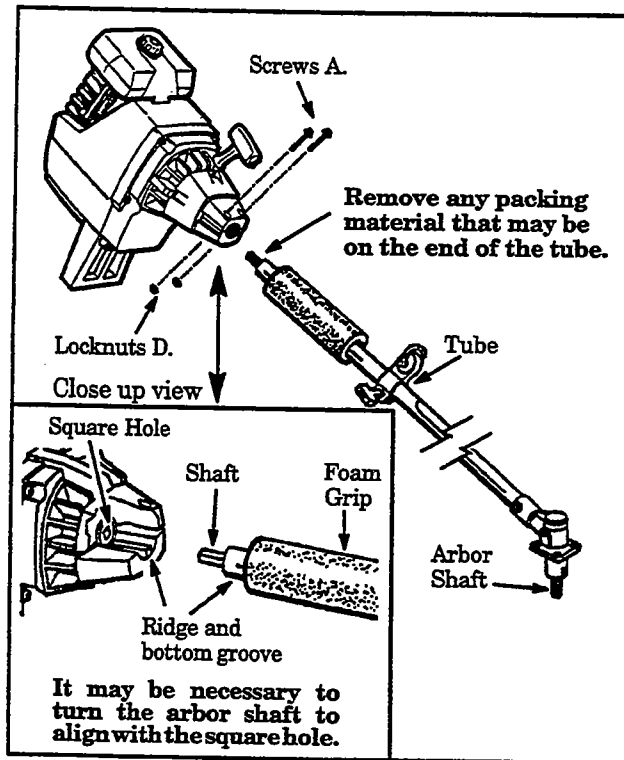

Figure 2

2. HANDLEBAR ASSEMBLY

- a. Locate the decal on the handlebar. Align the mounting block between the arrows on the decal; then, seat the handlebar in the mounting block.
- b. Position the cover between the arrows on the handlebar and align screw holes.
- c. Insert screws "C." and tighten securely.

NOTE: Refer to the illustration on the front cover for proper positioning.

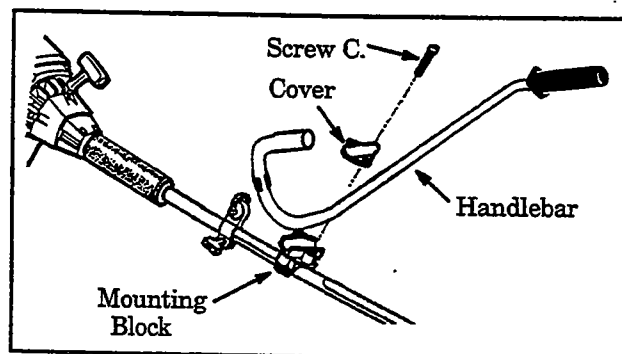

Figure 3

3. THROTTLE HANDLE ASSEMBLY

- Remove the rear screw from the trigger housing. Figure 4.
- Slide the trigger housing onto the right side of the handlebar. Align screw holes in the trigger housing with the screw hole in the handlebar.
- Reinstall the rear screw in the trigger housing. Tighten securely.

NOTE: Make sure the engine switch is located on the top side of the handle.

- Secure the loose wire assembly in the groove in the shaft pad.

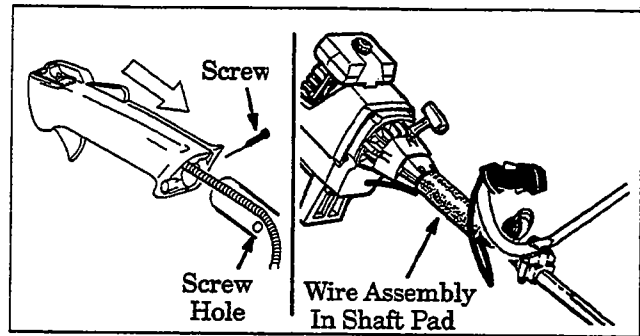

Figure 4

4. TRIMMER HEAD & PLASTIC SHIELD

▲ WARNING

The shield must be properly installed for all line trimmer usage. The shield provides partial protection from the risk of thrown objects to the operator and others and is equipped with a line limiter which cuts excess line to proper length.

▲ WARNING

Failure to install the shield in the position shown in Figure 5 can result in serious injury to the operator. The length of the shield must be aligned with the length of the tube. Direct the widest part of the shield toward the engine.

- Remove and discard the packing cover from the arbor shaft if so equipped.

CAUTION: The line limiter (on the underside of the shield) is sharp and can cut you.

- Place the shield under the gear box and insert four screws "B." through the gear box into the shield. Figure 5.
- Tighten screws "B." evenly and securely with a standard screwdriver.
- Install grass washer "H." over the arbor shaft. Make sure grass washer "H." is against and curved over the dust cup. Figure 5.
- Start threading the trimmer head onto the arbor shaft as shown in Figure 5.
- Align the hole in the dust cup with the hole in the center front of the gear box by turning the trimmer head.
- Insert the large hex wrench (provided) into the aligned holes to keep the arbor shaft from turning. Figure 5 (inset).

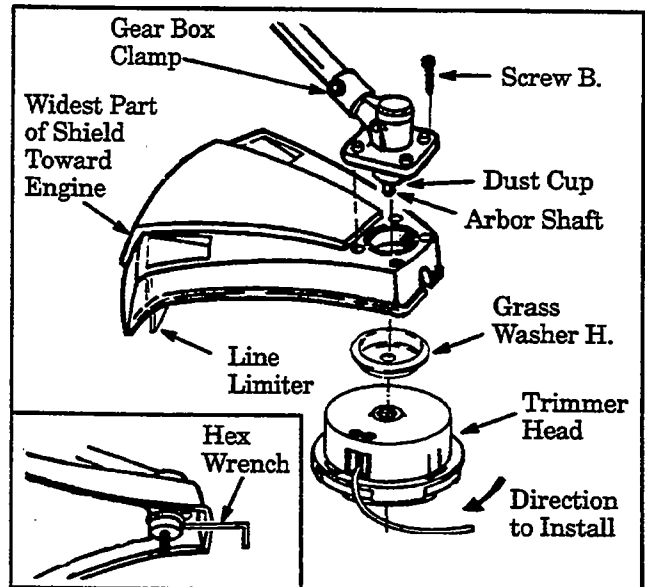

Figure 5

- Tighten the trimmer head counterclockwise against grass washer "H." and the dust cup while holding the large hex wrench. See Figure 5 (inset).
- Remove the hex wrench.

NOTE: To remove the trimmer head, insert the hex wrench into the aligned holes in the dust cup and gear box. Unthread the trimmer head. Be sure to store the grass washer, plastic shield, 4 shield screws, and hardware with the trimmer head for future use.

5. METAL SHIELD AND BLADE

▲ DANGER

The metal shield must be properly installed on the tool anytime the tool is used with the blade. The forward tip on the metal shield helps to reduce the occurrence of blade thrust which can cause serious injury such as amputation to the operator or bystanders.

▲ DANGER

Failure to install the shield in the position shown in Figures 6 and 7 can result in serious injury to the operator. The length of the shield must be aligned with the length of the tube. Direct widest part of the shield toward the engine.

NOTE: If your unit is equipped as a line trimmer, remove the trimmer head, grass washer, and plastic shield before installing the metal shield and blade. Store parts for future use.

- Remove and discard the packing cover from the arbor shaft, if so equipped.
- Remove the dust cup.
- Position the retention plate on the underside of the metal shield and align screw holes. Make sure the flat side of the plate is against the metal shield. Figure 6.
- Hold the retention plate in position and place the metal shield under the gear box. Align screw holes. Figure 6.

- e. Insert the four shield screws "C." one at a time through the gear box and shield, then thread them into the retention plate.
- f. Tighten the screws evenly and securely with the 3/16" hex wrench (provided).
- g. Install the dust cup over the arbor shaft.
- h. Install blade over arbor shaft, making sure the hole in the center of the blade is fitted around the raised center on the dust cup. Figure 6.

NOTE: When installing blade, make sure teeth on blade are oriented as shown in Figure 6.

- i. Install the large flat washer "G.", cupped washer "F.", and nut "E." as shown in Figure 6. Be sure cupped washer "F." is installed as shown in Figure 6 (inset).
- j. Align hole in the dust cup with the hole in the side of the gear box by turning the dust cup.
- k. Insert the large hex wrench (provided) into the aligned holes. Figure 6 (inset, upper left).
- l. While holding the hex wrench in position, firmly tighten nut "E." counterclockwise with a wrench.

m. Remove the hex wrench.

- n. Turn blade by hand. If the blade binds against shield, blade is not centered. Reinstall blade.

NOTE: To remove the blade, align holes as in step "j."; then, insert the large hex wrench. Unthread hex flange nut and remove parts. Be sure to store the blade, flat washer, cupped washer, and hex flange nut for future use.

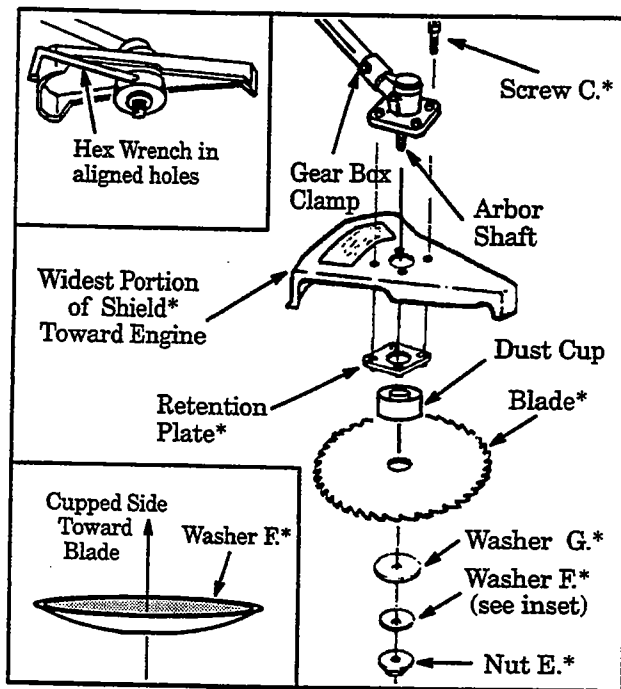

Figure 6

⚠ WARNING
Parts noted with * are critical and must be supplied by your Weed Eater dealer. Failure to use proper parts can cause the blade to fly off and seriously hurt you or others.

6. SHOULDER STRAP

⚠ WARNING
Proper shoulder strap and handlebar adjustments before starting the engine are required for safe and efficient use.

- a. Try on shoulder strap and adjust for fit and balance before starting the engine and beginning a cutting operation.
- b. Insert your right arm and head through the shoulder strap and allow it to rest on your left shoulder. Make sure the danger sign is on your back and the hook is to the right side of your waist. Figure 7.

NOTE: A one-half twist is built in the shoulder strap to allow the strap to rest flat on the shoulder.

- c. Adjust the strap so that the hook will be about 10 inches below the waist when the hook is attached to the shoulder strap.
- d. Fasten shoulder strap hook to clamp and lift tool to the operating position. Figure 7.

e. Check for the following:

1. Left arm extended, hand holding handlebar grip.
2. Right hand holding trigger handle, fingers on throttle trigger.
3. Engine below waist level.
4. Shoulder strap pad centered on left shoulder.
5. Danger sign centered on your back.
6. Full weight of tool on left shoulder.
7. Without operator bending over, the blade or trimmer head is near and parallel to the ground and easily contacts material to be cut.

- f. Modify these initial adjustments as necessary for comfort and control but do not locate the handlebar mounting block below the point of the arrow on the safety labels. Do not locate the shoulder strap clamp in any position other than between the engine and handlebar mounting block.



Figure 7

OPERATION -- Fueling Your Engine

BEFORE FUELING ENGINE:



WARNING

BE SURE TO READ THE FUEL INFORMATION IN THE WARNINGS AND SAFETY INSTRUCTIONS BEFORE YOU BEGIN.

IF YOU DO NOT UNDERSTAND THE SAFETY RULES, DO NOT ATTEMPT TO FUEL YOUR UNIT; CALL THE CUSTOMER ASSISTANCE HELPLINE AT 1-800-554-6723.

GASOLINE

The two-cycle engine on this product requires a fuel mixture of regular unleaded gasoline and a high quality engine oil for lubrication of the bearings and other moving parts. The correct fuel/oil mixture is 40:1 (see Fuel Mixture Chart). Too little oil or the incorrect oil type will cause poor performance and may cause the engine to over-heat and seize.

Gasoline and oil must be premixed in a clean container approved for gasoline. Always use fresh regular unleaded gasoline.

This engine is certified to operate on unleaded gasoline.

2-CYCLE AIR-COOLED OIL:

WEED EATER 40:1, 2-cycle engine oil is strongly recommended. WEED EATER oil is especially blended with fuel stabilizers and reduced smoke additives.

- Fuel stabilizers protect the fuel from oxidation and the formation of gum and varnish.
- Under average conditions, regular unleaded gasoline stays fresh for 30 to 60 days out of the refinery.
- WEED EATER 40:1, 2-cycle engine oil with fuel stabilizers will extend the fuel life by up to 5 times.

If WEED EATER 40:1, 2-cycle engine oil is not available, use a good quality 2-cycle engine oil, *formulated for AIR-COOLED engines*, that has a recommended fuel mixture of 40:1.

IMPORTANT! Do not use:

- **AUTOMOTIVE OIL**
- **BOAT OILS** (NMMA, BIA, etc.)

These oils do not have proper additives for 2-cycle, AIR-COOLED engines and can cause engine damage.

GASOLINE AND OIL MIXTURE

Mix gasoline and oil as follows:

- Consult Fuel Mixture Chart for correct mixture.
- Do not mix gasoline and oil directly in the fuel tank of the engine.

FOR ONE GALLON OF FUEL:

- Pour 3.2 ounces of high quality, 2-cycle engine oil into an empty, container approved for gasoline.
- Add one gallon of regular unleaded gasoline to the container, then securely replace the cap. Shake the container momentarily to assure oil is thoroughly mixed. The fuel is ready for use.

FUEL MIXTURE CHART

40:1 Fuel:Oil Mix Ratio

<u>Gasoline</u>	<u>Oil (fl. oz.)</u>
1 U.S. gal. (3.8 l)	3.2 fl. oz. (95 ml)
1.25 U.S. gal. (4.7 l)	4.0 fl. oz. (118 ml)
2.5 U.S. gal. (9.5 l)	8.0 fl. oz. (237 ml)

NOTE: One gallon fuel containers can hold more than one gallon. If too much gasoline is in the container, the resulting gas-to-oil mixture will not be correct for proper engine operation.



STARTING YOUR ENGINE

(For location of controls, refer to "Specifications.")

BEFORE STARTING THE ENGINE:

- Fuel engine. Move 10 feet (3 meters) away from fueling site.

▲ WARNING

The trimmer head will turn when the engine starts.

- Rest engine and shield on ground, supporting trimmer head off ground.

STARTING A COLD ENGINE, OR A WARM ENGINE AFTER RUNNING OUT OF FUEL:

- Make sure the switch is in the "On" position.
- Move the choke lever to the "Full Choke" position.
- Slowly press the primer bulb 6 times.
- Engage the throttle lock as follows
 - 1.) press the throttle lock-out
 - 2.) squeeze and hold the throttle trigger
 - 3.) press and hold the throttle lock, then
 - 4.) release the throttle trigger*Keep the throttle lock engaged until the engine runs smoothly.*
- Pull starter rope sharply 5 times.

NOTE: The engine may sound as if it is trying to start before the 5th pull. If so, go to the next step immediately.

- Move the choke lever to the "Half Choke" position.
- Pull the starter rope sharply until the engine runs, but no more than 6 pulls.

NOTE: If the engine has not started after 6 pulls (at half choke), check to make sure the switch and the choke lever are in the proper positions. Then, move the choke lever to the "Full Choke" position and press the primer bulb 6 times; pull the starter rope 2 more times. Move the choke lever to "Half Choke" and pull the starter rope until the engine runs, but no more than 6 more pulls.

NOTE: If the engine still has not started, it is probably flooded. Proceed to "Starting a Flooded Engine."

- Allow the engine to run 15 seconds, then move the choke lever to "Off Choke." Allow the unit to run for 30 more seconds at "Off Choke," then release the throttle lock by squeezing and releasing the trigger.

NOTE: If engine dies with the choke lever at the "Off Choke" position, move the choke lever to "Half Choke" and pull the rope until the engine runs.

- To stop the engine, move the switch to "Off."

▲ WARNING

Avoid any contact with the muffler. A hot muffler can cause serious burns.

STARTING A WARM ENGINE THAT HAS NOT RUN OUT OF FUEL:

- Make sure the switch is in the "On" position.
 - Move the choke lever to the "Half Choke" position.
 - Engage the throttle lock as directed in "STARTING A COLD ENGINE, . . ." *Keep the throttle lock engaged until the engine runs smoothly.*
 - Pull starter rope sharply until engine runs, but no more than 5 pulls.
 - Allow the engine to run 15 seconds, then move the choke lever to "Off Choke." Release the throttle lock by squeezing and releasing the trigger.
- NOTE:** If engine has not started, pull starter rope 5 more pulls. If engine still does not run, it is probably flooded. Proceed to "Starting a Flooded Engine."
- To stop the engine, move switch to the "Off" position.

STARTING A FLOODED ENGINE:

Flooded engines can be started by placing the switch in the "On" position and the choke lever in the "Off Choke" position; then, pull the rope to clear the engine of excess fuel. This could require pulling the starter rope *many times* depending on how badly the unit is flooded.

If the unit still doesn't start, call the Customer Assistance Helpline at 1-800-554-6723.

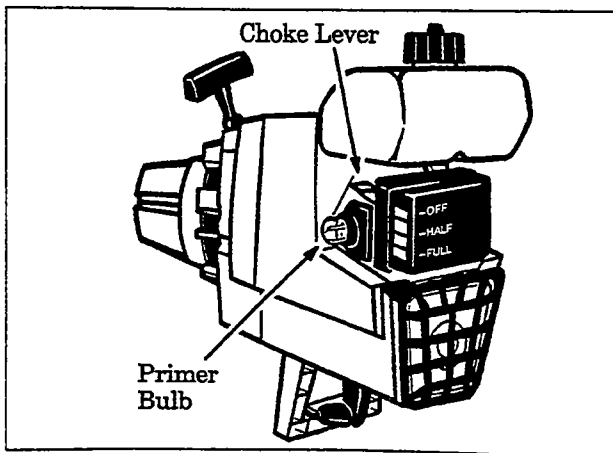
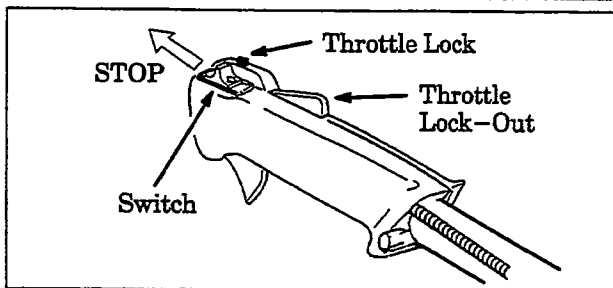
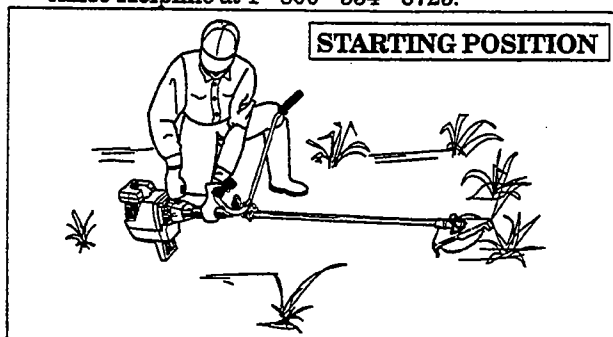

OPERATING INSTRUCTIONS

- When using the blade, bring the engine to full throttle before entering the material to be cut. The Blade has maximum cutting power at full throttle and is less likely to bind, stall, or cause blade thrust, which can result in serious injury to the operator or others. Refer to "Guard Against Blade Thrust".
- When using the trimmer head, do not run the engine at a higher speed than necessary. The cutting line will cut efficiently when the engine is run at less than full throttle. At lower speeds, there is less engine noise and vibration. The cutting line will last longer and will be less likely to "weld" onto the spool.
- If the blade or trimmer head does not turn when the engine is accelerated, make sure the drive shaft housing is properly seated in the engine shroud. Refer to "Assembly Steps-Tube."
- Always release throttle trigger and allow engine to return to idle speed when not cutting.
- The blade or trimmer head should not turn when the engine runs at idle speed. If the blade or trimmer head turns when the engine is at idle speed, refer to the "Trouble Shooting Chart."
- To stop engine:
 - Release the throttle trigger.
 - Move ignition switch to the "Off" position.
 - Stop the blade by allowing the "9 o'clock" position to contact cut material. Figure 8.

▲ WARNING
The blade continues to spin after the engine is turned off. The coasting blade can throw objects or seriously cut you if accidentally touched. Stop the blade by contacting the left-hand side of the coasting blade with material already cut.

▲ WARNING
Stop engine and blade before removing materials wrapped around the blade shaft to avoid injury.

▲ WARNING
The operator or others must not try to clear away cut material with the engine running or the blade turning to avoid serious injury.

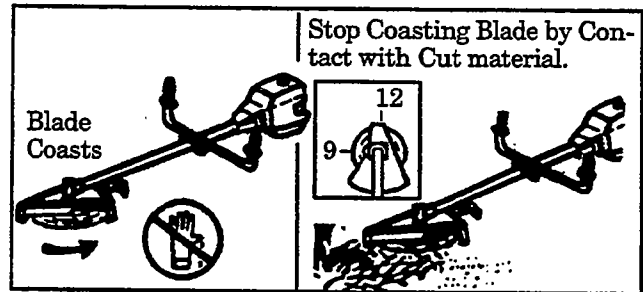

USING YOUR UNIT AS A LINE TRIMMER

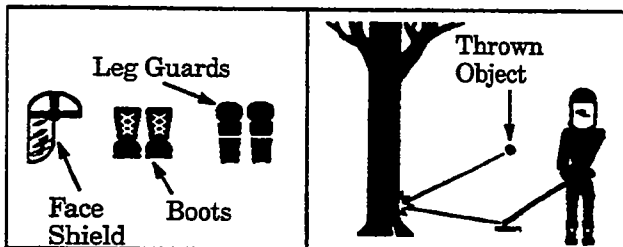

▲ WARNING—THROWS OBJECTS

The rapidly moving line causes objects to be thrown violently. The shield will not provide complete protection to the operator or others. The operator must wear a safety face shield or goggles. Always wear heavy, long pants and boots. Keep others at least 50 feet (15 meters) away.

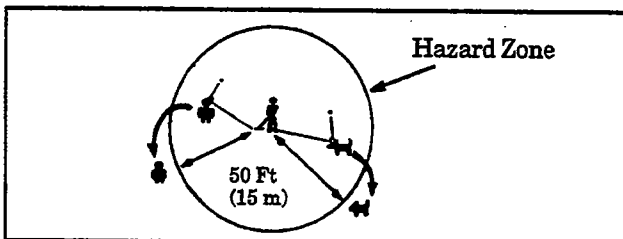

▲ WARNING – HAZARD ZONE

This tool will throw objects and cut. Keep others including children, animals, bystanders and helpers at least 50 feet (15 meters) away from the operator and tool. Stop the engine if you are approached.



▲ WARNING – DAMAGED TRIMMER HEAD

Trimmer head parts that are chipped, cracked or damaged in any other way can fly apart and cause serious injury. Do not use. Replace damaged parts before using the tool.

A. LINE TRIMMER SAFETY

1. OPERATOR SAFETY

- Always wear eye protection when operating, servicing, or performing maintenance on your unit. See "Safety Accessories."
- Do not operate this tool when you are tired, ill or under the influence of alcohol, drugs, or medication.

- c. Always wear heavy, long pants, long sleeves, boots, and gloves. Do not go barefoot or wear sandals, short pants, short sleeves, jewelry, loose clothing, or clothing with loosely hanging straps, ties, tassels, etc.; they can be caught in moving parts. Secure hair so it is above shoulder length. Being fully covered will help protect you from pieces of toxic plants such as poison ivy thrown by the blade, which could be more of a hazard than touching the plant itself.
- d. Do not swing the tool with such force that you are in danger of losing your balance.
- e. Never start or run the engine inside a closed room or building. Breathing exhaust fumes can kill.
- f. Keep handles free of oil and fuel.

2. TOOL SAFETY

- a. Inspect the entire tool before each use. Replace damaged parts. Check for fuel leaks and make sure all fasteners are in place and securely fastened.
- b. Use only .080" (2 mm) diameter WEED EATER brand line. Never use wire or rope, string, etc.
- c. Be sure the shield is properly attached.

- d. Make sure trimmer head is properly installed and securely fastened. Refer to "Assembly."
- e. Be sure trimmer head stops turning when engine idles. See "Carburetor Adjustments."
- f. Make carburetor adjustments with the drive shaft housing supported to prevent the trimmer line from contacting any object.
- g. Keep others away when making carburetor adjustments.
- h. Use only WEED EATER accessories or attachments as recommended.

3. CUTTING SAFETY

- a. Inspect the area to be cut before each use. Remove objects (rocks, broken glass, nails, wire, string, etc.) which can be thrown or become entangled in the trimmer head.
- b. Always keep the engine on the right side of your body.
- c. Hold the tool firmly with both hands.
- d. Keep firm footing and balance. Do not over-reach.
- e. Keep the trimmer head below waist level.
- f. Do not raise the engine above your waist.
- g. Keep all parts of your body away from the trimmer line and muffler when engine is running.
- h. Use only for jobs explained in this manual.

B. TRIMMER LINE ADVANCE

- The trimmer line will advance approximately 2 inches each time the bottom of the trimmer head is tapped on the ground with the engine running at full throttle.
- The most efficient line length is the maximum length allowed by the line limiter.
- Always keep the shield in place when the tool is being operated. Figure 9.
- To Advance Line:
 1. Operate the engine at full throttle.
 2. Hold the trimmer head parallel to and above the grassy area.
 3. Tap bottom of trimmer head lightly on ground one time. Figure 9. Approximately 2" (5 cm) of line will be advanced with each tap.

NOTE: Always tap trimmer head on a grassy area. Tapping on surfaces such as concrete or asphalt can cause excessive wear to the trimmer head.

NOTE: If the line is worn down to two inches or less, more than one tap will be required to obtain the most efficient line length.

▲ WARNING

Use only .080" (2 mm) diameter WEED EATER brand line. Other sizes of line will not advance properly. Do not use other materials such as wire, string, rope, etc. Wire can break off during cutting and become a dangerous missile that can possibly cause serious injury.

▲ WARNING

Use minimum speed and do not crowd the line when cutting around hard objects (rock, gravel, fence posts, etc), which can damage the trimmer head, become entangled in the line, or be thrown causing a serious hazard.

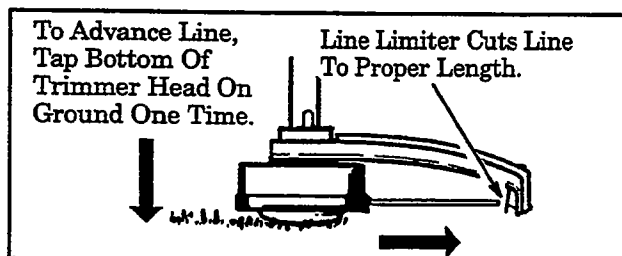

Figure 9

C. CUTTING METHODS

- The tip of the line does the cutting. You will achieve the best performance and minimum line wear by not crowding line into cutting area. The right and wrong ways are shown in Figure 10.
- For trimming or scalping, use less than full throttle to increase line life, especially:
 - during light duty cutting.
 - near objects around which the line can wrap such as small posts, trees or fence wire.

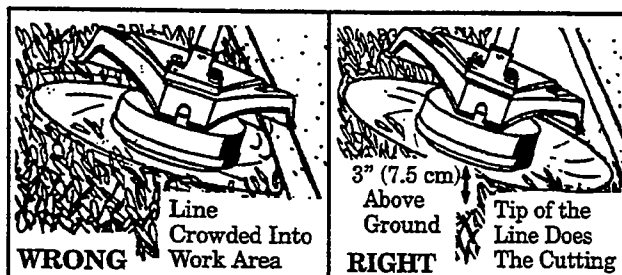

Figure 10

- The line will easily remove grass and weeds from around walls, fences, trees and flower beds, but it also can cut the tender bark of trees or shrubs and scar fences. To help avoid damage especially to delicate vegetation or trees with tender bark, shorten line to 4-5" (10-13 cm) and use at less than full throttle.
- For mowing or sweeping, use full throttle for a good clean job.

▲ WARNING

Use minimum speed and do not crowd the line when cutting around hard objects (rock, gravel, fence posts, etc), which can damage the trimmer head, become entangled in the line, or be thrown causing a serious hazard.

▲ WARNING

Always wear eye protection. Never lean over the trimmer head. Rocks or debris can ricochet or be thrown into eyes and face and cause blindness or other serious injury.

1. **TRIMMING** - Figure 11 . Hold bottom of the trimmer head about 3" (7.5 cm) above ground and at an angle. Allow only the tip of the line to make contact. Do not force trimmer line into work area.
2. **SCALPING** - Figure 12 . The scalping technique removes unwanted vegetation. Hold the bottom of the trimmer head about 3" (7.5 cm) above the ground and at an angle. Allow the tip of the line to strike ground around trees, posts, monuments, etc. *This technique increases line wear.*
3. **MOWING**- Figure 13 . Your trimmer is ideal for mowing in places conventional lawn mowers cannot reach. In the mowing position, keep the line parallel to the ground. Avoid pressing the head into the ground as this can scalp the ground and damage the tool.
4. **SWEEPING** - Figure 14 . The fanning action of the rotating line can be used for a quick and easy clean up. Keep the line parallel to and above surfaces being swept and move tool from side to side.

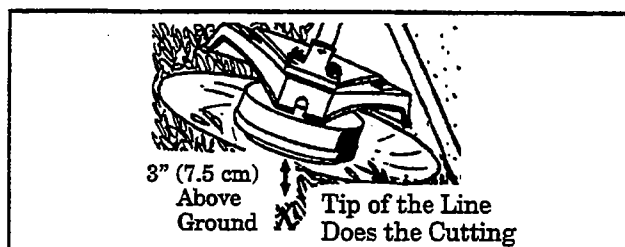

Figure 11

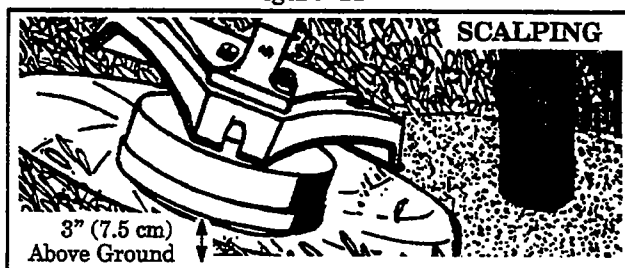

Figure 12

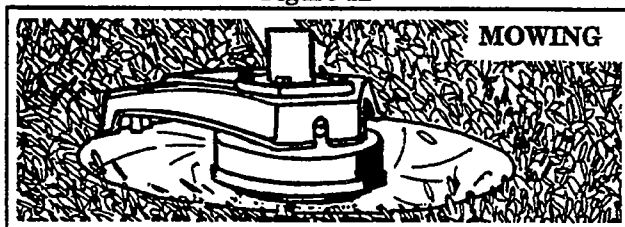

Figure 13

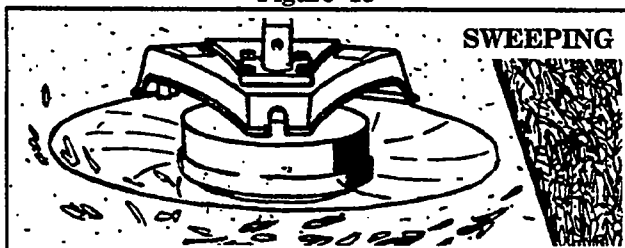

Figure 14

D. LINE REPLACEMENT

- For proper line feed:
 - Use only genuine WEED EATER pre-wound spools and .080" (2 mm) diameter WEED EATER brand line. Use of other types of spools or lines can result in excessive breakage, line welding and improper line feed.
 - Pre-wound spools offer the most convenient method for replacing line as well as optimum performance.
- Always clean dirt and debris from spool and hub when performing any type maintenance.

1. Installing Spool with Line

- a. Hold the trimmer head as shown in Figure 15 . Press the lock tab and turn the lock ring as shown in Figure 15 .
- b. Remove the lock ring, tap button, and spool. Figure 16 .
- c. Clean dirt and debris from all parts.
- d. Inspect all trimmer head parts for damage. Replace damaged parts.

▲ WARNING

Trimmer head parts that are chipped, cracked, broken, or damaged in any other way can fly apart and cause serious injury. Do not use. Replace damaged parts before using the tool.

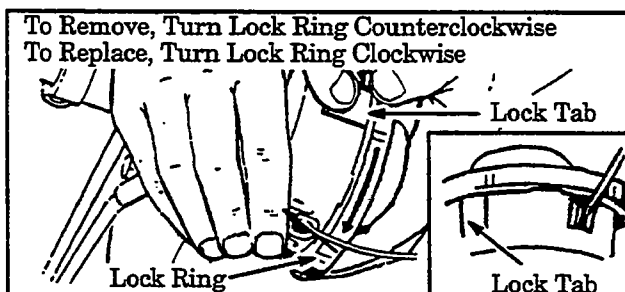

Figure 15

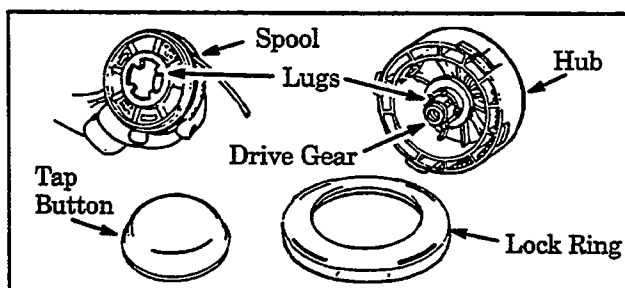

Figure 16

NOTE: The aluminum line saver (Figure 17) can become worn during use. After a groove is worn into line saver, remove it from trimmer head, turn it upside down, and reinstall it (with spool removed) to provide a new wear surface.

▲ WARNING

The line saver must be installed only from the inside of the trimmer head. If installed on the outside of the trimmer head, the line saver can fly off and become a dangerous missile.

- e. Insert the end of the line through the line saver. Figure 17. Place spool in trimmer head. Press spool down, then turn it enough to lock lugs on spool under lugs on drive gear. Figure 16.

NOTE: Make sure the line is not caught between the rim of spool and the wall of trimmer head.

- f. Replace the tap button. Align the lock ring over the catches on the hub; push the lock ring down on the hub and turn it clockwise until the catches lock into place. Figure 17.

▲ WARNING

All catches must be fastened and the lock tab latched in the Lock Ring. If installed incorrectly, the Lock Ring can fly off and become a dangerous missile.

- g. Make sure lock ring is properly fastened by pulling on it and trying to turn it counterclockwise. If it comes off, reinstall it properly.
- h. Pull on the line to change the spool from the locked position to the operating position.
- i. Obtain correct line length, 4–6" (10–15 cm) by pressing the tap button (Figure 18) and pulling on the line again.

NOTE: Each time the tap button is pressed, approximately 2" (5 cm) of line can be pulled from the trimmer head. Figure 18.

2. Spool Replacement

- a. Replace the spool when the square corners on the lugs are rounded off, reduced in size, or broken off. Figure 19.
- b. To replace the spool, follow the instructions in "Installing Spool with Line."

3. Installing Line on Spool

To replace the Line on existing Spool:

- a. Follow "Installing Spool w/Line," steps "a.–d." and remove any line remaining on the spool.
- b. Use a 40 foot (12 m)) length of .080" (2 mm) WEED EATER brand line.
- c. Insert 1/16" – 1/8" (1.5–3 mm) of the end of the line through the hole in the spool. Figure 20. Allow no more than 1/8" (3 mm) line to extend inside the spool.
- d. Wrap the line onto the spool firmly and evenly in the direction shown by the arrow on the spool. Figure 20.

NOTE: The line must be wrapped firmly and evenly for proper line feed.

- e. Follow "Installing Spool with Line," steps "e.–i."

If the line breaks off or backs up in the trimmer head, follow "Installing Spool w/Line," steps "a.–d." Pull slack in line until the line is tightly wound on the spool, leaving 4–6 inches of extended line. Continue with steps "e.–i."

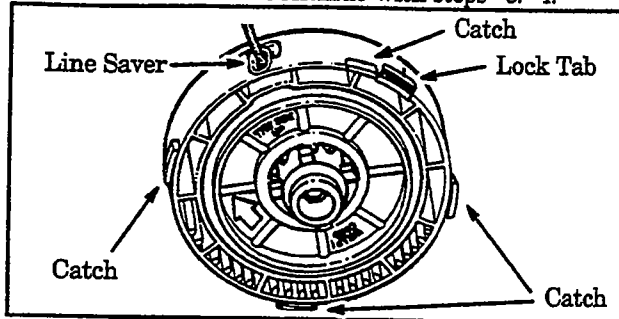

Figure 17

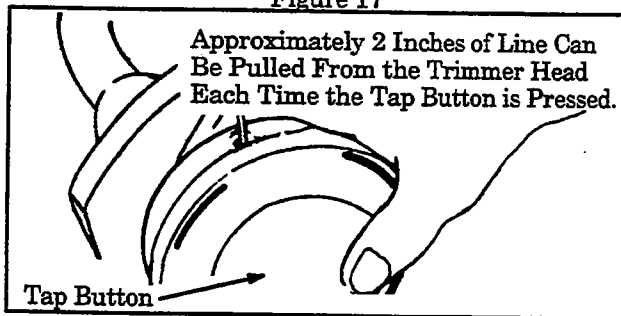

Figure 18

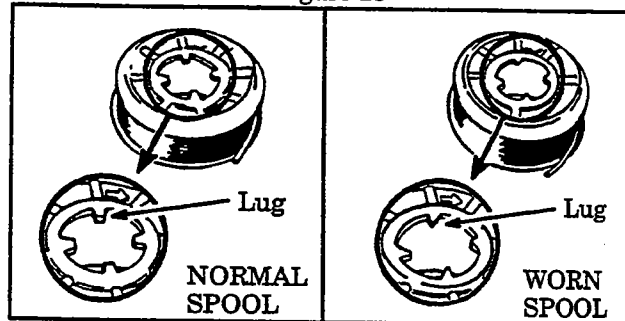

Figure 19

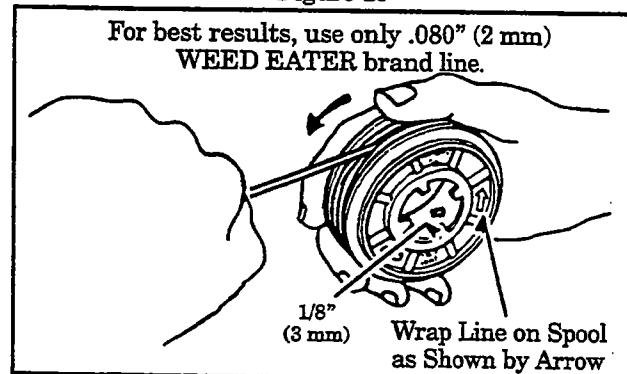
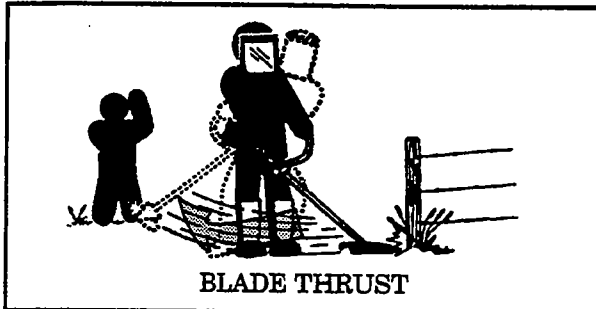

Figure 20

USING YOUR UNIT AS A BRUSHCUTTER

The 8" (20 cm) Brush Blade is designed to cut grass, weeds, and woody brush and small trees up to 2" (5 cm) in diameter.

▲ DANGER – THIS POWER TOOL CAN BE DANGEROUS! This unit can cause serious injury including amputation or blindness to the operator and others. The warnings and safety instructions in this manual must be followed to provide reasonable safety and efficiency in using this unit. The operator is responsible for following the warnings and instructions in this manual and on the unit. Read the entire Operator's Manual before using this unit! Restrict the use of this power tool to persons who read, understand, and follow the warnings and instructions in this manual and on the unit.



▲ DANGER – BLADE THRUST When the spinning blade contacts anything it does not cut, a dangerous reaction can occur causing the entire unit and operator to be thrust violently in any direction. This reaction is called Blade Thrust. As a result, the operator can lose control of the unit. Use handlebar, shoulder strap, and keep shield in place. Make sure others are at least 50 feet (15 meters) away. Keep blade sharp. Cut at full throttle and from your right to left. Keep hands, feet and unit in proper position; refer to "Guard Against Blade Thrust."

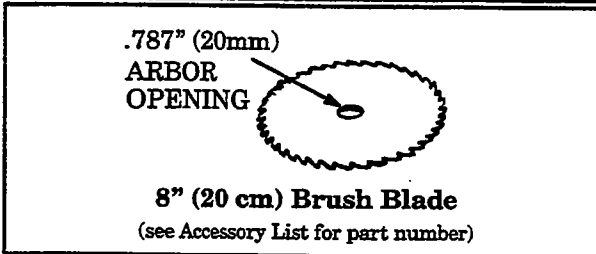

▲ DANGER – PROPER BLADE Use only the 8" (20 cm) Brush Blade and proper hardware as shown. The use of any other parts can result in serious injury. Do not use any accessory or attachment other than those recommended by the manufacturer for use with this unit. Blades that are bent, warped, cracked, broken, or damaged can fly apart and cause serious injury. Do not use; Throw away.

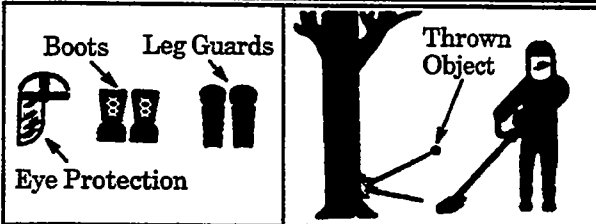

▲ WARNING – THROWS OBJECTS The rapidly moving blade causes objects to be thrown violently. The shield will not provide complete protection to the operator or others. The operator must wear a safety face shield or goggles. Always wear safety leg guards and boots.

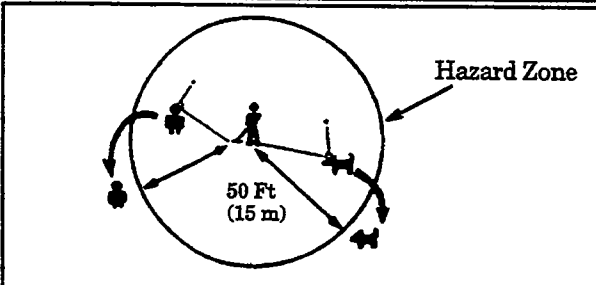

▲ WARNING – HAZARD ZONE This unit will throw objects and cut. Keep others including children, animals, bystanders, and helpers at least 50 feet (15 meters) away from the operator and unit. Stop the engine and blade immediately if you are approached.



NOTE: In areas where other people and animals are present, such as near sidewalks, streets, houses, etc., it is strongly recommended that the operator use the buddy system; that is, have another person serve as a "look out," keeping himself and others at least 50 feet (15 meters) away from the operator.

▲ WARNING – COASTING BLADE The blade continues to spin after the engine is stopped or the throttle is released. The coasting blade can thrust, throw objects, or seriously cut you if accidentally touched. Stop the blade by leaving it in contact with material already cut. Use the "9 o'clock" position as the point of contact.

A. BLADE SAFETY

1. OPERATOR SAFETY

- Always wear eye protection when operating, servicing, or performing maintenance on your unit. See "Safety Accessories."
- Always wear heavy, long pants, long sleeves, boots, and gloves. Do not go barefoot or wear sandals, jewelry, short pants, short sleeves, loose clothing, or clothing with loosely hanging straps, ties, tassels, etc.; they can be caught in moving parts. Secure hair so it is above shoulder length. Being fully covered will help protect you from pieces of toxic plants such as poison ivy thrown by the blade, which could be more of a hazard than touching the plant itself.
- Do not operate this unit when you are tired, ill, or under the influence of alcohol, drugs, or medication.
- Always use the handlebar and a properly adjusted shoulder strap. See "Assembly."
- Do not swing the unit with such force that you are in danger of losing your balance.
- Never start or run the engine inside a closed room or building. Breathing exhaust fumes can kill.
- Keep handles free of oil and fuel.

2. UNIT SAFETY

- Inspect the entire unit before each use. Replace damaged parts. Check for fuel leaks and make sure all handles, guards, and fasteners are in place and securely fastened.

- Be sure the metal shield is properly attached. The metal shield *must* be installed for all blade usage.
- Make sure the blade is properly installed and securely fastened. Refer to "Assembly."
- Be sure the blade stops turning when the engine idles. See "Trouble Shooting Chart."
- Make carburetor adjustments with the drive shaft housing supported to prevent the blade from contacting any object. Hold unit by hand; do not use the shoulder strap for support.
- Keep others away when making carburetor adjustments.
- Have all maintenance and service not explained in this manual performed by an Authorized Service Dealer.

3. CUTTING SAFETY

- Inspect the area to be cut before each use. Remove objects (rocks, broken glass, nails, wire, string, etc.) which can be thrown or become entangled in the blade.
- Always keep the engine on the right side of your body. Hold the unit firmly with both hands.
- Keep firm footing and balance. Do not over-reach.
- Keep blade below waist level.
- Do not raise the engine above your waist. The blade can come dangerously close to your body.
- Cut at full throttle.
- Cut from your right to your left.
- Use only for jobs explained in this manual. Do not use the blade as an edger. The shield does not provide adequate protection.

B. GUARD AGAINST BLADE THRUST

- Blade Thrust* is a reaction that only occurs when using a bladed unit. This reaction can cause serious injury such as amputation. Carefully study this section. It is important that you understand what causes *blade thrust*, how you can reduce the chance of its occurring, and how you can remain in control of the unit if *blade thrust* occurs.
- The forward tip on the shield helps to reduce the occurrence of *blade thrust* but cannot prevent the occurrence. The operator must follow all warnings and safety instructions in this section to lessen the chance of *blade thrust* occurring and to maintain control of unit if the reaction does occur.

1. WHAT CAUSES BLADE THRUST *Blade Thrust* can occur when the spinning blade contacts an object that it does not cut. This contact causes the blade to stop for an instant and then suddenly move or "thrust" away from the object that was hit. The "thrusting" reaction can be violent enough to cause the operator to be propelled in any direction and lose control of the unit. The uncontrolled unit can cause serious injury if the blade contacts the operator or others. Figure 21.

2. WHEN BLADE THRUST OCCURS. *Blade thrust* can occur without warning if the blade snags, stalls, or binds. This is more likely to occur in areas where it is difficult to see the material being cut. By using the unit properly, the occurrence of *blade thrust* will be reduced and the operator will be less likely to lose control.

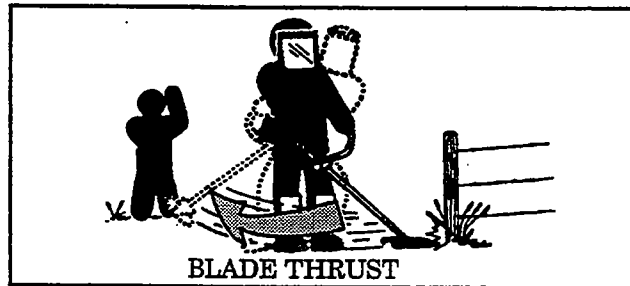

Figure 21

3. REDUCE THE CHANCE OF BLADE THRUST

- Cut only grass, weeds, and woody brush up to 2" (5 cm) in diameter with the brush blade. Do not let the blade contact material it cannot cut such as stumps, rocks, fences, metal, etc., or clusters of hard, woody brush having a diameter greater than 2" (5 cm).
- Keep the blade sharp. A dull blade is more likely to snag and thrust.
- Cut only at full throttle. The blade has maximum cutting power at full throttle and is less likely to bind or stall.
- "Feed" the blade deliberately and not too rapidly. The blade can thrust away if it is fed too rapidly.
- Cut only from your right to your left. Swinging the unit in the same direction as the blade spins increases the cutting action.

4. MAINTAIN CONTROL

- a. Use the shoulder strap and keep a firm grip on the unit with both hands. A properly adjusted shoulder strap will support the weight of the unit, freeing your arms and hands to control and guide the cutting motion.
- b. Keep feet comfortably spread apart and braced for the possibility of a sudden, rapid thrust of the unit. Do not overreach. Keep firm footing and balance.
- c. Keep the blade below waist level. It will be easier to maintain control of the unit.
- d. Do not raise the engine above your waist as the blade can come dangerously close to your body.
- e. Do not swing the unit with such force that you are in danger of losing your balance.

C. CUTTING METHODS

1. Establish a rhythmic cutting procedure.
 - a. Plant feet firmly, comfortably apart.
 - b. Cut while swinging the upper part of your body from right to left.
 - c. Move forward to the next area to be cut after the return swing and plant feet once more.
2. Use the 8 o'clock to 10 o'clock position for cutting. Figure 22.
3. Stop the engine and blade, then unclip the shoulder strap from unit before clearing cut material.
4. To reduce the chance of material wrapping around the blade, follow these steps:
 - a. Cut at full throttle.
 - b. Swing the unit into material to be cut from your right to your left.
 - c. Avoid the material just cut as you make the return swing.

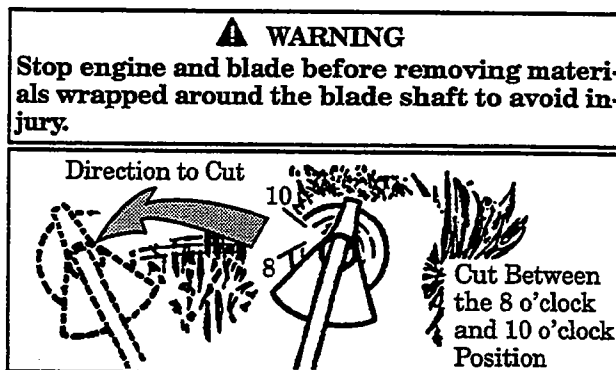
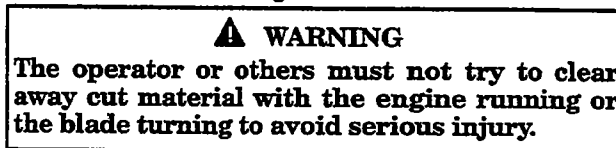

Figure 22



ACCESSORIES

ITEM	STOCK NO.
SAFETY FACE SHIELD	952-701601
SAFETY GLASSES	952-701645
SAFETY LEG GUARDS	952-701600
TAP-N-GO I TRIMMER HEAD	952-701643
SPOOL W/LINE	952-701523
NYLON CUTTING LINE (.080 dia.)	
80 Ft.	952-701534
200 Ft.	952-701595
400 Ft.	952-701590
FUEL CAP	952-701583
FLEX SHAFT LUBE	952-701570
AIR FILTER	952-701614
WEED EATER® 40:1 2-CYCLE ENGINE OIL	
--3.2 oz.	952-030133
--8 oz.	952-030128
--19.6 oz.	952-031138
8" BRUSH BLADE	952-701610
OPTIONAL 4 POINT, 8" WEED BLADE	952-701611
SPARK PLUG	530-030075

GENERAL MAINTENANCE

A. MAINTENANCE SAFETY

1. Maintain the unit according to recommended procedures. Keep cutting line at the proper length.
2. Never start engine with clutch shroud removed. The clutch can fly apart and cause serious injury.
3. Disconnect the spark plug before performing maintenance except for carburetor adjustments.
4. Make carburetor adjustments with the lower end supported to prevent the trimmer line from contacting any object.
5. Keep others away when making carburetor adjustments.
6. Be sure blade or trimmer head stops turning when engine idles. See "Carburetor Adjustments."
7. Replace blade or trimmer head parts that are cracked, chipped, or damaged in any other way before using the unit.
8. Use only .080" (2 mm) diameter WEED EATER brand line. Never use wire, rope, string, etc.
9. Use only genuine WEED EATER replacement parts as recommended.
10. Inspect the entire unit. Replace damaged parts. Check for fuel leaks and make sure all fasteners are in place and securely fastened.

B. FLEXIBLE DRIVE SHAFT LUBRICATION

- Lubricate the drive shaft:
 - After each ten (10) hours of operation.
 - Before operating if the unit has been stored for 90 days or longer.
- To order flex shaft lube, see the Accessory List for the proper part number.

▲ WARNING

If the engine is hot, avoid touching the muffler. A hot muffler can cause serious burns.

CAUTION: Lay the drive shaft on a clean surface. Avoid laying shaft on the floor, ground or on any other surface that may have dirt or debris. Even after wiping the shaft, grease residue can pick up particles that can cause damage or premature failure.

CAUTION: Take care to avoid injury to your hands and fingers with broken wires when checking for damage or wiping the drive shaft. A cloth will not prevent broken wires from puncturing or tearing your skin.

1. Remove the gear box clamp screw and the locating screw from the gear box. Figure 23.
2. Remove gear box from the tube. Figure 23.
3. Remove the drive shaft from the tube. Figure 23 (inset).

4. Check drive shaft for broken wires, twists, or kinks, and replace if damage is found.
5. Using a clean cloth, wipe the surface of the drive shaft thoroughly to remove any old grease.
6. Apply a uniform coat of lube to the entire surface of the drive shaft.
7. Inject the remaining contents of the container into the top of the tube.
8. Reinstall the drive shaft in the tube. Figure 23 (inset).
9. Reassemble the gear box to the tube. Tighten screws securely.

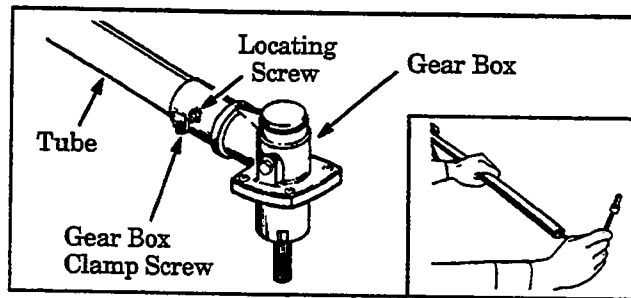

Figure 23

C. AIR FILTER

NOTE: A dirty air filter decreases the life and performance of the engine and increases fuel consumption.

1. Clean the Air Filter:

- Always after 5 tanks of fuel or 5 hours of operation, whichever is less.
- More frequently, in dusty conditions.
 - a. Loosen the two screws on the air filter cover enough to remove the cover from the engine. Figure 24.
 - b. Remove air filter from cover. Figure 24.
 - c. Wash filter in soap and water.
 - d. Squeeze filter dry and replace in cover.

CAUTION: Do not clean the air filter in gasoline or other flammable solvent to avoid creating a fire hazard.

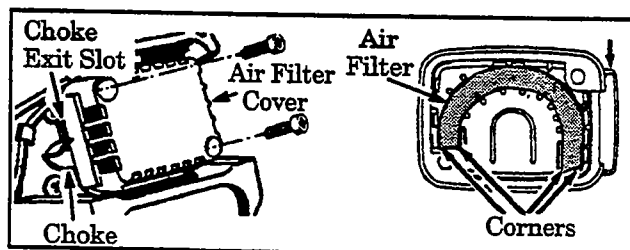

Figure 24

- e. Reinstall the air filter cover, making sure the choke exit slot (Figure 24) is placed over the choke lever.

CAUTION: Make sure air filter is fitted into corners of the cover to keep dust from entering engine and causing engine damage.

NOTE: If replacing the air filter, see the Accessory List for the proper part number.

D. CARBURETOR ADJUSTMENTS

NOTE: This is a complicated task. Read all warnings and instructions thoroughly before starting adjustments. If you do not think that you completely understand all warnings and instructions, let your Authorized Service Dealer perform these adjustments.

▲ WARNING

Make carburetor adjustments with the lower end supported to prevent blade or trimmer line from contacting any object. Hold unit with your hand; do not use optional shoulder strap for support.

▲ WARNING

Keep others away when making carburetor adjustments.

▲ WARNING

Serious injury to the operator and others can occur if the carburetor is not properly adjusted.

- Poor engine performance can be a result of other causes such as dirty air filter, carbon build-up on muffler outlets, etc. See "Trouble Shooting Chart" before proceeding with carburetor adjustments.
- For best results, it is recommended that you have an Authorized Service Dealer make all carburetor adjustments. Your dealer has the training, experience, and tools necessary to properly adjust your unit to meet our factory performance specifications. *This service is not covered by warranty.* If it becomes necessary for you to make carburetor adjustments yourself, follow the described procedures very carefully.
- Very small adjustments can affect engine performance. It is important to turn the screw a very small amount per adjustment and test performance before making further adjustments. Each adjustment should be no more than the width of the slot in the adjusting screw.
- This is a complicated task and it is important to follow instructions in sequence as indicated.

1. TROUBLE SHOOTING SUGGESTIONS

- Engine will not continue to run at idle position. See "Idle Speed Adjustment" and "Low Speed Mixture Adjustment."
- Blade or trimmer head continues to spin when the engine idles. See "Idle Speed Adjustment."
- Engine dies or hesitates when it should accelerate. See "Acceleration Check."
- Loss of cutting power which cannot be corrected by cleaning the air filter. See "High Speed Mixture Adjustment."
- Engine will not run. See "Trouble Shooting Chart." Then, if the carburetor requires adjustment, begin with "Basic Carburetor Settings."

▲ WARNING

The blade or trimmer line will be spinning during most of this procedure. Wear protective equipment and observe all safety instructions.

2. BASIC CARBURETOR SETTINGS

NOTE: In most cases, your engine can be made to run properly with minor carburetor adjustments. Refer to "Trouble Shooting Suggestions" in the left column for the condition you are experiencing and follow the instructions. The basic carburetor settings are provided below.

Turn the low speed screw and the high speed screw (Figure 25) clockwise until they stop. *Do not turn the screws until they are tight as damage to the needle seats can occur.*

3. ADJUSTING PROCEDURE

a. PREPARATION

1. Use a fresh fuel mix. See "Fueling Your Engine."
2. Make sure the line extends to the length allowed by the line limiter to provide correct load on engine.
3. Start the engine. Cut grass for 3 minutes to warm engine. *The engine must be at operating temperature before carburetor adjustments can be performed correctly.*

b. IDLE SPEED ADJUSTMENT

1. Allow engine to idle.
2. Adjust idle speed screw (Figure 25) until engine continues to run without stalling and without blade or trimmer head moving.
 - Turn screw clockwise to increase engine speed if the engine stalls or dies.
 - Turn screw counterclockwise to slow engine down and/or to keep blade or trimmer head from turning.
3. Follow instructions in "Acceleration Check."
4. No further adjustments are necessary if the blade or trimmer head does not turn at idle speed and if performance is satisfactory.

▲ WARNING

Recheck idle speed after each adjustment. The blade or trimmer head must not turn at idle speed to avoid serious injury to the operator and others.

c. ACCELERATION CHECK

1. Allow engine to idle.
2. Squeeze trigger fully
 - a. If performance is satisfactory, proceed to "d. Low Speed Mixture Adjustment."
 - b. If the engine does not accelerate smoothly, turn the low speed mixture screw (Figure 25) counterclockwise a small amount (no more than the width of the slot in the adjusting screw).
3. Repeat step "2." until smooth acceleration is obtained. *Do not turn the screws until they are tight as damage to the needle seats can occur.*

NOTE: It may be necessary to repeat "Idle Speed Adjustment" through "Acceleration Check," to obtain correct adjustments.

d. LOW SPEED MIXTURE ADJUSTMENT

1. Allow engine to idle.
2. Turn the low speed screw (Figure 25) slowly clockwise until the speed starts to drop. Note this position.
3. Turn the low speed screw counterclockwise until the speed increases and then starts to drop again. Note this position.
4. Set the low speed screw at the midpoint between the two positions.
5. Follow instructions in "Acceleration Check."

e. HIGH SPEED MIXTURE ADJUSTMENT

CAUTION: Do not operate engine at full throttle for prolonged periods while making high speed adjustments as damage to the engine can occur.

1. Allow engine to idle, then squeeze throttle trigger fully.

NOTE: Perform steps "2." through "4." at full throttle.

2. Turn high speed screw (Figure 25) very slowly clockwise until engine speed is reduced.
3. Turn high speed screw very slowly counterclockwise. Stop when the engine begins to run roughly.

4. Turn screw slowly the minimum amount clockwise until the engine runs smoothly.
5. Follow instructions in "Acceleration Check."

CAUTION: If the engine does not operate according to these instructions after repeating the adjusting steps, do not use the unit. Take it to your Authorized Service Dealer.

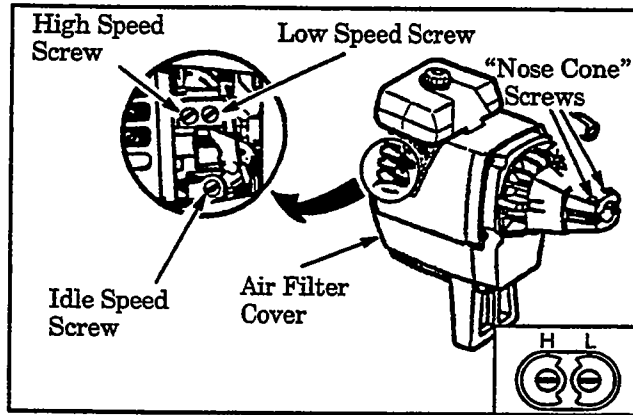

Figure 25

E. SPARK PLUG & IGNITION TIMING

- Replace spark plug yearly. Ignition timing is fixed; nonadjustable.



F. BLADE SHARPENING

▲ WARNING

Always stop the engine before sharpening a blade. The blade will continue to spin after the engine stops or after the throttle trigger has been released. Make sure the blade has stopped coasting and disconnect spark plug before performing work on the blade.

1. Check blades for flatness periodically. Lay the blade on a flat surface and inspect the blade for flatness before sharpening. Throw away a blade that is not flat.
2. File or grind each edge in the same manner to maintain a balanced blade. Figure 26.

▲ WARNING

Always replace a blade that is bent, warped, cracked, or damaged in any other way. Never attempt to straighten and re-use a damaged blade. Use only the specified replacement blade.

CAUTION: Wear protective gloves when handling or performing maintenance on the blade to help avoid injury.

▲ WARNING

To prevent blade from cracking or flying apart after sharpening, do not file within 1/4" (6 mm) of the radii shown in Figure 26.

BRUSH BLADE

File Or Grind
Blade As Shown

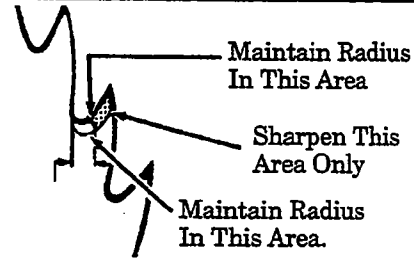
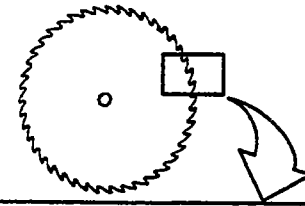

Figure 26

G. OPTIONAL 4 Point, 8" (20 cm) Weed Blade

▲ WARNING

Always stop the engine before sharpening a blade. The blade will continue to spin after the engine stops or after the throttle trigger has been released. Make sure the blade has stopped coasting and disconnect the spark plug before performing work on the blade.

1. The 4 point, 8" (20 cm) blade is reversible. When the cutting edge on one side becomes dull, turn the blade over. When both sides of cutting edges become dull, the blade may be resharpened.
2. Check blades for flatness periodically. Lay the blade on a flat surface and inspect the blade for flatness before sharpening. Throw away a blade that is not flat.
3. File or grind each edge in the same manner to maintain a balanced blade. Figure 26.

▲ WARNING

Always replace a blade that is bent, warped, cracked, or damaged in any other way. Never attempt to straighten and re-use a damaged blade. Use only the specified replacement blade.

CAUTION: Wear protective gloves when handling or performing maintenance on the blade to help avoid injury.

▲ WARNING

To prevent blade from cracking or flying apart after sharpening, do not file within 1/4" (6 mm) of the radii shown in Figure 26.

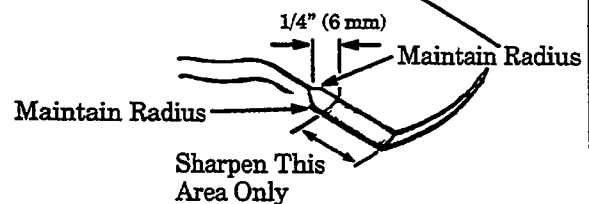
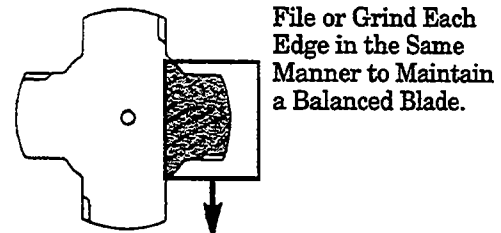

Figure 27

H. TROUBLE SHOOTING CHART

SYMPTOM	CAUSE	REMEDY
Engine will not start or will run only for a few seconds after starting.	<ol style="list-style-type: none"> 1. Fuel tank empty. 2. Engine flooded. 3. Spark plug not firing. 4. Fuel not reaching carburetor. 5. Carburetor requires adjustment. 6. None of the above. 	<ol style="list-style-type: none"> 1. Fill tank with correct fuel mixture 2. See "Starting Instructions." 3. Install new plug/check ignition system. 4. Clean fuel filter; inspect fuel line. 5. See "Carburetor Adjustments." 6. Contact your Service Dealer.
Engine will not idle properly.	<ol style="list-style-type: none"> 1. Carburetor requires adjustment. 2. None of the above. 3. Throttle trigger screw too tight. 	<ol style="list-style-type: none"> 1. See "Carburetor Adjustments." 2. Contact your Authorized Service Dealer. 3. See the "Throttle Cable" section.
Engine will not accelerate, lacks power, or dies under a load.	<ol style="list-style-type: none"> 1. Air filter dirty. 2. Spark plug fouled. 3. Carburetor requires adjustment. 4. Muffler outlets plugged. 5. None of the above. 	<ol style="list-style-type: none"> 1. Clean or replace air filter. 2. Clean or replace spark plug and re-gap. 3. See "Carburetor Adjustments." 4. Contact your Authorized Service Dealer. 5. Contact your Authorized Service Dealer.
Engine smokes excessively.	<ol style="list-style-type: none"> 1. Air filter dirty. 2. Fuel mixture incorrect. 3. Carburetor requires adjustment. 	<ol style="list-style-type: none"> 1. Clean or replace air filter. 2. Refuel with correct fuel mixture. 3. See "Carburetor Adjustments."
Engine runs hot.	<ol style="list-style-type: none"> 1. Fuel mixture incorrect. 2. Carburetor requires adjustment. 3. Spark plug incorrect. 4. None of the above. 	<ol style="list-style-type: none"> 1. See "Fueling Your Unit." 2. See "Carburetor Adjustments." 3. Replace with correct plug. 4. Contact your Authorized Service Dealer.
Cutting attachment turns at idle speed.	<ol style="list-style-type: none"> 1. Carburetor requires adjustment. 2. Throttle cable binding. 3. Clutch requires repair. 	<ol style="list-style-type: none"> 1. See "Carburetor Adjustments." 2. Contact your Authorized Service Dealer. 3. Contact your Authorized Service Dealer.
Cutting attachment stops under a load or does not turn when engine is accelerated.	<ol style="list-style-type: none"> 1. Drive Shaft not engaged. 2. Drive shaft broken. 3. Carburetor requires adjustments. 4. Clutch requires repair. 	<ol style="list-style-type: none"> 1. See "Assembly, "Tube." 2. Contact your Authorized Service Dealer. 3. See "Carburetor Adjustments." 4. Contact your Authorized Service Dealer.
Line does not advance or breaks while cutting.	<ol style="list-style-type: none"> 1. Line improperly routed in head. 2. Line improperly wound onto spool. 3. Line size incorrect. 4. Too little line outside head. 5. Dirt accumulated on cover cut-outs. 	<ol style="list-style-type: none"> 1. Remove cover. Check line routing. 2. Rewind line tightly and evenly. 3. Use only .080" (2 mm) line. 4. Remove cover. Pull 4" (10 cm) of line out. 5. Clean cover cut-outs.
Line welds on spool.	<ol style="list-style-type: none"> 1. Line size incorrect. 2. Incorrect spool. 3. Crowding line against material being cut. 4. Cutting at higher speed than necessary. 	<ol style="list-style-type: none"> 1. Use only .080" (2 mm) line. 2. Use proper spool. 3. Cut with tip of line. 4. Reduce cutting speed.
Line releases continuously.	<ol style="list-style-type: none"> 1. Line improperly routed in head. 	<ol style="list-style-type: none"> 1. Remove cover. Check line routing.
Line usage is excessive.	<ol style="list-style-type: none"> 1. Line improperly routed in head. 2. Line size incorrect. 3. Cutting at high speed around hard objects. 4. Crowding line against material being cut. 	<ol style="list-style-type: none"> 1. Remove cover. Check line routing. 2. Use only .080" (2 mm) line. 3. Reduce speed around hard objects. 4. Cut with tip of line.
Line pulls back into head.	<ol style="list-style-type: none"> 1. Too little line outside of head. 2. Line size incorrect. 	<ol style="list-style-type: none"> 1. Remove cover. Pull 4" (10 cm) of line out. 2. Use only .080" (2 mm) line.

? CUSTOMER ASSISTANCE
1-800-554-6723

One of the most important priorities at POULAN/WEED EATER is customer satisfaction, especially *after* the sale. Your product has been expertly engineered and carefully manufactured to rigid quality standards to provide you with optimum performance and maximum operational lifetime. As with all mechanical products, however, making adjustments or replacing parts may be necessary during the life of your unit.

Because customer satisfaction is a major priority, POULAN/WEED EATER has established a special, toll free Customer Assistance Service to assist you with any after-the-sale needs. Whether you need a replacement part, an accessory, the name of your nearest sales or service dealer, or just need help in assembling your unit, our customer service representatives will be available to answer your questions.

When calling our Customer Assistance Service, please be prepared to give the description of the unit, the model number, serial number, and, if ordering parts, the part number or description of each part. Call 1-800-554-6723. Our representatives will be glad to help.

FOR SERVICE OR REPLACEMENT PARTS:

1. Consult your dealer/place of purchase.
2. Consult the yellow pages of your phone directory for the name of the nearest POULAN/WEED EATER Master Service Dealer (under "saws" for Chain Saws or under "lawnmowers" for Trimmers, Brushcutters, and Blowers).

NOTE: POULAN/WEED EATER Division provides parts and service through its authorized distributors and dealers; therefore, all requests for parts and service should be directed to your local dealer(s). The philosophy of POULAN/WEED EATER Division is to continually improve all of its products. If the operating characteristics or the appearance of your product differs from those described in this Operator's Manual, please contact your local POULAN/WEED EATER Dealer for updated information and assistance.

? NECESITA ASISTENCIA AL CLIENTE
1-800-554-6723

Una de la prioridades más importantes en POULAN/WEED EATER es la satisfacción al cliente, especialmente *después* de la venta. El producto ha sido diseñado y fabricado con esmero bajo estrictas normas de calidad para ofrecerle resultados óptimos y máxima vida operacional. No obstante, al igual que con todos los productos mecánicos, es posible que sea necesario efectuar ajustes o reemplazar piezas durante la vida de la unidad.

Debido a que la satisfacción de los clientes es una de nuestras prioridades principales, POULAN/WEED EATER tiene un número telefónico especial, sin costo, para Asistencial al Cliente con objeto de ayudarle a Ud. con cualquier necesidad después de haber comprado el equipo. Tanto si necesita una pieza de repuesto, un accesorio, el nombre de su concesionario de ventas o de servicio más cercanos, o si simplemente necesita asistencia para ensamblar la unidad, nuestros representantes de asistencia al cliente están disponibles para contestar sus preguntas.

Cuando llame a nuestro servicio de asistencia al cliente, tenga a mano la descripción de la unidad, el número de modelo, el número de serie y, si desea ordenar piezas, el número de pieza o su descripción. Llame al 1-800-554-6723. Nuestros representantes lo atenderán con mucho gusto.

PARA SERVICIO O PIEZAS DE REPUESTO:

1. Consulte a su concesionario o lugar de compra del equipo.
2. Consulte las páginas amarillas de su directorio telefónico para encontrar el Concesionario Principal de Servicio POULAN/WEED EATER más cercano (bajo "sierras" para sierras de cadena o bajo "cortadoras de césped" para cortadoras de bordes, cortadoras de malezas y abanicos).

NOTA: La División POULAN/WEED EATER suministra piezas de repuesto a través de sus distribuidores y concesionarios autorizados; por lo tanto, todas las solicitudes de piezas o servicio deben dirigirse a su concesionario local. La filosofía de la División POULAN/WEED EATER es mejorar continuamente todos sus productos. Si las características de operación o la apariencia de su producto difiere de los descritos en este Manual del Operador, por favor consulte a su concesionario POULAN/WEED EATER local para obtener la información más reciente disponible y asistencia.

? AIDE AUX CONSOMMATEURS
1-800-554-6723

L'une des principales priorités de POULAN/WEED EATER est la satisfaction de ses clients, tout spécialement *après* la vente. Votre appareil a fait l'objet d'une conception d'experts et d'une soigneuse fabrication selon des normes de qualité très strictes pour vous assurer d'une performance optimum et de la durée d'utilisation maximum. Comme pour tous les appareils mécaniques, certains réglages ou remplacements de pièces peuvent toutefois être requis durant la vie de votre appareil.

Puisque la satisfaction de ses clients est l'un des objectifs les plus importants de POULAN/WEED EATER, cette dernière a une ligne spéciale sans frais d'aide aux consommateurs pour satisfaire tous vos besoins d'après-vente. Que vous ayez besoin d'une pièce de rechange, d'un accessoire, du nom du concessionnaire ou du centre de service le plus proche ou que vous ayez besoin d'aide dans l'assemblage de votre appareil, nos représentants du service à la clientèle se feront un plaisir de répondre à vos questions.

Quand vous appelez notre service d'aide aux consommateurs, soyez prêt à donner la description de l'appareil, le numéro de modèle, le numéro de série et, si vous commandez des pièces, le numéro de chaque pièce ou sa description. Appelez au 1-800-554-6723 et nos représentants se feront un plaisir de vous aider.

POUR RÉPARATIONS OU PIÈCES DE RECHANGE:

1. Adressez-vous à votre concessionnaire/à l'endroit où vous avez acheté l'appareil.
2. Consultez les pages jaunes de votre annuaire pour y trouver le nom du Centre de service principal POULAN/WEED EATER le plus proche (sous la rubrique "Scies" pour les scies à chaîne ou "Tondeuses" pour les coupe-bordures, les coupe-broussailles et les souffleuses).

REMARQUE: La Division POULAN/WEED EATER fournit des pièces et des réparations par l'intermédiaire de ses distributeurs et concessionnaires autorisés et toutes demandes de pièces et de réparations devraient donc être adressées à votre concessionnaire local. La philosophie de POULAN/WEED EATER est de toujours améliorer tous ses articles. Si les caractéristiques de fonctionnement ou l'apparence de votre appareil diffèrent de celles décrites dans ce manuel de l'utilisateur, veuillez vous adresser à votre concessionnaire POULAN/WEED EATER local pour obtenir des renseignements à jour et de l'aide. Les pièces et réparations ne sont pas fournies directement par la Division POULAN/WEED EATER de WCI Outdoor Products Inc.

POULAN/WEED EATER
DIVISION OF WCI OUTDOOR PRODUCTS, INC.
Shreveport, Louisiana 71129 U.S.A.

530-083185-1-06/20/95

Free Manuals Download Website

<http://myh66.com>

<http://usermanuals.us>

<http://www.somanuals.com>

<http://www.4manuals.cc>

<http://www.manual-lib.com>

<http://www.404manual.com>

<http://www.luxmanual.com>

<http://aubethermostatmanual.com>

Golf course search by state

<http://golfingnear.com>

Email search by domain

<http://emailbydomain.com>

Auto manuals search

<http://auto.somanuals.com>

TV manuals search

<http://tv.somanuals.com>