





marantz[®] Integrated Amplifier
PM8004

User Guide

SAFETY PRECAUTIONS



CAUTION
RISK OF ELECTRIC SHOCK
DO NOT OPEN



CAUTION:
TO REDUCE THE RISK OF ELECTRIC SHOCK, DO NOT REMOVE COVER (OR BACK). NO USER-SERVICEABLE PARTS INSIDE. REFER SERVICING TO QUALIFIED SERVICE PERSONNEL.

The lightning flash with arrowhead symbol, within an equilateral triangle, is intended to alert the user to the presence of uninsulated "dangerous voltage" within the product's enclosure that may be of sufficient magnitude to constitute a risk of electric shock to persons.

The exclamation point within an equilateral triangle is intended to alert the user to the presence of important operating and maintenance (servicing) instructions in the literature accompanying the appliance.

WARNING:
TO REDUCE THE RISK OF FIRE OR ELECTRIC SHOCK, DO NOT EXPOSE THIS APPLIANCE TO RAIN OR MOISTURE.



Hot surface mark

CAUTION:
HOT SURFACE. DO NOT TOUCH.

The top surface over the internal heat sink may become hot when operating this product continuously. Do not touch hot areas, especially around the "Hot surface mark" and the top panel.

PRECAUTION:
SURFACE CHAUDE. NE PAS TOUCHER.

La surface supérieure du dissipateur de chaleur peut devenir chaude si vous utilisez ce produit en continu. Ne touchez pas les zones chaudes, tout particulièrement vers l'inscription "Hot surface mark" et le panneau supérieur.

PRECAUCIÓN:
SUPERFICIE CALIENTE. NO TOCAR.

La superficie superior sobre el disipador de calor interno podría llegar a calentarse al operar este producto de forma continua. No toque las áreas calientes, especialmente las situadas alrededor de la "Hot surface mark" y del panel superior.

IMPOTANT SAFETY INSTRUCTIONS

1. Read these instructions.
2. Keep these instructions.
3. Heed all warnings.
4. Follow all instructions.
5. Do not use this apparatus near water.
6. Clean only with dry cloth.
7. Do not block any ventilation openings. Install in accordance with the manufacturer's instructions.
8. Do not install near any heat sources such as radiators, heat registers, stoves, or other apparatus (including amplifiers) that produce heat.
9. Do not defeat the safety purpose of the polarized or grounding-type plug. A polarized plug has two blades with one wider than the other. A grounding type plug has two blades and a third grounding prong. The wide blade or the third prong are provided for your safety. If the provided plug does not fit into your outlet, consult an electrician for replacement of the obsolete outlet.
10. Protect the power cord from being walked on or pinched particularly at plugs, convenience receptacles, and the point where they exit from the apparatus.
11. Only use attachments/accessories specified by the manufacturer.
12. Use only with the cart, stand, tripod, bracket, or table specified by the manufacturer, or sold with the apparatus. When a cart is used, use caution when moving the cart/apparatus combination to avoid injury from tip-over.
13. Unplug this apparatus during lightning storms or when unused for long periods of time.
14. Refer all servicing to qualified service personnel. Servicing is required when the apparatus has been damaged in any way, such as power-supply cord or plug is damaged, liquid has been spilled or objects have fallen into the apparatus, the apparatus has been exposed to rain or moisture, does not operate normally, or has been dropped.
15. Batteries shall not be exposed to excessive heat such as sunshine, fire or the like.



CAUTION:

To completely disconnect this product from the mains, disconnect the plug from the wall socket outlet. The mains plug is used to completely interrupt the power supply to the unit and must be within easy access by the user.

PRECAUTION:

Pour déconnecter complètement ce produit du courant secteur, débranchez la prise de la prise murale. La prise secteur est utilisée pour couper complètement l'alimentation de l'appareil et l'utilisateur doit pouvoir y accéder facilement.

PRECAUCIÓN:

Para desconectar completamente este producto de la alimentación eléctrica, desconecte el enchufe del enchufe de la pared. El enchufe de la alimentación eléctrica se utiliza para interrumpir por completo el suministro de alimentación eléctrica a la unidad y debe de encontrarse en un lugar al que el usuario tenga fácil acceso.

FCC INFORMATION (For US customers)

1. PRODUCT

This product complies with Part 15 of the FCC Rules. Operation is subject to the following two conditions: (1) this product may not cause harmful interference, and (2) this product must accept any interference received, including interference that may cause undesired operation.

2. IMPORTANT NOTICE: DO NOT MODIFY THIS PRODUCT

This product, when installed as indicated in the instructions contained in this manual, meets FCC requirements. Modification not expressly approved by Marantz may void your authority, granted by the FCC, to use the product.

3. NOTE

This product has been tested and found to comply with the limits for a Class B digital device, pursuant to Part 15 of the FCC Rules. These limits are designed to provide reasonable protection against harmful interference in a residential installation.

This product generates, uses and can radiate radio frequency energy and, if not installed and used in accordance with the instructions, may cause harmful interference to radio communications. However, there is no guarantee that interference will not occur in a particular installation. If this product does cause harmful interference to radio or television reception, which can be determined by turning the product OFF and ON, the user is encouraged to try to correct the interference by one or more of the following measures:

- Reorient or relocate the receiving antenna.
- Increase the separation between the equipment and receiver.
- Connect the product into an outlet on a circuit different from that to which the receiver is connected.
- Consult the local retailer authorized to distribute this type of product or an experienced radio/TV technician for help.

For Canadian customers:

This Class B digital apparatus complies with Canadian ICES-003. Cet appareil numérique de la classe B est conforme à la norme NMB-003 du Canada.

□ NOTES ON USE / OBSERVATIONS RELATIVES A L'UTILISATION / NOTAS SOBRE EL USO

WARNINGS	AVERTISSEMENTS	ADVERTENCIAS
<ul style="list-style-type: none"> • Avoid high temperatures. Allow for sufficient heat dispersion when installed in a rack. • Handle the power cord carefully. Hold the plug when unplugging the cord. • Keep the unit free from moisture, water, and dust. • Unplug the power cord when not using the unit for long periods of time. • Do not obstruct the ventilation holes. • Do not let foreign objects into the unit. • Do not let insecticides, benzene, and thinner come in contact with the unit. • Never disassemble or modify the unit in any way. • Ventilation should not be impeded by covering the ventilation openings with items, such as newspapers, tablecloths or curtains. • Naked flame sources such as lighted candles should not be placed on the unit. • Observe and follow local regulations regarding battery disposal. • Do not expose the unit to dripping or splashing fluids. • Do not place objects filled with liquids, such as vases, on the unit. • Do not handle the mains cord with wet hands. • When the switch is in the OFF position, the equipment is not completely switched off from MAINS. • The equipment shall be installed near the power supply so that the power supply is easily accessible. 	<ul style="list-style-type: none"> • Eviter des températures élevées. Tenir compte d'une dispersion de chaleur suffisante lors de l'installation sur une étagère. • Manipuler le cordon d'alimentation avec précaution. Tenir la prise lors du débranchement du cordon. • Protéger l'appareil contre l'humidité, l'eau et la poussière. • Débrancher le cordon d'alimentation lorsque l'appareil n'est pas utilisé pendant de longues périodes. • Ne pas obstruer les trous d'aération. • Ne pas laisser des objets étrangers dans l'appareil. • Ne pas mettre en contact des insecticides, du benzène et un diluant avec l'appareil. • Ne jamais démonter ou modifier l'appareil d'une manière ou d'une autre. • Ne pas recouvrir les orifices de ventilation avec des objets tels que des journaux, nappes ou rideaux. Cela entraverait la ventilation. • Ne jamais placer de flamme nue sur l'appareil, notamment des bougies allumées. • Veillez à respecter les lois en vigueur lorsque vous jetez les piles usagées. • L'appareil ne doit pas être exposé à l'eau ou à l'humidité. • Ne pas poser d'objet contenant du liquide, par exemple un vase, sur l'appareil. • Ne pas manipuler le cordon d'alimentation avec les mains mouillées. • Lorsque l'interrupteur est sur la position OFF, l'appareil n'est pas complètement déconnecté du SECTEUR (MAINS). • L'appareil sera installé près de la source d'alimentation, de sorte que cette dernière soit facilement accessible. 	<ul style="list-style-type: none"> • Evite altas temperaturas. Permite la suficiente dispersión del calor cuando está instalado en la consola. • Maneje el cordón de energía con cuidado. Sostenga el enchufe cuando desconecte el cordón de energía. • Mantenga el equipo libre de humedad, agua y polvo. • Desconecte el cordón de energía cuando no utilice el equipo por mucho tiempo. • No obstruya los orificios de ventilación. • No deje objetos extraños dentro del equipo. • No permita el contacto de insecticidas, gasolina y diluyentes con el equipo. • Nunca desarme o modifique el equipo de ninguna manera. • La ventilación no debe quedar obstruida por haberse cubierto las aperturas con objetos como periódicos, manteles o cortinas. • No deberán colocarse sobre el aparato fuentes inflamables sin protección, como velas encendidas. • A la hora de deshacerse de las pilas, respete la normativa para el cuidado del medio ambiente. • No exponer el aparato al goteo o salpicaduras cuando se utilice. • No colocar sobre el aparato objetos llenos de líquido, como jarros. • No maneje el cable de alimentación con las manos mojadas. • Cuando el interruptor está en la posición OFF, el equipo no está completamente desconectado de la alimentación MAINS. • El equipo se instalará cerca de la fuente de alimentación de manera que resulte fácil acceder a ella.

□ CAUTIONS ON INSTALLATION PRÉCAUTIONS D'INSTALLATION EMPLAZAMIENTO DE LA INSTALACIÓN

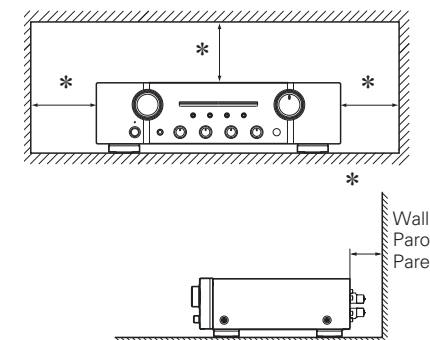

* For proper heat dispersal, do not install this unit in a confined space, such as a bookcase or similar enclosure.

- More than 0.3 m (12 in.) is recommended.
- Do not place any other equipment on this unit.

* Pour permettre la dissipation de chaleur requise, n'installez pas cette unité dans un espace confiné tel qu'une bibliothèque ou un endroit similaire.

- Une distance de plus de 0,3 m (12 po) est recommandée.
- Ne placez aucun matériel sur cet appareil.

* Para la dispersión del calor adecuadamente, no instale este equipo en un lugar confinado tal como una librería o unidad similar.

- Se recomienda dejar más de 0,3 m (12 pulg.) alrededor.
- No coloque ningún otro equipo sobre la unidad.

Getting started

Thank you for purchasing this MARANTZ product. To ensure proper operation, please read this owner's manual carefully before using the product.
After reading the manual, be sure to keep it for future reference.

Contents

Getting started	1
Accessories	1
About this manual	1
Main features	2
Cautions on handling	3
About the remote control	3
Inserting the batteries	3
Operating range of the remote control	3
Part names and functions	4
Front panel	4
Rear panel	4
Remote control	5
Basic connections	6
Preparations	6
Connecting cables	6
Connecting the audio equipment	6
Connecting the speakers	6
Connecting the speakers cables	6
Speaker connections	7
Connecting players	7
Connecting recorders	7
Connecting the power cord	8
Basic operation	8
Before use	8
Turning the power on	8
Turning the power standby	8
Turning the power off	8
Starting playback	9
Direct playback using a source audio component	9
Muting sound	9
Using headphone set	9
Starting Recording	9
Advanced connections	9
Connecting P.DIRECT connectors	9
Connecting pre out connectors	10
Connecting the remote control connectors	10
Advanced operations	10
Setting Auto standby mode	10
Troubleshooting	11
Specifications	12
Explanation terms	12
Index	12

Accessories

Check that the following parts are supplied with the product.

- | | |
|---|---|
| ① Owner's manual | 1 |
| ② Power cord (Cord length: Approx. 1.8 m) | 1 |
| ③ Remote control (RC003PM) | 1 |
| ④ R03/AAA batteries | 2 |

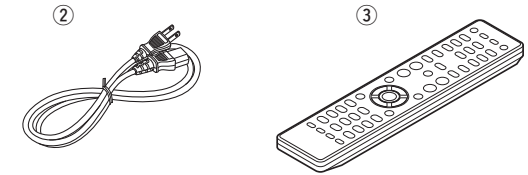

About this manual

❑ Operation buttons

The operations described in this manual are based mainly on remote control operation.

❑ Symbols



This symbol indicates a reference page on which related information is described.



This symbol indicates a supplementary information and tips for operations.

NOTE

This symbol indicates points to remember operations or function limitations.

❑ Illustrations

Note that the illustrations in these instructions are for explanation purposes and may differ from the actual unit.

Main features

Tri-tone control

This unit has a 3-tone control function for adjusting the midrange sound in addition to the bass and treble sounds so that you can make a more variable sound adjustment according to source and system.

All-discrete current-feedback amplifier

Marantz' proprietary current-feedback circuit, using discrete components, is adopted in the pre amplifier and power amplifier. It is a high-speed amplifier using the latest technology developed for the higher-grade amplifiers.

HDAM-SA3 Technology

The V/I converter circuit, which is the key block of the current-feedback pre-amplifier and power amplifier, is equivalent to the HDAM-SA3 ampmodule developed for such higher-grade models as the PM-11S2.

CD direct buffer amplifier

An input buffer amplifier exclusive for CD is mounted near the CD input jacks. This is a high-speed buffer amplifier made with discrete components, which avoids interference between right and left channels and can send the signals to the pre-amplifier with very high fidelity.

Improved momentary current supply ability

It is generally known that the sound quality is not necessarily the same even if amplifiers have the same specifications. Marantz considers the cause to be the power to drive speakers. The power amplifier of this unit has the ability to momentarily supply current of 25 A or more to drive speakers strongly.

Short-power-line layout

For strong momentary current supply, a short power-line layout unifies the power circuit and output stage of the power amplifier section. This layout allows connecting the large-current lines via the shortest route while to arranging the left and right channels symmetrically.

All-Discrete current-feedback phono equalizer

As a phono equalizer amplifier for MM cartridges, a constant current-feedback PHONO equalizer of quality equal to that of the higher-grade model PM-11S2 is used.

Double-shielded triodal transformer

The unit is equipped with a toroidal power transformer to minimize vibration and leakage flux specific to the transformer. Especially to reduce leakage flux, which affects sound quality, the periphery is double-shielded, using a core ring and a short ring.

Block condenser of large capacity

A large-capacity condenser of 18,000 μ F is used in the power circuit of the power amplifier. In the preamplifier, a 4700 μ F condenser is used.

High-performance volume

Capacitor for high quality sound

Double-layered chassis

High-grade speaker terminals

Cautions on handling

• Before turning the power switch on

Check once again that all connections are correct and that there are no problems with the connection cables.

- Power is supplied to some of the circuitry even when the unit is set to the standby mode. When leaving home for long periods of time, be sure to unplug the power cord from the power outlet.

• About condensation

If there is a major difference in temperature between the inside of the unit and the surroundings, condensation may form on parts inside the unit, causing the unit to fail to operate properly.

If this happens, let the unit sit for an hour or two with the power off and wait until there is little difference in temperature before using the unit.

• Cautions on using mobile phones

Using a mobile phone near this unit may result in noise. If that occurs, move the mobile phone away from the unit when it is in use.

• Moving the unit

Turn off the power and unplug the power cord from the power outlet.

Next, disconnect the cables connected to other system units before moving the unit.

About the remote control

Inserting the batteries

- ① Remove the rear cover of the remote control.

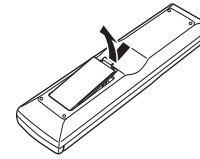

- ② Set two R03/AAA batteries in the battery compartment in the indicated direction.

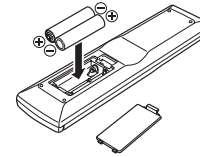

- ③ Put the rear cover back on.

NOTE

- Replace the batteries with new ones if the unit does not operate even when the remote control is operated close to the unit.
- The supplied batteries are only for verifying operation.
- Insert the batteries in the proper direction, following the “+” and “-” marks in the battery compartment.
- To prevent damage or leakage of battery fluid:
 - Do not use a new battery with an old one.
 - Do not use two different types of batteries.
 - Do not attempt to charge dry batteries.
 - Do not short-circuit, disassemble, heat or dispose of batteries in a fire.
 - Do not keep the battery in a place exposed to direct sunlight or in places with extremely high temperatures, such as near a heater.
- If the battery fluid leaks, carefully wipe the fluid off the inside of the battery compartment and insert new batteries.
- Remove the batteries from the remote control if it will not be used for a long time.
- Used batteries in accordance with local regulations on battery disposal.

Operating range of the remote control

operate the remote control while pointing it at the remote sensor.

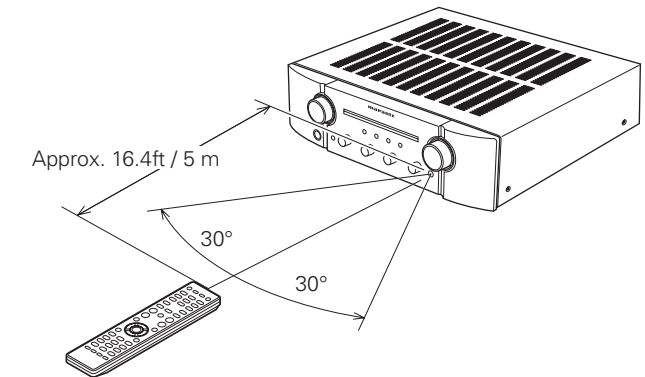

NOTE

The unit may function improperly or the remote control may not operate if the remote control sensor is exposed to direct sunlight, or strong artificial light from a fluorescent or infrared light.

Part names and functions

For buttons not explained here, see the page indicated in parentheses ().

Front panel

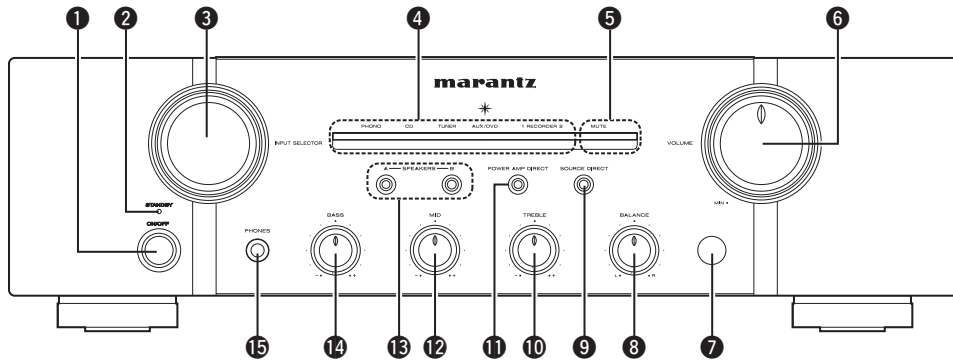

- 1 Power switch (ON/OFF)** (8)
- 2 STANDBY indicator** (8)
 - Indicates the status of the unit's as follows:
 - Power "ON" : Off
 - When the protection circuit is activated : Red (blinking) (6)
 - Standby : Red
 - Power "OFF" : Off
- 3 INPUT SELECTOR knob** (9)
- 4 Input indicators** (8)
- 5 MUTE indicator (MUTE)** (9)
- 6 VOLUME control knob** (8, 9)
- 7 Remote control sensor** (3, 10)
- 8 BALANCE control knob** (8, 9)
- 9 SOURCE DIRECT switch/indicator** (9)
- 10 TREBLE control knob** (8, 9)
- 11 POWER AMP DIRECT switch/indicator** (9)
- 12 MID control knob** (8, 9)
- 13 SPEAKERS A/B switch/indicators** (9)
- 14 BASS control knob** (8, 9)
- 15 Headphone jack (PHONES)** (9)

NOTE

You can adjust the **8** BALANCE, **10** TREBLE, **12** MID and **14** BASS control knobs only when **9** SOURCE DIRECT switch is turned off.

Rear panel

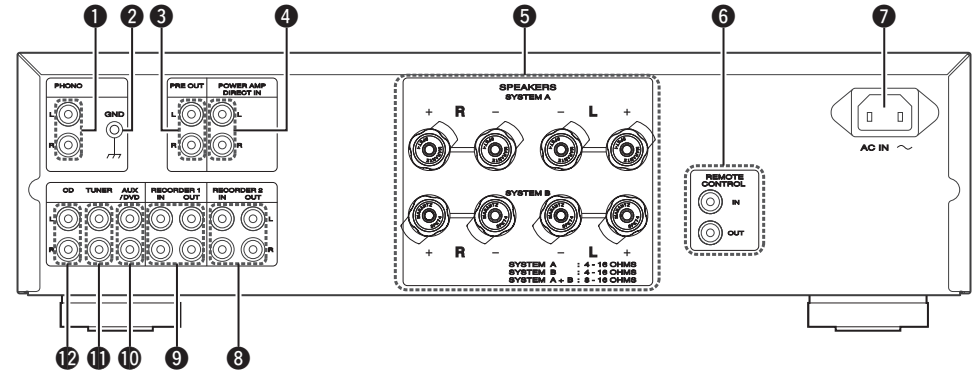

- 1 PHONO input connectors** (7)
- 2 PHONO GND terminal** (7)
- 3 PRE OUT connectors** (10)
- 4 POWER AMP DIRECT IN connectors** (9)
- 5 Speaker system terminals (SPEAKERS SYSTEM A/B)** (6, 7)
- 6 REMOTE CONTROL input/output connectors** (10)
- 7 AC inlet (AC IN)** (8)
- 8 RECORDER 2 input/output connectors** (7)
- 9 RECORDER 1 input/output connectors** (7)
- 10 AUX/DVD input connectors** (7)
- 11 TUNER input connectors** (7)
- 12 CD input connectors** (7)

Remote control

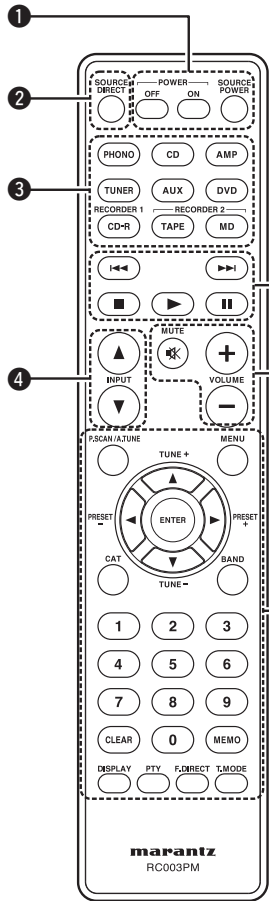

You can use the supplied remote control to operate this unit and Marantz audio components such as CD players, tuners, DVD players, and tape decks. See "Operating Marantz audio components" (page 5).

- 1 POWER ON/STANDBY buttons** (8)
- POWER ON button
 - POWER OFF button
 - SOURCE POWER button

You can press this button to switch the mode of Marantz audio components (provided with a power standby function) between power-on and standby.

- 2 SOURCE DIRECT button** (9)
- 3 Input selector buttons** (5)
- 4 INPUT ▲/▼ buttons** (9)
- 5 Component operating buttons** (8, 9)
- 6 VOLUME adjustment buttons** (8, 9)
- MUTE Button
 - VOLUME + / - Button

Operating Marantz audio components

Operation

- Press the corresponding **3** Input selector button of the audio component for selecting the input source to be used in playback and recording.
 - The remote control operation is switched to operation mode of the selected input source.
 - This unit's function will be switched accordingly.
- Operate the audio component.
 - See the table on the right for the buttons you can use.



- The remote control **3** Input selector buttons are used to select the input source for this unit and switch the remote control operation mode at the same time.
- You can operate the remote control of this unit regardless of the remote control mode setting.
- To use the remote control correctly, also refer to the operating instructions of other components.

NOTE

Some input terminals of this unit and corresponding input selector buttons on the remote control have different names, as shown below.

Remote control buttons	The unit input terminals
AUX, DVD	AUX/DVD
CD-R	RECORDER1
TAPE, MD	RECORDER2

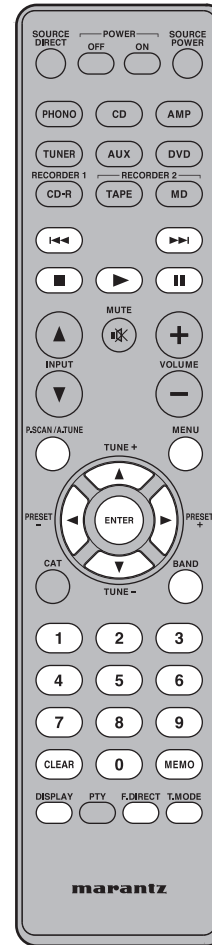

CD operation

Operation buttons	Function
⏮ ⏪ ⏩ ⏭	Skip
■	Stop
▶	Playback
⏸	Pause
0 - 9	Track selection
T.MODE	Sound mode selection

Tuner operation

Operation buttons	Function
P.SCAN/A.TUNE	preset scan
▲/TUNE+	Tuning up
▼/TUNE-	Tuning down
◀/PRESET-	Preset channel selection
▶/PRESET+	Preset channel selection
BAND	FM/AM switching
0 - 9	Enter number
CLEAR	Clear memory or input data
MEMO	Save preset station number
F.DIRECT	Direct frequency tuning
T.MODE	Auto stereo/monaural switching

- The remote control buttons may not function properly for some Marantz tuners.

DVD operation

Operation buttons	Function
⏮ ⏪ ⏩ ⏭	Skip
■	Stop
▶	Playback
⏸	Pause
MENU	Menu
▲ ▼ ◀ ▶	Cursor operation
ENTER	Enter setting
0 - 9	Enter number
DISPLAY	Display disc information

Cassette deck operation

Operation buttons	Function
⏮	Fast-rewind
⏩	Fast-forward
■	Stop
▶	Playback
⏸	Pause
CLEAR	Counter reset

Basic connections

NOTE

- Do not plug in the power cord until all connections have been completed.
- When making connections, also refer to the operating instructions of the other components.
- Be sure to connect the left and right channels properly (left with left, right with right).
- Do not bundle power cords with connection cables. Doing so can result in humming or noise.
- Do not turn up the volume without a turntable connected to the PHONO input terminals. Doing so will cause humming or noise.

Preparations

Connecting cables

Select the cables according to the equipment being connected.

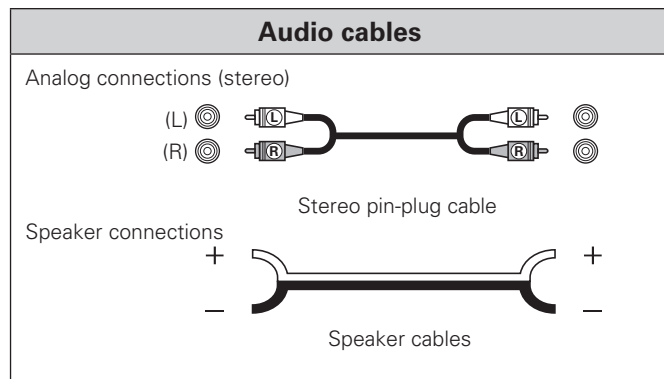

Connecting the audio equipment

Cautions on playing SA(Super Audio) sources:

When regular speakers not compatible with SA sources (DVD Audio discs, Super Audio CDs and other sources, including treble components above the audible range), set the properties of the player (DVD Audio player, Super Audio CD player, etc.) for use with regular speakers (or amplifiers).

The speakers may be damaged if the volume is set too high when playing SA sources. For instructions on player settings, refer to the operating instructions included with the player.

Connecting the speakers

Connecting the speakers cables

Carefully check the left (L) and right (R) channels and + (red) and - (white) polarities on the speakers being connected to the unit, and be sure to connect the channels and polarities correctly.

1 Peel off about 10 mm of sheathing from the tip of the speaker cable, then either twist the core wire tightly or apply solder to it.



2 Turn the speaker terminal counterclockwise to loosen it.



3 Insert the speaker cable's core wire to all the way into the speaker terminal.

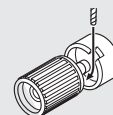

4 Turn the speaker terminal clockwise to tighten it.

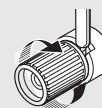

NOTE

- Connect the speaker cables so they do not stick out of the speaker terminals. The protection circuit may be activated if the wires touch the rear panel or if the + and - sides touch each other ("Protection circuit").
- Never touch the speaker terminals while the power supply is connected. Doing so could result in electric shock.

Protection circuit

The protection circuit is be activated in the following situations:

- If the speaker cable wire touches the rear panel or screws or if the speaker cable wire touches the speaker cable's + and - sides are touching
- If the surrounding temperature is extremely high
- If the inside of the amplifier gets hot to extended use at a high output

If the protection circuit is activated, the speaker output is blocked and the power indicator flashes in red. If this happens, unplug the power cord, then check the connections of the speaker cables and input cables. If the unit becomes very hot, wait for it to cool off and improve the ventilation around it. After doing this, plug the power cord back in.

If the protection circuit is activated even though there are no problems with the ventilation around the unit or in connections, the unit may be damaged. Turn off the power and then contact a Marantz service center.

When using a banana plug

Tighten the speaker terminal firmly before inserting the banana plug.

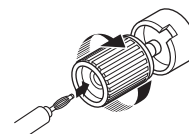

Connecting the speakers

Speaker connections

- The same signal is output from the SPEAKERS A and B terminals.
- When only one set of speakers is to be connected, use either the SYSTEM A or B terminals.

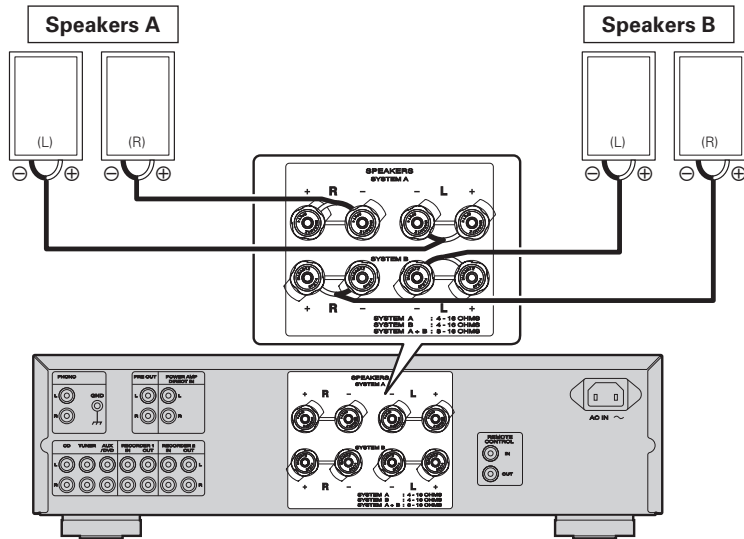

Speaker impedance

Use speakers with impedances within the ranges shown below to suit how they are used.

Speakers used	Impedance
A	4 - 16 Ω
B	4 - 16 Ω
A and B	8 - 16 Ω

Connecting players

A turntable with an MM type cartridge can be connected to this unit. To use an MC cartridge, please install a step-up transformer.

- If humming or other noise is generated when the ground wire is connected, disconnect it.

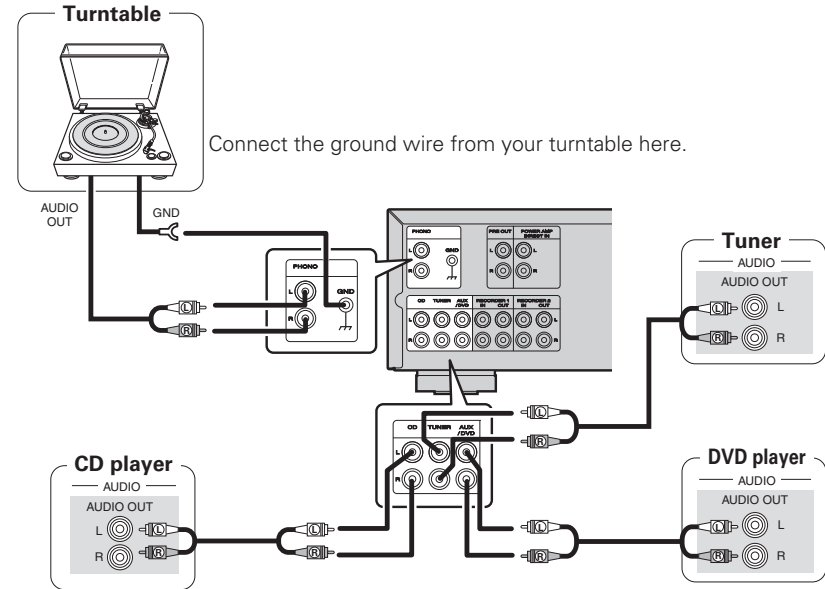

Connecting recorders

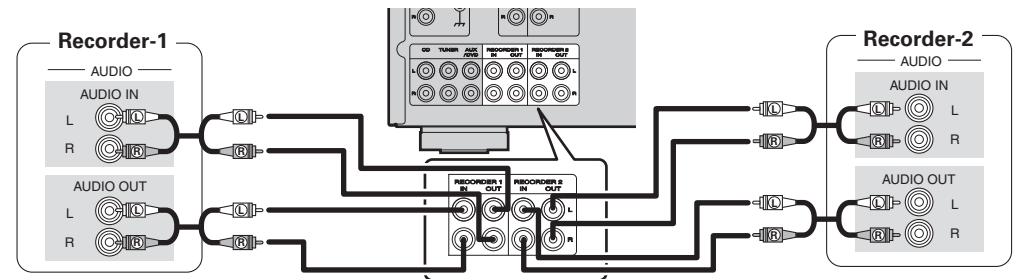

Connecting the power cord

Wait until all connections have been completed before connecting the power cord.

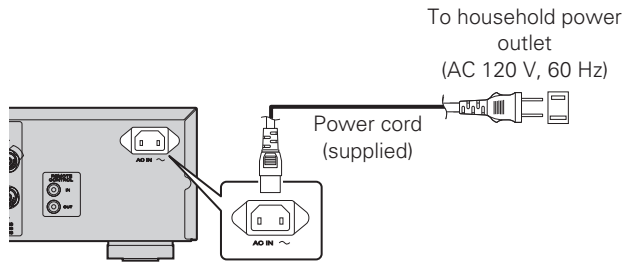

NOTE

- Insert the plugs securely. Loose connections will result in the generation of noise.
- Do not use any cord other than the provided power cord.

Basic operation



Symbols used to indicate buttons in this manual

- Button located on both the main unit and the remote control → **BUTTON**
- Button only on the main unit → **<BUTTON>**
- Button only on the remote control → **[BUTTON]**

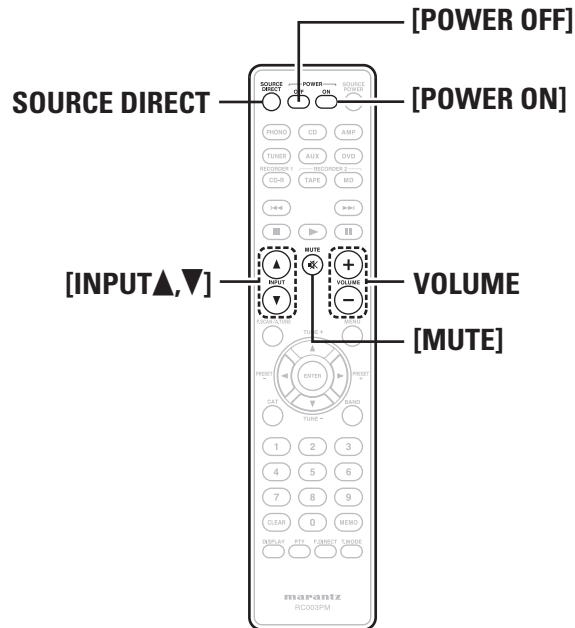
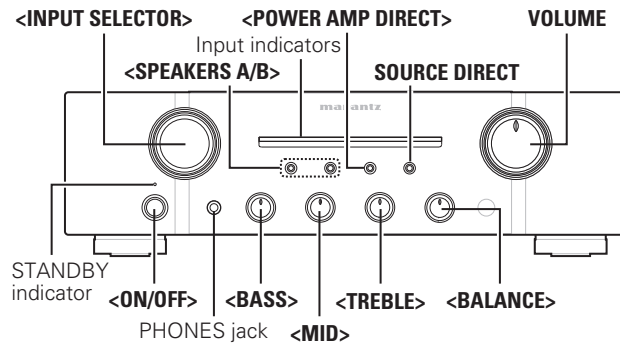

Before use

- 1 Turn the **VOLUME** all the way down.
- 2 Set **<BASS>**, **<MID>**, **<TREBLE>** and **<BALANCE>** to the center positions.

Turning the power on

Press **<ON/OFF>**.

- Power is turned on.
- Input indicator for the selected source lights.
- The unit will be ready to start playback after several seconds.

Turning the power standby

Press **[POWER OFF]**.

- The power is set to the standby mode.
- The STANDBY indicator lights in red.



- Press **[POWER ON]** to turn on power from standby mode.
- You can also turn on power by using either **<INPUT SELECTOR>** from standby mode.

NOTE

Power continues to be supplied to some of the circuitry even when the power is in the standby mode. When leaving home for long periods of time or when going on vacation, either press **<ON/OFF>** to turn off the power, or unplug the power cord from the power outlet.

Turning the power off

Press **<ON/OFF>**.

- Power is turned off.
- All indicators will turn off.

Starting playback

- 1 Use either **<INPUT SELECTOR>** or **[INPUT ▲,▼]** to select an input source you want for playback.

The input indicator for the selected source lights.

[Selectable sources]



- You can also select an input source by pressing the Input selector buttons of the remote control.
- The input source you select is stored in memory even after you turn off power, and the same source is selected when power is turned on again.

- 2 Press **<SPEAKERS A/B>** to select the speaker system to be used for playback.

The indicator for the selected speaker system lights.

- 3 Start playing back the source.

- 4 Adjust the **VOLUME** to the desired level.

□ Adjusting the tone

- **<BASS>** Adjusts the bass sound.
- **<MID>** Adjusts the midrange sound.
- **<TREBLE>** Adjusts the treble sound.
- **<BALANCE>** Adjusts the left and right output balance.

Direct playback using a source audio component

Since the audio signals bypass the tone control circuits (BASS/MID/TREBLE/BALANCE), the music reproduction is more faithful to the original sound.

Press **SOURCE DIRECT**.

The SOURCE DIRECT indicator lights.



To adjust the tone, turn off **SOURCE DIRECT**.

Muting sound

This function mutes the sound by stopping audio output.

Press **[MUTE]**.

The MUTE indicator lights.

- To cancel the mute operation, press the button again. You can also cancel the mute operation by operating **VOLUME** of the remote control.

Using headphone set

Plug headphones into PHONES jack.

- To listen with headphones, turn speaker output OFF.

□ Adjusting the volume

Adjust the **VOLUME** to the desired level.

NOTE

To prevent hearing loss, do not raise the volume level excessively when using headphones.

Starting Recording

- 1 Use either **<INPUT SELECTOR>** or **[INPUT ▲,▼]** to select the input source you want to record.

- 2 Set the recorder to recording mode.

- 3 Start playback of the source you want to record.

- Recording will start in sync with the playback operation of the source.

Advanced connections

Connecting P.DIRECT connectors

If you use a preamplifier, connect it as shown below, and then you can use this unit as a power amplifier.

To switch the **POWER AMP DIRECT** mode, press and hold **<POWER AMP DIRECT>** for at least 3 seconds.

- Switching **<POWER AMP DIRECT>** "ON", allows the device connected to the Power Amp Direct connector on the rear panel to be played. When ON, the input indicator turns off.
- Switching **<POWER AMP DIRECT>** "OFF", allows the program source selected using the **INPUT SELECTOR** knob to be played. When OFF, the input indicator lights up.

For details on operations of the preamplifier, refer to the instruction manual supplied with the preamplifier to be used.

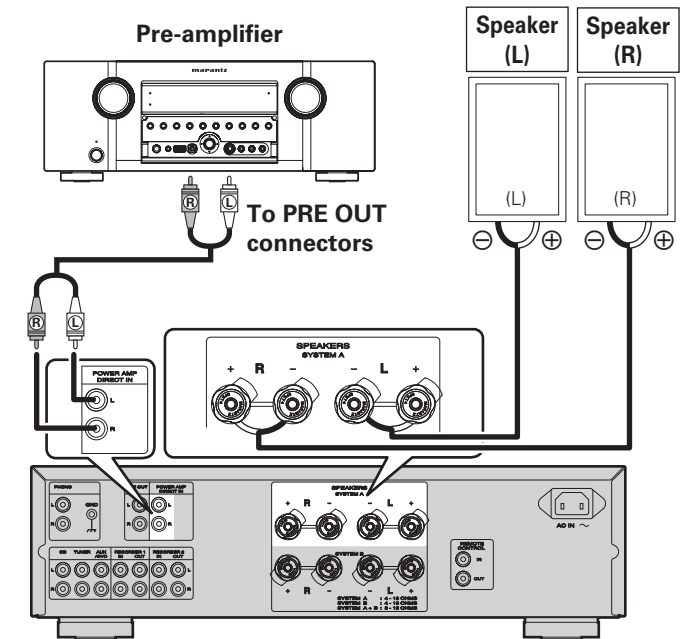

NOTE

- When the **POWER AMP DIRECT** is "ON", adjustment of the volume, balance and tone on the main unit has no effect. Adjust the volume on the input device.
- When the **POWER AMP DIRECT** is "ON", the main unit outputs at maximum volume. Check the output level on the input device before playing it and adjust the volume accordingly.

Connecting pre out connectors

If you use a power amplifier, connect it as shown below, and then you can use this unit as a preamplifier.

For connecting speaker systems, refer to the instruction manual supplied with the power amplifier to be used.

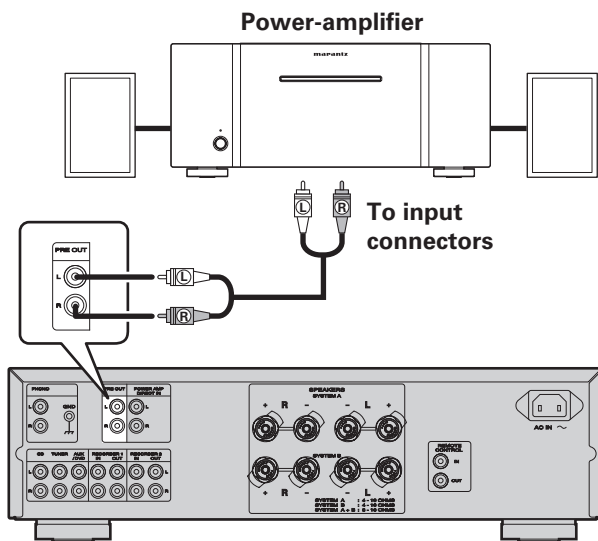

NOTE

- NEVER insert the short-circuiting pin plug into the PRE OUT terminals. Doing so could result in damage.
- Signals are output from the PRE OUT terminals even when using headphones.

Connecting the remote control connectors

When you use this unit connected to Marantz audio components, it sends control signals to operate each component.

Connection

Use the remote connection cable (supplied with a Marantz audio component you want to connect) to connect the REMOTE CONTROL OUT terminal of this unit to the REMOTE CONTROL IN terminal of the component to be connected.

Setting

Set the remote control switch located on the rear panel of the connected audio component to "EXTERNAL" or "EXT." to use this feature.

- This setting will disable remote sensor reception of the connected audio component.
- To operate the connected audio component, point the remote control at the remote sensor of this unit.

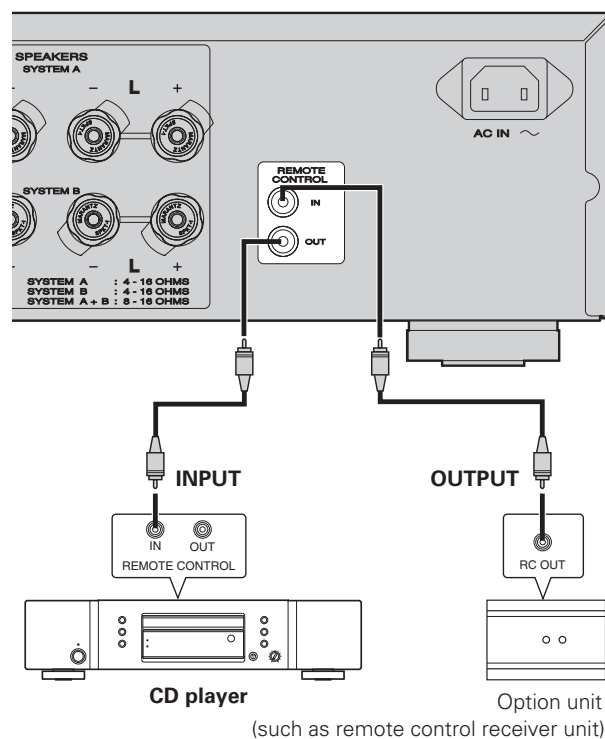

Advanced operations

Setting Auto standby mode

With the Auto standby mode ON, this unit will automatically enter the Auto standby mode after about 30 continuous minutes of no output from the speakers or headphones.

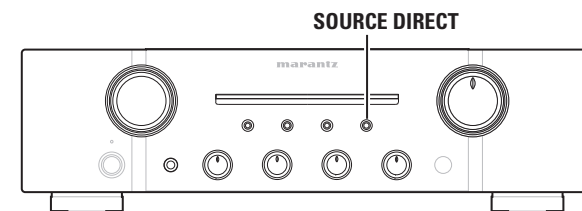

Press and hold <SOURCE DIRECT> for at least 5 seconds.

- Auto standby mode is switched between On and Off.

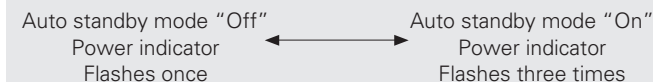

NOTE

Perform the operation using the buttons on the unit. You cannot perform the operation using [SOURCE DIRECT] on the remote control.



- The default setting for the Auto standby mode is OFF.
- This unit will automatically enter Auto standby mode after about continuous 30 minutes in the following conditions.
 - No output from the selected input source.
 - No operation performed on the remote control.
 - No operation of <SPEAKERS A/B>, <POWER AMP DIRECT>, <SOURCE DIRECT> or <INPUT SELECTOR>.

Troubleshooting

If a problem occurs, first check the following:

1. Are the connections correct?

2. Is the unit being operated as described in the owner's manual?

3. Are the other components operating properly?

If this unit does not operate properly, check the items listed in the table below. If the problem persists there may be a malfunction.

In that case, disconnect the power immediately and contact your retail outlet.

Symptom	Cause	Countermeasure	Page
Power is not turned on.	<ul style="list-style-type: none"> The power cord's plug is not plugged in firmly. The unit is in standby mode. 	<ul style="list-style-type: none"> Make sure that the power cord is plugged in properly. Either turn the INPUT SELECTOR knob of this unit or press POWER ON of the remote control. 	8 8
	<ul style="list-style-type: none"> The protection circuit is activated. 	<ul style="list-style-type: none"> If the STANDBY indicator is blinking, turn off power, wait 1 minute or longer, and turn on power again. 	6
When power is turned on but there is no sound.	<ul style="list-style-type: none"> The speaker cables are not properly connected. The input cable is not properly connected. The INPUT SELECTOR knob setting position is incorrect. The VOLUME control knob is set to minimum. The SPEAKERS A/B switches are turned off. 	<ul style="list-style-type: none"> Make sure the speakers are connected properly. Make sure the input cables are connected properly. Set the INPUT SELECTOR knob at the correct setting position. Use the VOLUME control knob to turn volume up to an appropriate level. Turn on the SPEAKERS A/B switch corresponding to the speaker system terminals (SYSTEM A or SYSTEM B) to which the speakers are connected. 	7 7 9 9 9
	<ul style="list-style-type: none"> The incorrect SPEAKERS A/B switch is turned on. 	<ul style="list-style-type: none"> Turn on the SPEAKERS A/B switch corresponding to the speaker system terminals (SYSTEM A or SYSTEM B) to which the speakers are connected. 	9
	<ul style="list-style-type: none"> The mute function activated. 	<ul style="list-style-type: none"> If the MUTE indicator is lit, press MUTE on the remote control to cancel muting. 	9
	<ul style="list-style-type: none"> The protection circuit is activated. 	<ul style="list-style-type: none"> Turn off power, wait 1 minute or longer, and turn on power again. 	6
Sound is produced from either one speaker only.	<ul style="list-style-type: none"> The speaker cables are not properly connected. The BALANCE control knob setting position is inappropriate. 	<ul style="list-style-type: none"> Make sure that the speakers are connected properly. Set the BALANCE control knob at the appropriate position. 	7 9
The left and right channels are reversed.	<ul style="list-style-type: none"> Either the left/right speaker or left/right input cable connections are reversed. 	<ul style="list-style-type: none"> Make sure that the speakers are connected correctly. 	7
Noise is produced during a record playback.	<ul style="list-style-type: none"> The ground wire from the turntable is disconnected. The PHONO input terminals are not properly connected. A TV set near the turntable is causing the noise. 	<ul style="list-style-type: none"> Make sure that the PHONO GND terminal is connected properly. Make sure that the PHONO input terminal is connected properly. Relocate the TV set or turntable in another place. 	7 7 -
	<ul style="list-style-type: none"> The turntable and speakers are too close to each other. The turntable is placed on a rack or floor that vibrates easily. 	<ul style="list-style-type: none"> Install the speakers as far away from the turntable as possible. If the turntable is not supplied with an insulating pad, use insulating pad available in the market. 	- -
	<ul style="list-style-type: none"> Batteries are low. You are operating the remote control outside of the specified range. There is an obstacle between the main unit and remote control. You have pressed the wrong button. Batteries are not inserted in the proper direction as indicated by polarity markers (⊕ and ⊖) in the battery compartment. 	<ul style="list-style-type: none"> Replace with new batteries. Operate within the specified range. Remove the obstacle. Press the correct button. Insert the batteries in the proper direction in accordance with the polarity markers in the battery compartment. 	3 3 3 5 3

Specifications

<ul style="list-style-type: none"> • Power output (20 Hz – 20 kHz simultaneous drive of both channels): 	70 W x 2 (8 Ω load) 100 W x 2 (4 Ω load)
<ul style="list-style-type: none"> • Total harmonic distortion (20Hz – 20kHz simultaneous drive of both channels, 8Ω load): 	0.02%
<ul style="list-style-type: none"> • Output band width (8Ω load, 0.05%): 	5Hz – 60kHz
<ul style="list-style-type: none"> • Frequency response (CD, 1W, 8Ω load): 	5Hz – 100kHz ±3dB
<ul style="list-style-type: none"> • Dumping factor (8Ω load, 20Hz – 20kHz): 	100
<ul style="list-style-type: none"> • Input sensitivity/Input impedance PHONO (MM): CD, TUNER, AUX/DVD, RECORDER: POWER AMP DIRECT IN 	2mV/47kΩ 200mV/20kΩ 1.6V/15kΩ
<ul style="list-style-type: none"> • Output voltage/Output impedance PRE OUT 	1.6V/600Ω
<ul style="list-style-type: none"> • Maximum allowable PHONO input level (1kHz) MM 	100mV
<ul style="list-style-type: none"> • RIAA deviation (20Hz ~ 20kHz) 	±0.5dB
<ul style="list-style-type: none"> • S/N (IHF-A, 8Ω load) PHONO (MM) CD, TUNER, AUX/DVD, RECORDER POWER AMP DIRECT IN . 	87dB (5mV input, 1W output) 106dB (2V input, Rated output) 125dB (Rated output)
<ul style="list-style-type: none"> • Tone control Bass (50Hz) Mid (900Hz) Treble (15kHz) 	±10dB ±6dB ±10dB
<ul style="list-style-type: none"> • Power requirement 	AC 120V 60Hz
<ul style="list-style-type: none"> • Power consumption (UL60065) Standby power consumption 	200W 0.3W
<ul style="list-style-type: none"> • Weight 	26.9 lbs (12.2kg)

For the purpose of improvement, the specifications and design are subject to change without notice.

Explanation terms

P

Protection Circuit

This is a function to prevent damage to components within the power supply when an abnormality such as an overload or excess voltage occurs for any reason.

In this unit, the STANDBY indicator blinks and the unit enters standby mode when an abnormality occurs.

S

Speaker impedance

This is certain-rated resistance of the speaker set to an alternating current and expressed in ohms. The smaller the impedance, the greater the output. However, load on the amplifier is increased. Use speakers whose impedance is supported by this unit.

Index

A

Adjusting the tone	9
Adjusting the volume	9
Auto standby mode	10

B

BALANCE	4, 8
BASS	4, 8
Batteries	3
Before use	8

C

Connection	
Connecting cables	6
Connecting players	7
Connecting recorders	7
Connecting the speakers	6, 7

I

INPUT SELECTOR	4, 8
----------------------	------

M

MID	4, 8
Mute	4, 8

P

POWER AMP DIRECT	4, 9
Power cord	8
PRE OUT	4, 10
Protection circuit	6, 12

R

Remote control	3, 5, 10
----------------------	----------

S

SOURCE DIRECT	4, 8
Speaker cables	6, 7
Stereo pin-plug cable	6

T

TREBLE	4, 8
--------------	------

V

VOLUME	4, 8
--------------	------

• PM8004 (unit: inch (mm))

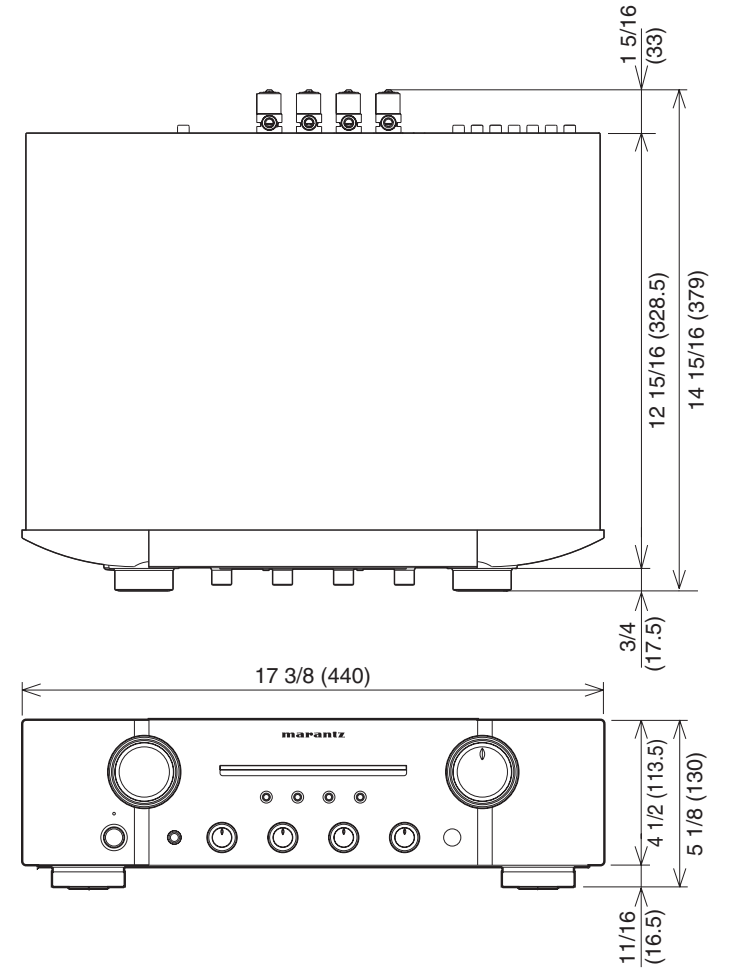

www.marantz.com

You can find your nearest authorized distributor or dealer on our website.

marantz[®] is a registered trademark.

Free Manuals Download Website

<http://myh66.com>

<http://usermanuals.us>

<http://www.somanuals.com>

<http://www.4manuals.cc>

<http://www.manual-lib.com>

<http://www.404manual.com>

<http://www.luxmanual.com>

<http://aubethermostatmanual.com>

Golf course search by state

<http://golfingnear.com>

Email search by domain

<http://emailbydomain.com>

Auto manuals search

<http://auto.somanuals.com>

TV manuals search

<http://tv.somanuals.com>