

The OmniView™ SE 4-Port User Manual

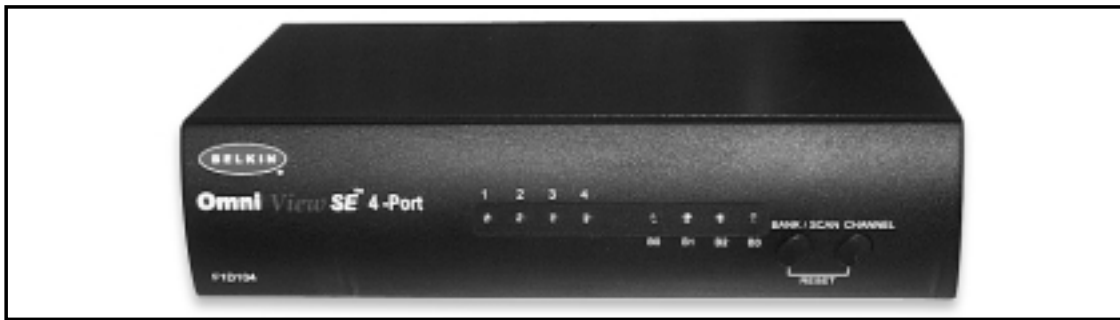

Introduction

Thank you for purchasing the Belkin Components **OmniView™ SE** KVM switch. Controlling multiple PCs from one keyboard, mouse and monitor has never been easier!

The **OmniView™ SE** puts you in control. Compatible with AT and PS-2 style computers, it is loaded with features such as Integrated Mouse Conversion Technology, separate DB25 daisy-chain ports, and an optional 19" (48.3cm) rackmount kit. It has complete keyboard and mouse emulation for error-free boot-ups, plus Microsoft® Intellimouse® support. The **OmniView™ SE** is also designed to handle the most demanding resolutions up to 1600 x 1200, without any noticeable degradation in image quality. Switching can be done through convenient front-panel pushbutton, or keyboard "Hot" key commands. And if you wish to control a Macintosh computer, simply add the Belkin MAC Adapter™ for even more system control.

Features

- Allows a user to control four computers from one keyboard, mouse and monitor
- Integrated Mouse Conversion Technology allows connection of AT-style computers that have serial mouse ports while using a PS/2 mouse only at the console
- Keyboard and mouse emulation for error-free boot-ups
- Microsoft® Intellimouse® and Intellimouse® Pro support
- Up to 1600 x 1200 resolution support
- DB25 Daisy-Chain ports - allows control over more computers by adding more **OmniView™ SE** units
- Supports both AT and PS/2 style keyboards (AT requires AT-PS/2 adapter)
- Supports VGA, SVGA and Multisync monitors
- Uses inexpensive and commonly found standard cables
- Pushbutton or keyboard "Hot" key command switching
- AutoScan mode for even more convenience
- Audible feedback when switching
- Recalls CAPS LOCK, NUM LOCK and SCROLL LOCK keys' status for each computer automatically
- Front-panel status LEDs
- Works with **OmniView™ PS/2 MAC Adapter™**
- No software required
- One year product warranty

Package Contents

OmniView™ SE 4-Port	F1D104
9VDC, 600mA power supply	F1D065-PWR
This manual	P72464
Registration card	P72009

Technical Specifications

Console Connectors:

Keyboard: 6 pin Mini DIN female
Mouse: 6 pin Mini DIN female (for PS/2 mouse)
DB9 male (for spare serial mouse)
Monitor: HDDB15 female

Computer Port Connectors:

Keyboard: 6 pin Mini DIN female
Mouse: 6 pin Mini DIN female (for PS/2 mouse)
DB9 male (for serial mouse)
Monitor: HDDB15 male

Dimensions:

Width: 9.5" (237 mm)
Height: 2.3" (58 mm)
Depth: 6.0" (153 mm)

Weight: 2.5 lbs (1.1 kg)
Operating Temp: 32 to 104 deg. F (0~40 deg. C)
Storage Temp: -4 to 140 deg. F (-20 ~ 60 deg. C)
Humidity: 0~80% RH, non-condensing

Product Detail

FRONT PANEL

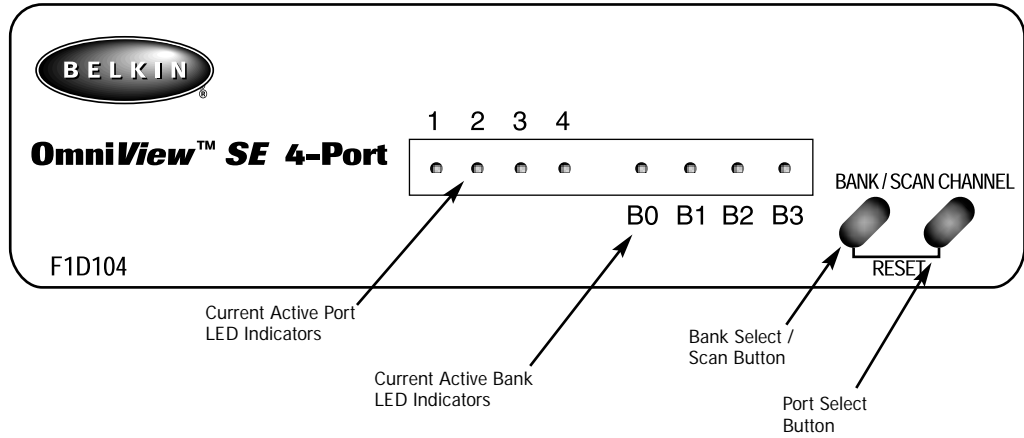

REAR PANEL

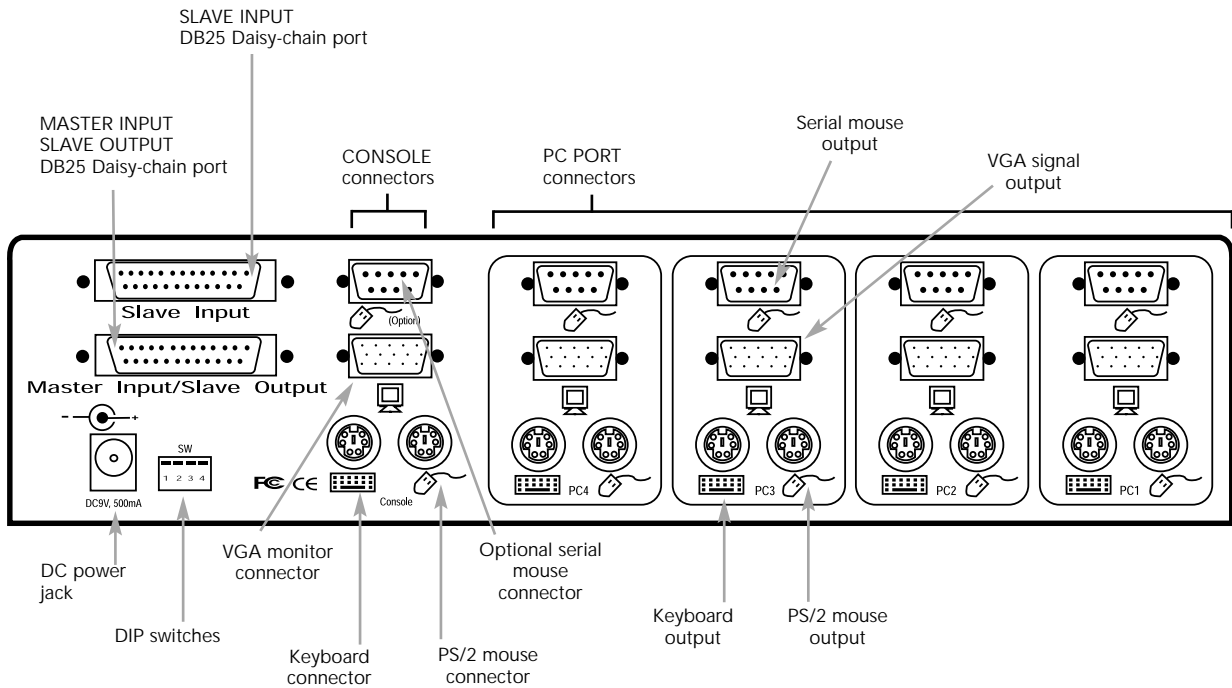

Cabling Detail

Make sure you have the right cables!

The OmniView™ SE requires cables to connect the eight computers you will be controlling. Below are the Belkin part numbers and their descriptions. We recommend purchasing Cable Kits based on the type of mouse port your computer uses. Cable kits have all the cables you need to connect one computer to the OmniView™ SE:

PS/2 Cable Kit - A3X982

Includes:

- 2 x F2N036-06
- 1 x F2N025-06-T

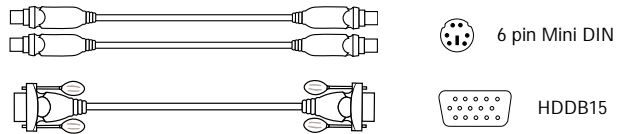

AT Cable Kit - A3X939

Includes:

- 1 x F3A510-06
- 1 x F2N025-06-T
- 1 x F2N209-06-T
- 1 x F2N017

(see below for descriptions of each)

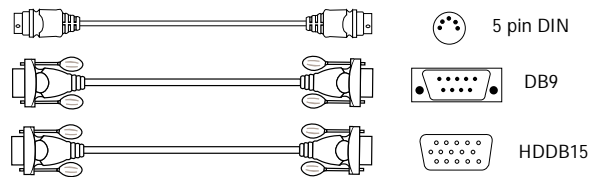

Individual Cables and Adapters:

- PS/2 cable for keyboard and mouse ports
6 pin Mini DIN male/male
Part# F2N036-XX
- Standard VGA cable for monitor port
HDDB15 male/female with thumbscrews
Part# F2N025-XX-T
- Serial extension cable for serial mouse
DB9 male/female with thumbscrews
Part# F2N209-XX-T
- AT keyboard cable for AT-style keyboard port
5 pin DIN male/male
Part# F3A510-XX
- AT to PS/2 keyboard adapter
5 pin DIN female/6 pin Mini DIN male
Part# F2N017

Daisy-Chain Cable

- DB25 Male/Male,
2' (.61m) with ferrite
Part # F1D108-CBL

Optional 19" (48.3cm) Rackmount Kit

- 19" (48.3cm), 1.5u high
Part # F1D103

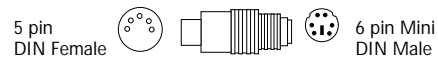

Other Cables and Adapters:

- High-resolution/high-refresh rate VGA cable for monitor port
HDDB15 male/female with thumbscrews
Part# A3H981-XX
- PS/2 to AT keyboard adapter - for use with a computer having an AT-style keyboard port
6 pin Mini DIN female/ 5 pin DIN male
Part# F2N018

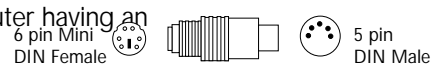

NOTE: The "-XX" in the part number represents the length in feet.

Hardware Installation

PLEASE FOLLOW THIS INSTALLATION PROCEDURE EXACTLY. NOT DOING SO MAY RESULT IN KEYBOARD AND/OR MOUSE ERRORS, OR FAULTY OPERATION.

WARNING: Before attempting to connect anything to the OmniView™ SE or the computers, make sure everything is powered off. Plugging and unplugging cables may cause irreversible damage to your computers and the OmniView™ SE. Belkin Components will not be held responsible for damage caused.

1. Set the DIP switches. If you have only one OmniView™ SE, use the MASTER bank setting. If the OmniView™ SE you are using will be daisy-chained off another unit, use a unique slave setting. Please refer to the next section for more information regarding multiple OmniView™ SE units.

DIP switches 1 & 2 set the SCAN_TIME. See the USAGE section regarding this setting

Use this setting if you have only one OmniView™ SE →

DIP SWITCH SETTINGS				BANK ADDRESS	
1	2	3	4		
ON	ON	ON	ON	BANK 0	MASTER
ON	ON	OFF	ON	BANK 1	Slave
ON	ON	ON	OFF	BANK 2	Slave
ON	ON	OFF	OFF	BANK 3	Slave

DIP Switches 1&2 set scantime. See page 15 for AutoScan Mode DIP Switch settings.

NOTE: "ON" is down ↓

2. Find a convenient place to put your OmniView™ SE. Take note of the length of your cables so that your computers, OmniView™ SE, keyboard, mouse, and monitor are distanced properly.
3. Connect the monitor to the OmniView™ SE. Using the attached cable, or the one included with your monitor, connect it to the HDDB15 female port on the back of the OmniView™ SE labeled with the monitor symbol at the CONSOLE section.

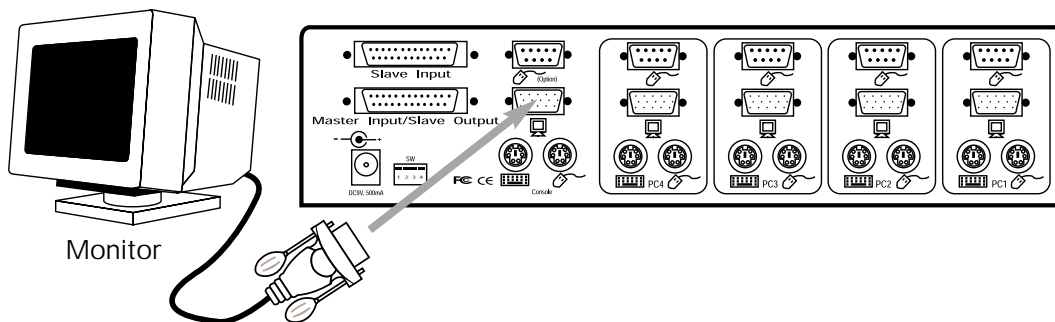

Hardware Installation (continued)

4. Connect the keyboard and mouse to the **OmniView™ SE**. If you have an AT-style keyboard, you will need an AT-PS/2 adapter (Belkin Part# F2N017).

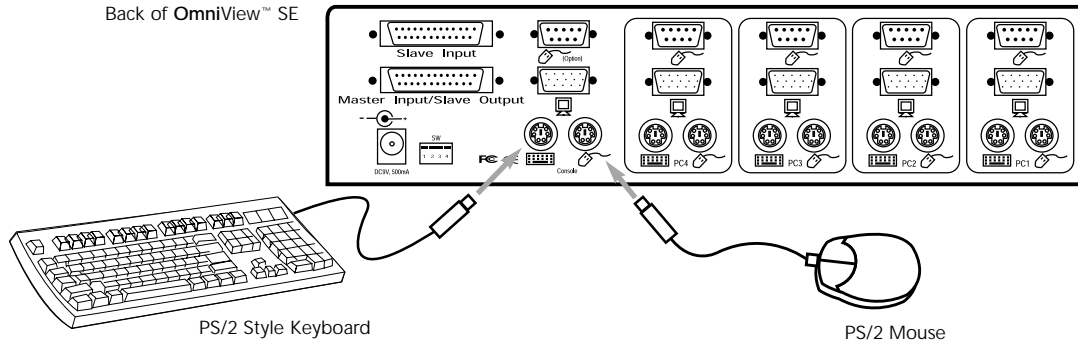

5. Connect the first computer's VGA cable to the **OmniView™ SE**. Using the VGA cable (Belkin Part# F2N025-XX-T or A3H981-XX), connect the male end of the cable to the VGA port on the computer, and the female end on the PC1 VGA port at the back of **OmniView™ SE**.

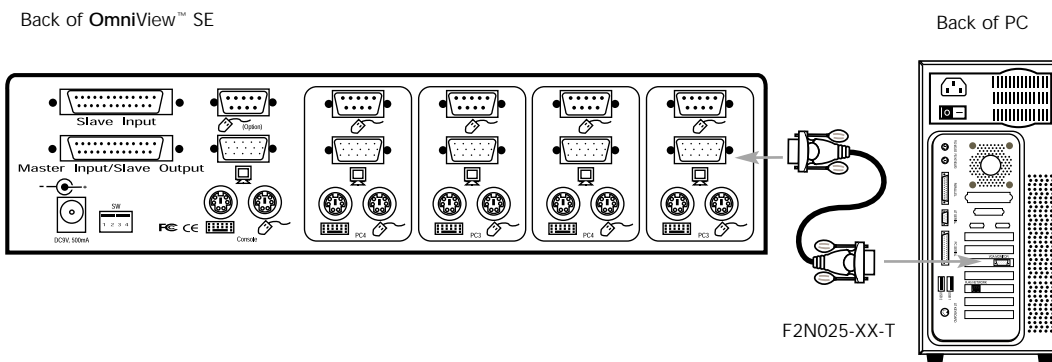

Hardware Installation (continued)

6. Connect the first computer's mouse cable to the **OmniView™ SE**. If using a PS/2 cable (Belkin Part# F2N036-XX), connect one end to the PS/2 mouse port on the computer, and the other end to the PC1 PS/2 mouse port on the back of the **OmniView™ SE**. If using a serial mouse cable (Belkin Part# F2N209-XX-T), connect one end to a DB9 serial port on the computer, and the other end to the PC1 DB9 serial mouse port on the back of the **OmniView™ SE**.

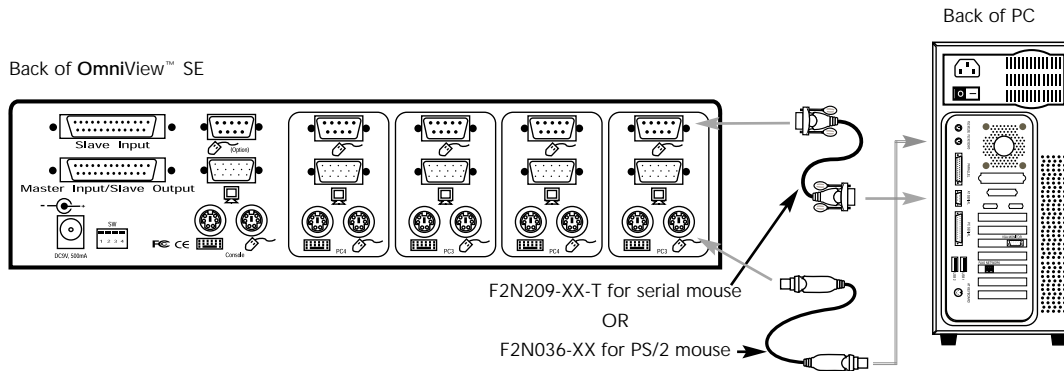

7. Connect the first computer's keyboard cable to the **OmniView™ SE**. If using a PS/2 cable (Belkin Part# F2N036-XX), connect one end to the PS/2 keyboard port on the computer, and the other end to the PC1 keyboard port on the back of the **OmniView™ SE**. If your computer has an AT-style keyboard port, you will need a PS/2-AT keyboard adapter (Belkin Part# F2N018). If using an AT-cable (Belkin Part# F3A510-XX), connect one end to the AT keyboard port on the computer, and the other end to an AT to PS/2 keyboard adapter (Belkin Part# F2N017). Then, connect the adapter to the PC1 keyboard port on the back of the **OmniView™ SE**.

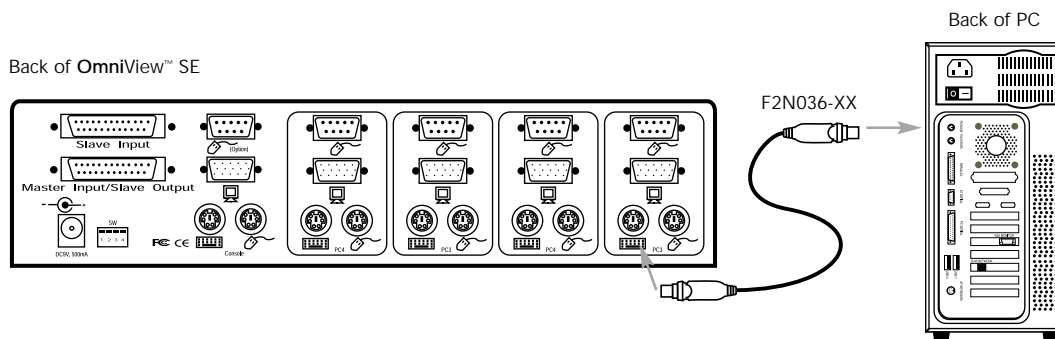

8. Double check all the connections. Make sure the keyboard and mouse cables go to the correct ports.
9. Repeat steps 5-7 for the remainder of the computers.
10. Attach the power supply to the power supply connector at the back of the **OmniView™ SE**. Plug this into any available AC outlet. You should see the LED or Port 1 on the front panel blink, and hear a beep. Power up your monitor.

Hardware Installation (continued)

11. You can now power up all of your computers simultaneously. The first computer will show up on the monitor. Check to see if the keyboard and mouse work, as well as the image displayed on the screen. If this is okay, press the SELECT button and check the functionality of the other computers. If you find any errors, double-check all of the cable connections.

NOTE: Avoid pressing any keys on the keyboard or moving the mouse if the currently selected port has a computer that is in the process of booting up. This may cause the computer to not detect, or initialize the keyboard or mouse drivers properly.

Daisy-Chained Operation

(SKIP IF YOU HAVE ONLY ONE OmniView™ SE)

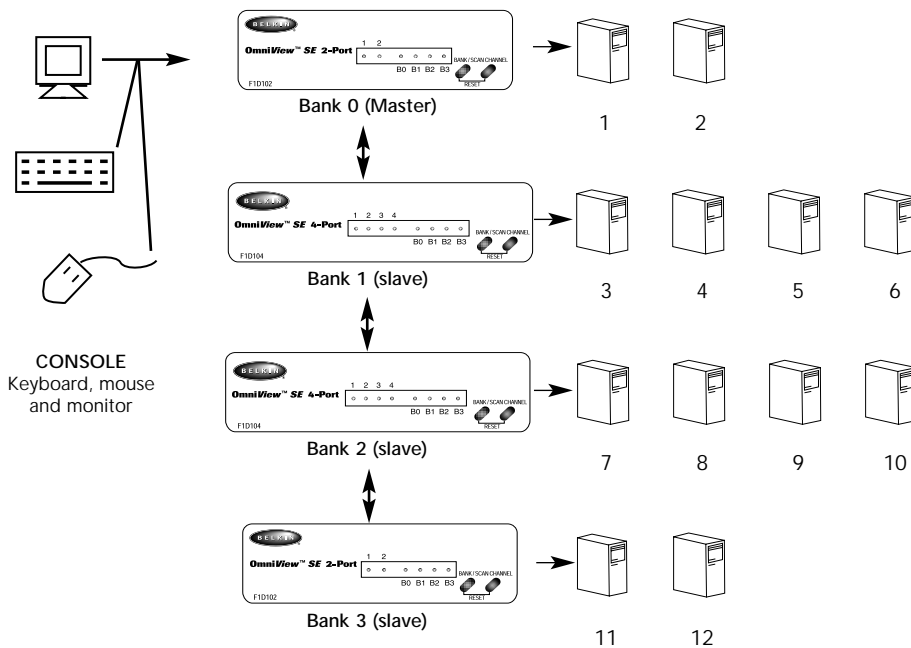

The OmniView™ SE has the capability to be daisy-chained to additional units for control over more computers. Up to four OmniView™ SE units can be daisy chained together, whether 2-Port, 4-Port, or a mixture of both. The example above shows two OmniView™ SE 2-Port units and two OmniView™ SE 4-Port units daisy chained together.

Each OmniView™ SE unit is defined as a "BANK." See diagram above for more information. BANK numbers range from 0 to 3 for a total of 4 BANKS. BANK 0 is the MASTER bank, while banks 1 through 3 are slave banks. The MASTER bank is the unit that connects to the console keyboard, mouse, and monitor.

The DIP switches must be set correctly for proper identification and usage. See page 6 for the actual settings. **If you are using the OmniView™ SE in a single-unit configuration, it must be set as the MASTER (BANK 0). If it is to be used as a slave unit, then it must be set to any unused unique bank number from 1 through 3.**

Daisy-Chained Operation (continued)

Daisy-chaining OmniView SE units with an OmniView™ PRO

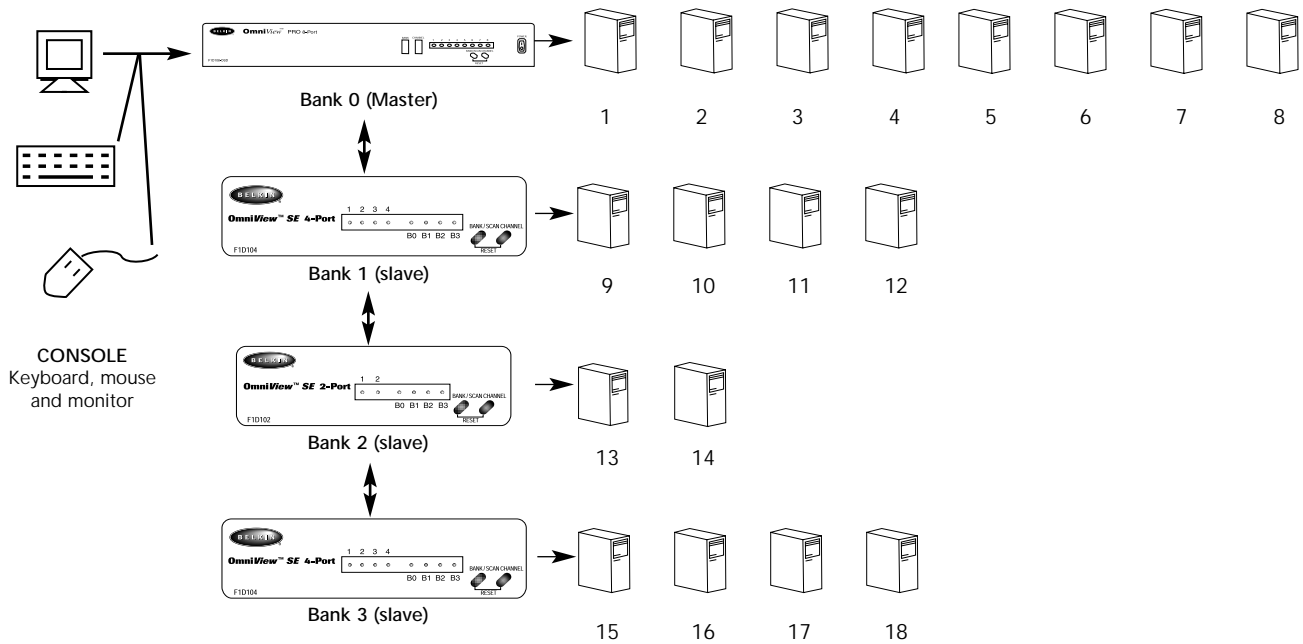

The **OmniView™** SE is designed to be able to cascade with the **OmniView™** PRO as well. In such a scenario, it is recommended that the **OmniView™** PRO be the MASTER unit, and the **OmniView™** SE units be slave units. This is shown in the diagram above. The **OmniView™** PRO is an 8-Port, 19" (48.3cm) rackmountable **OmniView™**, having the same features as the **OmniView™** SE, but adding On-Screen Display. When the **OmniView™** PRO is used as MASTER, all of the other **OmniView™** units in the chain will benefit from the On-Screen Display of the MASTER **OmniView™** PRO.

When the **OmniView™** PRO is used as the MASTER unit, 15 more **OmniView™** units (SE and/or PRO) can be daisy-chained to the master. Only BANKs 1 to 3 can be used by **OmniView™** SE units. BANKs 4 to 15 must be used by PRO units. Daisy-Chaining the **OmniView™** SE:

Daisy-Chained Operation (continued)

Adding Slave Units

This assumes you already have a MASTER unit (or MASTER and slave units) set-up and working properly. Below is the procedure of daisy-chaining a new slave unit.

- Set the DIP switches of the slave unit to a unique slave BANK setting.
- Connect the computers using the same procedure outlined in steps 5 to 9 in the previous section. **DO NOT POWER UP THE COMPUTERS YET.**
- Connect the power supply to the **OmniView™ SE**, and plug it into any available AC outlet. This is necessary to initialize the unit. You will see the LED display on the front panel show the unit's bank address setting.
- Using the F1D108-CBL daisy-chain cable, connect one end to the "Master Input / Slave Output" of the unit. Refer to the diagram above.
 - ❑ If the previous unit is the MASTER, then the other end of the cable connects to the "Master Input/Slave Output" port of the MASTER (such as cable 1 in the diagram above).
 - ❑ If the previous unit is a slave, then the other end goes to the "Slave Input" port of the previous slave unit (such as cables 2 and 3 in the diagram above).
- RESET the MASTER unit by pressing the BANK/SCAN and CHANNEL buttons simultaneously. This is necessary for the MASTER unit to detect the newly added slave unit.
- Verify that the MASTER unit has detected the new slave by pressing the BANK/SCAN button. If it detected the new slave properly, the LED "1" on the new slave unit will blink. If you have many slave units, you may have to press the BANK/SCAN button a couple of times to cycle through the preexisting slave units before reaching the newly added unit.
- Now you can power up the computers connected to the newly added slave unit. After all the computers have booted up, you may need to RESET the MASTER unit again to detect the presence of powered computers on the new slave unit.

Daisy-Chained Operation (continued)

Daisy-Chaining the OmniView™ SE:

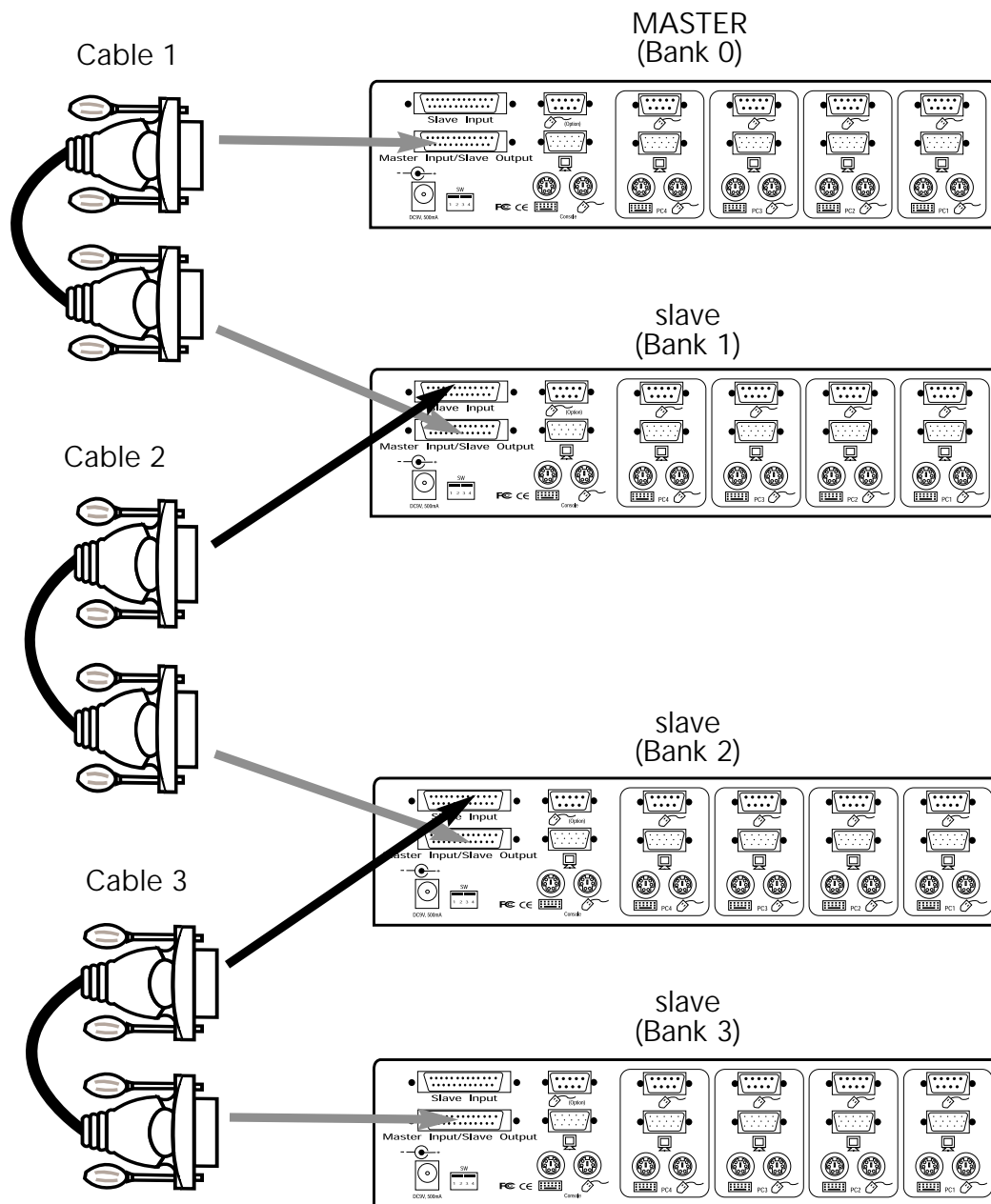

Usage

Selecting which computer to operate can be done either by the SELECT button, or through keyboard "Hot" key commands. You will notice that after the **OmniView™ SE** switches to another computer, the mouse will be inoperative for about 1-2 seconds. This is normal operation and ensures that proper mouse synchronization is established.

The SELECT Button:

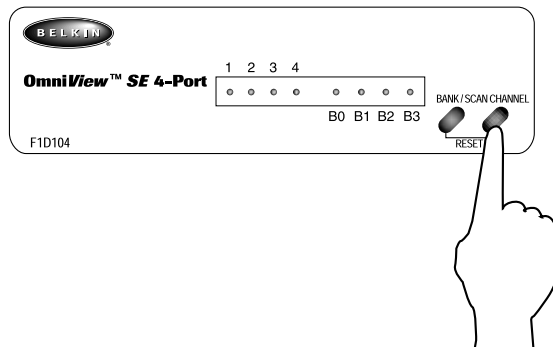

Pressing the **SELECT** button cycles you through all the ports, including inactive ports.

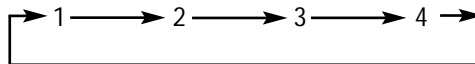

The BANK / SCAN Button:

Pressing the **BANK / SCAN** button cycles you through all the active BANKS (if there are slave units present) and then puts the unit in AutoScan mode. If the unit is a single MASTER unit, pressing the button immediately invokes AutoScan mode. This is evident by a long BEEP, followed by two short beeps.

Keyboard "Hot" Key commands:

You can also conveniently command the **OmniView™ SE** to switch ports through simple keyboard key sequences. To send commands to the **OmniView™ SE**, the **SCROLL LOCK** key must be pressed twice within 2 seconds. You will hear a beep for confirmation. Below are the different commands:

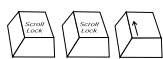

Switch to **PREVIOUS ACTIVE** port
(on the same BANK)

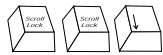

Switch to **NEXT ACTIVE** port
(on the same BANK)

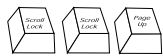

Switch to the **PREVIOUS BANK**
(by default, selects first active port on that BANK)

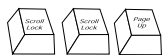

Switch to the **NEXT BANK**
(by default, selects first active port on that BANK)



Directly switches to port **Y** on **BANK X**.
($x=\{0-3\}$, $y=\{1-4\}$)

Usage (continued)

You can switch directly to any port by giving the **OmniView™ SE** the **BANK** and **PORT** numbers. For instance, if you press [SCROLL LOCK] [SCROLL LOCK] [2] [2], the computer on **PORT 2** of the **OmniView™ SE** set to **BANK 2** will be selected. In the diagram below, that is PC # 8. Hence, if you only have one **OmniView™ SE**, the first key (X) must be "0".

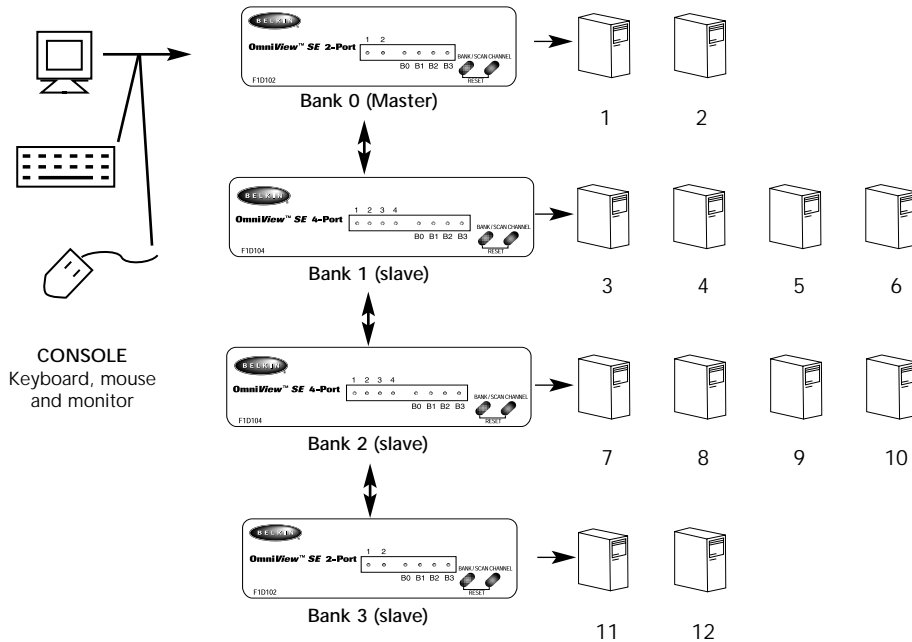

AutoScan Mode

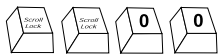

Enable AutoScan mode

In AutoScan mode, the **OmniView™ SE** remains on one port for a number of seconds, before switching to the next. Set DIP switches 1 & 2 using the table below according to a **SCAN_TIME** interval you prefer. If there are slave units present, the **SCAN_TIME** setting is set on the **MASTER** unit only, and need not be set on the slave units.

DIP SWITCH #		SCAN_TIME
1	2	
ON	ON	7 seconds
ON	OFF	15 seconds
OFF	ON	30 seconds
OFF	OFF	60 seconds

NOTE: There is no mouse or keyboard control in this mode. This is necessary to prevent errors. Otherwise, if the user is moving the mouse or using the keyboard when the **OmniView™ SE** switches to the next port, data flow is interrupted and will cause erratic mouse movement and/or the wrong characters to show up when using the keyboard.

To get out of AutoScan mode, press the [SPACEBAR].

Troubleshooting

General Problems:

Q: When cascading, the MASTER unit does not see the slave unit(s).

- A:**
- Refer to the Hardware Installation section for information on how to properly connect the daisy-chain cable.
 - Make sure that the daisy-chain cable that you are using is the F1D108-CBL. Using any other cable will not guarantee proper operation or video quality.
 - RESET the MASTER OmniView™ SE (or OmniView™ PRO), whichever the case may be.

Monitor/Video Problems:

Q: I am getting ghosting, shadowing or fuzzy images on my monitor. What do I do?

- A:**
- Check the cables and make sure they are inserted properly.
 - Your resolution and/or refresh rate is extremely high, or your cable is too long. Replace your VGA cables with coaxial, double-shielded cables such as Belkin A3H981-XX.
 - Check to make sure that the power adapter is plugged in and is working properly. It must be 9VDC, 600mA minimum. Make sure the power switch is on.
 - Lower your refresh rate and/or screen resolution settings.

Keyboard Problems:

Q: The keyboard is not detected, or a keyboard error is reported during boot-up.

- A:**
- Check the cables and make sure they are inserted properly in the correct ports.
 - Check to make sure that the power adapter is plugged in and is working properly. It must be 9VDC, 600mA minimum. Make sure the power switch is on.
 - RESET the OmniView™ SE by simultaneously pressing the BANK/SCAN and CHANNEL buttons on the front panel.
 - Do not press any keys on the keyboard while the selected computer is booting up. This is true for any PC, whether stand-alone or connected to a KVM switch.

Q: The computers boot up fine, but the keyboard does not work.

- A:**
- Check the cables and make sure they are inserted properly in the correct ports.
 - Make sure the keyboard works when directly plugged into the computers.
 - Try a different keyboard, but use only 101, 102 or 104-key keyboards.
 - Make sure that the keyboard driver is for 101, 102 or 104-key keyboards, and not old XT keyboards.
 - Check to make sure that the power adapter is plugged in and is working properly. It must be 9VDC, 600mA minimum. Make sure the power switch is on.
 - RESET the OmniView™ SE by simultaneously pressing the BANK/SCAN and CHANNEL buttons on the front panel.

PS/2 Mouse Problems at the Console or Computers:

Q: The mouse is not detected during boot-up.

- A:**
- Check the cables and make sure they are inserted properly in the correct ports.
 - Check your computer/motherboard documentation making sure that the PS/2 mouse port (or IRQ) is enabled.
 - Make sure the mouse is directly plugged into the computer. Rebooting is necessary when trying this. If the computer still does not detect the mouse, then your computer's PS/2 mouse port has a problem.
 - RESET the OmniView™ SE by simultaneously pressing the BANK/SCAN and CHANNEL buttons on the front panel.

Troubleshooting (continued)

Q: The computers boot up fine, but the mouse does not work.

- A:**
- Check the cables and make sure they are inserted properly in the correct ports.
 - Make sure the mouse works when directly plugged into the computer.
- Rebooting is necessary when trying this. If the mouse pointer still does not move, then either your PS/2 mouse port or the mouse itself has a problem.
- Try a different mouse.
 - Make sure the mouse is a true PS/2 mouse. A combo mouse will work just as long as it is set for PS/2 mode with the correct adapter. A serial-only mouse with a combo mouse adapter will not work.
 - Check to make sure that the power adapter is plugged in and is working properly. It must be 9VDC, 600mA minimum. Make sure the power switch is on.
 - RESET the **OmniView™ SE** by simultaneously pressing the BANK/SCAN and CHANNEL buttons on the front panel.
 - Switch to another computer port, then switch back. This is another method of re-initializing the mouse.

Q: When I switch from one port to another, mouse movement is completely erratic. What do I do?

- A:**
- Switch to another port, then switch back to the previous port. This can resynchronize the mouse.
 - RESET the **OmniView™ SE** by simultaneously pressing the BANK/SCAN and CHANNEL buttons on the front panel.
 - Make sure you do not have more than one mouse driver. Make sure that the driver is either for a Standard PS/2 or Microsoft®-compatible PS/2 mouse. Try to obtain the latest version from your hardware manufacturer.
 - If you are using a specialized mouse such as a cordless mouse, scrolling mouse or mice with more than 2 operational buttons, use generic PS/2 mouse drivers. Non-standard mice often use non-PS/2 proprietary mouse protocol.
 - Make sure you do not have any mouse drivers loaded in your config.sys or autoexec.bat files.
 - Avoid moving the mouse or pressing the mouse buttons when switching ports.
 - Reset the mouse to resume proper mouse movement simply by unplugging the mouse from the **OmniView™ SE** for about 2-3 seconds, and plugging it in again.
 - Switch to another computer port, then switch back. This is another method of re-initializing the mouse.

Problems with computers using the serial mouse output:

Note: The **OmniView™ SE** has Integrated Mouse Conversion Technology. This technology converts the PS/2 mouse signals at the console to serial mouse signals. Windows® 9x Control Panel System applet may not display that it has detected a mouse, but the Modem applet will show a serial mouse at a certain serial port.

Q: The computers boot up fine, but the mouse does not work.

- A:**
- Switch to another computer port, then switch back. This is another method of re-initializing the mouse.
 - Check the cables and make sure they are inserted properly in the correct ports.
 - Check the cable and make sure that it is a straight-through DB9 male/female cable such as Belkin P/N F2N209-XX-T (XX is the length in feet).
 - Check your computer/motherboard documentation making sure that the serial ports are enabled, and that there are no IRQ or base address conflicts with other serial ports or modems.
 - Plug in a serial mouse directly to your computer, and reboot. If the mouse pointer still does not move, then there maybe no serial mouse drivers installed, or the serial port on your computer may have other conflicts or problems.
 - Try a different PS/2 mouse at the console.
 - Make sure the mouse (at the console) is a true PS/2 mouse. A combo mouse will

Troubleshooting (continued)

work just as long as it is set for PS/2 mode with the correct adapter. A serial-only mouse with a combo mouse adapter WILL NOT work.

- Check to make sure that the power adapter is plugged in and is working properly. It must be 9VDC, 600mA minimum. Make sure the power switch is on.
- RESET the **OmniView™ SE** by simultaneously pressing the BANK/SCAN and CHANNEL buttons on the front panel.

Q: When I switch from one port to another, mouse movement is completely erratic. What do I do?

- A:**
- RESET the **OmniView™ SE** by simultaneously pressing the BANK/SCAN and CHANNEL buttons on the front panel.
 - Make sure you do not have more than one serial mouse driver loaded. Make sure that the driver is either for a Standard Serial or Microsoft®-compatible serial mouse.
 - Avoid using a specialized mouse at the console such as a cordless mouse, scrolling mouse or mice with more than 2 operational buttons. Non-standard mice often use non-PS/2 proprietary mouse protocol.
 - Make sure you do not have any other mouse drivers loaded in your config.sys or autoexec.bat files.
 - Avoid moving the mouse or pressing the mouse buttons when switching ports.
 - Reset the mouse to resume proper mouse movement simply by unplugging the mouse from the **OmniView™ SE** for about 2-3 seconds, and plugging it in again.
 - Switch to another computer port, then switch back. This is another method of re-initializing the mouse.

Q: The wheel on the Intellimouse® does not work on my computer. Why?

- A:**
- The Integrated Mouse Conversion Technology converts only the standard PS/2 signals which are the buttons and the x & y coordinate movement, but not the wheel movement or wheel button. This is because the wheel and wheel button data use non-PS/2 protocol.

Note about the Optional Serial Mouse port at the console:

If you have tried all possible troubleshooting methods, you can plug in a serial mouse (as a second mouse) at the optional serial mouse input port. See the Product Detail section, page 4, for the diagram. This mouse will be directly connected to the serial mouse ports on the **OmniView™ SE**. Note that the serial mouse signals will not be converted to PS/2 mouse signals, so if you have other PCs using PS/2 mouse ports, you must keep the PS/2 mouse at the console. This serial mouse is a second mouse, and is active only when on a computer that uses the serial mouse output.

Information

Contacting Belkin Components

Corporate Headquarters
501 West Walnut Street
Compton • CA • 90220
Phone 310.898.1100
800.223.5546
Fax 310.898.1111

Belkin Components, Ltd.
Clarke Road
Mount Farm • Bletchley
Milton Keynes • MK1 1LG
United Kingdom
Phone +44 (0) 1908367178
Fax +44 (0) 1908366564

www.belkin.com

FCC Statement

This equipment has been tested and found to comply with the limits for a Class B digital device, pursuant to part 15 of the FCC Rules. These limits are designed to provide reasonable protection against harmful interference in a residential installation. This equipment generates, uses and can radiate radio frequency energy and, if not installed and used in accordance with the instructions, may cause harmful interference to radio communications. However, there is no guarantee that interference will not occur in a particular installation. If this equipment does cause harmful interference to radio or television reception, which can be determined by turning the equipment off and on, the user is encouraged to try to correct the interference by one or more of the following measures:

- Reorient or relocate the receiving antenna.
- Increase separation between the equipment and receiver.
- Connect the equipment into an outlet on a circuit different from that to which the receiver is connected.
- Consult the dealer or an experienced radio technician for help.

CE Declaration of Conformity

We, Belkin Components, declare under our sole responsibility that the **OmniView™ SE**, to which this declaration relates, is in conformity with Generic Emissions Standard EN50081-1 and with Generic Immunity Standard EN50082-1 1992.

Belkin Components One Year Product Warranty

Belkin Components warrants this product against defects in materials and workmanship for one year. If a defect is discovered, Belkin will, at its option, repair or replace the product at no charge provided it is returned during the warranty period, with transportation charges prepaid, to the authorized Belkin dealer from whom you purchased the product. Proof of purchase may be required.

This warranty does not apply if the product has been damaged by accident, abuse, misuse, or misapplication; if the product has been modified without the written permission of Belkin; or if any Belkin serial number has been removed or defaced.

THE WARRANTY AND REMEDIES SET FORTH ABOVE ARE EXCLUSIVE IN LIEU OF ALL OTHERS, WHETHER ORAL OR WRITTEN, EXPRESSED OR IMPLIED. BELKIN SPECIFICALLY DISCLAIMS ANY AND ALL IMPLIED WARRANTIES, INCLUDING, WITHOUT LIMITATION, WARRANTIES OF MERCHANTABILITY AND FITNESS FOR A PARTICULAR PURPOSE.

No Belkin dealer, agent, or employee is authorized to make any modification, extension, or addition to this warranty.

BELKIN IS NOT RESPONSIBLE FOR SPECIAL, INCIDENTAL, OR CONSEQUENTIAL DAMAGES RESULTING FROM ANY BREACH OF WARRANTY, OR UNDER ANY OTHER LEGAL THEORY, INCLUDING BUT NOT LIMITED TO LOST PROFITS, DOWNTIME, GOODWILL, DAMAGE TO OR REPROGRAMMING, OR REPRODUCING ANY PROGRAM OR DATA STORED IN OR USED WITH BELKIN PRODUCTS.

Some states do not allow the exclusion or limitation of incidental or consequential damages or exclusions of implied warranties, so the above limitations of exclusions may not apply to you. This warranty gives you specific legal rights, and you may also have other rights that vary from state to state.

Free Manuals Download Website

<http://myh66.com>

<http://usermanuals.us>

<http://www.somanuals.com>

<http://www.4manuals.cc>

<http://www.manual-lib.com>

<http://www.404manual.com>

<http://www.luxmanual.com>

<http://aubethermostatmanual.com>

Golf course search by state

<http://golfingnear.com>

Email search by domain

<http://emailbydomain.com>

Auto manuals search

<http://auto.somanuals.com>

TV manuals search

<http://tv.somanuals.com>