



Powered by Accton

ES4324
24-Port Gigabit Ethernet
Lite Switch

Installation Guide

Installation Guide

24-Port Gigabit Lite Switch

*Layer 2 Workgroup Switch
with 24 1000BASE-T (RJ-45) Ports,
and 4 Gigabit Combination (RJ-45/SFP) Ports*

ES4324
E092007-AP-R01
150200057600A

Compliances and Safety Warnings

FCC - Class A

This equipment has been tested and found to comply with the limits for a Class A digital device, pursuant to part 15 of the FCC Rules. These limits are designed to provide reasonable protection against harmful interference when the equipment is operated in a commercial environment. This equipment generates, uses, and can radiate radio frequency energy and, if not installed and used in accordance with the instruction manual, may cause harmful interference to radio communications. Operation of this equipment in a residential area is likely to cause harmful interference in which case the user will be required to correct the interference at his own expense.

You are cautioned that changes or modifications not expressly approved by the party responsible for compliance could void your authority to operate the equipment.

You may use unshielded twisted-pair (UTP) for RJ-45 connections - Category 3 or better for 10 Mbps connections, Category 5 or better for 100 Mbps connections, Category 5, 5e, or 6 for 1000 Mbps connections. For fiber optic connections, you may use 50/125 or 62.5/125 micron multimode fiber or 9/125 micron single-mode fiber.

Industry Canada - Class A

This digital apparatus does not exceed the Class A limits for radio noise emissions from digital apparatus as set out in the interference-causing equipment standard entitled "Digital Apparatus," ICES-003 of the Department of Communications.

Cet appareil numérique respecte les limites de bruits radioélectriques applicables aux appareils numériques de Classe A prescrites dans la norme sur le matériel brouilleur: "Appareils Numériques," NMB-003 édictée par le ministère des Communications.

Japan VCCI Class A

この装置は、情報処理装置等電波障害自主規制協議会（VCCI）の基準に基づくクラスA情報技術装置です。この装置を家庭環境で使用すると電波妨害を引き起こすことがあります。この場合には使用者が適切な対策を講ずるよう要求されることがあります。

CE Mark Declaration of Conformance for EMI and Safety (EEC)

This information technology equipment complies with the requirements of the Council Directive 89/336/EEC on the Approximation of the laws of the Member States relating to Electromagnetic Compatibility and 73/23/EEC for electrical equipment used within certain voltage limits and the Amendment Directive 93/68/EEC. For the evaluation of the compliance with these Directives, the following standards were applied:

- RFI Emission:
- Limit class A according to EN 55022:1998
 - Limit class A for harmonic current emission according to EN 61000-3-2/1995
 - Limitation of voltage fluctuation and flicker in low-voltage supply system according to EN 61000-3-3/1995
- Immunity:
- Product family standard according to EN 55024:1998
 - Electrostatic Discharge according to EN 61000-4-2:1995 (Contact Discharge: ± 4 kV, Air Discharge: ± 8 kV)
 - Radio-frequency electromagnetic field according to EN 61000-4-3:1996 (80 - 1000 MHz with 1 kHz AM 80% Modulation: 3 V/m)
 - Electrical fast transient/burst according to EN 61000-4-4:1995 (AC/DC power supply: ± 1 kV, Data/Signal lines: ± 0.5 kV)
 - Surge immunity test according to EN 61000-4-5:1995 (AC/DC Line to Line: ± 1 kV, AC/DC Line to Earth: ± 2 kV)
 - Immunity to conducted disturbances, Induced by radio-frequency fields: EN 61000-4-6:1996 (0.15 - 80 MHz with 1 kHz AM 80% Modulation: 3 V/m)
 - Power frequency magnetic field immunity test according to EN 61000-4-8:1993 (1 A/m at frequency 50 Hz)
 - Voltage dips, short interruptions and voltage variations immunity test according to EN 61000-4-11:1994 (>95% Reduction @10 ms, 30% Reduction @500 ms, >95% Reduction @5000 ms)
- LVD:
- EN 60950-1:2001

Caution: Do not plug a phone jack connector in the RJ-45 port. This may damage this device.

Attention: Les raccordeurs ne sont pas utilisés pour le système téléphonique!

Safety Compliance

Warning: Fiber Optic Port Safety



When using a fiber optic port, never look at the transmit laser while it is powered on. Also, never look directly at the fiber TX port and fiber cable ends when they are powered on.

Avertissement: Ports pour fibres optiques - sécurité sur le plan optique



Ne regardez jamais le laser tant qu'il est sous tension. Ne regardez jamais directement le port TX (Transmission) à fibres optiques et les embouts de câbles à fibres optiques tant qu'ils sont sous tension.

Warnhinweis: Faseroptikanschlüsse - Optische Sicherheit



Niemals ein Übertragungslaser betrachten, während dieses eingeschaltet ist. Niemals direkt auf den Faser-TX-Anschluß und auf die Faserkabelenden schauen, während diese eingeschaltet sind.

Power Cord Safety

Please read the following safety information carefully before installing this switch:

Warning: Installation and removal of the unit must be carried out by qualified personnel only.

- The unit must be connected to an earthed (grounded) outlet to comply with international safety standards.
- Do not connect the unit to an A.C. outlet (power supply) without an earth (ground) connection.
- The appliance coupler (the connector to the unit and not the wall plug) must have a configuration for mating with an EN 60320/IEC 320 appliance inlet.
- The socket outlet must be near to the unit and easily accessible. You can only remove power from the unit by disconnecting the power cord from the outlet.
- This unit operates under SELV (Safety Extra Low Voltage) conditions according to IEC 60950. The conditions are only maintained if the equipment to which it is connected also operates under SELV conditions.

France and Peru only

This unit cannot be powered from IT† supplies. If your supplies are of IT type, this unit must be powered by 230 V (2P+T) via an isolation transformer ratio 1:1, with the secondary connection point labelled Neutral, connected directly to earth (ground).

† Impédance à la terre

Important! Before making connections, make sure you have the correct cord set. Check it (read the label on the cable) against the following:

Power Cord Set	
U.S.A. and Canada	The cord set must be UL-approved and CSA certified.
	The minimum specifications for the flexible cord are: - No. 18 AWG - not longer than 2 meters, or 16 AWG. - Type SV or SJ - 3-conductor
	The cord set must have a rated current capacity of at least 10 A.
	The attachment plug must be an earth-grounding type with NEMA 5-15P (15 A, 125 V) or NEMA 6-15P (15 A, 250 V) configuration.
Denmark	The supply plug must comply with Section 107-2-D1, Standard DK2-1a or DK2-5a.
Switzerland	The supply plug must comply with SEV/ASE 1011.
U.K.	The supply plug must comply with BS1363 (3-pin 13 A) and be fitted with a 5 A fuse which complies with BS1362.
	The mains cord must be <HAR> or <BASEC> marked and be of type HO3VVF3GO.75 (minimum).
Europe	The supply plug must comply with CEE7/7 ("SCHUKO").
	The mains cord must be <HAR> or <BASEC> marked and be of type HO3VVF3GO.75 (minimum).
	IEC-320 receptacle.

Veillez lire à fond l'information de la sécurité suivante avant d'installer le Switch:

AVERTISSEMENT: L'installation et la dépose de ce groupe doivent être confiés à un personnel qualifié.

- Ne branchez pas votre appareil sur une prise secteur (alimentation électrique) lorsqu'il n'y a pas de connexion de mise à la terre (mise à la masse).
- Vous devez raccorder ce groupe à une sortie mise à la terre (mise à la masse) afin de respecter les normes internationales de sécurité.
- Le coupleur d'appareil (le connecteur du groupe et non pas la prise murale) doit respecter une configuration qui permet un branchement sur une entrée d'appareil EN 60320/IEC 320.
- La prise secteur doit se trouver à proximité de l'appareil et son accès doit être facile. Vous ne pouvez mettre l'appareil hors circuit qu'en débranchant son cordon électrique au niveau de cette prise.
- L'appareil fonctionne à une tension extrêmement basse de sécurité qui est conforme à la norme IEC 60950. Ces conditions ne sont maintenues que si l'équipement auquel il est raccordé fonctionne dans les mêmes conditions.

France et Pérou uniquement:

Ce groupe ne peut pas être alimenté par un dispositif à impédance à la terre. Si vos alimentations sont du type impédance à la terre, ce groupe doit être alimenté par une tension de 230 V (2 P+T) par le biais d'un transformateur d'isolement à rapport 1:1, avec un point secondaire de connexion portant l'appellation Neutre et avec raccordement direct à la terre (masse).

Cordon électrique - Il doit être agréé dans le pays d'utilisation	
Etats-Unis et Canada:	Le cordon doit avoir reçu l'homologation des UL et un certificat de la CSA.
	Les spécifications minimales pour un câble flexible sont AWG No. 18, ou AWG No. 16 pour un câble de longueur inférieure à 2 mètres. - type SV ou SJ - 3 conducteurs
	Le cordon doit être en mesure d'acheminer un courant nominal d'au moins 10 A.
	La prise femelle de branchement doit être du type à mise à la terre (mise à la masse) et respecter la configuration NEMA 5-15P (15 A, 125 V) ou NEMA 6-15P (15 A, 250 V).
Danemark:	La prise mâle d'alimentation doit respecter la section 107-2 D1 de la norme DK2 1a ou DK2 5a.
Suisse:	La prise mâle d'alimentation doit respecter la norme SEV/ASE 1011.
Europe	La prise secteur doit être conforme aux normes CEE 7/7 ("SCHUKO") LE cordon secteur doit porter la mention <HAR> ou <BASEC> et doit être de type HO3VVF3GO.75 (minimum).

Bitte unbedingt vor dem Einbauen des Switches die folgenden Sicherheitsanweisungen durchlesen:

WARNING: Die Installation und der Ausbau des Geräts darf nur durch Fachpersonal erfolgen.

- Das Gerät sollte nicht an eine ungeerdete Wechselstromsteckdose angeschlossen werden.
- Das Gerät muß an eine geerdete Steckdose angeschlossen werden, welche die internationalen Sicherheitsnormen erfüllt.
- Der Gerätestecker (der Anschluß an das Gerät, nicht der Wandsteckdosenstecker) muß einen gemäß EN 60320/IEC 320 konfigurierten Geräteeingang haben.
- Die Netzsteckdose muß in der Nähe des Geräts und leicht zugänglich sein. Die Stromversorgung des Geräts kann nur durch Herausziehen des Gerätenetzkabels aus der Netzsteckdose unterbrochen werden.
- Der Betrieb dieses Geräts erfolgt unter den SELV-Bedingungen (Sicherheitskleinstspannung) gemäß IEC 60950. Diese Bedingungen sind nur gegeben, wenn auch die an das Gerät angeschlossenen Geräte unter SELV-Bedingungen betrieben werden.

Stromkabel. Dies muss von dem Land, in dem es benutzt wird geprüft werden:	
Schweiz	Dieser Stromstecker muß die SEV/ASE 1011Bestimmungen einhalten.
Europe	Das Netzkabel muß vom Typ HO3VVF3GO.75 (Mindestanforderung) sein und die Aufschrift <HAR> oder <BASEC> tragen. Der Netzstecker muß die Norm CEE 7/7 erfüllen ("SCHUKO").

Warnings and Cautionary Messages

- Warning:** This product does not contain any serviceable user parts.
- Warning:** Installation and removal of the unit must be carried out by qualified personnel only.
- Warning:** When connecting this device to a power outlet, connect the field ground lead on the tri-pole power plug to a valid earth ground line to prevent electrical hazards.
- Warning:** This switch uses lasers to transmit signals over fiber optic cable. The lasers are compliant with the requirements of a Class 1 Laser Product and are inherently eye safe in normal operation. However, you should never look directly at a transmit port when it is powered on.
- Caution:** Wear an anti-static wrist strap or take other suitable measures to prevent electrostatic discharge when handling this equipment.
- Caution:** Do not plug a phone jack connector in the RJ-45 port. This may damage this device. Les raccordeurs ne sont pas utilisé pour le système téléphonique!
- Caution:** Use only twisted-pair cables with RJ-45 connectors that conform to FCC standards.

Warnings (in German)

- Achtung:** Dieses Produkt enthält keine Teile, die eine Wartung vom Benutzer benötigen.
- Achtung:** Installation und Deinstallation des Gerätes müssen von qualifiziertem Servicepersonal durchgeführt werden.
- Achtung:** Wenn das Gerät an eine Steckdose angeschlossen wird, muß der Masseanschluß am dreipoligen Netzstecker mit Schutzerde verbunden werden, um elektrische Gefahren zu vermeiden.
- Achtung:** Dieses Gerät nutzt Laser zur Signalübertragung über Glasfasern. Die Laser entsprechen den Anforderungen an eine Lasereinrichtung der Klasse 1 und sind durch ihre Bauart im normalen Betrieb sicher für die Augen. Trotzdem sollte niemals direkt in den einen Übertragungskanal geblickt werden, wenn er eingeschaltet ist.

Environmental Statement

The manufacturer of this product endeavours to sustain an environmentally-friendly policy throughout the entire production process. This is achieved through the following means:

- Adherence to national legislation and regulations on environmental production standards.
- Conservation of operational resources.
- Waste reduction and safe disposal of all harmful un-recyclable by-products.
- Recycling of all reusable waste content.
- Design of products to maximize recyclables at the end of the product's life span.
- Continual monitoring of safety standards.

End of Product Life Span

This product is manufactured in such a way as to allow for the recovery and disposal of all included electrical components once the product has reached the end of its life.

Manufacturing Materials

There are no hazardous nor ozone-depleting materials in this product.

Documentation

All printed documentation for this product uses biodegradable paper that originates from sustained and managed forests. The inks used in the printing process are non-toxic.

Purpose

This guide details the hardware features of this switch, including its physical and performance-related characteristics, and how to install the switch.

Audience

This guide is for system administrators with a working knowledge of network management. You should be familiar with switching and networking concepts.

Zielgruppe Dieser Anleitung ist fuer Systemadministratoren mit Erfahrung im Netzwerkmanagement. Sie sollten mit Switch- und Netzwerkkonzepten vertraut sein.

Related Publications

The following publication gives specific information on how to operate and use the management functions of this switch:

The *Management Guide*

Also, as part of both switches firmware, there is an online web-based help that describes all management related features.

Contents

Chapter 1: Introduction	1-1
Overview	1-1
Switch Architecture	1-2
Network Management Options	1-2
Description of Hardware	1-2
10/100/1000BASE-T Ports	1-2
SFP Slots	1-2
Port and Power Status LEDs	1-3
Power Supply Socket	1-4
Features and Benefits	1-4
Connectivity	1-4
Expandability	1-4
Performance	1-4
Management	1-5

Chapter 2: Network Planning	2-1
Introduction to Switching	2-1
Application Examples	2-2
Collapsed Backbone	2-2
Central Wiring Closet	2-3
Remote Connections with Fiber Cable	2-4
Making VLAN Connections	2-5
Application Notes	2-6

Chapter 3: Installing the Switch	3-1
Selecting a Site	3-1
Ethernet Cabling	3-1
Equipment Checklist	3-2
Package Contents	3-2
Optional Rack-Mounting Equipment	3-2
Mounting	3-3
Rack Mounting	3-3
Desktop or Shelf Mounting	3-4
Installing an Optional SFP Transceiver	3-5
Connecting to a Power Source	3-6

Chapter 4: Making Network Connections	4-1
Connecting Network Devices	4-1
Twisted-Pair Devices	4-1
Cabling Guidelines	4-1
Connecting to PCs, Servers, Hubs and Switches	4-2
Network Wiring Connections	4-2
Fiber Optic SFP Devices	4-4
Connectivity Rules	4-6
1000BASE-T Cable Requirements	4-6
1000 Mbps Gigabit Ethernet Collision Domain	4-6
100 Mbps Fast Ethernet Collision Domain	4-7
10 Mbps Ethernet Collision Domain	4-7
Cable Labeling and Connection Records	4-8

Appendix A: Troubleshooting	A-1
Diagnosing Switch Indicators	A-1
Power and Cooling Problems	A-1
Installation	A-2
In-Band Access	A-2

Appendix B: Cables	B-1
Twisted-Pair Cable and Pin Assignments	B-1
10BASE-T/100BASE-TX Pin Assignments	B-1
Straight-Through Wiring	B-2
Crossover Wiring	B-3
1000BASE-T Pin Assignments	B-3
Cable Testing for Existing Category 5 Cable	B-4
Fiber Standards	B-4

Appendix C: Specifications	C-1
Physical Characteristics	C-1
Switch Features	C-2
Management Features	C-2
Standards	C-2
Compliances	C-3

Glossary

Index

Tables

Table 1-1	Port Status LEDs	1-3
Table 1-2	Power Status LED	1-3
Table 4-1	Maximum 1000BASE-T Gigabit Ethernet Cable Length	4-6
Table 4-2	Maximum 1000BASE-SX Fiber Optic Cable Length	4-6
Table 4-3	Maximum 1000BASE-LX Fiber Optic Cable Length	4-6
Table 4-4	Maximum 1000BASE-LH Fiber Optic Cable Length	4-6
Table 4-5	Maximum Fast Ethernet Cable Length	4-7
Table 4-6	Maximum Ethernet Cable Length	4-7
Table A-1	Troubleshooting Chart	A-1
Table B-1	10/100BASE-TX MDI and MDI-X Port Pinouts	B-2
Table B-2	1000BASE-T MDI and MDI-X Port Pinouts	B-3

Figures

Figure 1-1	Front Panels	1-1
Figure 1-2	Rear Panel	1-1
Figure 1-3	Por and Power LEDs	1-3
Figure 1-4	Power Supply Socket	1-4
Figure 2-1	Collapsed Backbone	2-2
Figure 2-2	Central Wiring Closet	2-3
Figure 2-3	Remote Connections with Fiber Cable	2-4
Figure 2-4	Making VLAN Connections	2-5
Figure 3-1	RJ-45 Connections	3-2
Figure 3-2	Attaching the Brackets	3-3
Figure 3-3	Installing the Switch in a Rack	3-4
Figure 3-4	Attaching the Adhesive Feet	3-4
Figure 3-5	Inserting an SFP Transceiver into a Slot	3-5
Figure 3-6	Power Socket	3-6
Figure 4-1	Making Twisted-Pair Connections	4-2
Figure 4-2	Wiring Closet Connections	4-3
Figure 4-3	Making Connections to SFP Transceivers	4-5
Figure B-1	RJ-45 Connector Pin Numbers	B-1
Figure B-2	Straight-through Wiring	B-2
Figure B-3	Crossover Wiring	B-3

Chapter 1: Introduction

Overview

The ES4324 is an intelligent Layer 2 switch with 24 10/100/1000BASE-T ports, four of which are Gigabit combination ports* that are shared with four SFP transceiver slots (see Figure 1-1, Ports 21-24).

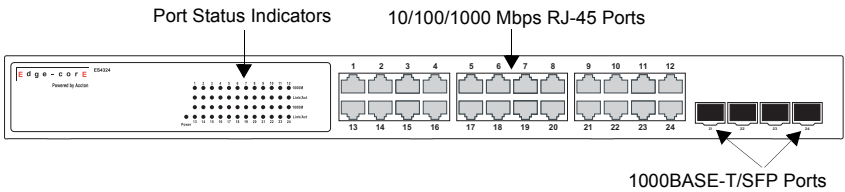

Figure 1-1 Front Panels



Figure 1-2 Rear Panel

* If an SFP transceiver is plugged in, the corresponding RJ-45 port is disabled for ports 21-24.

Switch Architecture

The switch employs a wire-speed, non-blocking switching fabric. This permits simultaneous wire-speed transport of multiple packets at low latency on all ports. The switch also features full-duplex capability on all ports, which effectively doubles the bandwidth of each connection.

The switch uses store-and-forward switching to ensure maximum data integrity. With store-and-forward switching, the entire packet must be received into a buffer and checked for validity before being forwarded. This prevents errors from being propagated throughout the network.

Network Management Options

The switch contains a comprehensive array of LEDs for “at-a-glance” monitoring of network and port status. It also includes a management agent that allows you to configure or monitor the switch using its embedded Web-management software, or via SNMP applications.

For a detailed description of switch’s advanced features, refer to the *Management Guide*.

Description of Hardware

10/100/1000BASE-T Ports

The switch contains 24 RJ-45 ports that operate at 10 Mbps or 100 Mbps, half or full duplex, or at 1000 Mbps, full duplex. Because all ports on the switch support automatic MDI/MDI-X operation, you can use straight-through cables for all network connections to PCs or servers, or to other switches or hubs. (See “1000BASE-T Pin Assignments” on page B-3.)

Each of these ports support auto-negotiation, so the optimum transmission mode (half or full duplex), and data rate (10, 100, or 1000 Mbps) can be selected automatically.

SFP Slots

The Small Form Factor Pluggable (SFP) transceiver slots are shared with four of the RJ-45 ports (ports 21-24). In its default configuration, if an SFP transceiver (purchased separately) is installed in a slot and has a valid link on its port, the associated RJ-45 port is disabled and cannot be used.

Port and Power Status LEDs

The switch includes a display panel for key system and port indications that simplify installation and network troubleshooting. The LEDs, which are located on the front panel for easy viewing, are shown below and described in the following tables.

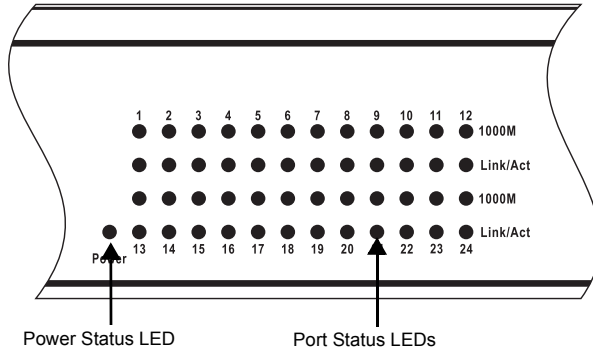

Figure 1-3 Port and Power LEDs

Table 1-1 Port Status LEDs

LED	Condition	Status
Fast Ethernet Ports (Ports 1-24)		
Link/Act (Link/Activity)	On/Flashing Green	Port has established a valid network connection. Flashing indicates activity.
	Off	There is no valid link on the port.
1000 Mbps	On Green	Port is operating at 1000 Mbps.
	Off	Port is operating at 10 or 100 Mbps.

Table 1-2 Power Status LED

LED	Condition	Status
Power	Green	Internal power is operating normally.
	Off	Power off.

Power Supply Socket

The power socket is located on the rear panel of the switch. The standard power socket is for the AC power cord.

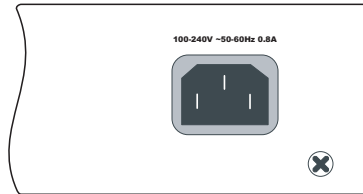

Figure 1-4 Power Supply Socket

Features and Benefits

Connectivity

- 24 10/100/1000 Mbps ports for easy Gigabit Ethernet integration and for protection of your investment in legacy LAN equipment.
- Auto-negotiation enables each RJ-45 port to automatically select the optimum communication mode (half or full duplex) if this feature is supported by the attached device; otherwise the port can be configured manually.
- RJ-45 10/100/1000BASE-T ports support auto MDI/MDI-X pinout selection.
- Unshielded (UTP) cable supported on all RJ-45 ports: Category 3 or better for 10 Mbps connections, Category 5 or better for 100 Mbps connections, and Category 5, 5e, 6 or better for 1000 Mbps connections.
- IEEE 802.3-2005 Ethernet, Fast Ethernet, and Gigabit Ethernet.

Expandability

- Four Small Form Factor Pluggable (SFP) transceiver slots (shared with 1000BASE-T ports)
- Supports 1000BASE-SX, 1000BASE-LX and 1000BASE-LH SFP transceivers.

Performance

- Transparent bridging.
- Provides store-and-forward switching.
- Jumbo-Frame up to 9,6 Kbytes
- Supports flow control
- Broadcast storm control

Management

- “At-a-glance” LEDs for easy troubleshooting.
- Network management agent
 - Manages switch in-band
 - Supports SNMP v1/v2c, RMON and web-based interface

Chapter 2: Network Planning

Introduction to Switching

A network switch allows simultaneous transmission of multiple packets via non-crossbar switching. This means that it can partition a network more efficiently than bridges or routers. The switch has, therefore, been recognized as one of the most important building blocks for today's networking technology.

When performance bottlenecks are caused by congestion at the network access point (such as the network card for a high-volume file server), the device experiencing congestion (server, power user or hub) can be attached directly to a switched port. And, by using full-duplex mode, the bandwidth of the dedicated segment can be doubled to maximize throughput.

When networks are based on repeater (hub) technology, the distance between end stations is limited by a maximum hop count. However, a switch turns the hop count back to zero. So subdividing the network into smaller and more manageable segments, and linking them to the larger network by means of a switch, removes this limitation.

A switch can be easily configured in any Ethernet, Fast Ethernet, or Gigabit Ethernet, network to significantly boost bandwidth while using conventional cabling and network cards.

Application Examples

The switch is not only designed to segment your network, but also to provide a wide range of options in setting up network connections. Some typical applications are described below.

Collapsed Backbone

The switch is an excellent choice for mixed Ethernet, Fast Ethernet, and Gigabit Ethernet installations where significant growth is expected in the near future. In a basic stand-alone configuration, it can provide direct full-duplex connections for up to 24 workstations or servers. You can easily build on this basic configuration, adding direct full-duplex connections to workstations or servers. When the time comes for further expansion, just connect to another hub or switch using one of the Gigabit Ethernet ports built into the front panel, a Gigabit Ethernet port on a plug-in SFP transceiver.

In the figure below, the 24-port switch is operating as a collapsed backbone for a small LAN. It is providing dedicated 10 Mbps full-duplex connections to workstations, 100 Mbps full-duplex connections to power users, and 1 Gbps full-duplex connections to servers.

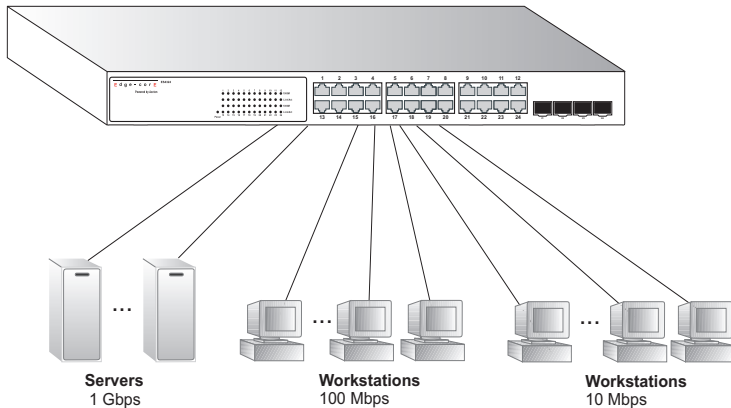

Figure 2-1 Collapsed Backbone

Central Wiring Closet

With 24 parallel bridging ports (i.e., 24 distinct collision domains), this switch can collapse a complex network down into a single efficient bridged node, increasing overall bandwidth and throughput.

In the figure below, the 1000BASE-T RJ-45 ports on the switch are providing 1 Gbps full-duplex connections for up to 24 local segments. In addition, the switch is also connecting remote servers over fiber optic cable at 1 Gbps.

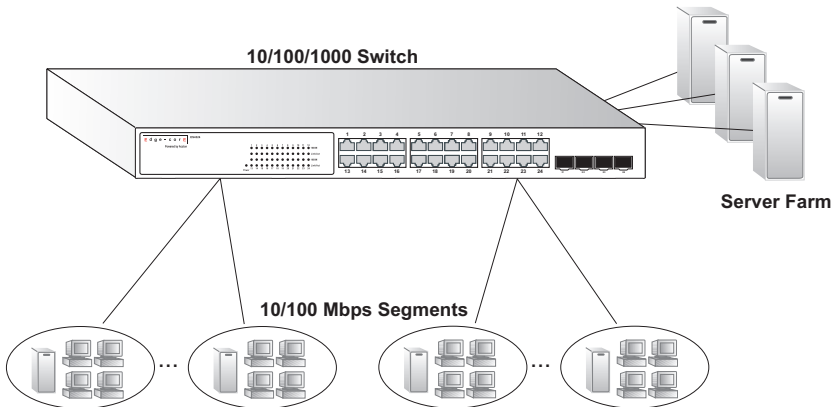

Figure 2-2 Central Wiring Closet

Remote Connections with Fiber Cable

Fiber optic technology allows for longer cabling than any other media type. A 1000BASE-SX (MMF) link can connect to a site up to 550 meters away, a 1000BASE-LX (SMF) link up to 5 km, and a 1000BASE-LH link up to 70 km. This allows a switch stack to serve as a collapsed backbone, providing direct connectivity for a widespread LAN.

A 1000BASE-SX SFP transceiver can be used for a high-speed connection between floors in the same building, and a 1000BASE-LX transceiver can be used for high-bandwidth core connections between buildings in a campus setting. For long-haul connections, a 1000BASE-LH SFP transceiver can be used to reach another site up to 70 kilometers away.

The figure below illustrates three switches interconnecting multiple segments with fiber cable.

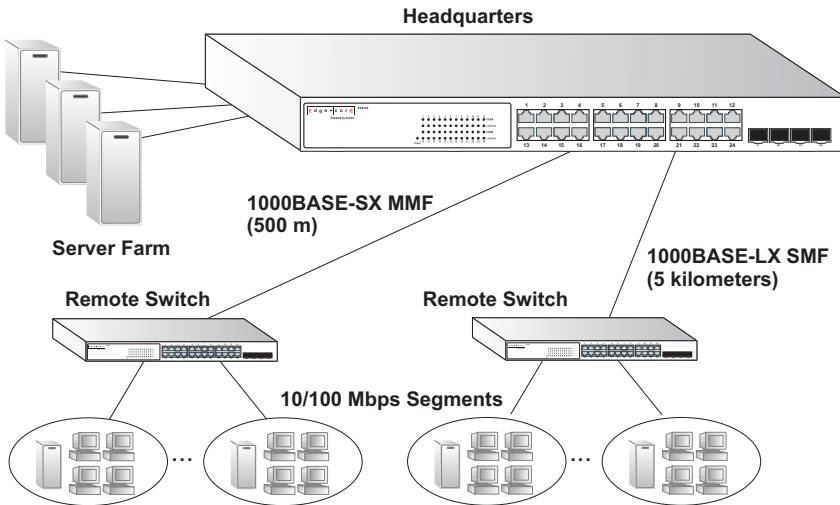

Figure 2-3 Remote Connections with Fiber Cable

Making VLAN Connections

The switch supports VLANs that can be used to organize any group of network nodes into separate broadcast domains. VLANs confine broadcast traffic to the originating group, and can eliminate broadcast storms in large networks. This provides a more secure and cleaner network environment.

VLANs can be based on untagged port groups, or traffic can be explicitly tagged to identify the VLAN group to which it belongs. Untagged VLANs can be used for small networks attached to a single switch. However, tagged VLANs should be used for larger networks, and all the VLANs assigned to the inter-switch links.

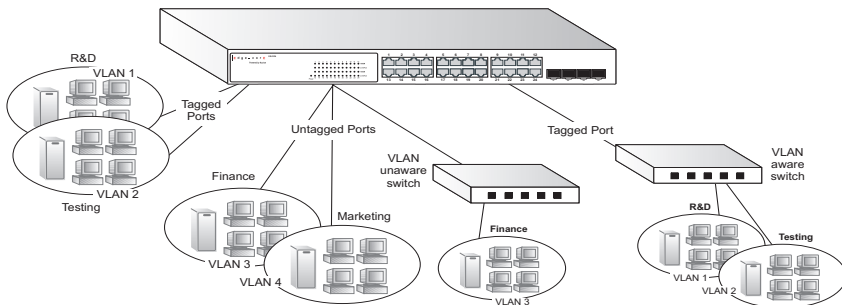

Figure 2-4 Making VLAN Connections

Note: When connecting to a switch that does not support IEEE 802.1Q VLAN tags, use untagged ports.

Application Notes

1. Full-duplex operation only applies to point-to-point access (such as when a switch is attached to a workstation, server or another switch). When the switch is connected to a hub, both devices must operate in half-duplex mode.
2. For network applications that require routing between dissimilar network types, you can attach the switch directly to a multi-protocol router.
3. As a general rule, the length of fiber optic cable for a single switched link should not exceed:
 - 1000BASE-SX: 550 m (1805 ft) for multimode fiber
 - 1000BASE-LX: 5 km (3.1 miles) for single-mode fiber
 - 1000BASE-LH: 70 km (43 miles) for single-mode fiber

However, power budget constraints must also be considered when calculating the maximum cable length for your specific environment.

Chapter 3: Installing the Switch

Selecting a Site

switch units can be mounted in a standard 19-inch equipment rack or on a flat surface. Be sure to follow the guidelines below when choosing a location.

- The site should:
 - be at the center of all the devices you want to link and near a power outlet.
 - be able to maintain its temperature within 0 to 40 °C (32 to 104 °F) and its humidity within 10% to 90%, non-condensing
 - provide adequate space (approximately five centimeters or two inches) on all sides for proper air flow
 - be accessible for installing, cabling and maintaining the devices
 - allow the status LEDs to be clearly visible
- Make sure twisted-pair cable is always routed away from power lines, fluorescent lighting fixtures and other sources of electrical interference, such as radios and transmitters.
- Make sure that the unit is connected to a separate grounded power outlet that provides 100 to 240 VAC, 50 to 60 Hz, is within 2 m (6.6 feet) of each device and is powered from an independent circuit breaker. As with any equipment, using a filter or surge suppressor is recommended.

Ethernet Cabling

To ensure proper operation when installing the switches into a network, make sure that the current cables are suitable for 10BASE-T, 100BASE-TX or 1000BASE-T operation. Check the following criteria against the current installation of your network:

- Cable type: Unshielded twisted pair (UTP) or shielded twisted pair (STP) cables with RJ-45 connectors; Category 3 or better for 10BASE-T, Category 5 or better for 100BASE-TX, and Category 5, 5e or 6 for 1000BASE-T.
- Protection from radio frequency interference emissions
- Electrical surge suppression
- Separation of electrical wires (switch related or other) and electromagnetic fields from data based network wiring
- Safe connections with no damaged cables, connectors or shields

3 Installing the Switch

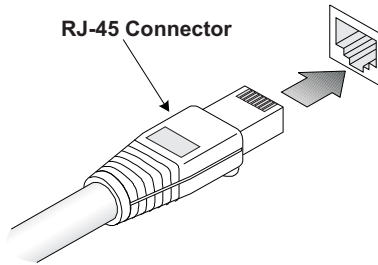

Figure 3-1 RJ-45 Connections

Equipment Checklist

After unpacking the switch unit, check the contents to be sure you have received all the components. Then, before beginning the installation, be sure you have all other necessary installation equipment.

Package Contents

- ES4324 switch
- Four adhesive foot pads
- Bracket Mounting Kit containing two brackets and eight screws for attaching the brackets to the switch
- Power cord—either US, Continental Europe or UK
- This Installation Guide
- Management Guide CD
- Warranty Registration Card—be sure to complete and return to Edge-core

Optional Rack-Mounting Equipment

If you plan to rack-mount the switches, be sure to have the following equipment available:

- Four mounting screws for each device you plan to install in a rack—these are not included
- A screwdriver (Phillips or flathead, depending on the type of screws used)

Mounting

A switch unit can be mounted in a standard 19-inch equipment rack or on a desktop or shelf. Mounting instructions for each type of site follow.

Rack Mounting

Before rack mounting the switch, pay particular attention to the following factors:

- **Temperature:** Since the temperature within a rack assembly may be higher than the ambient room temperature, check that the rack-environment temperature is within the specified operating temperature range (see page C-1).
- **Mechanical Loading:** Do not place any equipment on top of a rack-mounted unit.
- **Circuit Overloading:** Be sure that the supply circuit to the rack assembly is not overloaded.
- **Grounding:** Rack-mounted equipment should be properly grounded. Particular attention should be given to supply connections other than direct connections to the mains.

To rack-mount devices:

1. Attach the brackets to the device using the screws provided in the Bracket Mounting Kit.

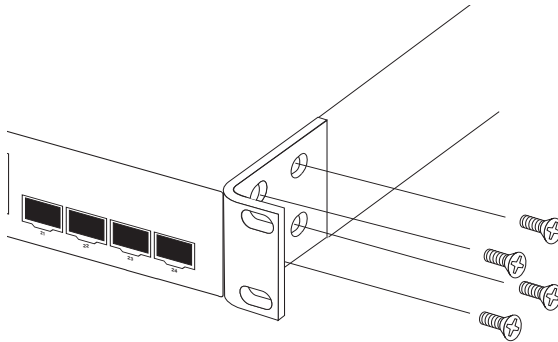

Figure 3-2 Attaching the Brackets

3 Installing the Switch

2. Mount the device in the rack, using four rack-mounting screws (not provided). Be sure to secure the lower rack-mounting screws first to prevent the brackets being bent by the weight of the switch.

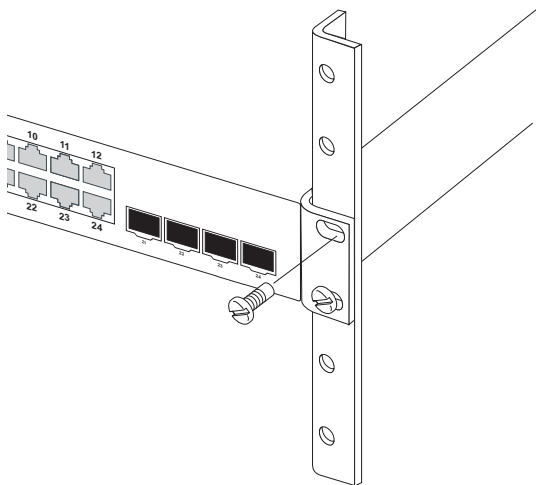

Figure 3-3 Installing the Switch in a Rack

3. If installing a single switch only, turn to “Connecting to a Power Source” at the end of this chapter.
4. If installing multiple switches, mount them in the rack, one below the other, in any order.

Desktop or Shelf Mounting

1. Attach the four adhesive feet to the bottom of the first switch.

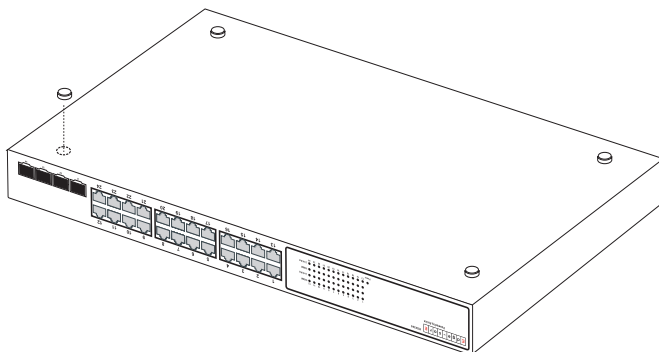

Figure 3-4 Attaching the Adhesive Feet

2. Set the device on a flat surface near an AC power source, making sure there are at least two inches of space on all sides for proper air flow.
3. If installing a single switch only, go to “Connecting to a Power Source” at the end of this chapter.
4. If installing multiple switches, attach four adhesive feet to each one. Place each device squarely on top of the one below, in any order.

Installing an Optional SFP Transceiver

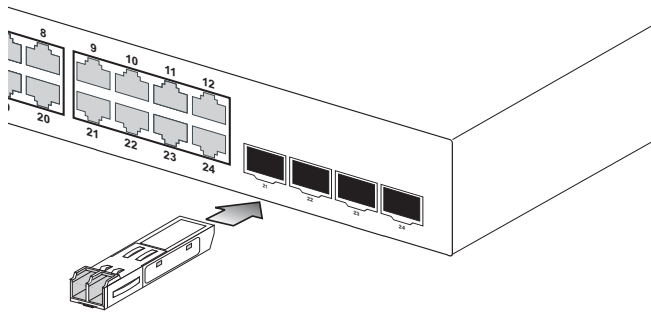

Figure 3-5 Inserting an SFP Transceiver into a Slot

The switch supports the following optional transceivers:

- 1000BASE-SX
- 1000BASE-LX
- 1000BASE-LH

To install an SFP transceiver, do the following:

1. Consider network and cabling requirements to select an appropriate transceiver type. Refer to “Connectivity Rules” on page 4-6.
2. Insert the transceiver with the optical connector facing outward and the slot connector facing down. Note that SFP transceivers are keyed so they can only be installed in one orientation.
3. Slide the transceiver into the slot until it clicks into place.

Note: SFP transceivers are hot-swappable. The switch does not need to be powered off before installing or removing a transceiver. However, always first disconnect the network cable before removing a transceiver.

Note: SFP transceivers are not provided in the switch package.

Connecting to a Power Source

To connect a device to a power source:

1. Insert the power cable plug directly into the socket located at the back of the device.

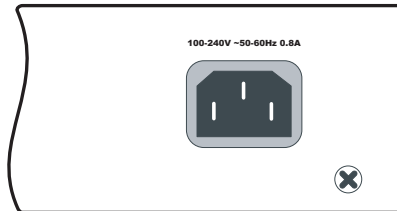

Figure 3-6 Power Socket

2. Plug the other end of the cable into a grounded, three-pin, AC power source.

Note: For international use, you may need to change the AC line cord. You must use a line cord set that has been approved for the socket type in your country.

3. Check the front-panel LEDs as the device is powered on to be sure the Power LED is on. If not, check that the power cable is correctly plugged in.

Chapter 4: Making Network Connections

Connecting Network Devices

The switch units are designed to interconnect multiple segments (or collision domains). It can be connected to network cards in PCs and servers, as well as to hubs, switches or routers. It may also be connected to devices using optional SFP transceivers.

Twisted-Pair Devices

Each device requires an unshielded twisted-pair (UTP) cable with RJ-45 connectors at both ends. Use Category 5, 5e or 6 cable for 1000BASE-T connections, Category 5 or better for 100BASE-TX connections, and Category 3 or better for 10BASE-T connections.

Cabling Guidelines

The RJ-45 ports on the switch support automatic MDI/MDI-X pinout configuration, so you can use standard straight-through twisted-pair cables to connect to any other network device (PCs, servers, switches, routers, or hubs).

See Appendix B: for further information on cabling.



Caution: Do not plug a phone jack connector into an RJ-45 port. This will damage the switch. Use only twisted-pair cables with RJ-45 connectors that conform to FCC standards.

Connecting to PCs, Servers, Hubs and Switches

1. Attach one end of a twisted-pair cable segment to the device's RJ-45 connector.

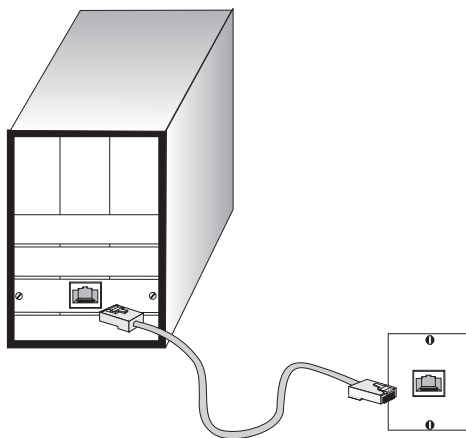

Figure 4-1 Making Twisted-Pair Connections

2. If the device is a PC card and the switch is in the wiring closet, attach the other end of the cable segment to a modular wall outlet that is connected to the wiring closet. (See “Network Wiring Connections” on page 2.) Otherwise, attach the other end to an available port on the switch.

Make sure each twisted pair cable does not exceed 100 meters (328 ft) in length.

3. As each connection is made, the Link LED (on the switch) corresponding to each port turns on to indicate that the connection is valid.

Network Wiring Connections

Today, the punch-down block is an integral part of many of the newer equipment racks. It is actually part of the patch panel. Instructions for making connections in the wiring closet with this type of equipment follows.

1. Attach one end of a patch cable to an available port on the switch, and the other end to the patch panel.
2. If not already in place, attach one end of a cable segment to the back of the patch panel where the punch-down block is located, and the other end to a modular wall outlet.
3. Label the cables to simplify future troubleshooting. See “Cable Labeling and Connection Records” on page 4-8.

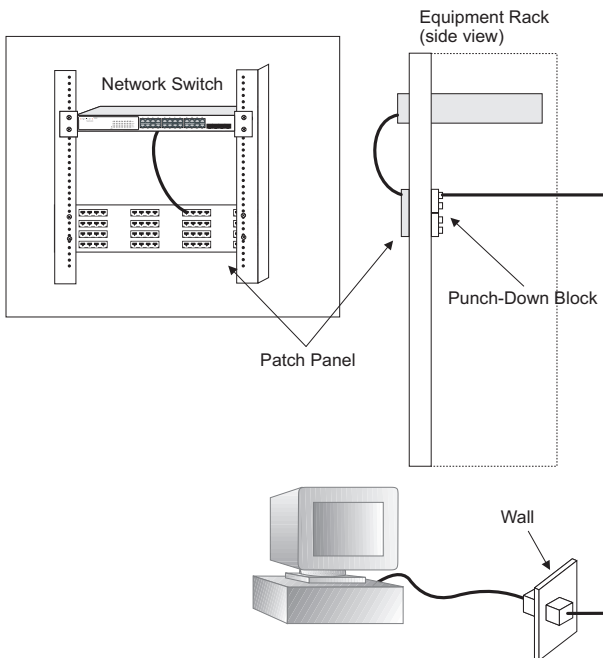

Figure 4-2 Wiring Closet Connections

Fiber Optic SFP Devices

An optional Gigabit SFP transceiver (1000BASE-SX, 1000BASE-LX or 1000BASE-LH) can be used for a backbone connection between switches, or for connecting to a high-speed server.

Each single-mode fiber port requires 9/125 micron single-mode fiber optic cable with an LC connector at both ends. Each multimode fiber optic port requires 50/125 or 62.5/125 micron multimode fiber optic cabling with an LC connector at both ends.

Warning: The switch use lasers to transmit signals over fiber optic cable. The lasers are compliant with the requirements of a Class 1 Laser Product and are inherently eye safe in normal operation. However, you should never look directly at a transmit port when it is powered on.

Note: When selecting a fiber SFP device, considering safety, please make sure that it can function at a temperature that is not less than the recommended maximum operational temperature of the product. You must also use an approved Laser Class 1 SFP transceiver.

Hinweis:Bei der Wahl eines Glasfasertransceivers muß für die Beurteilung der Gesamtsicherheit beachtet werden, das die maximale Umgebungstemperatur des Transceivers für den Betrieb nicht niedriger ist als die für dieses Produkts. Der Glasfasertransceiver muß auch ein überprüftes Gerät der Laser Klasse 1 sein.

1. Remove and keep the LC port's rubber cover. When not connected to a fiber cable, the rubber cover should be replaced to protect the optics.
2. Check that the fiber terminators are clean. You can clean the cable plugs by wiping them gently with a clean tissue or cotton ball moistened with a little ethanol. Dirty fiber terminators on fiber cables will impair the quality of the light transmitted through the cable and lead to degraded performance on the port.

3. Connect one end of the cable to the LC port on the switch and the other end to the LC port on the other device. Since LC connectors are keyed, the cable can be attached in only one orientation.

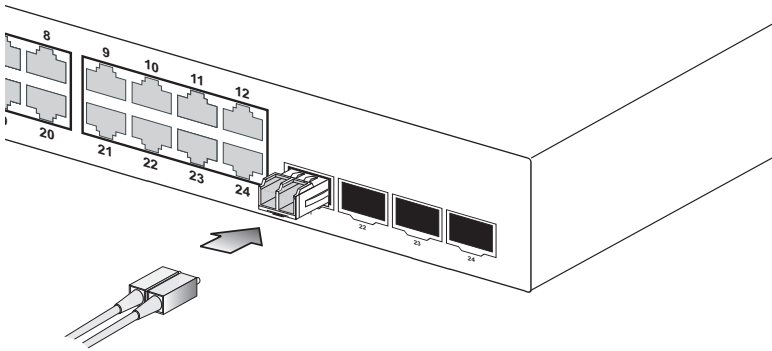

Figure 4-3 Making Connections to SFP Transceivers

4. As a connection is made, check the Link LED on the switch corresponding to the port to be sure that the connection is valid.

The 1000BASE-SX, 1000BASE-LX and 1000BASE-LH fiber optic ports operate at 1 Gbps full duplex. The maximum length for fiber optic cable operating at Gigabit speed will depend on the fiber type as listed under “1000 Mbps Gigabit Ethernet Collision Domain” on page 4-6.

Connectivity Rules

When adding hubs (repeaters) to your network, please follow the connectivity rules listed in the manuals for these products. However, note that because switches break up the path for connected devices into separate collision domains, you should not include the switch or connected cabling in your calculations for cascade length involving other devices.

1000BASE-T Cable Requirements

All Category 5 UTP cables that are used for 100BASE-TX connections should also work for 1000BASE-T, providing that all four wire pairs are connected. However, it is recommended that for all critical connections, or any new cable installations, Category 5e (enhanced Category 5) or Category 6 cable should be used. The Category 5e specification includes test parameters that are only recommendations for Category 5. Therefore, the first step in preparing existing Category 5 cabling for running 1000BASE-T is a simple test of the cable installation to be sure that it complies with the IEEE 802.3-2005 standards.

1000 Mbps Gigabit Ethernet Collision Domain

Table 4-1 Maximum 1000BASE-T Gigabit Ethernet Cable Length

Cable Type	Maximum Cable Length	Connector
Category 5, 5e, 6 100-ohm UTP or STP	100 m (328 ft)	RJ-45

Table 4-2 Maximum 1000BASE-SX Fiber Optic Cable Length

Fiber Diameter	Fiber Bandwidth	Cable Length Range	Connector
62.5/125 micron multimode fiber (MMF)	160 MHz/km	2-220 m (7-722 ft)	LC
	200 MHz/km	2-275 m (7-902 ft)	LC
50/125 micron multimode fiber (MMF)	400 MHz/km	2-500 m (7-1641 ft)	LC
	500 MHz/km	2-550 m (7-1805 ft)	LC

Table 4-3 Maximum 1000BASE-LX Fiber Optic Cable Length

Fiber Diameter	Fiber Bandwidth	Cable Length Range	Connector
9/125 micron single-mode fiber	N/A	2 m - 5 km (7 ft - 3.2 miles)	LC

Table 4-4 Maximum 1000BASE-LH Fiber Optic Cable Length

Fiber Diameter	Fiber Bandwidth	Cable Length Range	Connector
9/125 micron single-mode fiber	N/A	2 m - 70 km (7 feet - 43 miles)	LC

100 Mbps Fast Ethernet Collision Domain

Table 4-5 Maximum Fast Ethernet Cable Length

Type	Cable Type	Maximum Cable Length	Connector
100BASE-TX	Category 5 or better 100-ohm UTP or STP	100 m (328 ft)	RJ-45

10 Mbps Ethernet Collision Domain

Table 4-6 Maximum Ethernet Cable Length

Type	Cable Type	Maximum Length	Connector
10BASE-T	Categories 3, 4, 5 or better 100-ohm UTP	100 m (328 ft)	RJ-45

Cable Labeling and Connection Records

When planning a network installation, it is essential to label the opposing ends of cables and to record where each cable is connected. Doing so will enable you to easily locate inter-connected devices, isolate faults and change your topology without need for unnecessary time consumption.

To best manage the physical implementations of your network, follow these guidelines:

- Clearly label the opposing ends of each cable.
- Using your building's floor plans, draw a map of the location of all network-connected equipment. For each piece of equipment, identify the devices to which it is connected.
- Note the length of each cable and the maximum cable length supported by the switch ports.
- For ease of understanding, use a location-based key when assigning prefixes to your cable labeling.
- Use sequential numbers for cables that originate from the same equipment.
- Differentiate between racks by naming accordingly.
- Label each separate piece of equipment.
- Display a copy of your equipment map, including keys to all abbreviations at each equipment rack.

Appendix A: Troubleshooting

Diagnosing Switch Indicators

Table A-1 Troubleshooting Chart

Symptom	Action
Power LED is Off	<ul style="list-style-type: none">• Check connections between the switch, the power cord, and the wall outlet.• Contact your dealer for assistance.• Contact our Technical Support.
Link LED is Off	<ul style="list-style-type: none">• Verify that the switch and attached device are powered on.• Be sure the cable is plugged into both the switch and corresponding device.• If the switch is installed in a rack, check the connections to the punch-down block and patch panel.• Verify that the proper cable type is used and its length does not exceed specified limits.• Check the adapter on the attached device and cable connections for possible defects. Replace the defective adapter or cable if necessary.

Power and Cooling Problems

If the power indicator does not turn on when the power cord is plugged in, you may have a problem with the power outlet, power cord, or internal power supply. However, if the unit powers off after running for a while, check for loose power connections, power losses or surges at the power outlet, and verify that the fans on the unit are unobstructed and running prior to shutdown. If you still cannot isolate the problem, then the internal power supply may be defective.

Installation

Verify that all system components have been properly installed. If one or more components appear to be malfunctioning (such as the power cord or network cabling), test them in an alternate environment where you are sure that all the other components are functioning properly.

In-Band Access

You can access the management agent in the switch from anywhere within the attached network using a Web browser, or other network management software tools. However, you must first configure the switch with a valid IP address, subnet mask, and default gateway. If you have trouble establishing a link to the management agent, check to see if you have a valid network connection. Then verify that you entered the correct IP address. Also, be sure the port through which you are connecting to the switch has not been disabled. If it has not been disabled, then check the network cabling that runs between your remote location and the switch.

Appendix B: Cables

Twisted-Pair Cable and Pin Assignments

For 10BASE-T/100BASE-TX connections, a twisted-pair cable must have two pairs of wires. For 1000BASE-T connections the twisted-pair cable must have four pairs of wires. Each wire pair is identified by two different colors. For example, one wire might be green and the other, green with white stripes. Also, an RJ-45 connector must be attached to both ends of the cable.

Caution: Each wire pair must be attached to the RJ-45 connectors in a specific orientation.

Caution: DO NOT plug a phone jack connector into any RJ-45 port. Use only twisted-pair cables with RJ-45 connectors that conform with FCC standards.

Figure B-1 illustrates how the pins on the RJ-45 connector are numbered. Be sure to hold the connectors in the same orientation when attaching the wires to the pins.

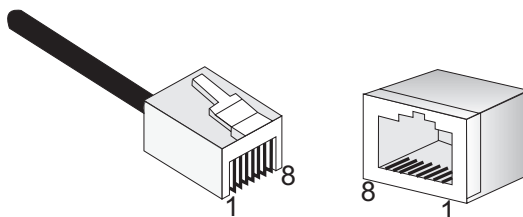

Figure B-1 RJ-45 Connector Pin Numbers

10BASE-T/100BASE-TX Pin Assignments

Use unshielded twisted-pair (UTP) or shielded twisted-pair (STP) cable for RJ-45 connections: 100-ohm Category 3 or better cable for 10 Mbps connections, or 100-ohm Category 5 or better cable for 100 Mbps connections. Also be sure that the length of any twisted-pair connection does not exceed 100 meters (328 feet).

The RJ-45 ports on the switch base unit support automatic MDI/MDI-X operation, so you can use straight-through cables for all network connections to PCs or servers, or to other switches or hubs. In straight-through cable, pins 1, 2, 3, and 6, at one end of the cable, are connected straight through to pins 1, 2, 3, and 6 at the other end of the cable. When using any RJ-45 port on the switch, you can use either straight-through or crossover cable.

Table B-1 10/100BASE-TX MDI and MDI-X Port Pinouts

Pin	MDI Signal Name	MDI-X Signal Name
1	Transmit Data plus (TD+)	Receive Data plus (RD+)
2	Transmit Data minus (TD-)	Receive Data minus (RD-)
3	Receive Data plus (RD+)	Transmit Data plus (TD+)
6	Receive Data minus (RD-)	Transmit Data minus (TD-)
4,5,7,8	Not used	Not used

Note: The "+" and "-" signs represent the polarity of the wires that make up each wire pair.

Straight-Through Wiring

If the twisted-pair cable is to join two ports and only one of the ports has an internal crossover (MDI-X), the two pairs of wires must be straight-through. (When auto-negotiation is enabled for any RJ-45 port on the switch, you can use either straight-through or crossover cable to connect to any device type.)

You must connect all four wire pairs as shown in the following diagram to support Gigabit Ethernet connections.

EIA/TIA 568B RJ-45 Wiring Standard
10/100BASE-TX Straight-through Cable

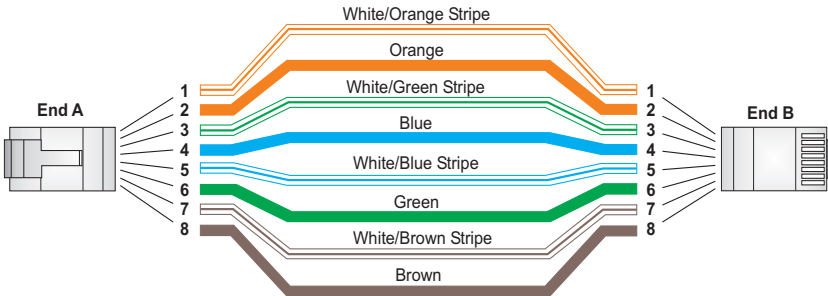

Figure B-2 Straight-through Wiring

Crossover Wiring

If the twisted-pair cable is to join two ports and either both ports are labeled with an “X” (indicating MDI-X) or neither port is labeled with an “X” (which indicates MDI), a crossover must be implemented in the wiring. (When auto-negotiation is enabled for any RJ-45 port on the switch, you can use either straight-through or crossover cable to connect to any device type.)

You must connect all four wire pairs as shown in the following diagram to support Gigabit Ethernet connections.

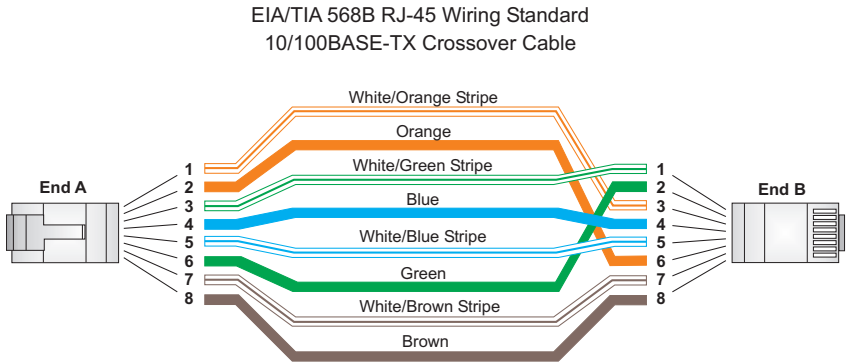

Figure B-3 Crossover Wiring

1000BASE-T Pin Assignments

All 1000BASE-T ports support automatic MDI/MDI-X operation, so you can use straight-through cables for all network connections to PCs or servers, or to other switches or hubs.

The table below shows the 1000BASE-T MDI and MDI-X port pinouts. These ports require that all four pairs of wires be connected. Note that for 1000BASE-T operation, all four pairs of wires are used for both transmit and receive.

Use 100-ohm Category 5, 5e or 6 unshielded twisted-pair (UTP) or shielded twisted-pair (STP) cable for 1000BASE-T connections. Also be sure that the length of any twisted-pair connection does not exceed 100 meters (328 feet).

Table B-2 1000BASE-T MDI and MDI-X Port Pinouts

Pin	MDI Signal Name	MDI-X Signal Name
1	Bi-directional Data One Plus (BI_D1+)	Bi-directional Data Two Plus (BI_D2+)
2	Bi-directional Data One Minus (BI_D1-)	Bi-directional Data Two Minus (BI_D2-)
3	Bi-directional Data Two Plus (BI_D2+)	Bi-directional Data One Plus (BI_D1+)

Table B-2 1000BASE-T MDI and MDI-X Port Pinouts

Pin	MDI Signal Name	MDI-X Signal Name
4	Bi-directional Data Three Plus (BI_D3+)	Bi-directional Data Four Plus (BI_D4+)
5	Bi-directional Data Three Minus (BI_D3-)	Bi-directional Data Four Minus (BI_D4-)
6	Bi-directional Data Two Minus (BI_D2-)	Bi-directional Data One Minus (BI_D1-)
7	Bi-directional Data Four Plus (BI_D4+)	Bi-directional Data Three Plus (BI_D3+)
8	Bi-directional Data Four Minus (BI_D4-)	Bi-directional Data Three Minus (BI_D3-)

Cable Testing for Existing Category 5 Cable

Installed Category 5 cabling must pass tests for Attenuation, Near-End Crosstalk (NEXT), and Far-End Crosstalk (FEXT). This cable testing information is specified in the ANSI/TIA/EIA-TSB-67 standard. Additionally, cables must also pass test parameters for Return Loss and Equal-Level Far-End Crosstalk (ELFEXT). These tests are specified in the ANSI/TIA/EIA-TSB-95 Bulletin, "The Additional Transmission Performance Guidelines for 100 Ohm 4-Pair Category 5 Cabling."

Note that when testing your cable installation, be sure to include all patch cables between switches and end devices.

Adjusting Existing Category 5 Cabling to Run 1000BASE-T

If your existing Category 5 installation does not meet one of the test parameters for 1000BASE-T, there are basically three measures that can be applied to try and correct the problem:

1. Replace any Category 5 patch cables with high-performance Category 5e or Category 6 cables.
2. Reduce the number of connectors used in the link.
3. Reconnect some of the connectors in the link.

Fiber Standards

The current TIA (Telecommunications Industry Association) 568-A specification on optical fiber cabling consists of one recognized cable type for horizontal subsystems and two cable types for backbone subsystems.

Horizontal 62.5/125 micron multimode (two fibers per outlet).

Backbone 62.5/125 micron multimode or single mode.

TIA 568-B will allow the use of 50/125 micron multimode optical fiber in both the horizontal and backbone in addition to the types listed above. All optical fiber components and installation practices must meet applicable building and safety codes.

Appendix C: Specifications

Physical Characteristics

Ports

- 20 10/100/1000BASE-T, with auto-negotiation
- 4 10/100/1000BASE-T shared with 4 SFP transceiver slots.

Network Interface

- Ports 1-24: RJ-45 connector, auto MDI/X
 - 10BASE-T: RJ-45 (100-ohm, UTP cable; Category 3 or better)
 - 100BASE-TX: RJ-45 (100-ohm, UTP cable; Category 5 or better)
 - 1000BASE-T: RJ-45 (100-ohm, UTP or STP cable; Category 5, 5e, or 6)
- *Maximum Cable Length - 100 m (328 ft)

Buffer Architecture

- 400 Kbytes

Aggregate Bandwidth

- 48 Gbps

Switching Database

- 8K MAC address entries, 1K static MAC addresses;

LEDs

- System: Power
- Port: Link/Act, 1000

Weight

- 3.72 kg (8.44 lbs)

Size

- 44.0 x 17.1 x 4.3 cm (17.0 x 6.7 x 1.7 in.)

Temperature

- Operating: 0 to 40 °C (32 to 104 °F)
- Storage: -40 to 70 °C (-40 to 158 °F)

Humidity

- Operating: 10% to 90% (non-condensing)



Specifications

AC Input

100 to 240 V, 50-60 Hz, 0.8 A

Power Supply

Internal, auto-ranging transformer: 100 to 240 VAC, 50 to 60 Hz

Power Consumption

28 Watts maximum

Maximum Current

0.25 A @ 115 VAC

0.12 A @ 230 VAC

Switch Features

Forwarding Mode

Store-and-forward

Throughput

Wire speed

Management Features

In-Band Management

Web, SNMP manager

Software Loading

HTTP in-band

Standards

IEEE 802.3-2005

Ethernet, Fast Ethernet, Gigabit Ethernet

IEEE 802.1D Spanning Tree Protocol

IEEE 802.1Q Virtual LAN

IEEE 802.1X, Port-Based Network Access Control, 2001

ISO/IEC 8802-3

Compliances

CE Mark

Emissions

FCC Class A

VCCI Class A

Immunity

EN 61000-4-2/3/4/5/6/8/11

Safety

CSA 22.2.60950-1 & UL 60950-1

IEC 60950-1/ EN60950-1

Glossary

10BASE-T

IEEE 802.3 specification for 10 Mbps Ethernet over two pairs of Category 3 or better UTP cable.

100BASE-TX

IEEE 802.3u specification for 100 Mbps Fast Ethernet over two pairs of Category 5 or better UTP cable.

1000BASE-LH

Specification for long-haul Gigabit Ethernet over two strands of 9/125 micron core fiber cable.

1000BASE-LX

IEEE 802.3z specification for Gigabit Ethernet over two strands of 50/125, 62.5/125 or 9/125 micron core fiber cable.

1000BASE-SX

IEEE 802.3z specification for Gigabit Ethernet over two strands of 50/125 or 62.5/125 micron core fiber cable.

1000BASE-T

IEEE 802.3ab specification for Gigabit Ethernet over 100-ohm Category 5 or 5e twisted-pair cable (using all four wire pairs).

Auto-Negotiation

Signalling method allowing each node to select its optimum operational mode (e.g., speed and duplex mode) based on the capabilities of the node to which it is connected.

Bandwidth

The difference between the highest and lowest frequencies available for network signals. Also synonymous with wire speed, the actual speed of the data transmission along the cable.

Collision

A condition in which packets transmitted over the cable interfere with each other. Their interference makes both signals unintelligible.

Collision Domain

Single CSMA/CD LAN segment.

CSMA/CD

CSMA/CD (Carrier Sense Multiple Access/Collision Detect) is the communication method employed by Ethernet, Fast Ethernet, or Gigabit Ethernet.

End Station

A workstation, server, or other device that does not forward traffic.

Ethernet

A network communication system developed and standardized by DEC, Intel, and Xerox, using baseband transmission, CSMA/CD access, logical bus topology, and coaxial cable. The successor IEEE 802.3 standard provides for integration into the OSI model and extends the physical layer and media with repeaters and implementations that operate on fiber, thin coax and twisted-pair cable.

Fast Ethernet

A 100 Mbps network communication system based on Ethernet and the CSMA/CD access method.

Full Duplex

Transmission method that allows two network devices to transmit and receive concurrently, effectively doubling the bandwidth of that link.

Gigabit Ethernet

A 1000 Mbps network communication system based on Ethernet and the CSMA/CD access method.

IEEE

Institute of Electrical and Electronic Engineers.

IEEE 802.3

Defines carrier sense multiple access with collision detection (CSMA/CD) access method and physical layer specifications.

IEEE 802.3ab

Defines CSMA/CD access method and physical layer specifications for 100BASE-T Gigabit Ethernet. (Now incorporated in IEEE 802.3-2005.)

IEEE 802.3u

Defines CSMA/CD access method and physical layer specifications for 100BASE-TX Fast Ethernet. (Now incorporated in IEEE 802.3-2005.)

IEEE 802.3x

Defines Ethernet frame start and stop requests and timers used for flow control on full-duplex links. (Now incorporated in IEEE 802.3-2005.)

IEEE 802.3z

Defines CSMA/CD access method and physical layer specifications for 1000BASE Gigabit Ethernet. (Now incorporated in IEEE 802.3-2005.)

LAN Segment

Separate LAN or collision domain.

Layer 2

Data Link layer in the ISO 7-Layer Data Communications Protocol. This is related directly to the hardware interface for network devices and passes on traffic based on MAC addresses.

LED

Light emitting diode used for monitoring a device or network condition.

Link Segment

Length of twisted-pair or fiber cable joining a pair of repeaters or a repeater and a PC.

Local Area Network (LAN)

A group of interconnected computers and support devices.

Management Information Base (MIB)

An acronym for Management Information Base. It is a set of database objects that contains information about the device.

Media Access Control (MAC)

A portion of the networking protocol that governs access to the transmission medium, facilitating the exchange of data between network nodes.

Modal Bandwidth

Bandwidth for multimode fiber is referred to as modal bandwidth because it varies with the modal field (or core diameter) of the fiber. Modal bandwidth is specified in units of MHz per km, which indicates the amount of bandwidth supported by the fiber for a one km distance.

Network Diameter

Wire distance between two end stations in the same collision domain.

Redundant Power Supply (RPS)

A backup power supply unit that automatically takes over in case the primary power supply should fail.

RJ-45 Connector

A connector for twisted-pair wiring.

Switched Ports

Ports that are on separate collision domains or LAN segments.

TIA

Telecommunications Industry Association

Transmission Control Protocol/Internet Protocol (TCP/IP)

Protocol suite that includes TCP as the primary transport protocol, and IP as the network layer protocol.

UTP

Unshielded twisted-pair cable.

Virtual LAN (VLAN)

A Virtual LAN is a collection of network nodes that share the same collision domain regardless of their physical location or connection point in the network. A VLAN serves as a logical workgroup with no physical barriers, allowing users to share information and resources as though located on the same LAN.

Index

Numerics

- 10 Mbps connectivity rules 4-7
- 100 Mbps connectivity rules 4-7
- 1000 Mbps connectivity rules 4-6
- 1000BASE-LX fiber cable lengths 4-6
- 1000BASE-SX fiber cable lengths 4-6
- 1000BASE-T
 - pin assignments B-3
 - ports 1-2
- 1000BASE-ZX fiber cable lengths 4-6
- 100BASE-TX
 - cable lengths 4-7
 - ports 1-2
- 10BASE-T ports 1-2
- 10BASE-T/100BASE-TX pin assignments B-1

A

- adhesive feet, attaching 3-4
- air flow requirements 3-1
- applications
 - collapsed backbone 2-2
 - remote connections 2-3
 - VLAN connections 2-3, 2-5

B

- brackets, attaching 3-3
- buffer size C-1

C

- cable
 - Ethernet cable compatibility 3-1
 - labeling and connection records 4-8
 - lengths 4-7
- cleaning fiber terminators 4-4
- compliances
 - EMC C-3
 - safety C-3
- connectivity rules
 - 10 Mbps 4-7
 - 100 Mbps 4-7
 - 1000 Mbps 4-6
- contents of package 3-2

- cooling problems A-1
- cord sets, international 3-6

D

- desktop mounting 3-4
- device connections 4-1

E

- electrical interference, avoiding 3-1
- equipment checklist 3-2
- Ethernet connectivity rules 4-6, 4-7

F

- Fast Ethernet connectivity rules 4-7
- features C-2
 - management 1-5
- full-duplex connectivity 2-1

G

- grounding for racks 3-3

I

- IEEE 802.3 Ethernet 1-4
- IEEE 802.3ae 10 Gigabit Ethernet 1-4
- IEEE 802.3u Fast Ethernet 1-4
- IEEE 802.3z Gigabit Ethernet 1-4
- indicators, LED 1-3
- installation
 - connecting devices to the switch 4-2
 - desktop or shelf mounting 3-4
 - port connections 4-1
 - power requirements 3-1
 - problems A-2
 - rack mounting 3-3
 - site requirements 3-1
 - wiring closet connections 4-7

L

- laser safety 4-4
- LC port connections 4-4
- LED indicators
 - Power 1-3
- problems A-1

location requirements 3-1

M

management

agent 1-2

features 1-5, C-2, C-3

SNMP 1-2

mounting the switch

in a rack 3-3

on a desktop or shelf 3-4

N

network

connections 4-1

examples 2-2

P

package contents 3-2

pin assignments B-1

1000BASE-T B-3

100BASE-TX/10BASE-T B-1

ports, connecting to 4-1

power, connecting to 3-6

problems, troubleshooting A-1

R

rack mounting 3-3

rear panel receptacles 1-4

RJ-45 port 1-2

connections 4-1

pinouts B-3

rubber foot pads, attaching 3-4

S

screws for rack mounting 3-2

site selection 3-1

SNMP agent 1-2

specifications

compliances C-2, C-3

environmental C-1

physical C-1

power C-2

standards

compliance C-3

IEEE C-2

status LEDs 1-3

surge suppressor, using 3-1

switch architecture 1-2

switching, introduction to 2-1

T

temperature within a rack 3-3

troubleshooting

in-band access A-2

power and cooling problems A-1

switch indicators A-1

twisted-pair connections 4-1

V

VLANs

tagging 2-5

ES4324
E092007-AP-R01
150200057600A

Free Manuals Download Website

<http://myh66.com>

<http://usermanuals.us>

<http://www.somanuals.com>

<http://www.4manuals.cc>

<http://www.manual-lib.com>

<http://www.404manual.com>

<http://www.luxmanual.com>

<http://aubethermostatmanual.com>

Golf course search by state

<http://golfingnear.com>

Email search by domain

<http://emailbydomain.com>

Auto manuals search

<http://auto.somanuals.com>

TV manuals search

<http://tv.somanuals.com>