

Accton

Making Partnership Work

VDSL Switch-VS2512A

VDSL Splitter-VM2524

VDSL Splitter-VM2548

Installation Guide



Installation Guide

VDSL Switch-VS2512A

VDSL Switch supporting 12 VDSL Lines, with 1 Slot for Optional Gigabit Uplink, 10/100BASE-TX, or 100BASE-FX Modules

VDSL Splitter-VM2524

VDSL Splitter supporting 24 VDSL Lines

VDSL Splitter-VM2548

VDSL Splitter supporting 48 VDSL Lines



Copyright © 2002 by Accton Technology Corporation. All rights reserved.

No part of this document may be copied or reproduced in any form or by any means without the prior written consent of Accton Technology Corporation.

Accton makes no warranties with respect to this documentation and disclaims any implied warranties of merchantability, quality, or fitness for any particular purpose. The information in this document is subject to change without notice. Accton reserves the right to make revisions to this publication without obligation to notify any person or entity of any such changes.

Accton

International Headquarters

No. 1 Creation Road III,
Science-based Industrial Park
Hsinchu 300, Taiwan
Phone: +886-3-5770-270
Fax: +886-3-5770-267
Internet: support@accton.com.tw

Asia Pacific Headquarters

1 Claymore Drive
#08-05/06 Orchard Towers (Rear Block)
Singapore 229594
Phone: +65 238 6556
Fax: +65 238 6466
Internet: www.acctontech.com

Europe Headquarters

Edificio Conata II,
Calle Fructuós Gelabert 6-8, 2^a, 4^a,
08970 - Sant Joan Despi,
Barcelona, Spain.
Phone: +34-93-477-4920
Fax: +34-93-477-3774

Accton is a trademark of Accton Technology Corporation. Other trademarks or brand names mentioned herein are trademarks or registered trademarks of their respective companies.

VS2512A
VM2524
VM2548
E072002-R01
150000010100A

Accton Technology Corporation

Limited Warranty: Accton warrants all its products to be free of manufacturing defects in workmanship and materials, under normal use and service, for the applicable warranty term. All Accton products carry a standard 90-day limited warranty from the date of purchase from Accton or its Authorized Reseller. Accton may, at its own discretion, repair or replace any product not operating as warranted with a similar or functionally equivalent product, during the applicable warranty term.

The standard limited warranty can be upgraded to a Limited Lifetime* warranty by registering new products within 30 days of purchase from Accton or its Authorized Reseller. Registration can be accomplished via the enclosed product registration card or online via the Accton web site. Failure to register will not affect the standard limited warranty. The Limited Lifetime warranty covers a product during the Life of that Product, which is defined as the period of time during which the product is an "Active" Accton product. A product is considered to be "Active" while it is listed on the current Accton price list. As new technologies emerge, older technologies become obsolete and Accton will, at its discretion, replace an older product in its product line with one that incorporates these newer technologies. At that point, the obsolete product is discontinued and is no longer an "Active" Accton product. A list of discontinued products is attached with the most recent version being available on the support section of our web site (<http://www.acctontech.com>).

All products that are replaced become the property of Accton. Replacement products may be either new or reconditioned. Any replaced or repaired product carries either a 30-day limited warranty or the remainder of the initial warranty, whichever is longer. Accton is not responsible for any custom software or firmware, configuration information, or memory data of Customer contained in, stored on, or integrated with any products returned to Accton pursuant to any warranty. Products returned to Accton should have any customer-installed accessory or add-on components, such as expansion modules, removed prior to returning the product for replacement. Accton is not responsible for these items if they are returned with the product.

Customers must contact Accton for a Return Material Authorization number prior to returning any product to Accton. Proof of purchase may be required. Any product returned to Accton without a valid Return Material Authorization (RMA) number clearly marked on the outside of the package will be returned to customer at customer's expense. Customers are responsible for all shipping charges from their facility to Accton. Accton is responsible for return shipping charges from Accton to customer.

Limited Warranty

WARRANTIES EXCLUSIVE: IF AN ACCTON PRODUCT DOES NOT OPERATE AS WARRANTED ABOVE, CUSTOMER'S SOLE REMEDY SHALL BE REPAIR OR REPLACEMENT OF THE PRODUCT IN QUESTION, AT ACCTON'S OPTION. THE FOREGOING WARRANTIES AND REMEDIES ARE EXCLUSIVE AND ARE IN LIEU OF ALL OTHER WARRANTIES OR CONDITIONS, EXPRESS OR IMPLIED, EITHER IN FACT OR BY OPERATION OF LAW, STATUTORY OR OTHERWISE, INCLUDING WARRANTIES OR CONDITIONS OF MERCHANTABILITY AND FITNESS FOR A PARTICULAR PURPOSE. ACCTON NEITHER ASSUMES NOR AUTHORIZES ANY OTHER PERSON TO ASSUME FOR IT ANY OTHER LIABILITY IN CONNECTION WITH THE SALE, INSTALLATION, MAINTENANCE OR USE OF ITS PRODUCTS. ACCTON SHALL NOT BE LIABLE UNDER THIS WARRANTY IF ITS TESTING AND EXAMINATION DISCLOSE THE ALLEGED DEFECT IN THE PRODUCT DOES NOT EXIST OR WAS CAUSED BY CUSTOMER'S OR ANY THIRD PERSON'S MISUSE, NEGLIGENCE, IMPROPER INSTALLATION OR TESTING, UNAUTHORIZED ATTEMPTS TO REPAIR, OR ANY OTHER CAUSE BEYOND THE RANGE OF THE INTENDED USE, OR BY ACCIDENT, FIRE, LIGHTNING, OR OTHER HAZARD.

LIMITATION OF LIABILITY: IN NO EVENT, WHETHER BASED IN CONTRACT OR TORT (INCLUDING NEGLIGENCE), SHALL ACCTON BE LIABLE FOR INCIDENTAL, CONSEQUENTIAL, INDIRECT, SPECIAL, OR PUNITIVE DAMAGES OF ANY KIND, OR FOR LOSS OF REVENUE, LOSS OF BUSINESS, OR OTHER FINANCIAL LOSS ARISING OUT OF OR IN CONNECTION WITH THE SALE, INSTALLATION, MAINTENANCE, USE, PERFORMANCE, FAILURE, OR INTERRUPTION OF ITS PRODUCTS, EVEN IF ACCTON OR ITS AUTHORIZED RESELLER HAS BEEN ADVISED OF THE POSSIBILITY OF SUCH DAMAGES.

SOME COUNTRIES DO NOT ALLOW THE EXCLUSION OF IMPLIED WARRANTIES OR THE LIMITATION OF INCIDENTAL OR CONSEQUENTIAL DAMAGES FOR CONSUMER PRODUCTS, SO THE ABOVE LIMITATIONS AND EXCLUSIONS MAY NOT APPLY TO YOU. THIS WARRANTY GIVES YOU SPECIFIC LEGAL RIGHTS, WHICH MAY VARY FROM STATE TO STATE. NOTHING IN THIS WARRANTY SHALL BE TAKEN TO AFFECT YOUR STATUTORY RIGHTS.

* Accton will provide warranty service for up to three years following discontinuance from the active Accton price list. Under the limited lifetime warranty, internal and external power supplies, fans, and cables are covered by a standard one-year warranty from date of purchase

Compliances

FCC - Class A

This equipment generates, uses, and can radiate radio frequency energy and, if not installed and used in accordance with the instruction manual, may cause interference to radio communications. It has been tested and found to comply with the limits for a Class A computing device pursuant to Subpart B of Part 15 of FCC Rules, which are designed to provide reasonable protection against such interference when operated in a commercial environment. Operation of this equipment in a residential area is likely to cause interference, in which case the user, at his own expense, will be required to take whatever measures may be required to correct the interference. You are cautioned that changes or modifications not expressly approved by the party responsible for compliance could void your authority to operate the equipment.

You may use unshielded twisted-pair (UTP) for RJ-45 connections - Category 3 or greater for 10 Mbps connections, and Category 5 for 100 Mbps connections. For fiber optic connections, you may use 50/125 or 62.5/125 micron multimode fiber or 9/125 micron single-mode fiber.

- Warnings:**
1. Wear an anti-static wrist strap or take other suitable measures to prevent electrostatic discharge when handling this equipment.
 2. When connecting this hub to a power outlet, connect the field ground lead on the tri-pole power plug to a valid earth ground line to prevent electrical hazards.

Industry Canada - Class A

This digital apparatus does not exceed the Class A limits for radio noise emissions from digital apparatus as set out in the interference-causing equipment standard entitled "Digital Apparatus," ICES-003 of the Department of Communications.

Cet appareil numérique respecte les limites de bruits radioélectriques applicables aux appareils numériques de Classe A prescrites dans la norme sur le matériel brouilleur: "Appareils Numériques," NMB-003 édictée par le ministère des Communications.

Japan VCCI Class A

この装置は、情報処理装置等電波障害自主規制協議会（VCCI）の基準に基づくクラスA情報技術装置です。この装置を家庭環境で使用すると電波妨害を引き起こすことがあります。この場合には使用者が適切な対策を講ずるよう要求されることがあります。

CE Mark Declaration of Conformance for EMI and Safety (EEC)

This information technology equipment complies with the requirements of the Council Directive 89/336/EEC on the Approximation of the laws of the Member States relating to Electromagnetic Compatibility and 73/23/EEC for electrical equipment used within certain voltage limits and the Amendment Directive 93/68/EEC. For the evaluation of the compliance with these Directives, the following standards were applied:

- RFI Emission:
- Limit class A according to EN 55022:1998
 - Limit class A for harmonic current emission according to EN 61000-3-2/1995
 - Limitation of voltage fluctuation and flicker in low-voltage supply system according to EN 61000-3-3/1995
- Immunity:
- Product family standard according to EN 55024:1998
 - Electrostatic Discharge according to EN 61000-4-2:1995 (Contact Discharge: ± 4 kV, Air Discharge: ± 8 kV)
 - Radio-frequency electromagnetic field according to EN 61000-4-3:1996 (80 - 1000 MHz with 1 kHz AM 80% Modulation: 3 V/m)
 - Electrical fast transient/burst according to EN 61000-4-4:1995 (AC/DC power supply: ± 1 kV, Data/Signal lines: ± 0.5 kV)
 - Surge immunity test according to EN 61000-4-5:1995 (AC/DC Line to Line: ± 1 kV, AC/DC Line to Earth: ± 2 kV)
 - Immunity to conducted disturbances, Induced by radio-frequency fields: EN 61000-4-6:1996 (0.15 - 80 MHz with 1 kHz AM 80% Modulation: 3 V/m)
 - Power frequency magnetic field immunity test according to EN 61000-4-8:1993 (1 A/m at frequency 50 Hz)
 - Voltage dips, short interruptions and voltage variations immunity test according to EN 61000-4-11:1994 (>95% Reduction @10 ms, 30% Reduction @500 ms, >95% Reduction @5000 ms)
- LVD:
- EN 60950 (A1/1992; A2/1993; A3/1993; A4/1995; A11/1997)

Warning! Do not plug a phone jack connector in the RJ-45 port. This may damage this device. Les raccordeurs ne sont pas utilisés pour le système téléphonique!

Taiwan BSMI Class A

警告使用者：這是甲類的資訊產品，在居住的環境中使用時，可能會造成射頻干擾，在這種情況下，使用者會被要求採取某些適當的對策。

Safety Compliance

Warning: Fiber Optic Port Safety



When using a fiber optic port, never look at the transmit laser while it is powered on. Also, never look directly at the fiber TX port and fiber cable ends when they are powered on.

Avertissement: Ports pour fibres optiques - sécurité sur le plan optique



Ne regardez jamais le laser tant qu'il est sous tension. Ne regardez jamais directement le port TX (Transmission) à fibres optiques et les embouts de câbles à fibres optiques tant qu'ils sont sous tension.

Warnhinweis: Faseroptikanschlüsse - Optische Sicherheit



Niemals ein Übertragungslaser betrachten, während dieses eingeschaltet ist. Niemals direkt auf den Faser-TX-Anschluß und auf die Faserkabelenden schauen, während diese eingeschaltet sind.

Underwriters Laboratories Compliance Statement

Important! Before making connections, make sure you have the correct cord set. Check it (read the label on the cable) against the following:

Operating Voltage	Cord Set Specifications
120 Volts	UL Listed/CSA Certified Cord Set
	Minimum 18 AWG
	Type SVT or SJT three conductor cord
	Maximum length of 15 feet
	Parallel blade, grounding type attachment plug rated 15 A, 125 V
240 Volts (Europe only)	Cord Set with H05VV-F cord having three conductors with minimum diameter of 0.75 mm ²
	IEC-320 receptacle
	Male plug rated 10 A, 250 V

The unit automatically matches the connected input voltage. Therefore, no additional adjustments are necessary when connecting it to any input voltage within the range marked on the rear panel.

Wichtige Sicherheitshinweise (Germany)

1. Bitte lesen Sie diese Hinweise sorgfältig durch.
2. Heben Sie diese Anleitung für den späteren Gebrauch auf.
3. Vor jedem Reinigen ist das Gerät vom Stromnetz zu trennen. Verwenden Sie keine Flüssigoder Aerosolreiniger. Am besten eignet sich ein angefeuchtetes Tuch zur Reinigung.
4. Die Netzanschlußsteckdose soll nahe dem Gerät angebracht und leicht zugänglich sein.
5. Das Gerät ist vor Feuchtigkeit zu schützen.
6. Bei der Aufstellung des Gerätes ist auf sicheren Stand zu achten. Ein Kippen oder Fallen könnte Beschädigungen hervorrufen.
7. Die Belüftungsöffnungen dienen der Luftzirkulation, die das Gerät vor Überhitzung schützt. Sorgen Sie dafür, daß diese Öffnungen nicht abgedeckt werden.
8. Beachten Sie beim Anschluß an das Stromnetz die Anschlußwerte.
9. Verlegen Sie die Netzanschlußleitung so, daß niemand darüber fallen kann. Es sollte auch nichts auf der Leitung abgestellt werden.
10. Alle Hinweise und Warnungen, die sich am Gerät befinden, sind zu beachten.
11. Wird das Gerät über einen längeren Zeitraum nicht benutzt, sollten Sie es vom Stromnetz trennen. Somit wird im Falle einer Überspannung eine Beschädigung vermieden.
12. Durch die Lüftungsöffnungen dürfen niemals Gegenstände oder Flüssigkeiten in das Gerät gelangen. Dies könnte einen Brand bzw. elektrischen Schlag auslösen.
13. Öffnen sie niemals das Gerät. Das Gerät darf aus Gründen der elektrischen Sicherheit nur von autorisiertem Servicepersonal geöffnet werden.
14. Wenn folgende Situationen auftreten ist das Gerät vom Stromnetz zu trennen und von einer qualifizierten Servicestelle zu überprüfen:
 - a. Netzkabel oder Netzstecker sind beschädigt.
 - b. Flüssigkeit ist in das Gerät eingedrungen.
 - c. Das Gerät war Feuchtigkeit ausgesetzt.
 - d. Wenn das Gerät nicht der Bedienungsanleitung entsprechend funktioniert oder Sie mit Hilfe dieser Anleitung keine Verbesserung erzielen.
 - e. Das Gerät ist gefallen und/oder das Gehäuse ist beschädigt.
 - f. Wenn das Gerät deutliche Anzeichen eines Defektes aufweist.
15. Zum Netzanschluß dieses Gerätes ist eine geprüfte Leitung zu verwenden. Für einen Nennstrom bis 6A und einem Gerätegewicht größer 3 kg ist eine Leitung nicht leichter als H05VV-F, 3G, 0.75 mm² einzusetzen.

Der arbeitsplatzbezogene Schalldruckpegel nach DIN 45 635 Teil 1000 beträgt 70 dB(A) oder weniger.

Contents

Chapter 1: About the VDSL Switch-VS2512A	1-1
Overview	1-1
VDSL Technology	1-2
Switch Architecture	1-3
Management Options	1-3
Description of Hardware	1-4
VDSL Switch-VS2512A	1-4
VDSL Splitter-VM2524 and VDSL Splitter-VM2548	1-5
Ethernet-over-VDSL CPE	1-6
Status LEDs	1-7
Optional Media Extender Modules	1-8
Power Supply Receptacle	1-11
Key Features	1-12
Chapter 2: Network Planning	2-1
Introduction to Switching	2-1
Sample Applications	2-1
Internet Connections	2-2
Remote Connections with Fiber Cable	2-2
Making VLAN Connections	2-3
Application Notes	2-4
Chapter 3: Installing the VDSL Switch and Splitter	3-1
Preparing the Site	3-1
Installing Additional Phone Line Equipment	3-1
Equipment Checklist	3-1
Package Contents	3-2
VDSL Switch-VS2512A	3-2
Optional Rack-Mounting Equipment	3-2
Mounting	3-2
Desktop or Shelf Mounting	3-4
Installing an Optional Module into the Switch	3-5
Installing a GBIC Transceiver	3-6
Connecting to the Stack's Backplane	3-7
Powering On the Switch	3-7
Chapter 4: Making Network Connections	4-1
Twisted-Pair Devices	4-1
Cabling Guidelines	4-1
Connecting to the Punch-down Blocks	4-1
Wiring Closet Connections	4-2
Fiber Optic Devices	4-3

Appendix A: Troubleshooting	A-1
Diagnosing Switch Indicators	A-1
Power and Cooling Problems	A-1
Installation	A-2
In-Band Access	A-2
Appendix B: Cables	B-1
Specifications.	B-1
Twisted-Pair Cable and Pin Assignments	B-1
10BASE-T/100BASE-TX Pin Assignments	B-2
1000BASE-T Pin Assignments	B-3
1000BASE-T Cable Requirements	B-3
Cable Testing for Existing Category 5 Cable	B-3
Adjusting Existing Category 5 Cabling to Run 1000BASE-T	B-4
RJ-21 Port Pin Assignments	B-4
Console Port Pin Assignments	B-5
DB-9 Port Pin Assignments	B-5
Console Port to 9-Pin DTE Port on PC	B-5
Console to 25-Pin DTE Port on PC	B-5
Appendix C: Specifications	C-1
VDSL Switch	C-1
Physical Characteristics	C-1
Switch Features	C-2
Management Features	C-3
Standards	C-3
Compliances	C-3
Warranty	C-4
VDSL Splitter	C-4
Slide-in Modules	C-5
1000BASE-SX Extender Module	C-5
1000BASE-LX Extender Module	C-5
1000BASE-T Extender Module	C-6
100BASE-FX Extender Modules	C-6
10/100BASE-TX Extender Modules	C-7
1000BASE-X GBIC Module	C-7
Appendix D: Ordering Information	D-1
Glossary	
Index	

Chapter 1: About the VDSL Switch-VS2512A

Overview

Accton's Ethernet-over-VDSL system consists of end-user CPEs (Customer Premise Equipment) connected to a VDSL switch and splitter by standard telephone cable. The VDSL connection delivers an Ethernet data link rated up to 15 Mbps symmetric (full duplex), while simultaneously supporting standard telephone services. The system can be deployed in any multi-dwelling/multi-tenant environment (apartment blocks, hotels, or office complex) to provide both high-speed Internet access and telephone services without any need for re-wiring.

Accton's VDSL Switch-VS2512A and VDSL-Splitter-VM2524/VM2548 combine both the data and phone signals coming from your Internet and telephone service providers, and pass these signals directly over standard telephone wiring to multiple users in the same building. A CPE is then used to separate these signals and pass them on to a customer's computer and telephone equipment. In-building connections can operate up to 15 Mbps for runs up to 1070 m (3500 ft), 10 Mbps for runs up to 1220 m (4000 ft), 5 Mbps for runs up to 1525 m (5000 ft).

Note: Category 3 cable must be installed to achieve the maximum distance, but the distance may be limited by factors such as how the cable is bundled, and the interference and noise on the link.

The VDSL switch and splitter are typically located in a wiring closet or other central location of a multi-dwelling/multi-tenant unit, campus or enterprise. An Internet connection is provided from the ISP to the customer's building over fiber optic cable, running Ethernet directly over a 100 Mbps or 1 Gbps connection. This kind of WAN connection is referred to as Fiber To The Building (FTTB). Phone signals are routed from PBX/MDF distribution equipment into the splitter. The data and phone signals for each user are combined in the splitter, and passed over VDSL lines to individual customers.

The CPE at the other end of the VDSL line connects to any PC or Macintosh equipped with a 10/100BASE-TX network interface card. Your existing telephone, modem, or fax machine simply plugs into the CPE's phone port. There is no need for special splitters, terminators or filters. In fact, there is no need to modify the home wiring at all. And, because the VDSL connection is based on Ethernet, no further complex software configuration is required.

VDSL Technology

VDSL (Very High Bit-Rate Digital Subscriber Line) is at the high-end of all the DSL technologies, offering the best combination of fiber optics and copper to provide high-speed broadband Internet access. VDSL's primary application is in providing a broadband data service to multi-tenant residential or commercial buildings. In this implementation, fiber optic cable carries data from an Internet Service Provider to the building; then the installed telephone copper wires take the data and deliver it to individual units within that building.

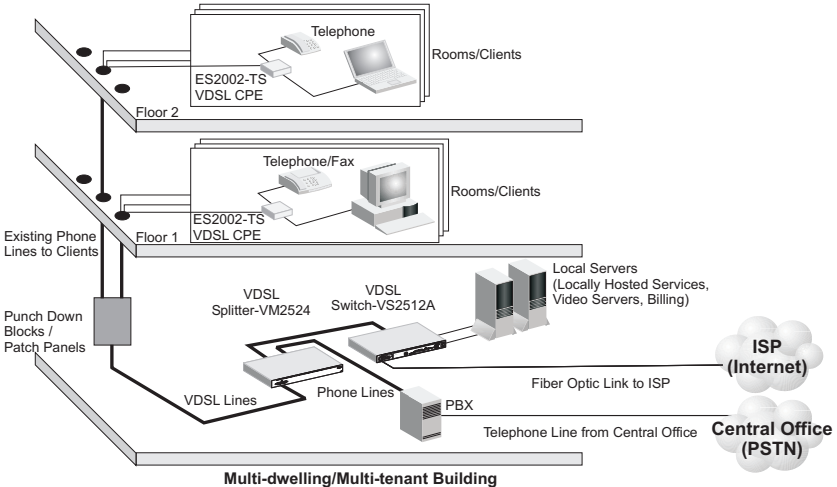

Figure 1-1. VDSL Application

VDSL provides high-speed Internet access over existing phone lines by making use of previously unused frequency bandwidth above the voice band. By placing VDSL signals above the frequency of the voice signal, a VDSL service can coexist on the same line as other telephone services. VDSL can operate symmetrically, providing the same data rate in both directions, or asymmetrically, providing a higher data rate in the downstream (receive) direction than in the upstream (transmit) direction.

VDSL can deliver high-performance online applications, such as high-quality video and other switched multimedia services. Accton's Ethernet-over-VDSL system provides robust performance, with a symmetric data rate up to 15 Mbps, and a range up to 1525 m (5000 ft). Accton's system is based on advanced VDSL QAM (Quadrature Amplitude Modulation) technology with adaptive channel equalization that overcomes bridge taps and other line distortions. Reed-Solomon Forward Error Correction and interleaving protects against errors due to impulse noise and enables recovery from signal interruptions. Frequency Division Duplexing (FDD) separates downstream and upstream channels and allows VDSL signals to coexist with regular telephone services. A power back-off mechanism is also implemented to reduce noise from crosstalk in line bundles.

Switch Architecture

The VDSL Switch-VS2512A employs a wire-speed, non-blocking switching fabric. This permits simultaneous wire-speed transport of multiple packets at low latency on all ports. This switch also features full-duplex capability on all ports, which effectively doubles the bandwidth of each connection.

Management Options

This switch contains a comprehensive array of LEDs for “at-a-glance” monitoring of network and port status. It also includes a built-in network management agent that allows the switch to be managed in-band using SNMP or RMON (Groups 1, 2, 3 and 9) protocols, with a Web browser, or remotely via Telnet. The switch also provides an RS-232 serial port (DB-9 connector) on the front panel for out-of-band management. A PC may be connected to this port for configuration and monitoring out-of-band via a null-modem cable. (See Appendix B for wiring options.)

This switch provides a wide range of advanced performance-enhancing features. Port-based and tagged VLANs, plus support for automatic GVRP VLAN registration provides traffic security and efficient use of network bandwidth. QoS priority queueing ensures the minimum delay for moving real-time multimedia data across the network. Flow control eliminates the loss of packets due to bottlenecks caused by port saturation. Broadcast storm control prevents broadcast traffic storms from engulfing the network. Some of this switch’s advanced features are described below. For a detailed description, refer to the Management Guide.

VLANs

The VDSL Switch-VS2512A supports up to 255 VLANs. A Virtual LAN is a collection of network nodes that share the same collision domain regardless of their physical location or connection point in the network. By segmenting your network into VLANs, you can:

- Eliminate broadcast storms which severely degrade performance in a flat network.
- Simplify network management for node changes/moves by remotely configuring VLAN membership for any port, rather than having to manually change the node’s IP address.

Multicast Switching

Specific multicast traffic can be assigned to its own VLAN to ensure that it does not interfere with normal network traffic and to guarantee real-time delivery by setting the required priority level for the designated VLAN. The switch uses IGMP Snooping to manage multicast group registration.

Traffic Priority

This switch provides Quality of Service (QoS) by prioritizing each packet based on the required level of service, using four distinct categories with Weighted Round Robin Queuing. It uses IEEE 802.1p and 802.1Q tags to prioritize incoming traffic based on input from the end-station application. These functions can be used to provide independent priorities for delay-sensitive data and best-effort data.

Description of Hardware

VDSL Switch-VS2512A

Accton's VDSL Switch-VS2512A together with the VDSL Splitter-VM2524/VM2548 combines data and voice signals for delivery over standard telephone cable to multiple users in residential or commercial buildings. Ethernet data signals are received on the switch uplink port and passed to 12 VDSL lines via 12 internal Ethernet ports. These 12 VDSL lines are then passed to the splitter via the RJ-21 connector on the rear panel.

The switch supports the following optional modules: 1-port 1000BASE-T, 1-port 1000BASE-SX, 1-port 1000BASE-LX, 1-port 1000BASE-X GBIC, 4-port 100BASE-FX multimode and single-mode, 1-port 100BASE-FX multimode, 1-port 10/100BASE-TX, or 4-port 10/100Base-TX. The fiber module ports can provide direct connection to your ISP with fiber optic cable. In a switch stack, any of the module ports can also function as uplinks to the backbone, or as regular switch ports for networking.

Speed, duplex mode, and flow control for the optional module, and GBIC transceiver ports are shown below.

Port Type	Speed	Duplex Mode	Flow Control
100BASE-FX	100 Mbps	full duplex	auto
10/100BASE-TX	auto (10/100 Mbps)	auto	auto
1000BASE-T	auto (10/100/1000 Mbps)	full duplex at 1000 Mbps full/half duplex at 10/100 Mbps	auto
1000BASE-SX	1000 Mbps	full duplex	auto
1000BASE-LX	1000 Mbps	full duplex	auto
1000BASE-LH	1000 Mbps	full duplex	auto

Note: If the attached device does not support auto-negotiation, you will have to manually configure the other device to match the duplex mode and speed, otherwise it will default to half duplex.

The switch also includes a DB-9 console port on the front panel for switch configuration. It also has two FireWire (IEEE 1394) ports that can be used to stack up to 8 units for common management access. When multiple units are stacked together, you can manage the entire stack by connecting to the console port on the Master unit in the stack. The push button on the front panel is used to select the Master unit in the stack.

Note: Only one unit in the stack can act as Master.

The switch also includes key system and port indicators that simplify installation and network troubleshooting. The front panel has LEDs for Ethernet link status/activity and VDSL link status, as well as system status indicators.

The following figure shows the components of the VDSL Switch.

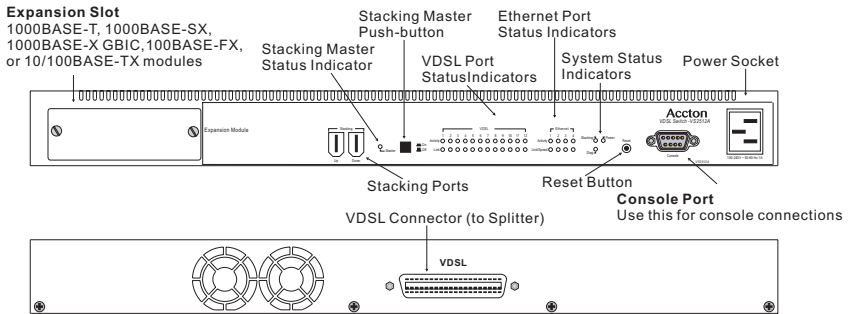

Figure 1-2. VDSL Switch-VS2512A Front and Rear Panels

VDSL Splitter-VM2524 and VDSL Splitter-VM2548

Accton's VDSL Splitter-VM2524 and VDSL Splitter-VM2548 combine data and voice signals for delivery over standard telephone cable to multiple users in residential or commercial buildings. Data signals from the VDSL Switch port (rear panel) are combined with phone signals from the PBX port (rear panel) and then passed to multiple users over the VDSL Line port (front panel). The VDSL Splitter-VM2524 can support up to 24 line/users. The VDSL Splitter-VM2548 can support up to 48 line/users.

Two VDSL Switch-VS2512A units can be connected to one VDSL Splitter-VM2524, or four can be connected to one VDSL Splitter-VM2548, with "Y" cables, via the VDSL Switch port. The switch is connected directly to your ISP with fiber optic cable. The RJ-21 PBX port on the rear panel connects to PBX/MDF equipment that leads to your POTS (Plain Old Telephone Service) provider. The RJ-21 VDSL Line port on the front panel connects to a punch-down block or patch panel that distributes phone lines to individual users in your building.

The following figures shows the components of the VDSL Splitter-VM2524 and VDSL Splitter-VM2548.

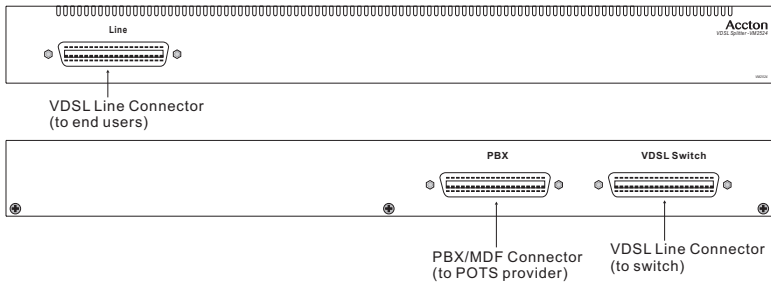

Figure 1-3. VDSL Splitter-VS2524 Front and Rear Panels

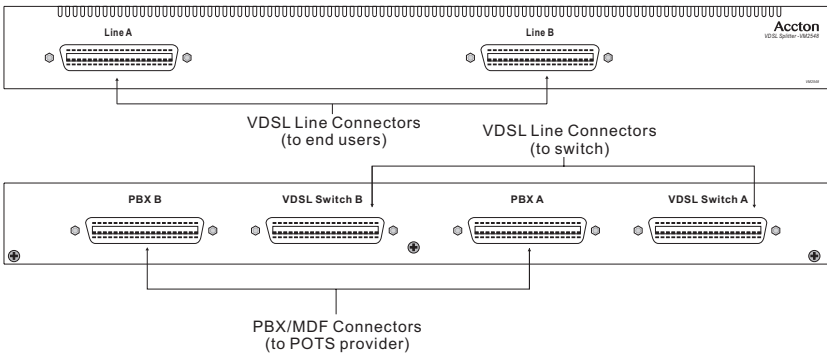

Figure 1-4. VDSL Splitter-VS2548 Front and Rear Panels

Ethernet-over-VDSL CPE

The Splitter-VM2524 and Splitter-VM2548 are designed to connect to the RJ-11 VDSL Line port on an ES2002-TS CPE. The CPE provides users with a high-speed Internet connection via its RJ-45 Ethernet port and a standard telephone connection via its RJ-11 phone jack.

Status LEDs

The LEDs, which are located on the VS2512A front panel for easy viewing, are shown below and described in the following table.

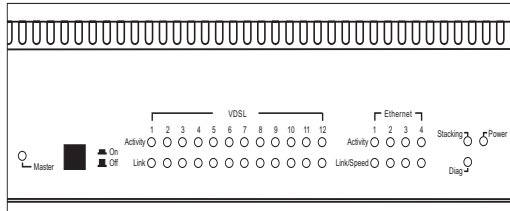

Figure 1-5. Port and System LEDs

Port Status LEDs		
LED	Condition	Status
VDSL Ports		
Link	On Green	Port has a valid connection, port enabled
	Flashing Amber	Port has a valid connection, port disabled
	Off	Port does not have a valid connection
Activity	Flashing Green	Shows that traffic is crossing the port
	Off	Shows that no traffic is crossing the port
Ethernet Ports		
Link/Speed	On Amber	Port is operating at 1000 Mbps
	On Green	Port is operating at 100 Mbps
	Flashing Green	Port is operating at 10 Mbps
	Flashing Amber	Port is disabled
Activity	Flashing Green	Shows that traffic is crossing the port
	Off	Shows that no traffic is crossing the port

System Status LEDs		
LED	Condition	Status
Power	On	Switch is receiving power
Diag	Flashing Green	System diagnostic test in progress
	On Green	System diagnostic test successfully completed
	On Amber	System diagnostic test failed
Stacking	On	Shows that the stacking link is connected
Master	On	The switch is the master switch in the stack
	Off	The switch is a slave switch in the stack

Optional Media Extender Modules

Optional 1000BASE-SX Module (VM2512A-1SX-SC-M)

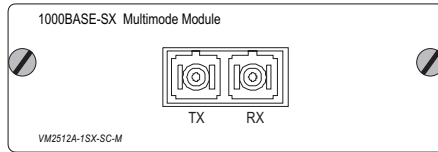

Figure 1-6. Single-Port 1000BASE-SX Gigabit Module

Using multimode fiber optic cable, the 1000BASE-SX port can be connected to a remote site up to 550 m (1805 ft) away. The 1000BASE-SX Gigabit module operates at 1 Gbps, with support for full-duplex mode and flow control. This module is fitted with an SC connector, but you can attach an ST plug to the switch using the SC-ST Converter (Part Number: ST5002).

Note: If the attached device does not support auto-negotiation, you will have to manually configure the other device to full duplex and no flow control.

Optional 1000BASE-LX Module (VM2512A-1LX-SC-S)

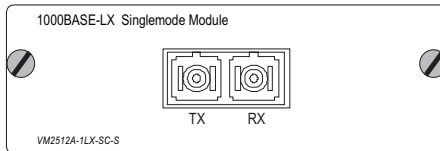

Figure 1-7. Single-Port 1000BASE-LX Gigabit Module

Using single-mode fiber optic cable, the 1000BASE-LX port can be connected to a remote site up to 5 km (16404 ft) away. The 1000BASE-LX Gigabit module operates at 1 Gbps, with support for full-duplex mode and flow control. This module is fitted with an SC connector, but you can attach an ST plug to the switch using the SC-ST Converter (Part Number: ST5002).

Note: If the attached device does not support auto-negotiation, you will have to manually configure the other device to full duplex and no flow control.

Optional 1000BASE-X GBIC Module (VM2512A-1GX-GBIC)

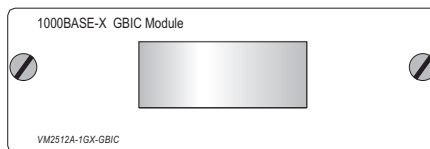

Figure 1-8. Single Port 1000BASE-X GBIC Module

1000BASE-SX GBIC transceivers provide one short-wavelength (850 nm) Gigabit port that can be used for a high-speed backbone or server connection. This port can be connected to a site up to 220 m (722 ft) away with 62.5/125 micron multimode fiber cable, or up to 500 m (1641 ft) with 50/125 micron multimode fiber cable.

1000BASE-LX GBIC transceivers provide one long-wavelength (1300 nm) Gigabit port that can be used for a high-speed backbone or server connection. This port can be connected to a site up to 5 km (16404 ft) away with single-mode fiber cable.

1000BASE-LH GBIC transceivers provide one long-wavelength (1550 nm) Gigabit port that can be used for a long-haul connection to a remote location. This port can be connected to a site up to 70 km (43.5 miles) away with single-mode fiber cable.

Caution: Install only 5 V GBIC transceivers into the module slots

Optional 1000BASE-T Module (VM2512A-1GT)

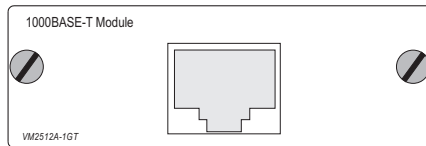

Figure 1-9. Single-Port 1000BASE-T Gigabit Module

Using Category 5 or 5e twisted-pair cable you can connect to another device up to 100 m (328 ft) away. The 1000BASE-T module operates at 10, 100, or 1000 Mbps, full duplex, and supports auto-negotiation of speed and flow control. Note that you should first test the cable installation for IEEE 802.3ab compliance. See “1000BASE-T Cable Requirements” on page B-3.

If the attached device does not support auto-negotiation, you will have to manually configure the other device to match the speed and duplex mode with no flow control.

Optional 10/100BASE-TX Module (VM2512A-1TX)

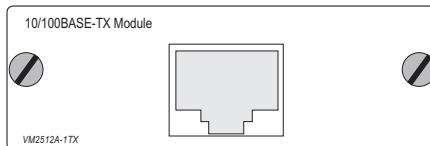

Figure 1-10. 1-Port 10/100BASE-TX Module

Using Category 3, 4, or 5 twisted-pair cable for 10 Mbps links or Category 5 twisted-pair cable for 100 Mbps links, you can connect to another device up to 100 m (328 ft) away. The 10/100BASE-TX module operates at 10/100 Mbps, full and half duplex, and supports auto-negotiation of speed and flow control.

Optional 10/100BASE-TX Module (VM2512A-4TX)

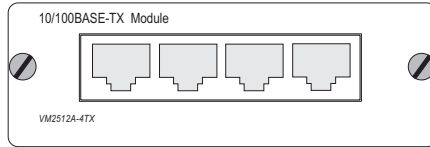

Figure 1-11. 4-Port 10/100BASE-TX Module

Using Category 3, 4, or 5 twisted-pair cable for 10 Mbps links or Category 5 twisted-pair cable for 100 Mbps links, you can connect to another device up to 100 m (328 ft) away. The 10/100BASE-TX module operates at 10, 100 Mbps, full and half duplex, and supports auto-negotiation of speed and flow control.

Optional 100BASE-FX Module (VM2512A-1FX-SC-M)

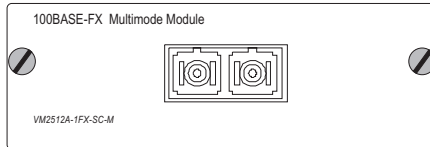

Figure 1-12. 1-Port 100BASE-FX Multimode Module

Using 62.5/125 or 50/125 micron multimode fiber cable, the 100BASE-FX port can be connected to a remote site up to 2 km (1.24 miles) away. The 100BASE-FX module operates at 100 Mbps, with support for full-duplex mode and flow control. This module is fitted with an SC connector.

Optional 100BASE-FX Module (VM2512A-4FX-MTRJ-M)

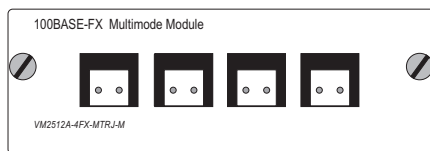
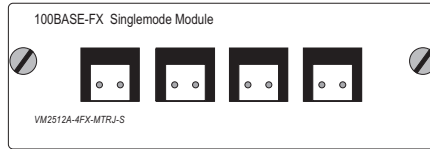

Figure 1-13. 4-Port 100BASE-FX Multimode Module

Using 62.5/125 or 50/125 micron multimode fiber cable, the 100BASE-FX ports can be connected to a remote site up to 2 km (1.24 miles) away. The 100BASE-FX module operates at 100 Mbps, with support for full-duplex mode and flow control. This module is fitted with 4 MT-RJ connectors.

Optional 100BASE-FX Module (VM2512A-4FX-MTRJ-S)**Figure 1-14. 4-Port 100BASE-FX Single-mode Module**

Using 9/125 micron single-mode fiber cable, the 100BASE-FX ports can be connected to a remote site up to 20 km (12.43 miles) away. The 100BASE-FX module operates at 100 Mbps, with support for full-duplex mode and flow control. This module is fitted with 4 MT-RJ connectors

Power Supply Receptacle

There is a power receptacle on the front panel of the switch for the AC power cord.

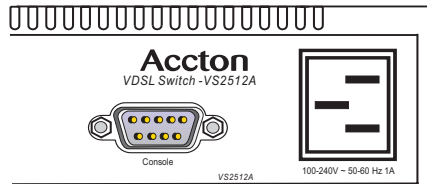
**Figure 1-15. Power Supply Receptacle**

Key Features

VDSL features (CPE side) include:

- High-speed Internet access over existing phone lines
- VDSL connection provides the following rate/range options:

Rate	Mode	Max. Range
15 Mbps	Symmetric	1070 m (3500 ft)
10 Mbps	Symmetric	1220 m (4000 ft)
5 Mbps	Symmetric	1525 m (5000 ft)

- Concurrent data and telephone services (voice/ISDN) over a single connection
- Always-on digital connection eliminates dial-up delays, and transparent reconnection when initiating any network request
- Supports evolving ETSI, ANSI and ITU VDSL standards for the copper local loop
- Spectral compatibility with POTS, ISDN (2B1Q/4B3T) or “Smartphone” digital PBX
- Port-to-port isolation for Ethernet
- Robust operation on severely distorted lines
- Supports power back-off algorithm that permits a mixed distance deployment

Ethernet features (CO side) include:

- Optional 1-port 1000BASE-T, 1-port 1000BASE-SX, 1-port 1000BASE-X GBIC, 4-Port 100BASE-FX, or 4-Port 10/100BASE-TX modules
- Compliant to IEEE 802.3 10BASE-T Ethernet, IEEE 802.3u 100BASE-TX and 100BASE-FX Fast Ethernet, IEEE 802.3ab Gigabit Ethernet, and IEEE 802.3z Gigabit Ethernet standards
- The 1000BASE-T port auto-negotiates Ethernet connection at 10/100/1000 Mbps, full/half duplex at 10/100 Mbps, full duplex at 1000Mbps
- The 1000BASE-SX port cannot be set to auto-negotiation; it is fixed at 1000 Mbps, full duplex
- The 100BASE-FX ports cannot be set to auto-negotiation; they are fixed at 1000 Mbps, full duplex
- The 10/100BASE-TX ports auto-negotiate Ethernet connection at 10/100 Mbps, full/half duplex
- Provides back pressure for half duplex and IEEE 802.3x flow control for full duplex

System features include:

- LEDs indicate Ethernet link status/activity, VDSL link status, and System status
- Stacks up to 8 units for console management
- Simple plug-and-play installation
- Switch fabric bandwidth of 9.8 Gbps
- Switching table with a total of 8K entries
- Transparent bridging

- Provides Store-and-Forward switching for intra-VLAN traffic
- Supports wire-speed Layer 2 switching
- Supports flow control, using back pressure for half duplex and IEEE 802.3x for full duplex
- Broadcast Storm Control
- Desktop or rack-mountable

Management features include:

- “At-a-glance” LEDs for easy troubleshooting
- Network management agent:
 - Manages switch in-band or out-of-band
 - Supports Telnet, SNMP/RMON and Web-based interface
 - Spanning Tree Protocol for redundant network connections
 - VLAN Support with up to 255 groups, port-based or with 802.1Q VLAN tagging, and GVRP for automatic VLAN learning
 - Quality of Service (QoS) supports four levels of priority and Weighted Round Robin Queueing
 - Multicast Switching based on IGMP Snooping
 - Port trunking supported with 2 Gigabit ports.

Chapter 2: Network Planning

Introduction to Switching

A network switch allows simultaneous transmission of multiple packets via non-crossbar switching. This means that it can partition a network more efficiently than bridges or routers. The switch has, therefore, been recognized as one of the most important building blocks for today's networking technology.

When performance bottlenecks are caused by congestion at the network access point (such as the network card for a high-volume file server), the device experiencing congestion (server or power user) can be attached directly to a switched port. And, by using full-duplex mode, the bandwidth to the end-user can be doubled to maximize throughput.

A switch can be easily configured in any Ethernet network to significantly boost bandwidth while using conventional cabling and network cards.

Sample Applications

VDSL provides significant savings on network installation, equipment and service fees. Internet services operate over existing phone cabling and a minimal amount of network equipment. The only changes require installing an ES2002-TS CPE for each client, and a VDSL Switch-VS2512A and VDSL Splitter-VM2524 in the basement or wiring closet. Internet service can then be provided over a direct Ethernet connection to your ISP. For non-commercial environments, you can run the switch through a broadband router at the customer's site. This will allow you to use a single-user account and ISP sharing to significantly reduce network access charges.

Accton's VDSL Switch-VS2512A provides Internet connections of up to 15 Mbps, full duplex, for multiple users. Cable distances also can run up to 1525 meters (at lower transmission rates). VDSL installation is extremely economical for multiple-tenant dwellings such as apartment buildings, hotels or school dormitories, as well as commercial buildings.

VDSL provides multiple-user access to the Internet with benefits including:

- Internet services such as e-mail over faster connections than currently possible with other options such as cable modem or ADSL
- Multimedia applications such as video and virtual gaming made available to the broader public for the first time
- Access to corporate intranets at speeds close to that available in the office

Both local network applications and Internet services are supported for commercial environments.

Internet Connections

The figure below shows a VDSL Switch-VS2512A and VDSL Splitter-VM2524 providing a broadband data service to a multi-tenant residential or commercial building. In this implementation, fiber optic cable carries data from a telephone company's central office to the building; then the installed telephone copper wires take the data and deliver it to individual units within that building.

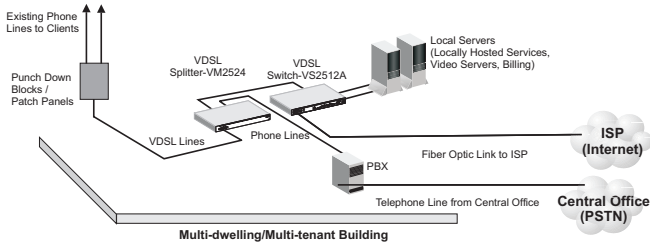

Figure 2-1. Internet Connections

Remote Connections with Fiber Cable

Fiber optic technology allows for longer cabling than any other media type. A 1000BASE-SX MMF Gigabit link can connect to a site up to 550m away. This allows end-users in two sites to use the same Internet connection, share server resources, and communicate with each other.

In the figure below, a 1000BASE-SX port on the bottom VDSL Switch-VS2512A in the stack in Building 1 is providing 1000 Mbps connectivity to the VDSL Switch-VS2512A in Building 2.

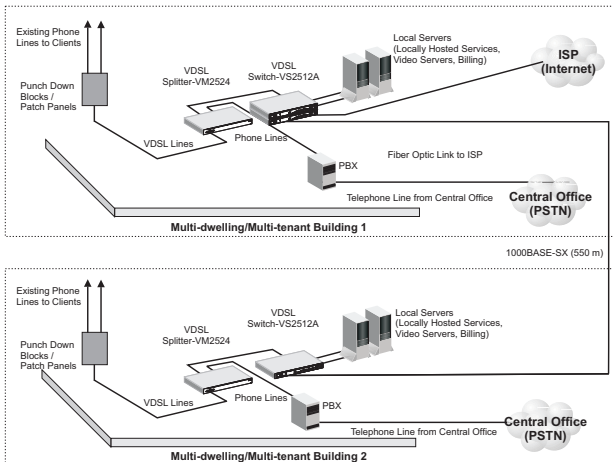

Figure 2-2. Remote Connection with Fiber Cable

Making VLAN Connections

VLANs can be based on port groups, or each data frame can be explicitly tagged to identify the VLAN group to which it belongs. When using port-based VLANs, ports can be assigned to one or more groups. Port-based VLANs are suitable for small networks. A single switch can be easily configured to support several VLAN groups for various organizational entities (such as Finance and Marketing).

When VLANs cross switches linked by Ethernet connections, you must use VLAN tagging. This allows you to assign multiple VLAN groups to the “trunk” ports (that is, tagged ports) connecting different switches.

This switch also has a Private VLAN feature. This allows modification of the default VLAN to provide port-based security and isolation between ports within the VLAN. Data traffic on these ports can only be forwarded to, and from, the uplink port. Private VLANs and normal VLANs can exist simultaneously within the same switch.

In the figure below, ports 1-5, connected to four end users and a server, are configured into a normal VLAN. The remaining ports are configured into a private VLAN.

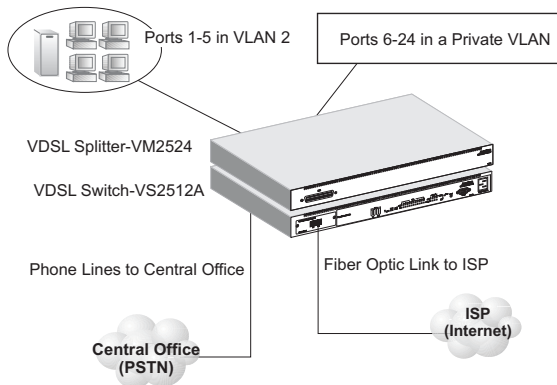

Figure 2-3. Making VLAN Connections

Note: When connecting to a switch that does not support IEEE 802.1Q VLAN tags, use untagged ports.

Application Notes

1. For network applications that require routing between dissimilar network types, you can attach the VDSL switch directly to a router.
2. The multimode fiber modules are fitted with SC connectors, but you can attach an ST plug to the switch using Accton's optional SC-to-ST plug converter (Part Number: ST5002, for 62.5/125 micron cable only). If you do use an ST plug converter, be sure you run cable from the Rx (Tx) port on the module to the Tx (Rx) port on the target device.
3. As a general rule the length of Gigabit fiber optic cable for a single switched link should not exceed 550 m (1805 ft) for multimode fiber or 5 km (16404 ft) for single-mode fiber.

However, power budget constraints must also be considered when calculating the maximum cable length for your specific environment.

Chapter 3: Installing the VDSL Switch and Splitter

Preparing the Site

In multi-tenant buildings, phone lines coming from the service provider are generally attached to a PBX or MDF distribution box in the basement. These lines run from the PBX to a punch-down block, and then up to the POTS terminals for individual users. The following figure displays the normal wiring before installing the VDSL switch and splitter.

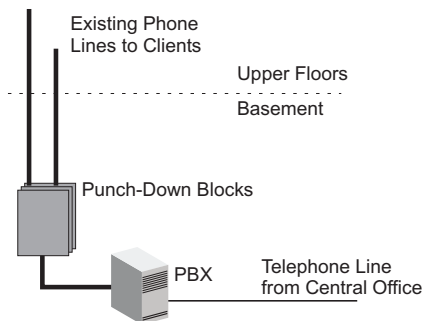

Figure 3-1. Wiring before VDSL Switch and Splitter Installation

Installing Additional Phone Line Equipment

The switch and splitter should be installed close to the PBX and the punch-down block, usually in the basement or wiring closet. You may also want to install a rack for distribution equipment, such as a splitter, switch, router, or patch panel.

An optional patch panel can be used to connect the circuits between the splitter and the punch-down blocks. If a patch panel is not used, the splitter connects directly to the PBX for the incoming phone lines and the punch-down block used for the VDSL lines running up to the end users. In this case, the punch-down blocks must have an RJ-21 connector.

Equipment Checklist

Before installing the switch and splitter, verify that you have all the items listed under "Package Contents." If any of the items are missing or damaged, contact your local Accton distributor. Also, be sure you have all the necessary tools and cabling before installing the switch and splitter. Note that these devices can be installed on any suitably large flat surface or in a standard EIA 19-inch rack.

Package Contents

VDSL Switch-VS2512A

- VDSL Switch-VS2512A
- Four adhesive foot pads
- Bracket Mounting Kit containing two brackets and four screws for attaching the brackets to the switch
- One Power Cord—either US, Continental Europe or UK
- RS-232 console cable
- One FireWire Stack Cable
- This Installation Guide
- Management Guide

VDSL Splitter-VM2524/2548

- VDSL Splitter-VM2524 or VDSL Splitter-VM2548
- Four adhesive foot pads
- Bracket Mounting Kit containing two brackets and four screws for attaching the brackets to the splitter
- This Installation Guide

Please complete the warranty registration card and return to Accton, or register online at: register.acctontech.com.

Please inform your dealer if there are any incorrect, missing or damaged parts. If possible, retain the carton, including the original packing materials. Use them again to repack the product in case there is a need to return it for repair.

Optional Rack-Mounting Equipment

If you plan to rack-mount the switch and splitter, be sure to have the following equipment available:

- Four mounting screws for each device you plan to install in a rack—these are not included
- A screwdriver (Phillips or flathead, depending on the type of screws used)

Mounting

The switch and splitter may be mounted on any flat surface, such as a shelf, or in a rack.

Before you start installing the switch and splitter, make sure you can provide the right operating environment, including power requirements, sufficient physical space, and proximity to other network devices that are to be connected. Verify the following installation requirements:

- Power requirements: 100 to 240 VAC ($\pm 10\%$) at 50 to 60 Hz ($\pm 3\text{Hz}$). The switch and splitter power supplies automatically adjust to the input voltage level. Make sure that a properly grounded power outlet is within 2.5 m (8 ft) of the switch and splitter.
- The switch and splitter should be located in a cool dry place, with at least 10 cm (4 in.) of space on the sides for ventilation.
- Place the switch and splitter out of direct sunlight, and away from heat sources or areas with a high amount of electromagnetic interference. The temperature and humidity should be within the ranges listed in the specifications.
- If you intend to mount the switch and splitter in a rack, make sure you have all the necessary mounting screws, brackets, bolts and nuts, and the right tools.
- Check if network cables and connectors needed for installation are available.
- Be sure the splitter is within reach of the punch-down blocks (or patch panel) for rear panel connections and within reach of the VDSL switch for front panel connections.

Installing Optional Modules: Before mounting the switch, be sure you install any optional modules. If you have purchased an optional slide-in 1000BASE-SX, 1000BASE-T, 1000BASE-LX, 1000BASE-X GBIC, 10/100BASE-TX or 100BASE-FX media expansion module, install it now, following the instructions provided on page 3-5.

To rack-mount devices:

1. Attach the brackets to the device using the screws provided in the Bracket Mounting Kit.

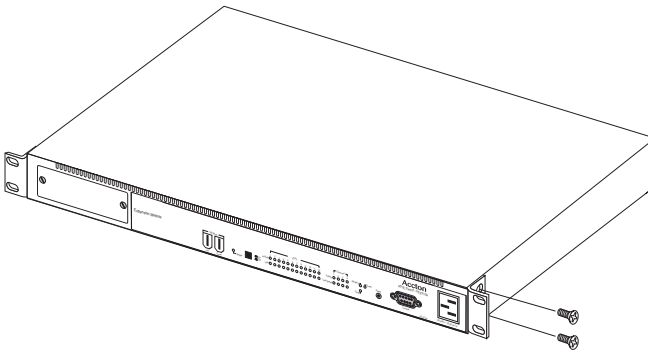

Figure 3-2. Attaching the Brackets

3. If installing a single switch only, go to “Powering On the Switch” at the end of this chapter.
4. If installing multiple switches, attach four adhesive feet to each one. Place each device squarely on top of the one below, in any order.

Installing an Optional Module into the Switch

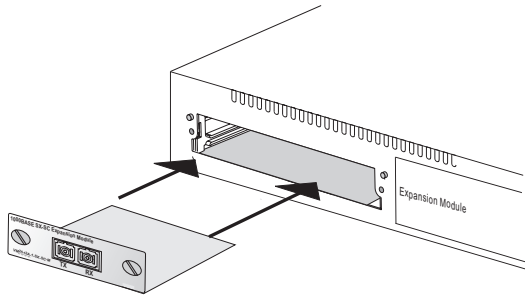

Figure 3-5. Installing an Optional Module

Caution: DO NOT install slide-in modules with the switch powered on. Be sure you power off the switch before installing any module.

To install an optional module into the switch, do the following:

1. Disconnect power to the switch.
2. Remove the blank metal plate (or a previously installed module) from the appropriate slot by removing the two screws with a flat-head screwdriver.
3. Before opening the package that contains the module, touch the bag to the switch casing to discharge any potential static electricity. Also, it is recommended to use an ESD wrist strap during installation.
4. Remove the module from the anti-static shielded bag.
5. Holding the module level, guide it into the carrier rails on each side and gently push it all the way into the slot, ensuring that it firmly engages with the connector.
6. If you are sure the module is properly mated with the connector, tighten the retainer screws to secure the module in the slot.

Installing a GBIC Transceiver

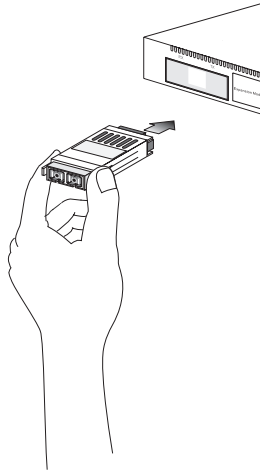

Figure 3-6. Installing a GBIC Transceiver

Caution: Install only 5 V GBIC transceivers into the module slots.

You can install a GBIC transceiver as described below:

1. Insert the transceiver with the SC connector facing out toward you. Note that the transceiver is keyed so that it can only be installed in one orientation.
2. Press in on the transceiver's side tabs, and gently slide it into the GBIC interface slot until it clicks into place.

Caution: Install only 5 V GBIC transceivers into the module slots.

Note: GBIC transceivers are hot-swappable. You do not need to power off the switch before installing or removing a transceiver.

Connecting to the Stack's Backplane

Plug one end of the provided stack cable in the “Down” port of the top unit and the other end to the “Up” port of the next unit. Repeat this step for each unit in the stack. Form a simple chain starting at the “Down” port on the top unit and ending at the “Up” port on the bottom unit (stacking up to 8 units). The VDSL Switch-VS2512A supports a wrap-around stacking feature. If a connection is made between the “Down” port of the bottom switch in the stack and the “Up” port of the top switch, then all switches in the stack will remain connected, even if one fails.

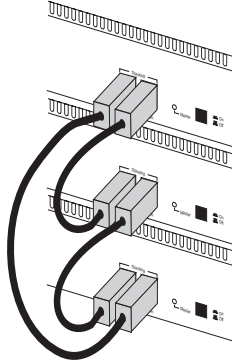

Figure 3-7. Connecting to the Stack's Backplane

Select the Master unit in the stack by pushing the push button in on the front of the switch.

Note: Only one switch in the stack can act as Master.

Powering On the Switch

To connect a device to a power source:

1. Insert the power cable plug directly into the receptacle located at the front of the switch.

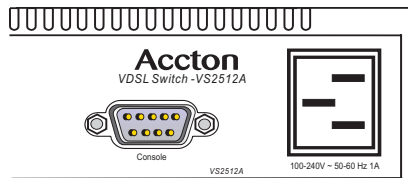

Figure 3-8. Power Receptacle

2. Plug the other end of the cable into a grounded, 3-pin socket.

Note: For International use, you may need to change the AC line cord. You must use a line cord set that has been approved for the receptacle type in your country.

3. Check the front-panel LEDs as the switch is powered on to be sure the Power LED is lit. If not, check that the power cable is correctly plugged in. The switch will automatically select the setting that matches the connected input voltage. Therefore, no additional adjustments are necessary when connecting it to any input voltage within the range marked on the front panel.
4. The switch performs a self-diagnostic test upon power-on.

Note: The unit supports a “hot remove” feature which permits you to connect or disconnect network cables without powering off the unit and without disrupting the operation of the devices attached to the unit.

Chapter 4: Making Network Connections

Twisted-Pair Devices

Each device requires an unshielded twisted-pair (UTP) cable with RJ-45 connectors at both ends. For 100BASE-TX connections, Category 5 cable is required; for 10BASE-T, Category 3, 4 or 5 cable can be used.

Cabling Guidelines

The RJ-45 ports on the switch support automatic MDI/MDI-X operation, so you can use standard straight-through twisted-pair cables to connect to any other network device (PCs, servers, switches, routers, or hubs).

Note: Auto-negotiation must be enabled for automatic MDI/MDI-X pinout configuration.

See Appendix B for further information on cabling.

Connecting to the Punch-down Blocks

The splitter connects directly to the PBX and building's phone-line punch-down block with RJ-21 connectors. Follow the steps listed below to connect the splitter.

1. Connect one RJ-21 flat cable from the PBX/MDF to the RJ-21 connector on the back of the splitter labeled "PBX."
2. Connect the other RJ-21 flat cable from the punch-down block to the RJ-21 connector on the front of the splitter labeled "Line."

The RJ-21 port on punch-down blocks must be wired to match the pin assignments of ports on the back of the splitter. To ensure that your cables are properly wired, refer to "RJ-21 Port Pin Assignments" on page B-4.

Note: If you are using a patch panel, connect the RJ-21 ports on the back of the splitter directly to the corresponding ports on the patch panel, and then manually wire each pair (up to 24) from the patch panel to the punch-down blocks.

- Label the cables to simplify future troubleshooting.

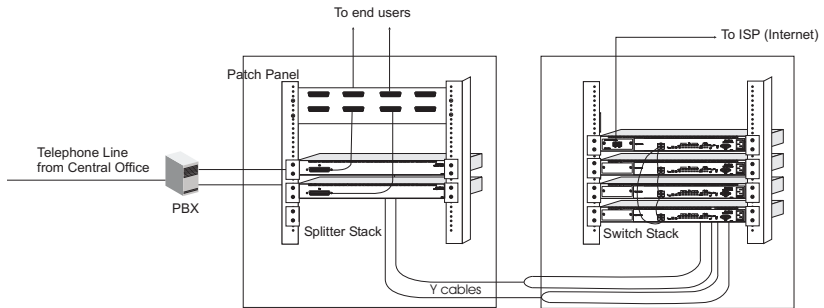

Figure 4-2. Wiring Closet Connections

Fiber Optic Devices

An optional slide-in 1000BASE-SX, 1000BASE-LX or 100BASE-FX module, or 1000BASE-X transceiver may be used for backbone and long distance connections, or for ISP (Internet) connections. A 1000BASE-SX, 100BASE-LX or 1000BASE-X transceiver may also be used for connecting to a high-speed server.

MT-RJ Connections

Each single-mode device requires a 9/125 micron multimode fiber optic cable with MT-RJ connectors at both ends. Each multimode device requires a 62.5/125 micron or 50/125 micron multimode fiber optic cable with MT-RJ connectors at both ends.

- Remove and keep the MT-RJ port's plastic cover. When not connected to a fiber cable, the cover should be replaced to protect the optics.
- Check that the fiber terminators are clean. Dirty fiber terminators on fiber optic cables will impair the quality of the light transmitted through the cable and lead to degraded performance on the port.
- Connect one end of the cable to the MT-RJ port on the switch and the other end to the MT-RJ port on the other device. Since MT-RJ connectors are keyed, the cable can be attached in only one orientation.
- As each connection is made, check the Link LED on the switch's front panel for the corresponding port to be sure that the connection is valid

SC Connections

Each single-mode fiber optic port requires 9/125 micron multimode fiber optic cabling with an SC connector at both ends. Each multimode fiber optic port requires 50/125 or 62.5/125 micron multimode fiber optic cabling with an SC connector at both ends. If you need to connect to a device with 62.5/125 micron cable that has ST-type connectors, Accton provides an optional SC-ST Converter (Part Number: ST5002).

Caution: This switch uses lasers to transmit signals over fiber optic cable. The lasers are compliant with the requirements of a Class 1 Laser Product and are inherently eye safe in normal operation. However, you should never look directly at a transmit port when it is powered on.

1. Remove and keep the SC port's rubber cover. When not connected to a fiber cable, the rubber cover should be replaced to protect the optics.
2. Check that the fiber terminators are clean. You can clean the cable plugs by wiping them gently with a clean tissue or cotton ball moistened with a little ethanol. Dirty fiber terminators on fiber cables will impair the quality of the light transmitted through the cable and lead to degraded performance on the port.
3. Connect one end of the cable to the SC port on the switch and the other end to the SC port on the other device. Since SC connectors are keyed, the cable can be attached in only one orientation.

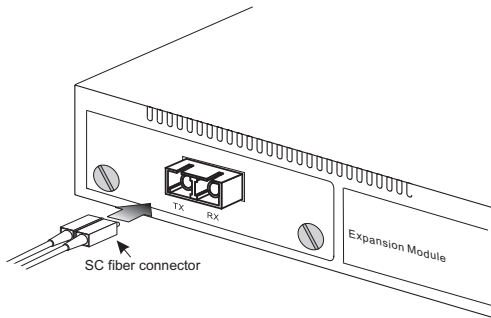

Figure 4-3. Making SC Port Connections

4. As a connection is made, check the Link LED on the switch corresponding to the port to be sure that the connection is valid.

Note: If you use the optional SC-ST Converter, be sure to connect the converter's Rx (Tx) port to the Rx (Tx) port on the other device.

1000BASE-SX, 1000BASE-LX and 1000BASE-LH fiber optic ports operate at 1 Gbps full duplex, with auto-negotiation of flow control. 100BASE-FX connections operate at 100 Mbps, full duplex, with auto-negotiation of flow control.

Appendix A: Troubleshooting

Diagnosing Switch Indicators

The VDSL Switch-VS2512A can be easily monitored through panel indicators to identify problems. The table below describes common problems you may encounter and possible solutions. If the solutions in the table fail to resolve the problem contact Accton Technical Support for advice.

Symptom	Cause	Solution
POWER indicator does not light up after power on.	Power outlet, power cord, or internal power supply may be defective.	<ul style="list-style-type: none">• Check the power outlet by plugging in another device that is functioning properly.• Check the power cord with another device. If these measures fail to resolve the problem, have the unit's power supply replaced by a qualified Accton distributor.
ETHERNET LINK indicator does not light up after making a connection.	Network cable or Ethernet device attached to this port may be defective.	<ul style="list-style-type: none">• Verify that the switch and attached device are powered on.• Be sure an Ethernet cable is plugged into both the switch and attached device.• Verify that the proper cable type is used and its length does not exceed specified limits.• Check the network cable connections for possible defects. Replace the defective cable if necessary.
VDSL LINK indicator does not light up after making a connection.	VDSL switch, cabling, VDSL, VDSL LINE, or VDSL Switch ports may be defective.	<ul style="list-style-type: none">• Verify that the VDSL switch and attached CPE are powered on.• Be sure the RJ-21 cables are plugged into the VDSL switch, splitter, and the VDSL punch-down block/patch panel.• Verify that the cable length does not exceed specified limits.• Check the cable connections on the VDSL switch, splitter, punch-down block/patch panel, and the VDSL CPE for possible defects. Replace the defective cable if necessary.

Power and Cooling Problems

If the power indicator does not turn on when the power cord is plugged in, you may have a problem with the power outlet, power cord, or internal power supply. However, if the unit powers off after running for a while, check for loose power connections, power losses or surges at the power outlet, and verify that the fans on the unit are unobstructed and running prior to shutdown. If you still cannot isolate the problem, then the internal power supply may be defective. In this case, contact Accton Technical Support for assistance.

Installation

Verify that all system components have been properly installed. If one or more components appear to be malfunctioning (such as the power cord or network cabling), test them in an alternate environment where you are sure that all the other components are functioning properly.

In-Band Access

You can access the management agent in the switch from anywhere within the attached network using Telnet, a Web browser, or other network management software such as AccView. However, you must first configure the switch with a valid IP address, subnet mask, and default gateway. If you have trouble establishing a link to the management agent, check to see if you have a valid network connection. Then verify that you entered the correct IP address. Also, be sure the port through which you are connecting to the switch has not been disabled. If it has not been disabled, then check the network cabling that runs between your remote location and the switch.

Note: You can configure the management agent to accept one to four simultaneous Telnet sessions. If the maximum number of sessions already exists, an additional Telnet connection will not be able to log into the system.

Appendix B: Cables

Specifications.

Cable Types and Specifications			
Cable	Type	Max. Length	Connector
10BASE-T	Cat. 3, 4, 5 100-ohm UTP	100 m (328 ft)	RJ-45
100BASE-TX	Cat. 5 100-ohm UTP	100 m (328 ft)	RJ-45
1000BASE-SX	50/125 or 62.5/125 micron core MMF	See the following table	SC or ST
1000BASE-LX	9/125 micron SMF	5 km (3.12 miles)	SC or ST
1000BASE-LH	9/125 micron SMF	70 km (43.5 miles)	SC or ST
100BASE-FX	50/125 or 62.5/125 micron multimode fiber optic cable	2 km (1.24 miles)	MTRJ
100BASE-FX	9/125 micron single-mode fiber optic cable	20 km (12.43 miles)	MTRJ
1000BASE-T	Cat. 5, 5e 100-ohm UTP	100 m (328 ft)	RJ-45

1000BASE-SX Fiber Specifications		
Fiber Diameter	Fiber Bandwidth	Maximum Cable Length
62.5/125 micron MMF	160 MHz/km	2-220 m (7-722 ft)
	200 MHz/km	2-275 m (7-902 ft)
50/125 micron MMF	400 MHz/km	2-500 m (7-1641 ft)
	500 MHz/km	2-550 m (7-1805 ft)

Twisted-Pair Cable and Pin Assignments

Caution: DO NOT plug a phone jack connector into any RJ-45 port. Use only twisted-pair cables with RJ-45 connectors that conform with FCC standards.

Caution: Each wire pair must be attached to the RJ-45 connectors in a specific orientation. (See "Cabling Guidelines" on page 4-1 for an explanation.)

Figure B-1 illustrates how the pins on the RJ-45 connector are numbered. Be sure to hold the connectors in the same orientation when attaching the wires to the pins.

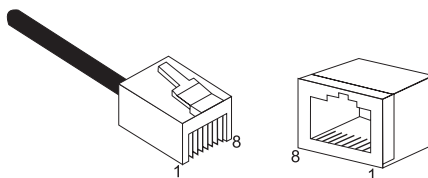

Figure B-1. RJ-45 Connector Pin Numbers

10BASE-T/100BASE-TX Pin Assignments

For 100BASE-TX/10BASE-T connections, a twisted-pair cable must have two pairs of wires. Each wire pair is identified by two different colors. For example, one wire might be red and the other, red with white stripes. Also, an RJ-45 connector must be attached to both ends of the cable.

With 100BASE-TX/10BASE-T cable, pins 1 and 2 are used for transmitting data, and pins 3 and 6 for receiving data.

RJ-45 Pin Assignments	
Pin Number	Assignment ¹
1	Tx+
2	Tx-
3	Rx+
6	Rx-

1: The "+" and "-" signs represent the polarity of the wires that make up each wire pair.

Because all ports on this switch support automatic MDI/MDI-X operation, you can use straight-through cables for all network connections to PCs or servers, or to other switches or hubs. In straight-through cable, pins 1, 2, 3, and 6, at one end of the cable, are connected straight through to pins 1, 2, 3 and 6 at the other end of the cable. The table below shows the 10BASE-T/100BASE-TX MDI and MDI-X port pinouts.

Pin	MDI-X Assignment	MDI Assignment
1	Input Receive Data +	Output Transmit Data +
2	Input Receive Data -	Output Transmit Data -
3	Output Transmit Data +	Input Receive Data +
6	Output Transmit Data -	Input Receive Data -

No other pins are used.

Note: Auto-negotiation must be enabled for automatic MDI/MDI-X pinout configuration.

1000BASE-T Pin Assignments

1000BASE-T ports support automatic MDI/MDI-X operation, so you can use straight-through cables for all network connections to PCs or servers, or to other switches or hubs.

The table below shows the 1000BASE-T MDI and MDI-X port pinouts. These ports require that all four pairs of wires be connected. Note that for 1000BASE-T operation, all four pairs of wires are used for both transmit and receive.

Use 100-ohm Category 5 or 5e unshielded twisted-pair (UTP) or shielded twisted-pair (STP) cable for 1000BASE-T connections. Also be sure that the length of any twisted-pair connection does not exceed 100 meters (328 feet).

Pin	MDI Signal Name	MDI-X Signal Name
1	Transmit Data plus (TD1+)	Transmit Data plus (TD2 +)
2	Receive Data minus (RD1-)	Receive Data minus (RD2-)
3	Transmit Data plus (TD2+)	Transmit Data plus (TD1+)
4	Transmit Data plus (TD3+)	Transmit Data plus (TD4+)
5	Receive Data minus (RD3-)	Receive Data minus (RD4-)
6	Receive Data minus (RD2-)	Receive Data minus (RD1-)
7	Transmit Data plus (TD4+)	Transmit Data plus (TD3+)
8	Receive Data minus (RD4-)	Receive Data minus (RD3-)

1000BASE-T Cable Requirements

All Category 5 UTP cables that are used for 100BASE-TX connections should also work for 1000BASE-T, providing that all four wire pairs are connected. However, it is recommended that for all critical connections, or any new cable installations, Category 5e (enhanced Category 5) cable should be used. The Category 5e specification includes test parameters that are only recommendations for Category 5. Therefore, the first step in preparing existing Category 5 cabling for running 1000BASE-T is a simple test of the cable installation to be sure that it complies with the IEEE 802.3ab standards.

Cable Testing for Existing Category 5 Cable

Installed Category 5 cabling must pass tests for Attenuation, Near-End Crosstalk (NEXT), and Far-End Crosstalk (FEXT). This cable testing information is specified in the ANSI/TIA/EIA-TSB-67 standard. Additionally, cables must also pass test parameters for Return Loss and Equal-Level Far-End Crosstalk (ELFEXT). These tests are specified in the ANSI/TIA/EIA-TSB-95 Bulletin, "The Additional Transmission Performance Guidelines for 100 Ohm 4-Pair Category 5 Cabling."

Note that when testing your cable installation, be sure to include all patch cables between switches and end devices.

Adjusting Existing Category 5 Cabling to Run 1000BASE-T

If your existing Category 5 installation does not meet one of the test parameters for 1000BASE-T, there are basically three measures that can be applied to try and correct the problem:

1. Replace any Category 5 patch cables with high-performance Category 5e cables.
2. Reduce the number of connectors used in the link.
3. Reconnect some of the connectors in the link.

RJ-21 Port Pin Assignments

The PBX/MDF connector is designed to aggregate 24 POTS/ISDN ports. Each wire pair must be attached to the RJ-21 connector in a specific orientation detailed below. The following tables shows the pin assignments.

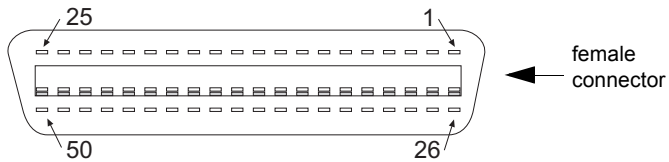

Pins	Circuit	Pins	Circuit	Pins	Circuit	Pins	Circuit
1,26	1, Ring/Tip	7,32	7, Ring/Tip	13,38	13, Ring/Tip	19,44	19, Ring/Tip
2,27	2, Ring/Tip	8,33	8, Ring/Tip	14,39	14, Ring/Tip	20,45	20, Ring/Tip
3,28	3, Ring/Tip	9,34	9, Ring/Tip	15,40	15, Ring/Tip	21,46	21, Ring/Tip
4,29	4, Ring/Tip	10,35	10, Ring/Tip	16,41	16, Ring/Tip	22,47	22, Ring/Tip
5,30	5, Ring/Tip	11,36	11, Ring/Tip	17,42	17, Ring/Tip	23,48	23, Ring/Tip
6,31	6, Ring/Tip	12,37	12, Ring/Tip	18,43	18, Ring/Tip	24,49	24, Ring/Tip

The VDSL Line connector is designed to aggregate 24 VDSL ports. The following table shows the pin assignments.

Pins	Circuit	Pins	Circuit	Pins	Circuit	Pins	Circuit
1,26	Port 1	7,32	Port 7	13,38	Port 13	19,44	Port 19
2,27	Port 2	8,33	Port 8	14,39	Port 14	20,45	Port 20
3,28	Port 3	9,34	Port 9	15,40	Port 15	21,46	Port 21
4,29	Port 4	10,35	Port 10	16,41	Port 16	22,47	Port 22
5,30	Port 5	11,36	Port 11	17,42	Port 17	23,48	Port 23
6,31	Port 6	12,37	Port 12	18,43	Port 18	24,49	Port 24

Console Port Pin Assignments

The DB-9 serial port on the switch's front panel is used to connect to the switch for out-of-band console configuration. The on-board menu-driven configuration program can be accessed from a terminal or a PC running a terminal emulation program. The pin assignments used to connect to the serial port are provided in the following tables.

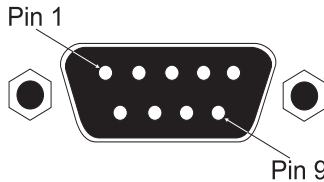

Figure 2-1. DB-9 Console Port Pin Numbers

DB-9 Port Pin Assignments

EIA Circuit	CCITT Signal	Description	Switch's DB9 DTE Pin #	PC DB9 DTE Pin #	PC DB25 DTE Pin #
BB	104	RxD (Received Data)	2	2	3
BA	103	TxD (Transmitted Data)	3	3	2
AB	102	SG (Signal Ground)	5	5	7

No other pins are used.

Console Port to 9-Pin DTE Port on PC

Switch's 9-Pin Serial Port	Null Modem	PC's 9-Pin DTE Port
2 RXD	<----- TXD ----->	3 TXD
3 TXD	----- RXD ----->	2 RXD
5 SGND	----- SGND -----	5 SGND

No other pins are used.

Console to 25-Pin DTE Port on PC

Switch's 9-Pin Serial Port	Null Modem	PC's 25-Pin DTE Port
2 RXD	<----- TXD ----->	2 TXD
3 TXD	----- RXD ----->	3 RXD
5 SGND	----- SGND -----	7 SGND

No other pins are used.

Appendix C: Specifications

VDSL Switch

Model

VDSL Switch-VS2512A

Physical Characteristics

VDSL Specifications

Supports evolving ETSI, ANSI and ITU standards

Modulation: 4 to 256 QAM Frequency Division Duplexing

Data Rate: Up to 15 Mbps symmetric

Range: Up to 1525 m (5000 ft)

Ports

1 RJ-21 Port (contains 12 VDSL lines)

1 Stacking Port Pair

1 Slide-in Module Slot

Interfaces

VDSL Line: RJ-21 flat cable

Stacking Ports: IEEE 1394 FireWire connectors

Buffer Architecture

16 Mbytes

Switch Fabric Bandwidth

9.8 Gbps

Switching Database

8K MAC address entries

LEDs

System: Power, Diag., Stacking, Master

VDSL Port: Link, Activity

Ethernet Port: Link/Speed, Activity

Weight

3.94 kg (8 lbs 11 oz)

Size

44.0 x 35.2 x 4.4 cm (17.4 x 13.9 x 1.7 in.)

Temperature

Operating: 0 to 50 °C (32 to 122 °F)

Storage: -40 to 70 °C (-40 to 158 °F)

Specifications

Humidity

Operating: 5% to 90%

AC Input

100 to 240 V, 50 to 60 Hz

Power Consumption

40 Watts maximum

Heat Dissipation

137 BTU/hr maximum

Maximum Current

0.5 A @ 110 VAC

0.25 A @ 240 VAC

Switch Features

Spanning Tree Protocol

Forwarding Mode

Store-and-forward

Throughput

Layer 2: wire speed

Flow Control

Full Duplex: IEEE 802.3x

Half Duplex: Back pressure

Broadcast Storm Suppression

Traffic throttled above a critical threshold

VLAN Support

Up to 255 groups; port-based or with 802.1Q VLAN tagging

Private VLAN feature

GVRP for automatic VLAN learning

Quality of Service

Four levels of priority and Weighted Round Robin Queueing; Quality of Service based on DSCP, IP Precedence/TOS, TCP/UDP port number

VDSL Bandwidth Control

Rate Limiting

Management Features

In-Band Management

Telnet, Web-based HTTP, or SNMP manager
(AccView Network Management software provided free)

Out-of-Band Management

RS-232 DB-9 console port

Software Loading

TFTP in-band or XModem out-of-band

MIB Support

MIB-II (RFC1213), Interfaces Evolution MIB (RFC 2863), Ethernet-Like MIB (RFC 2665), Bridge MIB (RFC 1493), Extended Bridge MIB: P-bridge, Q-bridge (RFC2674), RMON MIB (RFC 2819), Entity MIB (RFC 2737), RADIUS authentication client MIB (RFC 2618), Accton's private MIB

RMON Support

Groups 1, 2, 3, 9 (Statistics, History, Alarm, Event)

Additional Features

Port Trunks
Port Mirroring

Standards

IEEE 802.3 Ethernet, IEEE 802.3u Fast Ethernet,
IEEE 802.1D Spanning Tree Protocol and traffic priorities,
IEEE 802.1p priority tags, IEEE 802.1Q VLAN,
IEEE 802.3ac VLAN tagging,
IEEE 802.3x full-duplex flow control (ISO/IEC 8802-3)
SNMP (RFC 1157), RMON (RFC 1757 groups 1,2,3,9), ARP (RFC 826),
ICMP (RFC 792), IP (RFC 791, UDP (RFC 768), TCP (RFC 793),
TFTP (RFC 783), TELNET (RFC 854-859), SMI (RFC 1155), Traps (RFC1215),
HTML (RFC1866), HTTP (RFC 2068)

Compliances

CE Mark

Emissions

FCC Class A
Industry Canada Class A
EN55022 (CISPR 22) Class A
EN 61000-3-2/3
VCCI Class A

Specifications

Immunity

EN 61000-4-2/3/4/5/6/8/11

Safety

CSA/NRTL (CSA 22.2.950 & UL 1950)

EN 60950 (TÜV/GS)

CB (UEC60950)

Warranty

Limited Lifetime

VDSL Splitter

Models

VM2524

VM2548

Ports

VM2524: 1 RJ-21 Port (contains 24 VDSL lines)

VM2548: 2 RJ-21 Ports (each port contains 24 VDSL lines)

Network Interface

RJ-21 flat cable

Weight

3 kg (6 lbs 10 oz)

Size

44.0 x 35.2 x 4.4 cm (17.4 x 13.9 x 1.7 in.)

Temperature

Operating: 0 to 50 °C (32 to 122 °F)

Storage: -40 to 70 °C (-40 to 158 °F)

Humidity

Operating: 5% to 90%

AC Input

100 to 240 V, 50 to 60 Hz

CE Mark

Emissions

FCC Class A

Industry Canada Class A

EN55022 (CISPR 22) Class A

EN 61000-3-2/3

VCCI Class A

Immunity

EN 61000-4-2/3/4/5/6/8/11

Safety

CSA/NRTL (CSA 22.2.950 & UL 1950)

EN60950 (TÜV/GS)

CB (UEC60950)

Warranty

Limited Lifetime

Slide-in Modules

1000BASE-SX Extender Module

Model

VM2512A-SX-SC-M

Ports

1 1000BASE-SX SC-type port

Network Interface

SC connector, 50/125 or 62.5/125 micron multimode fiber cable

Operating Mode

Fixed at 1000 Mbps, full duplex

Auto-negotiation of flow control

Standards

IEEE 802.3z Gigabit Ethernet

1000BASE-LX Extender Module

Model

VM2512A-LX-SC-S

Ports

1 1000BASE-LX SC-type port

Network Interface

SC connector, 9/125 micron single-mode fiber cable

Operating Mode

Fixed at 1000 Mbps, full duplex

Auto-negotiation of flow control

Standards

IEEE 802.3z Gigabit Ethernet

1000BASE-T Extender Module

Model

VM2512A-1GT

Ports

1 1000BASE-T RJ-45 port

Network Interface

RJ-45 connector, 100-ohm Category 5 or 5e twisted-pair cable (using all four wire pairs)

Operating Mode

1 Gbps, full duplex, autonegotiation of speed and flow control

10/100 Mbps, full and half duplex, autonegotiation of speed, duplex mode, and flow control

Standards

IEEE 802.3ab

100BASE-FX Extender Modules

Models

VS2512A-4FX-MTRJ-M

VS2512A-4FX-MTRJ-S

VM2512A-1FX-SC-M

Ports

VS2512A-4FX-MTRJ-M and VS2512A-4FX-MTRJ-S

4 1000BASE-FX MT-RJ ports

VM2512A-1FX-SC-M

1 1000BASE-FX SC port

Network Interface

50/125 or 62.5/125 micron multimode fiber cable

9/125 micron single-mode fiber cable

Operating Mode

Fixed at 100 Mbps, full duplex

Auto-negotiation of flow control

Standards

IEEE 802.3u

10/100BASE-TX Extender Modules

Models

VS2512A-4TX

VS2512A-1TX

Ports

VS2512A-4TX

4 10/100BASE-T RJ-45 ports

VS2512A-1TX

1 10/100BASE-T RJ-45 port

Network Interface

RJ-45 connector, 100-ohm , UTP cable

10BASE-T - Categories 3, 4, or 5

100BASE-TX - Category 5

Operating Mode

10/100 Mbps, full and half duplex

Auto-negotiation of speed and flow control

Standards

IEEE 802.3

IEEE 802.3u

IEEE 802.3x

1000BASE-X GBIC Module

Model

VM2512A-1GX-GBIC

Ports

1 slot for GBIC transceivers

Network Interface

50/125 micron or 62.5/125 micron multimode fiber

9/125 micron single-mode fiber cable

Operating Mode

Fixed at 1000 Mbps, full duplex

Standards

IEEE 802.3z

Appendix D: Ordering Information

VDSL Switch-VS2512A Products and Accessories	
Product Number	Description
VS2512A	12-port VDSL switch with one media expansion slot
VS2524	24-port VDSL switch with one media expansion slot and one SFP slot
VM2524	24-port VDSL Splitter
VM2548	48-port VDSL Splitter
ES2002-TS	VDSL CPE
VS2524-1SX-SC-M	Gigabit module with one 1000BASE-SX multimode fiber port (SC connector)
VS2524-1LX-SC-S	Gigabit module with one 1000BASE-LX single-mode fiber port (SC connector)
VS2524-1GT	Gigabit module with one 1000BASE-T port (RJ-45 connector)
VS2524-1GX-GBIC	Gigabit module with one slot for GBIC transceivers
VS2512A-4TX	10/100-BASE-TX module with 4 RJ-45 ports
VS2512A-1TX	10/100-BASE-TX module with 1 RJ-45 port
VS2512A-4FX-MTRJ-M	100BASE-FX module with 4 multimode fiber ports (MT-RJ connector)
VS2512A-4FX-MTRJ-S	100BASE-FX module with 4 single-mode fiber ports (MT-RJ connector)
VS2512A-1FX-SC-M	100BASE-FX module with 1 multimode fiber ports (SC connector)

Glossary

10BASE-T

IEEE 802.3 specification for 10 Mbps Ethernet over two pairs of Category 3, 4, or 5 UTP cable.

100BASE-FX

IEEE 802.3u specification for 100 Mbps Fast Ethernet over two strands of 50/125 or 62.5/125 micron core fiber cable.

100BASE-TX

IEEE 802.3u specification for 100 Mbps Fast Ethernet over two pairs of Category 5 UTP cable.

1000BASE-LX

IEEE 802.3z specification for Gigabit Ethernet over two strands of 50/125, 62.5/125 or 9/125 micron core fiber cable.

1000BASE-LH

Gigabit Ethernet over two strands of 9/125 micron core fiber cable.

1000BASE-SX

IEEE 802.3z specification for Gigabit Ethernet over two strands of 50/125 or 62.5/125 micron core fiber cable.

1000BASE-T

IEEE 802.3ab specification for Gigabit Ethernet over 100-ohm Category 5 or 5e twisted-pair cable (using all four wire pairs).

Auto-Negotiation

Signalling method allowing each node to select its optimum operational mode (e.g., 10 Mbps or 100 Mbps and half or full duplex) based on the capabilities of the node to which it is connected.

Bandwidth

The difference between the highest and lowest frequencies available for network signals. Also synonymous with wire speed, the actual speed of the data transmission along the cable.

Collision

A condition in which packets transmitted over the cable interfere with each other. Their interference makes both signals unintelligible.

Collision Domain

Single CSMA/CD LAN segment.

Customer Premises Equipment (CPE)

Terminating equipment, such as terminals, phones, routers and routers, supplied by the phone company, installed at customer sites, and connected to the phone company network.

CSMA/CD

CSMA/CD (Carrier Sense Multiple Access/Collision Detect) is the communication method employed by Ethernet, Fast Ethernet, or Gigabit Ethernet.

End Station

A workstation, server, or other device that does not forward traffic.

Ethernet

A network communication system developed and standardized by DEC, Intel, and Xerox, using baseband transmission, CSMA/CD access, logical bus topology, and coaxial cable. The successor IEEE 802.3 standard provides for integration into the OSI model and extends the physical layer and media with repeaters and implementations that operate on fiber, thin coax and twisted-pair cable.

Fast Ethernet

A 100 Mbps network communication system based on Ethernet and the CSMA/CD access method.

Fiber to the Home (FTTH)

A network where an optical fiber runs from the service provider to the subscriber's premises or home.

Gigabit Ethernet

A 1000 Mbps network communication system based on Ethernet and the CSMA/CD access method.

Full Duplex

Transmission method that allows two network devices to transmit and receive concurrently, effectively doubling the bandwidth of that link.

IEEE

Institute of Electrical and Electronic Engineers.

IEEE 802.3

Defines carrier sense multiple access with collision detection (CSMA/CD) access method and physical layer specifications.

IEEE 802.3ab

Defines CSMA/CD access method and physical layer specifications for 1000BASE-T Fast Ethernet.

IEEE 802.3u

Defines CSMA/CD access method and physical layer specifications for 100BASE-TX Fast Ethernet.

IEEE 802.3x

Defines Ethernet frame start/stop requests and timers used for flow control on full-duplex links.

IEEE 802.3z

Defines CSMA/CD access method and physical layer specifications for 1000BASE Gigabit Ethernet.

LAN Segment

Separate LAN or collision domain.

LED

Light emitting diode used for monitoring a device or network condition.

Local Area Network (LAN)

A group of interconnected computer and support devices.

Main Distribution Frame (MDF)

The termination equipment where outside telephone lines connect to a building or site.

Media Access Control (MAC)

A portion of the networking protocol that governs access to the transmission medium, facilitating the exchange of data between network nodes.

Multiple Tenant Units (MTU)

A building that contains more than a single tenant, such as an apartment block, office complex, or hotel.

MIB

An acronym for Management Information Base. It is a set of database objects that contains information about the device.

Network Diameter

Wire distance between two end stations in the same collision domain.

Private Branch Exchange (PBX)

A telephone exchange local to a particular organisation who use, rather than provide, telephone services.

POTS

Plain Old Telephone Service.

Redundant Power Unit (RPU)

A backup power supply that automatically takes over in case the primary power supply should fail.

RJ-45 Connector

A connector for twisted-pair wiring.

Splitter

A filter to separate DSL signals from POTS signals to prevent mutual interference.

Switched Ports

Ports that are on separate collision domains or LAN segments.

Transmission Control Protocol/Internet Protocol (TCP/IP)

Protocol suite that includes TCP as the primary transport protocol, and IP as the network layer protocol.

UTP

Unshielded twisted-pair cable.

VDSL

Very high data rate Digital Subscriber Line: A family of digital telecommunications protocols designed to allow high speed data communication at data rates from 12.9 to 52.8 Mbps with corresponding maximum reach ranging from 4500 feet to 1000 feet of 24 gauge twisted pair cable over the existing copper telephone lines.

Virtual LAN (VLAN)

A Virtual LAN is a collection of network nodes that share the same collision domain regardless of their physical location or connection point in the network. A VLAN serves as a logical workgroup with no physical barriers, allowing users to share information and resources as though located on the same LAN.

Index

Numerics

- 1000BASE-LX connections 4-3
- 1000BASE-SX connections 4-3
- 1000BASE-X connections 4-3
- 100BASE-FX connections 4-3
- 100BASE-LH connections 4-3
- 100BASE-LX connections 4-3

A

- accessories, ordering D-1
- adhesive feet, attaching 3-4
- applications
 - Internet connections 2-2
 - VLAN connections 2-3

B

- brackets, attaching 3-3
- broadcast storm control 1-3
- buffer size C-1

C

- cable
 - specifications B-1
- cleaning fiber terminators 4-4
- compliances
 - EMC C-3, C-4
 - safety C-4, C-5
- console port 1-3
 - pin assignments B-5
- contents of package 3-2
- cooling problems A-1
- cord sets, international 3-7

D

- desktop mounting 3-4

E

- equipment checklist 3-2
- Extender C-7

F

- features C-2
 - management 1-12, 1-13
 - system 1-12
- fiber cables 4-3
- front panel of splitter 1-6
- front panel of switch 1-5, 1-6

- full-duplex connectivity 2-1

G

- GVRP 1-3

I

- indicators, LED 1-7
- installation
 - desktop or shelf mounting 3-4
 - installing a GBIC transceiver 3-6
 - installing optional modules 3-3
 - port connections 4-1
 - problems A-2
 - rack mounting 3-3
 - wiring closet connections 4-2

K

- key features 1-12

L

- laser safety 4-4
- LED indicators
 - Link 1-4, 1-7
 - Power 1-7
 - problems A-1
- limited warranty C-4, C-5

M

- management
 - agent 1-3
 - features 1-13, C-3
 - out-of-band 1-3
 - SNMP 1-3
 - Web-based 1-3
- MIB support C-3
- modules
 - 10/100BASE-TX 1-4, 1-9, 1-10, C-7
 - 1000BASE-LX 1-4, 1-8, C-5
 - 1000BASE-SX 1-4, 1-8, C-5
 - 1000BASE-T 1-4, 1-9, C-6, C-7
 - 1000BASE-X GBIC 1-4, 1-8
 - 100BASE-FX 1-4, 1-10, C-6
- mounting the switch
 - in a rack 3-3
 - on a desktop or shelf 3-4
- MT-RJ port connections 4-3
- multicast switching 1-3

Index

IGMP Snooping 1-3
multimode and single-mode fiber optic
cables 4-3
multimode fiber optic cables 4-3

N

network
connections 4-1, 4-3
null-modem cable 1-3

O

optional
modules, installation 3-3
ordering information D-1
out-of-band management 1-3

P

package contents 3-2
pin assignment
RJ21 B-4
pin assignments B-1
1000BASE-T B-3
10BASE-T/100BASE-TX B-2
console port B-5
DB-9 B-5
port saturation 1-3
port-based VLANs 2-3
ports, connecting to 4-1, 4-3
power, connecting to 3-7
priority queues 1-4
problems, troubleshooting A-1

Q

QoS 1-3

R

rack mounting 3-3
rear panel of splitter 1-6
rear panel of switch 1-5, 1-6
Remote 2-2
RJ-45 ports
connections 4-1
pinouts B-3
RMON 1-3
routing applications 2-4
RS-232 port 1-3
rubber foot pads, attaching 3-4

S

sample applications

Internet connections 2-2
remote connections 2-2
SC port connections 4-3
screws for rack mounting 3-2
SC-ST Converter 4-3, 4-4
serial port 1-3
site selection 3-1
SNMP agent 1-3
specifications
10/100BASE-TX module C-7
1000BASE-LX C-5
1000BASE-SX C-5
1000BASE-T module C-6, C-7
1000BASE-X GBIC module C-7
100BASE-FX module C-6
compliances C-3
environmental C-1, C-4
management features C-3
physical C-1
slide-in module C-5
VDSL C-1
VDSL splitter C-4
VDSL switch C-1
standards
compliance C-3
IEEE C-3
status LEDs 1-7
switch architecture 1-2
switching, introduction to 2-1

T

tags
priority 1-4
VLAN 2-3
Telnet A-2
traffic priority 1-4
troubleshooting
in-band access A-2
power and cooling problems A-1
switch indicators A-1
twisted-pair connections 4-1

V

VLANs 1-3, 2-3
tagging 2-3

W

warranty C-4, C-5

Index-2

Web-based management 1-3

Weighted Round Robin Queuing 1-4

VS2412A
VM2524, VM2548
E072002-R01
150000010100A

Free Manuals Download Website

<http://myh66.com>

<http://usermanuals.us>

<http://www.somanuals.com>

<http://www.4manuals.cc>

<http://www.manual-lib.com>

<http://www.404manual.com>

<http://www.luxmanual.com>

<http://aubethermostatmanual.com>

Golf course search by state

<http://golfingnear.com>

Email search by domain

<http://emailbydomain.com>

Auto manuals search

<http://auto.somanuals.com>

TV manuals search

<http://tv.somanuals.com>