

# Mercury Hub User Guide



**PR0018 (Mains Powered)**  
**PR0017 (Mercury Controller Powered)**



Ensure that all power is switched off before installing or maintaining this product

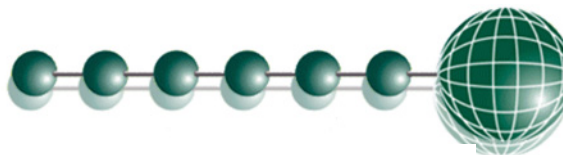

**Table of Contents:**

**THE MERCURY HUB..... 3**

**Description ..... 3**

**Front View ..... 3**

**Rear View ..... 3**

**Top View ..... 4**

**Connection to Mercury Controllers: ..... 4**

    RS232 Lead Lengths ..... 4

**Connection to other IP equipment..... 4**

**Connection to another Mercury Hub or Other Ethernet Hub/switch ..... 4**

**Connection to a Data Manager/Director ..... 4**

**10 Base T connectors ..... 5**

**Network ID ..... 5**

**ID for equipment with rotary switch's. .... 5**

**SPECIFICATION ..... 6**

**Power requirements: ..... 6**

**Mounting..... 6**

**RS232 Cable Lengths ..... 6**

**Ethernet Cable lengths ..... 6**



Ensure that all power is switched off before installing or maintaining this product

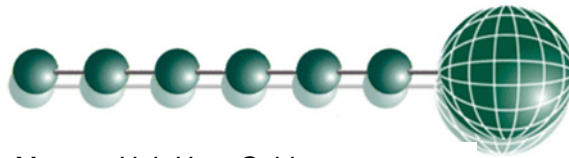

## The Mercury Hub

From Resource Data Management

### Description

The Mercury Hub is a device that allows up to 10 RDM controllers to be connected to an IP network, with out the need for individual IP Futura modules. The Hub can be mains powered, or powered from 2 connected Mercury controllers. There are 10 RS232 connections for linking to Mercury controllers, 2 standard ethernet hub (10baseT) connections for other network devices and a dedicated ethernet Uplink port.

### Front View

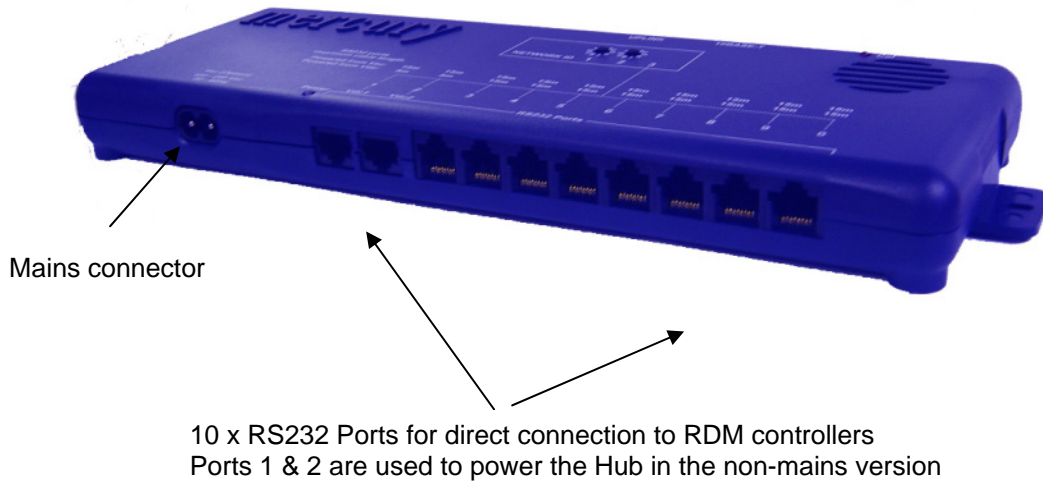

### Rear View

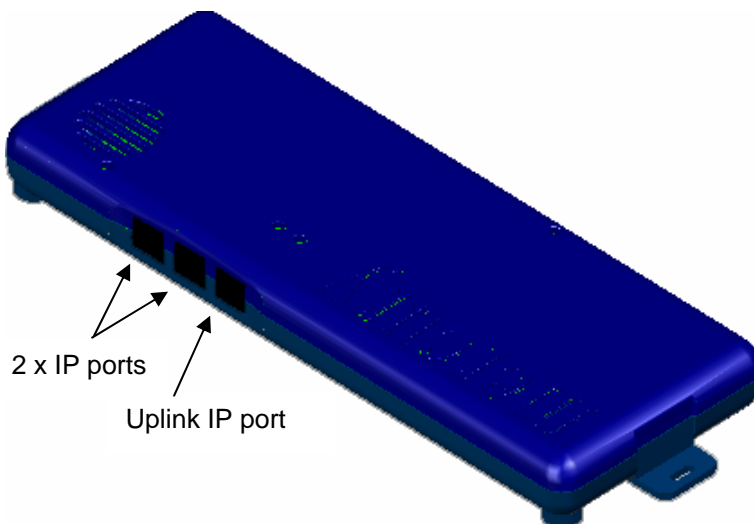

Ensure that all power is switched off before installing or maintaining this product

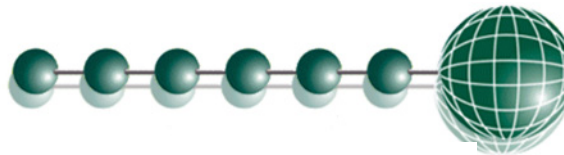

## Top View

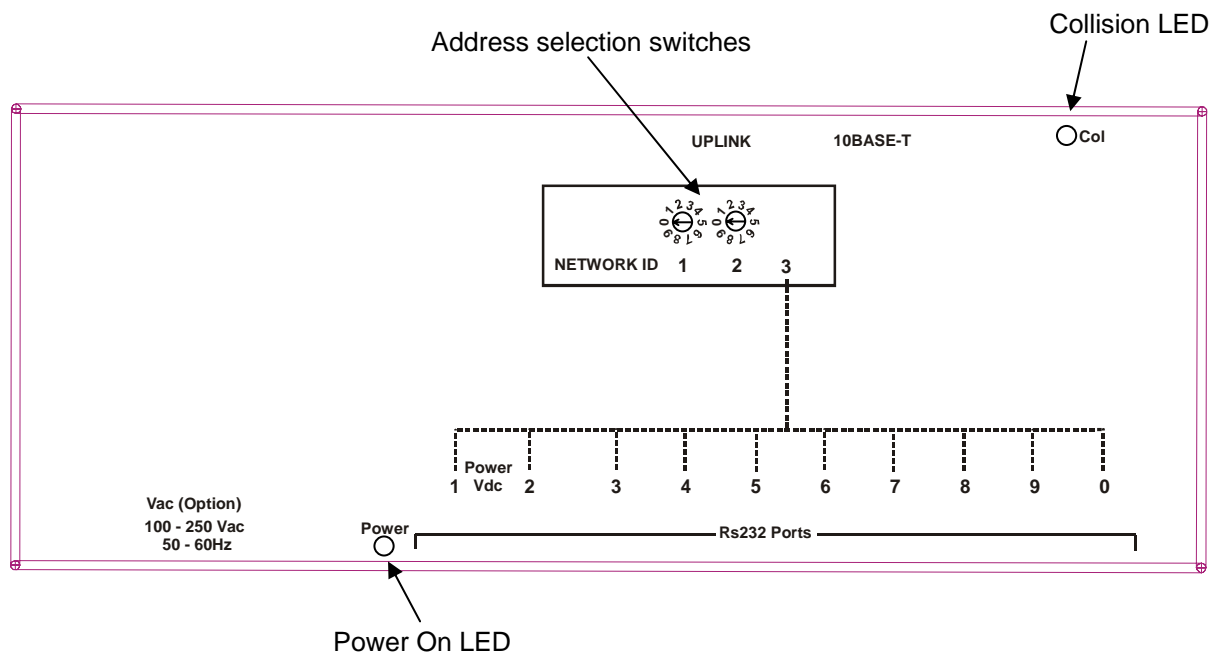

### Connection to Mercury Controllers:

Using a standard CAT5 patch lead, connect the serial output of the RDM Controller to one of the RS232 ports of the Mercury Hub.

### RS232 Lead Lengths

For mains powered hubs, patch lead maximum length must not exceed 15 metres. (ports 1 - 10)  
For Mercury powered hubs, inputs 1 and 2 patch leads must not exceed 5 metres, ports 3 - 10 must not exceed 15 metres.

The 3-character address that will be seen on the system front end is determined by the position of the two Network ID rotary switches and the port the controller has been connected to.

### Connection to other IP equipment

Use a standard CAT5 patch lead to connect other IP equipment to the Mercury Hub (such as a Futura IP module) into the 10Base T ports 1 or 2.

### Connection to another Mercury Hub or Other Ethernet Hub/switch

Use a standard CAT5 patch lead from the Uplink port into a standard IP port on the next Hub.

### Connection to a Data Manager/Director

Use a standard CAT5 patch lead and connect the Data Manager or Data Director to one of the two 10 Base T ports.



Ensure that all power is switched off before installing or maintaining this product

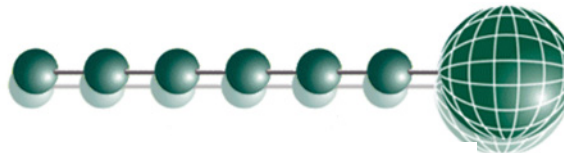

### 10 Base T connectors

The three 10Base T connectors have 2 leds on them: The green LED; when static, indicates that the connection to the device is good, the green LED then flickers when data is being transmitted. The amber LED indicates there is an error or fault on that channel.



### Network ID

The 3-character network ID is made up from the positions of the 2 rotary switches and the RS232 connector number. We recommend that the 2 rotary switches are set to the Bay number and that the case sections are plugged into their corresponding RS232 port numbers.

E.g. Bay 10 case 2:

The 2 rotary switches set to "1" and "0", controller plugged into port 2. The ID then is seen as "102" at the system front end.

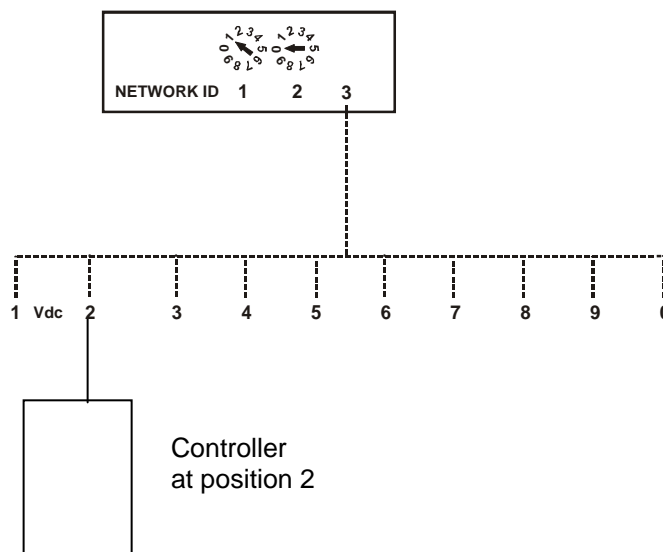

Note that case number 10 would plug into RS232 port 0 (right most port) and come through as "100".

### ID for equipment with rotary switch's.

For RDM products that use the 3 rotary switch's for the network ID (such as Powertrays), the ID will follow what is set on the controller local switch's and **NOT** the port position on the Hub.



Ensure that all power is switched off before installing or maintaining this product

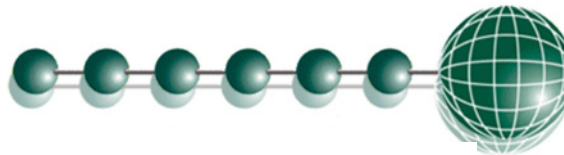

## Specification

### Power requirements:

Supply Voltage Range:	100 - 240 Vac $\pm$ 10% (Mains version)
Supply Frequency:	50 - 60 Hz (Mains version)
	OR
Maximum supply current:	2 x Mercury Controllers connected to ports 1 and 2 500 mAmps
Typical supply current:	<100 mAmps
Operating temperature range:	+5°C to +50°C
Operating Humidity:	80% maximum
Storage temperature range:	-20°C to +65°C
Environmental:	Indoor use at altitudes up to 2000m, Pollution Degree 1, Installation Category II. Voltage fluctuations not to exceed $\pm$ 10% of nominal voltage
Size:	300mm (L) x 35mm (H) x 110mm (W)
Weight:	300 Grams
Safety:	EN61010
EMC:	EN61326; 1997 +Amdt. A1; 1998
Ventilation:	There is no requirement for forced cooling ventilation
Class 2 Insulation:	<b>No</b> protective Earth is required and <b>none</b> should be fitted.

The host equipment must provide a suitable external over-current protection device such as: -

Fuse:	1A 240 Vac Antisurge (T) HRC conforming to IEC 60127
Or MCB:	1A, 240 VAC Type C conforming to BS EN 60898

### Mounting

There is a fixing lug at each end of the Hub, with hole centres 317 mm apart. Use typically Number 6 x 1" Pan head screw with 6mm washer, torque down to 1.5 Newton metres.

### RS232 Cable Lengths

Port number	Main Powered Hub	Mercury Powered Hub
1	15 metres	5 metres
2	15 metres	5 metres
3	15 metres	15 metres
4	15 metres	15 metres
5	15 metres	15 metres
6	15 metres	15 metres
7	15 metres	15 metres
8	15 metres	15 metres
9	15 metres	15 metres
0	15 metres	15 metres

### Ethernet Cable lengths

Port number	Main Powered Hub	Mercury Powered Hub
1	Refer to Cat5 standard	Refer to Cat5 standard
2	Refer to Cat5 standard	Refer to Cat5 standard
Uplink	Refer to Cat5 standard	Refer to Cat5 standard



Ensure that all power is switched off before installing or maintaining this product

## Free Manuals Download Website

<http://myh66.com>

<http://usermanuals.us>

<http://www.somanuals.com>

<http://www.4manuals.cc>

<http://www.manual-lib.com>

<http://www.404manual.com>

<http://www.luxmanual.com>

<http://aubethermostatmanual.com>

Golf course search by state

<http://golfingnear.com>

Email search by domain

<http://emailbydomain.com>

Auto manuals search

<http://auto.somanuals.com>

TV manuals search

<http://tv.somanuals.com>