

Hot Food Drop-In Wells

Electric



100-HW/D443



300-HW/D4



300-HW/D443



500-HW/D4

Pans not included

Models:

100-HW/D4
100-HW/D6
100-HW/D443
100-HW/D643
200-HW/D4
200-HW/D6
300-HW/D4
300-HW/D443
300-HW/D643
300-HW/D6
400-HW/D4
400-HW/D6
500-HW/D4
500-HW/D6

• **INSTALLATION**

• **OPERATION**

• **MAINTENANCE**



W164 N9221 Water Street • P.O. Box 450 • Menomonee Falls, Wisconsin 53052-0450 USA
PHONE: 262.251.3800 • 800.558.8744 USA/CANADA FAX: 262.251.7067 • 800.329.8744 U.S.A. ONLY
www.alto-shaam.com

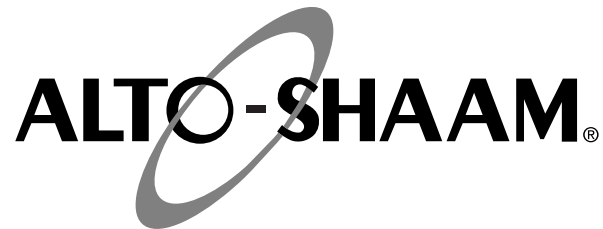

Delivery	1
Unpacking	1
Safety Procedures and Precautions.	2

Installation

Installation Requirements	3
Leveling	3
Options & Accessories	3
Rough Cut Counter Top Openings	3
Electrical Connection	4
Electrical Specifications	5
Remote Control Mounting Instructions	6
Dimensions.	7-9

Operating Instructions

Operating Instructions.	10
General Holding Guidelines	11

Care and Cleaning

Cleaning and Preventive Maintenance	12
Protecting Stainless Steel Surfaces	12
Cleaning Agents	12
Cleaning Materials	12
Care and Cleaning	13
Sanitation	14

Service

Troubleshooting Guide	15
Service Parts List & Diagrams	15

Wire Diagrams

Always refer to the wire diagram(s) included with the unit for most current version.

Warranty

Transportation Damage and Claims	Back Cover
Limited Warranty	Back Cover

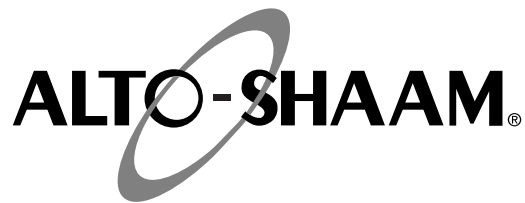

DELIVERY

This Alto-Shaam appliance has been thoroughly tested and inspected to ensure only the highest quality unit is provided. Upon receipt, check for any possible shipping damage and report it at once to the delivering carrier. *See Transportation Damage and Claims section located in this manual.*

This appliance, complete with unattached items and accessories, may have been delivered in one or more packages. Check to ensure that all standard items and options have been received with each model as ordered.

Save all the information and instructions packed with the appliance. Complete and return the warranty card to the factory as soon as possible to ensure prompt service in the event of a warranty parts and labor claim.

This manual must be read and understood by all people using or installing the equipment model. Contact the Alto-Shaam Tech Team Service Department if you have any questions concerning installation, operation, or maintenance.

NOTE: All claims for warranty must include the full model number and serial number of the unit.

UNPACKING

1. Carefully remove the appliance from the carton or crate.

NOTE: Do not discard the carton and other packaging material until you have inspected the unit for hidden damage and tested it for proper operation.

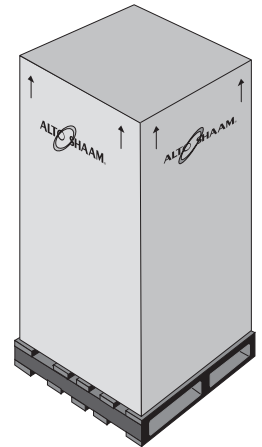

2. Read all instructions in this manual carefully before initiating the installation of this appliance.

DO NOT DISCARD THIS MANUAL.

This manual is considered to be part of the appliance and is to be provided to the owner or manager of the business or to the person responsible for training operators. *Additional manuals are available from the Alto-Shaam Tech Team Service Department.*

3. Remove all protective plastic film, packaging materials, and accessories from the appliance before connecting electrical power. Store any accessories in a convenient place for future use.

SAFETY PROCEDURES AND PRECAUTIONS

Knowledge of proper procedures is essential to the safe operation of electrically and/or gas energized equipment. In accordance with generally accepted product safety labeling guidelines for potential hazards, the following signal words and symbols may be used throughout this manual.

DANGER



Used to indicate the presence of a hazard that **WILL** cause severe personal injury, death, or substantial property damage if the warning included with this symbol is ignored.

WARNING



Used to indicate the presence of a hazard that **CAN** cause personal injury, possible death, or major property damage if the warning included with this symbol is ignored.

CAUTION



Used to indicate the presence of a hazard that can or will cause minor or moderate personal injury or property damage if the warning included with this symbol is ignored.

CAUTION

Used to indicate the presence of a hazard that can or will cause minor personal injury, property damage, or a potential unsafe practice if the warning included with this symbol is ignored.

NOTE: Used to notify personnel of installation, operation, or maintenance information that is important but not hazard related.

1. This appliance is intended to cook, hold or process foods for the purpose of human consumption. No other use for this appliance is authorized or recommended.
2. This appliance is intended for use in commercial establishments where all operators are familiar with the purpose, limitations, and associated hazards of this appliance. Operating instructions and warnings must be read and understood by all operators and users.
3. Any troubleshooting guides, component views, and parts lists included in this manual are for general reference only and are intended for use by qualified technical personnel.
4. This manual should be considered a permanent part of this appliance. This manual and all supplied instructions, diagrams, schematics, parts lists, notices, and labels must remain with the appliance if the item is sold or moved to another location.

NOTE



For equipment delivered for use in any location regulated by the following directive:

DO NOT DISPOSE OF ELECTRICAL OR ELECTRONIC EQUIPMENT WITH OTHER MUNICIPAL WASTE.

INSTALLATION

DANGER



IMPROPER INSTALLATION, ALTERATION, ADJUSTMENT, SERVICE, OR MAINTENANCE COULD RESULT IN SEVERE INJURY, DEATH, OR CAUSE PROPERTY DAMAGE.

READ THE INSTALLATION, OPERATING AND MAINTENANCE INSTRUCTIONS THOROUGHLY BEFORE INSTALLING OR SERVICING THIS EQUIPMENT.

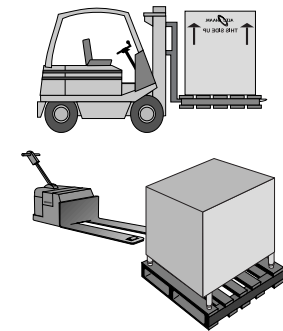

The Alto-Shaam appliance must be installed in a location that will permit the unit to function for its intended purpose and to allow for proper cleaning, and maintenance.

1. The appliance must be installed on a stable and level surface. A non-combustible, heat resistant surface is highly recommended.
2. **DO NOT** install this appliance in any area where it may be affected by any adverse conditions such as steam, grease, dripping water, high temperatures, etc.
3. The outer walls of the hot well can reach 200°F (93°C) to 260°F (127°C). Verify countertop material temperature rating with manufacturer before installing to ensure counter can withstand heat.

CAUTION



TO PREVENT PERSONAL INJURY, USE CAUTION WHEN MOVING OR LEVELING THIS APPLIANCE.

LEVELING

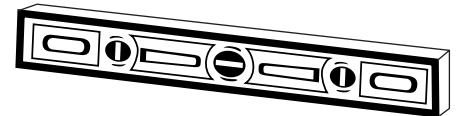

The heated well should be leveled before the electrical supply is connected. Level the appliance from side-to-side and front-to-back with the use of a spirit level. For appliances installed on a mobile stand, it is important that the floor surface be level due to the probability of frequent repositioning.

NOTE

It is important to apply a food grade silicone underneath the decor flange to seal flange to the countertop.

OPTIONS AND ACCESSORIES

PAN DIVIDER BARS

• HW SERIES FULL-SIZE	16019
• 300-HW/D443 & D643 FULL-SIZE	1011928
• HW SERIES HALF-SIZE / THIRD-SIZE	11318

ROUGH CUT COUNTER TOP OPENING

MODEL 100-HW/D4 or D6 ONE PAN:	14-1/4" x 22-3/4" (362mm x 578mm)
MODEL 100-HW/D443 or D643 ONE & ONE-THIRD PAN:	14-1/4" x 29-3/4" (362mm x 756mm)
MODEL 200-HW/D4 or D6 TWO PAN:	22-3/4" x 27" (686mm x 563mm)
MODEL 300-HW/D4 or D6 THREE PAN:	40" x 22-3/4" (1016mm x 578mm)
MODEL 300-HW/D443 or D643 THREE & ONE-THIRD PAN:	40" x 29-3/4" (1016mm x 756mm)
MODEL 400-HW/D4 or D6 FOUR PAN:	53-1/8" x 22-3/4" (1350mm x 578mm)
MODEL 500-HW/D4 or D6 FIVE PAN:	66-1/4" x 22-3/4" (1683mm x 578mm)

INSTALLATION



ELECTRICAL CONNECTION

1. An identification tag is permanently mounted on the appliance.
2. This appliance is equipped with a three-prong grounding plug. For your protection against shock hazard this appliance should be plugged directly into a properly grounded three-prong receptacle. Do not cut or remove the grounding prong from this plug. Plug the unit into a properly grounded receptacle **ONLY**, positioning the unit so that the plug is easily accessible in case of an emergency. Arcing will occur when connecting or disconnecting the unit unless all controls are in the "OFF" position.
3. Proper receptacle or outlet configuration or permanent wiring for this unit must be installed by a licensed electrician in accordance with applicable local electrical codes.



For CE approved units: To prevent an electrical shock hazard between the appliance and other appliances or metal parts in close vicinity, an equalization-bonding stud is provided. An equalization bonding lead must be connected to this stud and the other appliances / metal parts to provide sufficient protection against potential difference. The terminal is marked with the following symbol.



NOTE: CE approved appliances must be connected to an electrical circuit that is protected by an external GFCI outlet.

 DANGER	
	ENSURE POWER SOURCE MATCHES VOLTAGE STAMPED ON APPLIANCE NAMEPLATE.

 DANGER	
	ELECTRICAL CONNECTIONS MUST BE MADE BY A QUALIFIED SERVICE TECHNICIAN IN ACCORDANCE WITH APPLICABLE ELECTRICAL CODES.



DANGER	
	To avoid electrical shock, this appliance MUST be adequately grounded in accordance with local electrical codes or, in the absence of local codes, with the current edition of the National Electrical Code ANSI/NFPA No. 70. In Canada, all electrical connections are to be made in accordance with CSA C22.1, Canadian Electrical Code Part 1 or local codes.
	



INSTALLATION



ELECTRICAL SPECIFICATIONS



Refer to wire diagram sent with unit.

ELECTRICAL • 100-HW							
VOLTAGE	PHASE	CYCLE/HZ	AMPS	kW		PLUG CONFIGURATION	
120 (AGCY)	1	60	4.8	0.6		NEMA 5-15P	15A-125V PLUG

ELECTRICAL • 200-HW							
VOLTAGE	PHASE	CYCLE/HZ	AMPS	kW		PLUG CONFIGURATION	
120 (AGCY)	1	60	10.6	1.3		NEMA 5-15P	15A-125V PLUG
240 (AGCY)	1	60	5.3	1.3		NEMA 6-15P	15A-250V PLUG
at 208	1	60	4.6	1.0			
at 240	1	60	5.3	1.3			
230 (AGCY)	1	50/60	5.1	1.2		CEE 7/7	220-230V PLUG

ELECTRICAL • 300-HW							
VOLTAGE	PHASE	CYCLE/HZ	AMPS	kW		PLUG CONFIGURATION	
120 (AGCY)	1	60	21.4	2.6		NEMA L5-30P	30A-125V PLUG
240 (AGCY)	1	60	10.7	2.6		NEMA 6-15P	15A-250V PLUG
at 208	1	60	9.2	1.9			
at 240	1	60	10.7	2.6			
230 (AGCY)	1	50/60	10.3	2.4		CEE 7/7	220-230V PLUG

ELECTRICAL • 400-HW							
VOLTAGE	PHASE	CYCLE/HZ	AMPS	kW		PLUG CONFIGURATION	
120 (AGCY)	1	60	19.7	2.4		NEMA L5-30P	30A-125V PLUG
240 (AGCY)	1	60	9.9	2.4		NEMA 6-15P	15A-250V PLUG
at 208	1	60	8.5	1.8			
at 240	1	60	9.8	2.4			
230 (AGCY)	1	50/60	9.5	2.2		CEE 7/7	220-230V PLUG

ELECTRICAL • 500-HW							
VOLTAGE	PHASE	CYCLE/HZ	AMPS	kW		PLUG CONFIGURATION	
120	1	60	23.6	2.8		NEMA L5-30P	30A-125V PLUG
240 (AGCY)	1	60	11.8	2.8		NEMA 6-15P	15A-250V PLUG
at 208	1	60	10.2	2.1			
at 240	1	60	11.8	2.8			
230	1	50/60	11.3	2.6		CEE 7/7	220-230V PLUG

INSTALLATION

REMOTE CONTROL HOUSING MOUNTING INSTRUCTIONS

100-, 200- & 300-HW

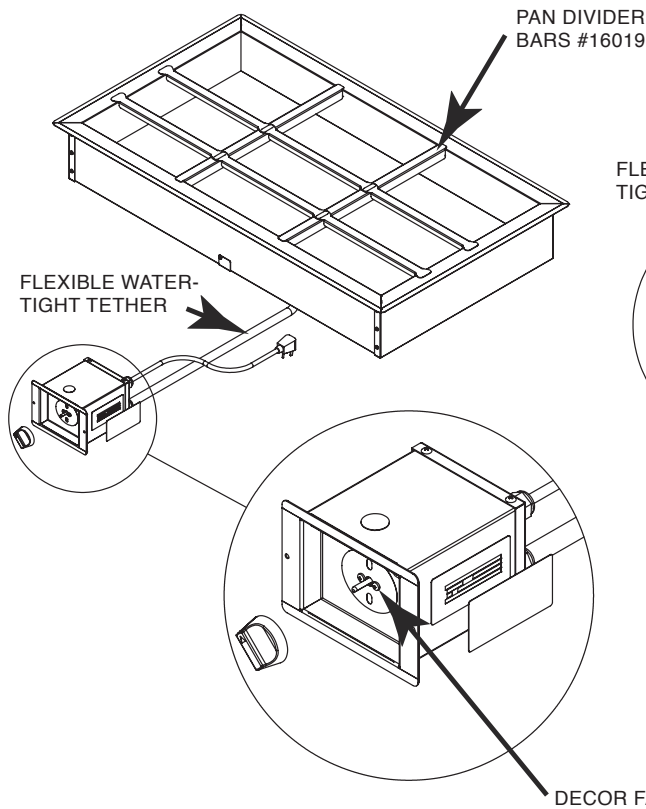

400- & 500-HW

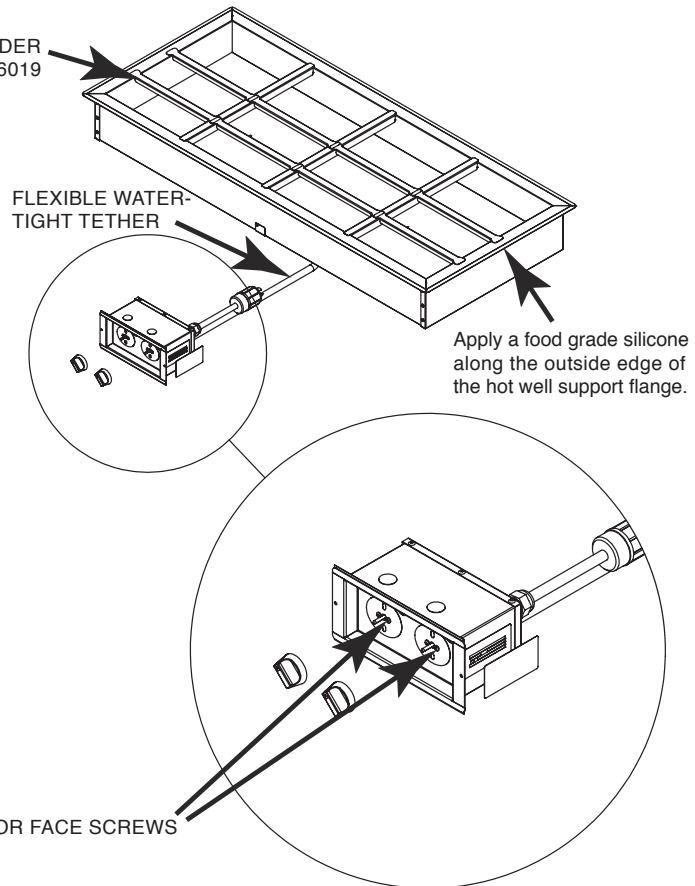

1. **100-HW, 200-HW or 300-HW:** Cut a 5-1/4" x 4-1/2" (133mm x 114mm) opening in the location where the control is to be positioned.
400-HW or 500-HW: Cut a 9-1/8" x 4-1/2" (232mm x 114mm) opening in the location where the control is to be positioned.
2. Thoroughly clean and dry the mounting surface around the control cut-out opening on which the décor face will be applied.
NOTE: The control face will not properly adhere to an unclean surface.
3. Remove the knob(s) from the thermostat(s) by pulling knob away from control. Remove the décor face from the unit by removing one screw located to the right of the thermostat. (Two screws for double pod.) See diagram above.
4. Route control housing through opening cut in step 1. Secure the décor face housing to the control housing using the screw(s) removed in step 3.
5. Remove the protective film from the mounting tape on the inside flanges of the décor face and apply the décor face to the mounting surface. Two holes are provided in décor face for additional mounting screws (not provided) if desired.
6. Reattach the knob(s) to the thermostat(s).

INSTALLATION

DIMENSIONS • CAPACITY

100-HW/D4 & 100-HW/D6

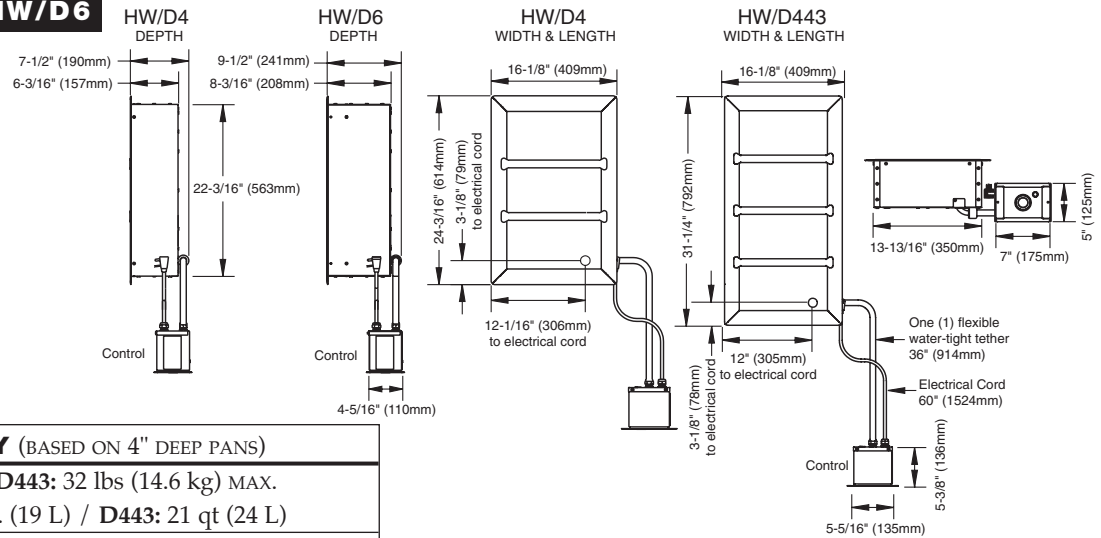

PRODUCT PAN CAPACITY (BASED ON 4" DEEP PANS)

D4: 24 lb (10.8 kg) / **D443:** 32 lbs (14.6 kg) MAX.

MAX. VOLUME: **D4:** 15 qt. (19 L) / **D443:** 21 qt (24 L)

FULL-SIZE PANS*: One (1) 12" x 20" x 4"
 GN 1/1 (325mm x 530mm x 102mm)

HALF-SIZE PANS*: Two (2) 12" x 10" x 4"
 GN 1/2 (325mm x 265mm x 102mm)

THIRD-SIZE PANS*: **D4:** Three (3) / **D443:** Four (4) 12" x 6" x 4"
 GN 1/3 (325mm x 176mm x 102mm)

*WILL ALSO ACCEPT 2-1/2" (65mm) DEEP PANS; D6 UNITS WILL ACCEPT 6" (153mm) DEEP PANS

200-HW/D4 & 200-HW/D6

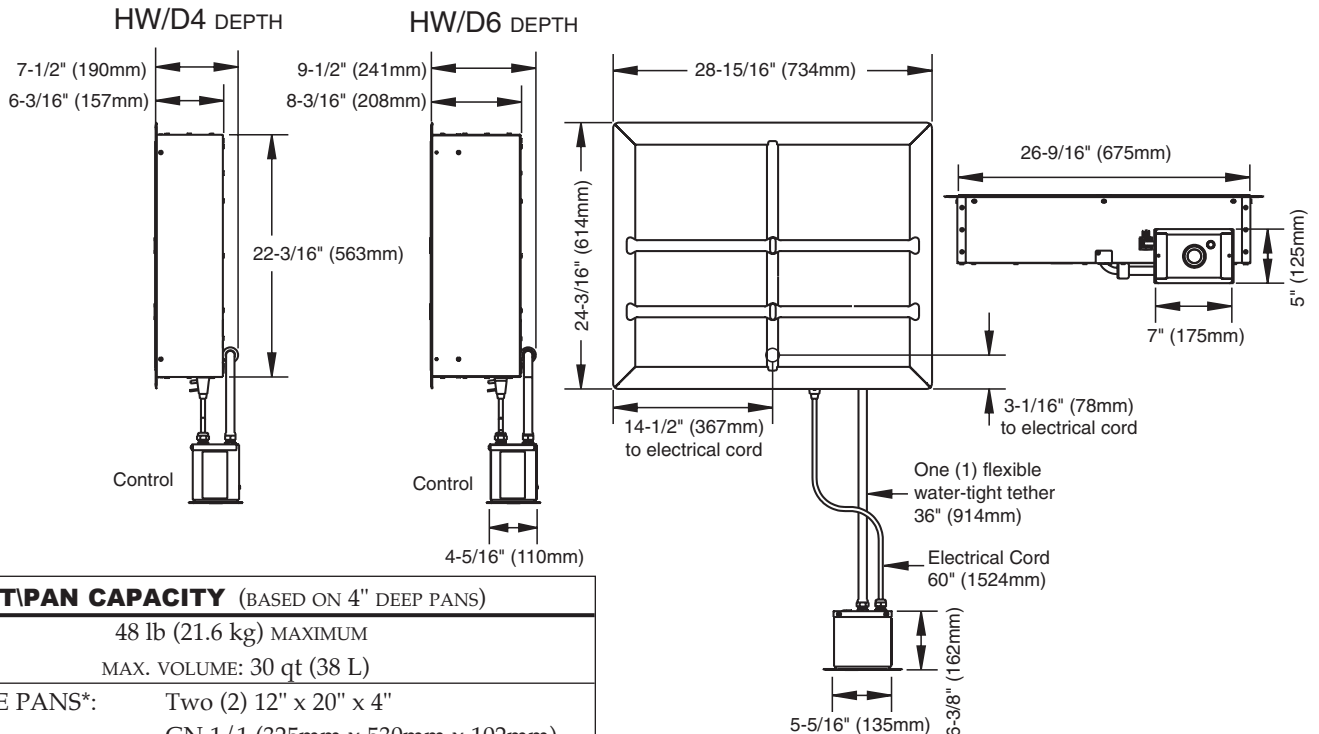

PRODUCT PAN CAPACITY (BASED ON 4" DEEP PANS)

48 lb (21.6 kg) MAXIMUM

MAX. VOLUME: 30 qt (38 L)

FULL-SIZE PANS*: Two (2) 12" x 20" x 4"
 GN 1/1 (325mm x 530mm x 102mm)

HALF-SIZE PANS*: Four (4) 12" x 10" x 4"
 GN 1/2 (325mm x 265mm x 102mm)

THIRD-SIZE PANS*: Six (6) 12" x 6" x 4"
 GN 1/3 (325mm x 176mm x 102mm)

*WILL ALSO ACCEPT 2-1/2" (65mm) DEEP PANS; D6 UNITS WILL ACCEPT 6" (153mm) DEEP PANS

INSTALLATION

DIMENSIONS • CAPACITY

300-HW/D4, D6, D443, D643

LENGTH
(ALL MODELS)

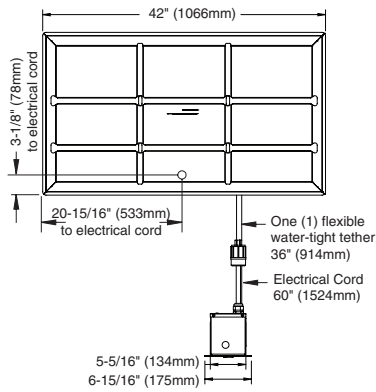

300-HW/D4
WIDTH & DEPTH

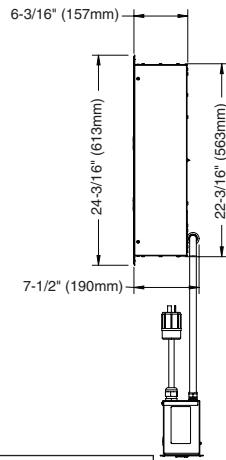

300-HW/D6
WIDTH & DEPTH

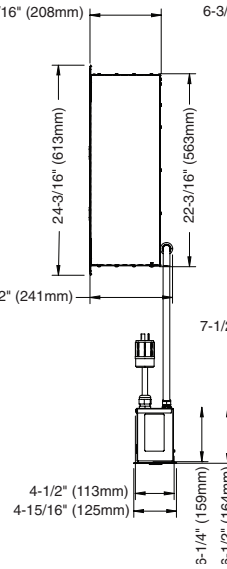

300-HW/D443
WIDTH & DEPTH

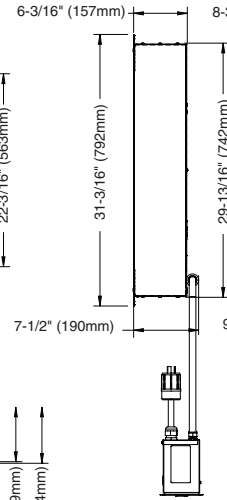

300-HW/D643
WIDTH & DEPTH

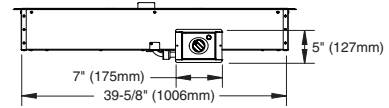
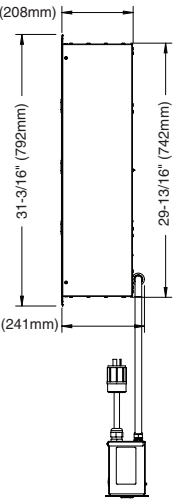

PRODUCT PAN CAPACITY (BASED ON 4" DEEP PANS)

D4: 62 lb (30 kg) / **D443:** 96 lb (44 kg) MAX.

MAX. VOLUME: **D4:** 45 qt (57 L) / **D443:** 60 qt (76 L)

FULL-SIZE PANS*: Three (3) 12" x 20" x 4"
GN 1/1 (325mm x 530mm x 102mm)

HALF-SIZE PANS*: Six (6) 12" x 10" x 4"
GN 1/2 (325mm x 265mm x 102mm)

THIRD-SIZE PANS*: **D4:** Nine (9) / **D443:** Twelve (12) 12" x 6" x 4"
GN 1/3 (325mm x 176mm x 102mm)

*WILL ALSO ACCEPT 2-1/2" (65mm) DEEP PANS; D6 UNITS WILL ACCEPT 6" (153mm) DEEP PANS

400-HW/D4 & 400-HW/D6

HW/D4 DEPTH

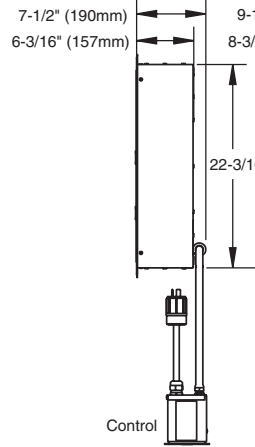

HW/D6 DEPTH

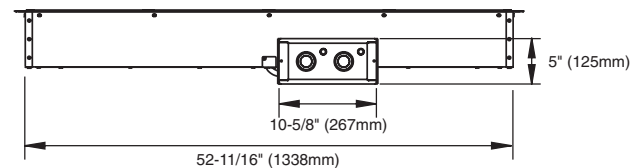
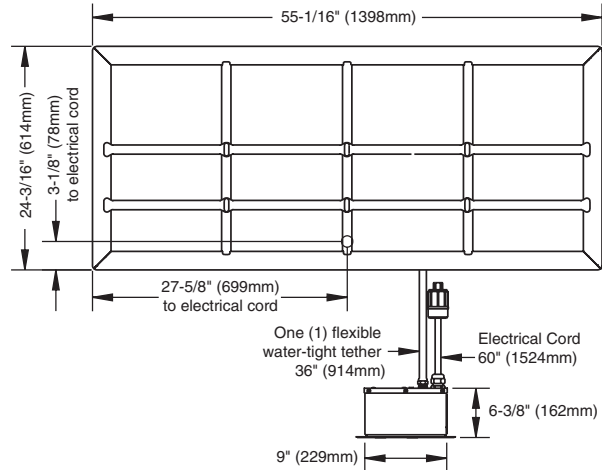
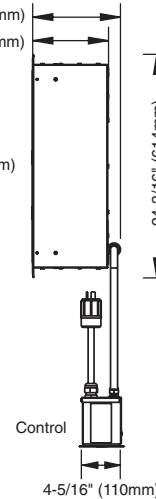

PRODUCT PAN CAPACITY (BASED ON 4" DEEP PANS)

96 lb (44 kg) MAXIMUM

MAX. VOLUME: 60 qt (76 L)

FULL-SIZE PANS*: Four (4) 12" x 20" x 4"
GN 1/1 (325mm x 530mm x 102mm)

HALF-SIZE PANS*: Eight (8) 12" x 10" x 4"
GN 1/2 (325mm x 265mm x 102mm)

THIRD-SIZE PANS*: Twelve (12) 12" x 6" x 4"
GN 1/3 (325mm x 176mm x 102mm)

*WILL ALSO ACCEPT 2-1/2" (65mm) DEEP PANS; D6 UNITS WILL ACCEPT 6" (153mm) DEEP PANS

INSTALLATION

DIMENSIONS • CAPACITY

500-HW/D4 & 500-HW/D6

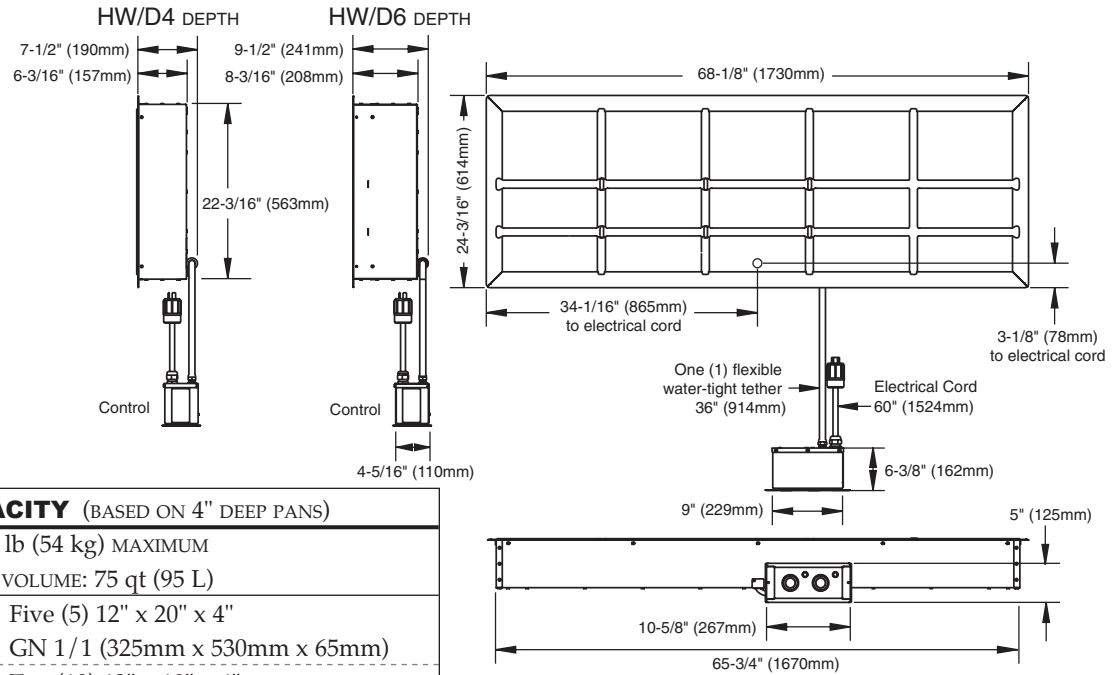

PRODUCT PAN CAPACITY (BASED ON 4" DEEP PANS)

120 lb (54 kg) MAXIMUM

MAX. VOLUME: 75 qt (95 L)

FULL-SIZE PANS*:	Five (5) 12" x 20" x 4" GN 1/1 (325mm x 530mm x 65mm)
HALF-SIZE PANS*:	Ten (10) 12" x 10" x 4" GN 1/2 (325mm x 265mm x 65mm)
THIRD-SIZE PANS*:	Fifteen (15) 12" x 6" x 4" GN 1/3 (325mm x 176mm x 65mm)

*WILL ALSO ACCEPT 2-1/2" (65mm) DEEP PANS; D6 UNITS WILL ACCEPT 6" (153mm) DEEP PANS

OPERATING INSTRUCTIONS

1. DO NOT ADD WATER TO HOT WELL

Halo Heat® hot wells maintain a constant and gentle temperature. **Adding water is not recommended** since water will accelerate the deterioration of the product and may damage the unit voiding the warranty.

2. PLACE PAN DIVIDERS AND EMPTY PANS IN THE WELLS

NOTE: No matter what type of pan configuration chosen, pan separator bars or divider bars must be used to close all gaps between pans, and all gaps between the pans and the edges of the wells. If these gaps are not closed, heat will escape, heat distribution will be uneven, and uniform temperature will be difficult to maintain.

This is a VERY important requirement to follow whenever this appliance is in use.

3. PREHEAT AT THE NUMBER “10” SETTING FOR A MINIMUM OF 30 MINUTES

An indicator light will illuminate when the thermostat(s) is (are) turned “ON.” The unit should be preheated at the **10** setting for a minimum of **30 minutes** before loading the unit with hot food.

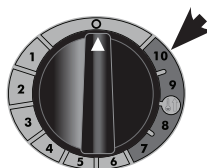

4. LOAD HOT FOODS INTO THE APPLIANCE

After preheating, place hot foods into the preheated pans located in the appliance or exchange the pans with pre-filled product pans. This appliance is designed for the purpose of hot food holding. Only hot foods should be placed into the unit. Potentially hazardous foods should be held in the unit at setting 10. If lower settings are used, ensure the food has maintained safe food temperatures. Lower settings should be tested by user to ensure food has maintained safe food temperatures between 140° and 160°F (60° and 71°C).

All pan divider bars required must be utilized at all times with the pan configuration chosen. Before loading food into the unit, use a pocket-type thermometer to make certain all products have reached an internal temperature of 140° to 180°F (60° to 82°C). If any food product is not at proper serving temperature, use a Halo Heat cooking and holding oven, set at 250° to 275°F (121° to 135°C), or a Combitherm oven to bring the product within the correct temperature range.

5. RESET THERMOSTAT(S) AS NEEDED

After all products are loaded into the unit, it is necessary to reset the thermostat(s). Since proper temperature range depends on the type of products and the quantities being held, it is necessary to periodically use a pocket thermometer to check each item to make certain the correct temperatures are being maintained. Proper temperature range is between a minimum of 140° and 180° F (60° and 82° C).

6. TO MAINTAIN PROPER FOOD TEMPERATURE, OVERHEAD HEATING IS REQUIRED.

CAUTION



METAL PARTS OF THIS EQUIPMENT BECOME EXTREMELY HOT WHEN IN OPERATION. TO AVOID BURNS, ALWAYS USE HAND PROTECTION WHEN OPERATING THIS APPLIANCE.

7. SERVE FRESH, HOT FOOD

Keep hot foods looking fresh. Occasionally stir or rotate food as needed. Wipe spills immediately to ensure maximum eye appeal and to ease end of day cleanup.

GENERAL HOLDING GUIDELINES

Chefs, cooks and other specialized food service personnel employ varied methods of cooking. Proper holding temperatures for a specific food product must be based on the moisture content of the product, product density, volume, and proper serving temperatures. Safe holding temperatures must also be correlated with palatability in determining the length of holding time for a specific product.

Halo Heat maintains the maximum amount of product moisture content without the addition of water, water vapor, or steam. Maintaining maximum natural product moisture preserves the natural flavor of the product and provides a more genuine taste. In addition to product moisture retention, the gentle properties of Halo Heat maintain a consistent temperature throughout the cabinet without the necessity of a heat distribution fan, thereby preventing further moisture loss due to evaporation or dehydration.

When product is removed from a high temperature cooking environment for immediate transfer into equipment with the lower temperature required for hot food holding, condensation can form on the outside of the product and on the inside of plastic containers used in self-service applications. Allowing the product to release the initial steam and heat produced by high temperature cooking can alleviate this condition. To preserve the safety and quality of freshly cooked foods however, a maximum of 1 to 2 minutes must be the only time period allowed for the initial heat to be released from the product.

Most Halo Heat holding equipment is provided with a thermostat control between 60° and 200°F (16° to 93°C). If the unit is equipped with vents, close the vents for moist holding and open the vents for crisp holding.

If the unit is equipped with a thermostat indicating a range of between 1 and 10, use a metal-stemmed indicating thermometer to measure the internal temperature of the product(s) being held. Adjust the thermostat setting to achieve the best overall setting based on internal product temperature.

HOLDING TEMPERATURE RANGE		
MEAT	FAHRENHEIT	CELSIUS
BEEF ROAST — Rare	130°F	54°C
BEEF ROAST — Med/Well Done	155°F	68°C
BEEF BRISKET	160° — 175°F	71° — 79°C
CORN BEEF	160° — 175°F	71° — 79°C
PASTRAMI	160° — 175°F	71° — 79°C
PRIME RIB — Rare	130°F	54°C
STEAKS — Broiled/Fried	140° — 160°F	60° — 71°C
RIBS — Beef or Pork	160°F	71°C
VEAL	160° — 175°F	71° — 79°C
HAM	160° — 175°F	71° — 79°C
PORK	160° — 175°F	71° — 79°C
LAMB	160° — 175°F	71° — 79°C
POULTRY		
CHICKEN — Fried/Baked	160° — 175°F	71° — 79°C
DUCK	160° — 175°F	71° — 79°C
TURKEY	160° — 175°F	71° — 79°C
GENERAL	160° — 175°F	71° — 79°C
FISH/SEAFOOD		
FISH — Baked/Fried	160° — 175°F	71° — 79°C
LOBSTER	160° — 175°F	71° — 79°C
SHRIMP — Fried	160° — 175°F	71° — 79°C
BAKED GOODS		
BREADS/ROLLS	120° — 140°F	49° — 60°C
MISCELLANEOUS		
CASSEROLES	160° — 175°F	71° — 79°C
DOUGH — Proofing	80° — 100°F	27° — 38°C
EGGS — Fried	150° — 160°F	66° — 71°C
FROZEN ENTREES	160° — 175°F	71° — 79°C
HORS D'OEUVRES	160° — 180°F	71° — 82°C
PASTA	160° — 180°F	71° — 82°C
PIZZA	160° — 180°F	71° — 82°C
POTATOES	180°F	82°C
PLATED MEALS	140° — 165°F	60° — 74°C
SAUCES	140° — 200°F	60° — 93°C
SOUP	140° — 200°F	60° — 93°C
VEGETABLES	160° — 175°F	71° — 79°C
THE HOLDING TEMPERATURES LISTED ARE SUGGESTED GUIDELINES ONLY. ALL FOOD HOLDING SHOULD BE BASED ON INTERNAL PRODUCT TEMPERATURES. ALWAYS FOLLOW LOCAL HEALTH (HYGIENE) REGULATIONS FOR ALL INTERNAL TEMPERATURE REQUIREMENTS.		

CLEANING AND PREVENTIVE MAINTENANCE

PROTECTING STAINLESS STEEL SURFACES



It is important to guard against corrosion in the care of stainless steel surfaces. Harsh, corrosive, or inappropriate chemicals can completely destroy the protective surface layer of stainless steel. Abrasive

pads, steel wool, or metal implements will abrade surfaces causing damage to this protective coating and will eventually result in areas of corrosion. Even water, particularly hard water that contains high to moderate concentrations of chloride, will cause oxidation and pitting that result in rust and corrosion. In addition, many acidic foods spilled and left to remain on metal surfaces are contributing factors that will corrode surfaces.

Proper cleaning agents, materials, and methods are vital to maintaining the appearance and life of this appliance. Spilled foods should be removed and the area wiped as soon as possible but at the very least, a minimum of once a day. Always thoroughly rinse surfaces after using a cleaning agent and wipe standing water as quickly as possible after rinsing.

CLEANING AGENTS

Use non-abrasive cleaning products designed for use on stainless steel surfaces. Cleaning agents must be chloride-free compounds and must not contain quaternary salts. Never use hydrochloric acid (muriatic acid) on stainless steel surfaces. Always use the proper cleaning agent at the manufacturer's recommended strength. Contact your local cleaning supplier for product recommendations.

CLEANING MATERIALS

The cleaning function can usually be accomplished with the proper cleaning agent and a soft, clean cloth. When more aggressive methods must be employed, use a non-abrasive scouring pad on difficult areas and make certain to scrub with the visible grain of surface metal to avoid surface scratches. Never use wire brushes, metal scouring pads, or scrapers to remove food residue.

 CAUTION	
 NO SCRAPERS	TO PROTECT STAINLESS STEEL SURFACES, COMPLETELY AVOID THE USE OF ABRASIVE CLEANING COMPOUNDS, CHLORIDE BASED CLEANERS, OR CLEANERS CONTAINING QUATERNARY SALTS. NEVER USE HYDROCHLORIC ACID (MURIATIC ACID) ON STAINLESS STEEL. NEVER USE WIRE BRUSHES, METAL SCOURING PADS OR SCRAPERS.
 NO WIRE BRUSHES	
 NO STEEL PADS	

CARE AND CLEANING



The cleanliness and appearance of this appliance will contribute considerably to operating efficiency and savory, appetizing food. Good equipment kept clean works better and lasts longer.



DANGER



DISCONNECT UNIT FROM POWER SOURCE BEFORE CLEANING OR SERVICING.

NOTE: Always allow the appliance to cool before cleaning.

CLEAN THE APPLIANCE DAILY.

<h2>DANGER</h2>	
	AT NO TIME SHOULD THE INTERIOR OR EXTERIOR BE STEAM CLEANED, HOSED DOWN, OR FLOODED WITH WATER OR LIQUID SOLUTION OF ANY KIND. DO NOT USE WATER JET TO CLEAN.
	SEVERE DAMAGE OR ELECTRICAL HAZARD COULD RESULT.
	WARRANTY BECOMES VOID IF APPLIANCE IS FLOODED

NOTE: Completely avoid the use of abrasive cleaning compounds, chloride-based cleaners, or cleaners containing quaternary salts. To protect metal finish on stainless steel, never use hydrochloric acid (muriatic acid).



INTERIOR:

1. Disconnect appliance from the power source. Let unit cool.
2. After the appliance has cooled, remove all detachable items such as pans and divider bars. Clean these items separately.
3. Remove any food scraps.
4. Wipe the interior metal surfaces with a paper towel to remove any remaining food debris.
5. Clean interior with a damp cloth or sponge and any good commercial detergent at the recommended strength.
6. For baked-on food deposits, use a non-caustic and non-toxic commercial oven cleaner appropriate for the interior surface. Follow the product manufacturer's instructions carefully for the use of this product. Any commercial oven cleaner must be approved for use on food contact areas. Remove soil with the use of a plastic scouring pad.
7. Rinse surfaces by wiping with a clean cloth or sponge and clean warm water.
8. Remove excess water with a sponge and wipe dry with a clean cloth or air dry. Leave area open until interior is completely dry. Replace divider bars and pans.
9. Interior can be wiped with a sanitizing solution after cleaning and rinsing. This solution must be approved for use on stainless steel food contact surfaces.

DO NOT USE ABRASIVE CLEANING COMPOUNDS.

Always follow appropriate state or local health (hygiene) regulations regarding all applicable cleaning and sanitation requirements for food service equipment.

SANITATION

Food flavor and aroma are usually so closely related that it is difficult, if not impossible, to separate them. There is also an important, inseparable relationship between cleanliness and food flavor. Cleanliness, top operating efficiency, and appearance of equipment contribute considerably to savory, appetizing foods. Good equipment that is kept clean, works better and lasts longer.

Most food imparts its own particular aroma and many foods also absorb existing odors. Unfortunately, during this absorption there is not distinction between GOOD and BAD odors. The majority of objectionable flavors and odors troubling food service operations are caused by bacteria growth. Sourness, rancidity, mustiness, stale or other OFF flavors are usually the result of germ activity.

The easiest way to insure full, natural food flavor is through comprehensive cleanliness. This means good control of both visible soil (dirt) and invisible soil (germs). A thorough approach to sanitation will provide essential cleanliness. It will assure an attractive appearance of equipment, along with maximum efficiency and utility. More importantly, a good sanitation program provides one of the key elements in the prevention of food-borne illnesses.

A controlled holding environment for prepared foods is just one of the important factors involved in the prevention of food-borne illnesses. Temperature monitoring and control during receiving, storage, preparation, and the service of foods are of equal importance.

The most accurate method of measuring safe temperatures of both hot and cold foods is by internal product temperature. A quality thermometer is an effective tool for this purpose, and should be routinely used on all products that require holding at a specific temperature.

A comprehensive sanitation program should focus on the training of staff in basic sanitation procedures. This includes personal hygiene, proper handling of raw foods, cooking to a safe internal product temperature, and the routine monitoring of internal temperatures from receiving through service.

Most food-borne illnesses can be prevented through proper temperature control and a comprehensive program of sanitation. Both these factors are important to build quality service as the foundation of customer satisfaction. Safe food handling practices to prevent food-borne illness is of critical importance to the health and safety of your customers.

HACCP, an acronym for Hazard Analysis (at) Critical Control Points, is a quality control program of operating procedures to assure food integrity, quality, and safety. Taking steps necessary to augment food safety practices is both cost effective and relatively simple. While HACCP guidelines go far beyond the scope of this manual, additional information is available by contacting:

**CENTER FOR FOOD SAFETY AND APPLIED
NUTRITION FOOD AND DRUG ADMINISTRATION
1-888-SAFEFOOD**

INTERNAL FOOD PRODUCT TEMPERATURES		
HOT FOODS		
DANGER ZONE	40° TO 140°F	(4° TO 60°C)
CRITICAL ZONE	70° TO 120°F	(21° TO 49°C)
SAFE ZONE	140° TO 165°F	(60° TO 74°C)
COLD FOODS		
DANGER ZONE	ABOVE 40°F	(ABOVE 4°C)
SAFE ZONE	36° TO 40°F	(2° TO 4°C)
FROZEN FOODS		
DANGER ZONE	ABOVE 32°F	(ABOVE 0°C)
CRITICAL ZONE	0° TO 32°F	(-18° TO 0°C)
SAFE ZONE	0°F or below	(-18°C or below)

CAUTION

THIS SECTION IS PROVIDED FOR THE ASSISTANCE OF QUALIFIED SERVICE TECHNICIANS ONLY AND IS NOT INTENDED FOR USE BY UNTRAINED OR UNAUTHORIZED SERVICE PERSONNEL.



DANGER



DISCONNECT UNIT FROM POWER SOURCE BEFORE CLEANING OR SERVICING.

SERVICE PARTS

LOC	P/N	DESCRIPTION
1.	CD-3232	CORDSET 120V (100-HW & 200-HW)
2.	CD-33367	CORDSET 120V (300-, 400- & 500-HW)
3.	CD-33840	CORDSET 208-240V
4.	CD-3922	CORDSET 230V
5.	LI-3027	WHITE POWER LIGHT 110V
6.	LI-3951	WHITE POWER LIGHT 250V
7.	PE-29421	PANEL OVERLAY 1-10
8.	TT-34982	THERMOSTAT, 120V
9.	TT-34981	THERMOSTAT, 240V
10.	KN-26568	KNOB

CALIBRATION PROCEDURES

Every unit is calibrated at the factory. Only a qualified service technician should calibrate the unit in the field if necessary.

SHOCK RISK WARNING: Unit must be disconnected from power source before making adjustments or calibrating switch.

TOOLS REQUIRED: 2mm allen (hex) wrench

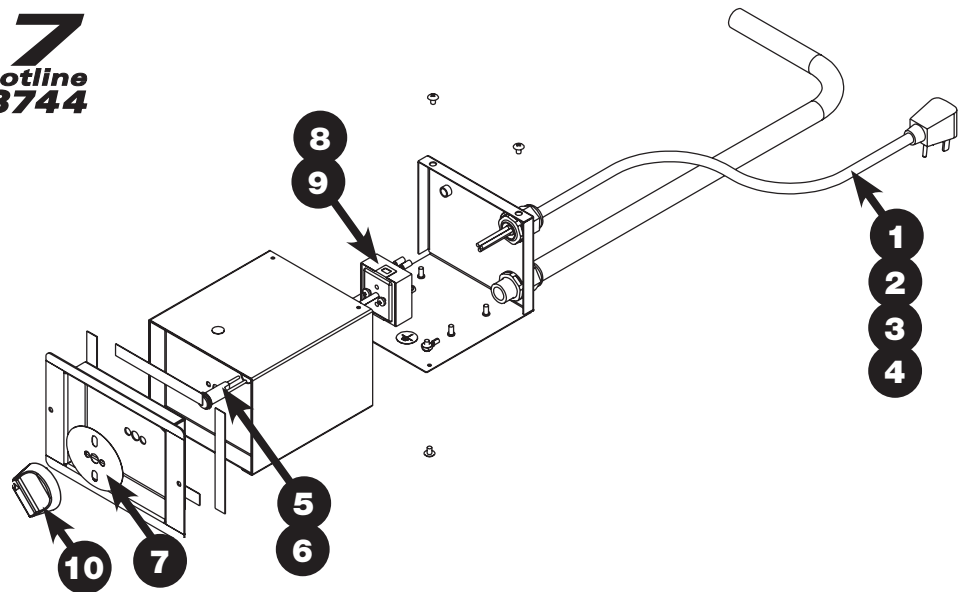

Part numbers and drawings are subject to change without notice.

CABLE HEATING REPLACEMENT SERVICE KITS		100-HW	200-HW	300-HW	400-HW	500-HW
KIT NUMBER		4877	4878	4880	4881	4880
SERVICE KIT INCLUDES:						
CB-3045	CABLE HEATING ELEMENT	37 ft	67 ft	132 ft	144 ft	120 ft
CR-3226	RING CONNECTOR	2	4	8	12	8
IN-3488	INSULATION CORNER	8 ft	8 ft	8 ft	8 ft	8 ft
BU-3105	SHOULDER BUSHING	2	4	8	12	8
BU-3106	CUP BUSHING	2	4	8	12	8
SL-3063	INSULATING SLEEVE	2	4	8	12	8
TA-3540	HIGH TEMP ELECTRICAL TAPE	1 roll	1 roll	1 roll	1 roll	1 roll
ST-2439	10.32 STUD	2	4	8	12	8
NU-2215	HEX NUT	4	8	32	24	32

Refer to wire diagram sent with unit for most current version

200-HW

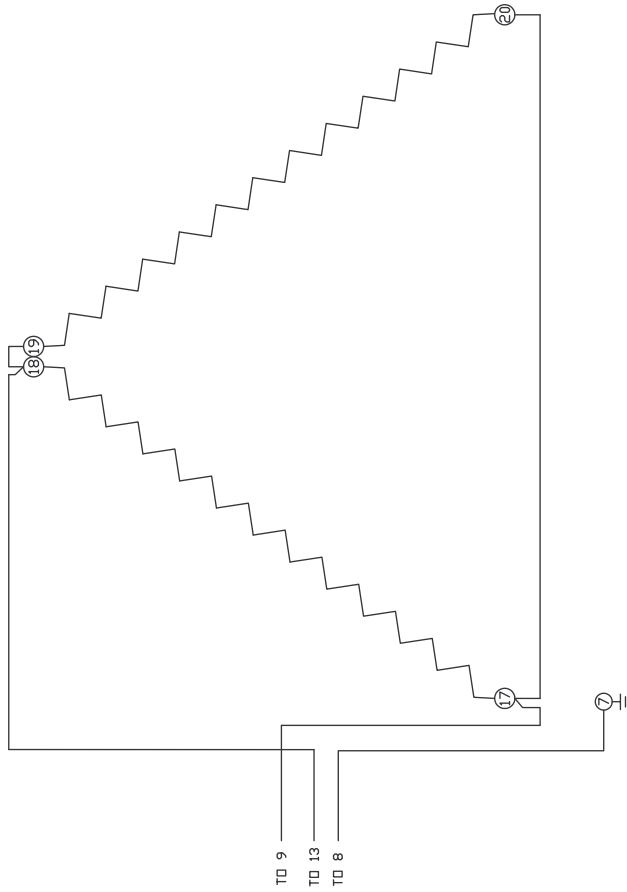

2: WRAPS OF HI-TEMP CABLE [CB-3045], 33' 6" = 22.14 OHMS AMBIENT TEMP

DESIGN	VOLTS	WATTS	AMPS
UL	120V	1268W	10.6A
UL	120V	1268W	10.6A

100-HW

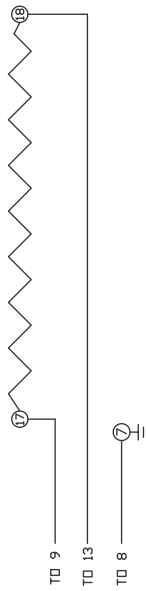

1: WRAP OF HI-TEMP CABLE [CB-3045]
36'6" = 24.1 OHMS @ AMBIENT TEMP.

DESIGN	VOLTS	WATTS	AMPS
UL	120V	580W	4.8A
UL	120V	580W	4.8A

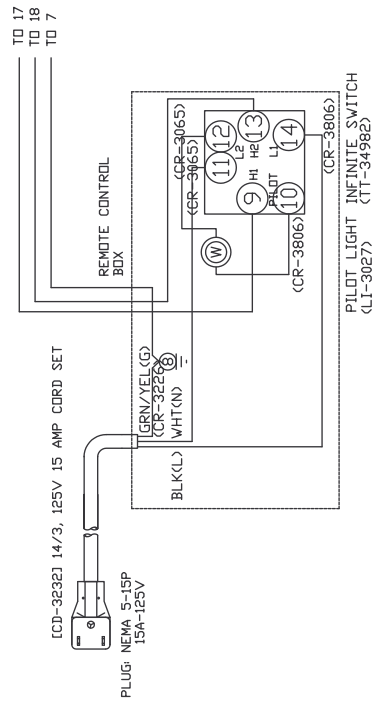

PILOT LIGHT INFINITE SWITCH
(LT-3027)

REV	ECO	DESCRIPTION	DATE	APP
1	5945	RE-DRAW HIG. CABLE SYMBOL	3/14/11	JPK
0	-	ADD INFINITE SWITCH	11/18/10	JPK
REV	ECO	DESCRIPTION	DATE	APP
100,200-HW 120V 60HZ				

ALTO-SHAAM
WIRING DIAGRAM
DWG: 77383
SHEET 1 OF 1

REFERENCE WIRE ASSBY #5013172

Refer to wire diagram sent with unit for most current version

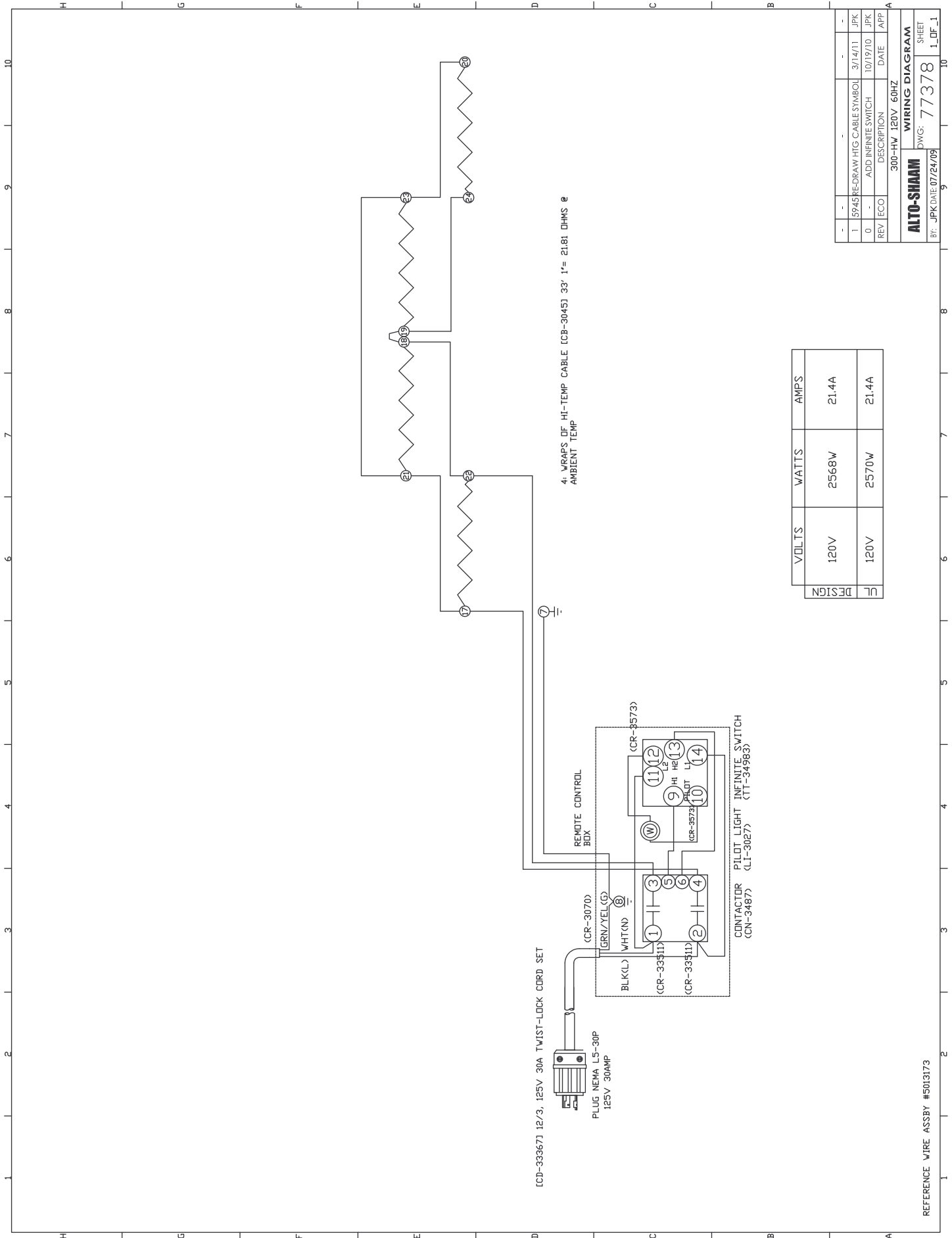

DESIGN	VOLTS	WATTS	AMPS
FL	120V	2568W	21.4A
CL	120V	2570W	21.4A

REV	ECO	DESCRIPTION	DATE	APP
1	15945	RE-DRAW HTG CABLE SYMBOL	3/14/11	JPK
0	-	ADD INFINITE SWITCH	10/19/10	JPK

300-HV 120V 60HZ

ALTO-SHAM WIRING DIAGRAM
 BY: JPK DAE 07/24/09 DWG: 77378 SHEET 1_DF_1

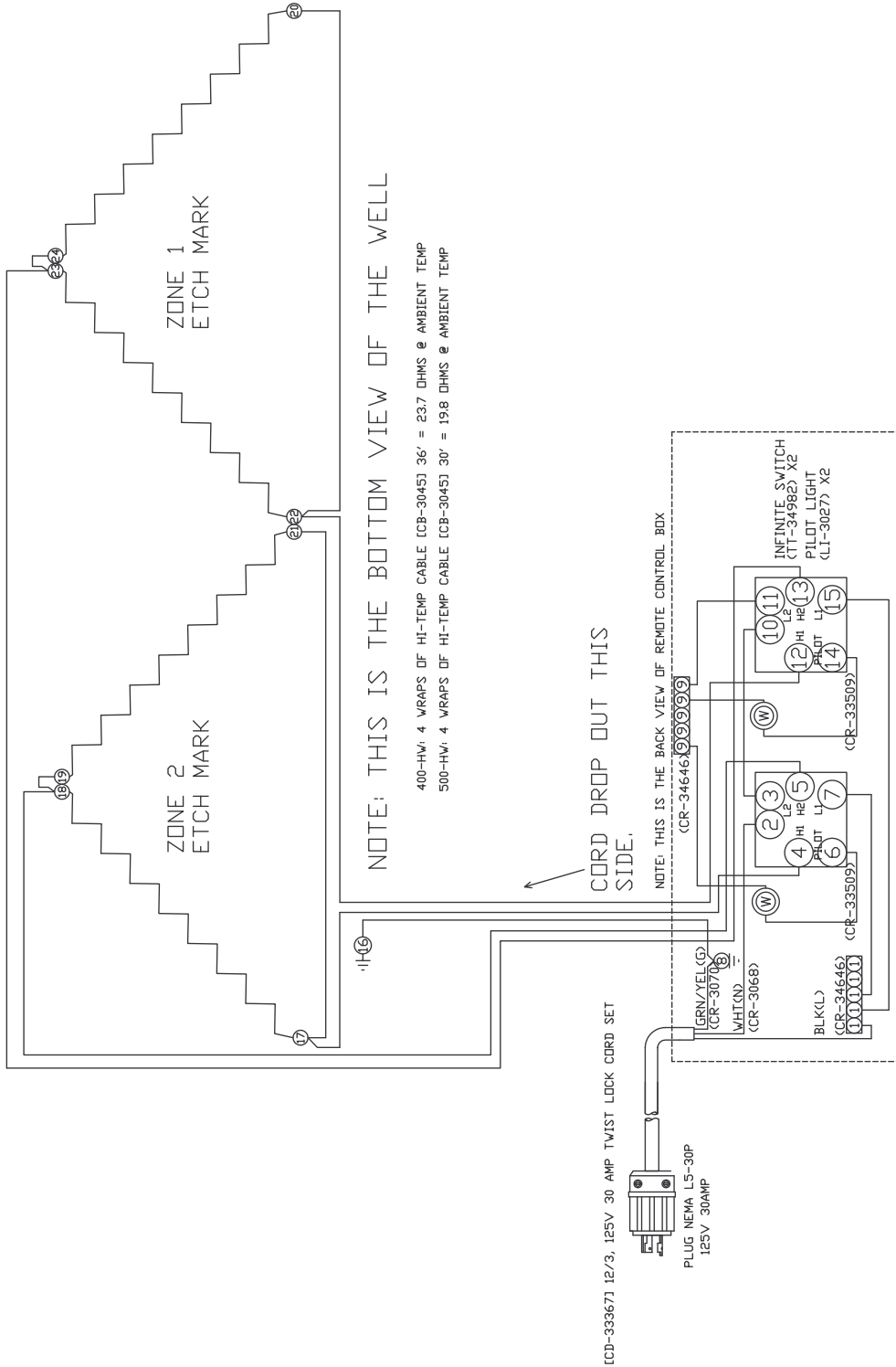

IMPORTANT: ZONE 1 THERMOSTAT MUST CONTROL ZONE 1 WELL.
 IMPORTANT: ZONE 2 THERMOSTAT MUST CONTROL ZONE 2 WELL.

400-HV		500-HV	
VOLTS	WATTS	VOLTS	WATTS
120V	2360W	120V	2832W
DESIGN	19.7A	DESIGN	23.6A
CF	19.7A	CF	23.6A

REV	ECO	DESCRIPTION	DATE	APP
2		15945 RE-DRAW HTG CABLE SYMBOL	3/14/11	JPK
1		FIX INFINITE SWITCH P/N	10/25/10	JPK
0		ADD INFINITE SWITCH	10/19/10	JPK
400 & 500-HV 120V 60HZ				

WIRING DIAGRAM
 DWG: 77356
 BY: JPK DATE: 05/28/10
 SHEET 1 OF 1

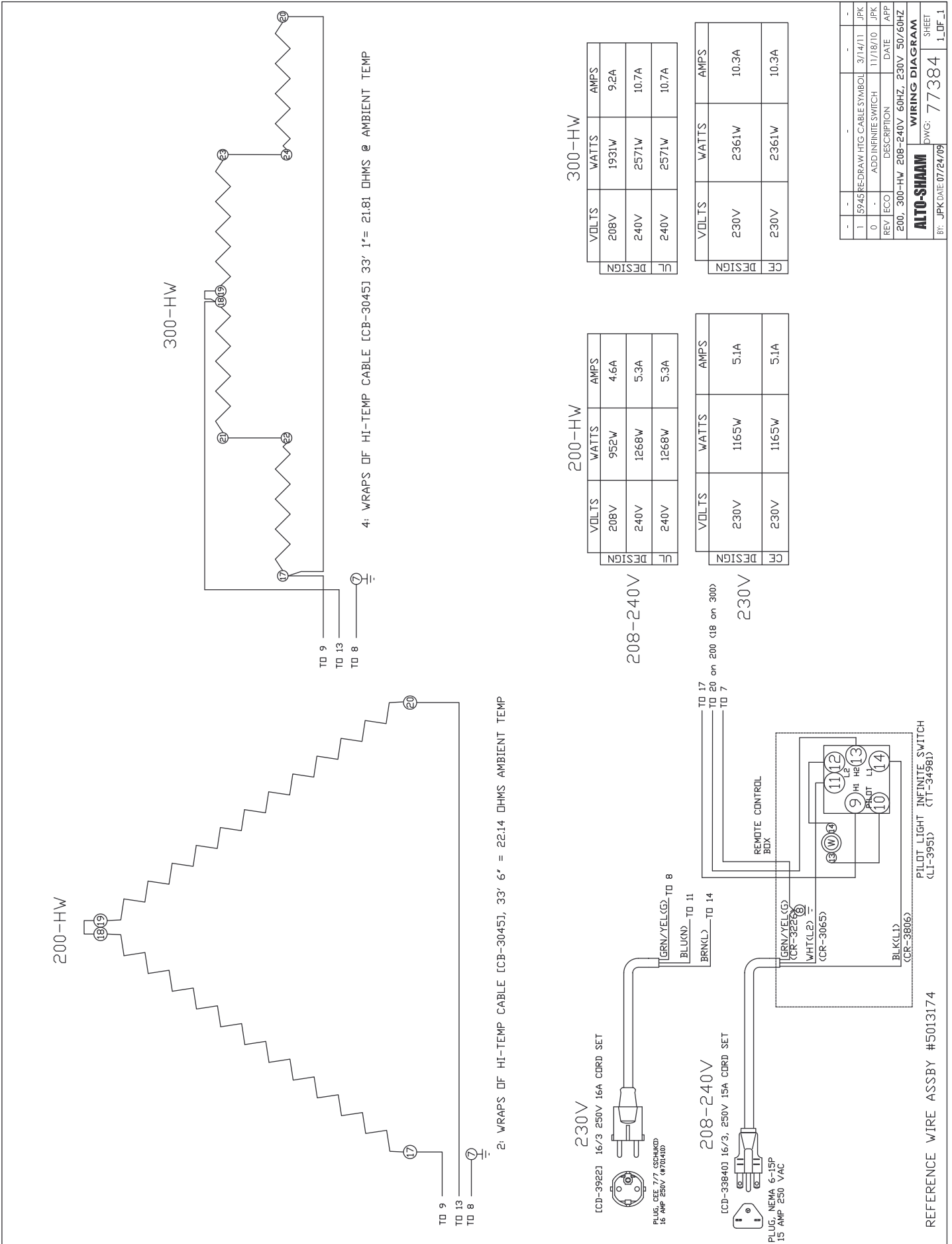

REV	ECO	DESCRIPTION	DATE	APP
1	5945	RE-DRAW HTG. CABLE SYMBOL	3/14/11	JPK
0		ADD INFINITE SWITCH	11/18/10	JPK

REV	ECO	DESCRIPTION	DATE	APP
200	300-HW	208-240V 60HZ, 230V 50/60HZ		

ALTO-SHAAM
BY: JPK DATE 07/24/09

WIRING DIAGRAM
DWG: 77384
SHEET 1 OF 1

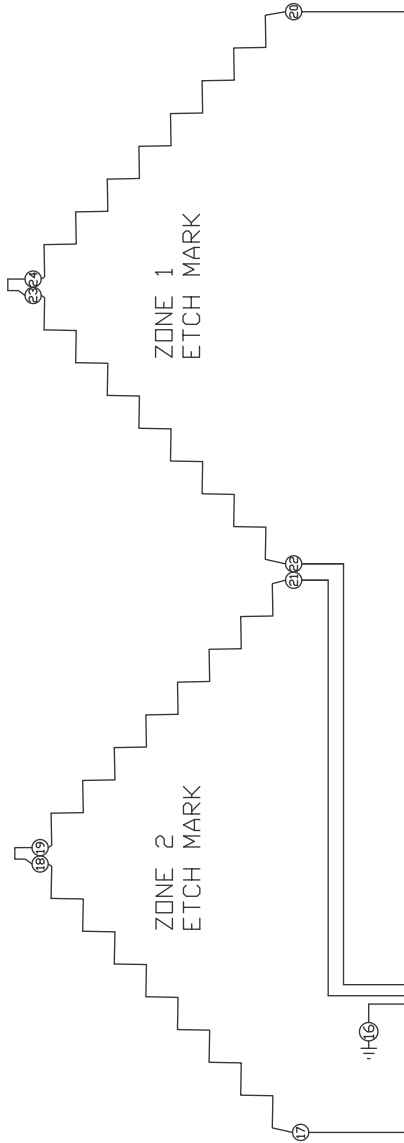

NOTE: THIS IS THE BOTTOM VIEW OF THE WELL

400-HW: 4 WRAPS OF HI-TEMP CABLE [CB-3045] 36' = 23.7 OHMS @ AMBIENT TEMP
 500-HW: 4 WRAPS OF HI-TEMP CABLE [CB-3045] 30' = 19.8 OHMS @ AMBIENT TEMP

IMPORTANT: ZONE 1 SWITCH MUST CONTROL ZONE 1 WELL,
 ZONE 2 SWITCH MUST CONTROL ZONE 2 WELL.

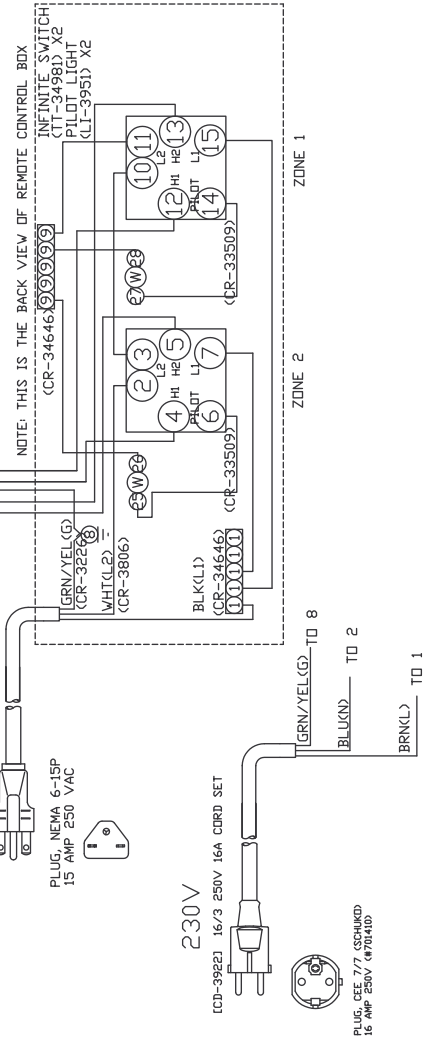

400-HW

VOLTS	WATTS	AMPS
208V	1772W	8.5A
240V	2360W	9.8A
240V	2380W	9.9A

500-HW

VOLTS	WATTS	AMPS
208V	2127W	10.2A
240V	2832W	11.8A
240V	2830W	11.8A

VOLTS	WATTS	AMPS
230V	2167W	9.4A
230V	2185W	9.5A

VOLTS	WATTS	AMPS
230V	2601W	11.3A
230V	2600W	11.3A

REV	ECO	DESCRIPTION	DATE	APP
1	5945	RE-DRAW HITC CABLE SYMBOL	3/14/11	JPK
0	-	ADD INFINITE SWITCH	11/24/10	JPK
400 & 500-HW	208-240V 60HZ, 230V 50/60HZ	DESCRIPTION	DATE	APP

ALTO-SHAAM WIRING DIAGRAM
 DWG: 77385 SHEET 1_OF_1

REFERENCE WIRE ASSBY #5013176

TRANSPORTATION DAMAGE and CLAIMS



All Alto-Shaam equipment is sold F.O.B. shipping point, and when accepted by the carrier, such shipments become the property of the consignee.

Should damage occur in shipment, it is a matter between the carrier and the consignee. In such cases, the carrier is assumed to be responsible for the safe delivery of the merchandise, unless negligence can be established on the part of the shipper.

1. Make an immediate inspection while the equipment is still in the truck or immediately after it is moved to the receiving area. Do not wait until after the material is moved to a storage area.
2. Do not sign a delivery receipt or a freight bill until you have made a proper count and inspection of all merchandise received.
3. Note all damage to packages directly on the carrier's delivery receipt.
4. Make certain the driver signs this receipt. If he refuses to sign, make a notation of this refusal on the receipt.
5. If the driver refuses to allow inspection, write the following on the delivery receipt:
Driver refuses to allow inspection of containers for visible damage.
6. Telephone the carrier's office immediately upon finding damage, and request an inspection. Mail a written confirmation of the time, date, and the person called.
7. Save any packages and packing material for further inspection by the carrier.
8. Promptly file a written claim with the carrier and attach copies of all supporting paperwork.

We will continue our policy of assisting our customers in collecting claims which have been properly filed and actively pursued. We cannot, however, file any damage claims for you, assume the responsibility of any claims, or accept deductions in payment for such claims.

LIMITED WARRANTY

Alto-Shaam, Inc. warrants to the original purchaser only that any original part that is found to be defective in material or workmanship will, at Alto-Shaam's option, subject to provisions hereinafter stated, be replaced with a new or rebuilt part.

The parts warranty period is as follows:

For the refrigeration compressor on Alto-Shaam Quickchillers™, five (5) years from the date of installation.

For the heating element on Halo Heat® cook/hold ovens, as long as the original purchaser owns the oven.

For all other parts, one (1) year from the date of installation or fifteen (15) months from the shipping date, whichever occurs first.

The labor warranty period is one (1) year from the date of installation or fifteen (15) months from the shipping date, whichever occurs first.

Alto-Shaam will bear normal labor charges performed during standard business hours, excluding overtime, holiday rates or any additional fees.

To be valid, a warranty claim must be asserted during the applicable warranty period. This warranty is not transferable.

THIS WARRANTY DOES NOT APPLY TO:

1. Calibration.
2. Replacement of light bulbs, door gaskets, and/or the replacement of glass due to damage of any kind.
3. Equipment damage caused by accident, shipping, improper installation or alteration.
4. Equipment used under conditions of abuse, misuse, carelessness or abnormal conditions, including but not limited to, equipment subjected to harsh or inappropriate chemicals, including but not limited to, compounds containing chloride or quaternary salts, poor water quality, or equipment with missing or altered serial numbers.
5. Damage incurred as a direct result of poor water quality, inadequate maintenance of steam generators and/or surfaces affected by water quality. Water quality and required maintenance of steam generating equipment is the responsibility of the owner/operator.
6. Damage caused by use of any cleaning agent other than Alto-Shaam's Combitherm® Cleaner, including but not limited to damage due to chlorine or other harmful chemicals. **Use of Alto-Shaam's Combitherm® Cleaner on Combitherm® ovens is highly recommended.**
7. Any losses or damage resulting from malfunction, including loss of product or consequential or incidental damages of any kind.
8. Equipment modified in any manner from original model, substitution of parts other than factory authorized parts, removal of any parts including legs, or addition of any parts.

This warranty is exclusive and is in lieu of all other warranties, express or implied, including the implied warranties of merchantability and fitness for a particular purpose. In no event shall Alto-Shaam be liable for loss of use, loss of revenue or profit, or loss of product, or for any indirect, special, incidental, or consequential damages. No person except an officer of Alto-Shaam, Inc. is authorized to modify this warranty or to incur on behalf of Alto-Shaam any other obligation or liability in connection with Alto-Shaam equipment.

Effective 09/10



RECORD THE MODEL AND SERIAL NUMBER OF THE APPLIANCE FOR EASY REFERENCE.

ALWAYS REFER TO BOTH MODEL AND SERIAL NUMBER IN ANY CONTACT WITH ALTO-SHAAM REGARDING THIS APPLIANCE.

Model: _____ Date Installed: _____
Voltage: _____ Purchased From: _____
Serial Number: _____

W164 N9221 Water Street • P.O. Box 450 • Menomonee Falls, Wisconsin 53052-0450 • U.S.A.

PHONE: 262.251.3800 • 800.558-8744 USA/CANADA FAX: 262.251.7067 • 800.329.8744 U.S.A. ONLY

www.alto-shaam.com

PRINTED IN U.S.A.

Free Manuals Download Website

<http://myh66.com>

<http://usermanuals.us>

<http://www.somanuals.com>

<http://www.4manuals.cc>

<http://www.manual-lib.com>

<http://www.404manual.com>

<http://www.luxmanual.com>

<http://aubethermostatmanual.com>

Golf course search by state

<http://golfingnear.com>

Email search by domain

<http://emailbydomain.com>

Auto manuals search

<http://auto.somanuals.com>

TV manuals search

<http://tv.somanuals.com>