



User's Manual

English

APC Smart-UPS[®]
3U Rack Mount
External Battery Pack

990-1056A, 08/01

1: SAFETY INFORMATION

American Power Conversion Corporation (APC) is the leading national and international manufacturer of state-of-the-art uninterruptible power supplies, redundant switches, power management software, and related equipment. APC products protect hardware, software, and data from the threat of power disturbances in business and government offices throughout the world.

The APC 3U Rack Mount Battery Pack connects to an APC Uninterruptible Power Supply (UPS) and provides extended protection from electrical blackouts, brownouts, sags, and surges.



Changes or modifications to this unit not expressly approved by the party responsible for compliance could void the warranty.

HANDLING SAFETY

- Be careful. Do not lift heavy loads without assistance.

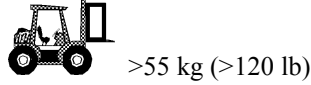
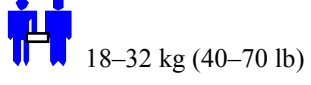
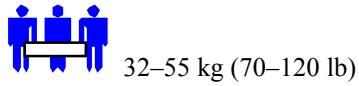
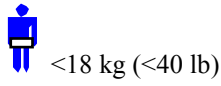

- This equipment is intended for installation in a temperature-controlled indoor area free of conductive contaminants. Refer to Specifications at the APC web site for the actual temperature range.

LIFE SUPPORT APPLICATION POLICY

As a general policy, APC does not recommend the use of any of its products in life support applications where failure or malfunctions of the APC product can be reasonably expected to cause failure of the life support device or to significantly affect its safety or effectiveness. APC does not recommend the use of any of its products in direct patient care. APC will not knowingly sell its products for use in such applications unless it receives in writing assurances satisfactory to APC that (a) the risks of injury or damage have been minimized, (b) the customer assumes all such risks, and (c) the liability of APC is adequately protected under the circumstances.

Examples of devices considered to be life support devices are neonatal oxygen and analyzers, nerve stimulators (whether used for anesthesia, pain relief, or other purposes), autotransfusion devices, blood pumps, defibrillators, arrhythmia detectors and alarms, pacemakers, hemodialysis systems, peritoneal dialysis systems, neonatal ventilator incubators, ventilators for both adults and infants, anesthesia ventilators, infusion pumps, and any other device designated as “critical” by the U.S.F.D.A.

Hospital grade wiring devices and leakage current may be ordered as options on many APC UPS systems, APC does not claim that units with this modification are certified or listed as Hospital Grade by APC or any other organization. Therefore these units do not meet the requirements for use in direct patient care.

BATTERY SAFETY



This equipment contains potentially hazardous voltages that may cause personal injury if handled incorrectly.

This equipment must be installed and serviced only by qualified electrical service personnel.

- This equipment contains potentially hazardous voltages. Do not attempt to disassemble the unit. The unit contains no user serviceable parts. Repairs are to be performed only by factory trained service personnel.
- Do not dispose of batteries in a fire. The batteries may explode.
- Do not open or mutilate batteries. They contain an electrolyte that is toxic and harmful to the skin and eyes.
- Do not connect the terminals of a battery or battery pack with a wire or other electrically conductive objects.
- To avoid personal injury due to energy hazard, remove wristwatches and jewelry such as rings when replacing the batteries. Use tools with insulated handles.
- Replace batteries with the same number and type of batteries as originally installed in the equipment.

BATTERY REPLACEMENT AND RECYCLING

See your dealer or visit the APC web site, www.apc.com/support, for information on replacement battery kits and battery recycling.



Be sure to return the spent battery to APC for recycling. Ship it to APC in the replacement battery packing material.

2: INSTALLING THE BATTERY PACK

The APC 3U Rack Mount Battery Pack provides extended protection to safeguard your computer and other valuable electronic equipment. The external battery pack also provides extra protection while replacing the batteries in the UPS.

MAXIMUM NUMBER OF BATTERY PACKS SUPPORTED BY THE UPS

The following table indicates the maximum number of battery packs supported by the UPS. In addition, battery pack connectors are color-coded and keyed to prevent improper connection.

UPS	VOLTAGE	USES THIS BATTERY PACK	MAXIMUM NUMBER OF BATTERY PACKS
SU2200RMXL3U	48	SU48RMXLBP3U	10
SU2200RMXLI3U	48	SU48RMXLBP3U	10
SU3000RMXL3U	48	SU48RMXLBP3U	10
SU3000RMXLI3U	48	SU48RMXLBP3U	10

UNPACKING

1. Inspect the battery pack upon receipt. APC designed robust packaging for your product. However, accidents and damage may occur during shipment. Notify the carrier and dealer if there is damage.

The packaging is recyclable; save it for reuse or dispose of it properly.

2. Check the package contents. The shipping package contains the battery pack, its front bezel (packaged separately), mounting rails, mounting cleats, hardware packet (necessary for rack mounting), and a literature kit containing product documentation.



The battery pack is shipped with the front bezel removed (packaged separately within the main box). You will install the plastic bezel (described later) during the installation procedure.

POSITIONING THE BATTERY PACK

Place the rack and the battery pack where they will be used. **The battery pack is heavy. Select a location sturdy enough to handle the weight.**

Consider that you must install the battery pack in a protected area that is free of excessive dust and has adequate airflow. Ensure the air vents on the front and rear of the battery pack are not blocked. Allow at least one inch of space on both sides.

Do not operate the UPS where the temperature and humidity are outside the specified limits. Refer to Specifications at the APC web site.

PLACEMENT

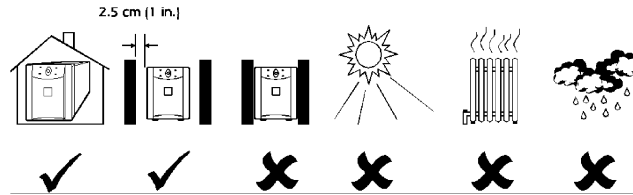

REVIEWING CONNECTORS ON THE BATTERY PACK

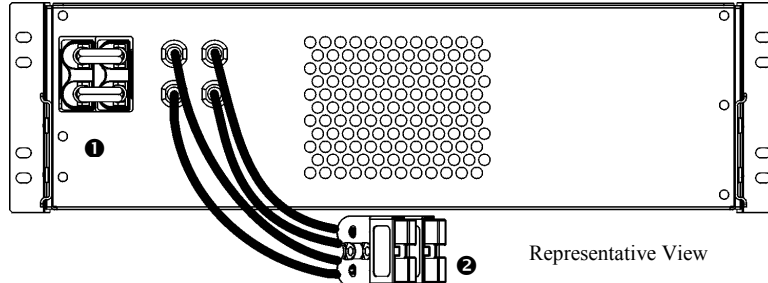

- Battery Pack Connector** Use the battery pack connector ❶ to daisy-chain multiple battery packs to the same UPS. The connector is color-coded and keyed to prevent improper connection.
- Connection Cable** Attach the connection cable plug ❷ into a battery pack connector on either the UPS or another battery pack. The connector is color-coded and keyed to prevent improper connection.
- Connector Plug** The connector plug is shipped installed in the battery pack connector. A similar plug is shipped installed in the UPS. The plug should only be removed when connecting battery packs.

INSTALLING THE BATTERY PACK

To install one or multiple battery packs, follow these basic steps. Details of each step follow this list.

1. Install the mounting rails in the rack.
2. Remove the battery trays from the battery pack.
3. Mount the battery pack in the rack. **Install the battery pack at or near the bottom of the rack.** Position it below the UPS.
4. Reinstall the battery trays and attach the front bezel.
5. Connect the battery pack to the Smart-UPS or another battery pack.

INSTALLING THE MOUNTING RAILS IN THE RACK

Install the mounting rails in the rack. Directions are included with the rail kit. The battery pack comes with standard 19-inch (46.5 cm) rack mounting rails, brackets, and cleats. The rack can have any of the common types of equipment mounting holes (square, round-threaded, or round-non-threaded). All necessary hardware is provided.

REMOVING THE BATTERY TRAYS FROM THE BATTERY PACK

The battery pack is heavy. To lighten it, remove the battery trays before mounting the unit in the rack.

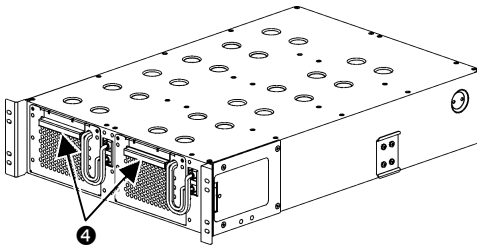
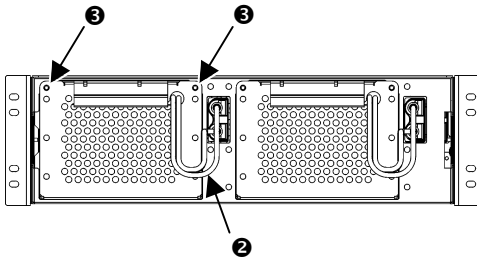
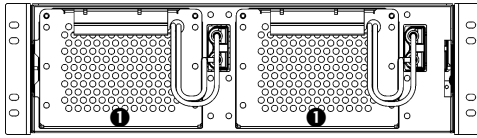

The battery trays are accessible from the front of the battery pack (shown at left). This procedure requires a Phillips screwdriver.

1. Notice that the two battery tray compartments 1 are visible. This procedure describes how to remove one battery tray.
2. Locate the white cord attached to the battery tray connector plug 2. Grasp the cord and pull firmly toward you until the connector plug is disconnected.

DO NOT pull the battery cables.

3. Use a screwdriver to remove the two battery pack mount screws located at the top corners of the face plate 3.

Set the screws aside in a safe place. You will replace them later.

4. Locate the battery tray handle 4.
5. Be careful during this step—the battery tray is heavy.

Pull the battery tray handle toward you to slide the tray out of the battery pack.

DO NOT pull on battery cables or white cord.

6. Repeat Steps 2 through 5 to remove the other the other tray.

MOUNTING THE BATTERY PACK IN THE RACK

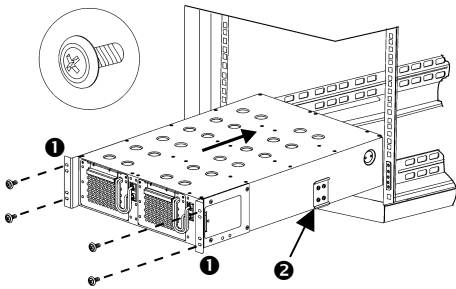

1. Supporting the battery pack on both sides, carefully align the unit with the rails. Use the handles 1 on the side of the battery pack to support the unit.
2. Each side of the battery pack has a cleat 2 that must slide into the groove on the rails. Insert each cleat into its groove and slide the battery pack into position.
3. Use the four ornamental screws supplied with the battery pack to attach the mounting brackets to the rack post. Insert the screws into the top and bottom holes in the U-space.

REINSTALLING THE BATTERY TRAYS AND ATTACHING THE FRONT BEZEL

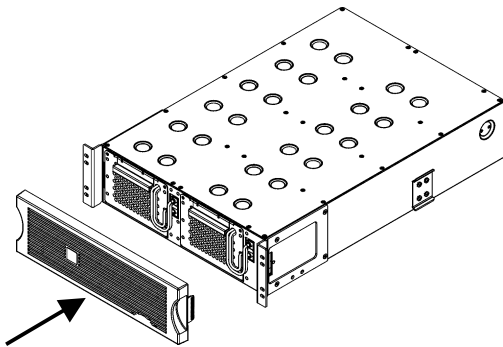
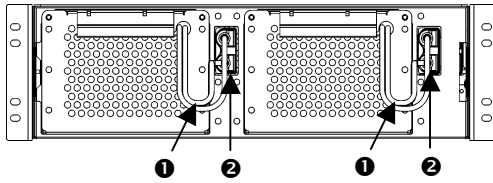

1. Supporting the battery tray on the bottom, align it with the battery pack opening and slide the tray into the compartment.
2. Replace the two screws to secure the battery pack face plate.
3. Locate the battery cables ❶ and the UPS battery connector jacks ❷ to the right of each battery tray.
4. To connect the battery connector plug to the battery jack, push the plug into the jack so the metal pieces inside each part are touching. Press firmly to ensure a tight connection. You will hear a “snap” when the connector is seated properly.
5. Push the battery cables and white cord as close to the battery tray as possible.
6. The battery pack is shipped with the front bezel removed (it is packaged separately within the main box).

Unpack the bezel and hold it with the cutout section on the right. Align the tabs on the side of the bezel with the slots on the front of the battery pack and gently snap it into place.

CONNECTING A BATTERY PACK TO THE SMART-UPS



Battery pack connectors are color-coded and keyed to prevent improper connection. The color of the connector on the UPS must match the color of the battery pack connector.



Allow the battery pack to charge for 24 hours. **Do not** expect full run time during this initial charge period.

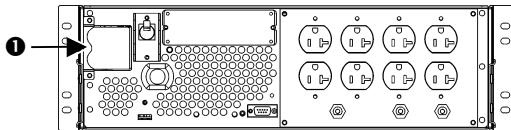

1. Remove the rear connector plug from the UPS ❶.



Both the UPS and the external battery pack are shipped with rear connector plugs installed.

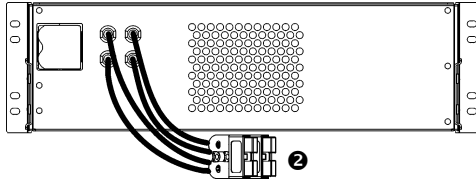

2. Facing the rear of the battery pack, locate the battery pack connector 2.

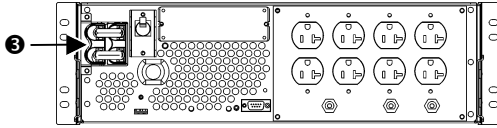

3. Insert the battery pack connector into the rear connector 3 on the back of the UPS.

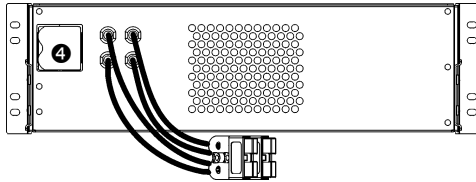

4. Be sure the rear connector plug 4 remains connected on the battery pack. Removal of this plug will cause the battery to be disconnected.

If multiple battery packs are used, refer to the procedure below, *Connecting a Battery Pack to Another Battery Pack*.

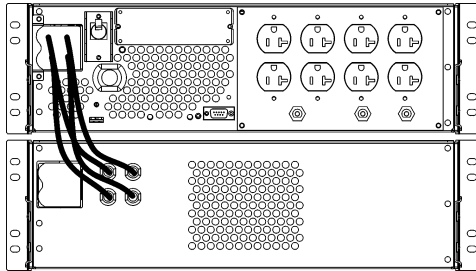

The example at left shows one battery pack properly connected to the UPS. Note that the rear connector plug in the Battery Pack is not removed.

CONNECTING A BATTERY PACK TO ANOTHER BATTERY PACK



You can connect a maximum of 10 battery packs to the UPS.

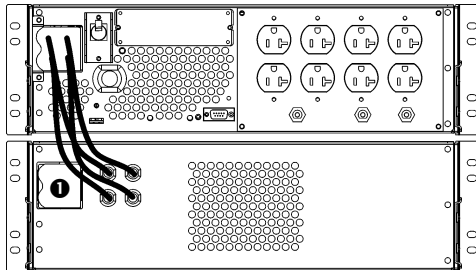

1. When more than one battery pack is used, remove the rear connector plug 1 from the battery pack connected to the UPS.

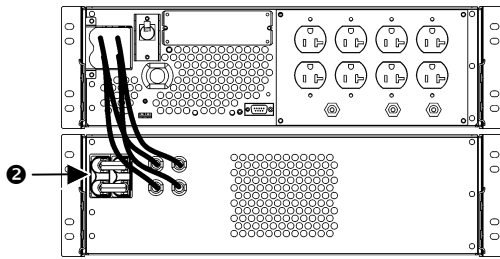

2. Insert the battery pack connector into the rear connector **2** on the back of the other battery pack.



When multiple battery packs are used, be sure the rear connector plug remains connected to the last battery pack in the stack only, otherwise the battery will not be connected.

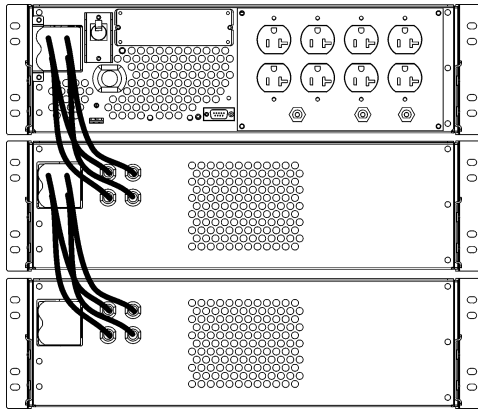

The example at left shows two external battery packs properly connected to the UPS.

3: OPERATING THE SMART-UPS WITH A BATTERY PACK

SETTING THE SMART-UPS TO RECOGNIZE THE BATTERY PACK(S)

Smart-UPS XL models cannot determine how many external battery packs are connected to them. You must program the Smart-UPS XL with the appropriate number of external batteries in one of four ways using:

- Smart-UPS Battery Pack Utility (BATTPACK)
- PowerChute® *plus* Version 5.x for Windows 95, Windows 98, Windows NT
- Terminal Program to Change the Number of External Battery Packs
- HyperTerminal Program to Change the Number of External Battery Packs

Each method is described in this section.



It is important to follow these instructions. The number of batteries affects the run time calculations the Smart-UPS performs when it is running on battery power.

USING THE SMART-UPS BATTERY PACK UTILITY (BATTPACK)

You can use the BATTPACK program with DOS or at a Microsoft® Windows DOS prompt. BATTPACK cannot be used with a DOS emulator or VDM (virtual DOS machine) like those in Windows 95, Windows 98, or Windows NT.

You must use the APC UPS Link cable to communicate to the UPS. Use either of two black cables: part numbers 940-0024C or 940-1524C.

At the DOS prompt, type: **battpack com[X] [Y]**

where [X] represents the available serial port the Battery Pack Utility uses to access the Smart-UPS. [Y] represents the number of external battery packs.

In the following example, the black cable is attached to communication port 1. There are four external battery packs. The program confirms that the update is successful.

```
C:> battpack com1 4
```

USING POWERCHUTE® PLUS VERSION 5.X FOR WINDOWS 95, WINDOWS 98, WINDOWS NT

PowerChute *plus* 5.x for Windows NT is compatible with NT 3.5.1 SP5, NT 4.0 Workstation (at least SP1), or NT 4.0 Server (at least SP1).

1. Install the software per the instructions on the CD. After rebooting the computer, access the PowerChute *plus* graphical user interface.
2. Click on **Configuration**.
3. Click on **UPS Operating Parameters**.
4. Adjust the **External Battery Pack** field to the appropriate number of external battery packs.
5. Click **OK**.

USING THE TERMINAL PROGRAM TO CHANGE THE NUMBER OF EXTERNAL BATTERY PACKS

Terminal is used in Windows 3.1x, Windows for Workgroups, and Windows NT 3.51.

1. **EXIT** the PowerChute *plus* Server. In Windows NT, the UPS Service must be stopped.
2. Go to **Program Manager > Accessories > Terminal**. Double-click on the **Terminal** icon.
3. Select the COM port to which the black-colored interface cable is attached as the Connector. The COM port settings are 2400 baud, 8 data bits, 1 stop bit, no parity, flow control is Xon/Xoff.
4. Click **OK**.
5. Once the terminal window is open, follow these steps:

COMMAND	RESPONSE
Y	SM
>	To see the number of external packs. (A new unit will display 000.)
+	Adds a battery pack.
>	To see the change in number of external battery packs.
-	Subtracts a battery pack.
>	To see the change in number of external battery packs.

USING THE HYPERTERMINAL PROGRAM TO CHANGE THE NUMBER OF EXTERNAL BATTERY PACKS

1. **EXIT** the PowerChute *plus* Server. In Windows NT, the UPS Service must be stopped.
2. From the Desktop, go to **Start => Programs => Accessories => HyperTerminal**. Double-click on the **HyperTerminal** icon.
3. You are prompted to choose a name and select an icon. Enter name and then click **OK**. Disregard the message, "...must install a modem," if it is displayed.
4. Select the COM port. The port settings are 2400 baud, 8 data bits, 1 stop bit, no parity, flow control is Xon/Xoff.
5. Click on **Advanced** and ensure the box labeled, **FIFO buffer**, is NOT checked.
6. Once the HyperTerminal window is open, follow these steps:

COMMAND	RESPONSE
Y	SM
>	To see the number of external packs. (A new unit will display 000.)
+	Adds a battery pack.
>	To see the change in number of external battery packs.
-	Subtracts a battery pack.
>	To see the change in number of external battery packs.

4: STORAGE AND REPLACEMENT

STORAGE

STORAGE CONDITIONS

Store the battery pack covered and flat (rack mount orientation) in a cool, dry location, with its battery fully charged. Disconnect any cables connected to the computer interface port to avoid unnecessarily draining the battery.

EXTENDED STORAGE

At -15 to +30 °C (+5 to +86 °F), charge the batteries every six months.

At +30 to +45 °C (+86 to +113 °F), charge the batteries every three months.

REPLACING A BATTERY TRAY

The battery pack has two easy to replace, hot-swappable battery trays. Battery tray replacement is a safe procedure, isolated from electrical hazards. You may leave the battery pack connected to the UPS with the protected equipment on for the following procedure. See your dealer or contact APC for information on replacement battery tray (RBC-27). See the APC website <http://www.apc.com/support>, to confirm the correct replacement battery tray number (RBC) and to see other options.

BATTERY TRAY REPLACEMENT PROCEDURE

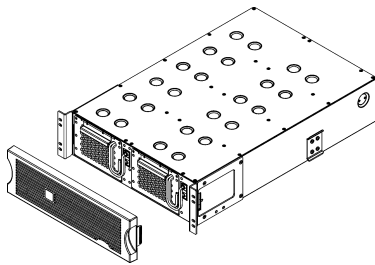

The battery trays are accessible from the front of the battery pack. This procedure requires a Phillips screwdriver.

1. Remove the front bezel. Use both hands and grasp the finger clips on either side of the bezel. Pull it toward you. The bezel will unsnap from the battery pack.

Set the bezel aside—you will reinstall it later.

Although both battery tray compartments are visible, Steps 2 through 11 describe how to remove and replace one battery tray. Repeat the steps for the other tray.

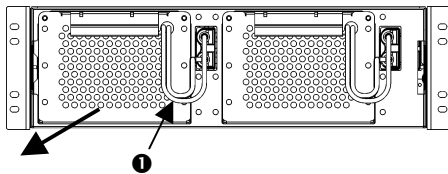

2. Locate the white cord attached to one of the battery tray connector plugs ❶. Grasp the cord and pull firmly toward you until the connector plug is disconnected.

DO NOT pull the battery cables.

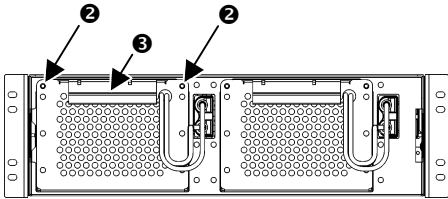

3. Use a screwdriver to remove the two battery pack mount screws located at the top corners of the battery tray face plate ❷.

Set the screws aside in a safe place. You will replace them later.

4. Locate the battery tray handle ❸.

5. Be careful during this step—the tray is heavy.

Pull the battery tray handle toward you to slide the tray out of the battery pack.

DO NOT pull on battery cables or white cord.

6. Return the battery tray to APC.

7. Supporting the new battery tray on the bottom, align it with the opening and slide the tray into the compartment.

8. Replace the two screws to secure the battery pack face plate.

9. Locate the battery cables ❹ and the UPS battery connector jack ❺ to the right of the battery tray.

10. Connect the battery connector plug to the jack. Push the plug into the jack so the metal pieces inside each part are touching. Press firmly to ensure a tight connection. You will hear a “snap” when the battery connector plug is seated properly.

11. Push the battery cables and white cord as close to the battery tray as possible.

12. Repeat Steps 2 through 11 to remove and replace the other battery tray.

13. Hold the bezel with the cutout section on the right. Align the tabs on the side of the bezel with the slots on the front of the battery pack and gently snap it into place.

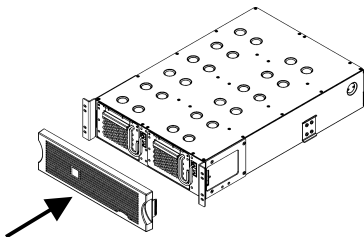
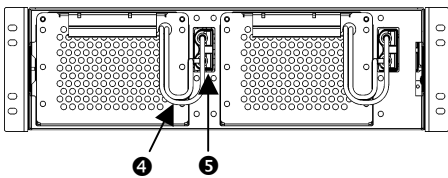

SERVICE

If the unit requires service, do not return it to the dealer. Instead, follow these steps:

1. Review the problems discussed in the *Troubleshooting* section of the User's Manual for your UPS to eliminate common problems.
2. Verify that no circuit breakers are tripped. A tripped circuit breaker is the most common problem.
3. If the problem persists, call APC Customer Service or visit the APC website (www.apc.com).
 - Note the model number of the unit, the serial number, and the date purchased. If you call APC Customer Service, a technician will ask you to describe the problem and try to solve it over the phone, if possible. If this is not possible the technician may arrange for the unit to be serviced or may issue a Returned Material Authorization Number (RMA#).
 - If the unit is under warranty, repairs are free. If not, there is a repair charge.
 - Procedures for servicing or returning your unit may vary internationally. Please contact the APC Customer Service office in the appropriate country (www.apc.com/support) for questions about warranty and RMA.
4. Pack the unit in its original packaging. If the original packing is not available, ask APC Customer Service about obtaining a new set.

Pack properly to avoid damage in transit. Never use Styrofoam beads for packaging. Damage sustained in transit is not covered under warranty.



Always DISCONNECT THE BATTERY before shipping in compliance with U.S. Department of Transportation (DOT) regulations.

5. Mark the RMA# on the outside of the package.
6. Return the unit by insured, prepaid carrier to the address given to you by Customer Service.

5: CONTACT AND WARRANTY INFORMATION

CONTACTING APC

Refer to the information provided at the APC Internet site:

<http://www.apc.com/support/contact>

DECLARATION OF CONFORMITY

CE 2001
EC Declaration of Conformity

We, the undersigned, declare under our sole responsibility that the equipment specified below conforms to the following standards and directives:

Standards to Which Conformity Declared:	EN50091-1, EN60950, EN50091-1-1, IEC60950 EN54022, EN50091-2, EN61000-3-2, EN61000-3-3 73/23/EEC, 93/68/EEC
Application of Council Directives:	89/36/EEC, 92/31/EEC, 93/68/EEC, 91/157/EEC
Type of Equipment:	Uninterruptible Power Supply
Model Number:	SUA60RXLBP3U
Manufacturer's Name and Address:	American Power Conversion 132 Fairgrounds Road West Kingston, Rhode Island, 02892, USA -or- American Power Conversion (A. P. C.) b. v. Ballybritt Business Park Galway, Ireland -or- American Power Conversion Main Avenue, Plaza Rosario, Cavite, Philippines -or- American Power Conversion 2nd Street, Plaza, Cavite Economic Zone Rosario, Cavite Philippines -or- American Power Conversion Lot 32 Phase 1 Carmelray Industrial Park Cambung, Calamba, Laguna Philippines -or- APC (Suzhou) UPS Co., Ltd No. 189 Subang Road, China-Singapore Suzhou Industrial Park Suzhou 215021, Jiangsu, P.R.C American Power Conversion (A. P. C.) b. v. Ballybritt Business Park Galway, Ireland
Importer's Name and Address:	
Place:	N. Billerica, MA U.S. Richard J. Everett, Sr. Regulatory Compliance Engineer 5 Jan 01
Place:	Galway, Ireland Ray S. Ballard, Managing Director, Europe 5 Jan 01 Phone: 353 917 02000 Fax: 353 9175 6009

LIMITED WARRANTY

American Power Conversion (APC) warrants its products to be free from defects in materials and workmanship for a period of two years from the date of purchase. Its obligation under this warranty is limited to repairing or replacing, at its own sole option, any such defective products. To obtain service under warranty you must obtain a Returned Material Authorization (RMA) number from customer support. Products must be returned with transportation charges prepaid and must be accompanied by a brief description of the problem encountered and proof of date and place of purchase. This warranty does not apply to equipment that has been damaged by accident, negligence, or misapplication or has been altered or modified in any way. This warranty applies only to the original purchaser who must have properly registered the product within 10 days of purchase.

EXCEPT AS PROVIDED HEREIN, AMERICAN POWER CONVERSION MAKES NO WARRANTIES, EXPRESSED OR IMPLIED, INCLUDING WARRANTIES OF MERCHANTABILITY AND FITNESS FOR A PARTICULAR PURPOSE. Some states do not permit limitation or exclusion of implied warranties; therefore, the aforesaid limitation(s) or exclusion(s) may not apply to the purchaser.

EXCEPT AS PROVIDED ABOVE, IN NO EVENT WILL APC BE LIABLE FOR DIRECT, INDIRECT, SPECIAL, INCIDENTAL, OR CONSEQUENTIAL DAMAGES ARISING OUT OF THE USE OF THIS PRODUCT, EVEN IF ADVISED OF THE POSSIBILITY OF SUCH DAMAGE. Specifically, APC is not liable for any costs, such as lost profits or revenue, loss of equipment, loss of use of equipment, loss of software, loss of data, costs of substitutes, claims by third parties, or otherwise.

Entire contents copyright © 2001 by American Power Conversion Corporation. All rights reserved. Reproduction in whole or in part without permission is prohibited.

APC, Smart-UPS, and PowerChute are registered trademarks of American Power Conversion Corporation. All other trademarks are the property of their respective owners.

Free Manuals Download Website

<http://myh66.com>

<http://usermanuals.us>

<http://www.somanuals.com>

<http://www.4manuals.cc>

<http://www.manual-lib.com>

<http://www.404manual.com>

<http://www.luxmanual.com>

<http://aubethermostatmanual.com>

Golf course search by state

<http://golfingnear.com>

Email search by domain

<http://emailbydomain.com>

Auto manuals search

<http://auto.somanuals.com>

TV manuals search

<http://tv.somanuals.com>