



**APC Smart-UPS<sup>®</sup> On-Line UX**  
**Models SUOL1000UXI and SUOL2000UXI**  
**220/230/240 Tower/Rack Mount**  
**Uninterruptible Power Supply**

**User's Manual**  
**English**

990-1137, 3/02



# 1: INSTALLATION

## UNPACKING

Inspect the UPS upon receipt. APC designed robust packaging for your product. However, accidents and damage may occur during shipment. Notify the carrier and dealer if there is damage.

The packaging is recyclable; save it for reuse or dispose of it properly.

Check the package contents. The shipping package contains the UPS; its front bezel (packaged separately); and a literature kit containing a software CD, one serial cable, power cords, a battery cable assembly, and product documentation.

## POSITIONING THE UPS

You must install the UPS in a protected area that is free of excessive dust and has adequate airflow. Ensure the air vents on the front and rear of the UPS are not blocked.

Do not operate the UPS where the temperature and humidity are outside the specified limits. Refer to the Specifications at the APC web site ([www.apc.com](http://www.apc.com)).

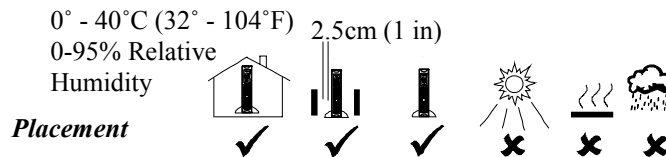

## INSTALLATION

### 1. ATTACH FRONT BEZEL

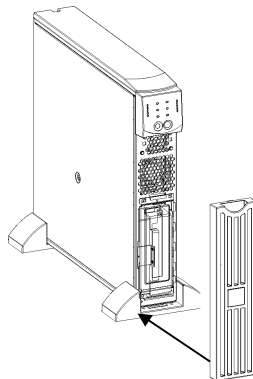

1. The UPS is shipped with the front bezel removed and packed separately within the main box. Unpack the bezel and hold it with the cutout section on top. Slide the tab on the bottom of the bezel into the slot on the bottom of the UPS. Gently snap the top of the bezel into place. The bezel can be removed by carefully unsnapping the top, and then sliding the bezel up and out of the tab on the bottom of the UPS.

## 2. CONNECT THE EXTERNAL BATTERIES

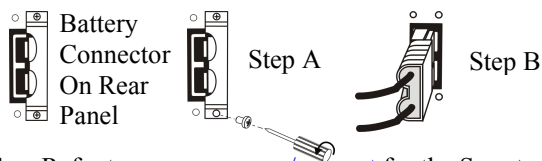

1. Refer to [www.apc.com/support](http://www.apc.com/support) for the Smart-UPS On-Line Battery Pack User Manual (990-1083).
2. If using a non-APC battery pack, a 48V battery string should be wired to the UPS using the enclosed battery cable assembly.

**Batteries must be Sealed Lead-Acid type.**

**Each string of four 12V batteries must be provided with an 80-100 amp fuse or fuse-able link to protect in the event of a short circuit.**

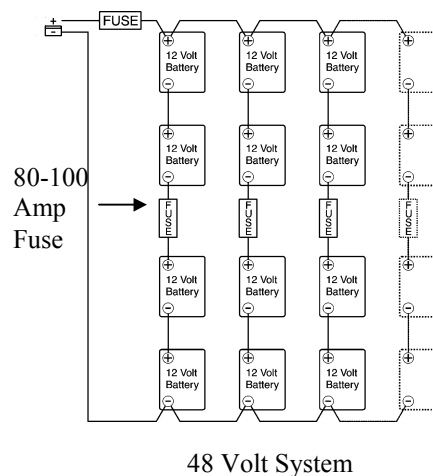

## 3. CONNECT THE EQUIPMENT TO THE UPS AND CONNECT THE UPS TO THE AC POWER SUPPLY

1. On the back panel, plug the female end of the power cord into the receptacle. Then plug the male end into a two-pole, three-wire, grounding receptacle. Avoid using extension cords and adapter plugs.
2. Connect the equipment to the UPS using the power cords provided with the equipment.
3. Turn on all connected equipment. To use the UPS as a master ON/OFF switch, be sure all connected equipment is switched on. The equipment will not be powered until the UPS is turned on.

## 4. TURN ON THE UPS

**Make sure the battery is connected before turning on the UPS!** Press the  button on the front panel to power up your UPS. This will power up connected equipment if that equipment is turned on.



The UPS charges the batteries when it is connected to utility power. **Do not** expect full run time during this initial charge period. Time depends on number and type of batteries.

The unit performs a self-test automatically when turned on and every two weeks thereafter (by default). Refer to the *User Configurable Items* section of this manual, below, for details on changing the default interval.

To turn on the UPS when no utility power is present, see the Cold Start function in the *Operations* section of this manual.

## 5. PROGRAMMING SMART-UPS ON-LINE WITH APPROPRIATE NUMBER OF BATTERY PACKS



It is important to follow these instructions. The number of batteries affects the run time calculations the Smart-UPS On-Line performs when it is running on battery power.

### 5A. USING POWERCHUTE® PLUS VERSION 5.X FOR WINDOWS 95, WINDOWS 98, WINDOWS NT

PowerChute *plus* 5.x for Windows NT is compatible with NT 3.5.1 SP5, NT 4.0 Workstation (at least SP1), or NT 4.0 Server (at least SP1).

Install the software per the instructions on the CD. After rebooting the computer, access the PowerChute *plus* graphical user interface.

Click on **Configuration**.

Click on **UPS Operating Parameters**.

Adjust the **External Battery Pack** field to the appropriate number of battery packs. \*See *User Configurables* in this manual.

Click **OK**.

### 5B. USING A TERMINAL PROGRAM

**EXIT** the PowerChute *plus* Server if running. In Windows NT, the UPS Service must be stopped.

Open a terminal program. For example to open Hyperterminal in Windows NT:

From the Desktop, go to **Start => Programs => Accessories => Hyperterminal**. Double-click on the **Hyperterminal** icon. You are prompted to choose a name and select an icon. Enter name and then click **OK**. Disregard the message, "...must install a modem," if it is displayed.

Select the COM port. The port settings are 2400 baud, 8 data bits, 1 stop bit, no parity, flow control off.

Once the terminal window is open, follow these steps to enter the number of external battery packs using the terminal mode within the Smart-UPS On-Line:

Hit the Enter key to initiate terminal mode. Following the prompts:

Hit 1 to modify UPS Settings. Hit e (or E) to modify the number of battery packs. Enter the number of battery packs followed by the Enter key. Enter YES (must be upper case) followed by the Enter key to confirm the new setting. Hit any key to continue. Hit the Esc key to return to the main menu. Hit the Esc key again to logout of terminal mode.

Exit the terminal program.

Restart the PowerChute *plus* Server if desired. In Windows NT, the UPS Service must be restarted if desired.

## 6. ACCESSORIES (OPTIONAL)

This UPS is equipped with an accessory slot. See the APC website ([www.apc.com](http://www.apc.com)) for available accessories.

For additional computer system security, install PowerChute **Plus**®, Smart-UPS monitoring software. It provides automatic unattended shutdown capabilities on most major network operating systems. PowerChute **Plus**® and its documentation are included on the CD that is packed with this UPS.

## 3: OPERATION

### FRONT PANEL

Power  
On



Power  
Off

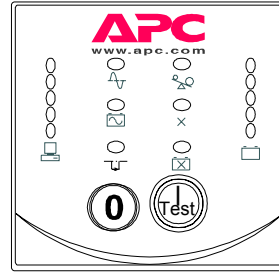

#### Cold Start

When the UPS is off and there is no utility power, use the cold start feature to apply power to the connected equipment from the UPS's battery. Cold start is

not a normal condition. To cold start the unit, push and hold the  button. You will hear a short beep then a long beep. During the long beep, release the button and the unit will cold start.

#### Load

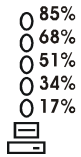

The five-LED display on the left of the front panel shows the percentage of available power used by the connected equipment (load). For example, if three LEDs are lit, the connected load is drawing between 51% and 68% of the UPS capacity. If all five LEDs are lit, the connected load is drawing between 85% and 100% of capacity. Thoroughly test your entire system to make sure that the UPS will not become overloaded. In the graphic to the left, the load capacity threshold is listed next to the LED (these values are not listed on the UPS).

#### SELF-TEST

##### Auto- matic Self- Test

The UPS performs a self-test automatically when turned on, and every two weeks thereafter (by default). Refer to the *User Configurable Items* table, below, for details on changing the default interval.

Automatic self-test eases maintenance requirements by eliminating the need for periodic manual self-tests. During the self-test, the UPS briefly operates the connected equipment on battery. If the UPS passes the self-test, it returns to online operation. If the UPS fails the self-test, the UPS lights the **Replace Battery** LED  and immediately returns to online operation. The connected equipment is not affected by a failed test. To confirm a self-test, failure, recharge the battery for 24 hours and perform another self-test. If it fails, the battery must be replaced.

##### Manual Self- Test

Press and hold the  button until the UPS beeps twice to initiate the self-test.

## UTILITY POWER

During normal operation, the UPS monitors the utility power and delivers power to the connected equipment. If your system is experiencing excessive periods of high or low voltage, have a certified electrician check your facility for electrical problems. If the problem continues, contact the utility company for further assistance.

**Online** The online indicator illuminates when the UPS is drawing utility power and performing double-conversion to supply clean power to the connected equipment.



**Utility Voltage** The UPS has a diagnostic feature that displays the utility voltage. Plug the UPS into the normal utility power.

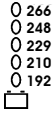

Press and hold the  button to view the utility voltage bar graph display. After a few seconds the five-LED display on the right of the front panel shows the utility input voltage. Refer to the figure at left for the voltage reading (values are not listed on the UPS).



The UPS starts a self-test as part of this procedure. The self-test does not affect the voltage display.

The display indicates the voltage is between the displayed value on the list and the next higher value. For example, with three LEDs lit, the input voltage is between 229 and 248 VAC.

If no LEDs are lit and the UPS is plugged into a working AC power outlet, the line voltage is extremely low.

If all five LEDs are lit, the line voltage is extremely high and should be checked by an electrician.

**Bypass** This LED illuminates to indicate the UPS is in Bypass mode. Battery backup is not available while in this mode. Utility power is being sent directly to connected loads. The UPS transfers to this mode due to a command received via the computer interface port or after a UPS internal fault.



**Fault** This LED illuminates to indicate the UPS has detected an internal fault. See the Troubleshooting section for details.



## BATTERY POWER

If the utility power fails, the UPS can provide power to the connected equipment from the batteries for a finite period. The UPS sounds an alarm—four beeps every 30 seconds—while operating on battery. The alarm stops when the UPS returns to online operation.

**On Battery** When the *On Battery* indicator is lit the UPS is supplying power to the connected equipment from its batteries.



### Battery Charge

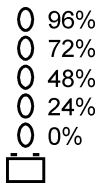

The five-LED display on the right of the front panel shows the present charge of the UPS battery as a percentage of the battery capacity. When all five LEDs are lit, the battery is fully charged. The LEDs extinguish, from top to bottom, as the battery capacity diminishes. Refer to the figure at left for the battery capacity threshold (values are not listed on the UPS).

As a low battery warning, any LEDs illuminated (for the given capacity) flash and the UPS beeps continuously. The low battery warning default setting can be changed in terminal mode or through the optional PowerChute software. Refer to *User Configurable Items*, below. To see the runtime in minutes for your UPS model refer to the Runtime Table at the APC website.

### Over-load



The UPS emits a sustained alarm tone and this LED illuminates when an overload condition occurs (that is, when the connected equipment exceeds the specified “maximum load” as defined in the specifications at the APC web site).

During an overload, the UPS may transfer to Bypass mode; after an overload situation is resolved, the UPS will transfer back to online mode. Disconnect non-essential equipment from the UPS to eliminate an overload.

### Replace Battery



Failure of a battery self-test causes the UPS to emit short beeps for one minute and the *Replace Battery* LED illuminates. The LED flashing indicates the battery is disconnected. The UPS repeats the alarm every five hours. Check that the battery pack is connected properly. If it is, perform the self-test procedure after the battery has charged for 24 hours to confirm the need to replace the battery. The alarm stops if the battery passes the self-test.

### SHUTDOWN MODE

In shutdown mode, the UPS stops supplying power to the connected equipment, waiting for the return of utility power. If there is no utility power present, external devices (such as servers) connected via the computer interface port or the accessory slot can command the UPS to shut down. This normally is done to preserve battery capacity after the shutdown of protected servers. The UPS scrolls the front panel indicators sequentially in shutdown mode.

### REAR PANEL

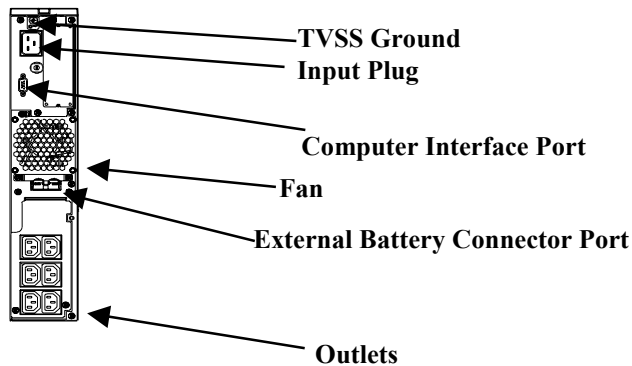



## BASIC CONNECTORS

### Computer Interface Port

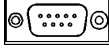

Power management software and interface kits can be used with the UPS. **Use only interface kits supplied or approved by APC.**



**Use the APC supplied cable to connect to the Computer Interface Port. DO NOT use a standard serial interface cable since it is incompatible with the UPS connector.**

### TVSS Screw

The UPS features a transient voltage surge-suppression (TVSS) screw for connecting the ground lead on surge suppression devices such as telephone and network line protectors.

### External Battery Connector Port



External battery packs can be obtained to connect to your UPS and give longer runtime during power outages. If used, unscrew the protective plate from in front of the connector port and insert the cable supplied with the battery pack into the connector port. Battery Packs can be daisy chained together to achieve desired run time.



To connect optional external battery pack(s) to the UPS, refer to the *Smart-UPS On-Line Battery Pack User's Manual* for instructions.

### Input Circuit Breaker

If the plunger on the circuit breaker pops out, reduce the load on the UPS by unplugging equipment and press the plunger in.

## ON BATTERY OPERATION

The UPS switches to battery operation automatically and an internal alarm sounds (periodic beeps) if the utility power fails. Press the ON button (front panel) to silence the UPS alarm until low battery (for the current outage only). You can change the audible indicator if you are using PowerChute software. If the utility power does not return, the UPS continues to supply power to the connected equipment until exhausted. The UPS will begin to beep continuously approximately two minutes before final low battery shutdown by default. If you are using a computer, you must manually save your files and power down before the UPS turns off, unless you are using PowerChute interface software that provides automatic, unattended shutdown.



UPS battery life differs based on usage and environment. It is recommended that the battery pack be changed once every three years.

## USER CONFIGURABLE ITEMS

<b>NOTE: SETTING THESE ITEMS REQUIRES SOFTWARE, OPTIONAL HARDWARE, OR CONFIGURATION IN TERMINAL MODE.</b>			
<b>FUNCTION</b>	<b>FACTORY DEFAULT</b>	<b>USER SELECTABLE CHOICES</b>	<b>DESCRIPTION</b>
Automatic Self-Test	Every 14 days (336 hours)	Every 7 days (168 hours), On Startup Only, No Self-Test	This function sets the interval at which the UPS will execute a self-test. Refer to your software manual for details.
UPS ID	UPS_IDEN	Up to eight characters to define the UPS	Use this field to uniquely identify the UPS for network management purposes.
Date of Last Battery Replacement	Manufacture Date	Date of Battery Replacement	Reset this date when you replace the battery pack.
Minimum Capacity Before Return from Shutdown	0 percent	15, 25, 35, 50, 60, 75, 90 percent	The UPS will charge its batteries to the specified percentage before return from a shutdown.
Duration of Low Battery Warning	2 minutes	5, 7, 10, 12, 15, 18, 20 minutes	This function sets the time before shutdown at which the UPS issues a low battery warning. Set it higher than the default if the operating system needs more time for shutdown.
Alarm Delay After Line Fail	5 second delay	30 second delay, At Low Battery Condition, No Alarm	Set the alarm delay to avoid alarms for minor power glitches.
Shutdown Delay	20 seconds	0, 60, 120, 240, 480, 720, 960 seconds	This function sets the interval between when the UPS receives a shutdown command and when shutdown occurs.
Synchronized Turn-on Delay	0 seconds	20, 60, 120, 240, 480, 720, 960 seconds	The UPS will wait the specified time after the return of utility power before turn-on (for example, to avoid branch circuit overload).
Output Voltage Setting	230 VAC	240, 220, 225 VAC	Nominal output voltage setting.
High Transfer Point	+ 10% of output voltage setting	+5%, +15%, +20%	Maximum voltage that the UPS will pass to the load during internal bypass operation.
Low Transfer Point	-30% of output voltage setting	-20%, -25%, -15%	Minimum voltage that the UPS will pass to the load during internal bypass operation.

<b>NOTE: SETTING THESE ITEMS REQUIRES SOFTWARE, OPTIONAL HARDWARE, OR CONFIGURATION IN TERMINAL MODE.</b>			
<b><i>FUNCTION</i></b>	<b><i>FACTORY DEFAULT</i></b>	<b><i>USER SELECTABLE CHOICES</i></b>	<b><i>DESCRIPTION</i></b>
Output Frequency	Automatic	50 ± 3 Hz, 50 ± 0.1 Hz, 60 ± 3 Hz, 60 ± 0.1 Hz	Sets the allowable output frequency of the UPS. Whenever possible, the output frequency tracks the input frequency. Automatic setting allows 50 +/-3 or 60 +/-3 Hz depending on the input frequency.
Unit Position	Tower	Rack Mount	The operating configuration of the UPS. Optional Rail Kit SUOLRK is required to convert to rack mount configuration.
Number of Battery Packs	1	Number of connected battery packs.	Defines number of battery packs for proper runtime prediction. One battery pack is equivalent to 864VAh (48V x 18Ah).

## **TERMINAL MODE**

Terminal mode is a menu driven interface that allows for enhanced configuration of the UPS. This interface can be accessed using a computer and a common serial communication application, such as Hyperterminal. To enter and use the Terminal Mode:

1. Connect a computer to the UPS using the cable supplied with your UPS.
2. Launch a standard serial communication application, such as Hyperterminal.
3. Specify the communications port (comm. port) to which you have connected.
4. Set the following properties: 2400 baud, 8 data bits, no parity, one stop bit, and no flow control.
5. Press the enter or return key.
6. Follow the instructions on the screen to continue in Terminal Mode.

## 4: TRANSPORT, MAINTENANCE, AND TROUBLESHOOTING

### TRANSPORTING YOUR UPS



Always **DISCONNECT THE BATTERY** before shipping in compliance with U.S. Department of Transportation (DOT) regulations.

This requirement applies whether the UPS is shipped alone or installed in an equipment rack or system.

Follow these steps to prepare the UPS for transport.



Due to its weight, removing the UPS from a rack requires two people.

1. Shut down any equipment attached to the UPS.
2. Disconnect the UPS from the power supply.
3. If your unit is in the Tower Configuration, skip this step and continue with Step 4, below. To remove the unit from a rack, reverse the steps for installation of the UPS into the rack found in the *Rack Mount Installation Sheet* found in the *Rail Kit*.
4. Remove the front bezel. If you are using the original UPS packaging, you must pack the front bezel separate from the UPS. Reverse the step for attaching the front bezel found in the *Installation* section of this manual.
5. Disconnect the external battery.
6. Your UPS can now be placed in its original packaging for transport.

### STORAGE

#### **STORAGE CONDITIONS:**

Store the UPS in a cool, dry location, with its batteries fully charged. Disconnect any cables connected to the computer interface port to avoid unnecessary battery drainage.

## TROUBLESHOOTING

Use the chart below to solve minor UPS installation problems. Refer to the APC web site [www.apc.com](http://www.apc.com) for assistance with complex UPS problems.

PROBLEM AND POSSIBLE CAUSE	SOLUTION
<b>UPS WILL NOT TURN ON</b>	
ON button not pushed.	Press the ON button once to power the UPS and the equipment.
UPS not connected to power supply.	Check that the power cable from the UPS to the utility power supply is securely connected.
UPS input circuit breaker tripped.	Reduce the load on the UPS by unplugging equipment and resetting the circuit breaker (on the back of UPS) by pressing the plunger in.
Very low or no utility voltage.	Check the AC power supply to the UPS by plugging in a table lamp. If the light is very dim, have the utility voltage checked.
External battery not connected properly.	Check that the battery connector is fully engaged.
<b>UPS OPERATES ON BATTERY ALTHOUGH NORMAL LINE VOLTAGE EXISTS</b>	
UPS input circuit breaker tripped.	Reduce the load on the UPS by unplugging equipment and resetting the circuit breaker (on the back of UPS) by pressing the plunger in.
Very high, low, or distorted line voltage. Inexpensive fuel powered generators can distort the voltage.	Move the UPS to a different outlet on a different circuit. Test the input voltage with the utility voltage display.
<b>BYPASS LED IS LIT, THE OVERLOAD LED IS LIT, AND THE FAULT LED IS LIT</b>	
Too many loads have been connected to the UPS.	Remove all nonessential loads. Push the ON button to restore power.
External overload condition.	Wait until overload condition passes. You may need to push the ON button to reset the UPS.
<b>FAULT LED IS LIT, THE OVERLOAD LED IS LIT, AND THE BYPASS LED IS NOT LIT</b>	
Overload condition.	Remove all nonessential loads. Push the OFF button, then the ON button to restore power.
<b>FAULT LED IS LIT AND THE OVERLOAD LED IS NOT LIT</b>	
Internal UPS fault.	Do not attempt to use the UPS. Turn the UPS off and have it serviced immediately.
<b>REPLACE BATTERY LED IS LIT</b>	
Weak battery.	Allow the battery to recharge for at least twenty-four hours. Then, perform a self-test. If the problem persists after recharging, replace the battery.
Battery not connected properly.	Check that the battery connector is fully engaged.
<b>UPS BEEPS OCCASIONALLY</b>	
Normal UPS operation.	None. The UPS is protecting the connected equipment.
<b>UPS DOES NOT PROVIDE EXPECTED BACKUP TIME</b>	
Batteries are weak due to recent outage or are near end of service life.	Charge the batteries. Batteries require recharging after extended outages. They wear faster when put into service often or when operated at elevated temperatures. If the battery pack is near the end of its service life, consider replacing it even if the <i>Replace Battery</i> LED is not yet lit.
<b>FRONT PANEL INDICATORS FLASH SEQUENTIALLY</b>	
UPS was shut down remotely.	None. The UPS will restart automatically when utility power returns.

## SERVICE

1. Review the problems discussed in the *Troubleshooting* section of this manual to eliminate common problems.
2. Verify that no circuit breakers are tripped. A tripped circuit breaker is the most common problem.
3. If the problem persists, call APC Customer Service or visit the APC website ([www.apc.com](http://www.apc.com)).
  - Note the model number of the unit, the serial number, and the date purchased. If you call APC Customer Service, a technician will ask you to describe the problem and try to solve it over the phone, if possible. If this is not possible the technician may arrange for the unit to be serviced or may issue a Returned Material Authorization Number (RMA#).
  - If the unit is under warranty, repairs are free. If not, there is a repair charge.
  - Procedures for servicing or returning your unit may vary internationally. Please contact the APC Customer Service office in the appropriate country ([www.apc.com/support](http://www.apc.com/support)) for questions about warranty and RMA.
4. Pack the unit in its original packaging. If the original packing is not available, ask APC Customer Service about obtaining a new set.

Pack properly to avoid damage in transit. Never use Styrofoam beads for packaging. Damage sustained in transit is not covered under warranty.



**Always DISCONNECT THE BATTERY before shipping in compliance with U.S. Department of Transportation (DOT) regulations.**

5. Mark the RMA# on the outside of the package.
6. Return the unit by insured, prepaid carrier to the address given to you by Customer Service.

## 5: CONTACT, REGULATORY, AND WARRANTY INFORMATION

### CONTACTING APC

Refer to the information provided at the APC Internet site:

<http://www.apc.com/support>

### REGULATORY AGENCY APPROVALS



### DECLARATION OF CONFORMITY

CE		2001	
EC Declaration of Conformity			
We, the undersigned, declare under our sole responsibility that the equipment specified below conforms to the following standards and directives:			
<b>Standards to Which Conformity Declared:</b>	EN55022; EN50091-2; En60950; EN50091-1-1, 2; 55024; IEC60950; EN61000-3-2, 3-3, 4-2, 4-3, 4-4, 4-5, 4-6, 4-8, 4-11		
<b>Application of Council Directives:</b>	73/23/EEC, 93/68/EEC 89/336/EEC, 92/31/EEC, 91/157/EEC		
<b>Type of Equipment:</b>	Uninterruptible Power Supply		
<b>Model Numbers:</b>	SUOL1000XLI, SUOL2000XLI, SUOL1000UXI, SUOL2000UXI		
<b>Manufacturer's Name and Address:</b>	American Power Conversion 132 Fairgrounds Road West Kingston, Rhode Island, 02892, USA -or- American Power Conversion (A. P. C.) b. v. Ballybritt Business Park Galway, Ireland -or- American Power Conversion Main Avenue, Peza Rosario, Cavite, Philippines -or- American Power Conversion 2nd Street, Peza, Cavite Economic Zone Rosario, Cavite Philippines -or- American Power Conversion Lot 32 Phase 1 Camelray Industrial Park Canlubang, Calamba, Laguna Philippines -or- APC (Suzhou) UPS Co., Ltd No. 189 Suhong Road, China-Singapore Suzhou Industrial Park Suzhou 215021, Jiangsu, P.R.C		
<b>Importer's Name and Address:</b>	American Power Conversion (A. P. C.) b. v. Ballybritt Business Park Galway, Ireland		
<b>Place:</b>	N. Billerica, MA U.S.	<i>Richard J. Everett</i>	5 Jan 02
		Richard J. Everett, Sr. Regulatory Compliance Engineer	
<b>Place:</b>	Galway, Ireland	<i>Ray S. Ballard</i>	5 Jan 02
		Ray S. Ballard, Managing Director, Europe	

## LIMITED WARRANTY

American Power Conversion (APC) warrants its products to be free from defects in materials and workmanship for a period of two years from the date of purchase. Its obligation under this warranty is limited to repairing or replacing, at its own sole option, any such defective products. To obtain service under warranty you must obtain a Returned Material Authorization (RMA) number from customer support. Products must be returned with transportation charges prepaid and must be accompanied by a brief description of the problem encountered and proof of date and place of purchase. This warranty does not apply to equipment that has been damaged by accident, negligence, or misapplication or has been altered or modified in any way. This warranty applies only to the original purchaser who must have properly registered the product within 10 days of purchase.

EXCEPT AS PROVIDED HEREIN, AMERICAN POWER CONVERSION MAKES NO WARRANTIES, EXPRESSED OR IMPLIED, INCLUDING WARRANTIES OF MERCHANTABILITY AND FITNESS FOR A PARTICULAR PURPOSE. Some states do not permit limitation or exclusion of implied warranties; therefore, the aforesaid limitation(s) or exclusion(s) may not apply to the purchaser.

EXCEPT AS PROVIDED ABOVE, IN NO EVENT WILL APC BE LIABLE FOR DIRECT, INDIRECT, SPECIAL, INCIDENTAL, OR CONSEQUENTIAL DAMAGES ARISING OUT OF THE USE OF THIS PRODUCT, EVEN IF ADVISED OF THE POSSIBILITY OF SUCH DAMAGE. Specifically, APC is not liable for any costs, such as lost profits or revenue, loss of equipment, loss of use of equipment, loss of software, loss of data, costs of substitutes, claims by third parties, or otherwise.

Entire contents copyright © 2002 by American Power Conversion Corporation. All rights reserved. Reproduction in whole or in part without permission is prohibited.

APC, Smart-UPS, and PowerChute are registered trademarks of American Power Conversion Corporation. All other trademarks are the property of their respective owners.



## Free Manuals Download Website

<http://myh66.com>

<http://usermanuals.us>

<http://www.somanuals.com>

<http://www.4manuals.cc>

<http://www.manual-lib.com>

<http://www.404manual.com>

<http://www.luxmanual.com>

<http://aubethermostatmanual.com>

Golf course search by state

<http://golfingnear.com>

Email search by domain

<http://emailbydomain.com>

Auto manuals search

<http://auto.somanuals.com>

TV manuals search

<http://tv.somanuals.com>