

STATEMENT D2v OPERATING MANUAL

ANHEM®



UPDATES: www.anthemAV.com

SOFTWARE VERSION 2.0x





SONIC FRONTIERS
INTERNATIONAL

BREAKING THE SOUND BARRIER™

SAFETY PRECAUTIONS

READ THIS SECTION CAREFULLY BEFORE PROCEEDING!

	WARNING RISK OF ELECTRIC SHOCK DO NOT OPEN	
<p>WARNING: TO REDUCE THE RISK OF ELECTRIC SHOCK, DO NOT REMOVE COVER (OR BACK). NO USER-SERVICEABLE PARTS INSIDE. REFER SERVICING TO QUALIFIED SERVICE PERSONNEL.</p>		



The lightning flash with arrowpoint within an equilateral triangle warns of the presence of uninsulated "dangerous voltage" within the product's enclosure that may be of sufficient magnitude to constitute a risk of electric shock to persons.



The exclamation point within an equilateral triangle warns users of the presence of important operating and maintenance (servicing) instructions in the literature accompanying the appliance.

WARNING: TO REDUCE THE RISK OF FIRE OR ELECTRIC SHOCK, DO NOT EXPOSE THIS PRODUCT TO RAIN OR MOISTURE AND OBJECTS FILLED WITH LIQUIDS, SUCH AS VASES, SHOULD NOT BE PLACED ON THIS PRODUCT.

CAUTION: TO PREVENT ELECTRIC SHOCK, MATCH WIDE BLADE OF PLUG TO WIDE SLOT, FULLY INSERT.

CAUTION: FOR CONTINUED PROTECTION AGAINST RISK OF FIRE, REPLACE THE FUSE ONLY WITH THE SAME AMPERAGE AND VOLTAGE TYPE. REFER REPLACEMENT TO QUALIFIED SERVICE PERSONNEL.

WARNING: UNIT MAY BECOME HOT. ALWAYS PROVIDE ADEQUATE VENTILATION TO ALLOW FOR COOLING. DO NOT PLACE NEAR A HEAT SOURCE, OR IN SPACES THAT CAN RESTRICT VENTILATION.

IMPORTANT SAFETY INSTRUCTIONS

- 1. Read Instructions** – All the safety and operating instructions should be read before the product is operated.
- 2. Retain Instructions** – The safety and operating instructions should be retained for future reference.
- 3. Heed Warnings** – All warnings on the product and in the operating instructions should be adhered to.
- 4. Follow Instructions** – All operating and use instructions should be followed.
- 5. Cleaning** – Unplug this product from the wall outlet before cleaning. Do not use liquid cleaners or aerosol cleaners. Use a damp, soft cloth for cleaning.
- 6. Water and Moisture** – Do not use this product near water – for example, near a bath tub, wash bowl, kitchen sink, or laundry tub; in a wet basement; or near a swimming pool; and the like.
- 7. Accessories** – Do not place this product on an unstable cart, stand, tripod, bracket, or table. The product may fall, causing serious injury to a child or adult, and serious damage to the product. Use only with a cart, stand, tripod, bracket, or table recommended by the manufacturer, or sold with the product. Any mounting of the product should follow manufacturer's instructions, and should use a mounting accessory recommended by the manufacturer.

8. **Ventilation** – Slots and openings in the cabinet are provided for ventilation and to ensure reliable operation of the product and to protect it from overheating, and these openings must not be blocked or covered. The openings should never be blocked by placing the product on a bed, sofa, rug, or other similar surface. This product should not be placed in a built-in installation such as a bookcase or rack unless proper ventilation is provided or the manufacturer's instructions have been adhered to.
9. **Power Sources** – This product should be operated only from the type of power source indicated on the marking label. If you are not sure of the type of power supply to your home, consult your product dealer or local power company. For products intended to operate from battery power, or other sources, refer to the operating instructions.
10. **Grounding and Polarization** – This product may be equipped with a polarized alternating-current line plug (a plug having one blade wider than the other). This plug will fit into the power outlet only one way. This is a safety feature. If you are unable to insert the plug fully into the outlet, try reversing the plug. If the plug should still fail to fit, contact your electrician to replace your obsolete outlet. Do not defeat the safety purpose of the polarized plug.
11. **Power-cord Protection** – Power-supply cords should be routed so that they are not likely to be walked on or pinched by items placed upon or against them, paying particular attention to cords at plugs, convenience receptacles, and the point where they exit from the product.
12. **Outdoor Antenna Grounding** – If an outside antenna or cable system is connected to the product, be sure the antenna or cable system is grounded so as to provide some protection against voltage surges and built-up static charges. Article 810 of the National Electrical Code, ANSI/NFPA 70, provides information with regard to the proper grounding of the mast and supporting structure, grounding of the lead-in wire to an antenna-discharge unit, size of grounding conductors, location of antenna-discharge unit, connection to grounding electrodes, and requirements for the grounding electrode.

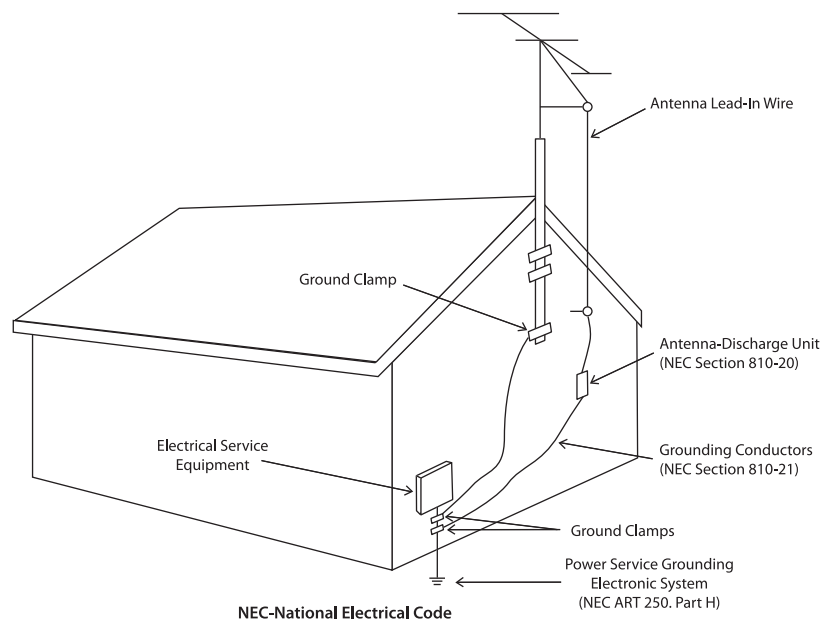

S2898A

13. **Lightning** – For added protection for this product during a lightning storm, or when it is left unattended and unused for long periods of time, unplug it from the wall outlet and disconnect the antenna or cable systems. This will prevent damage to the product due to lightning and power-line surges.
14. **Power Lines** – An outside antenna system should not be located in the vicinity of overhead power lines or other electric light or power circuits, or where it can fall into such power lines or circuits. When installing an outside antenna system, extreme care should be taken to keep from touching such power lines or circuits as contact with them might be fatal.
15. **Overloading** – Do not overload wall outlets, extension cords, or integral convenience receptacles as this can result in a risk of fire or electric shock.

- 16. Object and Liquid Entry** – Never push objects of any kind through openings as they may touch dangerous voltage points or short-out parts that could result in a fire or electric shock. Do not expose this product to dripping or splashing and ensure that no objects filled with liquids, such as vases, are placed on the product.
- 17. Servicing** – Do not attempt to service this product yourself, as opening or removing covers may expose you to dangerous voltage or other hazards. Refer all servicing to qualified service personnel.
- 18. Damage Requiring Service** – Unplug this product from the wall outlet and refer servicing to qualified personnel under the following conditions:
- When power-supply cord or plug is damaged.
 - If liquid has been spilled, or objects have fallen into the product.
 - If the product has been exposed to rain or water.
 - If the product does not operate normally by following the operating instructions. Adjust only those controls that are covered by the operating instructions as an improper adjustment of other controls may result in damage and will require extensive work by a qualified technician to restore the product to its normal operation.
 - If the product has been dropped or damaged in any way.
 - If the product exhibits a distinct change in performance – this indicates a need for service.
- 19. Replacement Parts** – When replacement parts are required, be sure the technician has used replacement parts specified by the manufacturer or have the same characteristics as the original part. Unauthorized substitutions may result in fire, electric shock, or other hazards.
- 20. Safety Check** – Upon completion of any service or repairs to this product, ask the service technician to perform safety checks to determine that the product is in proper operating condition.
- 21. Heat** – The product should be situated away from heat sources such as radiators, heat registers, stoves, or other products (including amplifiers) that produce heat.



RECYCLING AND REUSE GUIDELINES (Europe)

In accordance with the European Union WEEE (Waste Electrical and Electronic Equipment) directive effective August 13, 2005, we would like to notify you that this product may contain regulated materials which, upon disposal, require special reuse and recycling processing. For this reason Paradigm Electronics Inc. (the manufacturer of Paradigm speakers and Anthem electronic products) has arranged with its distributors in European Union member nations to collect and recycle this product at no cost to you. To find your local distributor please contact the dealer from whom you purchased this product or go to our website at www.paradigm.com.

Please note that only the product falls under the WEEE directive. When disposing of packaging and other shipping material we encourage you to recycle through the normal channels.

Anthem, Anthem Statement, AnthemLogic, ARC, Sonic Frontiers, and Paradigm are trademarks or registered trademarks of Paradigm Electronics Inc. Copyright Paradigm Electronics Inc. All rights reserved. The information contained herein may not be reproduced in whole or in part without our express written permission. We reserve the right to change specifications and/or features without notice as design improvements are incorporated.

Manufactured under license from Dolby Laboratories. Dolby, Pro Logic, and the double-D symbol are trademarks of Dolby Laboratories.

Manufactured under license under U.S. Patent #'s: 5,451,942; 5,956,674; 5,974,380; 5,978,762; 6,226,616; 6,487,535; 7,212,872; 7,333,929; 7,392,195; 7,272,567 & other U.S. and worldwide patents issued & pending. DTS is a registered trademark and the DTS logos, Symbol, DTS-HD and DTS-HD Master Audio are trademarks of DTS, Inc. © 1996-2008 DTS, Inc. All Rights Reserved.

Manufactured under license from THX Ltd. U.S. patent numbers 5,043,970; 5,189,703; and/or 5,222,059. European patent number 0323830. Other U.S. and foreign patents pending. Ultra2 and THX are trademarks or registered trademarks of THX Ltd. Lucasfilm is a trademark of Lucasfilm Ltd. Surround EX is a trademark of Dolby Laboratories. Used under authorization.

This product incorporates copyright protection technology that is protected by U.S. patents and other intellectual property rights. Use of this copyright protection technology must be authorized by Macrovision, and is intended for home and other limited viewing uses only unless otherwise authorized by Macrovision. Reverse engineering or disassembly is prohibited.

HDMI, the HDMI logo and High-Definition Multimedia Interface are trademarks or registered trademarks of HDMI Licensing LLC.

VXP, Visual Excellence Processing and the VXP logo are trademarks or registered trademarks of Sigma Designs, Inc.

All other trademarks are the property of their respective owners.

TABLE of CONTENTS

SECTION	PAGE
1. INTRODUCTION	
1.1 Before Making Connections.....	1
1.2 In-Use Notices	1
1.3 Front Panel.....	2
1.4 Front Panel Display	3
1.5 Rear Panel	4
1.6 Remote Control	5
1.7 Speaker Placement.....	6
1.8 Interconnects	7
2. CONNECTIONS	
2.1 Video	8
2.2 Audio	9
2.3 FM•AM Antennas	11
2.4 12 Volt Triggers	11
2.5 Powered IR (Infra Red) Receivers.....	11
2.6 IR (Infra Red) Emitters.....	11
2.7 Power.....	11
3. SETUP	
Entering / Navigating / Exiting the Setup Menu	15
3.1 Video Output	16
3.2 Set Time and Timers.....	21
3.3 Speaker Configuration.....	24
3.4 Listener Position	29
3.5 Level Calibration	30
3.6 Source Setup	32
3.7 Mode Presets	36
3.8 Analog Input Levels	37
3.9 ADC and Audio Output	38
3.10 Volumes and Path Names	39
3.11 Triggers, IR, and RS-232	40
3.12 Displays and Timeout	42
3.13 Save and Load Settings	44
3.14 Lockout and Passwords	45
3.15 ARC-1 Anthem Room Correction	46

4. OPERATION

4.1 Power On and Off	50
4.2 Path Selection	50
4.3 Manually Copying the Main Path to Zone2/3 and Record	51
4.4 Source Selection	51
4.4.1 FM•AM Tuner	52
4.4.2 Simulcast	52
4.5 Volume Control	53
4.6 Level Trim	53
4.7 Bass, Treble, and Balance	54
4.8 Surround Modes	54
4.8.1 AnthemLogic	55
4.8.2 Dolby Digital 2.0	55
4.8.3 Surround Modes for 2.0-Channel Sources	56
4.8.4 Dolby Digital	57
4.8.5 DTS	57
4.8.6 THX	58
4.8.7 Mode and THX options for 2.0-channel sources	60
4.8.8 Mode and THX options for 5.1-channel Dolby sources and 6-Ch S/E	61
4.8.9 Mode and THX options for 5.1-channel DTS sources	62
4.8.10 Dynamics	63
4.9 Lip-Sync Delay	63
4.10 Display Brightness	63
4.11 Video Source Adjustment	64
Picture	65
Crop Input	67
Scale Output	68
Aspect Ratio Control Examples	69
Output	71
Test Patterns	72
Info Panel	73
Shortcuts and emergency exits	73
4.12 Sleep Timer	74
4.13 Enable and Disable Timers	74
4.14 Status Display	74

5. REMOTE CONTROL CUSTOMIZATION

5.1 Codes for Other Brands	75
5.2 Learning Commands	75
5.3 Copying Commands	76
5.4 Volume Lock	76
5.5 Programming Macros	77
5.6 Resetting the Remote Control	77

6. SOFTWARE UPDATING

6.1 Software Version Identification	78
6.2 Software Updating Via Your Dealer.....	78
6.3 Software Updating Via Your Computer and the Internet	78
Appendix A – IR Macros for Surround Modes and FM•AM Banks	80
Appendix B – Preset Memory Codes	81
Specifications	88
Warranty	91
Big Pictures of Front and Rear Panels	Inside Back Cover

1. INTRODUCTION

Thank you for purchasing the Anthem Statement D2v processor.

The Statement D2v is a cutting-edge home theater audio processor with HDMI switching and video upconversion, multizone capabilities, and FM/AM tuner, along with state of the art video processing which includes deinterlacing, scaling, aspect ratio control, and picture adjustment. Anthem products are engineered to recreate the passion of live performance and thrill of the best movie theaters by using the highest level of circuit design, proprietary software, superior build quality, innovative features, and intuitive ergonomics with tremendous flexibility.

1.1 BEFORE MAKING CONNECTIONS

Check that you have received everything listed below and report discrepancies to your dealer as soon as possible. In case they are needed one day, keep the packing materials and the invoice that you received from your authorized Anthem dealer at time of purchase – without it, service will not be provided under warranty.

Packing List:

- Statement D2v
- 2 Remote controls
- 4 AA batteries
- FM antenna
- FM antenna adapter
- AM loop antenna
- IR terminal block (on rear panel)
- Power cord (North America only)

Additional items with ARC-1 Anthem Room Correction:

- Software installation CD
- Serial extension cable
- Microphone and clip
- USB microphone cable
- Telescopic stand
- Base



Safety Instructions:

- Read all precautions and instructions at the beginning of this manual.
- Do not connect power if there are signs of damage to any part of the exterior.
- The front panel power buttons and the rear panel AC switch do not disconnect the product from the AC line. Ensure that the power cord remains readily accessible at all times.
- To connect power, only use the supplied double-insulated power cord.
- Allow adequate ventilation to ensure reliable operation and to prevent overheating. The amount of space required above the unit for radiation depends on ambient air temperature and circulation. Installation inside an unventilated space such as a cabinet with a front that can be closed or a closet is not recommended.
- Failing to comply with any safety instruction, precaution, or warning in this operating manual is in violation of the intended use of the product.
- Anthem and any related party assume no liability for the user's failure to comply with requirements.

1.2 IN-USE NOTICES

- Disconnect the power cord before connecting or disconnecting any components.
- If the processor was transported or stored in the cold, let it warm to room temperature before use.
- Do not remove the top cover.
- Do not modify the product.
- Due to continuing advances operational characteristics may change. If this manual contains discrepancies please check www.anthemAV.com for the latest manual or software.

1. INTRODUCTION continued ...

1.3 FRONT PANEL

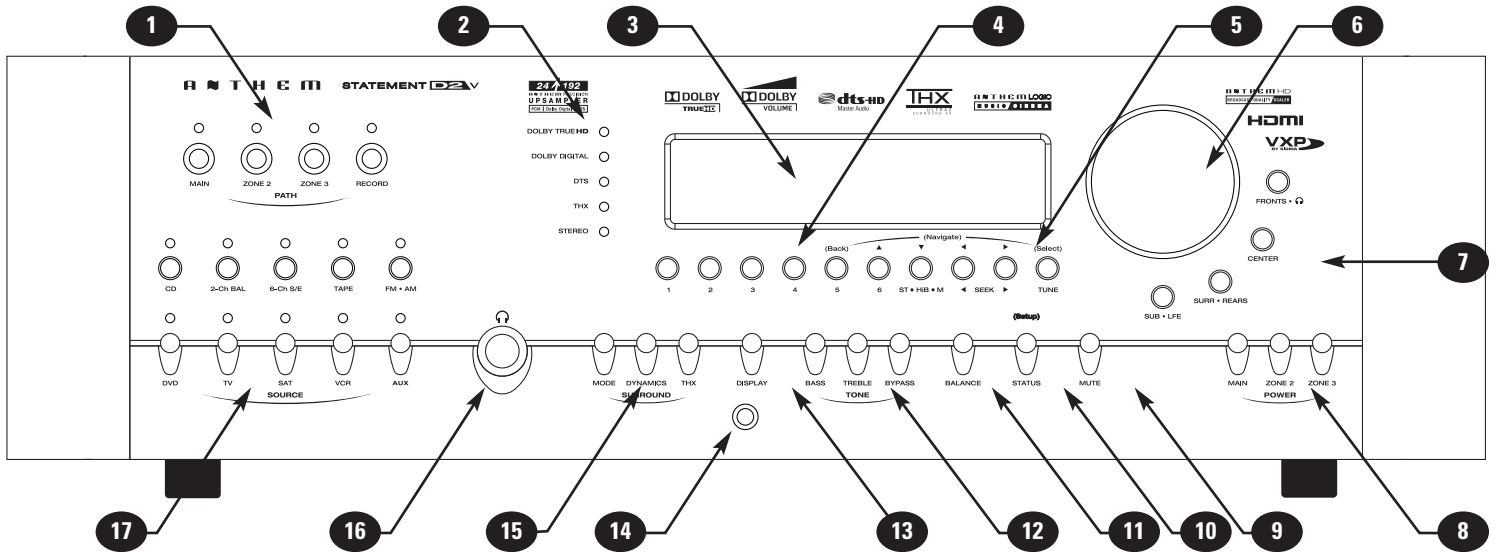

- | | |
|--|--|
| 1 – Path selection | 9 – Mute |
| 2 – Mode and decoder indicators | 10 – Status review / setup menu access |
| 3 – Display | 11 – Balance setting |
| 4 – FM•AM preset selection | 12 – Bass / treble settings |
| 5 – FM•AM tuning / setup menu navigation | 13 – LED and display brightness setting / video adjustment menu access |
| 6 – Master Control Knob: | 14 – Front panel IR sensor |
| • Volume | 15 – Surround mode / Dynamics / THX options / shortcuts to most common video adjustments |
| • Tune for FM•AM | 16 – Headphone jack |
| • Settings adjustment | 17 – Source selection |
| • Setup for time and source naming | |
| 7 – Speaker group and headphone access | |
| 8 – Power on / standby | |

For a larger diagram see inside back cover.

1. INTRODUCTION continued ...

1.4 FRONT PANEL DISPLAY

MAIN Display Example:

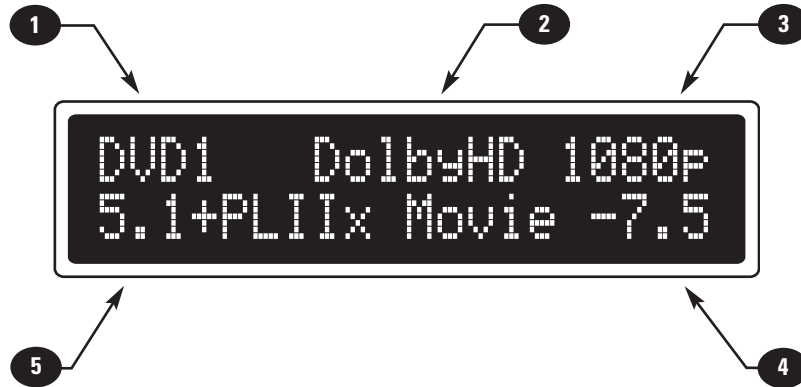

- 1 – Source selection.
- 2 – Audio input format or sleep timer if engaged.
- 3 – Video **input** resolution.
- 4 – Volume.
- 5 – Number of input channels + surround mode.

FM•AM Display Example:

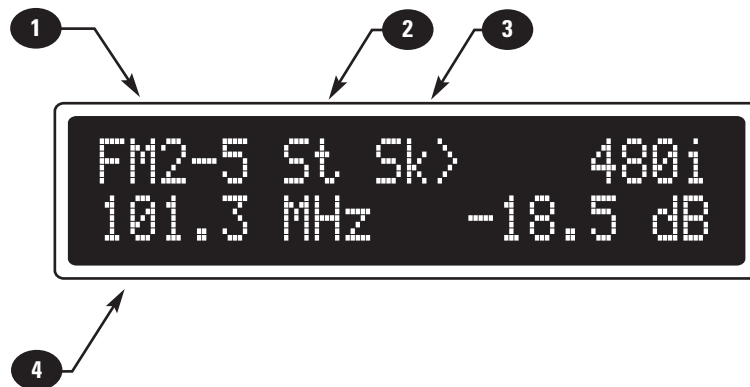

- 1 – Band+bank+preset. The tuner has three FM banks (FM1, FM2, and FM3) and one AM bank.
- 2 – FM mode. Displays "St" when in stereo, "HB" when in Hi-Blend, or "Mn" when in mono.
- 3 – Seek and scan indications.
- 4 – Frequency. FM is tuned to the nearest 0.1 MHz. AM is tuned to nearest 10 kHz (120V model) or 9 kHz (230V model).

The above information is also shown on-screen. For the video outputs that produce it, see section 3.

1. INTRODUCTION continued ...

1.5 REAR PANEL

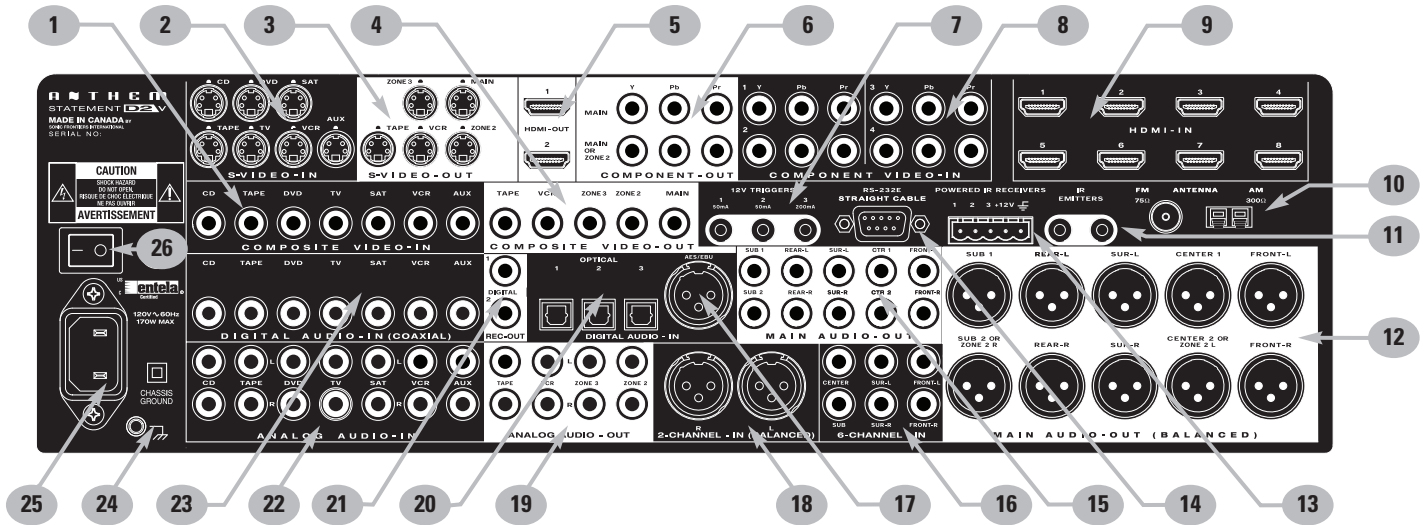

- | | |
|--|---|
| 1 – 7 composite video inputs | 14 – RS-232 interface (bidirectional) |
| 2 – 7 S-Video inputs | 15 – Main audio output (10 jacks) |
| 3 – 5 S-Video outputs | 16 – 6-channel analog audio input |
| 4 – 5 composite video outputs | 17 – AES/EBU digital audio input |
| 5 – 2 HDMI outputs (parallel) | 18 – Analog audio balanced L/R input |
| 6 – 2 component video outputs (3 jacks/ea) | 19 – ZONE2, ZONE3, and REC analog audio outputs |
| 7 – 3 12V trigger outputs | 20 – 3 optical digital audio inputs |
| 8 – 4 component video inputs (3 jacks/ea) | 21 – 2 digital audio REC outputs |
| 9 – 8 HDMI inputs | 22 – 7 analog audio L/R inputs |
| 10 – FM and AM antenna connections | 23 – 7 digital audio coaxial inputs |
| 11 – 2 IR emitters | 24 – Ground terminal |
| 12 – Main audio output (10 balanced jacks) | 25 – Power cord connection |
| 13 – 3 IR extension inputs with 12V supply | 26 – AC switch |

For a larger diagram see inside back cover.

1. INTRODUCTION continued ...

1.6 REMOTE CONTROL

- 1 – IR transmitter (front face)
- 2 – LED
- 3 – Power on for MAIN, ZONE2, and ZONE3
Power on/off for other control modes
This key does not turn off the processor (see #31)
- 4 – Control mode (to control other components)
These are not the source selection keys (see #19)
- 5 – FM•AM preset setting and selection
- 6 – Tone bypass
- 7 – Mode / video adjustments (press and hold for 3 seconds)
- 8 – Dynamics setting
- 9 – FM•AM preset up
- 10 – FM•AM preset down
- 11 – Sleep timer selection / timers setting
- 12 – Center channel selection for level / bass / treble
- 13 – Back (for Setup)
- 14 – Subwoofer / LFE selection for level adjustment
- 15 – Setup (press and hold for 3 seconds)
- 16 – Source seek
- 17 – Balance
- 18 – RECORD path selection (must be in MAIN – see #4)
- 19 – Source selection
- 20 – Copy MAIN when ZONE2, ZONE3, or RECORD is selected
- 21 – Bass selection for adjustment
- 22 – Treble selection for adjustment
- 23 – Surrounds / rears selection for level / bass / treble / balance
- 24 – • FM•AM tuning
• Adjustment for surround mode, dynamics, THX, levels, bass / treble, timers, brightness
• Setup navigation
- 25 – • FM•AM seek
• Balance adjustment
• Setup navigation
- 26 – Status / FM•AM direct entry / setup selection
- 27 – Fronts / headphones selection for level / bass / treble / balance
- 28 – Volume down
- 29 – THX selection
- 30 – Volume up
- 31 – Power off when in MAIN, ZONE2, or ZONE3 control mode
- 32 – Mute
- 33 – Front panel LED / display brightness setting / lip-sync delay
- 34 – On-screen display of current front panel display
- 35 – Scaler menu – press and hold for 3 seconds
- 36 – Learn – for customization of remote

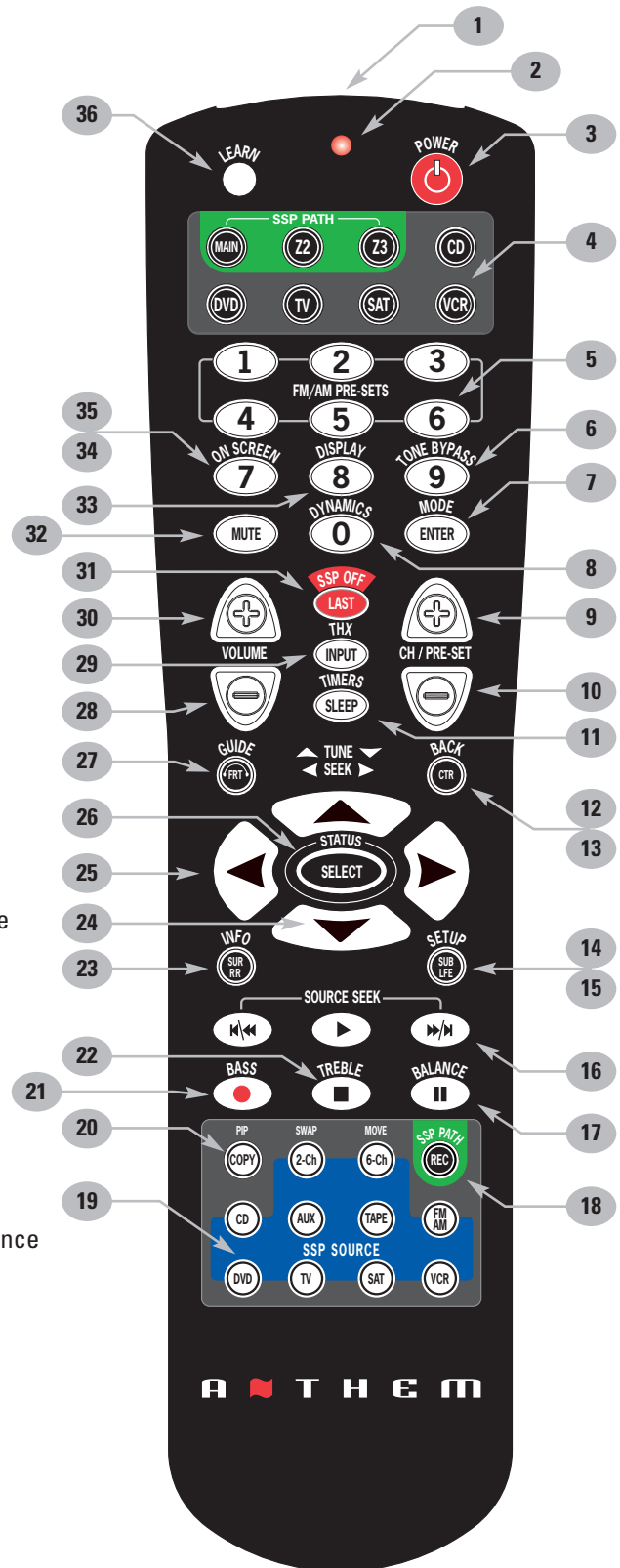

Rear: Battery cover (when batteries are running low and a key is pressed, the backlight stops working and the LED blinks twice)

1. INTRODUCTION continued ...

1.7 SPEAKER PLACEMENT

These illustrations show typical speaker placement for a 7.1-channel surround system. The surround and rear speakers are normally positioned 2-3 feet above ear level. The subwoofer can be placed in any location where severe resonances are prevented – see section 3.3.

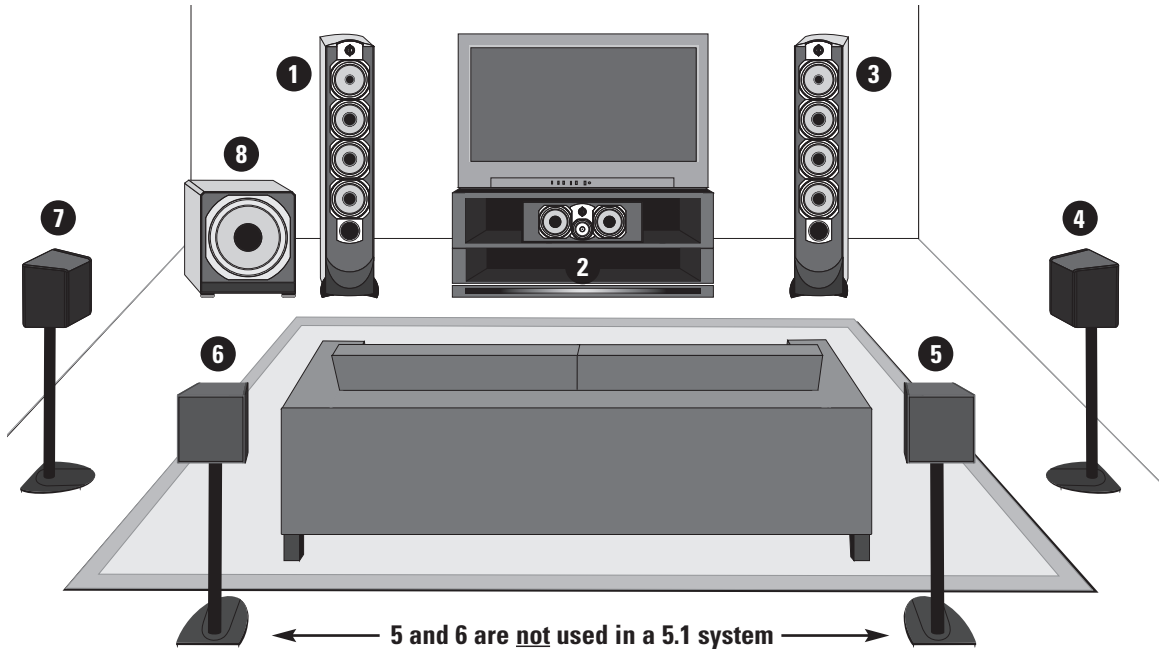

- | | | | |
|---------------|-------------------|---------------|---------------------|
| 1. Front-Left | 3. Front-Right | 5. Rear-Right | 7. Surround-Left |
| 2. Center | 4. Surround-Right | 6. Rear-Left | 8. Subwoofer (".1") |

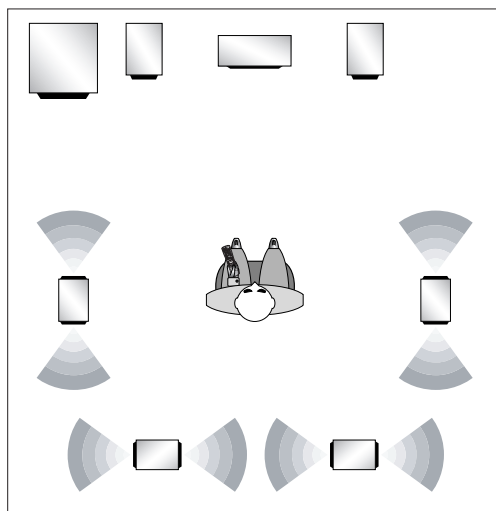

Dipole surrounds

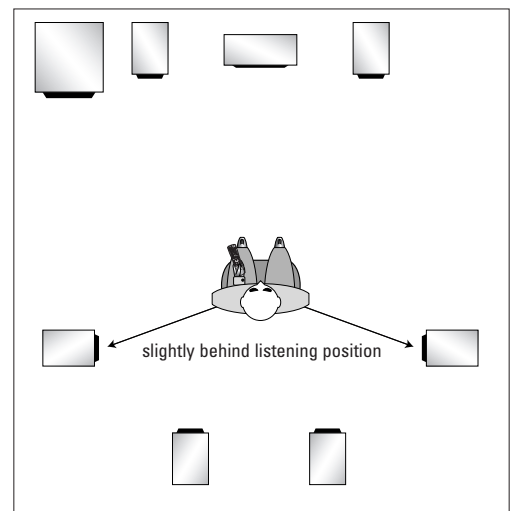







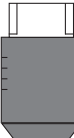

Direct radiating surrounds

1. INTRODUCTION continued ...

1.8 INTERCONNECTS

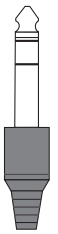
These illustrations show audio, video, IR, and trigger connectors used between source components, the processor, displays, and power amplifiers. RCA coaxial cables with 75-ohm impedance are equally suitable for analog video and digital audio.

RCA Black or White	RCA Red	RCA Yellow	HDMI	Mini DIN
				
Analog Left Channel	Analog Right Channel	Digital Audio or Composite Video	Digital Video and Audio	S-Video
RCA Green: Component Y	RCA Blue: Component Pb	RCA Red: Component Pr		

1/4" Stereo	3.5mm Mini (Mono)	Optical	XLR Female (connects to output)	XLR Male (connects to input)
				
Headphone	12V Trigger IR Emitter	Digital Audio	Analog Balanced or AES/EBU	

Read before calling for technical support due to bad, intermittent, or no picture via HDMI!

1080p uses twice the bandwidth that 720p and 1080i do – make sure that the cable is suitable for the application otherwise the picture may contain pixel dropouts or not play at all.

Use HDMI Category 2 cables, also known as “v1.3 certified”. This is a requirement for all connecting devices including extenders when connecting a display that supports Deep Color (10- or 12-bit). Connecting devices that worked in an older setup may not work with Deep Color. If the source allows Deep Color to be turned off, start troubleshooting by turning it off.

12-bit Deep Color that works at 1080p24 may not work at 1080p50 or 1080p60.

BE CAREFUL WHEN MAKING HDMI CONNECTIONS. The connector should easily slide in the jack – do not insert it on an angle and do not force it. Each connector contains 19 delicate pins and damaged pins can damage jacks. Such damaged jacks are not covered by warranty. If your HDMI cables have been connected enough times that they are about to wear out, we recommend that you replace them.

If using DVI connection note that cables with DVI connection on one end and HDMI connection on the other are more reliable than DVI-HDMI adapters. If you are having a connection problem and an adapter is in use, start troubleshooting by eliminating the adapter.

2. CONNECTIONS

2.1 VIDEO CONNECTIONS

To configure inputs **see section 3.6** and to configure video outputs **see section 3.1**.

HDMI:

Video is sent with audio from source components to the processor. Maximum video resolution is 1080p60. Connect MAIN HDMI output to a display with HDMI or DVI input – one with High-bandwidth Digital Content Protection (HDCP) is required to display copy-protected material. DVD players usually enable HDCP even on home movies. **If the source is protected, only HDMI video output is active** (see section 4.14).

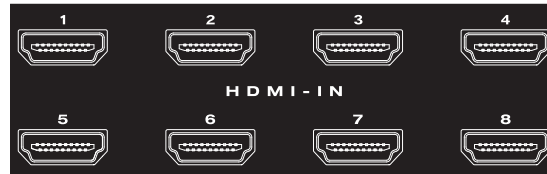
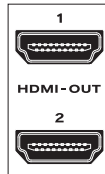

HDMI switching requires at least two seconds **per stage**, i.e. at least four seconds from source to processor to display.

Component Video:

Component video uses three coaxial cables and has a maximum resolution of 1080p when unprocessed or 480p when the source is copy-protected with Macrovision. Maximum input resolution is 1080i60 if the input is processed or converted to HDMI. The second Component output can be used in MAIN, processed or unprocessed, or in ZONE2.

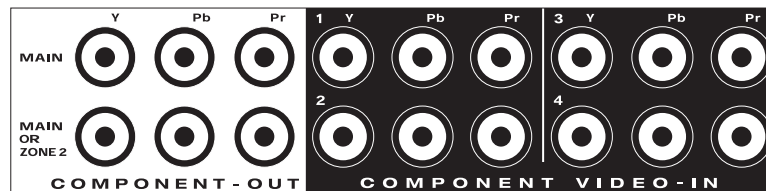

S-Video:

Maximum resolution is 480i (NTSC) / 576i (PAL). This connection keeps brightness and color separate for a better picture than Composite. S-Video input can be converted to Component and HDMI output (MAIN only).

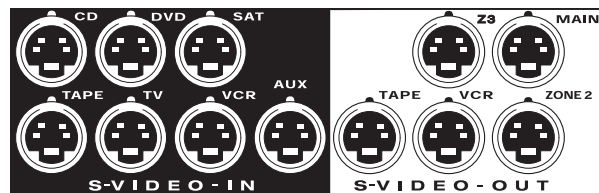

Composite Video:

Maximum resolution is 480i (NTSC) / 576i (PAL). This traditional format combines the black/white and color information for transmission on a single coaxial cable. To be displayed, the information has to be separated, a process that degrades video quality. Composite inputs can not be converted or processed. If you use a VCR, one with S-Video output is recommended. If a composite video source is black and white, it can be plugged into a Component video's Y input. If there is no choice but to convert a color source's composite output, a composite to S-Video converter is needed (not an adapter turned backwards).



2. CONNECTIONS continued ...

2.2 AUDIO CONNECTIONS

Digital Audio Inputs and Outputs:

Digital audio source components can be connected with a coaxial, optical, balanced, or HDMI cable. These carry 2-channel PCM, Dolby Digital, and DTS. The HDMI inputs also accept up to eight channels of PCM.

Should you need audio from the HDMI output to your display, it's 2-channel PCM.

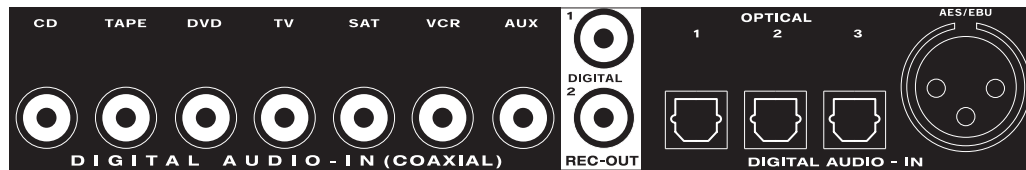
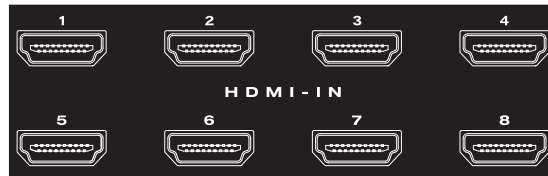
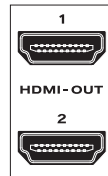

Use the HDMI inputs if your display has HDCP-compliant HDMI or DVI input, otherwise use the coaxial or optical inputs. The processor also provides one balanced AES/EBU connection, which is used on professional equipment. Any digital input can be assigned to any number of sources that are set to digital. **To change digital audio connection from factory default, see section 3.6.**

Digital Rec-Out can provide a signal to the digital audio input of a Mini Disc recorder, CD recorder etc. from any source set to Digital (except HDMI) or Anlg-DSP – see sections 3.6 to 3.9.

Analog Audio Inputs:

Analog audio connections are made with RCA or XLR cables. To use ZONE2, ZONE3, or RECORD, connect digital and analog audio and video* from the source. ZONE2, ZONE3, and RECORD require analog connection unless set to MAIN (explained in sections 3.6 and 4.3).

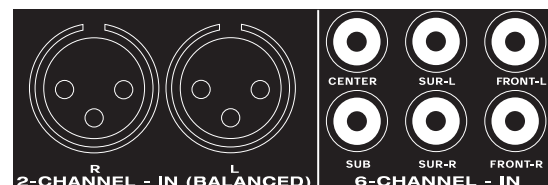

6-Ch Analog Input:

The 6-Ch input is for connecting DVD-Audio and multichannel SACD players that do not have HDMI output. When 6-Ch is selected, the video signal from **DVD** input is routed to the video outputs by factory default – to change this, see section 3.6.

HDMI connection with cable and satellite receivers may be problematic especially when output resolution follows each channel (native or pass-through mode). If there is a problem with HDMI from cable or satellite use component video connection instead, with coax or optical connection for audio. As these connections were designed to carry HDTV formats, there is almost never a difference in picture and sound quality with proper settings. As well, switching between channels is faster.

***Some boxes disable their component video output once HDMI is connected.** To use the box in a secondary zone that uses component video, connect the box to the processor via component, not HDMI.

2. CONNECTIONS continued ...

Analog Audio Outputs:

Balanced connection offers the highest transmission quality over long cable lengths, because it rejects noise pickup. In the processor, XLR output voltage is twice that of RCA (6 dB higher). The RCA outputs and the XLR outputs are always active – both can be used at the same time if the system requires it.

Parallel outputs are provided for a second center channel speaker and/or subwoofer. If your screen is large, you might want to use one center channel speaker above it and another one below it. One way to tame room resonances is by using multiple subwoofers playing the same signal from different locations in the room.

If you are not using the second set of balanced SUB2 and CENTER2 outputs, they can be reassigned as ZONE2 L/R outputs to ensure noise rejection if the ZONE2 amplifier has balanced input and it's at a distance from the processor (see section 3.9).

If you're using one rear channel, use the Rear-L output to connect it (see section 3.3).

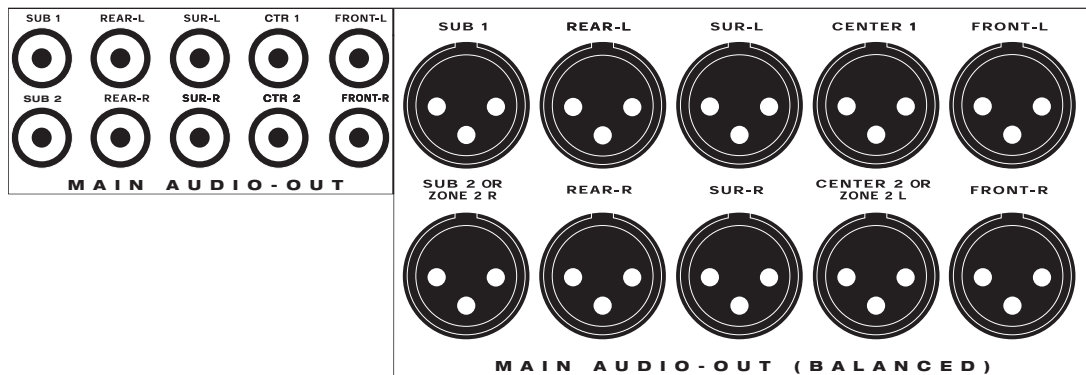

Shown below are the analog audio RECORD outputs which connect to the audio inputs of recording devices, together with the outputs that connect to amplifiers for ZONE2 and ZONE3:

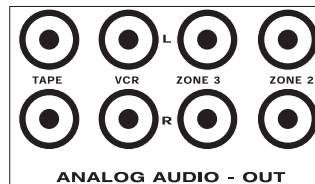

Why am I not getting sound in ZONE2, ZONE3, or RECORD?

For ZONE2, ZONE3, and RECORD to have any output, the source components being used there must be connected to the processor with the same type of connection. For example, if a source is connected via HDMI, there won't be output in ZONE2 unless you make additional connections from the source to the processor – analog L/R for audio, and Component, S-Video, or Composite video – whichever type the display in ZONE2 uses.

The only exception is when using Copy mode for audio – see section 4.3.

2. CONNECTIONS continued ...

2.3 FM•AM ANTENNAS

To connect the AM loop antenna, press the spring-loaded tabs of the AM ANTENNA connector and insert the bare ends of the two wires. Move the antenna until best reception is found.

To connect the FM antenna, connect the two wires to the screw terminals of the 75-ohm to 300-ohm adapter, then connect the adapter to the FM ANTENNA connector. Move the antenna until best reception is found – this is usually a “T” formation. If your cable company provides FM service, you can connect the cable to the processor.

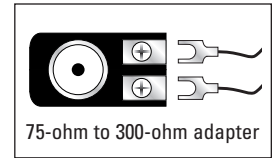

2.4 12 VOLT TRIGGERS

If your other components have provisions for a trigger, you can have them turn on and off together with the processor, or when a specified source is selected. Connect a trigger output from the processor to the trigger input of your power amplifier, display, etc., using a cable with 3.5mm mono mini plugs.

The processor provides flexible trigger options. From the factory, all the triggers are disabled. Through the setup menu, you can specify the conditions for enabling triggers (see section 3.11).

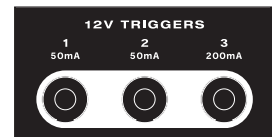

2.5 POWERED IR (INFRA RED) RECEIVERS

External IR receivers allow the remote control to be used from other locations in your home. Once an IR receiver is wired to another room, connect it to one of the three IR RECEIVER inputs through the removable terminal block. To use the terminal block, remove it from the processor, loosen the proper screw, insert the wire in the slot, tighten the screw onto the wire, and insert the terminal block into the processor. See section 3.11 for Setup information.

In addition, there is no need for an external 12V supply to power the receivers – use the processor’s built-in supply instead for up to three IR receivers and connect according to the IR receiver manufacturer’s instructions.

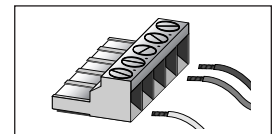
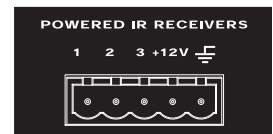

Custom Installers: The processor’s IR inputs sense modulated 38 kHz carrier, not demodulated data. With some control systems, an emitter face-to-face with an IR receiver may be needed.

2.6 IR (INFRA RED) EMITTERS

IR emitters allow control of your source components from any location in your home that has an IR receiver connected to the processor. After positioning the IR emitter according to its instructions, connect it to IR EMITTER output. Commands through the rear IR RECEIVER are re-transmitted through the IR emitters.

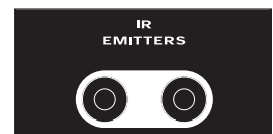

2.7 POWER

Connect the power cord to the processor and the power source then turn on the rear panel AC switch.

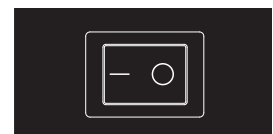

2. CONNECTIONS continued ...

Example 1: Disc Player to processor to main display

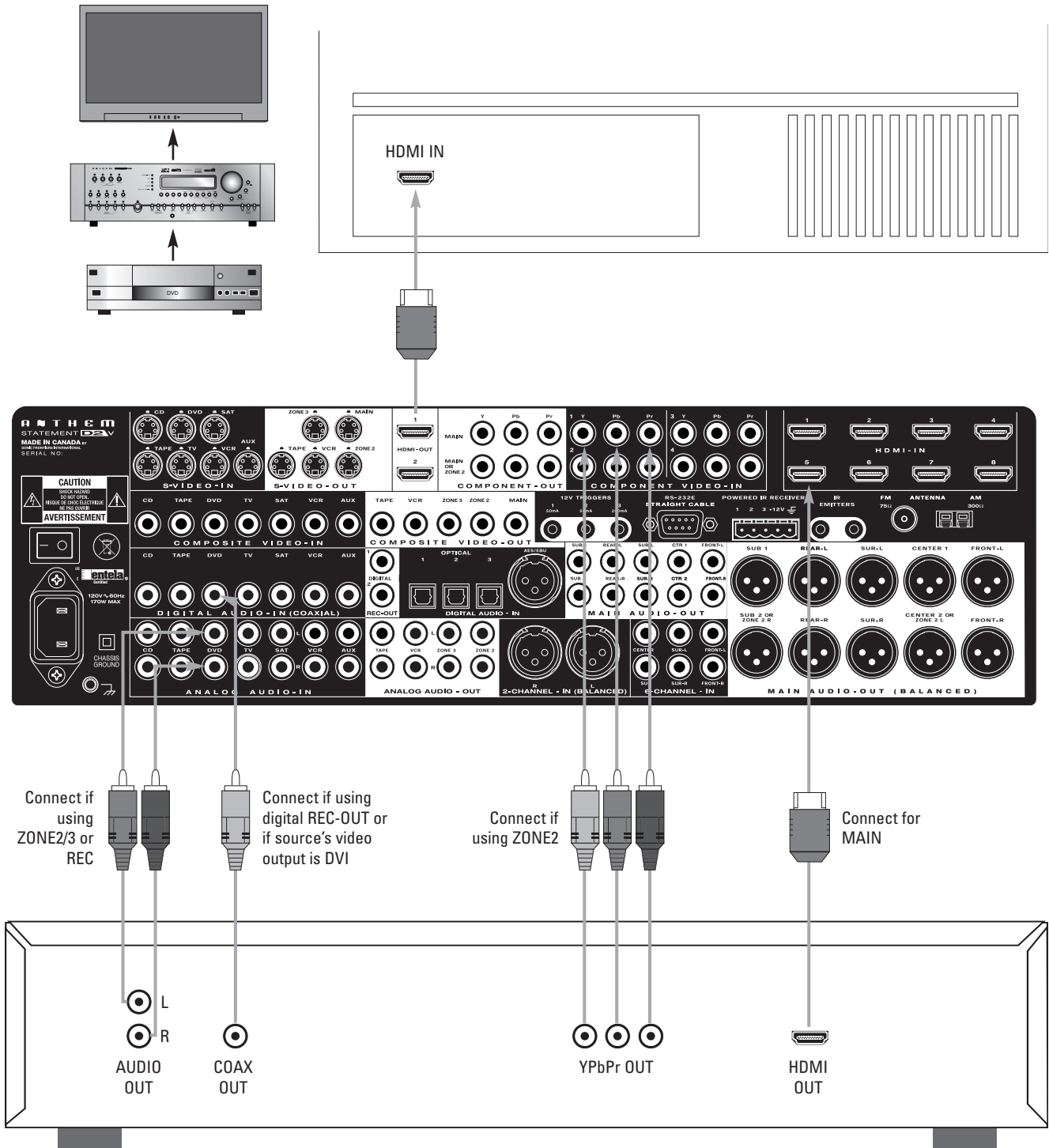

Cable and satellite receivers: HDTV receivers can be connected as above although **HDMI connection may be problematic** with older models especially when output resolution changes between SD, 720p, and 1080i according to the channel. If HDMI is problematic use component video connection instead, with coaxial or optical connection for audio.

In any case, using coax/optical for audio results in faster audio switching when video resolution changes.

2. CONNECTIONS continued ...

Example 2: A/V Recorder to processor

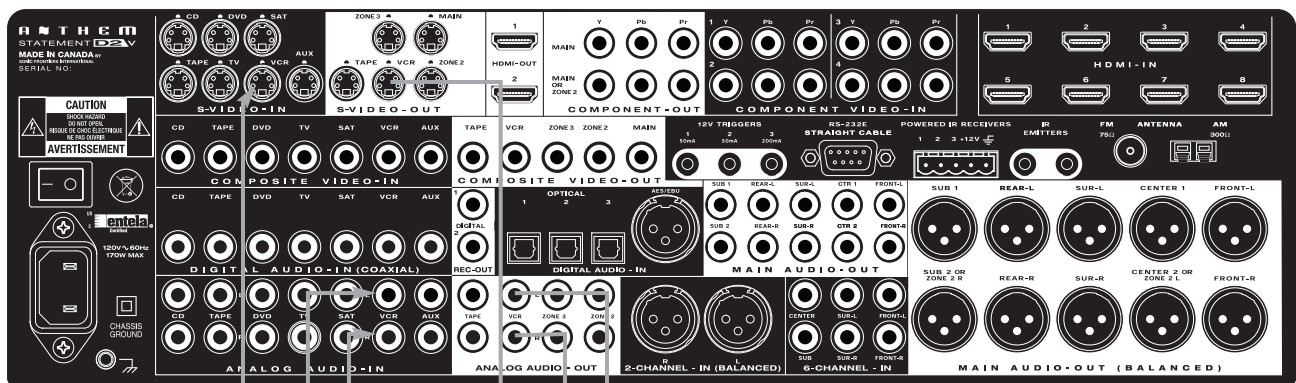
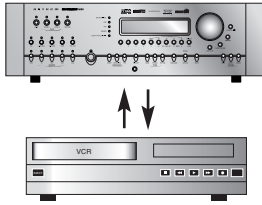

For ZONE2, ZONE3, and REC, in most cases you must use the same input type as the output type. If MAIN uses a different input connection, all you need to do is add these connections for ZONE2, ZONE3, and REC.

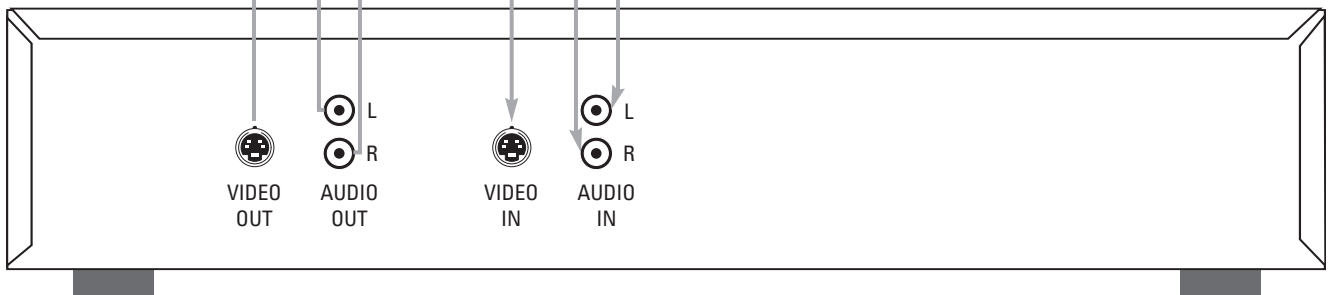

2. CONNECTIONS continued ...

Example 3: Processor to amplifiers and subwoofer (Balanced connection shown, single-ended is similar)

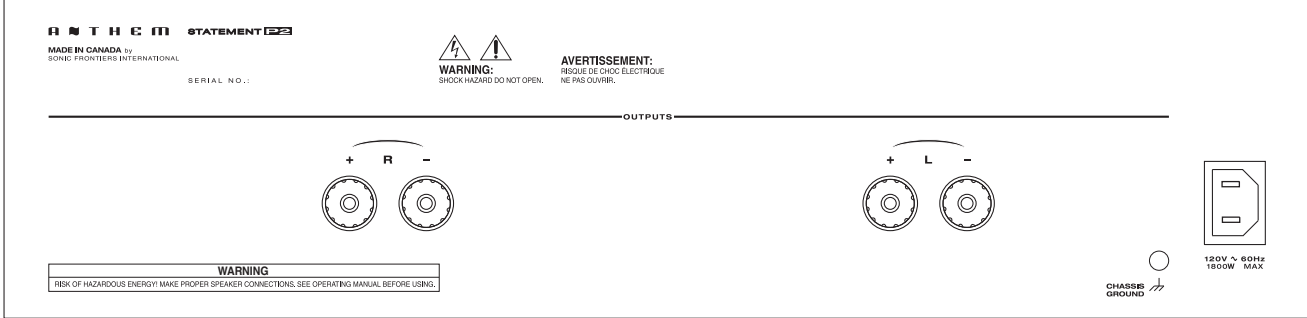
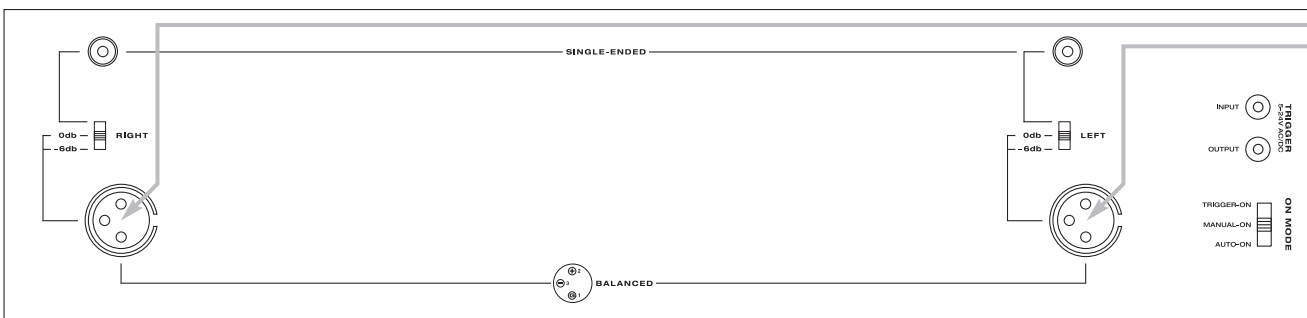
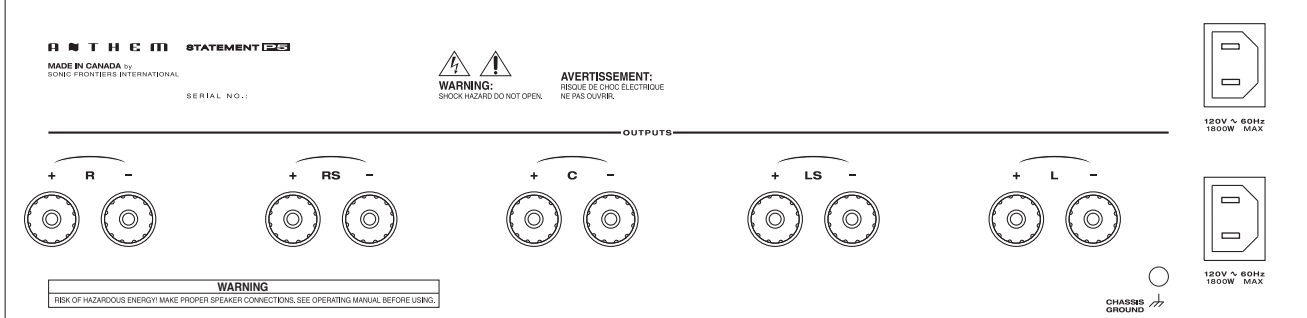
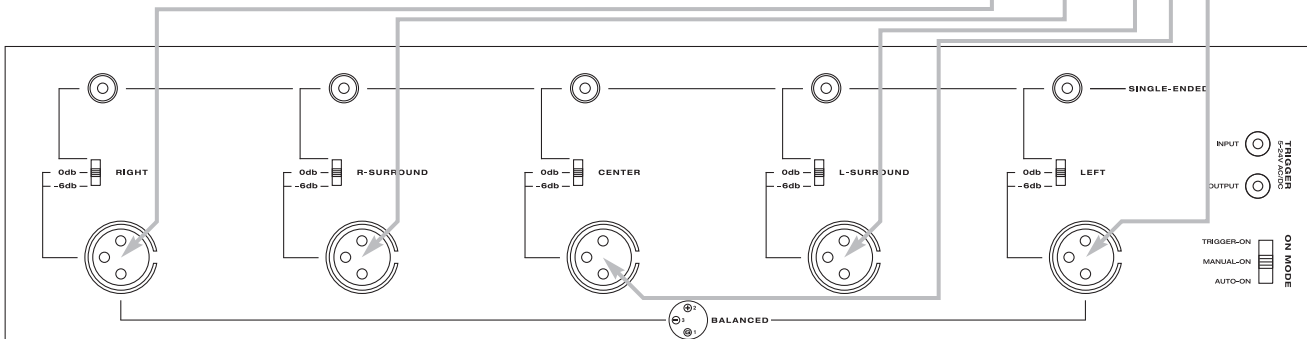
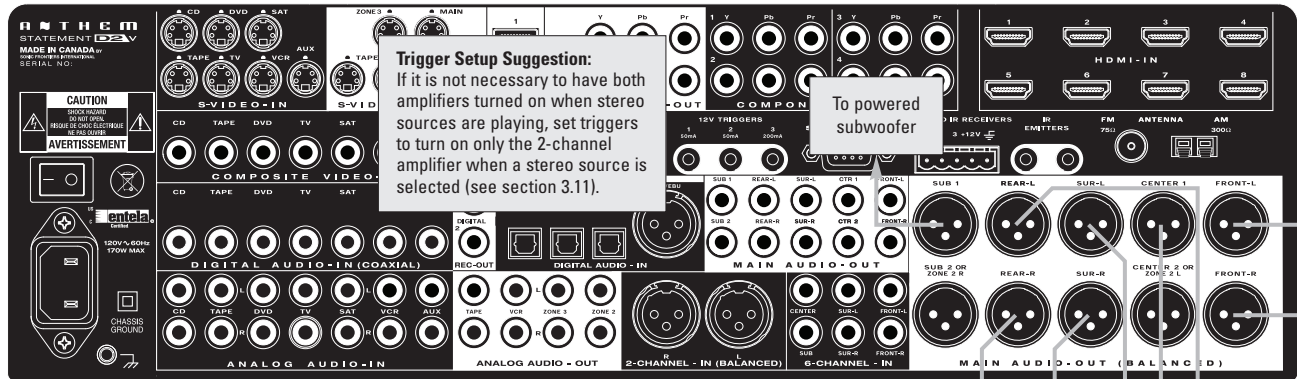

3. SETUP

For optimum performance and enjoyment, your processor should be properly set up. This may appear like a lot of work but keep in mind that most settings do not need to be changed from the factory ones.

The most important things are entering information about your display and speakers if the defaults do not apply, the distance from each speaker to the listening area, balancing output levels to one another, and input connections. The rest is preference – the surround mode presets, for example, should be set up **after** you have played various sources and have decided which surround modes you like best.

For proper audio balance, menus involving test noises must be set up in the order that they appear.

Alternatively, most of the setup can be done on your personal computer through RS-232 connection and a program from our web site, called Setup Editor. This can also save your configuration as a backup file. Setup Editor cannot play test signals – calibration still has to be done through the setup menu.

HOW TO ENTER THE SETUP MENU

The setup menu can be accessed from **MAIN** and **ZONE2**. The on-screen display shows only in that path. Test noises play only from MAIN.

Remote Control

Make sure the appropriate control mode is set then press **SUB/LFE (SETUP)** for 3 seconds.

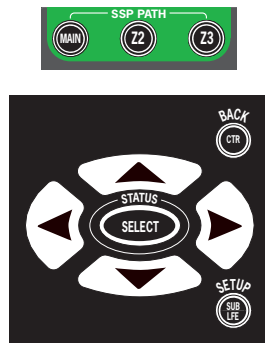

Front Panel

Make sure the appropriate path is selected then press and hold **STATUS (Setup)** for 3 seconds.

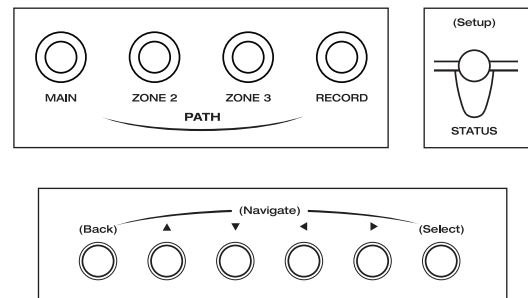

HOW TO NAVIGATE IN THE SETUP MENU

- Use the ▲ ▼ buttons to scroll through menus.
- Press **SELECT** to choose a menu item.
- Use the ▲ ▼ and ◀ ▶ buttons to change settings.
- Press **BACK** to return to previous item or menu.

HOW TO EXIT FROM THE SETUP MENU

Press **BACK** as many times as necessary. Each time BACK is pressed the previous item or menu returns. The menu will exit if not used for 5 minutes to prevent a burned-in on-screen image.

3. SETUP continued ...

SETTING UP THE PROCESSOR

Upon entering the setup menu your display will show the menu below. Only 8 menu items can be displayed at once – for clarity this manual shows each menu with all its items. On-screen display is recommended although the front panel shows similar information, one item at a time. If the default video output settings do not work with your display, use the front panel display to set video output. Setup menus are displayed through MAIN HDMI and Component (processed) outputs, and MAIN and ZONE2 S-Video outputs, whereas the 2-line status display and the video processing menu are displayed as follows:

MAIN on-screen display is available via HDMI1 output by default. On-screen display comes from HDMI2 and Component (processed) if “Preferred” is changed to “Component” in menu 1 submenus. S-Video on-screen display is available in both cases.

ZONE2 on-screen display is available via S-Video output.

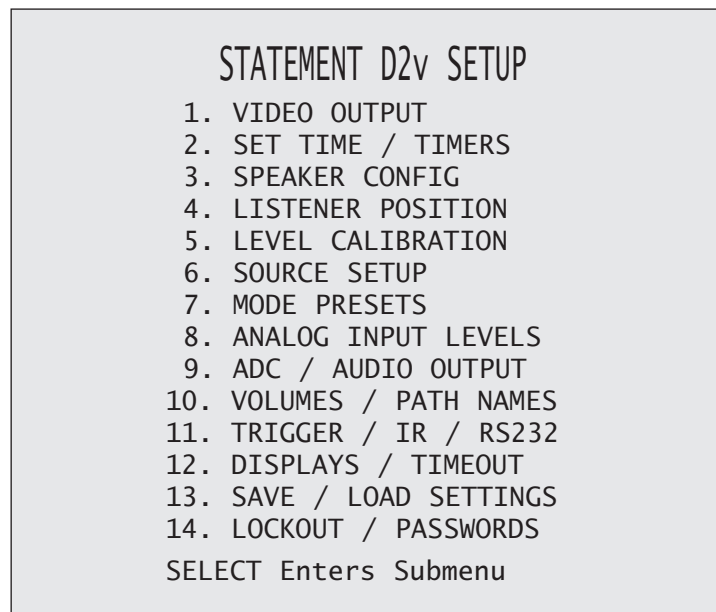

To go to a submenu, highlight a menu item and press **SELECT**. Each on-screen menu also has a scrolling help line at the bottom as shown above.

3.1 VIDEO OUTPUT

Highlighting VIDEO OUTPUT then pressing **SELECT** displays this menu:

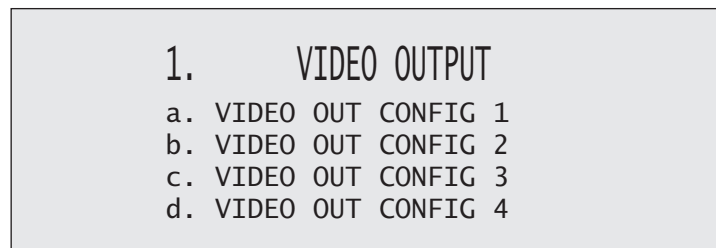

3. SETUP continued ...

Video Output Configurations:

The Statement D2v allows you to set four video output configurations – only **Configuration 1** is needed in most cases. The rest can be used to match the output refresh rate to source refresh rates, i.e. 1080p24, 1080p50, and 1080p60 if your display accepts these rates, or with a secondary display that needs different settings – only one display can be used at a time in this case. Output assignment by source is explained in section 3.6, and on-the-fly selection is explained at the end of section 4.11.

Calibration professionals: Live Video Settings Editor, a program downloadable from our web site, allows control via computer and file creation for video processing described in section 4.11, plus gamma correction (single or separate RGB curves) and custom output resolution and timing.

Once entering Configurations 2 through 4, the menu asks whether or not you want to use the same settings as Configuration 1 – the factory default is Yes. If different settings are used, the output changes according to the line that's highlighted in the VIDEO OUTPUT menu. Highlighting VIDEO OUT CONFIG 1 in the VIDEO OUTPUT menu then pressing **SELECT** displays this menu:

1a. VIDEO OUT CONFIG 1

- a. S-VIDEO OSD: NTSC
- b. PREFERRED: HDMI
- c. RESL 'N: 1280x720p60
- d. COLOR SPACE: Auto
- e. DATA: Auto
- f. LETTERBOX: Black
- g. SYNC: Normal
- h. COMPNT2 OUT: Passthru

Items a. through g. pertain to MAIN output only.

Changes in this menu do not take place immediately to prevent loss of video output as you scroll through settings. Once you leave this menu, it asks for confirmation – use the ◀ ▶ buttons to change to Yes, then press **SELECT**. To put a change into effect before leaving the menu, press **SELECT** then confirm.

How should I set my video sources to get the most out of video processing?

Where possible disable video processing in your sources so the Statement D2v's advanced processing can be used to its potential.

For standard DVD, set the player's output to 480i/576i because if output is progressive you will be looking at the player's deinterlacing, not the Statement D2v's. If the player does not allow 480i/576i HDMI output, using 480i/576i component video output may be best. If the player can be set to put out both 480i (NTSC) and 576i (PAL) according to source, you can use that setting – the Statement D2v accepts both formats.

If your HD cable/satellite receiver has passthrough mode where output resolution follows each station's resolution, use it. If not, set the receiver's output according to the HD channels that you watch most.

HD material on disc is natively 1080p24 or 1080i60 – if your player has a passthrough mode where output resolution and refresh rate follow that of the source, you can use it with Configuration 1 resolution set to, for example, 1920x1080p60 and Configuration 2 set to 1920x1080p24.

If your sources do not allow native (passthrough) video output, consider purchasing ones that do.

How should I set my display to get the most out of video processing?

If your display allows, set it to 1:1 pixel or dot-for-dot mode. The display's stretch modes, including edge cropping or overscan, should not be used if avoidable since they rescale the image unnecessarily.

S-Video On-Screen Display Format:

If using S-Video output use the ◀ ▶ buttons to select NTSC or PAL, whichever matches your display. If your display supports both formats, try NTSC first.

Preferred Video Output:

Use the ◀ ▶ buttons to select Component or HDMI – the video will be optimized for that type. The other output is disabled except to show menus. When Component is selected HDMI-only selections are not shown.

3. SETUP continued ...

Output Resolution:

Input from S-Video, Component, and HDMI is scaled to this resolution for Component and HDMI output. If interlaced to progressive scan conversion is in effect, it is uncompromisingly pixel-adaptive even with 1080i, and the same robust film mode detection applies as with standard-definition interlaced input.

Resolution is expressed as follows:

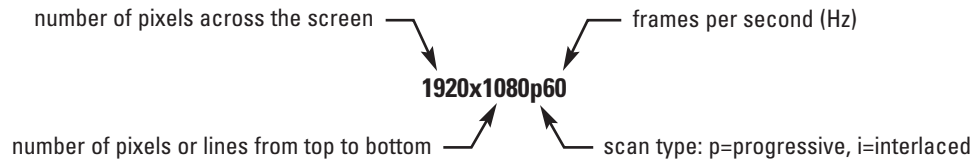

From the list below, use the setting that gives the best picture on your display. Other resolutions and refresh rates are available through Live Video Settings Editor including computer monitor and custom resolutions.

- 720 x 480i or 480p at 60 Hz (480i is not applicable to DVI input on display)
- 720 x 576i or 576p at 50 Hz (576i is not applicable to DVI input on display)
- 1280 x 720p at 50 Hz or 60 Hz
- 1024 or 1280 or 1360 or 1366 x 768p at 60 Hz (DVI input on display is required)
- 1920 x 1080i at 50 or 60 Hz
- 1920 x 1080p at 24 Hz or 50 Hz* or 60 Hz*
- Custom
- Auto[§]

*high-bandwidth cable is required

Color Space:

Set this to match your display type: HDTV (high definition TV), SDTV (standard definition), or Auto[§].

Data Format:

Select YCbCr 4:2:2, YCbCr 4:4:4, Studio RGB, Extended RGB, or Auto[§] – whichever looks best. When YCbCr is selected, the HDMI output uses YCbCr format and Component output uses YPbPr.

To determine whether Studio vs Extended RGB is the correct setting, compare shadow detail in dark scenes or play the color bar test pattern in section 4.11 and look at the stripes in the lower right. If using YCbCr output, compare detail around edges in colorful scenes to determine whether 4:2:2 vs 4:4:4 is best.

If colors look totally wrong with all sources, try all settings before contacting tech support. If colors look wrong only when certain sources are selected, see section 4.11.

§ Auto setting: Works with most displays, but you may get a better result selecting the format manually.

3. SETUP continued ...

Letterbox:

When the source's aspect ratio (the proportion of image width to height) does not match the display's aspect ratio and you want to preserve the original image's proportions, the unused areas of the screen will be blank. You can select the shade of these areas from ten levels between light gray and black. If you do not want letterbox (bars on top/bottom) or pillarbox (sidebars) on your screen, see section 4.11.

Synchronization:

Try Inverted setting if the image via HDMI is not centered or does not show – typically needed only with some older displays.

Component 2 Out:

The second Component video output can be configured in one of the following three ways or turned Off:

- MAIN output, processed (same signal as Component 1).
- MAIN output, passthrough – this bypasses the video processing and on-screen display is not available. If a secondary display in the main room does not accept the format being fed to the main display, use this setting.
- ZONE2 output – bypasses video processing and on-screen display not available.

3. SETUP continued ...

3.2 SET TIME / TIMERS

The time and day, plus 6 different timers are set in this menu. The timers in the processor are like an alarm clock, but allow two different timer settings for each of MAIN, ZONE2, and ZONE3.

2. SET TIME / TIMERS

- a. FORMAT: 12 Hr
- b. TIME: 12:00 AM
- c. DAY: Sunday
- d. ALL TIMERS: Disabled
- e. SET MAIN TIMERS
- f. SET ZONE2 TIMERS
- g. SET ZONE3 TIMERS

To set Time and Day:

- Enter the setup menu. Go to SET TIME / TIMERS and press **SELECT**.
- Press the ▼ button until you reach FORMAT.
- Use the ◀ ▶ buttons and choose 12 Hr or 24 Hr.
- Press the ▼ button to go to TIME.
- Press **SELECT**. "12" or the current hour will be highlighted in red.
- Use the Master Control Knob or the ▲ ▼ buttons to set the current hour.
- Press the ▶ button. "00" or the current minutes will be highlighted.
- Use the Master Control Knob or the ▲ ▼ buttons to set current minutes.
- Press **BACK** to return to the menu line.
- Press the ▼ button to go to DAY then use the ◀ ▶ buttons to set the current day.

All Timers:

This allows you to simultaneously "Enable" or "Disable" all Timers for MAIN, ZONE2, and ZONE3.

Highlighting SET MAIN TIMERS then pressing **SELECT** displays this menu:

2e. SET MAIN TIMERS

- a. --- TIMER 1: Off ---
- b. WEEKDAY ON: 8:00 AM
- c. WEEKDAY OFF: 11:00 PM
- d. WEEKEND ON: 10:00 AM
- e. WEEKEND OFF: 11:00 PM
- f. SOURCE: Last Stn
- g. ON-VOLUME: -35.0 dB
- h. --- TIMER 2: Off ---
- i. WEEKDAY ON: 8:00 AM
- j. WEEKDAY OFF: 11:00 PM
- k. WEEKEND ON: 10:00 AM
- l. WEEKEND OFF: 11:00 PM
- m. SOURCE: Last Stn
- n. ON-VOLUME: -35.0 dB

3. SETUP continued ...

Timer Options:

There are two Timers for Main and each Zone to allow greater flexibility. You can set week and weekend on/off times twice – once for the morning and again for the evening, for example.

Using the ◀ ▶ buttons, TIMER 1 and TIMER 2 choices are:

- **Off** – Timer is disabled.
- **Week** – Timer operates from Monday to Friday.
- **Wkend** – Timer operates on Saturday and Sunday.
- **Wk+Wkend** – Timer operates every day.

On and Off Times:

Auto-on/off times are entered for:

T1 or T2 WEEKDAY ON: Sets the Monday to Friday turn-on time.

T1 or T2 WEEKDAY OFF: Sets the Monday to Friday turn-off time.

T1 or T2 WEEKEND ON: Sets the Saturday and Sunday turn-on time.

T1 or T2 WEEKEND OFF: Sets the Saturday and Sunday turn-off time.

Timers may also be set to only turn on or only turn off (see Example 2) – this way, the processor can be set to turn on automatically, and it won't turn off until you turn it off manually.

If the processor is already on, Timer On settings are ignored to ensure that source and volume are not changed while in use.

Source:

Select what you want to be playing when a Timer turns the power on – any source, any preset FM•AM station, or Last Stn (the tuner setting when processor was turned off). Be sure that the **source** and the **power amplifier** are turned on or will be on at the Timer turn-on time. If your components have trigger inputs, you can set a processor trigger to turn them on (see section 3.11).

On-Volume:

Sets the volume that will play when a Timer turns the power on. The volume increases slowly when a Timer turns the power on.

3. SETUP continued ...

Example 1: Select a source for the ZONE2 Timer:

- Enter the setup menu. Go to SET TIME / TIMERS and press **SELECT**.
- Press the ▼ button until you reach SET ZONE2 TIMERS.
- Press **SELECT**. The SET ZONE2 TIMERS submenu will appear.
- Press the ▼ button until you reach SOURCE.
- Use the ◀ ▶ buttons to change to desired source.
- Press **BACK** to leave this submenu and return to the SET TIME/TIMERS menu.

To have the Timer turn on to a Preset Station, do the following from the SOURCE menu line:
(setting Preset Stations is explained in section 4.4.1)

- Use the ◀ ▶ buttons to change to “Last Stn”.
- Press **SELECT** to highlight “Last Stn”.
- Use the ▲ ▼ buttons to select an FM•AM Preset. These scroll from AM 1-1 to AM 1-6 then from FM1-1 to FM3-6 and back to “Last Stn”.
- Press **BACK** once you have selected a preset.

The Timer submenu setup procedure is the same for MAIN, ZONE2, and ZONE3.

Example 2: Change ZONE2, TIMER2 to come on Weekdays at 7:30 AM.

- Enter the setup menu. Go to SET TIME/TIMERS and press **SELECT**.
- Press the ▼ button until you reach SET ZONE2 TIMERS.
- Press **SELECT**. The SET ZONE2 TIMERS submenu will appear.
- Press the ▼ button to reach TIMER 2.
- Use the ◀ ▶ buttons to change to “Week”.
- Press the ▼ button until you reach WEEKDAY ON.
- Press **SELECT**. The hour is now highlighted. Use the Master Control Knob or the ▲ ▼ buttons to set the hour to “7” AM. (Continuing through “12” will advance the AM/PM settings.)
- Press the ▶ button. “00” minutes will be highlighted.
- Use the Master Control Knob or the ▲ ▼ buttons to set the minutes to “30”.
- Press **BACK** to leave this submenu and return to SET TIME/TIMERS menu.

When scrolling between 11 PM and 12 AM settings, the display shows “--:--”. Timers set in the “--:--” position will be skipped. For example, to set the Timer to only turn on, set the Off time to “--:--”. To set the Timer to only turn off, set the On time to “--:--”.

3.3 SPEAKER CONFIGURATION

The Speaker Configuration Setup allows you to enter information about your speakers so that sounds from sources are not lost or distorted.

3. SPEAKER CONFIGURATION

- a. BASS MANAGEMENT-MOVIE
- b. BASS MANAGEMENT-MUSIC
- c. SURROUNDS: Dipole
- d. REARS: Dipole-7.1
- e. UNITS: ft
- f. CENTER EQ: No
- g. TV SIZE: 30-42 in
- h. ROOM RESONANCE FILTER

Skip items f. to h. if using Anthem Room Correction on all sources.

Bass Management Configurations for Movies and Music:

The processor memorizes two bass management configurations – if using both (Music configuration is optional), always use **Movie** for sources containing LFE. The BASS MANAGEMENT-MUSIC menu asks whether or not you want to use the same settings as the Movie configuration – the default is “Yes”.

Setting up a configuration is described later in this section. Assigning a configuration to a source or enabling automatic activation according to presence/absence of LFE is explained in section 3.6.

If your source components have bass management and time alignment, turn them off by setting all channels “large” and to the same distance in the source components.

Surround and Rear Speaker Quantity and Type:

Surround speakers fall in two radiation pattern categories: Direct and Dipole. No delay is necessary in channels using dipole speakers since most of the sound is delayed through room reflections. When Dipole is selected, distance is matched internally with the greatest one in the LISTENER POSITION menu.

If you are using one rear speaker, set d. REARS to 6.1 and use the Rear-L output.

If you are using no rear speakers, skip the d. REARS setting. It makes no difference what it's set to.

Units:

Feet (ft) or metres (m). This will be used for size and distance measurements.

Center EQ:

When a speaker sits directly above or below a vertical surface such as a TV screen, reflections can change frequency response making dialog less natural. With Anthem's unique CENTER EQ set to “Yes” the negative effects of vertical surfaces close to the front of the speaker can be cancelled.

TV Size:

This determines the CENTER EQ response curve. Select from 18 - 30" / 30 - 42" / 42 - 54" / 54 - 66" / 66 - 78". If UNITS is set to “m” the selections are 45 - 75 cm / 75 - 100 cm / 100 - 135 cm / 135 - 165 cm / 165 - 200 cm.

Since room/TV/furniture acoustics vary as do center channel speakers and their positioning, play a few DVDs and use the setting that provides the clearest dialog even if it doesn't match the TV's size.

3. SETUP continued ...

Highlighting BASS MANAGEMENT-MOVIE then pressing **SELECT** displays this menu:

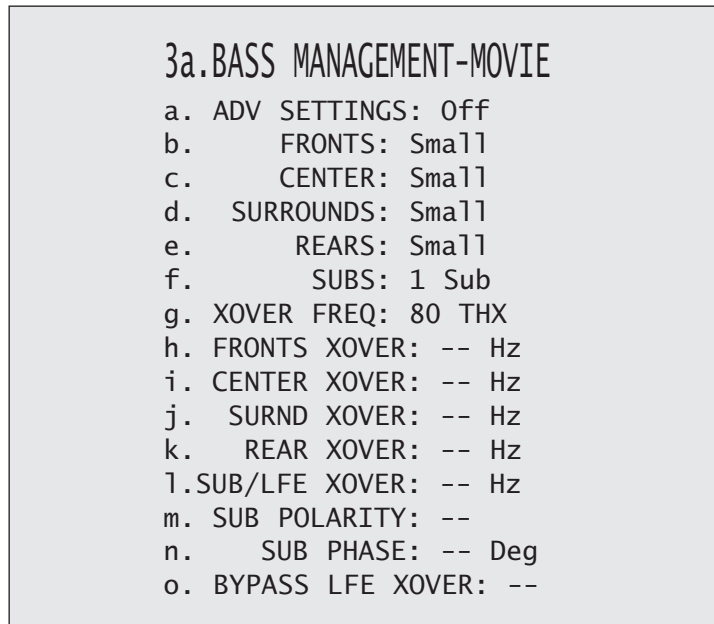

Skip items a. to l. if using Anthem Room Correction on all sources.

Advanced Settings:

The default is Off. Use of advanced settings is described later in this section.

Small or Large:

Most speakers should be set to Small and used with a subwoofer unless they use large drivers that play deep bass and LFE accurately. Even then, the question is which speaker can produce deeper and cleaner bass at higher output? It's almost always the subwoofer, which has the advantage of flexible positioning in the room to help control boominess. All THX certified speakers are designed for Small setting.

Subwoofer:

- **1 Sub** The subwoofer plays two things – LFE and bass from channels set to Small. This setting is preferred by THX. **Use this setting if using a subwoofer with Anthem Room Correction.**
- **1 Super** As above except bass from all channels is included, not just the ones set to Small. This setting is not recommended for the Movie configuration.
- **2 Subs** or **2 Supers** – Select if using both subwoofer outputs and not using ARC. This simply reduces the subwoofer channel's test noise level to compensate for the additional subwoofer.

"None" setting for:

- **CENTER** – the center channel plays from the L/R fronts.
- **SURROUNDS** – the L-Surround channel plays from the L-Front channel and the R-Surround channel plays from the R-Front channel (except Dolby Pro Logic modes).
- **REARS** – the rear channels on sources having them play from the surrounds.
- **SUBWOOFER** – the subwoofer channel plays from L/R fronts (forced to Large) and surrounds.

If you are using 5.1 speakers, use the SURROUND outputs and set REARS to None so no sound is lost!

Bass response highly depends on room acoustics and experimentation with subwoofer placement is recommended. Start by temporarily placing the subwoofer in the listening area, play some music with a range of bass and walk around the room. Positions where the bass range sounds smooth are suitable for permanent subwoofer placement as long as decor allows.

Crossover (Xover) Frequency:

The crossover divides audio in two frequency bands, resulting in lower bass level in Small channels and no midrange/treble in the subwoofer. If your subwoofer has a crossover, it should be bypassed – set its frequency control to the highest frequency.

A crossover does not cut frequencies off like a cliff, but rolls them off according to a slope. If set to 80 Hz, for example, your main speakers will still play lower frequencies – they just won't have to play them as loudly. This also lightens the load on the amplifier leaving extra power for mid and high frequencies. Setting the crossover to the lowest number on your speaker's specification page is **unlikely to provide the best result**.

Using the ◀ ▶ buttons choose a frequency between 25 Hz - 160 Hz suitable for the low frequency capability of your speakers. With THX certified speakers, the crossover should be set to 80 Hz.

LFE is redirected only when Subwoofer is set to No. If set to Yes or Super, the Movie configuration XOVER FREQ should not be set much lower than 80 Hz otherwise some LFE information will be lost.

Advanced Settings – Crossover Frequency:

When ADV SETTINGS is set to On, each speaker type can be set to a Crossover Frequency that best suits its low frequency characteristics and room acoustics. For example, if placing a speaker against a wall causes excessive bass, the Advanced Crossover can be used to roll off the excess bass.

If room acoustics cause response to drop in the crossover region, the subwoofer channel can be set to overlap other channels to compensate, for instance setting SUB/LFE XOVER to 90 Hz and FRONTS XOVER to 70 Hz. In the opposite situation, if there is a bass peak in the crossover region, you can spread settings to flatten response, for example SUB/LFE XOVER to 70 Hz and FRONTS XOVER to 90 Hz.

A very low setting, such as 25 Hz, may be used to protect full-range speakers from potentially harmful signals. Scrolling below 25 Hz or above 160 Hz brings the Off setting which bypasses the crossover.

Advanced Settings – Subwoofer Phase and Polarity:

Certain subwoofer positions can cause bass frequency cancellation. When the front speakers and subwoofer are out of phase or misaligned, they work against each other resulting in weak and dislocated sounding bass. This can be corrected by adjusting Phase and Polarity.

If your subwoofer has these controls, set them to zero/normal before making menu adjustments. The advantage of adjusting through the setup menu is hearing changes instantly from the listening position.

As a general guide, set Polarity to Normal if the subwoofer is near the front speakers and to Inverted if the subwoofer is near the back of the room. With bass material or the “shhhh” noise between FM radio stations playing, compare Normal to Inverted and use the setting that provides louder bass.

The Phase control provides further alignment – listen to FM “shhhh” noise and adjust until bass is loudest.

Advanced Settings – Bypass LFE Crossover:

If you have set SUB/LFE XOVER to much lower than 80 Hz, the upper portion of the LFE signal will be lost. With BYPASS LFE XOVER set to Yes, LFE goes to the subwoofer without going through the crossover, preventing loss of LFE information. This also applies to the 6-Ch input's SUB input (effectively an LFE input).

3. SETUP continued ...

Highlighting ROOM RESONANCE FILTER then pressing **SELECT** displays this menu:

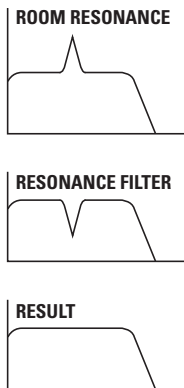

3h.ROOM RESONANCE FILTER

- a. TEST TONE: Off
- b. TEST LEVEL: +0.0dB
- c. TEST FREQ: 21 Hz
- d. APPLY FILTER: No
- e. CENTER FREQ: 60 Hz
- f. FILTER DEPTH: 1 dB
- g. FILTER WIDTH: 20 Hz
- h. THX ULTRA2 SUB: No
- i. THX BG COMPENSAT'N: NA

Skip this menu if using Anthem Room Correction on all sources.

Rooms often have a single prominent resonance peak which can make bass sound boomy, even with the finest subwoofer. The processor has a proprietary set of low frequency test tones that allow you to find and easily remove that resonance peak.

The Room Resonance Filter is a notch filter – it is not designed to boost weaker bass frequencies. While running the test tones, if you discover that instead of a prominent peak there is a prominent dip in response, the best way to fill it is through repositioning the subwoofer and/or listening position. Using electronics alone to accomplish this is often met with frustration, for example, a 10 dB boost would require the amplifier to work ten times harder, as well as speakers that can handle that much more power.

Test Tone and Level:

Test tones sweep from 18 Hz up to the XOVER FREQ (or the SUB/LFE XOVER frequency) that you have set in BASS MANAGEMENT -MOVIE or -MUSIC, whichever is higher. You can vary the level to a comfortable one.

Filter Center Frequency:

The frequency that is reduced the most when the filter is applied is called the Center Frequency. Set this to the frequency that sounds the loudest or most boomy when the built-in test tones are played. If you're using a sound pressure level meter, set it to C-weighting or Flat.

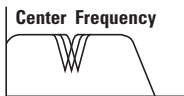

Filter Depth:

This is the amount of center frequency 'cut', or reduction in volume, in the subwoofer channel. Frequencies just above and just below the center frequency are also reduced, but not as much. Range is from 1 to 20 dB. Adjust to bring the level of the resonant peak down to the same level as the other frequencies.

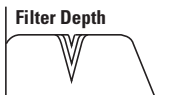

Filter Width:

This adjustment varies the range and sharpness of the filter. For example, if Filter Width is set to 3 Hz, the Room Resonance Filter cuts a very narrow range at the filter center frequency. If Filter Width is changed to 18 Hz, a broader range is reduced. Adjust so that resulting frequency response is as flat as it can be made.

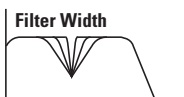

Frequency and Depth settings affect Width adjustment range – this changes automatically.

THX Boundary Gain Compensation:

If your listening room layout results in the subwoofer and/or listeners being too close to a wall, an excessive bass effect can result. With a subwoofer that extends to 20 Hz, including all THX Ultra2 certified subwoofers, Boundary Gain Compensation can improve bass balance. To enable, set THX ULTRA 2 SUB to Yes and THX BG COMPENSATION to On.

Procedure for adjusting Room Resonance Filter:

- Enter the setup menu. Go to SPEAKER CONFIGURATION and press **SELECT**.
- Press the ▼ button until you reach ROOM RESONANCE FILTER and press **SELECT**.
- Use the ◀ ▶ buttons to set TEST TONE to Auto. Press **SELECT** to start automatic sweeping of the test tones. Alternatively, you can set TEST TONE to Manual – to vary the frequency, press the ▲ ▼ buttons to reach TEST FREQ, then use the ◀ ▶ buttons to change frequency.
- Some subwoofers are not able to accurately reproduce frequencies below 30 Hz or so, especially at higher levels. In addition, it can be quite difficult to hear these frequencies. If playing them causes unusual sounds indicating the subwoofer is being stressed, do not continue to play them.
- TEST FREQ changes to show the frequency being played during automatic sweep. Listen for (or measure) the frequency that sounds too loud compared to the other frequencies.
- Press the ▼ button until you reach CENTER FREQ and select the frequency that is closest to the test tone frequency that was found to be the loudest.
- Press the ▲ button until you reach APPLY FILTER and set it to Yes.
- Press the ▲ ▼ buttons to go to FILTER DEPTH and FILTER WIDTH. Adjust both to achieve the flattest response across the range of test tones.
- Press **BACK** to stop the test tones and leave this submenu.

3. SETUP continued ...

3.4 LISTENER POSITION

The Listener Position menu lets you enter the distance between each speaker and the listening area. Ideally, speakers should be placed at an equal distance so their sound arrives at the listening area at the same time, but since this is rarely practical, the processor can delay the sound coming from speakers that are closer to the listener. This way, sound reaches the listening area at the same time from all speakers, and proper imaging can be achieved.

The speaker with the greatest distance setting will have no delay – speakers with shorter distance settings will be delayed according to their setting. Speakers set to Dipole in the SPEAKER CONFIGURATION menu have their distance set internally to the greatest distance that you enter for the other speakers.

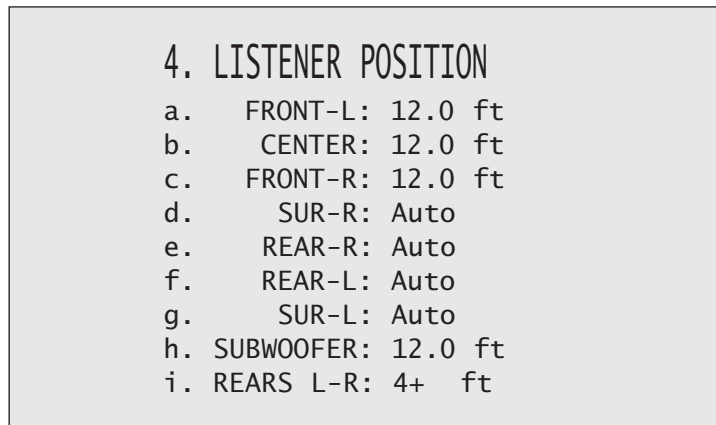

Distance Adjustment:

Enter the distance between your primary listening area and each speaker. Range is 0-99 ft in 0.5 ft increments or 0-32 m in 0.2 m increments.

Example: Set center speaker distance to 11 feet.

- Enter the setup menu. Go to LISTENER POSITION and press **SELECT**.
- Press the ▼ button until you reach CENTER.
- Use the ◀ ▶ buttons to change to 11.0 ft.
- When finished, press ▲ ▼ to go to another menu item, or...
- Press **BACK** to leave the submenu and return to the main menu.

Rear-L to Rear-R Distance:

ASA (Advanced Speaker Array) is a proprietary THX technology that processes the sound fed to the two surround and two rear speakers to provide an optimal surround sound experience. When using all 7.1 speaker outputs, placing the two rear speakers close together will provide the largest sweet spot. If for practical reasons you have to place the rear speakers further apart, choose the setting that most closely corresponds to the speaker spacing to optimize the surround soundfield.

3.5 LEVEL CALIBRATION

Level Calibration uses internal test noises to match speaker output levels at the listening position. These noises are also a way of checking system connections between processor, amplifier, and speaker. Audio calibrations from home theater setup discs are not recommended – some use incorrect methods.

A sound pressure level (SPL) meter with C-weighting is recommended if not using ARC. Measure from the listening position, pointing the meter up and holding it away from your body to prevent reflections.

The FRONTS, CENTER, SURROUNDS, REARS, SUB, and BALANCE buttons on the front panel and remote control do not change settings in this menu – they provide on-the-fly adjustment memorized according to input format in case a source needs it (sections 4.6 and 4.7).

5. LEVEL CALIBRATION

- a. NOISE SEQUENCE: Off
- b. TEST LEVEL: +0.0 dB
- c. FRONT-L: +0.0 dB
- d. CENTER: +0.0 dB
- e. FRONT-R: +0.0 dB
- f. SUR-R: +0.0 dB
- g. REAR-R: +0.0 dB
- h. REAR-L: +0.0 dB
- i. SUR-L: +0.0 dB
- j. MOVIE SUB: +0.0 dB
- k. MUSIC SUB: +0.0 dB

Skip items b. to i. if using ARC unless mic cannot detect sweep tones – raise TEST LEVEL in that case.

Test Noise Sequence:

Test noise plays from one speaker at a time, changing manually using the ▲ ▼ buttons or automatically every two seconds by setting NOISE SEQUENCE to Auto using the ◀ ▶ buttons, then pressing **SELECT**.

Source switches to FM • AM when any test noise is played. (Anlg-Dir bypasses the test noise generator.)

Test Noise Level:

This is the master volume for this menu's test noises – changing it changes the output of all channels. The noise comes out of the left front channel. Using the ◀ ▶ buttons, adjust NOISE LEVEL so the SPL meter reads 75 dB. If you do not have an SPL meter, skip this adjustment.

Level Calibration of each channel:

Balances speaker levels to one another. If you're calibrating by ear, use the remote control and sit in the listening area when adjusting. If using an SPL meter, adjust level so it reads 75 dB for each channel. If Noise Level is set while Front-L is at 0 dB, no adjustment of Front-L is needed since the output is the same. If using a powered subwoofer, make a rough adjustment with its input level control before setting sub level in this menu or using ARC. Speakers set to None in the Speaker Configuration menu are skipped.

If SUBS is set to Super in BASS MANAGEMENT-MOVIE (not advised) or BASS MANAGEMENT-MUSIC, do not rely on an SPL meter to set subwoofer level – set it by ear while playing various sources. Level Calibration cannot take into account the bass that's added to the subwoofer from speakers set to Large, which results in more bass during playback than the calibrated level.

3. SETUP continued ...

Procedure for Manual Test Sequence:

- Enter the setup menu. Go to LEVEL CALIBRATION and press **SELECT**.
- Use the ◀ ▶ buttons to set NOISE SEQUENCE to Manual.
- Press the ▲ ▼ buttons to go from speaker to speaker.
- As each speaker plays, use the ◀ ▶ buttons to adjust its loudness relative to other speakers.
- Press **BACK** to stop the test noise.

Procedure for Auto Test Sequence:

- Enter the setup menu. Go to LEVEL CALIBRATION and press **SELECT**.
- Use the ◀ ▶ buttons to set NOISE SEQUENCE to Auto.
- Press **SELECT** to start the automatic sequence.
- As each speaker plays, use the ◀ ▶ buttons to adjust its loudness relative to other speakers. After you make an adjustment, the next speaker will play.
- Press **BACK** to stop the test noise.

3.6 SOURCE SETUP

This is where you set up each source and path according to how you want them to be used.

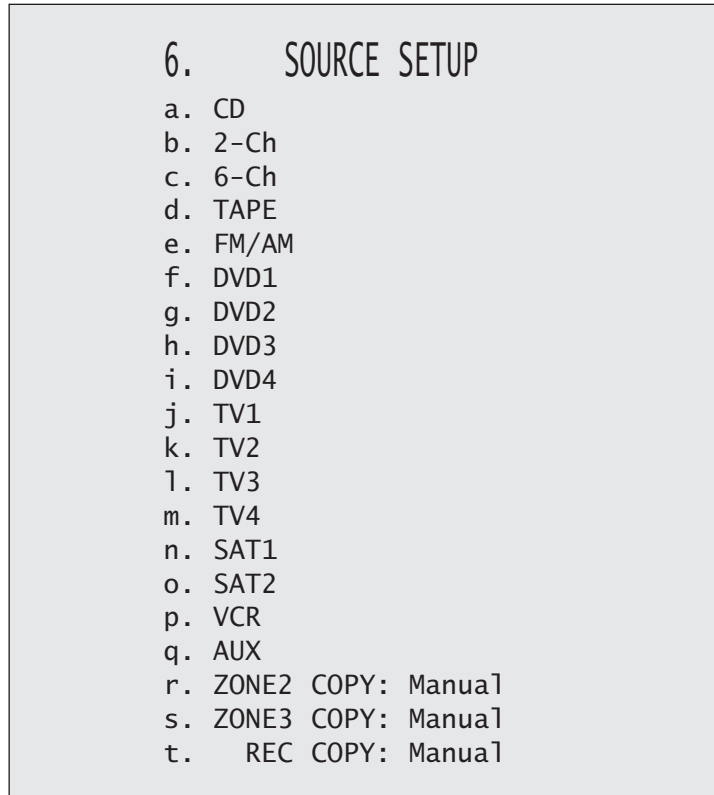

Copy MAIN to ZONE or REC:

If you want MAIN to always be copied to another path (see section 4.3), change Manual to Always. This is recommended if you want a source that only has digital audio output to be used in ZONE2, ZONE3, or REC, or if you want MAIN and another path to always play the same source. "Always" setting is not recommended if you want independent source selection – see the highlighted part of section 2.2.

Source Setup:

Besides setup of each source, DVD, TV, and SAT have expanded memory allowing you to set multiple configurations, which are useful for two reasons:

- Use multiple layers for same source, with different video adjustments on each layer, such as aspect ratio control (see section 4.11).
- Use multiple layers with different sources when you have more than nine source components.

To enable DVD2, DVD3, DVD4, TV2, TV3, TV4, or SAT2, at the top of its submenu change SAME AS to Custom to create its own Source Setup profile, or to any of the other sources to use the same Source Setup profile but with different video processing adjustments.

To copy settings from one source to another layer while having the ability to make changes to the new layer, select another source for SAME AS then press **SELECT**. When asked "Are you sure?" that you want to copy settings, use the ◀ ▶ buttons to change No to Yes and press **SELECT**. The new layer becomes Custom using the copied settings and changes can then be made.

Once set up, select a layer by pressing the source button one, two, three, or four times, or through the direct-access macros in Appendix A.

3. SETUP continued ...

Highlighting DVD1 then pressing **SELECT** displays this menu – the other submenus are similar:

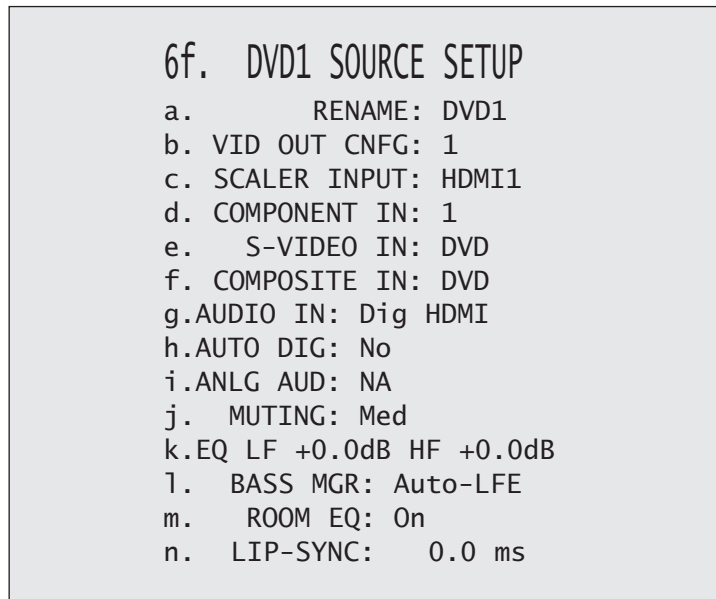

Rename:

The factory assigned source names that appear on the front panel display and the on-screen display can be changed to another name, up to six characters long. The following characters are available:

A, B, C...Z, a, b, c...z, blank, dash (-), period (.), slash (/), **0, 1, 2...9**, colon (:).

After highlighting the RENAME line, press **SELECT** and use the ◀ ▶ buttons to move from character to character, then use the ▲ ▼ buttons or rotate the Master Control Knob to change the character. It is also possible to rename ZONE2, ZONE3, and RECORD – see section 3.10.

When a source is renamed, the new name appears next to the factory name in the Source Setup and Mode Presets root menus and at the top of the renamed source's submenu.

Example: Rename "AUX" to "GAME".

- Enter the setup menu. Go to SOURCE SETUP and press **SELECT**.
- Press the ▼ button until you reach AUX and press **SELECT**.
- RENAME: AUX will be highlighted in red.
- Press **SELECT**. The first character "A" will be highlighted in red.
- Use the Master Control Knob or the ▲ ▼ buttons to change characters. Change the first one to "G".
- Press the ▶ button to move to the next character. Change it to "A".
- Use the ◀ ▶ buttons to move to each remaining character. Change to "M" and "E".
- Press **BACK** to leave the submenu and return to the main menu.

Video Output Configuration (MAIN only):

Choose between configurations 1 to 4 as set in the VIDEO OUTPUT menu, or Last Used. When Last Used is selected, the video configuration will be the same as the one that the previously selected source was using.

3. SETUP continued ...

Scaler Input (MAIN only):

Assign which input is used by the video processor when the source is selected – any HDMI, Component video, S-Video input, or “None”. Before setting this, be sure that you have read section 2.1. Note that if S-Video is selected, the input connection is the one specified in S-VIDEO IN. To increase seeking speed for the seek function in section 4.4, set this to None if the source does not use video processing.

Component, S-Video, Composite Video Inputs:

Assign which video input (or None) is used for unprocessed video switching when the source is selected, including in ZONE2, ZONE3, and REC.

Audio In (MAIN only):

There are three input types to choose from – Digital, Analog-DSP, and Analog-Direct. After highlighting AUDIO IN use the ◀ ▶ buttons to select an input format.



In Digital and Analog-DSP, all channels are upsampled to 24-bit / 192 kHz ensuring the finest in high-end sound reproduction. This applies even when the input is Dolby Digital or DTS.

- **Dig** (Digital): Choose any HDMI, coaxial, optical, or the AES/EBU connection. Any digital input can be assigned to multiple sources. This allows, for example, two setups for the same DVD player – one for DVDs using DVD1 source setup, and the other for CD music using CD source setup. Note that Dolby Digital and DTS are transmitted only through a digital connection.
- **Anlg-DSP** (Analog with Digital Signal Processing): Analog input is converted using high-end A/D converters to enable bass management, time alignment, Anthem Room Correction, surround mode, bass/treble, lip-sync delay, and THX. If you want your subwoofer to play from an analog L/R input, use this setting.
- **Anlg-Dir** (Analog-Direct): The preamp plays the traditional role of switching inputs and adjusting levels. All digital processing is bypassed.

If Preferred is set to HDMI in menu 1 and HDMI audio is selected here, Scaler Input must also be HDMI.

Auto Digital (MAIN only):

If set to Yes, the input type switches to Digital when sensing a digital clock signal from a source and to Analog-DSP when no clock signal is present. This feature is useful with older digital cable boxes that use the digital output for digital channels and analog output for analog channels.

Example: Change SAT1 Digital Input to optical.

- Make sure satellite receiver is connected to OPT1 and playing.
- Enter the setup menu. Go to SOURCE SETUP and press **SELECT**.
- Press the ▼ button until you reach SAT1 and press **SELECT**.
- Press the ▼ button until you reach AUDIO IN.
- Use the ◀ ▶ buttons to change to OPT1 (sound will now be heard).
- Press **BACK** to leave the submenu and return to the main menu.

Analog Audio:

If Audio In is set to analog, assign which input is used – any analog audio input can be used.

3. SETUP continued ...

Muting (MAIN only):

This eliminates popping sounds that may occur with some digital source components during a bitstream change. If popping is heard when changing chapter on a DVD or channel on a digital satellite receiver or cable box, use Max setting. However, if the beginning of a track is cut off when playing a CD, use Min setting.

EQ (MAIN only):

For sources set to Digital or Anlg-DSP, you can preset low and high frequency levels. This is useful for source components that have frequency irregularities. After highlighting the EQ line, press **SELECT** and use the ◀ ▶ buttons to select LF (low frequency) or HF (high frequency), then use the ▲ ▼ buttons to adjust. In the FM/AM Setup/Presets menu, FM and AM can be adjusted separately. The EQ settings in this menu and the on-the-fly BASS / TREBLE adjustments do not affect each other (see section 4.7).

Bass Manager (MAIN only):

Choose between Movie or Music configuration as set in the Bass Management menu, or Auto-LFE. When Auto-LFE is selected, the Movie configuration is used if the source contains LFE, and changes to the Music configuration at all other times. Auto-LFE is recommended when using two bass management configurations and the same player for DVDs and CDs.

Room EQ (MAIN only):

To disable room correction equalization performed with the ARC-1 microphone kit, change this to Off. If measurement info isn't loaded "NA" is displayed.

Lip-Sync (MAIN only):

Video can fall out of synchronization with audio for a variety of reasons. The Statement D2v's video processing causes video to be delayed by 24 milliseconds, which is less than the duration of one frame, thus considered synchronized. If for whatever reason audio is heard before the corresponding image is seen, you can set up to 170 milliseconds of audio delay. To adjust while watching video see section 4.9.

Example: Set DVD1 Lip-Sync delay to 24 milliseconds.

- Enter the setup menu. Go to SOURCE SETUP and press **SELECT**.
- Press the ▼ button until you reach DVD1 and press **SELECT**.
- Press the ▼ button until you reach LIP-SYNC and press **SELECT**.
- Use the ◀ ▶ buttons to move from digit to digit and the ▲ ▼ buttons to adjust to 24 ms.
- Press **BACK** to leave the submenu and return to the main menu.

3.7 MODE PRESETS

Mode and THX presets are applied when the source is selected or MAIN is turned on. Each input format except mono and Anlg-Dir has a setting. **If you do not want to use presets, set them to Last Used.**

After selecting a source in the MODE PRESETS root menu, a menu such as the DVD1 example below appears. Use the ▲ ▼ buttons to highlight an input format then use the ◀ ▶ buttons to select. For descriptions of surround modes and when to use them, refer to section 4.8.

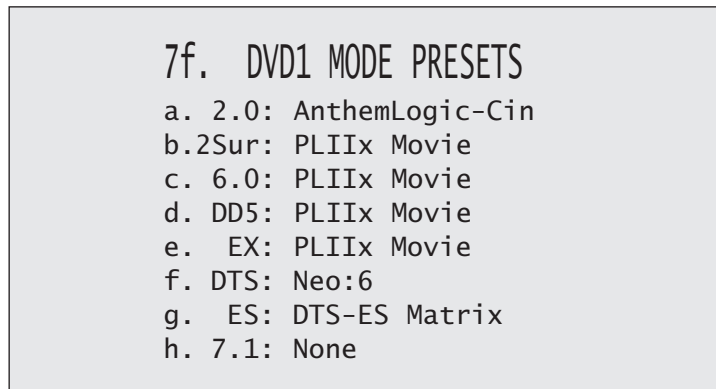

Program	Preset Selections
• 2.0	For stereo input, select any mode in section 4.8.3, THX Games Mode, or Last Used. Dolby Pro Logic, Pro Logic IIx Movie, and Neo:6 Cinema can be set with or without THX Cinema.
• 6.0	Select your playback preference for multichannel PCM (via HDMI) and 6-Ch analog input: PLIIx Movie (with or without THX Cinema), PLIIx Music, Dolby D EX, THX Surround EX, THX Cinema, THX Ultra2 Cinema, THX MusicMode, THX Games Mode, Neo:6 (with or without THX Cinema), Last Used, or None (see sections 4.8.4 and 4.8.6).
The following apply to Digital inputs only:	
• 2.0-Sur	Separate setting especially for surround-flagged Dolby Digital 2.0 material (section 4.8.2), normally PLIIx Movie but any setting that applies to regular stereo input can also be used.
• DD-5.1	Select your playback preference for Dolby Digital 5.1 material: PLIIx Movie (with or without THX Cinema), PLIIx Music, Dolby D EX, THX Surround EX, THX Cinema, THX Ultra2 Cinema, THX MusicMode, THX Games Mode, Neo:6 (with or without THX Cinema), Last Used, or None (see sections 4.8.4 and 4.8.6).
• DD-EX	For material encoded in Dolby Digital Surround EX: PLIIx Movie (with or without THX Cinema), PLIIx Music, Dolby D EX, THX Surround EX, Neo:6 (with or without THX Cinema), Same as DD-5.1, Last Used, or None (see sections 4.8.4 and 4.8.6).
• DTS-5.1	For DTS material: Neo:6 (with or without THX Cinema), PLIIx Movie (with or without THX Cinema), PLIIx Music, Dolby D EX, THX Cinema, THX Ultra2 Cinema, THX MusicMode, THX Games Mode, Last Used, or None (sections 4.8.5 and 4.8.6).
• DTS-ES	For DTS-ES: DTS-ES Matrix (with or without THX Cinema), PLIIx Movie (with or without THX Cinema), PLIIx Music, Dolby D EX, Same as DTS, Last Used, or None (see sections 4.8.5 and 4.8.6). Note that for ES Discrete, this setting is overridden and playback is in 6.1.
• 7.1	For HDMI 7.1-channel: THX Cinema, Last Used, or None (see section 4.8.6).

3.8 ANALOG INPUT LEVELS

For sources set to Anlg-DSP or Anlg-Dir in under Source Setup, you can match input levels in MAIN to each other so there are no large changes in volume as you change sources. This is also where recording level is set when using the processor as an analog-to-digital converter (see sections 3.6, 3.9, and 4.3).

8. ANALOG INPUT LEVELS		
a.	CD:	+0.0 dB
b.	2-Ch:	+0.0 dB
c.	6-Ch:	+0.0 dB
d.	TAPE:	+0.0 dB
e.	FM/AM:	-5.0 dB
f.	DVD1:	+0.0 dB
g.	DVD2:	+0.0 dB
h.	DVD3:	+0.0 dB
i.	DVD4:	+0.0 dB
j.	TV1:	+0.0 dB
k.	TV2:	+0.0 dB
l.	TV3:	+0.0 dB
m.	TV4:	+0.0 dB
n.	SAT1:	+0.0 dB
o.	SAT2:	+0.0 dB
p.	VCR:	+0.0 dB
q.	AUX:	+0.0 dB

If a source that is set to Analog-DSP is playing while you adjust the Input Level, you will notice a vertical bar graph to the left of the dB settings. With the on-screen display, this Bar Graph has a green, pink, and red area. The pink area, when showing, represents the last 6 dB of undistorted range and the red area, when showing, indicates overload. On the front panel display the overload indication is the uppermost segment, and the one below it is the "6 dB or less remaining" indicator.

Before making changes or adjustments in this menu, have all source components playing music with comparable dynamics. As you switch highlighted source, you will hear that component play. Remember, input levels applies only to analog sources and the bar graph only works with Analog-DSP setting.

Example: Adjust TAPE Input Level.

- Make sure a source is connected to TAPE Analog L/R, set accordingly in menu 6 and playing.
- Enter the setup menu. Go to ANALOG INPUT LEVELS and press **SELECT**.
- Press the ▼ button until you reach TAPE: +0.0 dB.
- Press **SELECT**. +0.0 dB will be highlighted in red.
- Use the ▲ ▼ buttons to change the Level.
- When finished, press **BACK** then ▲ ▼ to go to another source, or...
- Press **BACK** to leave the submenu and return to the main menu.

3.9 ADC / AUDIO OUTPUT

In the ADC / Audio Output menu you can set analog to digital conversion for the digital Record output and configure the balanced analog outputs.

9. ADC / AUDIO OUTPUT

- a. 6-CH ANLG-DSP: 96 kHz
- b. 2-CH ANLG-DSP: 44.1kHz
- c. MAIN>REC: 24Bit
- d. DIGITAL2: DIGITAL 1
- e. BAL OUT: Ctr2/Sub2

Sampling Frequency:

When a source that is set to Anlg-DSP is copied from MAIN to RECORD, the analog signal is converted to digital using the processor's high-end A/D converters, and sent to DIGITAL1. This is useful for recording analog sources on a CD burner or computer with S/PDIF input on the sound card. You can select from 44.1, 48, 88.2, or 96 kHz sampling rates. Recording level is set in the Analog Input Levels menu.

Use 48, 88.2, or 96 kHz only if the equipment connected to DIGITAL1 and DIGITAL2 accepts those rates. CD audio always uses 44.1 kHz.

The 6-Ch input has its own setting. When copied from MAIN to RECORD, the output is a 2-channel downmix.

Bit Rate of DIGITAL1 when MAIN is copied to REC:

Choose from 16 or 24 bit output, to match the recorder. At 16 bits, dither is added to improve low level signals.

Output of DIGITAL2:

Set it to have the same output as DIGITAL1, or a fixed output from any source set to Digital (DVD1, SAT1, etc.). DIGITAL1 and DIGITAL2 transmit data from digital sources in the same format it comes in – if it's Dolby Digital or DTS encoded, it stays that way and can be linked to other digital equipment.

Balanced Output:

If the Balanced CENTER2 and SUB2 outputs are not in use for a second center channel or subwoofer in MAIN, they can be used as Balanced ZONE2 L/R outputs. This is advantageous if the ZONE2 power amplifier has XLR inputs and is far from the processor, requiring a long interconnect.

3. SETUP continued ...

3.10 VOLUMES / PATH NAMES

This menu allows you to define the power-on volume settings, set whether or not MAIN outputs shut off when headphones are used, and to rename ZONE2, ZONE3, and RECORD.

10. VOLUMES / PATH NAMES

- a. MUTE LEVEL: Silent
- b. MAIN ON VOLUME: -35.0
- c. MAIN MAX VOLUME: +10.0
- d. ZONE2 ON VOL: -35.0
- e. ZONE2 MAX VOL: +0.0
- f. ZONE3 ON VOL: -35.0
- g. ZONE3 MAX VOL: +0.0
- h. HPHONE ON VOL: -35.0
- i. HPHONE MAX VOL: +10.0
- j. HPHONE MUTE SPK: No
- k. RENAME ZONE2: ZONE2
- l. RENAME ZONE3: ZONE3
- m. RENAME RECORD: RECORD

Mute Level:

When MUTE is pressed, sound can cut out completely, or decrease in volume by the amount that you set to keep some of it in the background – select from Silent or -5 to -30 dB in 5 dB steps.

Power-On Volume:

When you turn MAIN, ZONE2, or ZONE3 on, or plug in your headphones, the volume for each will come on at the known levels you have set in this menu. This prevents surprises when not knowing the volume someone had set when turning the processor off, then having the power-on volume be too loud or quiet. You can set independent volumes for MAIN, ZONE2, ZONE3, and HEADPHONE.

Maximum Volume:

These settings allow you to limit the volume of MAIN, ZONE2, ZONE3, or HEADPHONE to avoid damaging your equipment and/or your ears. This can also serve as a parental volume control feature. The range of settings available for MAIN is from -95.5 dB to +31.5 dB in steps of .5 dB, and for ZONE2, ZONE3, and HEADPHONE, the range is from -70.0 dB to +10.0 dB in 1.25 dB steps.

To set a fixed output for ZONE2 or ZONE3, scroll MAX VOL past +10.0 dB to select LockOnVol, then set the desired fixed output level in ON VOL. When the path is on, "Lock" is displayed beside the volume readout to indicate that its volume cannot be changed with the volume control.

Headphone Mutes Speakers:

Determines whether or not the MAIN speakers turn off when headphones are plugged into the front panel:

- **Yes** The MAIN speakers mute. "HPHONE" is displayed instead of "MAIN" to indicate that adjusting volume, bass, treble, and balance affect HEADPHONE only.
- **No** MAIN speakers continue to play when headphones are plugged in.

Rename Path:

The factory assigned path names that appear on the front panel and on-screen displays can be changed to another name up to six characters long – the procedure is the same as Rename Source under Source Setup.

3. SETUP continued ...

3.11 TRIGGERS / IR / RS232

When a trigger output on the processor is connected to the trigger input of another component, such as an amplifier or projector, the processor can turn it on or off according to the trigger's Setup. For components that do not have trigger inputs, a triggerable power bar may work (see your dealer).

Three 12 volt trigger outputs are provided – Trigger1 and Trigger2 each have maximum current output of 50 mA and Trigger3 has maximum current output of 200 mA. There is a quarter of a second delay between each trigger to minimize line voltage drops caused by switching on too many devices at once.

11. TRIGGER / IR / RS232

- a. ALL TRIGGERS:Disabled
- b. SET TRIGGER 1
- c. SET TRIGGER 2
- d. SET TRIGGER 3
- e. SET IR-INPUTS
- f. BAUD RATE: 19200
- g. FLOW CONTROL: None
- h. RS-232 TX STATUS: Off

All Triggers:

When "Disabled" all triggers remain off. When "Enabled" the trigger chart below is used to set conditions. For custom installation, the "RS-232 Ctrl" setting uses external control.

Set Trigger:

Highlighting SET TRIGGER 1 then pressing **SELECT** displays this menu:

11b. SET TRIG-1 SOURCES

	MAIN	Z2	Z3	REC
a. POWER:	*	-	-	
b. CD:	-	-	-	-
c. 2-Ch:	-	-	-	-
d. 6-Ch:	-	-	-	-
e. TAPE:	-	-	-	-
f. FM/AM:	-	-	-	-
g. DVD1:	-	-	-	-
h. DVD2:	-	-	-	-
i. DVD3:	-	-	-	-
j. DVD4:	-	-	-	-
k. TV1:	-	-	-	-
l. TV2:	-	-	-	-
m. TV3:	-	-	-	-
n. TV4:	-	-	-	-
o. SAT1:	-	-	-	-
p. SAT2:	-	-	-	-
q. VCR:	-	-	-	-
r. AUX:	-	-	-	-

In the example shown, TRIGGER 1 activates when MAIN power is turned on. Trigger outputs can also be set to activate according to source instead of Power.

3. SETUP continued ...

After highlighting Power or a source, press **SELECT** and use the ◀ ▶ buttons to move from one path to another. To set the condition, use the ▲ ▼ buttons to change the “-” to a “*”. Don't forget: In the root menu you have to set ALL TRIGGERS to Enabled for the triggers to work.

Changes to the trigger setup do not take effect until exiting from the setup menu, to avoid unnecessary rapid turning off and on of triggers while making changes.

Example: Activate Trigger2 when DVD1 is selected in MAIN.

- Enter the setup menu. Go to TRIGGER / IR / RS232 and press **SELECT**.
- Upon entering this menu item, ALL TRIGGERS will be highlighted in red.
- Use the ◀ ▶ buttons to change to Enabled.
- Press the ▼ button to go to SET TRIGGER 2. Press **SELECT**.
- Use the ▲ ▼ buttons to go to DVD1. Press **SELECT**.
- Use the ▲ ▼ buttons to change the “-” to “*”.
- Press **BACK** twice to leave this submenu.

Set IR Inputs:

This allows you to enable or disable the processor's infra-red inputs. Being able to do so can be useful when an IR receiver connected to the processor is in the same room as the processor. In this case the processor can receive two IR signals for the same command – one through the front and one through the back. The double-command may affect responsiveness – disabling the front IR solves this problem.

11e. SET IR-INPUTS

	MAIN	Z2	Z3
a. FRONT IR:	*	*	*
b. REAR IR 1:	*	*	*
c. REAR IR 2:	*	*	*
d. REAR IR 3:	*	*	*

After highlighting an IR input, press **SELECT** and use the ◀ ▶ buttons to move from one path to another. To turn the input off, use the ▲ ▼ buttons to change the “*” to a “-”. Do this through the front panel, since remote control commands are ineffective once an IR sensor is turned off.

If the processor does not respond to remote control commands, enter the Setup using the front panel buttons, go to the TRIGGER / IR / RS232 menu then SET IR-INPUTS, and make sure the FRONT IR settings are set to “*”. **Try this before contacting technical support (see also section 5.6).**

Baud Rate and Flow Control (normally for use only by custom installers):

The Baud Rate (adjustable from 1200 to 115200 bps), and Flow Control (RTS, CTS, or None), allow configuration of the serial port communication parameters.

RS-232 TX Status (normally for use only by custom installers):

When On, all commands, status changes, and control information are echoed through the RS-232 port.

3.12 DISPLAYS / TIMEOUT

This menu allows you to configure on-screen display, front panel display, and selection time.

12. DISPLAYS / TIMEOUT

- a. MAIN OS OUT: S-V + HD
- b. MAIN OS INFO: All Zones
- c. MAIN OS POS'N: Bottom
- d. MAIN OS COLOR: Blue
- e. MAIN VID MUTE: Gray
- f. Z2 OS OUT: S-V Only
- g. Z2 OS INFO: Z2 Only
- h. Z2 OS POS'N: Bottom
- i. Z2 OS COLOR: Blue
- j. Z2 VID MUTE: Gray
- k. FP WAKE-UP: Up 1
- l. DISPLAY TIMEOUT: 5 s

Main / Z2 On-Screen Output:

Lets you select the outputs that display on-screen information, or Bypassed, which turns the on-screen display off. If you choose Bypassed, you will have to rely on the front panel display. If you are using S-Video inputs and prefer the appearance of the HD characters, select HD Only – the HD characters will be used if a video signal is present.

Main / Z2 On-Screen Info:

Select the path adjustments that are shown by the on-screen displays. For example, if ZONE2 is set up with an IR repeater for the remote control and you are using the processor in the MAIN room, you may not want to see information about ZONE2. On the other hand, you may want to see the ZONE2 information, for example, while adjusting ZONE2 yourself from the MAIN room.

Main / Z2 On-Screen Position:

Allows you to position the on-screen display to reduce the chance of it interfering with the on-screen display positions of other video components (e.g. satellite receiver's status info). Choose from Bottom, Mid, or Top.

Main / Z2 On-Screen Color:

If the on-screen display of the setup menu appears unstable, it could be that your display is not synchronizing to the blue (factory default) background color. You can change the background color to one that your display can synchronize to – gray and magenta are also available.

Main / Z2 Video Mute Color:

For when there's no video input, select the "no signal" output – gray, blue, or magenta screen.

3. SETUP continued ...

Front Panel Wake-Up:

If Display is set to Medium, Low, or Off, it can be made to change to a brighter level while you make any adjustment – choose None, Up 1 brightness level, or Hi. When None is chosen and the Display is Off, it will behave as if set to Up 1 to prevent confusion as to whether the power is on or off.

Example: Disable the front panel wakeup.

- Enter the setup menu. Go to DISPLAYS/TIMEOUT and press **SELECT**.
- Press the ▼ button until you reach FP WAKE-UP.
- Use the ◀ ▶ buttons to change to None.
- When finished, press ▲ ▼ to go to another menu item, or...
- Press **BACK** to leave the submenu and return to the main menu.

Display Timeout:

This is the time that elapses after an adjustment is made in any path. After that, on-screen text disappears, the front panel becomes dim, and the regular MAIN display returns. Adjustable from 1 to 15 seconds.

3.13 SAVE / LOAD SETTINGS

Two memories can back up menu settings. If your system was set up by your dealer, the settings may be saved in Installer memory. You can make further adjustments – save those settings in User memory. Video processor settings (section 4.11) and FM•AM presets are also saved.

13. SAVE / LOAD SETTINGS

- a. SAVE USER SETTINGS
- b. LOAD USER SETTINGS
- c. SAVE INSTALLER SET'NS
- d. LOAD INSTALLER SET'NS
- e. LOAD FACTORY DEFAULTS

Save and Load Settings:

When saving or loading settings, the processor will prompt you to confirm that you want to replace the current settings – press **BACK** at this point if you don't want to make the changes.

To clear adjustments described in sections 4.6 and 4.7, save User Settings, then load Factory Defaults, then load User Settings. The Setup will remain as it was. If certain channels don't sound as loud as they should under certain conditions, and you have calibrated levels according to section 3.5, try this before contacting technical support. The cause may just be a forgotten adjustment, or an adjustment that someone else made and didn't tell you. **Happens sometimes!**

Example 1: Save User Settings.

- Enter the setup menu. Go to SAVE / LOAD SETTINGS and press **SELECT**.
- Upon entering this menu item, SAVE USER SET'NS will be highlighted in red.
- Press **SELECT**. You will be asked to confirm that you want to over-write current settings.
- Use the ◀ ▶ buttons and change to Yes. If you are using a Password, you will be asked for it. Use the 0 – 9 buttons to enter your Password. The on-screen display will say Saving Successful and the front panel will say Done.

Example 2: Load Installer Settings.

- Enter the setup menu. Go to SAVE / LOAD SETTINGS and press **SELECT**.
- Press the ▼ button until you reach LOAD INSTALLER SET'NS.
- Press **SELECT**. You will be asked to confirm that you want to restore installer settings.
- Use the ◀ ▶ buttons to change to Yes and press **SELECT**. The on-screen display will say Installer Settings Loaded and the front panel will say Done.

Example 3: Load Factory Defaults.

- Enter the setup menu. Go to SAVE / LOAD SETTINGS and press **SELECT**.
- Press the ▼ button until you reach LOAD FACTORY DEFAULTS.
- Press **SELECT**. You will be asked to confirm that you want to load factory settings.
- Use the ◀ ▶ buttons to change to Yes and press **SELECT**. The on-screen display will say Factory Defaults Loaded and the front panel will say Done.

3.14 LOCKOUT / PASSWORDS

Passwords are used to protect the saved User and Installer settings. Once you have set a password, it can also be used as a Lockout to prevent settings from being changed by anyone without one of the passwords.

14. LOCKOUT / PASSWORDS

- a. LOCK SETTINGS
- b. SET USER PASSWORD
- c. SET INSTALLER PASSW'D

Lock Settings:

When set to Yes, entry to the setup menu is prevented unless the password is entered first.

Set User or Installer Password:

Whether or not settings are locked, if a password is set, it will still be required to save changes to User or Installer settings. Pick a 4-digit number that you will remember easily. To enter it, use the **0 – 9** keys on the remote control (password cannot be entered from the front panel). To change a password, enter the old one, then enter (and confirm) the new one. Keep a record of your password in case it's forgotten!

Example 1: Set User Password (remote control only).

- Enter the setup menu. You must enter the USER or INSTALLER password if there is one.
- Go to LOCKOUT / PASSWORDS and press **SELECT**.
- Press the **▼** key to go to SET USER PASSWORD.
- Press **SELECT**. You will be asked to enter a four digit number – use the **0 – 9** keys. If you are changing your password you will be asked to enter your old one first. You will also be asked to confirm your new one.

Clearing the password: When asked for your new password, press the **▶** key four times. You will also be asked to confirm – press the **▶** key four times again. Message will say "User Password Removed".

Example 2: Lock Settings (remote control only).

- Enter the setup menu. Go to LOCKOUT / PASSWORDS and press **SELECT**.
- Upon entering this menu item, LOCK SETTINGS will be highlighted in red.
- Press **SELECT**. You will be asked to enter a password. The USER or INSTALLER password will work.
- Use the **◀ ▶** buttons to change to Yes or No.
- Press **SELECT** or **BACK**.

3.15 ARC-1 ANTHEM ROOM CORRECTION

ARC-1 corrects the effects of reflective surfaces and room boundaries on sound quality by measuring the response of each speaker relative to the listening area and equalizing it. ARC equalizes response without stressing the amplifier or speakers and does not downsample the source material to process it. ARC's filters are neither graphic nor parametric – ARC is a sophisticated system that flattens response using its ability to create practically any suitable function, inherently correcting phase effects created by the room.

The default correction range is up to 5 kHz. Although the limit can be changed if needed, a higher one is generally not advised since the microphone becomes directional at upper frequencies, affecting measurement accuracy especially if the height of the speaker's high frequency driver is not at ear level.

ARC also detects how much the room reinforces low frequencies due to its boundaries and pressurization. This room gain shows as a bump in the target response. ARC does not remove it because if flattened, bass sounds thin. Ideal anechoic speaker response, a straight line as measured in a special non-reverberant facility, is not the same as ideal in-room response which normally includes, to varying degree, this room gain.

ARC senses where each speaker's low-frequency response declines and sets high-pass filters accordingly.

Calibration is set such that average level is the same when comparing EQ "On" vs "Off". Note that to set levels ARC uses a midrange band that's wider than the standard home theater setup noise, which is centered at 1 kHz and narrow so there's no chance its level would be reduced by a crossover.

Sample response:

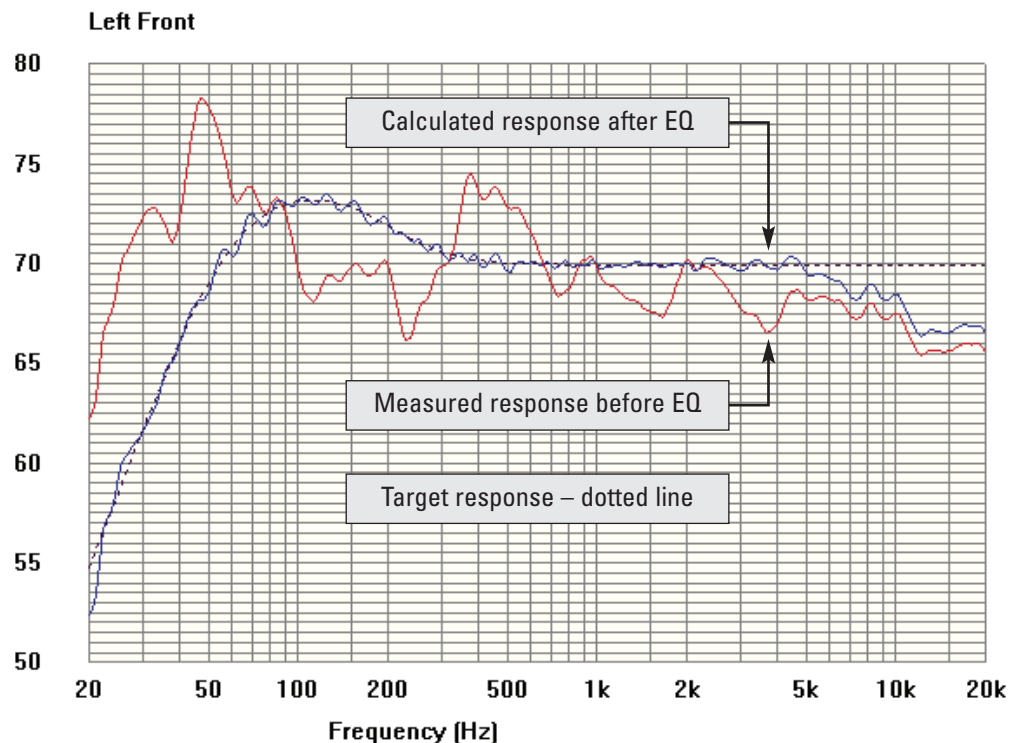

My subwoofer also has equalization. Should I use it?

Since rooms, correction systems, number of subwoofers, and speaker/listener positions vary, the answer varies although it is best to disable the subwoofer's EQ before running ARC. If the resulting calculated and target curves resemble each other, there is usually no reason to use the sub's EQ. If the curves significantly differ through a wide range, enable the sub's EQ and run ARC again to see if it helps. If you have run ARC with the sub's EQ enabled, ARC must be run again once the sub's EQ is turned off.

3. SETUP continued ...

Before starting:

- Ensure that the processor software and ARC software that you will be using are compatible with one another – check www.anthemAV.com for latest versions. Processor software installation instructions are in section 6.
- Your ARC-1 microphone, its support files, and your processor are a system with matching serial numbers – substitutions are not possible. Before a mic can be used for measurement, its response must be known. Each ARC-1 microphone's frequency response is measured precisely and this data is used to create your microphone calibration files.
- Your computer must be running Windows XP or Vista and have one 9-pin serial port (for connecting the processor) and one USB port (for connecting the mic), **or** one USB port and one card slot and a serial card, **or** two USB ports and a USB to serial adapter. The latter is least preferred.

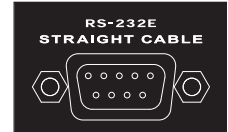

If using a USB to serial adapter to connect the processor:

1. It must be one that supports two stop bits – check with adapter manufacturer.
 2. Check the adapter manufacturer's website for the latest driver. If a message warns that the driver is not Windows-certified as it's about to be installed, do not use the adapter. Some "budget" adapters load bad data into the processor, possibly causing its operation to freeze.
 3. The virtual port must be assigned to COM1-COM6. If the processor software installer cannot locate the processor, use your adapter's port manager to check the setting.
- If you are using a laptop computer, check its power settings and battery meter to ensure that procedures will not be interrupted.
 - If the room contains large objects that won't be present during the system's normal use, move them out so ARC doesn't pick up reflections that won't be present during normal use.
 - While taking measurements it would be best to keep pets and younger or talkative family members out of hearing range. The measurements reject continuous background noise such as fans but if a sudden noise is made ARC will indicate that re-measurement is required.
 - ARC bypasses Center Channel EQ, Room Resonance Filter, and Boundary Gain Compensation.
 - Two configurations may be saved – one under Movie bass management and the other under Music.

Additional instructions for Mac computer use:

An Intel-based Mac with Bootcamp is required (ARC does not work with Parallels). To install Bootcamp:

- Do a Spotlight search for Bootcamp.
- Follow installation instructions to the letter – this involves partitioning the hard drive.
- After Bootcamp is installed, hold the Option key during bootup to display the two operating system options and select Windows.

3. SETUP continued ...

ARC software installation:

Play the ARC CD in your computer's CD or DVD drive. Instructions will appear on your screen. If your computer does not allow a CD to auto-run then double-click on the My Computer icon that's on Desktop, select the drive that the CD is in to view its contents, and double-click on setup.exe.

The installation will put several files into an Anthem folder on your computer and create shortcuts on your Start Menu and Desktop. Two files begin with your processor's serial number. Examples: 123456_100002.cal and 123456_100002Anthem.file.

Custom installers: To set up multiple systems using one computer, copy the two serialized files from each ARC CD to this directory after ARC is installed:

My Computer, Local Disk C:\Program Files\Anthem\AnthemRoomCorrection

Microphone stand assembly:

Screw the telescoping tube into its base and the microphone clip onto the tube. Position the clip vertically. Connect the USB microphone cable to the microphone and slide the microphone into the clip.

Microphone positioning:

During measurement the microphone must point straight up. The microphone's height is critical to proper measurement and should be at ear level when seated.

Ideally, the front speakers' high-frequency drivers should be at approximately the same height as the listener's ears but if they aren't and the result sounds dull or bright, microphone height will have to be adjusted and measurements repeated.

To adjust the length of the telescoping tube, first loosen its clamp by rotating it counterclockwise.

Five listening area positions are normally measured but this number can be increased up to ten. The first must be at or just in front of the central seating position. This is also used to set Speaker Calibration levels. Positions 2 and 3 should be symmetric to the left and the right of the center line, and the same applies to the remaining positions. If your room has less than five seating positions, measurements must still be taken from five positions at least 2 feet (70 cm) apart to ensure optimal sound.

Measurement:

- Connect the microphone and the processor to the computer.
- Set the microphone in the first position. Don't stand near the microphone while sweep tones are playing otherwise reflections from your body may cause bad measurements.
- Run Anthem Room Correction by selecting it from the Start Menu or double-clicking the Desktop shortcut and select Standard mode. The program will guide you through the remaining steps and at the end will load the correction data to your processor. The process takes about 20 minutes depending on the number of measurements.
- Once the ARC program is finished, you can disconnect the computer. Turn on the processor and set "Room EQ:" On/Off in the Source Setup menu according to each source. If you made measurements for a Music configuration, assign Bass Manager accordingly.
- Save your settings in the Save / Load Settings menu. Note that changing the Sub crossover in the Bass Management menu affects only Room EQ "Off" sources.

3. SETUP continued ...

Advanced:

After a file is created in Standard mode, it can be opened in Advanced mode to change correction range and room gain. To do this, change Targets then click on Calculate, then Upload.

Since rooms and systems vary the only advice that Anthem technical support can provide without being at your house to hear your system is to use the auto-detected settings. The alternative is trial and error.

To change the amount of room gain, the Force checkbox has to be checked for the manually entered change in dB to take effect once clicking on Calculate. To restore the settings sensed by ARC, click on Auto Detect and re-calculate. Clicking on Erase uploads flat parameters.

Updating ARC:

Check www.anthemAV.com periodically for ARC software updates. The download contains revision history, which may also indicate that the processor requires an update for the ARC version to work correctly.

If a newer version is posted and you would like to use it, check your current version:

- Run Anthem Room Correction in Advanced mode.
- Click on Help then click on About. The version number will be displayed.

Proceed only if your version is not the latest:

- Download the latest software from our web site to Desktop.
- When download is complete, right-click on the downloaded .zip file and extract it to Desktop.
- Open the extracted folder and double click on setup. Software installation instructions will appear on your screen. **If you are installing ARC on the computer for the first time, copy your two serialized files from your software CD to the extracted folder on Desktop before double-clicking on setup.** This way they will be added to Program Files as the software is installed.
- When installation is complete, you can delete the downloaded file and the extracted folder.

4. OPERATION

4.1 POWER ON/OFF

The processor comes on at the volume setting in the Volumes setup menu. **The power amplifier should be turned on last and off first to prevent “popping” when upstream components are turned on and off.**

Front Panel – Main on

- Press **MAIN** in the POWER or the PATH group. Alternatively, if ZONE2 and ZONE3 are off, press any **SOURCE** button, FM • AM preset, or **TUNE**.

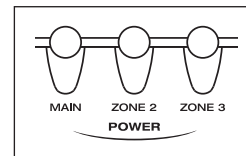

Front Panel – Zone off

- Press **ZONE2** or **ZONE3** in the POWER or PATH group.

Front Panel – Main or a Zone off

- Press **MAIN** or **ZONE2** or **ZONE3** in the POWER group.

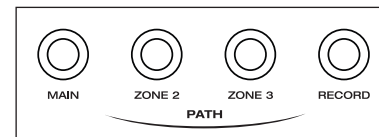

Remote Control – Main or a Zone on

- Make sure the appropriate control mode is set (**MAIN**, **Z2**, or **Z3** in the SSP PATH group) then press **POWER**.

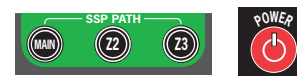

Remote Control – Main or a Zone off

- Make sure the appropriate control mode is set then press **SSP OFF**.



4.2 PATH SELECTION

Path routes sources to the MAIN, ZONE2, ZONE3, or RECORD outputs.

- **MAIN:** Routes sources to your main listening/viewing room, with outputs for 7.1-channel audio and the main display.
- **ZONE2** and **ZONE3:** Routes sources to other rooms in your home. The source selection can be the same as or different from the source selected in other paths. ZONE2 and ZONE3 each have outputs for a TV and 2-channel audio. **To listen to a source that is not connected via L/R analog audio, you must “copy” it from MAIN (see section 4.3).**
- **RECORD:** Except when prevented by copy protection, allows you to record sources independently of what is selected in other paths. Composite and S-Video, and fixed-level analog audio outputs are available for two recorders. In addition, the two coaxial digital audio outputs DIGITAL1 can put out the audio of any digital source, or convert an analog source to digital. DIGITAL2 can put out the same signal as DIGITAL1, or any of the sources set to Digital. To use conversion or downmixing, the source must be copied from MAIN – see section 4.3. **Analog audio RECORD output has a signal only if L/R analog audio is connected or when MAIN is copied.**



Remote control – the **REC** PATH key is near the bottom of the remote control.

The displayed path returns to MAIN a few seconds after an adjustment is made in ZONE2, ZONE3, RECORD, or HEADPHONE*. This is designed to prevent accidents. For example, if someone in the MAIN room wants to turn up the volume there, and the path is in ZONE2, the volume would increase in ZONE2, not MAIN. Since the person adjusting the volume doesn't hear the change, chances are that he or she would keep turning up the volume in ZONE2, unaware of what's happening there.

* Except when MAIN is off or HEADPHONE is set to mute the MAIN speakers in the Volumes setup menu.

4. OPERATION continued ...

4.3 MANUALLY COPYING THE MAIN PATH TO ZONE2, ZONE3, OR RECORD

When Main is copied to another path, the source selected in MAIN is directed to the other path.

If a source component's audio is connected to the processor using digital connection only, the Copy function is the only way to deliver the sound to another path.

Front Panel

Press **MAIN** simultaneously with **ZONE2**, **ZONE3**, or **REC**. Use **MAIN** to select the source.

Remote Control

Make sure the appropriate control mode is set, or **REC** path is selected, then press **COPY**.



When MAIN is copied, the display for the other paths reads “-MAIN-> ZONE2” (or ZONE3 or REC), along with the information normally displayed. **Copy can also be set permanently in the source setup menu.**

Downmixing to 2-Channel Stereo:

The center, surround, and rear channels can be mixed into the left and right channels for the ZONE2, ZONE3, TAPE, and VCR outputs. This can be done by the DVD player or the processor:

- **Processor downmix:** If the digital audio output from your DVD player is connected to the processor, the processor down-mixes 5.1 channels into 2.0 when you copy MAIN to another path. This applies whether the input is, Dolby Digital, DTS, or 6-Ch input.
- **DVD player downmix:** If the left/right analog outputs from your DVD player are connected to the processor's Analog Audio-In, the Dolby Digital down-mix done by your DVD player can be used for ZONE2, ZONE3, TAPE, and VCR outputs, without having to copy MAIN. Note that DVD players do not normally provide a down-mix for DTS material.

4.4 SOURCE SELECTION

After making sure that you are in the appropriate path (front panel) or appropriate control mode is set (remote control), select a source.

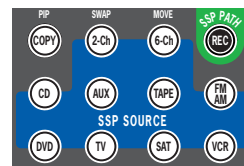
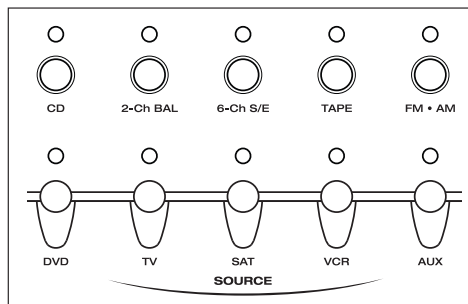

6-Channel Analog Audio Input:

The 6-Ch audio can be routed to ZONE2, ZONE3, and RECORD outputs as long as Copy mode, which creates the stereo down-mix, is used.

Source Seek (remote control only):

The SOURCE SEEK ◀▶ keys detect the previous/next active source, while the ▶ key advances one source at a time.



4. OPERATION continued ...

4.4.1 FM•AM TUNER

The processor has an FM•AM tuner. The selected station is common to all paths.

Manual Tuning:

After selecting the desired band by pressing **FM•AM**, use the \blacktriangle \blacktriangledown buttons (remote control) or press **TUNE** and rotate the Master Control Knob (front panel).



Automatic Tuning:

To find the next station, press \blacktriangleleft **SEEK** or **SEEK** \blacktriangleright . To scan and listen to all available stations for a few seconds, press and hold \blacktriangleleft **SEEK** or **SEEK** \blacktriangleright for about a second. The \blacktriangleleft **Sk** or **Sk** \blacktriangleright indicator on the display will change to \blacktriangleleft **Prv** or **Nxt** \blacktriangleright . To stop scanning, press one of the \blacktriangleleft **SEEK** \blacktriangleright buttons to return to Seek mode, or press **TUNE** to tune manually (front panel only). Press **TUNE** a second time to restore the regular functions and display (the TUNE function does not time out).

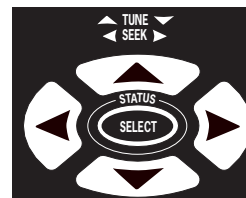

Direct Tuning (remote control only):

A station's frequency can be entered as a four-digit number. For example, to tune into 98.3 FM, press and hold **SELECT** until the display shows "<blank>0.0" in the lower left corner, then press **0, 9, 8, 3**.

Presets:

18 FM and 6 AM stations can be stored. The presets are divided into four banks of six. By repeatedly pressing **FM•AM**, the display will show that you are cycling through FM1, FM2, FM3, and AM. Once you have selected the desired bank, you can store the currently tuned radio station by pressing and holding one of the six preset keys (**1** through **6**) for about a second. You can even do this while scanning for stations. The lower line of the display briefly flashes once the station is stored. To skip a preset, set it to 87.5 FM or 530 AM.

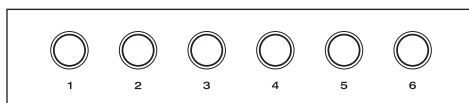

To recall a preset, select the bank that it is in, then press the respective preset key. From the remote control, you can also use the **CH+** and **CH-** keys to run through all FM or AM presets.

ST / HiB / M (front panel only):

If FM reception is weak, switching a station out of stereo can reduce or eliminate unwanted noise. Press **ST / HiB / M** repeatedly to cycle through Stereo, Hi-Blend, or Mono. Hi-Blend offers an alternative to Mono, offering decreased noise without the complete loss of stereo – it decreases hiss and noise by reducing some stereo separation only at higher frequencies. The setting is memorized for each preset.

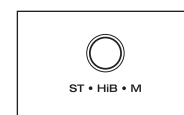

4.4.2 SIMULCAST

Simulcast allows you to select one video source and a different audio source. For example, you could view a sports event on TV while listening to your favorite FM•AM station. Simulcast is available for all paths.

Press and hold the desired video source button for 2 seconds. The display shows "Video Source" and the video source in the top line, and "SELECT AUDIO SOURCE" in the bottom line – while this is on the display, press another source button to select the audio source. When the regular display returns, the source LED indicates the video source, and the display shows the audio source next to a "+". **HDMI audio cannot be used in Simulcast mode.**

To exit from Simulcast mode, press any source button – both the audio and video will switch to this selection.

4. OPERATION continued ...

4.5 VOLUME CONTROL

Front Panel:

MAIN – Adjust using the Master Control Knob. If levels have been calibrated according to setup instructions, set volume to 0 dB for the playback level at which the film was presented in theaters.

ZONE2 or **ZONE3** – Press ZONE2 or ZONE3, then adjust.

HEADPHONE – While in MAIN, press FRONTS twice, then adjust.

Remote Control:

After the appropriate control mode is set, use the **VOL+** and **VOL-** keys.

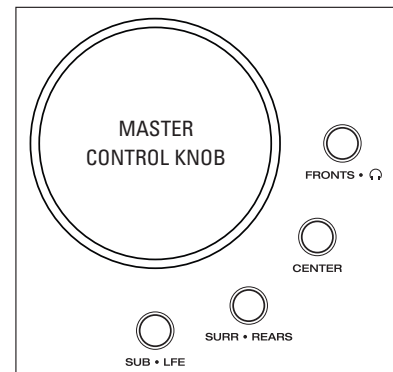

Mute:

When MUTE is pressed, the audio of the selected path is silenced or reduced in level according to the Volumes setup menu. To un-mute, press MUTE again or adjust volume.

Dialog Normalization:

Dolby Digital program material contains non-audio data which the processor uses to adjust playback level, when necessary, so volume variations between movies and programs are eliminated. Without Dialog Normalization, movies not encoded at standardized levels for the dialog could lose dynamic range – higher levels can result in distorted peaks, lower levels can result in quiet sounds disappearing into the noise floor. Dialog Normalization also ensures that Dynamics control (section 4.8.10) works as intended.

If the display reads “Dial Norm Offset -4.0 dB” at the start of a movie, it is indicating that the encoded level is higher than standard by 4.0 dB – the playback level of all channels is then automatically reduced by 4 dB.

4.6 LEVEL TRIM

If a speaker group occasionally sounds too loud or soft, its level can be adjusted on the fly. Settings are memorized according to input format. Adjust using the Master Control Knob or \blacktriangle \blacktriangledown on the remote:

- **Fronts:** Press FRONTS then adjust – this changes left, center, and right.
- **Center:** Press CENTER then adjust.
- **Surrounds:** Press SURREAR•REARS then adjust.
- **Rears:** Press SURREAR•REARS twice then adjust.
- **Subwoofer:** Press SUB•LFE then adjust.
- **LFE:** Press SUB•LFE twice then adjust – this reduces LFE level without affecting bass from other channels. Early DTS material may need LFE reduced to -10 dB.

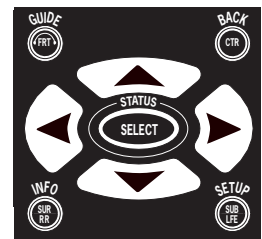

To reset all to 0 dB, see section 3.13.

When listening in stereo with front speakers set to large, the subwoofer must be set to Super in the speaker configuration if you want it to play.

4. OPERATION continued ...

4.7 BASS / TREBLE / BALANCE

To change the Bass, Treble, or Balance of:

- **MAIN – All Speakers Simultaneously:** Press BASS, TREBLE, or BALANCE, then adjust.
- **MAIN – Fronts Only:** Press FRONTS, press BASS, TREBLE, or BALANCE, then adjust.
- **MAIN – Center Only:** Press CENTER, press BASS or TREBLE, then adjust.
- **MAIN – Surrounds Only:** Press SURR•REARS, press BASS, TREBLE, or BALANCE, then adjust.
- **MAIN – Rears Only:** Press SURR•REARS twice, press BASS, TREBLE, or BALANCE, then adjust.
- **ZONE2 or ZONE3:** Press ZONE2 or ZONE3, press BASS, TREBLE, or BALANCE, then adjust.
- **HEADPHONE:** Press FRONTS•🎧 twice, press BASS, TREBLE, or BALANCE, then adjust.

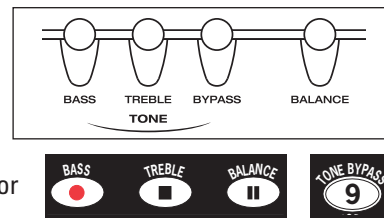

Pressing BYPASS disables the adjustment. Bass/Treble does not apply to sources set to Anlg-Dir.

4.8 SURROUND MODES

A surround mode is signal processing that enhances source material. Surround modes fall in two main categories – those that apply to **stereo** sources and those that apply to **multichannel** sources.

By default, all surround speakers are used except with 1.0-channel sources – after finding your preferences, change presets in the mode presets menu.

Surround modes do not apply to sources set to Anlg-Dir.

With analog input there is no way for a processor to detect whether the source material was encoded.

Stereo Sources:

This includes analog stereo, digital PCM stereo, and Dolby Digital 2.0. Surround modes can be applied to provide up to 7.1 channels of output. They are described later in this section. Each source memorizes its mode setting, so you can, for example, set TV to AnthemLogic-Cinema and CD to AnthemLogic-Music.

Multichannel Sources:

The processor engages decoding according to the format that you select on each DVD.

Once the processor's display shows the format, you can select additional processing described throughout this section. Your selections are memorized by format and by source.

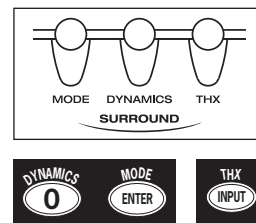

4. OPERATION continued ...

4.8.1 AnthemLogic™



These are proprietary surround modes developed by Anthem that offer outstanding surround performance and can be applied to any 2-channel source:

AnthemLogic-Music™

AnthemLogic-Music™ enhances the stereo listening experience without detracting from the stereo soundstage. Through extensive listening tests a very effective design was developed. This is a minimalist design that uses no echo or reverberation effects which could negatively affect the purity of the sound.

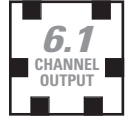

Up to 6.1 channels of output are provided. AnthemLogic-Music™ does not utilize the center channel to ensure that the purity of the stereo music soundstage will in no way be compromised when you're sitting in the "sweet spot" and listening to your favorite stereo recordings.

AnthemLogic-Music™ is very effective in creating an expansive musical soundstage that helps to remove the barrier of the listening room in a non-intrusive and compelling way. This is the factory default 2-channel surround mode for CD, TAPE, and FM•AM.

AnthemLogic-Cinema™

AnthemLogic-Cinema™ provides a large, enveloping and dynamic movie listening experience that makes 2-channel movies sound more like what is experienced in a state-of-the art movie theater. Again through extensive listening tests a very effective design was developed. This is also a minimalist design that avoids the use of echo effects, which could otherwise negatively affect the purity of the sound.



Up to 7.1 channels of output, depending on your speaker configuration. AnthemLogic-Cinema™ provides the missing link that lets you experience full impact home theater sound from any 2-channel stereo analog source such as VCR or TV, or any Dolby Digital 2-channel source, such as DVD or satellite. This is the factory default 2-channel surround mode for all sources except CD, TAPE, and FM•AM.

4.8.2 DOLBY DIGITAL 2.0



Dolby Digital 2.0 soundtracks with surround encoding contain a flag that is normally used to activate Pro Logic IIx Movie mode. The processor can be set to use this flag or to ignore it.

To find out if the Dolby Digital 2.0 material being played has the surround flag, press **MODE**. If flagged, the first line of the display says "DOLBY D 2.0 SUR AUTO" and if not flagged, it says "MODE FOR 2 CH INPUT".

The modes in the next section may be selected separately for flagged and unflagged stereo sources.

Single-channel soundtracks can be encoded two ways – using the center channel or with the same signal into the left/right channels. The mode changes to Mono if the soundtrack uses only the center channel – you can switch it to Mono-Academy or All Channel Mono afterwards.

4. OPERATION continued ...

4.8.3 SURROUND MODES FOR 2.0-CHANNEL SOURCES

Number of output channels is indicated. THX must be Off for all modes to be available. Press **MODE** then use the Master Control Knob or ▲ ▼ (up/down) on the remote control to cycle through selections:

Stereo	No surround mode is applied.
AnthemLogic-Music	6.1 – One of Anthem’s proprietary surround modes, designed to expand the soundstage of stereo music in a very natural way without losing soundstage integrity or image focus. The center channel is not used.
AnthemLogic-Cinema	7.1 – Another proprietary mode from Anthem, designed to provide the impact of a large theater experience from 2-channel movies and TV programs.
Pro Logic IIx Music	7.1 – Can be used with stereo music. Three parameters are adjustable by pressing the MODE button one, two, or three times while in Pro Logic IIx Music and rotating the Master Control Knob or using ▲ ▼ (up/down) on the remote: Center Width is adjustable from 0 to 7. Setting this to 0 places all center sound in the center speaker while 7 places it equally in the left and right channels. Dimension has seven steps of balance adjustment between the surround and center channels. Panorama when “On” extends the front stereo image to include the surround channels. Effective for recordings with strong left or right channel elements.
Pro Logic IIx Movie	7.1 – Dolby Surround decoder for 2-channel movies and TV programs.
Pro Logic IIx Matrix	7.1 – A matrix decoder that does not steer the image from one speaker to another.
Pro Logic IIx Game	7.1 – Bass from surround effects in video games is optimized for visceral impact.
Dolby Pro Logic	4.1 – In case there’s a desire to hear it “as it used to be” (surrounds are mono).
Neo:6 Music	6.1 – Can be used with stereo music. The center image is adjustable by pressing MODE while in Neo:6 Music and rotating the Master Control Knob or using ▲ ▼ (up/down) on the remote: Center Image is adjustable from 0 to 5 – an increase makes the center channel more prominent.
Neo:6 Cinema	6.1 – A matrix decoder that can be used with any matrix-encoded movie. Separation is created by allowing sounds to be placed at different points in the sound field.
All Channel Stereo	7.1 – The left and right channels are also sent to the surround and rear channels, while the center channel and subwoofer receive a combination of both. Some processing is used to retain image clarity. Useful for playing music at parties so it can be heard with equal loudness in all parts of the room.
All Channel Mono	7.1 – Combines the left and right channels and sends the signal to all speakers.
Mono	1.1 – Combines the left and right channels and sends them to the center speaker.
Mono-Academy	1.1 – Gives a presentation closer to the original on movies made from the 1930s to the 1960s, which relied on high-frequency rolloff for sound balance and to mask noise. Also useful with DVDs of TV shows if high-pitched noise leaked from a CRT (cathode ray tube) monitor to the recording during production.

Why can't I select a surround mode when playing a multichannel source?

If you are using less than 7.1 speakers and the speaker configuration menu is set correctly, modes that require more speakers cannot be selected. Except for AnthemLogic-Music, outputs are:

5.1 – L-Front, Center, R-Front, R-Surround, L-Surround, Subwoofer

6.1 – L-Front, Center, R-Front, R-Surround, L-Surround, **Rear***, Subwoofer

7.1 – L-Front, Center, R-Front, R-Surround, L-Surround, **R-Rear, L-Rear**, Subwoofer

* If two rear speakers are used, rear channel information goes to both.

4.8.4 DOLBY DIGITAL

Lossless Dolby TrueHD and various compressed formats including Dolby Digital Plus can be played. The number of input channels ranges up to 7.1.

Dolby Digital EX or Pro Logic IIx can be used to extract rear channels from the surrounds on DVDs encoded in Dolby Digital Surround EX. Dolby Digital EX creates a mono rear signal whereas with Pro Logic IIx the rear channels play a stereo signal. Either of these modes can be applied to any 5.1-channel source.

A list of movies encoded in Dolby Digital Surround EX can be found on the Dolby web site at www.dolby.com and on the THX web site at www.thx.com. A flag to engage Dolby Digital EX or Pro Logic IIx is usually contained in newer titles. Press **MODE** when a movie starts playing and use the Master Control Knob to select the mode that sounds best – the display says “DOLBY D 5.1 INPUT” if the soundtrack is unflagged, and “DOLBY D EX AUTO” if it is flagged.

4.8.5 DTS

Lossless DTS-HD Master Audio and various compressed formats such as DTS-HD High Resolution Audio, DTS 96/24, and DTS-ES can be played. Number of input channels ranges up to 7.1.

There are two ways that a rear channel is carried in DTS-ES:

- **Matrix** – DTS-ES Matrix sources have mono rear channel matrixed in the left and right surround channels. When played, Neo:6 is used to extract it. Neo:6 can be applied to any other 5.1-channel material – when a movie starts playing, press **MODE** and use the Master Control Knob to select.
- **Discrete** – DTS-ES Discrete sources contain 6.1 channels with an independent rear channel in the space that 5.1 channels normally occupy.

Why isn't my processor detecting the sound format that I'm trying to play?

A connection carries **one** format at a time and the processor plays what it gets – make sure the source's digital audio output is set to leave Dolby Digital and DTS unchanged (Bitstream) in its setup menu. You must also select the soundtrack that you want to hear in each disc's audio or language setup before playing the movie, or while the movie is playing by pressing AUDIO on the player's remote control.

4.8.6 THX

THX is an exclusive set of standards and technologies established by the world-renowned film production company Lucasfilm Ltd. THX grew from George Lucas' desire to make your experience of the film soundtrack, both in movie theaters and in your home theater, as faithful as possible to what the director intended. Movie soundtracks are mixed in special theaters called dubbing stages and are designed to be played in movie theaters with similar equipment and conditions. This soundtrack is often transferred to DVD without adjustments for home theater. THX engineers developed patented technologies to accurately translate the sound from the movie theater to the home, restoring proper tonal and spatial balance.

Each THX mode includes a combination of the following:

- **Re-Equalization** – Restores the correct tonal balance for home playback. A film soundtrack may sound bright when played in the home because film soundtracks are designed for large movie theaters where acoustic properties are different. To enable or disable Re-EQ press **THX** twice to display "THX RE-EQUALIZATION" then select On or Off with the Master Control Knob or ▲ ▼ (up/down) on the remote control. **Re-EQ is also applicable when THX is Off** – this can be useful where high-pitched noise leaked from a CRT monitor to the recording during production.
- **Timbre Matching** – The ear changes our perception of sound depending on the direction it's coming from. Movie theatres use an array of surround speakers resulting in surround information from many directions. In the home less surround speakers are used. Timbre Matching, which includes Re-EQ, changes surround information so its tonal characteristic resembles that of the front speakers. This ensures seamless panning between the front and surround speakers.
- **Adaptive Decorrelation** – In a movie theatre, a large number of surround speakers help create an enveloping surround sound experience, but in a home theatre there are usually only two speakers. Unless you are using properly positioned dipoles, surround speakers can sound like headphones that lack spaciousness and envelopment – they will also collapse into the closest speaker as you move away from the middle seating position. Adaptive Decorrelation senses the presence of identical surround channels (mono) and slightly changes one surround channel's time and phase relationship with respect to the other. This expands the listening position and creates – with only two speakers – the same spacious surround experience found in a movie theatre. Adaptive Decorrelation does not operate when the surround channels are different from one another.
- **ASA (Advanced Speaker Array)** – explained in section 3.4.

Summary of THX processing:

Re-EQ de-emphasizes treble. May be turned on or off at any time after pressing **THX** twice.

Timbre Matching matches the sound character of the surround channels to the front channels.

Adaptive Decorrelation restores spaciousness when the source has one surround channel.

ASA provides a wide rear soundstage.

4. OPERATION continued ...

Depending on speaker configuration and input format, THX options are:

- THX Cinema:** When THX Cinema is selected, Dolby Pro Logic IIx Movie is engaged. Alternatively, Dolby Pro Logic or DTS Neo:6 Cinema may be selected. Other surround modes do not apply and do not appear when pressing MODE.
- THX Ultra2 Cinema:** THX Ultra2 Cinema mode plays 5.1-channel movies using 7.1 speakers giving you the best possible THX movie watching experience with 5.1-channel sources. With this mode ASA processing blends the surround speakers and rear speakers providing the optimal mix of ambient and directional surround sounds.
- THX MusicMode:** THX MusicMode is applicable to multichannel music. With this mode THX ASA processing provides a wide stable rear soundstage.
- THX Games Mode:** Game audio is mixed and monitored in a different environment than that of music and movies. The interactive nature of the audio requires a playback system which can provide 360 degree panning while preserving the ambient nature of background sound elements. When playing 5.1-channel games, THX Games Mode may be engaged. Suitable sources are Dolby Digital 5.1 and DTS 5.1 game sources. If THX Games Mode is engaged with 2.0 input, the source is first converted to 5.1 via Pro Logic IIx Game mode.
- THX Surround EX:** THX Surround EX – Dolby Digital Surround EX is a joint development of Dolby Laboratories and the THX division of Lucasfilm Ltd.
- In a movie theater, film soundtracks encoded with Dolby Digital Surround EX are able to reproduce an extra channel added during the mixing of the program. This channel (called Surround Back but named Rear in the processor), places sounds behind the listener. This additional channel provides more detailed imaging behind the listener bringing more depth, spacious ambience, and sound localization.
- Movies created using Dolby Digital Surround EX may exhibit wording to that effect on DVD packaging. A list of movies created using this technology can be found on the Dolby web site at www.dolby.com and list of the DVD titles can be found on the THX web site at www.thx.com.
- Bearing the THX Surround EX logo, the processor will faithfully reproduce this technology in the home when in THX Surround EX mode.
- THX Surround EX can also be used with 5.1-channel sources not encoded with Dolby Digital Surround EX. Rear channel quality will depend on the source.

In accordance with THX, Bass/Treble, Level Trim, and Balance adjustments are **reset to 0 dB** when a THX mode is selected, after which you can make adjustments with THX engaged. When THX is Off, previous settings except Balance are restored. Due to the nature of bitstreams, adjustments made with THX engaged will be reset to 0 dB if the source is paused for longer than 3 seconds.

4. OPERATION continued ...

4.8.7 Mode and THX options for 2.0-channel sources

Select using Master Control Knob or ▲ ▼ keys on remote control. To make all modes available, turn THX off.

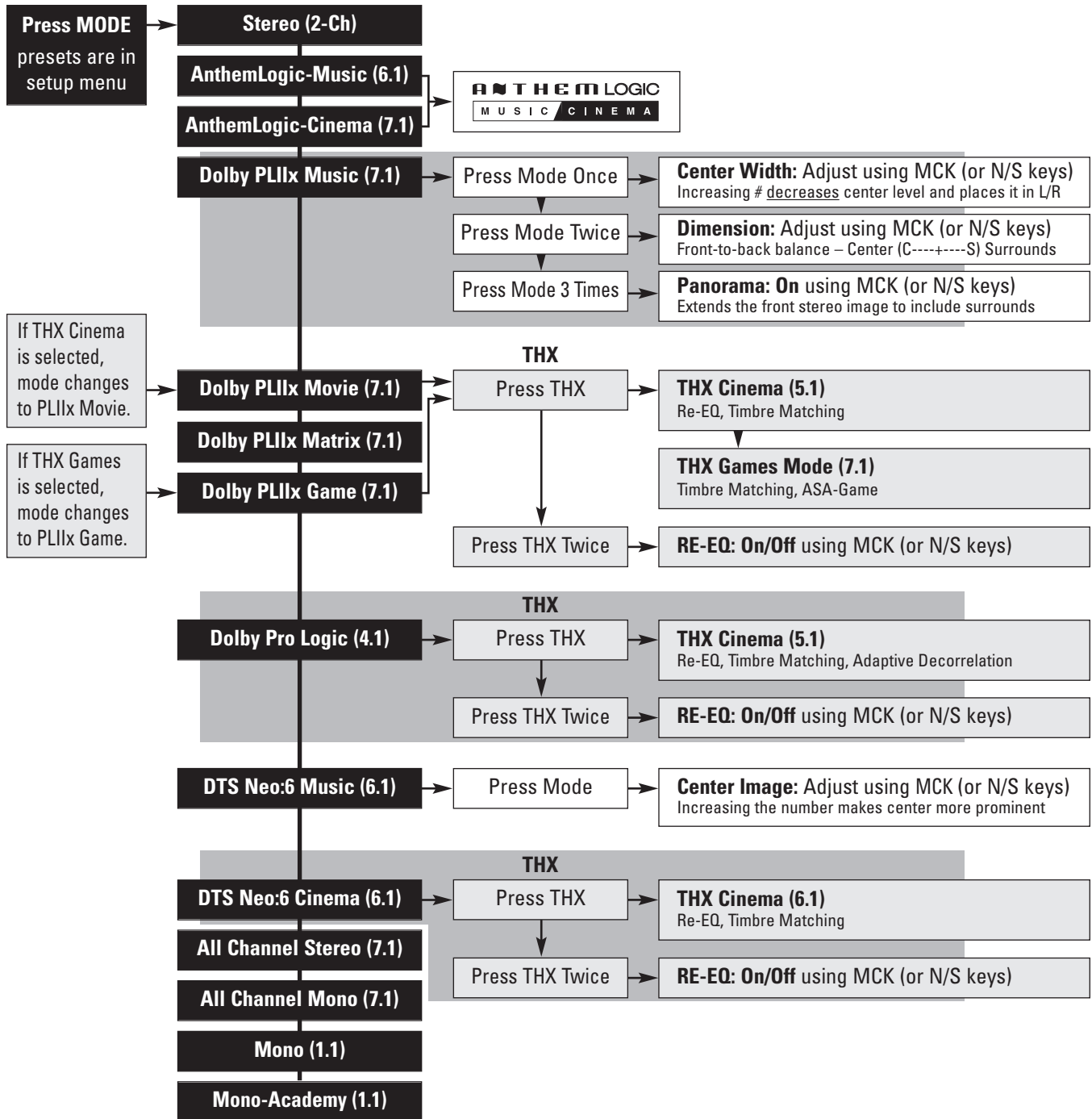

Selections are memorized separately for Dolby Digital Surround 2.0-flagged vs unflagged sources. Mono, All Channel Mono, and Mono-Academy are the options for Dolby Digital 1.0-channel sources.

4. OPERATION continued ...

4.8.8 Mode and THX options for 5.1-channel Dolby sources and 6-Ch S/E

Select using Master Control Knob or ▲ ▼ keys on remote control. To make all modes available, turn THX off.

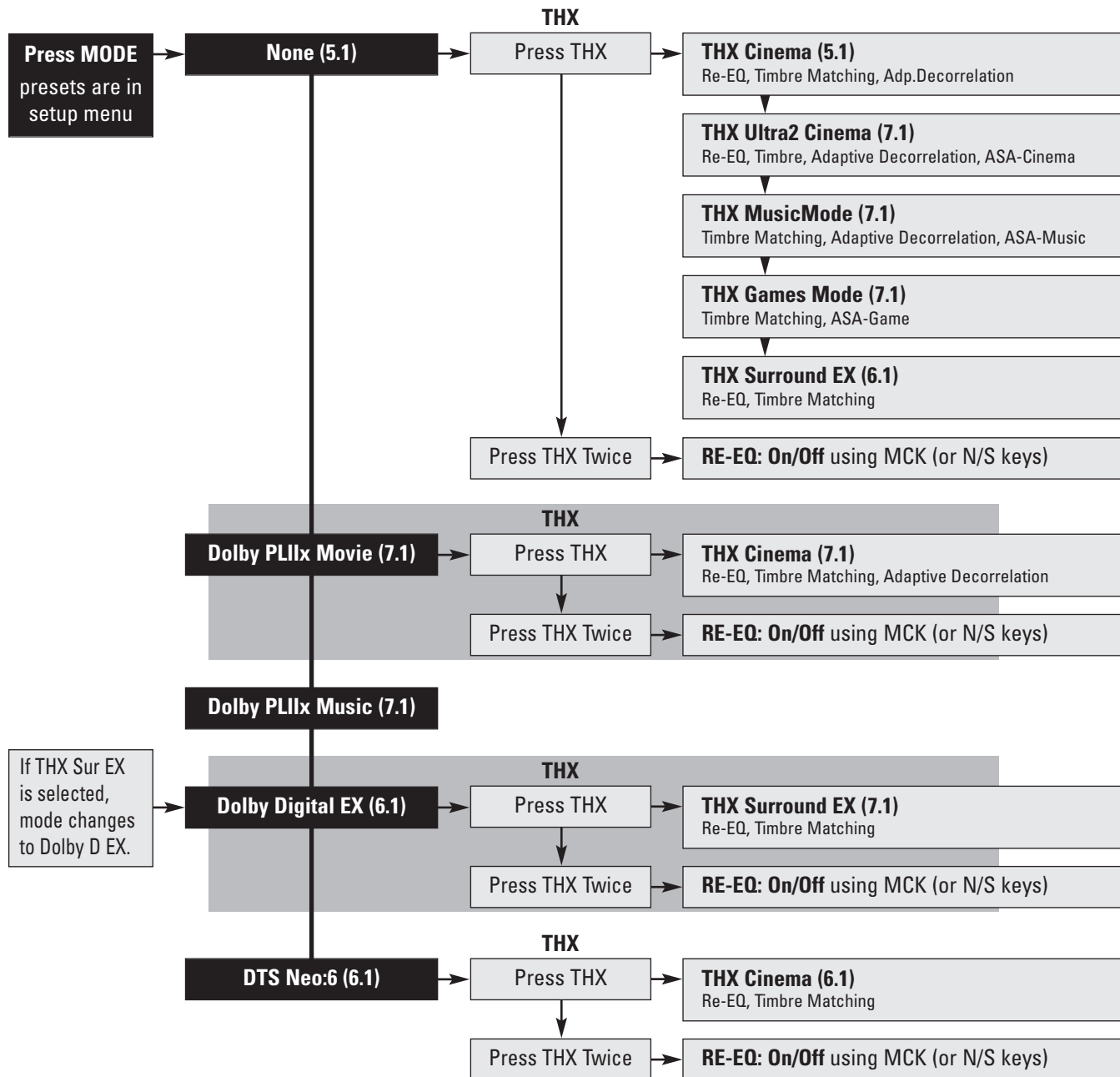

Selections are memorized separately for Dolby Digital Surround EX-flagged vs unflagged material. THX Cinema is the only option for 7.1-channel Dolby TrueHD (Re-EQ, Timbre Matching).

4. OPERATION continued ...

4.8.9 Mode and THX options for 5.1-channel DTS sources

Select using Master Control Knob or ▲ ▼ keys on remote control. To make all modes available, turn THX off.

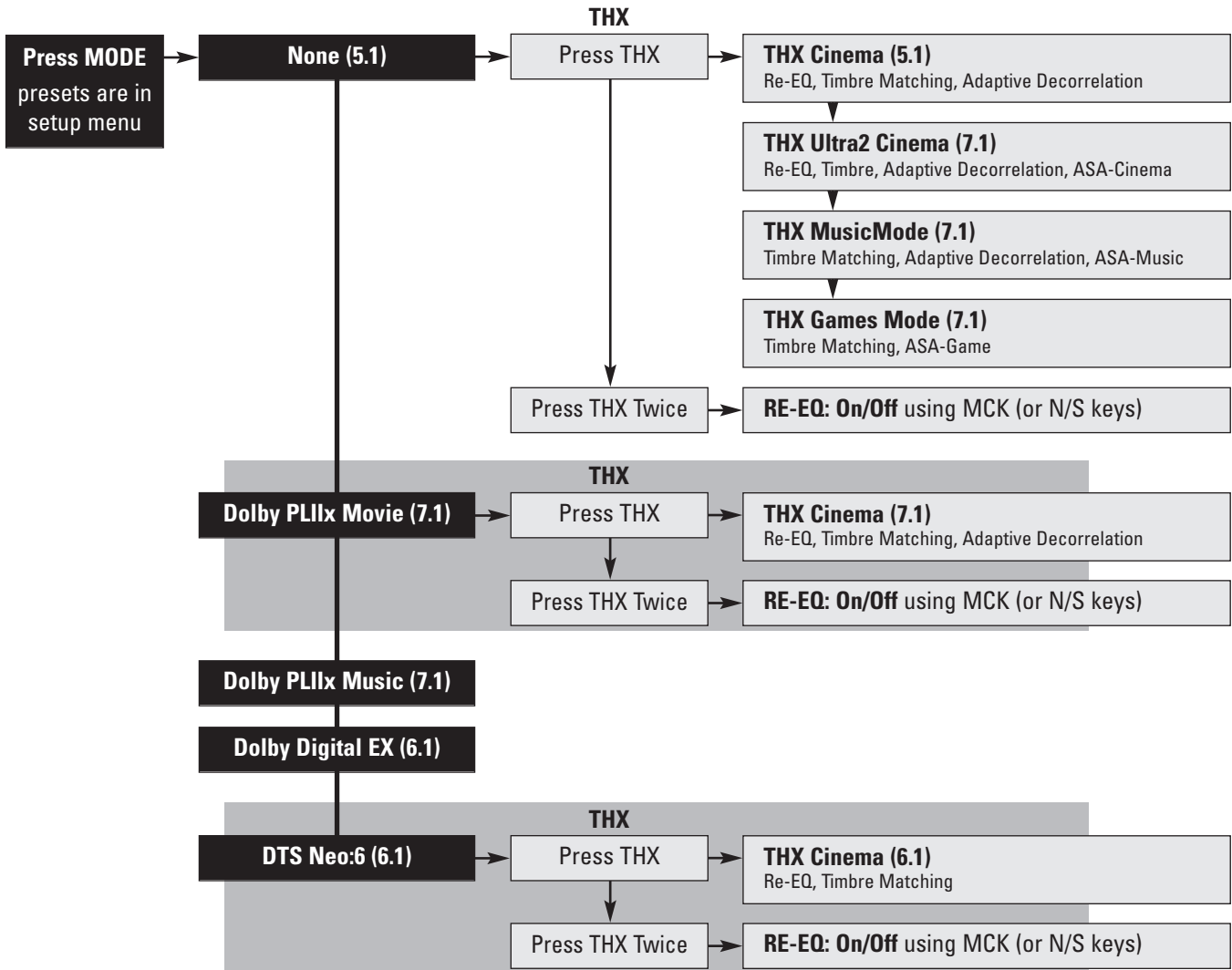

Selections are memorized separately for DTS vs DTS-ES Matrix. THX Cinema is the only option for 6.1- and 7.1-channel sources (Re-EQ, Timbre Matching).

4. OPERATION continued ...

4.8.10 DYNAMICS

This allows you to control the difference between the softest and loudest passages on multichannel soundtracks, as long as the soundtrack contains dynamic scaling information and at least 5.1 speakers are used. Press **DYNAMICS** and use the Master Control Knob or ▲ ▼ keys on the remote control to select:

Reduced: Allows the quieter parts to be heard more easily, and works by raising the level of quieter sounds and/or reducing the level of louder ones according to cues encoded on the DVD.

Late Night: Further reduces the softest-to-loudest difference.

Reduced and Late Night get reset to Normal when Main power is turned off.

4.9 LIP-SYNC DELAY (remote control only)

To adjust lip-sync while playing a video source instead of viewing the setup menu, press and hold the **DISPLAY** key until the display shows "LIP-SYNC DELAY", then use the ◀ ▶ keys to move from digit to digit and the ▲ ▼ keys to adjust.



4.10 DISPLAY BRIGHTNESS (front panel only)

To change the brightness of the front panel display and LED indicators, press **DISPLAY** and use the Master Control Knob to select Maximum, High, Medium, Low, or Off.

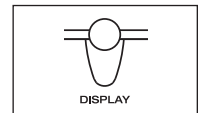

4. OPERATION continued ...

4.11 VIDEO SOURCE ADJUSTMENT

ANTHEM HD
BROADCAST QUALITY SCALER

VXP
BY SIGMA

Sources sometimes contain anomalies. HD inputs may have the wrong color space, while S-Video and component video signals may need adjustment before being converted to digital, for HDMI output. The processor allows **separate adjustment for each source**.

Anthem's video processor allows **separate adjustment for each source**. Adjust **after** setting up menu 1 and your display. Upon entering the Video Processing Menu, the on-screen display appears together with the video source so that you can see changes to the picture as you make them in the menu.

The outcome of the settings in the Video Processing Menu depends on settings in your source components, **so set them up first**, for example, set your DVD player's output to 16:9.

HOW TO ENTER THE VIDEO PROCESSING MENU

For three seconds, press and hold ON SCREEN (7) on the remote or DISPLAY on the front panel. The menu is displayed from MAIN outputs according to section 3.



HOW TO NAVIGATE IN THE VIDEO PROCESSING MENU

- Use the ◀ ▶ and ▲ ▼ keys to select an item.
- Press **SELECT** to change a setting. Items with a right arrow ▶ lead to further selections once SELECT is pressed.
- Press **BACK** to return to previous item.

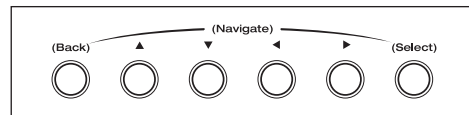
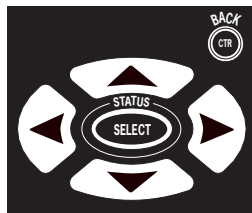

MAKING ADJUSTMENTS WHEN A SLIDER IS DISPLAYED



Use the ◀ ▶ keys. Use ▲ ▼ to go to the next slider if the menu has more than one.

HOW TO EXIT FROM THE VIDEO PROCESSING MENU

Press **BACK** as many times as necessary. Each time BACK is pressed the previous item or menu returns. The menu will exit if not used for 5 minutes to prevent a burned-in on-screen image.

PICTURE

The Picture menu provides video adjustments for each source. **Do not make adjustments in this menu if your display has not been calibrated** – see the Test Patterns section and return after calibrating your display.

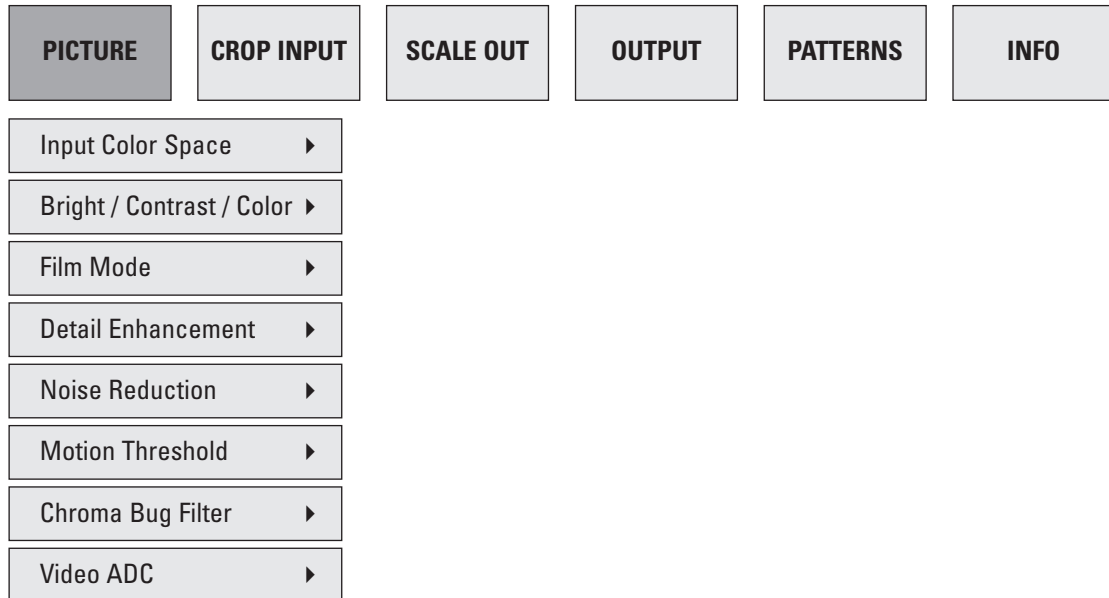

Input Color Space

For YCbCr input, the default is Auto, which switches between HD and SD color space according to whether input has HD or SD resolution. In case the source contains the wrong color space for its resolution, for example, a cable box that converts 480i channels to 1080i output without converting SD color space to HD causing some unnatural hues, the color space can be corrected by forcing the setting to SD or HD.

If the source is in RGB format instead of YCbCr, choose between Studio and Extended – detail in dark scenes can be used to find the correct setting. The default is Studio.

Brightness / Contrast / Color / Tint

If a source needs Brightness (black level), Contrast (white level), Color (saturation), or Tint (hue) adjustment, you can do it here. The default for each of these is 50. If the source component puts out RGB and output in menu1 is set to RGB, Color and Tint are not adjustable so that unnecessary color space conversion is avoided. If you need to adjust the image in such a case, set the source component to YCbCr output.

Film Mode

Did the source originate from film or from video? If from a video camera, which type? If it's a film source on TV, was a regular pattern of fields deleted to change the playing speed? Is it animation, and if so, according to which animation spec? Is it a mix of sources edited together? Are video characters being scrolled across a film source?

For a video processor to provide best image quality, it must detect the source's cadence, or pattern of field sequence, and deconstruct it accordingly. The Sigma Designs VXP processor can not only do that, it can do so even when the input is high-definition. Film Mode can be overridden by changing the setting from Auto to Off, but don't do it unless you need to.

4. OPERATION continued ...

Detail Enhancement

Digital processing is used to do what the name implies – experiment with the level adjustment and leave it where the picture looks best. The factory default is 0.

Noise Reduction

By treating parts of the picture selectively to avoid a soft overall image, this reduces or removes “block” and “mosquito” artifacts that appear in overcompressed video sources – adjust if necessary (default for each adjustment is 0). Block noise is characterized by square blocks momentarily blurring motion whereas mosquito noise is random-looking distortion near edges of objects in the picture. These artifacts are more likely to appear in digital broadcasts than with disc sources.

Motion Threshold

A high-quality deinterlacer has to treat the areas of the picture that contain motion differently from the areas that have very little or no motion. The motion threshold is the point where one type of deinterlacing changes to another. The factory default (4) should work best but adjustment is provided in case it's needed.

Chroma Bug Filter

A decode error in some older digital video sources appears as horizontal streaks over areas that are rich in color, especially red areas in cartoons and graphics. Turn correction On if you see such an artifact, but don't spend energy looking for it – your DVD player, depending on model, may have it taken care of.

Video ADC

S-Video and component video signals containing anomalies may need adjustment before being converted to digital. Video Input Gain (default: Auto) changes the white level and Video Input Offset (default: 50) changes the black level. Sampling Phase adjustment (default: 15) can be useful when video comes from a video DAC (e.g. computer video card) containing ringing edges due to improper filtering – adjust for minimal “ghost” imaging while using a static black and white picture with lots of detail and sharp edges.

For S-Video inputs, two more adjustments are available. Chroma Transient Improvement Level can fix blurred edges where two colors meet. Luma Digital Noise Reduction Level suppresses spikes in the signal which are usually noise. The default for both is 0 – experiment and leave where the picture looks best.

4. OPERATION continued ...

CROP INPUT

The Crop Input menu is where the image's frame is set. If there's anything outside of the image that you want to remove, this is the best place to do it, i.e. before the image is scaled, preventing unnecessary artifacts.

PICTURE	CROP INPUT	SCALE OUT	OUTPUT	PATTERNS	INFO
Auto Detect					
16:9					
4:3					
Custom Setting ▶					
Trim Edges: Off					
Trim Edges: On ▶					

Input Aspect Ratio – Auto Detect, 16:9, 4:3

The default is Auto Detect. In this mode, a 4:3 input frame is assumed if the input is standard definition (480 or 576 lines), and a 16:9 input frame is assumed if the input is high definition (720p and higher). If a forced setting is needed, select the one that displays the picture correctly – most often, this means selecting 16:9 when the source is standard-definition letterboxed. The most common aspect ratios are:

1.33:1 (4:3) SDTV, classic movies movies also 1.37:1	1.78:1 (16:9) HDTV, widescreen movies movies also 1.66:1, 1.85:1	2.4:1 "Scope" movies, anamorphic projection also 2.20:1, 2.35:1, 2.55:1 and beyond
---	---	---

Custom

If the above settings aren't suitable, select Custom and adjust Horizontal Size, Vertical Size, Horizontal Position, and Vertical Position. **If using an anamorphic projection lens, set Vertical Size to 810** (even if output resolution in menu 1 isn't 1920x1080 – the relationship is maintained to make setup easy).

Since position can be adjusted after size is adjusted, this can also be the right choice for off-center sources but in this case be sure to adjust size proportionally – you can use a geometry test pattern for a visual adjustment, or calculate the numbers by maintaining the 16:9 ratio between Horizontal Size (default 1920) and Vertical size (default 1080). If the input is standard-definition and letterboxed, use 64:27 to calculate the correct setting for a 16:9 screen. Horizontal and Vertical position defaults are 960 and 540, respectively.

Trim Edges

This selection is independent of the preceding ones. When "On" is selected, the edges of the input are trimmed. Use if you see "garbage" on the edges of the image or for removing the small amount of letterboxing that results from displaying movies with a 1.85:1 aspect ratio on a 16:9 (or 1.78:1) screen when the display is not overscanning. Number of pixels removed is adjustable from 0 to 20.

SCALE OUTPUT

The Scale Output menu provides options for making non-16:9 inputs fit on a 16:9 screen.

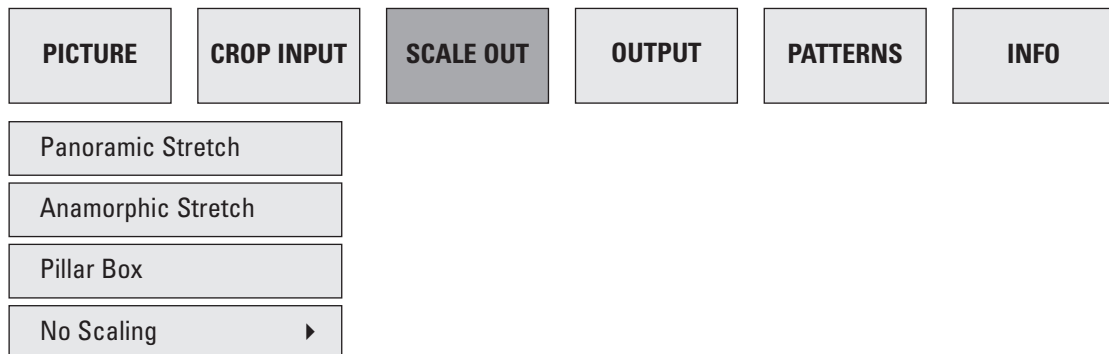

Panoramic Stretch

Fills the screen by stretching only the sides of the picture while the middle portion stays undistorted. Use with 4:3 input if you don't like seeing empty sides on a 16:9 screen.

Anamorphic Stretch

Fills the screen by stretching the picture sideways. Use this setting for standard-def DVDs that are anamorphic or "enhanced for widescreen TVs" – the image on these DVDs is squeezed sideways so that no vertical resolution is wasted on a letterbox, and made normal upon playback assuming that the DVD player is properly set (16:9 output). Also use this setting with anamorphic projection and Custom input cropping.

Pillar Box

With this setting, original aspect ratio is preserved for standard-def input, leaving the sides of the screen empty. The shade of the empty areas can be adjusted in menu 1. Not applicable when input is 720p or higher.

No Scaling

To quickly check what the source component is putting out in unscaled form, select No Scaling then make the appropriate selection above. Horizontal Size and Vertical Size adjustments close in on the outside of the image, and if they're changed from the factory defaults (100), Horizontal Position and Vertical Position become adjustable.

If the source and the display have the same resolution then No Scaling also allows trimming the edges of an input without enlarging it to compensate for the empty area. For example, if you're using a 1080p-native display and a 1080i source needs trimming, use Trim Edges: On in the Crop Input menu (minimum 2 pixels) and select No Scaling. The result is 1:1 pixel mapping for the remaining image.

Since a disc's menu and the main title do not always have the same aspect ratio, select scaling according to the main title.

4. OPERATION continued ...

Aspect Ratio Control Examples – how to crop and scale various sources for display on 16:9 and 2.4:1 screens:

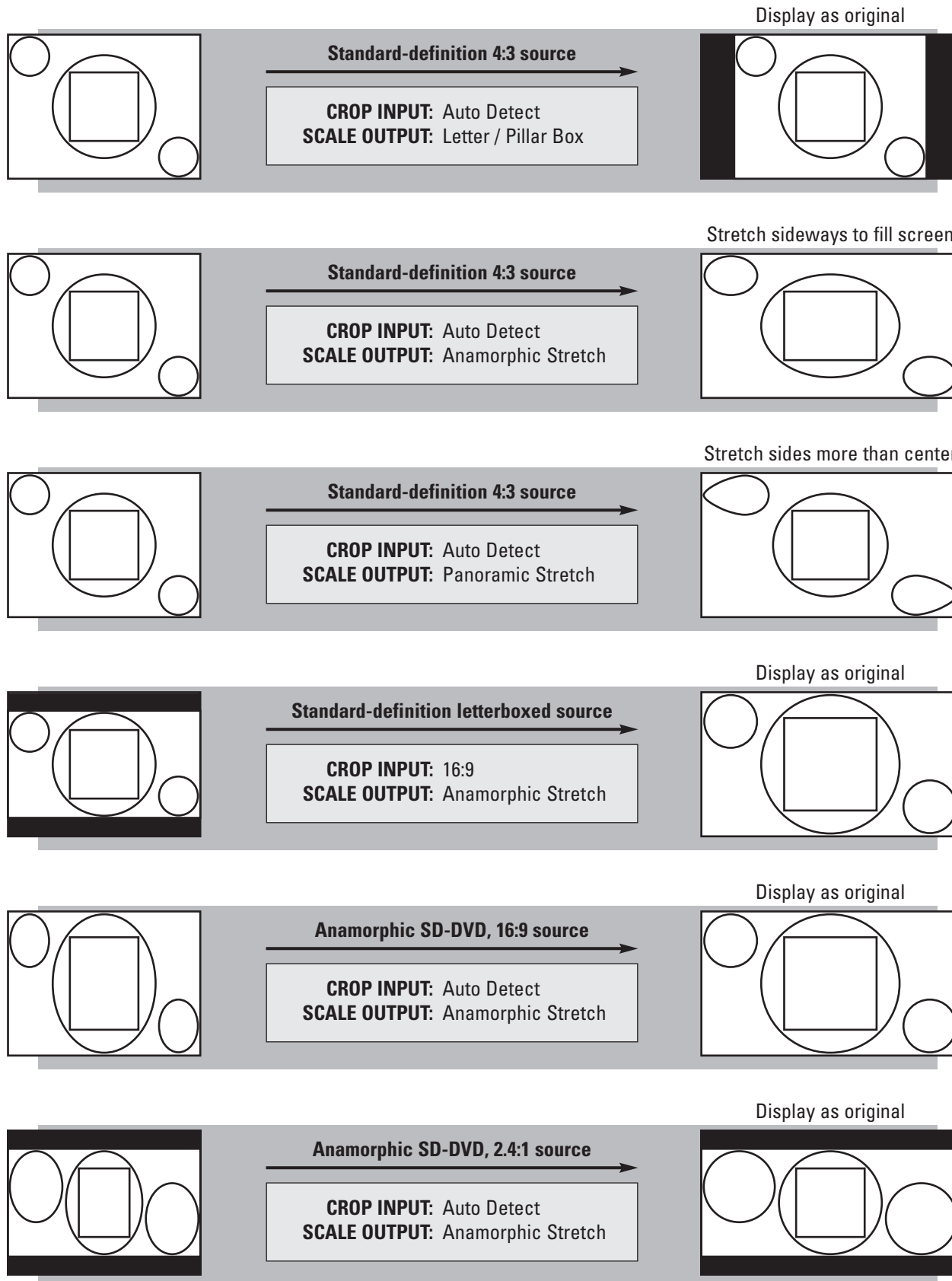

4. OPERATION continued ...

Aspect Ratio Control Examples continued

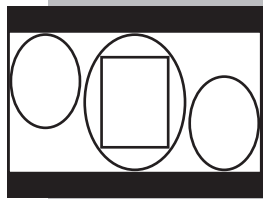

Anamorphic SD-DVD, 2.4:1 source

CROP INPUT: Custom, adjust to taste
SCALE OUTPUT: Anamorphic Stretch

Crop and/or stretch to fill screen

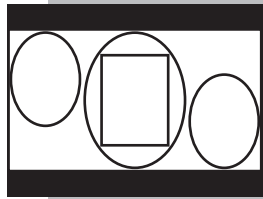
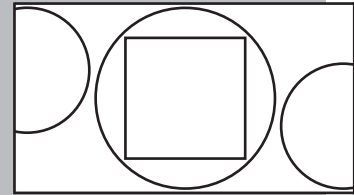

Anamorphic SD-DVD, 2.4:1 source

CROP INPUT: Custom, Vertical Size 810
SCALE OUTPUT: Anamorphic Stretch

Display as original using anamorphic lens

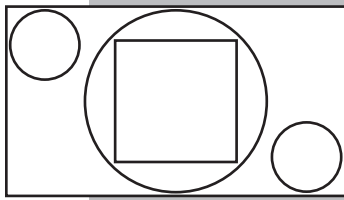
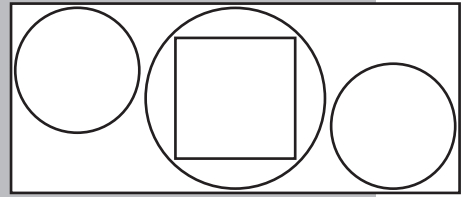

Hi-definition 16:9 source

CROP INPUT: Auto Detect
SCALE OUTPUT: Anamorphic Stretch

Display as original

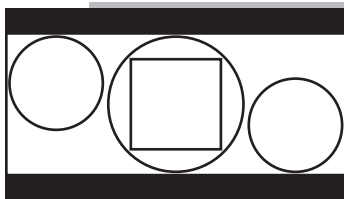
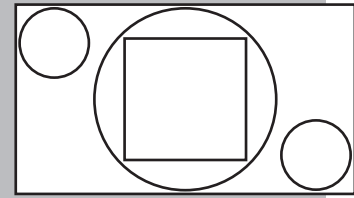

Hi-definition 2.4:1 source

CROP INPUT: Auto Detect
SCALE OUTPUT: Anamorphic Stretch

Display as original

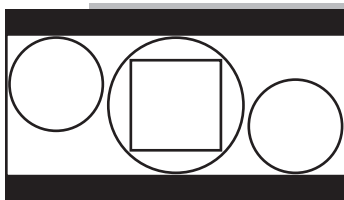
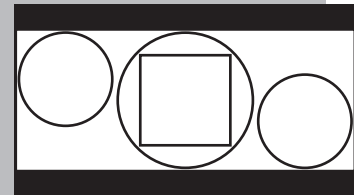

Hi-definition 2.4:1 source

CROP INPUT: Custom, adjust to taste
SCALE OUTPUT: Anamorphic Stretch

Crop and/or stretch to fill screen

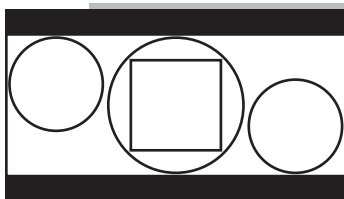
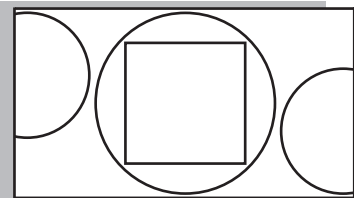

Hi-definition 2.4:1 source

CROP INPUT: Custom, Vertical Size 810
SCALE OUTPUT: Anamorphic Stretch

Display as original using anamorphic lens

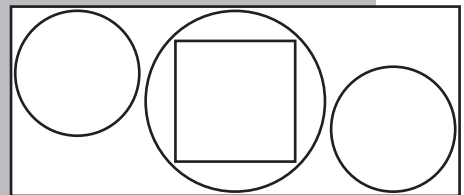

4. OPERATION continued ...

OUTPUT

The Output menu is used to select gamma correction and to turn frame lock on/off.

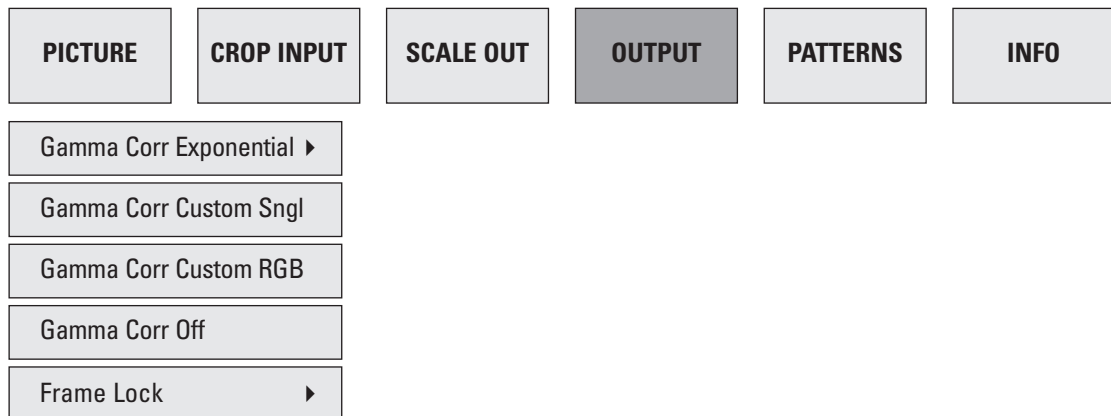

Gamma Correction (normally for use only by calibration specialists)

The default is Off. Curves other than exponential (default 100) are created with a computer – see section 3.1.

Frame Lock

The default is Off. Frame Lock is useful with video games by cutting processing time. When Auto is selected, buffering is disabled and the processor's output synchronizes with the source.

If your display accepts various refresh rates and your disc player has passthrough mode, you can also use Frame Lock to match refresh rate to the source material (24 Hz / 50 Hz / 60 Hz), overriding the refresh rate selected in menu 1. Engaging Frame Lock increases source switching time, therefore it should not be used if not needed – assigning different video output configurations in menu 1 is more effective in this case.

“Auto” means that if the source has a nature that prevents Frame Lock from engaging, it will not engage.

4. OPERATION continued ...

TEST PATTERNS

This section is a primer on display calibration and although the procedure is no match for a professional setup, the result will almost always be better than using the display with its factory settings. The only tool needed to adjust color this way is a blue filter that comes with test discs or the glasses from www.thx.com.

These digitally generated patterns can be more accurate than those played from a disc since some discs and players contain errors in design or user settings.

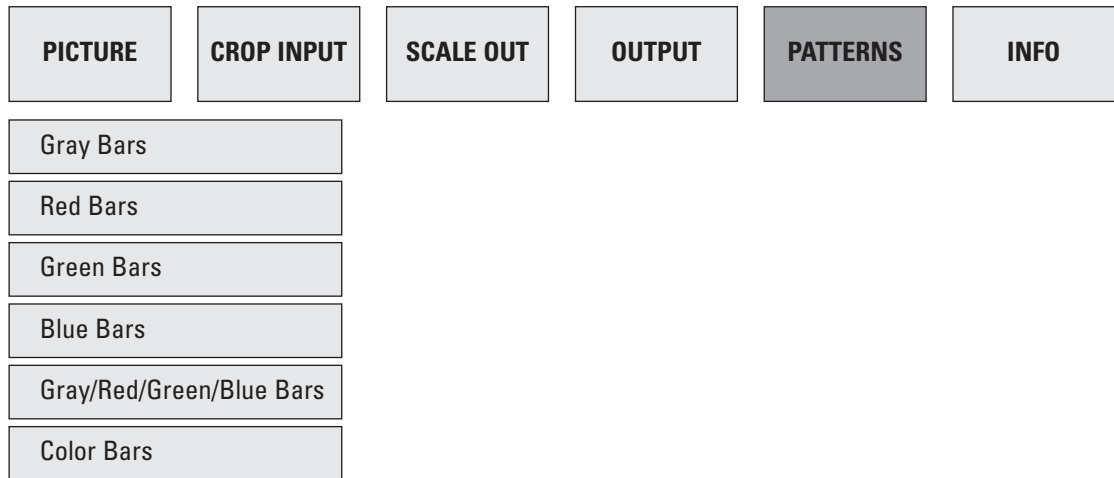

Before starting calibration

Set the room's lighting to the level that will be used during normal viewing. If your display varies light output according to the brightness of the image and/or ambient light, turn off these functions for now. If color temperature is selectable, select "medium" or the one that is neither too blue nor too red. If your display has DVI input, ensure that the correct output between Studio and Extended RGB is selected in menu 1.

The best setting for the display's sharpness control is usually at its lowest even when the default position is in the center. Sharpness is the addition of false edges around objects in the image and there is no reason to add false edges on all video sources unless there is something wrong with all video sources.

Any of these patterns can also be used to check whether the display is showing the whole image – if the bars at the left and right of the screen are narrower than the rest, your display is cropping and rescaling the image. As mentioned in section 3.1, see if you can disable this (select dot-by-dot mode in your display).

This is the gray 20-bar pattern – the red, green, blue, and gray/red/green/blue ones are similar:

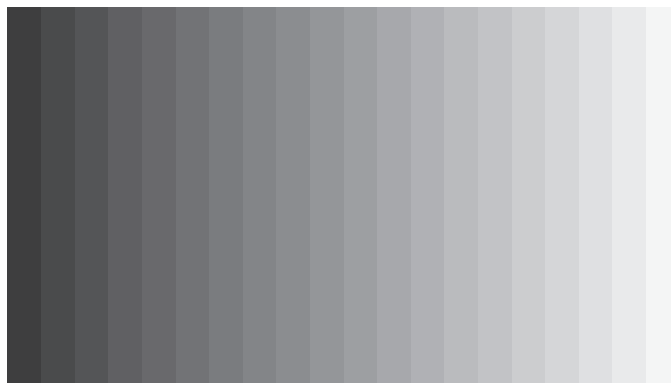

Black level is one step below the pattern's darkest bar and full level is one step beyond the brightest bar.

4. OPERATION continued ...

Color Bars is the SMPTE test pattern, with bars at 75% saturation:

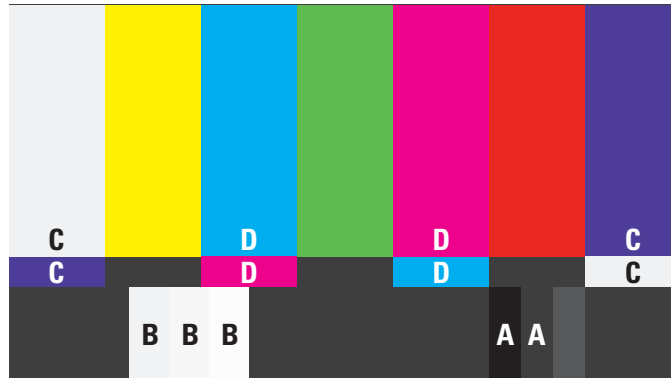

Setting your display's brightness and contrast

Increase brightness (black level) so that areas **A** can be seen as two areas with different brightness, then reduce the level until these areas match each other, or in other words, when the A on the left disappears by blending into the background. (Difference in shade will not appear if output in menu 1 is Extended RGB.)

After setting brightness, set contrast (white level) as high as possible so that areas **B** remain three areas with different and equally-spaced brightness. If the B in the middle starts to get closer in brightness to the B on the right, the contrast setting is too high for most lighting conditions.

Next, select the gray/red/green/blue bars pattern and if the rightmost bars in any of the colored areas are blended, reduce contrast until the areas can be seen separately. Depending on your display and/or lighting conditions, compromises in the settings may be necessary – try some sources with and without the display's automatic brightness compensation (where applicable) and trust your senses.

Setting your display's color and tint

Looking through the blue filter or glasses, adjust color (saturation) so that areas **C** match as closely as possible, then adjust tint (hue) so that areas **D** match as closely as possible.

After setting contrast and tint, check brightness and color – some fine tuning back and forth may be needed. Once again, trust your senses if the blue filter does not provide satisfactory results.

INFO

The Info panel shows Input Status (Video Source, Signal Type, Audio Source, and Film Mode) and Output Status (Signal Type, Frame Rate, Line Rate, and Frame Lock).

Shortcuts and emergency exits: Commonly adjusted settings and settings that make displays say “no signal” when the wrong selection is made can be accessed without entering menus. Press and hold **MODE** until “SCALE OUTPUT” is displayed, then select using the Master Control Knob or the ▲ ▼ keys on the remote control. Repeatedly pressing MODE before timeout cycles through Video Output Configuration, Frame Lock, and Gamma Correction.

If you have lost video output by changing settings, use the front panel display to correct the settings.

To quickly access Brightness, Contrast, Color, and Tint press and hold **DYNAMICS** until the Brightness slider appears, then use the ▲ ▼ keys to change slider and the ◀ ▶ keys to adjust.

4. OPERATION continued ...

4.12 SLEEP TIMER (remote control only)

If you would like to go sleep while listening to a program or music, the Sleep Timer will turn the processor power off after the selected amount of time:



- Select the desired path (MAIN, ZONE2, or ZONE3), then press **SLEEP** (the Sleep timer will operate for that path only).
- The first **SLEEP** keystroke always resets the timer to 30 minutes. Additional keystrokes then cycle as follows: Second=60, third=90, fourth=Disabled.
- Once set, the time remaining appears as the number following "Zzz" in the display.

4.13 ENABLE / DISABLE TIMERS (remote control only)

To enable or disable all timers without entering the Setup, press and hold the **SLEEP** key until the display shows "ALL TIMERS", then use the ▲ ▼ keys to enable/disable.

4.14 STATUS DISPLAY

Press, Release, Press to cycle through display screens that show the following:

- **Software version, day, and time.**
- **Video Input:** Resolution and refresh rate of video source, and copy protection status if available – "CP" means copy-protected, "NP" means not protected.
- **Audio Input:** Format, sample rate of lossless digital audio source or bit rate of lossy-compressed digital audio source, copy protection status for HDMI input.
- **Audio Input Format:** Source channels.
- **Copy Protection:** Displayed when outputs are restricted along with the type of restriction.
- **Video Output Configuration:** The active one and its resolution/refresh rate.
- **Audio Output:** Bit rate / sample rate running in the digital to analog converters.
- **Audio Output Format:** Channels producing output.
- **Dialog Normalization:** Displayed if not equal to 0 dB.
- **Tone Controls:** Enabled, Bypassed, or N/A.
- **Serial Number:** If the number on the rear panel does not match, contact Anthem immediately.

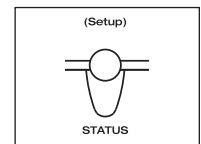

When in ZONE2 or ZONE3, information relating only to the selected path is displayed.

5. REMOTE CONTROL CUSTOMIZATION

5.1 CODES FOR OTHER BRANDS

The processor remote can control other components – brands and setup instructions are in Appendix B. If the brand for your component is not listed, try searching for a code:

1. Turn on the component, for example the DVD player.
2. Press a **control mode** key other than MAIN, Z2, or Z3, for example **DVD**.
3. Press and hold **LEARN** until the LED flashes twice then press **9, 9, 1**.
4. Press **0** for cable converters, satellite receivers, or video accessories, **1** for TVs, **2** for DVD players or VCRs, or **3** for CD players or audio amps/tuners.
5. Aim the remote towards the player and press **POWER** (or Play). If the player does not respond, press **CH+** to try the next code. If the player responds, press **LEARN** to lock the code. Codes are sent in order of popularity. CH– goes to the previous code. **If no code is found, see section 5.2.**
6. After finding a code, record it: Press and hold **LEARN** until the LED flashes twice, then press **9, 9, 0, 1**. Wait 3 seconds and count the number times that the LED flashes. This represents the first digit (for example, 3 flashes = 3, no flash = 0) – write this down. Next, press **2** for the second digit, **3** for the third digit, **4** for the fourth digit, **5** for the fifth digit and write the number of flashes each time.

5.2 LEARNING COMMANDS

Commands from other infra-red remote controls can be captured by the processor remote control. The factory command is still available by pressing LEARN before pressing the taught key.

If the factory command is used more than the learned command, the learned command can be programmed in Layer2 instead. In this case, the learned command is sent by pressing LEARN before pressing the key.

Before teaching a key note the following:

- Control mode keys and LEARN can not be taught. These keys never send IR commands.
- A multiple key sequence (for example Rec+Pause or Rec+Play) can not be taught to one key.
- A high level of ambient light, light from displays, and exposed fans could interfere with learning.

To teach a key:

1. Point the source and processor remotes at each other, holding them 2 inches apart.
2. Press and hold **LEARN** until the LED flashes twice then press **9, 7, 5**. One long blink indicates low battery or faulty memory – the remote will not go into learn mode under these conditions.
3. Press the desired **control mode** key.
4. Press the **key to be taught**, or to program the command into Layer2 press **LEARN** (don't hold) then press the **key to be taught**.
5. The LED flashes rapidly. Within 4 seconds, press and hold the **teaching key on the source remote** until the LED flashes twice. One long blink means bad capture (try again), memory full (delete another command), or unlearnable code.
6. Repeat steps 3-5 or 4-5 as often as desired until memory is full.
7. To exit, press and hold **LEARN** until the LED flashes twice or wait 10 seconds.

Deleting learned commands:

1. Press and hold **LEARN** until the LED flashes twice, then press **9, 7, 6**.
2. To delete a learned command from one key, press the **control mode** key, then the **key to be deleted** twice. To delete all learned commands in the control mode, press the **control mode** key twice.

5. REMOTE CONTROL CUSTOMIZATION continued ...

5.3 COPYING COMMANDS

The command from one key can be copied to another key (not applicable to Power, Record, and Learn keys).

To copy a command to another key in the same control mode:

1. Press the **control mode** key.
2. Press and hold **LEARN** until the LED flashes twice.
3. Press **9, 9, 4**.
4. Press the **key to be copied**.
5. Press the **new key** that will have the command. The LED flashes twice.

To copy a command into a different control mode:

1. Press and hold **LEARN** until the LED flashes twice.
2. Press **9, 9, 4**.
3. Press the **control mode** key of the key to be copied then the **key to be copied**.
4. Press the **new control mode** key then the **new key** that will have the command. The LED flashes twice.

To set the original functions:

1. Press the **control mode** key.
2. Press and hold **LEARN** until the LED flashes twice.
3. Press **9, 9, 4**.
4. Press the **control mode** key twice.

5.4 VOLUME LOCK

With Volume Lock engaged, the volume and mute keys control the processor regardless of control mode, making operation more convenient.

To engage Volume Lock for MAIN:

1. Press and hold **LEARN** until the LED flashes twice.
2. Press **9, 9, 3**.
3. Press **MAIN**.

To disengage Volume Lock for ZONE2 (or ZONE3), and re-engage the ZONE2 (or ZONE3) volume control:

1. Press **ZONE2** (or **ZONE3**).
2. Press and hold **LEARN** until the LED flashes twice.
3. Press **9, 9, 3**.
4. Press **VOL-**.

The volume and mute keys now control MAIN for every control mode selection except ZONE2. You may continue to disengage other control modes one at a time. To disengage all, press **VOL+** in step 4.

5. REMOTE CONTROL CUSTOMIZATION continued ...

5.5 PROGRAMMING MACROS

Macros are used to execute multiple functions with one key press, such as powering the processor, cable box, and display On at the same time. Up to 32 commands can be programmed.

Programming a Macro that works regardless of control mode setting:

1. Press and hold **LEARN** until the LED flashes twice.
2. Press **9, 9, 5**.
3. Press the key you want to use to activate your macro (e.g. Power).
4. Enter the command sequence that you want the macro to execute.
5. To exit, press and hold **LEARN** until the LED flashes twice or wait 10 seconds.

To clear the macro, repeat the steps above but skip step 4.

Programming a Macro that works in one control mode:

1. Press the control mode key.
2. Press and hold **LEARN** until the LED flashes twice.
3. Press **9, 7, 8**.
4. Press the key you want to use to activate your macro (e.g. Power).
5. Enter the command sequence that you want the macro to execute.
6. To exit, press and hold **LEARN** until the LED flashes twice or wait 10 seconds.

To clear the macro:

1. Press and hold **LEARN** until the LED flashes twice, then release.
2. Press **9, 7, 8**.
3. Press the control mode key where you programmed the macro.
4. Press the key that was programmed to activate the macro.
5. To exit, press and hold **LEARN** until the LED flashes twice or wait 10 seconds.

5.6 RESETTING THE REMOTE CONTROL

To erase user memory, press and hold **LEARN** until the LED flashes twice, then press **9, 8, 0**. To reset MAIN, Z2, or Z3 control mode, see the beginning of Appendix B.

If your remote control has stopped working, try resetting it before contacting technical support.

6. SOFTWARE UPDATING

The operational characteristics of the processor are controlled by software installed through the RS-232 port on the rear panel. Updates can be downloaded from our web site and installed afterwards.

6.1 SOFTWARE VERSION IDENTIFICATION

To find out which software version is in your processor, press **STATUS** and the display will show it. The latest software and manual are available from our web site. A list of changes comes with the download.

6.2 SOFTWARE UPDATING VIA YOUR DEALER

If you do not have a computer or wish to do software updates yourself but still want to have them done, please make arrangements with your dealer. Whether your dealer comes to your theater to do the update or you bring your processor to the dealer, the dealer may charge for this service.

6.3 SOFTWARE UPDATING VIA YOUR COMPUTER

For computer and connection requirements, see section 3.15.

Software installation:

1. Find out which version is installed by pressing **STATUS**.
2. Go Anthem's web site www.anthemAV.com and locate the latest software. Proceed only if your version is a lower number, indicating that it is older.
3. Click on the software link. You will be asked where to save a .zip file – save it to Desktop.
4. Double click or right-click on the downloaded file then extract it to Desktop.
5. In the extracted folder see Read Me.txt for the change history.
6. Double click on Installer.exe. The remaining instructions will appear.

Troubleshooting:

If the installer keeps returning a message saying that the processor is not found, make sure that the serial port on your computer isn't being used by another application – you must go into the application that is using it to turn off the serial port.

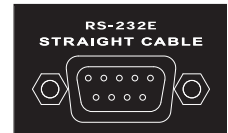

APPENDIX A – IR MACROS

Using the factory remote control's IR codes for MAIN path, the following 3-key sequences can be programmed into macro-capable aftermarket remotes to create a separate button for each mode, source, and tuner bank:

For Stereo sources:

MODE, 0, 1 – Stereo
MODE, 0, 2 – AnthemLogic-Music
MODE, 0, 3 – AnthemLogic-Cinema
MODE, 0, 4 – Pro Logic IIx Music
MODE, 0, 5 – Pro Logic IIx Movie
MODE, 0, 6 – Dolby Pro Logic
MODE, 0, 7 – DTS Neo:6 Music
MODE, 0, 8 – DTS Neo:6 Cinema
MODE, 0, 9 – All Channel Stereo
MODE, 1, 0 – All Channel Mono
MODE, 1, 1 – Mono
MODE, 1, 2 – Mono-Academy
MODE, 1, 3 – Pro Logic IIx Matrix
MODE, 1, 4 – Pro Logic IIx Game
THX, 0, 1 – THX Off
THX, 0, 2 – THX Cinema
THX, 0, 3 – THX Games Mode

For Surround-flagged Dolby Digital 2.0 sources:

MODE, 2, 1 – Stereo
MODE, 2, 2 – AnthemLogic-Music
MODE, 2, 3 – AnthemLogic-Cinema
MODE, 2, 4 – Pro Logic IIx Music
MODE, 2, 5 – Pro Logic IIx Movie
MODE, 2, 6 – Dolby Pro Logic
MODE, 2, 7 – DTS Neo:6 Music
MODE, 2, 8 – DTS Neo:6 Cinema
MODE, 2, 9 – All Channel Stereo
MODE, 3, 0 – All Channel Mono
MODE, 3, 1 – Mono
MODE, 3, 2 – Mono-Academy
MODE, 3, 3 – Pro Logic IIx Matrix
MODE, 3, 4 – Pro Logic IIx Game
THX, 0, 4 – THX Off
THX, 0, 5 – THX Cinema
THX, 0, 6 – THX Games Mode

Pro Logic IIx Music adjustment:

MODE, 4, 1 – Center Width display
MODE, 4, 2 – Dimension display
MODE, 4, 3 – Panorama Off
MODE, 4, 4 – Panorama On

Neo:6 Music adjustment:

MODE, 4, 5 – Center Image display

THX Re-EQ:

THX, 3, 0 – Re-EQ Off when THX is on
THX, 3, 1 – Re-EQ On when THX is on
THX, 3, 2 – Re-EQ Off when THX is off
THX, 3, 3 – Re-EQ On when THX is off

For Dolby Digital 5.1 sources:

THX, 1, 0 – None
THX, 1, 1 – THX Cinema
THX, 1, 2 – THX Ultra2 Cinema
THX, 1, 3 – THX MusicMode
THX, 1, 4 – THX Surround EX
THX, 1, 5 – THX Games Mode
THX, 1, 6 – PLIIx Movie
THX, 1, 7 – PLIIx Movie+THX Cinema
THX, 1, 8 – PLIIx Music
THX, 1, 9 – Dolby Digital EX
THX, 2, 0 – Neo:6
THX, 2, 1 – Neo:6+THX Cinema

For Dolby Digital Surround EX-flagged sources:

MODE, 5, 1 – None
MODE, 5, 2 – Dolby Digital EX
MODE, 5, 3 – THX Surround EX
MODE, 5, 4 – PLIIx Movie
MODE, 5, 5 – PLIIx Movie+THX Cinema
MODE, 5, 6 – PLIIx Music
MODE, 5, 7 – Neo:6
MODE, 5, 8 – Neo:6+THX Cinema

For 6-Ch sources (analog or HDMI):

MODE, 7, 0 – None
MODE, 7, 1 – THX Cinema
MODE, 7, 2 – THX Ultra2 Cinema
MODE, 7, 3 – THX MusicMode
MODE, 7, 4 – THX Surround EX
MODE, 7, 5 – THX Games Mode
MODE, 7, 6 – PLIIx Movie
MODE, 7, 7 – PLIIx Movie+THX Cinema
MODE, 7, 8 – PLIIx Music
MODE, 7, 9 – Dolby Digital EX
MODE, 8, 0 – Neo:6
MODE, 8, 1 – Neo:6+THX Cinema

For 6.1- and 7.1- channel sources:

THX, 6, 0 – None
THX, 6, 1 – THX Cinema

For DTS sources:

THX, 4, 0 – None
THX, 4, 1 – THX Cinema
THX, 4, 2 – THX Ultra2 Cinema
THX, 4, 3 – THX MusicMode
THX, 4, 4 – Neo:6+THX Cinema
THX, 4, 5 – THX Games Mode
THX, 4, 6 – PLIIx Movie
THX, 4, 7 – PLIIx Movie+THX Cinema
THX, 4, 8 – PLIIx Music
THX, 4, 9 – Dolby Digital EX
THX, 5, 0 – Neo:6

For DTS-ES sources:

MODE, 6, 1 – None
MODE, 6, 2 – DTS-ES Matrix
MODE, 6, 3 – DTS-ES+THX Cinema
MODE, 6, 4 – PLIIx Movie
MODE, 6, 5 – PLIIx Movie+THX Cinema
MODE, 6, 6 – PLIIx Music
MODE, 6, 7 – Dolby Digital EX

The macros below also work in ZONE2/3.

Tuner Bank Selection:

MODE, 9, 0 – AM
MODE, 9, 1 – FM1
MODE, 9, 2 – FM2
MODE, 9, 3 – FM3

Source Selection:

THX, 8, 0 – CD
THX, 8, 1 – 2-Ch BAL
THX, 8, 2 – 6-Ch S/E
THX, 8, 3 – TAPE
THX, 8, 4 – FM•AM
THX, 8, 5 – DVD1
THX, 8, 6 – DVD2
THX, 8, 7 – DVD3
THX, 8, 8 – DVD4
THX, 8, 9 – TV1
THX, 9, 0 – TV2
THX, 9, 1 – TV3
THX, 9, 2 – TV4
THX, 9, 3 – SAT1
THX, 9, 4 – SAT2
THX, 9, 5 – VCR
THX, 9, 6 – AUX

When using Simulcast mode, all sources must be selected using macros, and within 2 seconds.

Some tips if you're using a macro-capable remote control:

- If you do not want separate mode selection according to flagged vs unflagged source material, you can program macros as a 6-key sequence, for example MODE, 0, 1, MODE, 2, 1 and flag will make no difference to selection.
- You can program your source selection keys with the power-on command preceding each source-select command. This way, when a source is selected, the processor will turn on at the same time if it is off, similar to front panel operation.
- If your source components also have discrete commands for power-on and power-off, you can take the above idea even further, for example, program the TV button with the following sequence: Power-on the processor, select TV, power-on the satellite receiver / cable box, power-on the TV. This way, when the entire system is off and you or a family member wants to watch TV, "just push TV".

APPENDIX B – PRESET MEMORY CODES

The following codes are for setting operation of other components with the processor's remote control. If codes for your components are not in this library, see sections 5.1 and 5.2.

To enter a 5-digit code:

1. Press the control mode key near the top of the remote (e.g. **DVD**).
2. Press and hold **LEARN** until the LED flashes twice.
3. Enter the **5-digit code**. Two LED blinks indicate that the code is accepted.

Anthem Processors:

D1/2, AVM 20/30/40/50 – MAIN	31185
D1/2, AVM 20/30/40/50 – ZONE2	31186
D1/2, AVM 20/30/40/50 – ZONE3	31187
AVM 2 – MAIN	31096
AVM 2 – ZONE2	31097

Audio Amplifiers:

Accuphase	30382
Acurus	30765
Adcom	31100, 30577
Aiwa	30406
AudioSource	30011
Bel Canto Design	31583
Bose	30674
Carver	30269
Classe	31461, 31462
Curtis Mathes	30300
Denon	30160
Durabrand	31561
GE	30078
Harman/Kardon	30892
JVC	30331
Kenwood	30356
Korsun	31483
Left Coast	30892
Lenoxx	31561
Linn	30269
Logitech	31408
Luxman	30165
Magnavox	30269
Marantz	30892, 30321, 30269
Mark Levinson	31483
Nakamichi	30321
NEC	30264
Optimus	30395, 30300
Panasonic	30521, 30308
Parasound	30246
Philips	30892, 30269
Pioneer	30013, 30300
Polk Audio	30892, 30269
PS Audio	31523
RCA	30300
Realistic	30395
Sansui	30321
Shure	30264
Sony	30689, 30220, 30815
Soundesign	30078, 30211
Technics	30521, 30308
Victor	30331
Wards	30078, 30211, 30013
Yamaha	30354, 30143, 30133, 30504,
YBA	31502

Audio Amp/Tuners:

ADC	30531
Adcom	31616, 30616, 31617
Aiwa	31405, 30158, 30189, 31243,
	31089, 31388, 30121, 30405,
	31321, 31641, 31347
Akai	30224, 30076, 31512, 31255
Alco	31390
Amphion Media Works	31615, 31563
AMW	31563, 31615
Anam	31609, 31074, 30281
Apex Digital	31430, 31257
Arcam	31120
Audiophase	31387
Audiotronic	31189

Audiovox	31390, 31627
AVLight	30158
Bel Canto Design	31584
Bose	31229, 31253, 30639
Brix	31602
Cambridge Soundwks	31477, 31370
Capetronic	30531
Carver	31189, 30189, 30042, 31089,
	30008, 30360
Casio	30195
Clarinette	30195
Classic	31352
Coby	31513, 31389, 31263
Compaq	31136
Criterion	31420
Curtis	31596
Curtis Mathes	30080
Daewoo	31250
Dell	31383
Denon	31360, 30004, 31104, 30771,
	31311, 30273, 31142, 30301
Dynamic Bass	30360
Emerson	30424, 30255
Fisher	31409, 30360, 30219, 31801,
	30042
Fonmix	31360
Fosgate	31487
Garrard	30424, 30281, 30463, 30146,
	30440
Gateway	31517, 31567
GE	31379
Glory Horse	31263
Go Video	31532
GoldStar	30281
GPX	31299
Hafler	30146
Harman/Kardon	30110, 30189, 30891
Hewlett Packard	31181
Hitachi	31801, 31273
Initial	31426
Inkel	30027, 30062, 30502, 30491
Integra	30135, 31298
JBL	30110, 31306, 30281
JVC	30074, 31282, 31263, 31495,
	31374
Kansai	30440
Kenwood	31313, 31570, 31569, 30027,
	31051, 30077, 30313, 31027,
	30042, 30239, 30569, 31052,
	30186, 30314
KLH	31412, 31390, 31428
Koss	30424, 30255, 31366
Lasonic	31798, 31510
Lenoxx	31437
Lexicon	31076
Linn	30189
Liquid Video	31497
Lloyd's	30195
LXI	30181
Magnavox	31189, 31269, 30189, 30128,
	30391, 30195, 31089, 31514,
	30531
Marantz	31189, 31269, 30039, 30189,
	31089, 31289, 30200, 30128
MCS	30039, 30346
Memorex	31596
Mitsubishi	31393
Modulaire	30195
Musicmagic	31089
NAD	30320
Nakamichi	30347, 30097, 31555
NEC	30235
Norcent	31389

Onkyo	30135, 31298, 30842, 30380,
	31531
Optimus	31023, 30801, 31074, 30080,
	30186, 30531, 30797, 30042,
	30181, 30440, 30738, 30849,
	30177, 30219, 30670
Oritron	31497, 31366
Panasonic	31518, 30039, 31548, 31764,
	30518, 31350, 31763, 30367,
	31316, 31509, 31633, 30309,
	31288, 31363
Penney	30195
Philco	31390
Philips	31189, 31269, 30189, 31365,
	31089, 31266, 31283, 30891,
	31368, 30391, 31120, 31268
Pioneer	31023, 30150, 30630, 31184,
	30080, 30531, 31084, 31384,
	30244, 31343
Polaroid	31508
Polk Audio	30189, 31289
Proscan	31254
Qisheng	31609, 31390
Quasar	30039
RadioShack	31263
RCA	31023, 31609, 31254, 30346,
	30531, 31154, 31511, 30080,
	30530, 31074, 31390, 30054,
	30360
Realistic	30195, 30181, 30163
Regent	31437
Rio	31869, 31383
Saba	31519
Samsung	31500, 31295
Sansui	30189, 30346, 30193, 31089
Sanyo	30801, 30360, 31469, 30219,
	31251
Scott	30163, 30322
Sharp	31286, 30186, 31386, 31361
Sharper Image	31545, 31556, 30797, 31409,
	31416, 31549, 31385, 31411,
	31546, 31723, 31263, 31410
Sherwood	30491, 31423, 30062, 31077,
	30502, 31653
Shinco	31390
Shinsonic	31426
Silsonic	30176, 31426
Sonic	30281
Sonic Blue	31383, 31869, 31532
Sony	31058, 31441, 31258, 31759,
	30158, 31442, 31529, 31758,
	31371, 31503, 31042, 31658,
	31158, 31858, 31367, 31406,
	31458, 30168, 31558, 31131,
	31349, 31382
Soundesign	30670
Stereophonics	31023
Sunfire	31313, 30314, 30313, 31052
Tae Kwang	30440
Teac	30163, 31267, 31074, 31528,
	30463, 31390
Technics	31308, 31518, 30039, 30518,
	30309, 31309, 30208
Techwood	30281
Thorens	31189
Venturer	31390, 30849
Victor	30074
Wards	30158, 30189, 30080, 30054
Yamaha	30176, 30081, 31176, 31375,
	30186, 31331, 31276
Yorx	30195
Zenith	31293, 30857, 30281, 31869

APPENDIX B – PRESET MEMORY CODES continued ...

Cable Converters:

ABC	0003, 0008, 0014, 0001, 0007, 0013, 0011, 0017
Allegro	00315, 00153
Americast	00899
Antronix	00207, 00022
Archer	00797, 00207, 00153, 00022
Belcor	00056
Bell & Howell	00014
Bell South	00899
Cable Star	00056
Cabletenna	00022
Cableview	00022
Century	00153
Citizen	00315, 00153
Clearmaster	00883
ClearMax	00883
Colour Voice	00025, 00031
Comtronics	00040
Contec	00019
Coolmax	00883
Daeryung	01877, 00877, 00477, 00008
Digi	00637
Director	00476
Dumont	00637
Eastern	00002
Emerson	00797
Everquest	00040, 00015
Focus	00400
Funai	00019
Garrard	00153
GC Electronics	00207, 00056
Gehua	00476
Gemini	00797, 00015
General Instrument	00476, 00810, 00276, 00003, 00014, 00011, 00015
Global	01327
GMI	00015, 00797
GoldStar	00144, 00040
Goodmind	00797
Hamlin	00009, 00273, 00034, 00020, 00259
Hitachi	00014, 00011
Hytex	00007
Jasco	00015, 00315, 00153
Jebsee	00400
Jerrold	00476, 00810, 00276, 00003, 00012, 00014, 00011, 00015
Leon	00015
LG	00144, 00040
Linsay	00440
Magnavox	00027
Memorex	00000
Motorola	00476, 00810, 00276, 01254, 01106, 01376
Movie Time	00156, 00063
MS	00015
MultiVision	00012
Novaplex	00618
NSC	00063, 00156
Oak	00019, 00007
Optimus	00021
Pace	01877, 00237
Panasonic	00000, 00008, 00107, 00040, 00021
Panther	00637
Paragon	00000
Philips	00317, 00027, 00025, 00153, 00013, 00031, 01305
Pioneer	01877, 00877, 00144, 00533, 01021
Popular Mechanics	00400
Pulsar	00000
Quasar	00000
RadioShack	00015, 00883, 00797, 00315
RCA	00021
Realistic	00207
Recoton	00400

Regal	00279, 00273, 00259, 00020
Regency	00002
Rembrandt	00011
Runco	00000
Samsung	00000, 00144, 00040
Scientific Atlanta	01877, 00877, 00477, 00008, 00017
Seam	00510
Signal	00040, 00015
Signature	00011
SL Marx	00040
Sony	01006
Sprucer	00021
Starcom	00003, 00014, 00015
Stargate	00015, 00797, 00040
Starquest	00015
Supercable	00276
Supermax	00883
Sylvania	00001
Tandy	00258
Televue	00040
Texscan	00001
TFC	00310
Timeless	00040
Tocom	00012, 00013
Torx	00003
Toshiba	00000
Trans PX	00276, 00153, 00315
Tristar	00883
TS	00003
Tusa	00015
TV86	00063
Unika	00207, 00153, 00022
United Artists	00007
Universal	00153, 00056, 00207, 00022, 00191
V2	00883
Viewmaster	00883
Viewstar	00063, 00027, 00258
Vision	00883
Vortex View	00883
Zenith	00000, 00525, 00899
Zentek	00400

CD Players:

ADC	30018
Adcom	30155, 30234
Aiwa	30157, 30124, 30012
Akai	30156
Audio Alchemy	30194
Audio-Technica	30170
BSR	30245, 30194
Burmester	30420
California Audio Labs	30029, 30303
Carrera	30194
Carver	30157, 30437, 30179
Classic	31297
Crown	30122
DAK	30245
DBX	30254
Denon	30873, 30003
DKK	30000
DMX Electronics	30157
Dynamic Bass	30179
Emerson	30305, 30164, 30155, 30469
Fisher	30179, 30174, 31325, 30088, 30342
Garrard	30245, 30420, 30393, 30280, 30425
GE	30009
Gemini	30625
Genexxa	30032, 30305, 30164
GoldStar	30417
GPX	31296
Harman/Kardon	30157, 30173, 31202, 30426
Hitachi	30032, 30155
Inkel	30196, 30180, 30437
Integra	30101

JVC	30072, 31294, 30655
Kenwood	30681, 30826, 30626, 30028, 30037, 30036, 30190
KLH	31318
Kodak	30287
Korsun	31484
Koss	31317
Krell	30157
Kyocera	30018
LG	31208
Linn	30157
Luxman	30093
LXI	30305
Magnavox	30157, 30305
Marantz	30626, 30029, 30157, 30180
Mark Levinson	31484
McIntosh	30287
MCS	30029, 30043
Miro	30000
Mission	30157
MTC	30420, 30625
Nakamichi	30147
NEC	30043, 30234
Nikko	30174, 30170, 30164, 30625
NSM	30157
Onkyo	30868, 30101
Optimus	31063, 30000, 30032, 30037, 30342, 30437, 31075, 30145, 30194, 30305, 30426, 30087, 30179, 30280, 30420, 30468, 30175, 30196
Panasonic	30029, 30752, 30303
Parasound	30420, 30194
Philips	30626, 30157, 30287
Pioneer	31063, 31062, 30032, 30305, 30468, 31087
Polk Audio	30157
Proton	30157
QED	30157
Quad	30157
Quasar	30029
RadioShack	31075
RCA	31062, 30032, 30305, 30764, 30179, 30468, 30009, 30155, 30420, 30053
Realistic	30164, 30180, 30155, 30179, 30175, 30420
Rotel	30157, 30420
SAE	30157
Sansui	30157, 30305, 30202
Sanyo	30179, 30087
SAST	30157
Scott	30305, 30164, 30155
Sears	30305
Sharp	30861, 30037, 30180
Sherwood	31067, 30196, 30180, 30426
Shure	30043
Silsonic	30888, 30036
Sonic Frontiers	30157
Sony	30490, 30000, 31364, 30185, 30605, 30100, 30604
Soundesign	30425, 30145
STS	30018
Symphonic	30305
TAG McLaren	30157
Tascam	30420
TDK	31208
Teac	30393, 30180, 30174, 30420
Technics	30029, 30207, 30303
Tivoli Audio	31553
Vector Research	30194, 30417
Victor	30072
Wards	30157, 30053
Yamaha	30888, 30036, 30187, 30170, 31292
YBA	30625
Yorx	30461
Zonda	30157

APPENDIX B – PRESET MEMORY CODES continued ...

DVD Players:

Adcom	21094
Advent	21016
Aiwa	20641, 21912
Akai	20899, 20770, 21975, 21089
Allegro	20869
Amphion Media Works	22016, 22001
AMW	20872, 22016, 22001, 21176
Anam	21913
Apex Digital	20672, 20717, 20797, 21020, 21100, 20796, 21004, 21061, 21937, 20794, 20830, 21056, 21915, 20755
Aspire Digital	21168
Audiologic	20736
Audiovox	21071, 21122, 21041, 21121, 21072
Axion	21071, 21072
B & K	20662, 20655
Bel Canto Design	21571
Blaupunkt	20717
Blue Parade	20571
Broksonic	20868, 20695
Cambridge Soundwks	21916
CAVS	21057
Changhong	20627, 21061
CineVision	20876, 20869
Classic	21917
Coby	20778, 21107, 21086, 21923, 20852, 21165
Criterion	22007
Curtis Mathes	21087
CyberHome	21023, 21129, 20816, 21117, 21024
Daewoo	20784, 20869, 20833, 21918, 21172, 20705
Denon	20490, 20634
Dual	21085, 21068
DVD2000	20521
Emerson	20591, 20675, 20821
Enterprise	20591
Fisher	20670, 21919
Funai	20675
Gateway	21077, 21073, 21158
GE	20522, 20815, 20717
Go Video	20744, 20869, 21099, 21970, 20715, 20833, 21075, 21730, 20783, 21044, 21144
GPX	20699, 20769
Greenhill	20717
Harman/Kardon	20582, 20702
Hitachi	20573, 20664, 21919
Hiteker	20672
Initial	20717, 21931
Integra	20627, 21924
Jamo	22003
Jaton	21078
JBL	21926, 20702
Jensen	21016
JVC	20558, 20623, 21940, 21901, 20867
jWin	21051, 21049
Kenwood	20490, 20534, 21063, 20682
KLH	20717, 21939, 21149, 21020
Konka	20720, 20719, 20711, 20721
Koss	20651
Landel	20826
Lasonic	20798, 21173
Lennox	21938
LG	20801, 20101
Lite-On	21158, 21058
Loewe	20511
Magnavox	20503, 20675, 21976, 21914, 20821
Malata	21159, 20782
Marantz	20539
Memorex	20695

Microsoft	20522
Mintek	20839, 20717
Mitsubishi	21521, 20521
Momitsu	21082
NEC	20785
Nesa	20717
Next Base	20826
Niro	22024
Norcent	21003, 20872, 21923, 21107
Onkyo	20503, 20627, 21924, 20792, 21985
Oritron	20651, 21980
Panasonic	20490, 21462, 21907, 21910, 21990, 21362, 21762, 21909, 21986, 20632, 21490, 21908, 21925, 22017
Philco	22000
Philips	20503, 20539, 20646, 20885, 20854, 21914
Pioneer	20525, 20571, 20638, 20632, 20631, 21902
Polaroid	21086, 21061, 21998, 21200
Polk Audio	20539
Portland	20770
Prima	21016
Princeton	20674
Proscan	20522
ProVision	20778
Qwestar	20651
RCA	20522, 20571, 20717, 20822, 21193, 21974, 21132, 21965, 21022, 21913
Regent	21938
Rio	20869
Rotel	20623
Rowa	20823
Saba	21977
Sampo	20752, 20698
Samsung	20490, 20573, 20820, 21932, 21075, 20899, 21979
Sansui	20695
Sanyo	20695, 20670, 21967, 20873
Sharp	20630, 20752
Sharper Image	21995, 21117
Sherwood	21043, 20770, 20633, 21077
Shinco	20717
Shinsonic	20533, 20839, 21931
Sigma Designs	20674
Sonic Blue	20869, 21970, 21099
Sony	20533, 21533, 20864, 21033, 21904, 22020, 21903, 21981, 20772, 21934
Sungale	21074
Superscan	20821
SVA	20717, 20860, 21105
Sylvania	20821, 20675
Symphonic	20675
Teac	21984, 20809
Technics	20490
Technosonic	20730
Techwood	20692
Terapin	21031
Theta Digital	20571
Tivo	21996
Toshiba	20503, 21154, 22006, 21045, 21996, 20695, 21988
Tredex	20803, 20800, 20799, 20804
TYT	20705
Urban Concepts	20503
US Logic	20839
V Inc.	21226, 21064
Vocopro	21027
Xbox	20522
Xwave	21001
Yamaha	20490, 20539, 20545
Zenith	20503, 20591, 21906, 20869, 22002

Satellite Receivers:

AlphaStar	00772
Chaparral	00216
Crossdigital	01109
DirecTV	00392, 00566, 00639, 01639, 01142, 00247, 00749, 01749, 00724, 00819, 01856, 01076, 01109, 00099, 01444, 01108, 01392, 01443, 01640, 01442, 01414
Dish Network System	01005, 00775, 01775, 01505, 01170
Dishpro	01005, 00775, 01505, 01775
Echostar	01005, 00775, 01170, 01775, 01505
Expressvu	00775, 01775
Funai	00338
GE	00566
General Instrument	00869
GOI	00775, 01775
Goodmans	01246
Hisense	01535
Hitachi	00819, 01250, 00214, 00491, 00489, 00201
HTS	00775, 01775
Hughes Network Sys	01142, 00749, 01749, 01443, 01442, 01444
I-Lo	01535
JVC	00775, 01170, 00492, 01775
LG	01414, 01226
Magnavox	00724, 00722
Matsushita	00340, 00214, 00500
Memorex	00724
Mitsubishi	00749, 00491
Motorola	00869
NEC	00496, 01270
Next Level	00869
Panasonic	00247, 00701, 00214, 00500, 00340
Paysat	00724
Philips	01142, 00749, 01749, 00724, 01076, 00722, 00099, 01442
Proscan	00392, 00566
Proton	01535
RadioShack	00869
RCA	00392, 00566, 00855, 00143, 01392
Samsung	01276, 01109, 01108
Sanyo	00493, 01219
Sharp	00494
SKY	00856
Sony	00639, 01639, 00294, 01640, 00163
Star Choice	00869
Tivo	01142, 01444, 01443, 01442
Toshiba	00749, 01749, 00790, 00486, 01285
UltimateTV	01392, 01640
Uniden	00724, 00722
US Digital	01535
USDTV	01535
Victor	00492
Voom	00869
Zenith	00856, 01856

APPENDIX B – PRESET MEMORY CODES continued ...

TVs:

888 10264
A-Mark 10003
Abex 10032
Addison 11150, 10653, 10092
Admiral 10093, 10463
Advent 10761, 10817, 10815, 11933, 10783, 10842
Adventura 10046
Aiko 10092
Aiwa 11914, 11910
Akai 10812, 10702, 10030, 10672, 11903, 10264
Alaron 10179
Albatron 10843, 10700
Ambassador 10177
America Action 10180
Ampro 10751
Anam 10250, 10180, 10003, 10700, 10161, 10628
Anam National 10250, 10161, 10055, 10650
Anhua 10051
AOC 10451, 10093, 10180, 10060, 10030, 10178, 10019, 10185, 11150, 10018, 10052, 10474, 10003, 10092, 10179
Aolinpike 10264
Apex Digital 10748, 10765, 10767, 11943, 10879
Archer 10003
Audiovox 10451, 10180, 10875, 11952, 10802, 11951, 10092, 10623, 11937, 10003
Axion 11937
Baihe 10264
Baile 10001, 10391
Baohuashi 10264
Baosheng 10817
Beijing 10812, 10391, 10264, 10817, 10001
Belcor 10019
Bell & Howell 10154, 10016
BenQ 11032
Bradford 10180
Brockwood 10019
Broksonic 10236, 10463, 11911, 11938, 10003, 11905, 11935, 11929
Caihong 10817
Cailing 10748
Candle 10030, 10046, 10186, 10056
Carnivale 10030
Carver 10054, 10170
Celebrity 10000
Celera 10765
Changcheng 10051, 10817, 10001, 10391, 10264
Changfei 10817
Changfeng 10817, 10264
Changhai 10817
Changhong 10156, 10765, 10817, 10264, 10783, 10767, 11910
Chengdu 10817
Ching Tai 10003, 10474, 10179, 10092
Chun Yun 10000, 10180, 10161, 10474, 11150, 10092, 10843, 10003, 10179, 10700
Chunfeng 10264
Chung Hsin 10180, 10053, 11150, 10036, 10474
Chunsun 10817
Cinema 10672
Citizen 10060, 10030, 10039, 10280, 10056, 10186, 10046, 10092, 11928
Clairtone 10185
Clarion 10180
Colt 11906
Concerto 10056
Conrowa 10156, 10145, 10264
Contec 10180, 10157, 10185
Craig 10180, 10161
Crosley 10054
Crown 10180, 10039

Curtis Mathes 10047, 10054, 10154, 10451, 10093, 10060, 10702, 10030, 10145, 10166, 10466, 11347, 10039, 10056, 11147, 10016, 11919
CXC 10180
Daewoo 10154, 10451, 10180, 10030, 10178, 11661, 10474, 10003, 10628, 10032, 11150, 10092, 11928, 10627, 10700, 10056, 11909, 10170, 10391, 10623, 10019, 10672, 10039
Daytron 10019
Dayu 10391
Dell 11080
Denon 10145, 10511
Dumont 10017, 10019
Durabrand 10463, 10180, 10178, 10171, 11034, 10003
Dwin 10774, 10720
ECE 10037
Electroband 10000, 10185
Electrohome 10381
Elektra 10017, 11661
Emerson 10154, 10236, 10463, 10180, 10178, 10171, 10280, 10623, 10038, 11911, 11944, 10179, 10019, 11909, 11929, 10185, 10282, 11905, 10039, 11928, 10177
Envision 10030, 10813
Epson 10833, 10840
Ether 10030, 10161, 10003
Feilu 10817
Feiyan 10264
Feiyue 10817
Firstar 10236
Fisher 10154, 10159
Fortress 10093
Fujitsu 10186, 10853, 10179, 10809, 10683
Funai 10180, 10171, 10264, 11904, 10179, 10342
Furi 10145, 10817, 10264
Futurtech 10180
Ganxin 10817
Gateway 11756, 11755
GE 11447, 10047, 11454, 10051, 10451, 10180, 10030, 10178, 10092, 11147, 11919, 10055, 10027, 11917, 10135, 10282, 11347, 10021, 11907, 11922
General 10186
Gibraltar 10017, 10030, 10019
Gintai 11150, 10474
Go Video 10886
GoldStar 10154, 10030, 10178, 11926, 10019, 10037, 11910, 10001, 10032, 10056, 11150, 10039
Goodmans 10360
Grunpy 10180, 10179
Haier 11034, 10768
Haiyan 10264, 10817
Hallmark 10178
Hankook 10180, 10030, 10178, 10019, 10056, 10628
Harley Davidson 11904, 10179
Harman/Kardon 10054
Harvard 10180
Havermy 10093
Hello Kitty 10451
Hitachi 10180, 10628
Hisense 10156, 10748, 10145
Hitachi 11256, 10156, 10030, 10178, 11145, 10145, 10038, 11245, 10092, 10027, 10381, 10036, 11150, 10056, 11904, 10151, 10165, 10019, 10186, 10032, 10039, 10157, 10016, 10179, 10474
Hongmei 10093, 11910, 10817, 10264
Hongyan 10817, 10264
Hua Tun 11150

Huafa 10145
Huanghe 10817
Huangshan 10264, 10817
Huanyu 11910, 10817, 10264
Huaqiang 10264
Huari 10145, 10264
Huodateji 10051
Hyundai 10849
Imperial Crown 10001, 10391, 10264
Infinity 10054
Inteq 10017
Janeil 10046
JBL 10054
JCB 10000
Jean 10156, 10051, 10236, 10092, 10179, 10003, 10474
Jensen 10761, 10815, 11933, 10817
Jiahua 10051
Jialicai 10264
Jinfeng 10051, 10817
Jinhai 11910
Jinque 10817, 10264
Jinta 10264, 11910
Jinxing 10054, 10156, 10145, 10264, 10037, 10817
Juhua 10817, 10264
JVC 10053, 10160, 11923, 11253, 10036, 10653
Kaige 10264, 10817
Kangchong 11910
Kangli 10001, 10817, 10391, 10264
Kangyi 10264
Kaypani 10052
KEC 10180
Kenwood 10030, 10019
KLH 10765, 10767
KLL 10037
Kloss 10046, 10024
Kolin 10180, 10053, 11150, 10036, 10474
Kongque 10264, 10817
Konka 10632, 10707, 11940, 10628, 10703, 11939, 10638, 10817
KTV 10180, 10030, 10185, 10039, 10280
Kuaile 10264
Kunlun 10051, 10817, 10264
LG 10060, 10030, 10178, 10056, 10442, 10856, 10001, 10038, 10700, 10019, 10037, 10474, 11178, 10003, 10032, 10006
Lihua 10817
Lloyd's 11904
Loewe 10136
Logik 10016
Longjiang 10264, 10817
Luxman 10056
LXI 10047, 10054, 10154, 10156, 10178
Magnasonic 11928, 11913
Magnavox 11454, 10054, 10030, 10706, 11904, 10020, 11944, 10036, 10179, 10386, 11931, 10096, 10187, 11254, 11913, 10024, 10186
Magnin 11907
Majestic 10016
Marantz 10054, 10030, 10854, 10704, 11154, 10855
Maruman 10627, 10391
Matsushita 10250, 10650, 10161
Megapower 10700
Megatron 10178, 10145, 10003
MEI 10185
Meile 10264, 11910, 10817
Memorex 10154, 10463, 10150, 10178, 10179, 11920, 11927, 10016, 11911, 11926, 11924
Mermaid 10037
MGA 10150, 10030, 10178, 11907, 10019
Midland 10047, 10017, 10051, 10039, 10135, 10032

APPENDIX B – PRESET MEMORY CODES continued ...

TVs continued:

Minutz 10021
 Mitsubishi 10154, 10250, 10093, 10236, 10180, 11250, 10150, 10030, 10178, 10381, 10836, 10036, 10179, 10817, 11150, 10474, 10019, 10868, 10056, 11917
 Monivision 10843, 10700
 Motorola 10093, 10055
 MTC 10060, 10030, 10185, 10019, 10056
 Mudan 10051, 10817, 10264
 Multitech 10180
 NAD 10156, 10178, 10866
 Nanbao 11910, 10264
 Nansheng 10817, 10264
 National 10051
 NEC 10154, 10156, 10051, 10053, 10030, 10178, 10046, 11150, 10056, 10165, 10186, 10474, 10036, 10882, 10381, 10817, 11704, 10170, 10264, 10019, 10497
 Newave 10093, 10178, 11150, 10092, 10161
 Nikko 10030, 10178, 10092
 Nikon 11910
 Norcent 10748, 10824
 Noshi 10018
 NTC 10092
 Onking 10280
 Onwa 10180
 Optimus 10154, 10250, 10166, 11924, 11913, 10650, 11927
 Optoma 10887
 Optonica 10093, 10165
 Orion 10236, 10463, 11911, 11905, 10179, 11463, 11929
 Panasonic 10054, 10250, 10051, 10161, 11410, 11927, 11947, 10037, 10055, 10650, 11924, 11946, 11919, 11941
 Panda 10051, 10706, 10817, 10264, 11910
 Penney 10047, 10156, 10051, 10060, 10030, 10178, 10135, 11347, 11926, 10018, 10027, 10039, 11919, 10003, 10021, 10032, 11907, 10019
 Philco 10054, 10180, 10030, 10178, 10628, 10474, 10020, 10037, 10096, 10186, 10774, 10019, 10032, 10056
 Philips 11454, 10054, 10000, 10051, 10030, 10178, 10474, 10019, 11154, 10092, 10187, 10774, 10024, 10037, 10056, 10186, 10690, 10020, 10032
 Pilot 10030, 10019, 10039
 Pioneer 10166, 10038, 10866, 10679
 Portland 10092, 10039, 10019
 Prima 10761, 10815, 10783, 11933, 10817
 Princeton 10717, 10700
 Prism 10051
 Proscan 11447, 10047, 11347, 11922
 Proton 10030, 10178, 10001, 10039, 10466, 10003, 10052, 10474
 Pulsar 10017, 10019
 Qingdao 10051, 10817, 10264
 Quasar 10250, 10051, 11924, 10165, 11919, 10055, 10650
 RadioShack 10047, 10154, 10180, 10030, 10178, 10032, 10056, 11920, 10165, 11904, 10019, 10039

RCA 11447, 10047, 11454, 10000, 10030, 10178, 10679, 11247, 11917, 10090, 11948, 11147, 10019, 11907, 11922, 10135, 11958, 11047, 11347, 10018, 11547, 10038, 11919, 10092, 11953
 Realistic 10154, 10180, 10030, 10178, 10056, 10019, 10039, 10165, 10032
 Rhapsody 10185
 Rowa 10748, 10037, 10817
 Runco 10017, 10030, 10603, 10497
 Ruyi 10817
 Saige 10817
 Sampo 10154, 10093, 10030, 10178, 10171, 10032, 10052, 10474, 11755, 10039, 10700, 10036, 10092, 10650
 Samsung 10154, 10156, 10060, 10812, 10702, 10030, 10178, 10019, 10056, 11060, 10092, 10474, 10774, 10032, 10817, 10090, 11903, 10264, 10766, 10814, 11150, 10179
 Samsux 10039
 Sanjian 10264
 Sansui 10463, 11904, 11929, 11911
 Sanyo 10154, 10156, 10180, 10145, 10376, 10474, 10036, 10893, 11907, 10159, 10280, 10424, 10799, 11154, 10157, 10264, 10381, 10798, 10088, 11150
 Sanyuan 10093, 10817
 Scimitsu 10019
 Scotch 10178
 Scott 10236, 10180, 10178, 10179, 10019
 Sears 10047, 10054, 10154, 10156, 10178, 10171, 11926, 11904, 10056, 10159, 10179
 Shancha 10817, 10264
 Shanghai 10264, 11910, 10817
 Shaofeng 10145, 10817
 Sharp 10093, 10030, 10157, 10386, 10650, 10720, 10032, 10851, 10256, 10491, 10689, 10818, 10039, 10165, 10474, 10688, 10787, 10036, 11917
 Sharper Image 11950
 Shen Ying 10092, 10003, 10474, 10179
 Shencai 10145, 10264
 Sheng Chia 10093, 10236, 10179, 11150, 10474
 Shenyang 10817, 10264
 Shogun 10019
 Signature 10016
 Simpson 10187, 10186
 Skygiant 10180
 Skyworth 10748, 10264, 10037, 10817
 Sony 11100, 10000, 10036, 10650, 11300, 10111, 11925, 10080, 10834, 11904
 Soundesign 10180, 10178, 10179, 10186
 Sowa 10156, 10051, 10060, 10178, 10036, 10092, 10474, 11150
 Spectricon 10003
 Squareview 10171
 SSS 10180, 10019
 Starlite 10180
 Studio Experience 10843
 Supre-Macy 10046
 Supreme 10000
 SVA 10748, 10587, 10865, 10872, 10768, 10871, 10870
 Sylvania 10054, 10030, 10171, 11931,

Symphonic 10381, 11944, 10020, 10096
 Synco 10180, 10171, 11913, 11904
 10000, 10451, 10093, 10060, 10178, 10092, 10036, 10474
 Tacico 10178, 10179, 11150, 10092, 10474
 Tai Yi 11150
 Taishan 10817, 10391
 Tandy 10093
 Tashiko 11150, 10650, 10092
 Tatung 10054, 10154, 10156, 10051, 10060, 11150, 10474, 10036, 10055, 11756, 10003
 Technics 10250, 10051
 Technol Ace 10179
 Techview 10847
 Techwood 10051, 10003, 10056
 Teco 10051, 10093, 10178, 10474, 10036, 10280, 10092, 10264, 10653
 Teknika 10054, 10180, 10150, 10060, 10019, 10056, 10186, 10016, 10092, 10039, 10179
 Telefunken 10702, 10056
 Tera 10030, 10466, 10474
 Thomas 11904
 Tiane 10093, 10817
 TMK 10178, 10177, 10056
 TNCi 10017
 Tobo 10748, 10264
 Tongguang 10264
 Toshiba 10154, 11256, 10156, 10060, 10145, 11918, 11945, 10381, 10832, 10036, 11704, 11936, 10264, 10650, 11150, 11656, 11935, 10161, 10509, 10845, 11356
 Tosonic 10185
 Totevision 10039
 Trical 10157
 Tuntex 10030, 10474, 10092
 TVS 10463
 Ultra 10391
 Universal 10027
 V Inc. 11756, 10885, 10864
 Vector Research 10030
 Victor 10250, 10053, 10160, 10650, 10376, 10036, 10653
 Vidikron 10054
 Videch 10178, 10019, 10036
 Viewsonic 10857, 11755, 10885, 10864
 Viking 10046
 Wards 10054, 10030, 10178, 10020, 10080, 10165, 10866, 10019, 10027, 10056, 10111, 10179, 10016, 10021, 10096
 Warumaia 10391
 Waycon 10156
 Westinghouse 10889
 White Westinghouse 10463, 10186, 11909, 10623
 Xiahua 10817, 10264
 Xiangyang 10264
 Xihu 10817, 10264
 Xinghai 10264
 Xinrisong 11910
 Xuelian 11910
 Yamaha 10030, 10838, 10019, 10833, 10769, 10839
 Yapshe 10250
 Yongbao 11910
 Youlanasi 10817
 Yusida 11910
 Zenith 10017, 10463, 10178, 11911, 10016, 11909, 10092, 11904, 11929
 Zonda 10003

APPENDIX B – PRESET MEMORY CODES continued ...

VCRs:

ABS 21972
Admiral 20048, 20209
Adventura 20000
Aiko 20278
Aiwa 20037, 20000, 20307, 20468, 20124, 20406, 20348, 20479
Akai 20041, 20061, 20175, 20106
Alienware 21972
America Action 20278
American High 20035
Amoisonic 20479
Anam 20162, 20037, 20240, 20278, 20226, 21037
Anam National 20162, 20226
Asha 20240
Audiovox 20037, 20278
Beaumarck 20240
Bell & Howell 20104
Blaupunkt 20226
Broksonic 20184, 20121, 20209, 20002, 20348, 20295, 21479, 20479
Calix 20037
Canon 20035, 21174, 20167
Carver 20081
CCE 20072, 20278
Changhong 20048, 20081
Citizen 20037, 20278, 21278
Colt 20072
Craig 20037, 20047, 20240, 20072, 20271
Curtis Mathes 20060, 20035, 20162, 20041, 20760, 21035
Cybernex 20240
CyberPower 21972
Daewoo 20045, 20104, 20278, 20210, 20368, 21278, 20637, 20046, 20212, 20561
Dell 21972
Denon 20042
DirecTV 20739, 21989, 21954, 21949
Dish Network System 21943, 21946, 21945, 21944
Dishpro 21944, 21943
Durabrand 20039, 20038
Dynatech 20000
Echostar 21943, 21946, 21945, 21944
Electrohome 20037
Electrohome 20037
Emerex 20032
Emerson 20035, 20037, 20184, 20240, 20045, 20000, 20121, 20043, 20209, 20002, 20278, 20295, 20036, 20637, 21593, 20561, 21479, 20068, 20208, 20479, 21278, 20061, 20212
Euro1 21962
Expressvu 21944
Fisher 20047, 20104, 20066, 20054
Fuji 20035, 20033
Fujitsu 20045, 20052, 20366
Funai 20000, 20593, 21593
Garrard 20000
Gateway 21972
GE 20060, 20035, 20240, 21060, 20202, 20760, 21035, 20807, 20226, 20761
General 20045, 20366, 20052
Go Video 20643, 20526, 20432
GOI 21944
GoldStar 20037, 20209, 20038, 20226, 20225, 21237
Gradiente 20000
Haojie 20240
Harley Davidson 20000
Harman/Kardon 20081, 20038
Harwood 20072, 20068
Hauppauge 21992
Headquarter 20046
Hewlett Packard 21972
HI-Q 20047
Hitachi 20037, 20000, 20042, 20041,

20166, 20105, 20089
Howard Computers 21972
HP 21972
HTS 21944
Hughes Network Sys 20042, 21949, 20739
Hyundai 21951
iBUYPOWER 21972
Jensen 20041
JVC 20045, 20067, 20041, 21945, 20008, 21944, 20384, 20366
KEC 20037, 20278
Kenwood 20067, 20041, 20038, 20384
KLH 20072
Kodak 20035, 20037
Kolin 20043, 20041
LG 20037, 20045, 20042, 20209, 20038, 22010, 21037, 20040
Lloyd's 20000, 20208
Logik 20072
LXI 20037
Magnasonic 21278, 20593
Magnavox 20035, 20039, 20081, 20000, 20593, 20563, 20110, 21781
Magnin 20240
Marantz 20035, 20081, 21381
Marta 20037
Matsushita 20035, 20162, 20226, 21162, 20367, 20227
Media Center PC 21972
MEI 20035
Memorex 20035, 20162, 20037, 20048, 20039, 20047, 20240, 20000, 20104, 20209, 21237, 20046, 20479, 21162, 20348, 21048, 21262, 20307, 21037
MGA 20240, 20043, 20061
MGN Technology 20240
Microsoft 21972
Mind 21972
Minolta 20042, 20105
Mitsubishi 20067, 20043, 20041, 20061, 20807, 20173
Motorola 20035, 20048
MTC 20240, 20000
Multitech 20000, 20072
NAD 20058
National 20226
NEC 20035, 20037, 20048, 20104, 20067, 20041, 20038, 20040, 20008, 20370
Newave 20037
Nikko 20037
Nikon 20253, 20034
Noblex 20240
Northgate 21972
Olympus 20035, 20226, 21046
Onkyo 20222
Optimus 21062, 20162, 20037, 20048, 20104, 21048, 21262, 20593, 21162, 20058, 20432
Optonica 20062
Orion 20184, 20209, 20002, 20479, 20295, 21479
Panarex 21950
Panasonic 21062, 20035, 20162, 20077, 20226, 20616, 21162, 20225, 20367, 20227, 21035, 21262
Pansat 21950
Penney 20035, 20037, 20240, 20042, 20038, 21035, 20040, 20054, 21237
Pentax 20042, 20105
Philco 20035, 20000, 20226, 20479
Philips 20035, 20081, 20000, 20226, 20739, 21381, 20110, 20618, 21181, 20563, 21081, 21949, 20062
Pilot 20037
Pioneer 20042, 20067, 20058
Polk Audio 20081
Profitronic 20240
Proscan 20060, 20760, 21954, 20202,

21060, 20761
Protec 20072
Pulsar 20039
Qisheng 20060
Quarter 20046
Quartz 20046
Quasar 20035, 20162, 21035, 20077, 21162
RadioShack 20000, 21037
Radix 20037
Randex 20037
RCA 20060, 20035, 20240, 20000, 20042, 20807, 21060, 21989, 20106, 20761, 21035, 20058, 21964, 20105, 20226, 20760, 20880, 21954, 20077, 20202, 20453
Realistic 20035, 20037, 20048, 20047, 20000, 20104, 20066, 20046, 20062
ReplayTV 20614, 20616
Ricoh 20253, 20034
Runco 20039
Sampo 20037, 20048
Samsung 20240, 20045, 20212, 20760, 20210, 20432, 21014
Samtron 20643
Sanky 20048, 20039
Sansui 20000, 20067, 20209, 20041, 20479, 20271, 21479
Sanyo 20047, 20240, 20104, 20046, 20159, 20369, 20368
Scott 20184, 20045, 20121, 20043, 20210, 20212
Sears 20035, 20037, 20047, 20000, 20042, 20104, 20046, 20066, 21237, 20054, 20105
Sharp 20048, 20209, 20363, 20848, 20807, 20062, 20738, 21048
Shinco 20000
Shintom 20072
Shogun 20240
Singer 20072
Sonic Blue 20614, 20616
Sony 20035, 20032, 20033, 20000, 20253, 20639, 21232, 21972, 20636, 21032, 21957, 20034, 20586, 20640, 21956
STS 20042
Sunpak 20253
Sylvania 20035, 20081, 20000, 20043, 20110, 21781, 21593, 20593
Symphonic 20000, 21593, 20593
Systemax 21972
Tagar Systems 21972
Tashiko 20037
Tatung 20045, 20067, 20041, 20366, 20008
Teac 20000, 20041
Technics 20035, 20162
Teco 20035, 20037, 20048, 20041, 20038, 20040
Teknika 20035, 20037, 20000, 20052
Thomas 20000
Tivo 20739, 21957, 20636, 21956, 20618, 21503
TMK 20240, 20208, 20036
Toshiba 20045, 20067, 20043, 20041, 20210, 20384, 21008, 21972, 20366, 20845, 21503, 20066, 20212, 20828, 21145, 20008
Totevision 20037, 20240
Touch 21972
UltimateTV 21989
Unitech 20240
Vector 20045
Vector Research 20038, 20040
Victor 20067, 20041, 20008, 20384
Video Concepts 20045, 20040, 20061
Video magic 20037
Videosonic 20240
Viewsonic 21972

APPENDIX B – PRESET MEMORY CODES continued ...

VCRs continued:

Villain	20000
Wards	20060, 20035, 20048, 20047, 20081, 20240, 20000, 20042, 20072, 20062, 20212, 20760
White Westinghouse	20209, 20072, 20637
XR-1000	20035, 20000, 20072
Yamaha	20041, 20038
Zenith	20039, 20033, 20000, 20209, 20034, 20479, 21479, 21139, 20637
ZT Group	21972

Video Accessories:

ABS	01272
Alienware	01272
CyberPower	01272
Gateway	01272
Hewlett Packard	01272, 01267
Howard Computers	01272
HP	01272
iBUYPOWER	01272
InterVideo	01393
Jensen	01165
JVC	01384
Keyspan	01344
KWorld	01403
LG	01415
Linksys	01365
Macro Image Tech	01383
Media Center PC	01272
Microsoft	01272
Mind	01272
Motorola	01363

MyHD	01383
Northgate	01272
Panasonic	01120
Pinnacle Systems	01268
Pioneer	01010
Princeton	00113, 00295
Rabbit	00081
Roku	01486
Samsung	01190, 01490
Sensory Science	01126
Sharp	01010
SMC	01456
Sony	01272, 01324, 01364
Streamzap	01309
Systemax	01272
Tagar Systems	01272
TeleCaption	00171
Toshiba	01272
Touch	01272
Viewsonic	01272, 01329
ZT Group	01272

SPECIFICATIONS

ANALOG VIDEO SWITCHING

Bandwidth from input jack to output jack (bypass mode for component video)	
Composite & S-Video	70 MHz
Component: Y	110 MHz
Pr	90 MHz
Pb	80 MHz

All analog video inputs and outputs are 75 Ω , 1.5 Vp-p.

ANALOG AUDIO

Input Impedance	20 k Ω
Output Impedance	
Main	300 Ω (RCA), 600 Ω (XLR)
Zone2/3 & Record	51 Ω
Rated Input	2.0 Vrms
Maximum Input	5.3 Vrms
Minimum Load	5 k Ω
Rated Output (100 k Ω load)	2.0 Vrms
Maximum Output	
RCA	6.3 Vrms
XLR	12.6 Vrms
Headphone Output	100 mW into 32 Ω at 0.2% THD+N
Volume Control Range	
Main	-95.5 to +31.5 dB in 0.5 dB increments
Zone2/3 and Headphone	-62.5 to +10.0 dB in 1.25 dB increments
Crosstalk (at 1 kHz)	82 dB between channels, 86 dB between inputs
XLR Pin Configuration	Pin 1: Ground, Pin 2: Positive, Pin 3: Negative

DIGITAL AUDIO

Crossover	
High-Pass Slope (Small Speaker Setting)	12 dB/octave (2nd order)
Low-Pass Slope (Subwoofer)	24 dB/octave (4th order)
Frequency (Adjustable)	25 to 160 Hz in 5 Hz increments
Tone Control	
Filter Type	Shelf
Range	\pm 12 dB
Bass Turnover Frequency	200 Hz
Treble Turnover Frequency	2 kHz

Analog to Digital Conversion S/N Ratio at digital Rec output (IEC-A filter)	100 dB
--	--------

All digital inputs and outputs comply with HDMI, S/PDIF, or AES/EBU standards. Sample rate converter output is 24-bit / 192 kHz regardless of input.

SPECIFICATIONS continued ...

MAIN Path (RCA & XLR output)

Frequency Response and Bandwidth

Analog-Direct Inputs	10 Hz to 20 kHz (+0, -0.2 dB), 1 Hz to 130 kHz (+0, -3 dB)
Analog-DSP Inputs at 24/96	10 Hz to 20 kHz (+0, -0.3 dB), 2 Hz to 44 kHz (+0, -3 dB)
Digital Inputs at 24/96	10 Hz to 20 kHz (+0, -0.2 dB), 1 Hz to 45 kHz (+0, -3 dB)

THD+N (at Rated Input & Output)

Analog-Direct Inputs	0.006% (80 kHz BW)
Analog-DSP Inputs at 24/48 or 24/96	0.004% (AES17 filter)
Digital Inputs at 24/48 or 24/96	0.004% (AES17 filter)

IMD (CCIF at 15 kHz & 16 kHz)

Analog-Direct Inputs	<0.001%
Analog-DSP Inputs at 24/48	0.001%
Digital Inputs at 24/48 or 24/96	0.001%

S/N Ratio (ref. 2.0 Vrms, IEC-A filter)

Analog-Direct Inputs	107 dB
Analog-DSP Inputs at 24/48 or 24/96	101 dB
Digital Inputs at 24/48 or 24/96	104 dB

ZONE2 and ZONE3 Paths

Frequency Response and Bandwidth 20 Hz to 20 kHz (+0, -0.1 dB), 3 Hz to 140 kHz (+0, -3 dB)

THD+N (at Rated Input & Output) 0.06% (80 kHz BW)

IMD (CCIF at 15 kHz & 16 kHz) 0.06%

S/N Ratio (ref. 2.0 Vrms, IEC-A filter) 97 dB

FM TUNER

Sensitivity

50 dB S/N	13 dB μ typ., 25 dB μ max.
IHF	10 dB μ typ., 20 dB μ max.

S/N Ratio

Mono	75 dB typ., 65 dB min.
Stereo	69 dB typ., 60 dB min.

Distortion

Mono	0.2% typ., 1.0% max.
Stereo	0.3% typ., 1.5% max.

Stereo Separation 40 dB typ., 25 dB min.

Adjacent Channel Selectivity (\pm 400 kHz) 70 dB typ., 60 dB min.

Frequency Response 25 Hz to 15 kHz (+0, -2 dB)

AM TUNER

Sensitivity (20 dB S/N) 49 dB μ typ., 56 dB μ max.

S/N Ratio 50 dB typ., 43 dB min.

Distortion 0.7% typ., 2.0% max.

One Signal Selectivity (\pm 10 kHz) 24 dB typ., 18 dB min.

SPECIFICATIONS continued ...

CONTROL

Infra Red

Carrier Frequency	38 kHz
Max. 12V Supply Current	150 mA
Max. Emitter Current	60 mA per output

RS-232 Interface

Connection	DB-9F, straight-wired
Pinout (Statement D2v side)	Pin 2: Tx, Pin 3: Rx, Pin 5: Ground
Baud rate	1200, 2400, 4800, 9600, 19200, 38400, 57600, 115200
Configuration	8 data bits, 1 stop bit, no parity bits, flow control (RTS/CTS, None)

Trigger Outputs

Polarity	tip positive, sleeve ground
Max. Current at 12 VDC	Triggers 1 and 2: 50 mA each, Trigger 3: 200 mA
Sequential Delay	250 ms

POWER REQUIREMENT

Consumption Maximum 170 W

Low voltage version: In countries where the line voltage is 120V, this product operates from a single phase AC power source that supplies between 108V and 132V at a frequency of 60 Hz.

High voltage version: In countries where the line voltage is 220, 230, or 240V, this product operates from a single phase AC power source that supplies between 216V and 264V at a frequency of 50 or 60 Hz.

DIMENSIONS

Height 5 7/8 in. (14.9 cm) including feet, rackmounting – 3 rack units without feet

Width Standard Version..... 19 1/4 in. (49 cm)
Rackmount Version 19 in. (48.3 cm)
No-Handle Version..... 17 1/4 in. (43.8 cm)

Depth 15 1/4 in. (38.7 cm)

Weight (unpacked, not including 8 lb (3.5 kg) ARC-1 microphone kit) 27 lb (12.3 kg)

WARRANTY

CANADA & USA

Anthem Electronics warrants to the original purchaser that each Anthem Statement D2v processor is free from defects in workmanship and materials during normal use for a period starting from the date of sale of three (3) years, except for video circuitry which is covered for two (2) years, and remote controls which are covered for one (1) year. During the warranty period, Anthem Electronics will repair or replace any defective components free of charge.

This warranty is not transferable unless the product is traded-in with an Authorized Anthem Dealer, who may resell the product with the remaining warranty if it is cosmetically acceptable, in perfect working condition, and has not been internally or externally altered.

Warranty is void if the Anthem product is not purchased from an Authorized Anthem Dealer, if the serial number has been removed, altered, or defaced, if the product has been operated or handled other than in accordance with the instructions in its Operating Manual or otherwise abused, misused, damaged by accident or while in transport, tampered with, modified, or repaired by anyone other than Anthem Electronics or an authorized Anthem Electronics service center. If inspection by Anthem Electronics discloses that the repair required is not covered by this warranty, regular repair charges shall apply.

Display products sold by an Authorized Anthem Dealer are covered under the same warranty terms, except that the warranty period commences from the date of the dealer invoice, not the purchaser's invoice, and cosmetic flaws, if there are any, are excluded.

If a problem or defect is discovered in your Anthem product, please contact your Authorized Anthem Dealer. It is the Dealer's responsibility to determine the nature of the problem and arrange for the appropriate replacement parts, or the return of the product to Anthem Electronics.

A Return Authorization (RA) number must be obtained from Anthem Technical Support before any product can be returned to Anthem Electronics for any reason. The RA Number must be clearly visible on the outside of the shipping carton for Anthem Electronics to accept the return. Product shipped to Anthem Electronics without a RA Number will be refused and returned to the sender, freight collect. Product shipped to Anthem Electronics for repair must have shipping and insurance prepaid by the sender, be packaged in the original carton and packing material, and should be accompanied by a written description of the defect. Anthem Electronics will accept no responsibility for any damage occurring to a product that is shipped in any type of carton and packing material other than the original carton and packing material.

To receive service under warranty, an accompanying copy of the original sales receipt is required. Product repaired under warranty will be returned with shipping and insurance prepaid by Anthem Electronics (within Canada and USA only). All other repairs are subject to charges for labor, parts, return shipping, and insurance.

Disclaimer of Liability

Under no circumstances does Anthem Electronics assume liability or responsibility for injury or damages sustained in the use or operation of Anthem products, or for damages to any other connected products.

In no event shall Anthem Electronics, its agents, representatives, or employees, be responsible for any incidental or consequential damages. Some jurisdictions do not allow limitations of incidental or consequential damages, so this exclusion may not apply to you.

Anthem Electronics reserves the right to make design changes or improvements to products without any obligation to revise prior versions. All specifications are subject to change without notice.

On the expiration of the warranty period all liability of Anthem Electronics in connection with the product shall terminate.

This warranty constitutes the only warranty applicable to products sold by Anthem Electronics. No other warranty or condition, statutory or otherwise, expressed or implied, shall be imposed upon Anthem Electronics, nor shall any representation made by any person, including a representation by a representative or agent of Anthem Electronics, be effective to extend the warranty coverage provided herein.

INTERNATIONAL

Outside of Canada and USA, terms and conditions are set and maintained by the Authorized Anthem Distributor, not Anthem Electronics.

THE BIG PICTURE FRONT PANEL

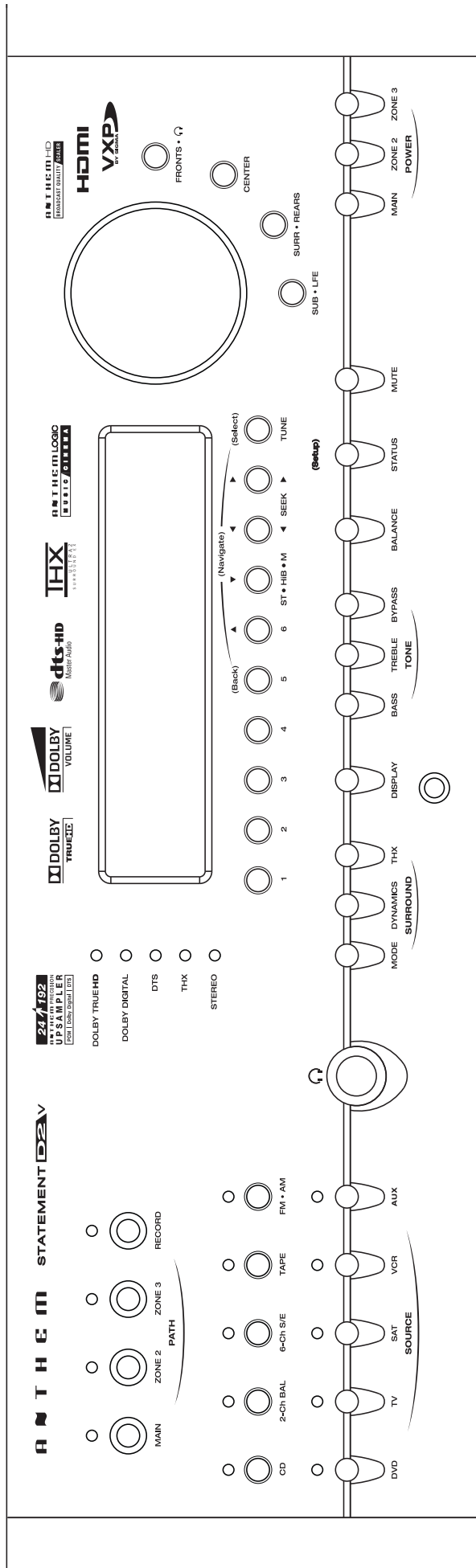

THE BIG PICTURE REAR PANEL

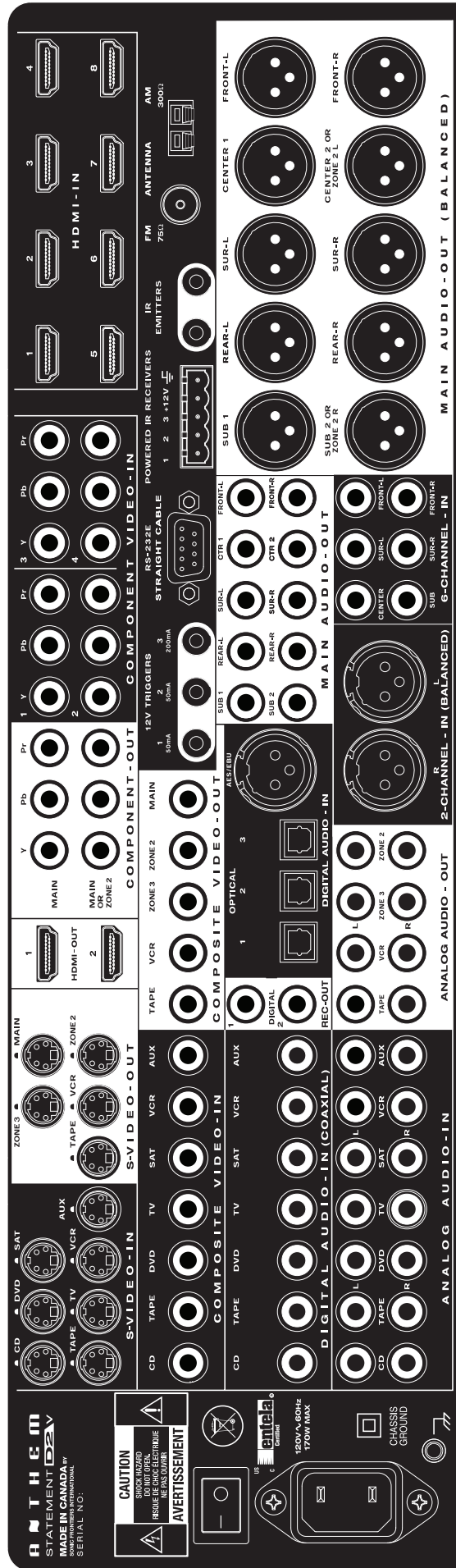



DESIGNED AND MANUFACTURED IN NORTH AMERICA

tel. (+1) 905-362-0958 M-F 9:00 am - 5:30 pm (ET)

www.anthemAV.com

Free Manuals Download Website

<http://myh66.com>

<http://usermanuals.us>

<http://www.somanuals.com>

<http://www.4manuals.cc>

<http://www.manual-lib.com>

<http://www.404manual.com>

<http://www.luxmanual.com>

<http://aubethermostatmanual.com>

Golf course search by state

<http://golfingnear.com>

Email search by domain

<http://emailbydomain.com>

Auto manuals search

<http://auto.somanuals.com>

TV manuals search

<http://tv.somanuals.com>