

FS-4000 Flat Screen Speaker System

3 high-performance speakers in one for today's flat screen technologies

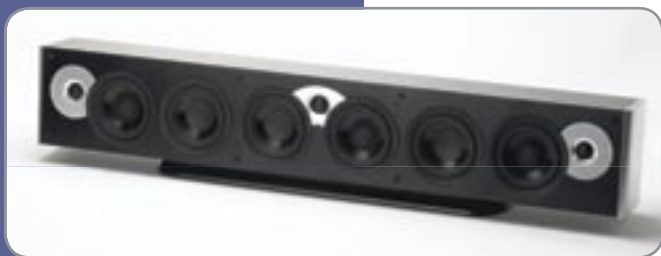

The decorative side panels are finished in a choice of automotive-grade Metallic Silver or a rich-looking Gloss Black paint.



Home Theater could be the most enjoyable, significant development in at-home entertainment to come along in a generation. Being able to literally "go to the movies" in one's own living room has completely transformed the experience of watching television.

Great sound is an integral, essential component to the theater experience at home. The downside for most people comes from having to mount and wire speakers all over their room. It's inconvenient, confusing, and unsightly.

Enter Atlantic's innovative FS-4000 Front Stage Loudspeaker. This sleek, 40"-long unit contains all three front speakers—left, center, and right—in a single enclosure. It's perfect for the growing number of customers who just want a simple, attractive, one-piece speaker

solution under their flat-screen television, without all the visual clutter of separate left, center, and right speakers surrounding their stylish, thin TV. The cabinet is internally separated into three chambers, each with a 1" tweeter, a 4½" magnetically-shielded woofer and a 4½" Bass Pressure Driver. Bass response extends down to 75Hz, for full-bodied sound even without a subwoofer.

All three speakers in the FS-4000 have two rear-panel controls—a 3-position HF Energy switch and a 2-position Boundary Compensation switch—to optimize the speakers' performance regardless of room acoustics or placement. These controls allow the FS-4000 to always sound its best.

The FS-4000 uses the same drivers and crossover technology as our highly-acclaimed 2200 and FS-3200 systems, so there is absolutely no compromise in

sound quality or tonal accuracy by having the three front channels in a single enclosure. With the FS-4000, it's now possible to enjoy the legendary Atlantic sound from speakers that blend right into the room.

FS-4000 Flat Screen Speaker System



Mounting Options

Five mounting options, included with speakers:

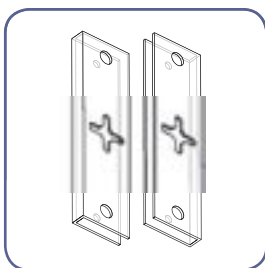

1. "Straight Ahead" wall bracket holds the speaker ½" off the wall pointing straight ahead.

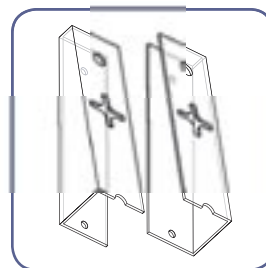

2. "Angled" wall bracket—angles the speaker up or down, depending on whether it's mounted above or below the video display.

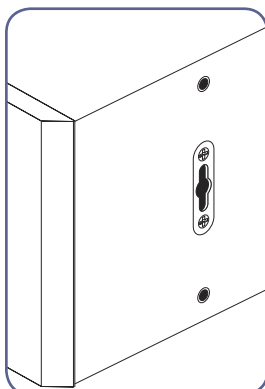

3. Keyhole mount (on the rear of the speaker), for simple flush wall mounting.

4. Atlantic's stud bracket can be used to anchor the FS-4000 from the wall studs to either the regular keyhole mount (as shown in option 3) or to the straight or angled brackets (as shown in options 1 and 2).

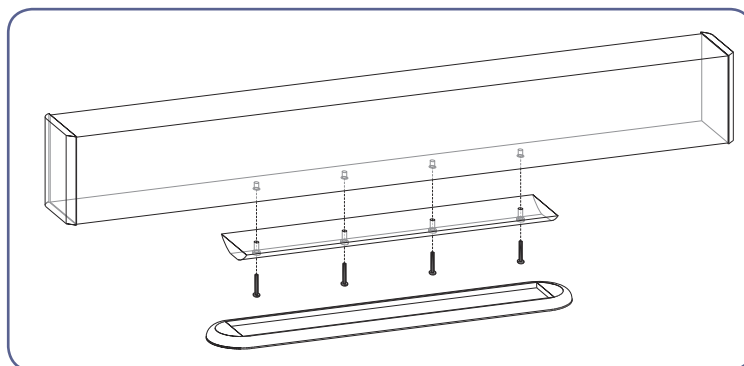
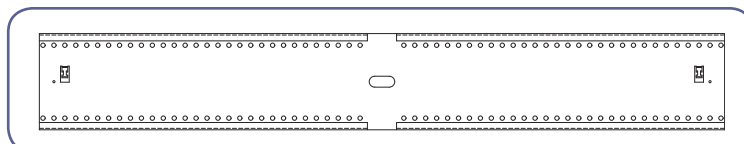

5. Using Atlantic's exclusive center channel rocker base, the FS-4000 can be used as a freestanding speaker on a TV or on a shelf in addition to wall mounting.



Notice that the FS-4000's tweeters are offset above the centerline of the woofers. This is a perfect example of the way that Atlantic pays close attention to acoustic details. By moving the tweeters up, we significantly reduce the audibly-intrusive interference patterns that result from woofers and tweeters being mounted side-by-side.

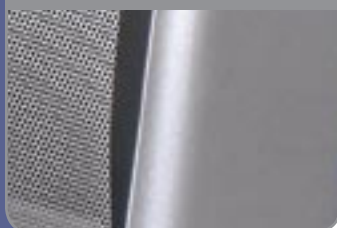

The decorative side panels are finished in a choice of automotive-grade metallic silver or a rich-looking Gloss Black paint.

Specifications

Type	2-way with Bass Pressure Drivers	Sensitivity	89dB
Drivers	Woofer (3) 4½" (115mm) GLH [§] (3) 4½" (115mm) Bass Pressure Drivers	Recommended Power	10 – 125 Watts RMS per channel
	Tweeter (3) 1" (25mm) soft dome	Magnetic Shielding	Yes
Frequency Response	75Hz – 20kHz ±3dB	Dimensions w/grille	40 x 6.5 x 5"*
Nominal Impedance	8 Ohms		1021 x 165 x 127mm
Crossover Frequency	3.75kHz, 3rd order	Weight	27lbs; 12.3kg

[§]Graphite Loaded Homopolymer

*Height without base. Add 1" height for base.

atlantic
TECHNOLOGY

©2005 Atlantic Technology • 343 Vanderbilt Ave.

Norwood, MA 02062 • 781.762.6300

www.atlanticttechnology.com

Free Manuals Download Website

<http://myh66.com>

<http://usermanuals.us>

<http://www.somanuals.com>

<http://www.4manuals.cc>

<http://www.manual-lib.com>

<http://www.404manual.com>

<http://www.luxmanual.com>

<http://aubethermostatmanual.com>

Golf course search by state

<http://golfingnear.com>

Email search by domain

<http://emailbydomain.com>

Auto manuals search

<http://auto.somanuals.com>

TV manuals search

<http://tv.somanuals.com>