



ATTO Technology, Inc.

---

# **ATTO FibreBridge Installation and Operation Manual**

**ATTO FibreBridge 2370E  
ATTO FibreBridge 2390C/R/D  
ATTO FibreBridge 2400C/R/D**

## **ATTO Technology, Inc.**

155 CrossPoint Parkway  
Amherst, New York 14068 USA

[www.attotech.com](http://www.attotech.com)

Tel (716) 691-1999

Fax (716) 691-9353

Sales support: [sls@attotech.com](mailto:sls@attotech.com)

Technical support: Monday -- Friday, 8am-8pm EST  
[techsupp@attotech.com](mailto:techsupp@attotech.com)

© 2007 ATTO Technology, Inc. All rights reserved. All brand or product names are trademarks of their respective holders. No part of this manual may be reproduced in any form or by any means without the express written permission of ATTO Technology, Inc.

9/2007

PRMA-0362-000

# Contents

---

<b>1.0 ATTO FibreBridge provides storage options .....</b>	<b>1</b>
ATTO FibreBridge 2370E features, benefits	
ATTO FibreBridge 2390C/R/D features, benefits	
ATTO FibreBridge 2400C/R/D features, benefits	
<b>1.1 ATTO FibreBridge 2370E .....</b>	<b>3</b>
Board dimensions	
Cooling and airflow	
Power	
Fibre Channel port	
SCSI ports	
Management access	
LED indicators	
<b>1.2 ATTO FibreBridge 2390R/D .....</b>	<b>5</b>
Dimensions	
Cooling and airflow	
Power	
Fibre Channel interface	
SCSI ports	
Management ports	
Manual reset switch	
LED indicators	
<b>1.3 ATTO FibreBridge 2390C .....</b>	<b>7</b>
Board dimensions	
Cooling and airflow	
Power	
Fibre Channel port	
SCSI ports	
Management access	
Manual reset switch	
LED indicators	
<b>1.4 ATTO FibreBridge 2400R/D .....</b>	<b>9</b>
Dimensions	
Cooling and airflow	
Power	
Fibre Channel port	
SCSI ports	
Management ports	
Manual reset switch	
LED indicators	
<b>1.5 ATTO FibreBridge 2400C .....</b>	<b>11</b>
Board dimensions	
Cooling and airflow	
Power	
Fibre Channel port	
SCSI ports	
Management access	
LED indicators	

<b>2.0 Installing the FibreBridge .....</b>	<b>13</b>
Unpack the packing box; verify contents	
Install the FibreBridge	
Discover the IP address	
Internet Explorer setup	
Begin initial configuration	
<b>3.0 Configuring the FibreBridge .....</b>	<b>15</b>
Preliminary steps	
Port configurations	
Modify passwords	
Enhance performance	
<b>3.1 Map devices .....</b>	<b>17</b>
FibreBridge mapping	
SCSI device mapping	
Mapping devices automatically	
Mapping devices manually.	
Multiple Node addressing (FB2400 only)	
<b>3.2 Remote monitoring, management .....</b>	<b>19</b>
SNMP-based monitoring	
Email messages provide error notification	
<b>4.0 Updating firmware .....</b>	<b>23</b>
Preliminary step	
Using ExpressNAV	
Using FTP	
Using the zModem command	
<b>5.0 Interface options .....</b>	<b>25</b>
Using ExpressNAV	
Opening an ExpressNAV session	
Optimizing ExpressNAV in Internet Explorer	
Using the serial port	
Using Telnet	
<b>Appendix A Cabling .....</b>	<b>i</b>
SCSI port connections	
Fibre Channel connections	
Serial port connections	
Ethernet connections	
<b>Appendix B CLI provides ASCII-based interface .....</b>	<b>ii</b>
CLI error messages	
CLI summary reference	
Command explanations	
<b>Appendix C Standards and compliances .....</b>	<b>xvii</b>
FCC Standards: Radio and Television Interference	
Canadian Standards	
European Standards	
Declaration of Conformity	
Certification for the FibreBridge 2400 only	

**Appendix D Warranty information .....xix**

Manufacturer limited warranty

# 1.0 ATTO FibreBridge provides storage options

*The ATTO FibreBridge™ family of products provides Fibre Channel-to-SCSI bridges as embeddable boards, stand alone enclosures that can be fitted for rack mount integration, or desktop units.*

Fibre Channel is a serial communications technology designed to transfer large amounts of data between a variety of hardware systems over long distances. It is a key technology for applications that require shared, high bandwidth access to storage.

Fibre Channel provides a logical point-to-point serial channel for the transfer of data between a buffer at a source device and a buffer at a destination device. It moves buffer contents from one port to another, without regard to the format or meaning of the data, so different upper level

protocols are able to run over Fibre Channel hardware.

All ATTO FibreBridge models can be used in a SAN (Storage Area Network) to connect a variety of Fibre Channel and SCSI devices. A SAN is a shared storage architecture connecting computers and storage devices for online data access. Each connected system can directly access any attached storage device.

The ATTO FibreBridge provides the interface between SCSI and Fibre Channel resources in SANs. Possible configurations depend upon your current hardware.

## ATTO FibreBridge 2370E features, benefits

The ATTO FibreBridge 2370E is a Fibre Channel-to-SCSI bridge that offers a high-performance architecture supporting next-generation storage media. The FibreBridge 2370E allows users with SCSI storage to add Fibre Channel connectivity, enabling SAN connectivity for the storage system. With industry-leading support for 4-Gigabit Fibre Channel and Ultra320 SCSI, the FibreBridge 2370E provides the throughput required by advanced storage media in an embeddable form factor for easy integration into SCSI devices.

- One 4-Gb Fibre Channel port which auto-negotiates to 1-Gb, 2-Gb or 4-Gb Fibre Channel

- SFP Fibre Channel connector
- Support for direct connect to F-port fabric switches, full duplex FC data transfers and FC-AL, PLDA and public loop login
- Two independent Ultra320 SCSI connections using standard 68-pin internal SCSI connectors
- Backward compatible with all single-ended SCSI devices and previous SCSI protocols
- Manual and auto SCSI device mapping
- 200 MB/sec. maximum throughput
- ExpressNAV™ integrated management console for remote configuration, management and diagnostic capabilities
- Supports SCSI hard disk drives, tape drives and CD libraries
- RoHS compliant

## ATTO FibreBridge 2390C/R/D features, benefits

---

The ATTO FibreBridge 2390C/R/D is a 4-Gigabit Fibre Channel-to-SCSI bridge configured with a single 4-Gb Fibre Channel port and dual-stacked Ultra320 SCSI buses featuring VHDCI interfaces.

Designed to integrate industry-leading performance and SAN capabilities into advanced storage solutions, the FibreBridge 2390 uses a high performance architecture suited for tape automation OEMs who wish to integrate high performance LTO-3 and SDLT600 tape drives into 4-Gb Fibre Channel SANs, as well as disk OEMs looking to add 4-Gb Fibre Channel connectivity to their disk storage devices.

- One 4-Gb Fibre Channel port which auto-negotiates to 1-Gb, 2-Gb or 4-Gb Fibre Channel

- SFP FC connector
- Support for direct connect to F-port fabric switches, full duplex FC data transfers and FC-AL, PLDA and public look login
- Two independent Ultra320 SCSI buses
- Dual-stacked VHDCI SCSI connectors
- Backward compatible with all single-ended SCSI devices and all previous SCSI protocols
- Manual and auto SCSI device mapping
- 215 MB/sec. maximum throughput
- ExpressNAV integrated management console for remote configuration, management and diagnostic capabilities
- Supports SCSI hard disk drives, tape drives and CD libraries

## ATTO FibreBridge 2400C/R/D features, benefits

---

The ATTO FibreBridge 2400C/R/D is a 4-Gigabit Fibre Channel-to-SCSI bridge configured with dual independent 4-Gb Fibre Channel ports and dual-stacked Ultra320 SCSI buses featuring VHDCI interfaces.

Designed to integrate industry-leading performance and SAN capabilities into future generation storage solutions, the FibreBridge 2400 uses a high performance architecture suited for tape automation OEMs who wish to integrate high performance LTO-3 and SDLT600 tape drives into 4-Gb Fibre Channel SANs, as well as disk OEMs looking to add 4-Gb Fibre Channel connectivity to their disk storage devices.

- Two independent 4-Gb Fibre Channel ports which auto-negotiate to 1-Gb, 2-Gb or 4-Gb Fibre Channel

- SFP FC connectors
- Support for direct connect to F-port fabric switches, full duplex FC data transfers and FC-AL, PLDA and public look login
- Two independent Ultra320 SCSI buses
- Dual-stacked VHDCI SCSI connectors
- Backward compatible with all single-ended SCSI devices and all previous SCSI protocols
- Manual and auto SCSI device mapping
- 440 MB/sec. maximum throughput
- ExpressNAV integrated management console for remote configuration, management and diagnostic capabilities
- Supports SCSI hard disk drives, tape drives and CD libraries

## 1.1 ATTO FibreBridge 2370E

The ATTO FibreBridge 2370E is a 4-Gigabit Fibre Channel to SCSI bridge offering the ability to add 4-Gigabit Fibre Channel connectivity to Ultra320 SCSI devices.

The FibreBridge 2370E is available in an embeddable card for easy integration into storage devices.

Default values are appropriate for most applications. Refer to [Configuring the FibreBridge](#) on page 15 for more information.

### Board dimensions

**Width:** 3.9 inches

**Length:** 7.995 inches

**Height of tallest component:** .55 inches on top, 0.1 inches on bottom

### Cooling and airflow

**Operating temperature:** 0-40 °C

**Humidity:** 10-90% non-condensing

### Power

The FibreBridge board is powered from a standard 4-pin disk drive power connector.

4-pin power connector  
**+12V GND GND +5V**

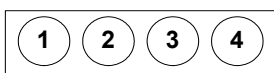

### Input voltage and

**power draw:** 5.0V = 10 Watts, 12V = 24 Watts

### Fibre Channel port

The 4-Gb Fibre Channel port uses a Small Formfactor Pluggable (SFP) interface. Its rate is set to automatic detection by default.

### SCSI ports

The two independent SCSI ports are Ultra320 SCSI busses with internal HD68 connectors, downward compatible with all forms of single-ended SCSI and all previous SCSI protocols.

### Management access

The 10/100 Base T Ethernet port is accessible from the RJ-45 connector to provide local and remote diagnostics, monitoring and management.

A serial 10-pin header provides support for an RS-232 remote monitoring and management port through the

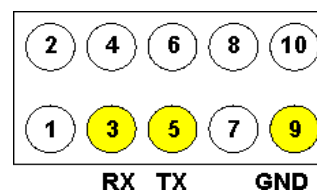

Command Line Interface. The baud rate is programmable and preset at the factory to 115200 bps.

### LED indicators

On-board LED indicators are on the board front or LED headers may be connected to outside panels.

**SCSI ports:** a green LED indicates activity if it is lit, no activity if it is off.

**Fibre Channel port:** A green LED indicates activity if it is lit, no activity if it is off. A separate green LED indicates speed: you may set the LED to signify 1 Gb/sec or 2 Gb/sec if it is off or 4 Gb/sec or 2 Gb/sec if it is on. Refer to [FCSpeedLED2G \(FB2370E\)](#) on page ix of the Appendix.

**A Ready LED** lights green to indicate ready and is off to indicate not ready.

**A Power Status LED** is on to indicate 5V and 12V are applied to the board; flashing green indicates that 12V is applied but 5V is not.

**A Yellow LED indicates fault status:** off means not faulted; on means faulted status.

**Embedded in the Ethernet port connector:** a lighted green LED shows a valid link; off indicates that no link is present. A separate blinking yellow LED indicates activity.



**LED Header P5 Pins**

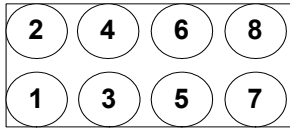

- 1 Ready LED Cathode
- 2 VDD 3.3
- 3 Power OK LED Cathode
- 4 VDD 3.3
- 5 Fault LED Cathode
- 6 VDD 3.3
- 7 NC
- 8 NC

**LED Header P6 Pins**

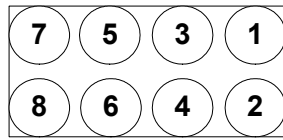

- 1 SCSI Port 1 Activity LED Cathode
- 2 VDD 3.3
- 3 SCSI Port 2 Activity LED Cathode
- 4 VDD 3.3
- 5 Fibre Channel Port Speed LED Cathode
- 6 VDD 3.3
- 7 Fibre Channel Port Activity LED Cathode
- 8 VDD 3.3

*Exhibit 1.1-1 FibreBridge 2370E board layout*

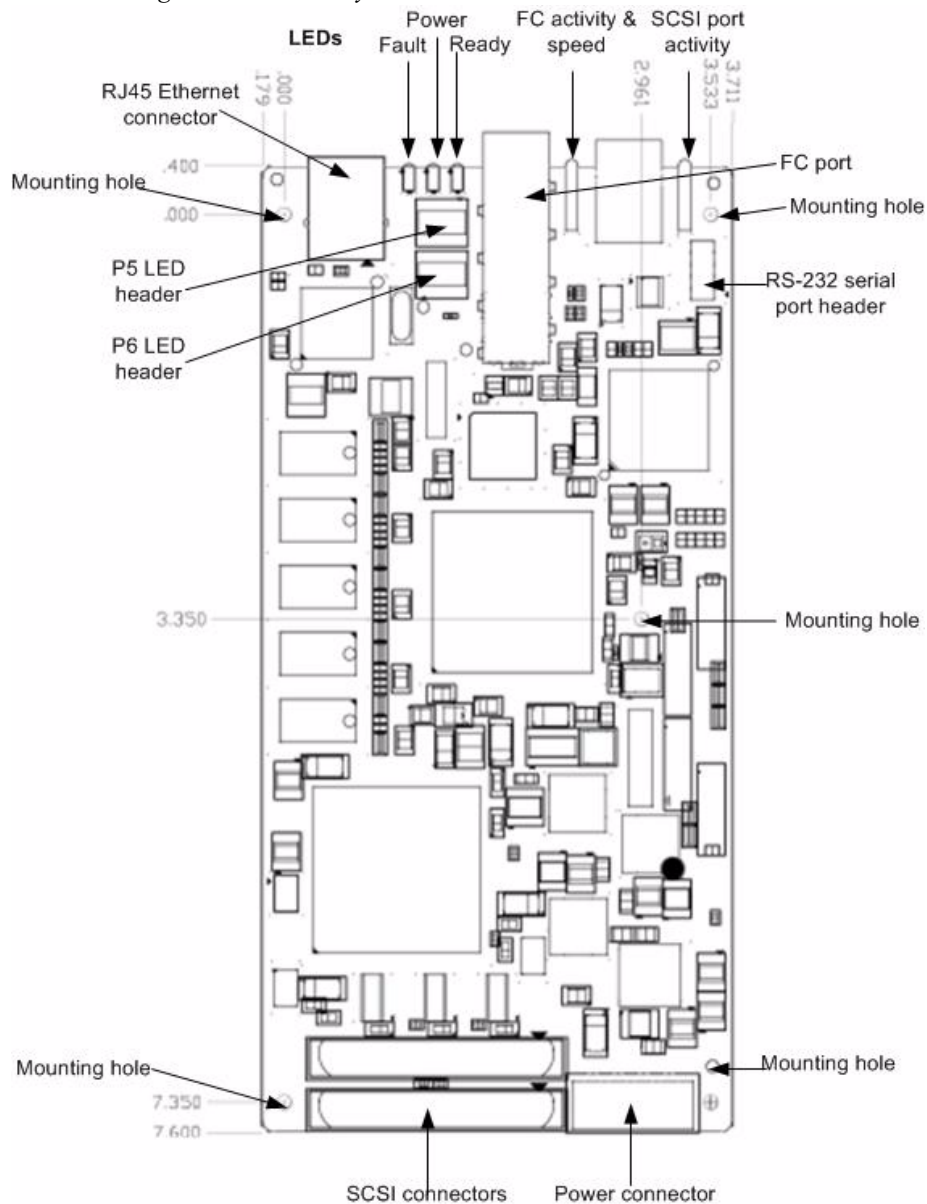

## 1.2 ATTO FibreBridge 2390R/D

The ATTO FibreBridge 2390R/D is a 4-Gigabit Fibre Channel to SCSI bridge offering the ability to add 4-Gigabit Fibre Channel connectivity to Ultra320 SCSI devices.

The FibreBridge 2390R/D is available in an industry-standard IU form factor for easy integration into racks. The advanced connectivity options make it suitable to support next-generation storage media such as LTO-3 and SDLT600.

Default values are appropriate for most applications. Refer to [Configuring the FibreBridge](#) on page 15 for more information.

### Dimensions

**Width:** 16.494 inches

**Length:** 10 inches

**Height:** 1.579 inches (1U)

**Weight:** approximately 10 pounds

### Cooling and airflow

**Operating temperature:** 0-40 °C external

**Humidity:** 10-90% non-condensing

Air enters from the front and is exhausted out the connector side. Ambient air near the inlets should not exceed 40 °C. The unit automatically stops operation if the temperature goes beyond this threshold.



### CAUTION

**Do not block the enclosure's vents. The FibreBridge does not allow data transfer if overheating occurs.**

### Power

The power supply circuit is permanently mounted within the enclosure and is not hot swappable. It has one standard IEC320 power receptacle and switch.

The universal power supply provides power for the bridge board and cooling fan.

The power requirements of the ATTO FibreBridge 2390R plus the power draw of the other equipment in the rack must not overload the supply circuit and/or wiring of the rack.

**Input voltage:** 110/230V AC, with operating input range of 90-132V AC or 175-264V AC, 100-240 VAC; 1.7-.7A, 50-60Hz.

### Battery-backed event log SRAM & Real-Time-Clock:

A rechargeable Lithium ion battery cell holds the memory in a 512KB SRAM for up to 30 days.



### WARNING

**Risk of explosion if the battery is removed and/or replaced by an incorrect type. Dispose of used batteries in accordance with your local environmental regulations.**



### WARNUNG

**Explosionsgefahr, wenn die Batterie falsch entfernt und/oder ersetzt wird. Entsorgen Sie benutzte Batterien in Übereinstimmung mit Ihren lokalen Umweltschutzbestimmungen.**

If the FibreBridge becomes disconnected from power, recharging begins automatically when power is restored to the system. The battery is fully charged after 24 hours of continuous power application.

### Fibre Channel interface

The optical SFP 4-Gb Fibre Channel port auto-negotiates to 1-Gb, 2-Gb or 4-Gb devices.

### SCSI ports

The two independent SCSI ports are Ultra320 SCSI busses with VHDCI connector, downward compatible with all forms of single-ended SCSI and all previous SCSI protocols.

### Management ports

The 10/100 Base T Ethernet port is accessible from the RJ-45 connector to support local and remote diagnostics, monitoring and management.

The RS-232 serial port provides support for remote monitoring and management using a DB9 connector. The baud rate is programmable and preset at the factory to 115200 bps.

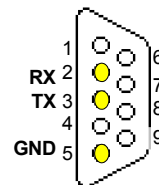

## Manual reset switch

A manual reset switch reboots the FibreBridge. To reset the FibreBridge, depress the reset button for no more than three seconds. To restore factory defaults, press the reset button for more than four seconds until the green **Ready** LED blinks.

## LED indicators

The LED indicators can be viewed from the connector (back) side and the front side of the FibreBridge 2390R/D. (See Exhibit 1.2-1)

LEDs on the connector (back) side are:

**A bicolor Ready/Fault LED** lights green to indicate ready, lights yellow to show a faulted condition, and is off to indicate not ready.

**Embedded in the Ethernet port connector:** a lighted green LED shows a valid link; off indicates

that no link is present. A separate blinking yellow LED indicates activity.

**Fibre Channel port:** A lighted green LED indicates link; off means no link. A separate green LED indicates activity if it is lit, no activity if it is off.

**SCSI ports:** A green LED on each port indicates activity if it is lit.

LEDs on the front panel are:

**A bicolor Ready/Fault LED** is lighted green to indicate ready, lighted yellow to show a faulted condition, and off indicates not ready.

**SCSI ports:** A green LED on each port indicates activity if it is lit.

**Fibre Channel port:** bicolor LED indicates FC speed. If it is off, speed is 1-Gb; if it is green, 2-Gb, and yellow indicates 4-Gb FC. A separate green LED indicates activity if it is lit, no activity if it is off.

Exhibit 1.2-1 Fibre Bridge 2390R/D dimensions with front panel LEDs and connector side details

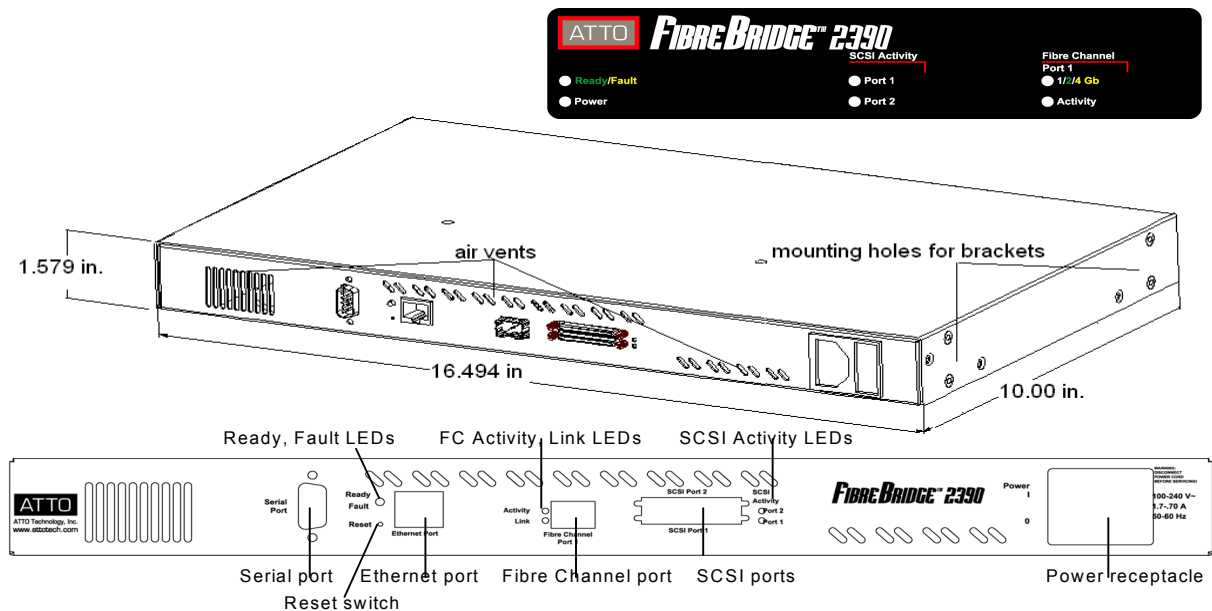

# 1.3 ATTO FibreBridge 2390C

The ATTO FibreBridge 2390C is a 4-Gigabit Fibre Channel to SCSI bridge offering the ability to add 4-Gigabit Fibre Channel connectivity to Ultra320 SCSI storage devices.

The FibreBridge 23900C is available in an industry-standard 4U cPCI card. Default values are appropriate for most applications. Refer to [Configuring the FibreBridge](#) on page 15 for more information.

### Board dimensions

- Width:** 6.1939 inches
- Length:** 6.299 inches
- Height of tallest component:** .545 inches

### Cooling and airflow

- Operating temperature: 0-40 °C
- Humidity: 10-90% non-condensing

### Power

The FibreBridge board may be powered from the cPCI backplane connector or a 6-pin connector.

- Input voltage:** 5.0V
- Power draw:** 30 Watts

**Battery-backed event log SRAM & Real-Time-Clock:** A rechargeable Lithium ion battery cell holds the memory in a 512KB SRAM for up to 30 days.

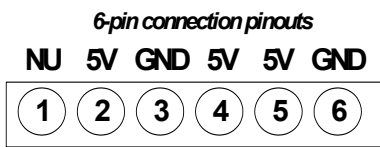

**⚠ WARNING**  
**Risk of explosion if the battery is removed and/or replaced by an incorrect type. Dispose of used batteries in accordance with your local environmental regulations.**

**⚠ WARNUNG**  
**Explosionsgefahr, wenn die Batterie falsch entfernt und/oder ersetzt wird. Entsorgen Sie benutzte Batterien in Übereinstimmung mit Ihren lokalen Umweltschutzbestimmungen.**

If the FibreBridge becomes disconnected from power, recharging begins automatically when power is restored to the system. The battery is fully charged after 24 hours of continuous power application.

### Fibre Channel port

The 4-Gb Fibre Channel port uses a Small Formfactor Pluggable (SFP) interface.

### SCSI ports

The two SCSI ports connect storage devices into the Fibre Channel Storage Area Network (SAN). Each port is totally independent from the other. The ports are Ultra320 SCSI busses with VHDCI connectors, downward compatible with all forms of single-ended SCSI and all previous SCSI protocols.

### Management access

The 10/100 Base T Ethernet port is accessible from the RJ-45 connector to support local and remote diagnostics, monitoring and management.

A serial 10-pin header provides support for an RS-232 remote monitoring and management port through a Command Line Interface. The baud rate is programmable and preset at the factory to 115200 bps.

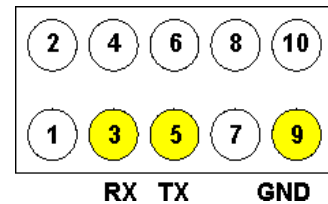

### Manual reset switch

A manual reset switch reboots the FibreBridge. To reset the FibreBridge, depress the reset button for no more than three seconds. To restore factory defaults, press the reset button for more than four seconds until the green **Ready** LED blinks.

### LED indicators

The on-board LED indicators show through the faceplate and follow left to right.  
**SCSI ports:** a green LED indicates activity if it is lit, no activity if it is off.  
**Fibre Channel port:** A lighted green LED indicates link; off means no link. A separate green LED indicates activity if it is lit, no activity if it is off.

**Embedded in the Ethernet port connector:** a lighted green LED shows a valid link; off indicates that no link is present. A separate blinking yellow LED indicates activity.

**A bicolor Ready/Fault LED** lights green to indicate ready, lights yellow to show a faulted condition, and is off to indicate not ready. FibreBridge 2400C bracket detail and board layout

Exhibit 1.3-1 The FibreBridge 2390C connectors and LEDs.

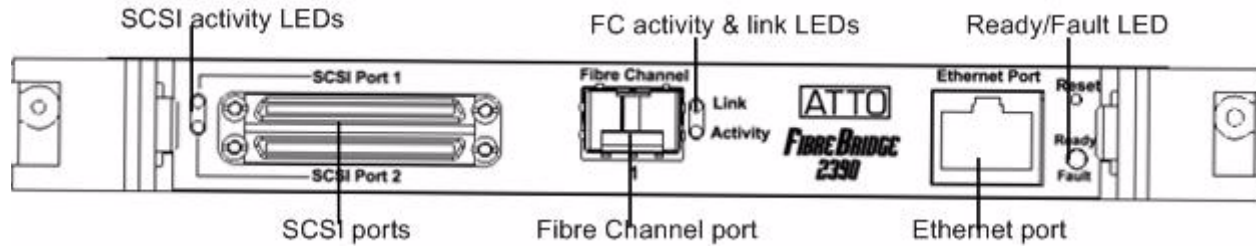
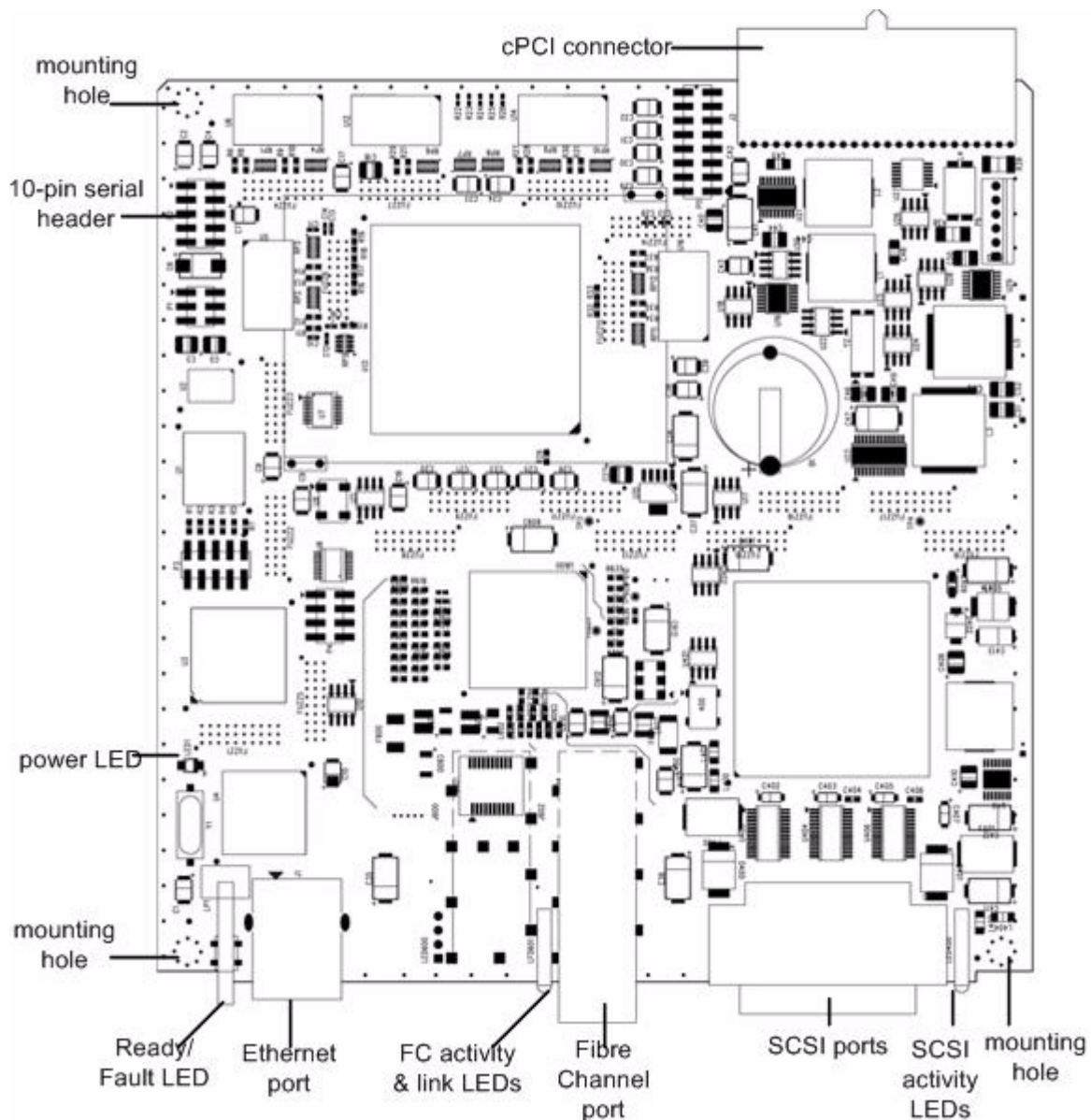

Exhibit 1.3-2 The FibreBridge 2390C board layout.



## 1.4 ATTO FibreBridge 2400R/D

The ATTO FibreBridge 2400R/D is a high performance bridge adding 4-Gigabit Fibre Channel connectivity to legacy SCSI storage devices.

The FibreBridge 2400R/D is available in an industry-standard 1U form factor for easy integration into racks.

Default values are appropriate for most applications. Refer to [Configuring the FibreBridge](#) on page 15 for more information.

### Dimensions

**Width:** 17 inches

**Length:** 11 inches

**Height:** 1.7 inches (1U)

**Weight:** approximately 10 pounds

### Cooling and airflow

**Operating temperature:** 0-40 °C external

**Humidity:** 10-90% non-condensing

Air enters from the front and is exhausted out the connector side. Ambient air near the inlets should not exceed 40°C. The unit automatically stops operation if the temperature goes beyond this threshold.



### CAUTION

**Do not block the enclosure's vents. The FibreBridge does not allow data transfer if overheating occurs.**

### Power

The power supply circuit is permanently mounted within the enclosure and is not hot swappable. It has one standard IEC320 power receptacle and switch.

The universal power supply provides power for the bridge board and cooling fan.

The power requirements of the ATTO FibreBridge 2400R plus the power draw of the other equipment in the rack must not overload the supply circuit and/or wiring of the rack.

**Input voltage:** 100-240 VAC; 1.7-.7A; 50-60Hz.

### Battery-backed event log SRAM & Real-Time-

**Clock:** A rechargeable Lithium ion battery cell holds the memory in a 512KB SRAM for up to 30 days.



### WARNING

**Risk of explosion if the battery is removed and/or replaced by an incorrect type. Dispose of used batteries in accordance with your local environmental regulations.**



### WARNUNG

**Explosionsgefahr, wenn die Batterie falsch entfernt und/oder ersetzt wird. Entsorgen Sie benutzte Batterien in Übereinstimmung mit Ihren lokalen Umweltschutzbestimmungen.**

If the FibreBridge becomes disconnected from power, recharging begins automatically when power is restored to the system. The battery is fully charged after 24 hours of continuous power application.

### Fibre Channel port

The dual independent 4-Gigabit Fibre Channel ports can connect the FibreBridge to either a Fabric or Arbitrated Loop using a Small Formfactor Pluggable (SFP) interface. The FibreBridge 2400R/D auto negotiates with 1-Gb, 2-Gb and 4-Gb/sec. devices

### SCSI ports

The two SCSI ports connect storage devices into the Fibre Channel Storage Area Network (SAN). Each port is totally independent from the other.

The ports are Ultra320 SCSI busses with VHDCI connector, downward compatible with all forms of single-ended SCSI and all previous SCSI protocols.

### Management ports

The 10/100 Base T Ethernet port is accessible from the RJ45 connector to support local and remote diagnostics, monitoring and management.

The RS-232 serial port provides support for remote monitoring and management using a DB9 connector. The baud rate is programmable and preset at the factory to 115200 bps.

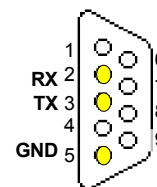

## Manual reset switch

A manual reset switch reboots the FibreBridge.

To reset the FibreBridge, depress the reset button for no more than three seconds.

To restore factory defaults, press the reset button for more than four seconds until the green Ready LED blinks.

## LED indicators

The LED indicators can be viewed from the connector side and the front side of the FibreBridge 2400R/D. (See Exhibit 1.4-1)

LEDs on the connector side are:

**A bicolor Ready/Fault LED** lights green to indicate ready, lights yellow to show a faulted condition, and is off to indicate not ready.

**Embedded in the Ethernet port connector:** a lighted green LED shows a valid link; off indicates

that no link is present. A separate blinking yellow LED indicates activity.

**Fibre Channel port:** A lighted green LED indicates link; off means no link. A separate green LED indicates activity if it is lit, no activity if it is off.

**SCSI ports:** A green LED on each port indicates activity if it is lit.

LEDs on the faceplate are:

**A bicolor Ready/Fault LED** is lighted green to indicate ready, lighted yellow to show a faulted condition, and off indicates not ready.

**SCSI ports:** A green LED on each port indicates activity if it is lit.

**Fibre Channel port:** bicolor LED indicates FC speed. If it is off, speed is 1-Gb; if it is green, 2-Gb, and yellow indicates 4-Gb FC. A separate green LED indicates activity if it is lit, no activity if it is off.

Exhibit 1.4-1 Connectors, LEDs and power receptacle on the connector side and LEDs on the faceplate

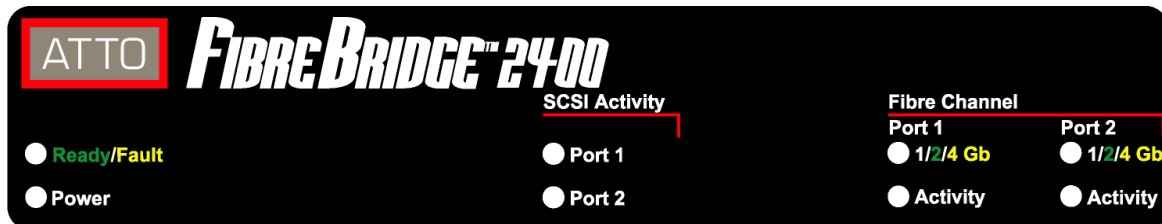
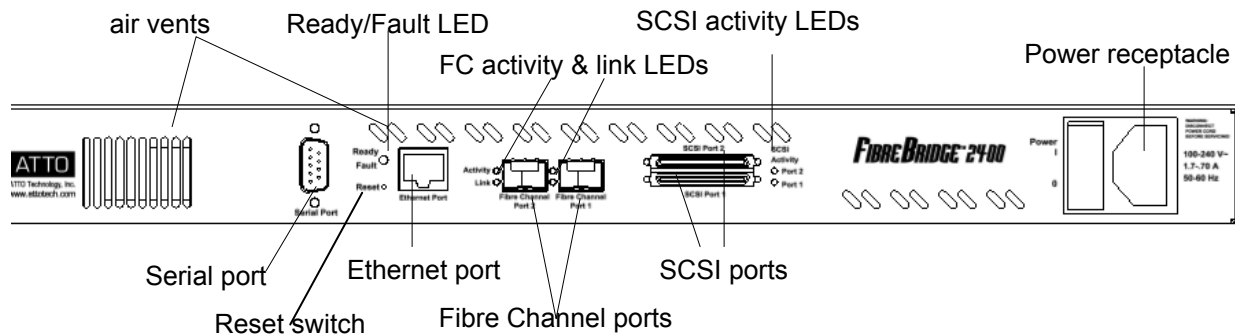

# 1.5 ATTO FibreBridge 2400C

The ATTO FibreBridge 2400C is a high performance bridge adding 4-Gigabit Fibre Channel connectivity to legacy SCSI storage devices.

The FibreBridge 2400C is available in an industry-standard 4U cPCI card for easy integration into storage devices. Default values are appropriate for most applications. Refer to [Configuring the FibreBridge](#) on page 15 for more information.

### Board dimensions

**Width:** 6.1939 inches

**Length:** 6.299 inches

**Height of tallest component:** .545 inches

### Cooling and airflow

Operating temperature: 0-40 °C

Humidity: 10-90% non-condensing

### Power

The FibreBridge board may be powered from the cPCI backplane connector or a 6-pin connector.

**Input voltage:** 5.0V

**Power draw:** 30 Watts

### Battery-backed event log SRAM & Real-Time-Clock:

A rechargeable Lithium ion battery cell holds the memory in a 512KB SRAM for up to 30 days.



#### WARNING

**Risk of explosion if the battery is removed and/or replaced by an incorrect type. Dispose of used batteries in accordance with your local environmental regulations.**



#### WARNUNG

**Explosionsgefahr, wenn die Batterie falsch entfernt und/oder ersetzt wird. Entsorgen Sie benutzte Batterien in Übereinstimmung mit Ihren lokalen Umweltschutzbestimmungen.**

If the FibreBridge becomes disconnected from power, recharging begins automatically when power is restored to the system. The battery is fully charged after 24 hours of continuous power application.

6-pin connection pinouts

NU 5V GND 5V 5V GND

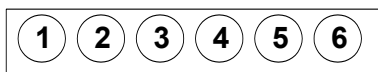

### Fibre Channel port

The dual independent 4-Gb Fibre Channel ports can connect the FibreBridge to either a Fabric or Arbitrated Loop using a Small Formfactor Pluggable (SFP) interface. The FibreBridge auto negotiates with 1-Gb, 2-Gb and 4-Gb/sec. devices

### SCSI ports

The two SCSI ports connect storage devices into the Fibre Channel Storage Area Network (SAN). Each port is totally independent from the other.

The ports are Ultra320 SCSI busses with VHDCI connectors, downward compatible with all forms of single-ended SCSI and all previous SCSI protocols.

### Management access

The 10/100 Base T Ethernet port is accessible from the RJ-45 connector to support local and remote diagnostics, monitoring and management.

A serial 10-pin header provides support for an RS-232 remote monitoring and management port through a Command Line Interface. The baud rate is programmable and preset at the factory to 115200 bps.

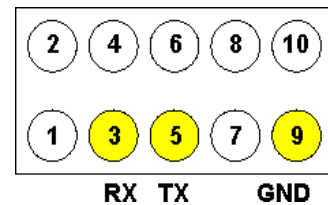

### LED indicators

The on-board LED indicators show through the faceplate and follow left to right.

**SCSI ports:** a green LED indicates activity if it is lit, no activity if it is off.

**Fibre Channel port:** A lighted green LED indicates link; off means no link. A separate green LED indicates activity if it is lit, no activity if it is off.

**Embedded in the Ethernet port connector:** a lighted green LED shows a valid link; off indicates that no link is present. A separate blinking yellow LED indicates activity.

**A bicolor Ready/Fault LED** lights green to indicate ready, lights yellow to show a faulted condition, and is off to indicate not ready.



Exhibit 1.5-1 FibreBridge 2400C bracket detail and board layout

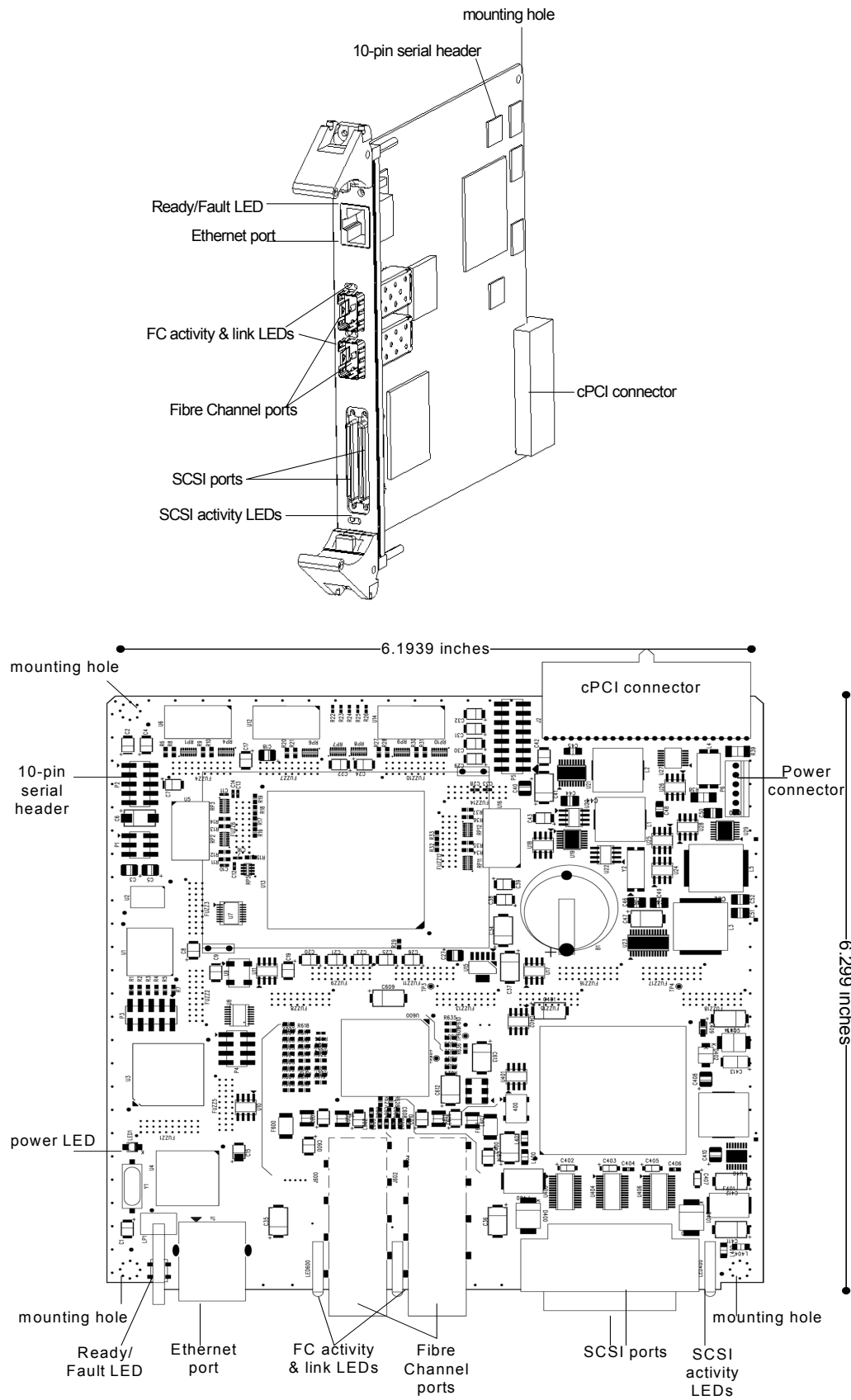

## 2.0 Install the FibreBridge

If you have not already completed the instructions on the *Quick Start* page packed with your FibreBridge, use the following instructions to install the FibreBridge.

### Unpack the packing box; verify contents

- The FibreBridge. Note the serial number of your FibreBridge unit: \_\_\_\_\_
- Power cord
- “L” brackets for mounting in a 19” rack
- Ethernet cable
- RS 232 cable
- CD which includes the Firmware, Installation and Operation Manual, QuickNAV™ IP discovery program and system drivers

### Install the FibreBridge

- 1 Place the FibreBridge on a stable flat surface, install it into a standard rack or into your device.  
If installing the Fibre Bridge 2390R/D or the FibreBridge 2400 R/D into a rack, see Exhibit 2.0-1 and follow these instructions:
  - a. Attach “L” brackets so that the front side with the LEDs face front and the connector side is at the back.
  - b. Install the FibreBridge horizontally within the rack so it does not reduce the air flow within the rack.
- 2 Connect and power up Fibre Channel devices from your SAN to the FibreBridge using SFPs and multimode fiber optic cables for the Fibre Channel ports. Keep cable lengths as short as possible to ensure the highest signal quality and performance. Refer to [Cabling](#) on page i of the Appendix.
- 3 Connect and power up SCSI target devices. Refer to [Cabling](#) on page i of the Appendix.
- 4 Connect the Ethernet port to your network.
- 5 Connect power according to the FibreBridge model:
  - For the FibreBridge 2370E, FibreBridge 2390C and Fibre Bridge 2400C, connect the power connector to the FibreBridge.
  - For the FibreBridge 2390C and FibreBridge 2400C, power is already connected if you have installed the unit using the cPCI connection.

- For the FibreBridge 2390R/D and the FibreBridge 2400R/D, connect the AC power cord from the FibreBridge to the proper AC source outlet and turn on the power using the power switch.



### CAUTION

**The power source must be connected to a protective earth ground and comply with local electrical codes. Improper grounding may result in an electrical shock or damage to the unit.**

If you are using a rack:

- a. Properly ground the FibreBridge to the rack equipment. The earth ground connection must be maintained.
  - b. The power requirements plus the power draw of the other equipment in the rack must not overload the supply circuit and/or wiring of the rack.
- 6 Wait up to two minutes for the FibreBridge Ready LED to light indicating the FibreBridge has completed its power-on self test sequence.

### Discover the IP address



#### Note

*The FibreBridge is initially configured with DHCP enabled. It is best if you have access to a DHCP server.*

- 1 Work from the computer attached to the FibreBridge Ethernet port on the same domain. From the CD supplied with your FibreBridge, run the QuickNav Utility **QuickNAV-windows.exe** for Windows or **QuickNAV-Mac** for Mac OS X.
- 2 Locate the FibreBridge with the serial number recorded earlier.
- 3 Highlight the serial number.
- 4 Click **Next**.

If a DHCP server is available on your network, an address is assigned automatically by the server. Note the assigned address:

---

If you do not have a DHCP server, get an IP address and subnet mask from your network administrator, type it into the area provided, and click on **Next**.

5 Click on **Launch Browser**

Your browser points to the ATTO ExpressNAV splash screen. If you use Internet Explorer as a browser, continue on to [Internet Explorer setup](#) below. If not, continue on to [Begin initial configuration](#).

### Internet Explorer setup

- 1 Open your browser
- 2 Select **Internet Options**.
- 3 In the **Internet Options** screen, select the **Security** tab.
- 4 Click on the **Trusted Sites** icon.
- 5 Click on the **Sites** button.
- 6 In the text box **Add this Web site to the zone**, add the IP address of the appliance. You may use wild cards.

- 7 Click on **Add**
- 8 Uncheck the **Require server verification** check box.
- 9 Click **OK**.
- 10 At the bottom of the **Internet Options** box, click on **OK** and close the box.

### Begin initial configuration

- 1 The ExpressNAV interface welcome screen appears. Click on **Enter Here**
- 2 Type in the user name and password.



**Note**

The default values are user name **root** and password **Password**. The user name is case insensitive and the password is case sensitive. It is best practice to change the default user name and password. Refer to [Interface options](#) on page 25.

Exhibit 2.0-1 Brackets to install the FibreBridge 2390R/D or 2400R/D into a rack.

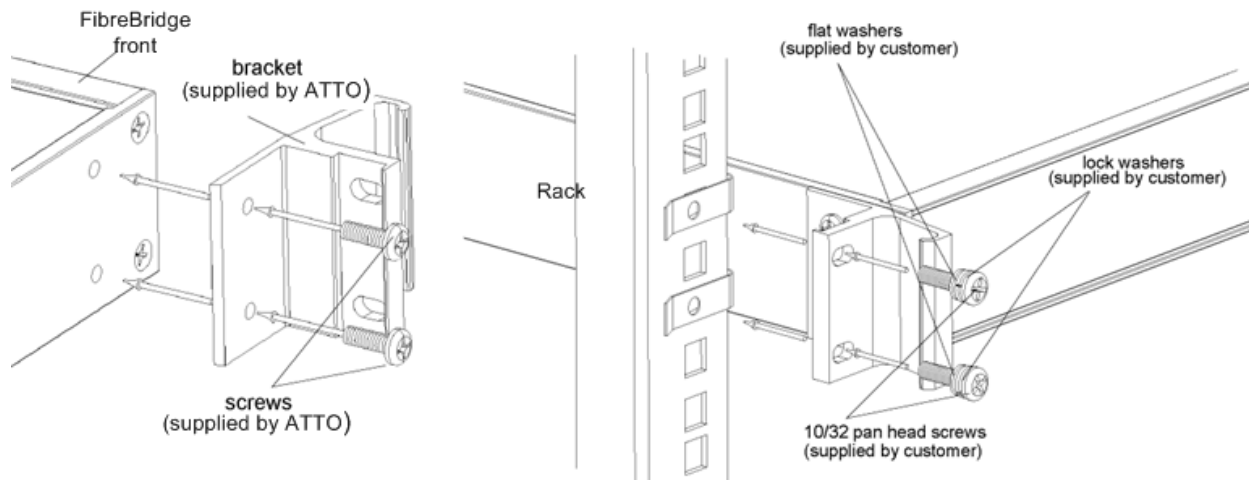
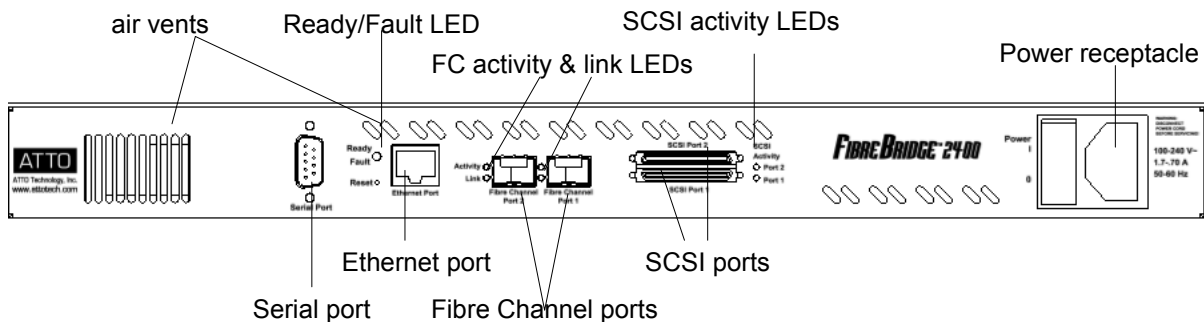

Exhibit 2.0-2 Typical FibreBridge connectors, LEDs and power receptacle



## 3.0 Configure the FibreBridge

To configure the ATTO FibreBridge, use ATTO ExpressNAV. Default values are appropriate for most configurations, but may be modified. The ExpressWizard provides one-button setup for many applications.

The best way to access the FibreBridge to view and change settings is to use ATTO ExpressNAV, a browser-based graphical interface. Other methods are also available. Refer to [Interface options](#) on page 25.

Help is available from within ExpressNAV for any page headings displayed in red. For more information on any of these parameters, refer to the specific CLI command in [Command explanations](#) on page vi of the Appendix.

To change mapping, refer to [Map devices](#) on page 17.

To use Email notification or SNMP, refer to [Remote monitoring, management](#) on page 19.

You may make changes to several pages before going to the **Restart** page and restarting the FibreBridge to save the changes.

### Preliminary steps

- 1 If you are not already in the ExpressNAV interface, type the IP address of your Fibre Bridge in a standard browser as found in [Using ExpressNAV](#) on page 25, click **Enter**. Here, type in your user name and password, and click **OK**.
- 2 The **Status** page appears. Choose one of the following options:
  - View all settings to ensure they are appropriate for your configuration.

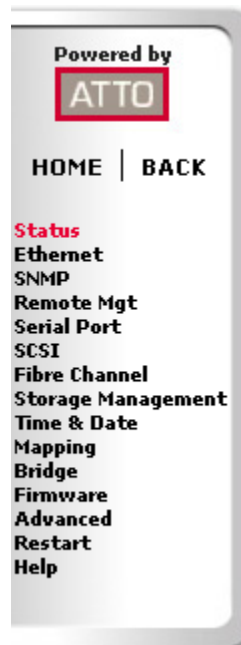

- Keep the automatic settings created when you powered up your Fibre Bridge and do nothing, accepting all the default settings for all ports.
- Use the individual pages listed on the side menu to make changes or use other features such as Email notification or SNMP as needed.

### Port configurations

- 1 Follow the [Preliminary steps](#).
- 2 Click on the port you wish to configure on the left hand menu: **Ethernet, Serial Port, SCSI or Fibre Channel**.
- 3 Select the parameters you wish to change.
- 4 Click **Submit**.
- 5 If you have completed all changes for this session, go to the **Restart** page and restart the Fibre Bridge.

### Modify passwords

- 1 Follow the [Preliminary steps](#)
- 2 From the side menu select **Bridge**. The **Bridge Configuration** page is displayed.

.....

To change usernames or passwords you must enter the current Admin password:

Admin Username: root

New Admin Password: .....

Confirm New Admin Password: .....

.....

Read Only Username: user

New Read Only Password: .....

Confirm New Read Only Password: .....

.....

The Administrator user name that you are currently logged in with and the current read only user name, if present, are displayed in their text boxes.

- 3 Enter the Administrator (**Admin**) password where indicated.
- 4 Enter appropriate information into the **New Admin Password**, **Confirm New Admin Password** or **New Read Only Password** and **Confirm New Read Only Password** text boxes.
- 5 Click **Submit**.
- 6 If you have completed all changes for this session, go to the **Restart** page and restart the Fibre Bridge.

### Enhance performance

SpeedWrite is a method to improve the performance of WRITE commands to SCSI tape devices attached to the FibreBridge.

Using the CLI command **SpeedWrite**, you can specify the SCSI bus, target and LUN of a

mapped device or specify [all] to set or get the state of all currently mapped SCSI devices.

**SpeedWriteDefault** specifies the state of **SpeedWrite** for any SCSI devices mapped manually or via an **AutoMap** operation. If enabled, any new SCSI device uses **SpeedWrite** performance enhancement by default.

- 1 Follow the [Preliminary steps](#).
- 2 From the left hand menu, click on **Storage Management**.
- 3 Select the parameters you wish to change.
- 4 Click **Submit**.
- 5 If you have completed all changes for this session, go to the **Restart** page and restart the FibreBridge.

## 3.1 Map devices

After getting an IP address and entering ATTO ExpressNAV, you must map devices so that the FibreBridge can access the devices in your network.

The ATTO FibreBridge allows parallel SCSI devices to participate in a Fibre Channel arbitrated loop or on a fabric. Fibre Channel and parallel SCSI use different models to address devices. The FibreBridge translates between these addressing models.

### FibreBridge mapping

On a Fibre Channel Arbitrated Loop, the FibreBridge appears at a single Arbitrated Loop Port Address (AL\_PA). Each device on an arbitrated loop is assigned a unique AL\_PA during loop initialization. The FibreBridge supports both modes of AL\_PA assignment, commonly referred to as hard and soft addressing.

**WWN:** To identify each Fibre Channel device while addressing, each Fibre Channel device is assigned a unique World Wide Name (WWN). The 64-bit WWN has the following format:

Field Name	WWN Format		Company ID			Device ID		
	0	1	2	3	4	5	6	7
Value	20	00	00	10	86	xx	xx	xx

**Soft addressing** allows the loop initialization master to assign the FibreBridge a unique address during the loop initialization process. The address assigned cannot be determined before loop initialization. Adding new devices to an arbitrated loop may change the address assigned to the FibreBridge.

**Hard addressing** allows a predetermined address to be assigned to the FibreBridge. The FibreBridge tries to acquire the desired hard address. If another device has already been assigned the specified address, the FibreBridge acquires a currently unassigned address.



Note

*The default mode is soft addressing.*

### SCSI device mapping

SCSI devices connected to the FibreBridge are viewed as Fibre Channel LUNs to the host computer. SCSI devices must be on the same addressing level as the SCSI portion of the FibreBridge. The FibreBridge SCSI ID must be set to a different SCSI ID from the other devices on the same bus.

The ATTO ExpressNAV interface graphically shows you current mapping and the SCSI devices available for mapping. Refer to [Interface options](#) on page 25.

Use the ExpressNAV interface to map devices automatically or to customize mapping. You may modify the mapping as needed to make a device inaccessible to a host or to replace a non-functioning mapped unit.



Note

*It is not necessary to set all mapped devices online: SCSI commands sent to offline devices are rejected.*

## Mapping devices automatically

- 1 If you are not already in the ExpressNAV interface, type the IP address of your FibreBridge in a standard browser as found in [Using ExpressNAV](#) on page 25, click **Enter Here**, type in your user name and password, and click **OK**.
- 1 The **Status** page appears.
- 2 From the ExpressNAV main menu, click on the **Mapping** menu item on the left side of the screen.
- 3 The **Mapping** page appears. Wait for the automatic scan for devices to complete.
- 4 Click **AutoMap**

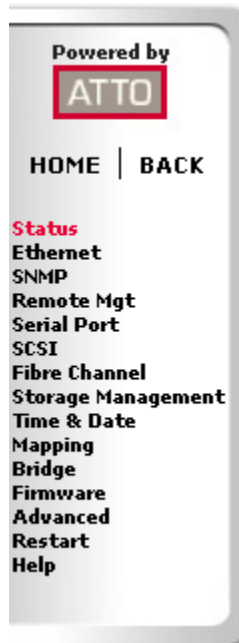

All the commands necessary to enable mapping and the command **saveconfiguration norestart** are performed.

## Mapping devices manually.

- 1 If you are not already in the ExpressNAV interface, type the IP address of your FibreBridge in a standard browser as found in [Using ExpressNAV](#) on page 25, click **Enter Here**, type in your user name and password, and click **OK**.
- 1 The **Status** page appears.
- 2 From the ExpressNAV main menu, click on the **Mapping** menu item on the left side of the screen.
- 3 The **Mapping** page appears. Wait for the automatic scan for devices to complete.
- 4 Select the devices from the box on the right hand side of the screen and drag to the appropriate LUN on the left.
- 5 Click **Submit**. All the commands necessary to enable mapping and the command **saveconfiguration norestart** are performed

## Multiple Node addressing (FB2400 only)

The FibreBridge has a unique Port name for each Fibre Channel port. By default, each Fibre Channel port also has a separate unique Node name: the host computer perceives the FibreBridge as two separate entities, allowing mapping of a different set of logical units to each FC port.

You may use a combination of the Command Line Interface and ExpressNAV to change the default setting to create a single Node name for the FibreBridge and map devices to that node.

- 1 Connect to the FibreBridge using the Command Line Interface as described in [Interface options](#) on page 25.

- 2 At the **Ready** prompt, type  
`set FCMultiNode disabled`



### Note

*Changing the state of the **FCMultiNode** command causes all maps to be deleted.*

- 3 Press **Enter**.
- 4 Type **saveconfiguration restart**.
- 5 Press **Enter**.
- 6 Follow the directions in [Mapping devices automatically](#) or [Mapping devices manually](#) above.

## 3.2 Remote monitoring, management

*The Ethernet port provides monitoring and management using the ExpressNAV interface.*

Remote system monitoring may be set up through Remote Management page of the ExpressNAV interface (see Exhibit 3.0-3) using the Simple Network Management Protocol (SNMP) or Email.

Various types of problems may create a notification:

- Device errors such as medium error, aborted command and hard error
- Device transitions from online to offline
- Critical and warning temperature conditions
- Critical and warning voltage conditions

Messages may state that a device is not working, a medium has an error, or a command has been stopped.

You may designate which warning level a recipient receives. For example, a recipient with a critical severity level only receives critical messages and not warning or informational messages.

In both monitoring systems, you select the warning levels for each recipient:

- **All:** all warnings, critical events and informational messages
- **Informational:** all warnings, critical events and informational messages
- **Warning:** events which are either warnings or critical events
- **Critical:** only events which are critical
- **None:** no messages are sent

*Exhibit 3.0-3 The Remote Management page in the ExpressNAV interface*

### Remote Management

<b>SNMP:</b> <input checked="" type="radio"/> enabled <input type="radio"/> disabled	<b>Email Notification:</b> <input type="radio"/> enabled <input checked="" type="radio"/> disabled
<b>SNMP Traps:</b> <input type="radio"/> enabled <input checked="" type="radio"/> disabled	<b>SMTP Server Address (IP or Name):</b> <input type="text" value="0.0.0.0"/>
<b>SNMP Extended Traps:</b> <input type="radio"/> enabled <input checked="" type="radio"/> disabled	<b>Username:</b> <input type="text"/>
<b>Auto Log Sense:</b> <input type="radio"/> enabled <input checked="" type="radio"/> disabled	<b>Password:</b> <input type="password" value="....."/>
<b>SNMP Trap Recipient IP Addresses:</b>	
<input type="text" value="0.0.0.0"/>	<input type="text" value="None"/>
<input type="text" value="0.0.0.0"/>	<input type="text" value="None"/>
<input type="text" value="0.0.0.0"/>	<input type="text" value="None"/>
<input type="text" value="0.0.0.0"/>	<input type="text" value="None"/>
<input type="text" value="0.0.0.0"/>	<input type="text" value="None"/>
<input type="text" value="0.0.0.0"/>	<input type="text" value="None"/>
<b>Recipient Address (To):</b>	
<input type="text"/>	<input type="text" value="None"/>
<input type="text"/>	<input type="text" value="None"/>
<input type="text"/>	<input type="text" value="None"/>
<input type="text"/>	<input type="text" value="None"/>
<input type="text"/>	<input type="text" value="None"/>

Submit



## SNMP-based monitoring

The Simple Network Management Protocol (SNMP) facilitates the exchange of management information between network devices.

An agent resides in the FibreBridge which takes information from the FibreBridge and translates it into a form compatible with SNMP. If certain conditions arise, the agent sends asynchronous notifications (traps) to a client.



Note

Consult your network administrator for further assistance with SNMP.

- 1 If you are not already in the ExpressNAV interface, type the IP address of your FibreBridge in a standard browser as found in [Using ExpressNAV](#) on page 25, click **Enter Here**, type in your user name and password, and click **OK**.
- 2 On the left hand menu, click **Remote Mgt**.
- 3 The **Remote Management** page appears. Click on the **enabled** radio button next to the SNMP heading.
- 4 Click on the appropriate radio button for **SNMP Traps**, **SNMP Extended Traps** and **Auto Log Sense**.
  - **SNMP Traps** and **SNMP Extended Traps** are notifications for SNMP functions such as device transition and device error.
  - **Auto Log Sense** controls whether current data from log pages in a SCSI target device is available automatically.
- 5 Enter the IP addresses of the those who should receive messages (SNMP trap recipients) in the text boxes on the left.
- 6 Select the type of message you wish each recipient to receive from the drop down box next to each address.
- 7 Click **Submit**.

Exhibit 3.0-4 Events triggering SNMP notification for extended or standard trap generation, severity level and explanation

Event	Severity Level	Extended Traps disabled	Extended Traps enabled	Explanation
Aborted Command	Warning	No	Yes	A SCSI command discovers a command a command has been aborted.
Device Transition	Info	No	Yes	A target device has failed, become offline or come online.
Fibre Channel Loop Down	Info	Yes	Yes	A loop down event on a Fibre Channel port has occurred.
Fibre Channel Loop Up	Info	Yes	Yes	A loop up event on a Fibre Channel port has occurred.
Hardware Error	Critical	No	Yes	An unrecoverable target device failure.
Illegal Request	Info	No	Yes	A SCSI command discovers an illegal SCSI request has been attempted.
Medium Error	Warning	No	Yes	A SCSI command discovers a command terminated with an error condition that may have been caused by a flaw in the target device's physical medium or its recorded data.
Temperature	Info	Yes	Yes	The unit's internal temperature has increased or decreased to within standard operating ranges.
Temperature	Critical	Yes	Yes	Unit's internal temperature has increased to at or above the maximum operating temperature or decreased to at or below the minimum operating temperature.

Event	Severity Level	Extended Traps disabled	Extended Traps enabled	Explanation																				
Temperature	Warning	Yes	Yes	Unit's internal temperature has increased to at or within the unit's maximum operating temperature less the unit's temperature warning offset or decreased to at or within the unit's minimum operating temperature plus the unit's temperature warning offset.																				
Unit Attention	Info	No	Yes	A SCSI command discovers a unit attention condition has occurred.																				
Unit Power On	Info	Yes	Yes	The unit has been powered up.																				
Voltage	Info	Yes	Yes	A monitored voltage level has increased or decreased to within standard operating ranges.																				
Voltage	Critical	Yes	Yes	A monitored nominal voltage level has increased or decreased beyond the percentages listed below: <table border="1"> <thead> <tr> <th>Level</th> <th>VDDA</th> <th>Vddb</th> <th>VDDC</th> <th>VDDD</th> </tr> </thead> <tbody> <tr> <td></td> <td>3.30V</td> <td>2.50V</td> <td>1.50V</td> <td>1.35V</td> </tr> <tr> <td>Low</td> <td>5%</td> <td>4%</td> <td>5%</td> <td>4.5%</td> </tr> <tr> <td>High</td> <td>8%</td> <td>5%</td> <td>5%</td> <td>5%</td> </tr> </tbody> </table>	Level	VDDA	Vddb	VDDC	VDDD		3.30V	2.50V	1.50V	1.35V	Low	5%	4%	5%	4.5%	High	8%	5%	5%	5%
Level	VDDA	Vddb	VDDC	VDDD																				
	3.30V	2.50V	1.50V	1.35V																				
Low	5%	4%	5%	4.5%																				
High	8%	5%	5%	5%																				
Voltage	Warning	Yes	Yes	A monitored nominal voltage level has increased or decreased beyond the percentages listed below: <table border="1"> <thead> <tr> <th>Level</th> <th>VDDA</th> <th>Vddb</th> <th>VDDC</th> <th>VDDD</th> </tr> </thead> <tbody> <tr> <td></td> <td>3.30V</td> <td>2.50V</td> <td>1.50V</td> <td>1.35V</td> </tr> <tr> <td>Low</td> <td>3%</td> <td>3%</td> <td>3%</td> <td>3%</td> </tr> <tr> <td>High</td> <td>5%</td> <td>3.5%</td> <td>3%</td> <td>3%</td> </tr> </tbody> </table>	Level	VDDA	Vddb	VDDC	VDDD		3.30V	2.50V	1.50V	1.35V	Low	3%	3%	3%	3%	High	5%	3.5%	3%	3%
Level	VDDA	Vddb	VDDC	VDDD																				
	3.30V	2.50V	1.50V	1.35V																				
Low	3%	3%	3%	3%																				
High	5%	3.5%	3%	3%																				

## Email messages provide error notification

Email notification allows the FibreBridge to send an Email message to you, a network administrator or other users when certain events occur. Serious error messages are sent immediately, while messages for less serious errors are sent every 15 minutes.

You may send Emails to up to five Email addresses and designate which conditions prompt each Email notification.

When an event occurs that has been designated as requiring Email notification, the FibreBridge sends the message; it cannot respond to a rejection by a server for an invalid address. Ensure all Email addresses typed in are valid.

Each Email is time stamped when it leaves as part of the SMTP header information as shown in Exhibit 3.0-5.

1 If you are not already in the ExpressNAV interface, type the IP address of your

FibreBridge in a standard browser as found in [Using ExpressNAV](#) on page 25, click **Enter Here**, type in your user name and password, and click **OK**.

- 2 On the left hand menu, click **Remote Mgt.**
- 3 The **Remote Management** page appears.
- 4 Click on the **enabled** radio button next to the **Email Notification** heading.
- 5 Type in the sender address (Emails show this name in the **From** field)
- 6 Type in the SMTP Server IP address
- 7 Type in the user name and password of your SMTP Email account if your server requires it
- 8 Type in up to five Email addresses
- 9 Choose **All**, **Informational**, **Warning**, or **Critical** for each Email address.
- 10 When all information is typed in, click **Submit**.

*Exhibit 3.0-5 The Email messages sent by the FibreBridge follow this format.*

Subject: [The Type of Event that Occurred]

Message Body:

This is a status message from [FibreBridge name]. Identifying information as well as the most recent entries from the event log appear below.

```
***** Unit Information *****
Serial Number : [Serial Number]
IP Addresses:  [IP Address1]
               [IP Address2]
***** Event Log Entries *****
```

[Listing of the ten latest event log entries]

*Exhibit 3.0-6 Events triggering an Email message, severity level and explanation*

Event	Severity Level	Explanation																				
Aborted Command	Warning	A SCSI command discovers a command has been aborted.																				
Device Down	Warning	A target device has failed or become offline.																				
Hardware Error	Critical	A SCSI command discovers an unrecoverable target device failure.																				
Medium Error	Warning	A command terminated with an error condition that may have been caused by a flaw in the target device's physical medium or its recorded data.																				
Temperature	Critical	Unit's internal temperature has increased to at or above the maximum operating temperature or decreased to at or below the minimum operating temperature.																				
Temperature	Warning	Unit's internal temperature has increased to at or within the unit's maximum operating temperature less the unit's temperature warning offset or decreased to at or within the unit's minimum operating temperature plus the unit's temperature warning offset.																				
Unit Power On	Info	The unit has been powered up.																				
Voltage	Critical	A monitored nominal voltage level has increased or decreased beyond the percentages listed below: <table border="0" style="width: 100%; border-collapse: collapse;"> <tr> <td style="width: 10%;"></td> <td style="width: 20%;">VDDA (3.30V)</td> <td style="width: 20%;">VDDB (2.50V)</td> <td style="width: 20%;">VDDC (1.50V)</td> <td style="width: 20%;">VDDD(1.35V)</td> </tr> <tr> <td>Level</td> <td></td> <td></td> <td></td> <td></td> </tr> <tr> <td>Low</td> <td>5%</td> <td>4%</td> <td>5%</td> <td>4.5%</td> </tr> <tr> <td>High</td> <td>8%</td> <td>5%</td> <td>5%</td> <td>5%</td> </tr> </table>		VDDA (3.30V)	VDDB (2.50V)	VDDC (1.50V)	VDDD(1.35V)	Level					Low	5%	4%	5%	4.5%	High	8%	5%	5%	5%
	VDDA (3.30V)	VDDB (2.50V)	VDDC (1.50V)	VDDD(1.35V)																		
Level																						
Low	5%	4%	5%	4.5%																		
High	8%	5%	5%	5%																		
Voltage	Warning	A monitored nominal voltage level has increased or decreased beyond the percentages listed below: <table border="0" style="width: 100%; border-collapse: collapse;"> <tr> <td style="width: 10%;"></td> <td style="width: 20%;">VDDA (3.30V)</td> <td style="width: 20%;">VDDB (2.50V)</td> <td style="width: 20%;">VDDC (1.50V)</td> <td style="width: 20%;">VDDD(1.35V)</td> </tr> <tr> <td>Level</td> <td></td> <td></td> <td></td> <td></td> </tr> <tr> <td>Low</td> <td>3%</td> <td>3%</td> <td>3%</td> <td>3%</td> </tr> <tr> <td>High</td> <td>5%</td> <td>3.5%</td> <td>3%</td> <td>3%</td> </tr> </table>		VDDA (3.30V)	VDDB (2.50V)	VDDC (1.50V)	VDDD(1.35V)	Level					Low	3%	3%	3%	3%	High	5%	3.5%	3%	3%
	VDDA (3.30V)	VDDB (2.50V)	VDDC (1.50V)	VDDD(1.35V)																		
Level																						
Low	3%	3%	3%	3%																		
High	5%	3.5%	3%	3%																		

## 4.0 Update firmware

The ATTO FibreBridge has several processors which control the flow of data. The firmware to control these processors can be upgraded in the field using the **PUT** command from an FTP connection, or ZModem utility over an RS-232 serial connection. The preferred method is to use ATTO ExpressNAV.



### Note

The recommended management tool for updating firmware for the FibreBridge is the ATTO ExpressNAV interface. Use the **Update Firmware** page.

The FibreBridge firmware is distributed as an **.ima** file and can be obtained from the ATTO web site.

### Preliminary step

The FibreBridge firmware is distributed as an **.ima** file from the ATTO Technology web site at [www.attotech.com](http://www.attotech.com) or from the CD included with your bridge. Download the file and note the filename.



### CAUTION

Before beginning this procedure, ensure that all I/O to the FibreBridge has stopped.

During this procedure, **do not** interrupt the flash process.

**Do not** power down the host or the FibreBridge until the display returns the Ready prompt.

Interrupting the flash process will make your FibreBridge inoperable and you will have to return it to ATTO Technology for repair.

### Using ExpressNAV

- 1 If you are not already in the ExpressNAV interface, type the IP address of your FibreBridge in a standard browser as found in [Using ExpressNAV](#) on page 25, click **Enter Here**, type in your user name and password, and click **OK**.
- 2 Click on the **Firmware** menu item for the left-hand side of the page.
- 3 The **Firmware Update** page appears. Click **Browse** to locate the firmware you downloaded in the preliminary step.
- 4 Highlight the file.
- 5 Click **Upload**.
- 6 Wait until a success message is displayed.
- 7 Click on the **Restart** menu item on the left-hand side of the page.
- 8 The **Restart** page appears. Click on **Restart**.

### Using FTP

- 1 Establish an FTP link to the bridge that is to be flashed.
- 2 Use the **PUT** command to download the firmware file to the bridge. For example  

```
PUT c:\bridge_firmware\FB3200100.IMA
```
- 3 Once the download is complete, cycle power on the FibreBridge to implement the new firmware.

### Using the zModem command

- 1 Load a Terminal Program such as Hyper Terminal.
- 2 Set the terminal and the FibreBridge for the highest possible baud rate for your terminal.
- 3 Turn on power to the FibreBridge.
- 4 Once the **Ready** prompt appears, type **ZMODEM RECEIVE**. The FibreBridge displays that it is preparing to receive a file from your terminal program.
- 5 On the terminal program, choose **Transfer Send File**

- 6 In the **Send File** box, enter the current FibreBridge **.ima** file or click the browse button to find it.
- 7 Click **Send File**
- 8 The FibreBridge acknowledges receiving the file and displays a message not to interrupt power for 90 seconds. Once the download is complete, cycle power on the FibreBridge to start the new firmware.

## 5.0 Interface options

Alternative methods to the ATTO ExpressNAV interface may be used to manage the Fibre Bridge. ATTO ExpressNAV is the recommended interface.

### Using ExpressNAV

Each page in the ATTO ExpressNAV interface provides information and/or configuration parameters based on a specific topic.

ATTO ExpressNAV is the recommended management tool for the Fibre Bridge. It is a web-based graphical user interface (GUI) that allows you to manage the Fibre Bridge by clicking choices and commands in traditional GUI fashion or by entering CLI commands directly, as you would in a terminal emulation session, on the **Advanced CLI** page.

#### Opening an ExpressNAV session

- 1 Point your browser at the IP address of the Fibre Bridge. Refer to [Discover the IP address](#) on page 13.
- 2 The **ExpressNAV** home page is displayed. Click **Enter**.
- 3 Enter the user name and password values.



#### Note

The default values are user name: **root** and password: **Password**. The user name is case insensitive and password is case sensitive. It is best practice to change user names and

passwords. Refer to [Modify passwords](#) on page 15.

The **Status** page appears.

Each page can be reached through the menu at the side of each page. An image on each page's header shows each port in the product faceplate. Each port is clickable and takes you to the appropriate page.

If you have completed configuration operations and have clicked **Submit** on the page you are viewing, go to the **Restart** page and restart the Fibre Bridge to save the settings.

If you have not completed configuration changes, go on to the next page.

#### Optimizing ExpressNAV in Internet Explorer

- 1 Go to the browser toolbar and select **Tools**
- 2 Select **Internet Options**
- 3 Select the **Security** tab
- 4 Select the **Custom Level** button.
- 5 On the menu presented, go to the **Microsoft VM, Java permissions** and make sure **Disable Java** is *not* selected.
- 6 Go to the **Miscellaneous** topic and select **METAREFRESH**.

### Using the serial port

- 1 Connect a cable from Fibre Bridge RS-232 serial port to the serial (COM) port on a personal computer.
  - a. Click **OK**.
  - b. In the **Connect To** dialog box, for the **Connect using field** select the COM port number to which your serial cable is connected.
  - c. Click **OK**.
  - d. In the COM Properties dialog box select the following values:
    - Bits per second: 115200
    - Data Bits: 8
    - Parity: None
    - Stop Bits: 1
- 2 Turn on the Fibre Bridge.
- 3 Start a terminal emulation program on the personal computer, and use it to connect to the Fibre Bridge. For example, if you are using HyperTerminal on a computer running a Windows operating system,
  - a. Type **Fibre Bridge** in the **New Connection** dialog box.

- Flow Control: None
  - Terminal type: ASCII
  - Echo: on
- f. Click **OK**.
- 4 After you connect to the Fibre Bridge, start-up messages are displayed. These messages are only displayed at start-up. The last line in the start-up message sequence is **Ready**.
  - 5 In serial port sessions, there is no prompt on the line below the word **Ready**. Begin typing commands in the blank line where the cursor is

resting. No user name or password is required for serial port access.

- 6 To verify that you have connected successfully, type **help** after the **Ready** prompt and press **Enter**.
  - If a list of all available commands does not appear on the screen, review the steps in this section, check the cable, or contact service personnel until the problem is solved.

If you have difficulty using the serial port, verify that you have the correct settings and that your serial cable is less than two meters in length.

## Using Telnet

Up to three Telnet sessions can be conducted simultaneously. A serial port session can use the CLI while Telnet sessions are open. Whichever session issues the first **set** CLI command can continue to issue set commands, while the other sessions can only issue **get** commands or display information. Once a connection is established, refer to [CLI provides ASCII-based interface](#) on page ii of the Appendix.

- 1 Connect to the Fibre Bridge from a computer on the same Ethernet network.
- 2 Start a Telnet session.



### Note

*There is more than one way to connect to the Fibre Bridge using a telnet program. Your*

*telnet program may operate differently than in the following instructions.*

- 3 At the telnet prompt, issue the **open** command where x.x.x.x is the IP address of the Fibre Bridge.

```
telnet > open x.x.x.x
```

- 4 If you have to specify a port type, enter the port type "telnet" and the terminal type "vt100".

```
port type: telnet
```

```
terminal type: vt100
```

- 5 Enter the default values for the user name, **root**, and the password, **Password**, if you did not set new values in [Modify passwords](#) on page 15.

# Appendix A Cabling

ATTO FibreBridge SCSI ports connect SCSI storage devices into the Fibre Channel Storage Area Network (SAN). Use an Ethernet connection to use the ATTO ExpressNAV interface.

Make sure all cables are anchored securely at both ends with the proper connectors.

## SCSI port connections

The FibreBridge supports a wide variety of SCSI storage devices including stand-alone drives, removable drives, JBODs, tape, CD and DVD drives, changers, libraries and magneto optical drives.

Each SCSI port is totally independent from the other SCSI port. Each bus may support up to 15 devices and each SCSI bus auto-negotiates the appropriate sync rates with the connected devices. If slower devices are mixed with faster devices, the bus communicates at the rate of the slowest device.

Connect slower devices to one SCSI port and faster devices to the other port.

Connect a SCSI connector from the SCSI device to a SCSI port on the FibreBridge.

Check the type of cable, cable length limit and number of devices recommended for each port. Keep cable lengths as short as possible to ensure the highest signal quality and performance. These cable lengths include the wiring inside the devices.

Device type	Cable limit
Ultra SCSI Single Ended (SE)	1.5 meters
Ultra2 SCSI Low Voltage Differential (LVD)	12 meters
Ultra160 SCSI Low Voltage Differential (LVD)	12 meters
Ultra320 SCSI Low Voltage Differential (LVD)	12 meters

## Fibre Channel connections

Fibre Channel technology offers a variety of cabling options. The type of cable required varies depending upon the application, environment and distance.

Cable length	Cable type	Cable size	FC connector
Up to 175 meters	multi mode fiber optic	62.5 micron	LC
Up to 500 meters	multimode fiber optic	50 micron	LC
Up to 13 meters	unequalized copper		HSSDC-2

## Serial port connections

The ATTO FibreBridge supports remote service operations over the RS-232 serial port using standard terminal emulation software available with most systems.

Connect a DB-9 crossover serial cable (null modem) between the ATTO FibreBridge serial port and one of the computer's serial COM ports. A gender changer or DB-9 to DB-25 converter may be needed depending on the cables being used.

## Ethernet connections

The 10/100 BaseT Ethernet port provides remote monitoring and management using the ATTO ExpressNAV interface.

When you connect an Ethernet cable between the FibreBridge and a 10/100Base-T connection, you may need a crossover cable connecting directly to a computer. The ATTO FibreBridge auto detects the Ethernet speed by default.



## Appendix B CLI provides ASCII-based interface

The command line interface (CLI) provides access to the ATTO FibreBridge Services through a set of ASCII commands. CLI commands may be entered while in CLI mode.

FibreBridge Services provide configuration and monitoring for the FibreBridge. The command line interface (CLI) is a set of ASCII-based commands which perform these tasks. CLI commands may be entered while in CLI mode.

- CLI commands are context sensitive and generally follow a standard format

[Get|Set] Command [Parameter1|Parameter2]

followed by the **return** or **enter** key

- CLI commands are case insensitive: you may type all upper or all lower case or a mixture. Upper and lower case in this manual and the **help** screen are for clarification only.
- Commands generally have three types of operation: get, set and immediate.
- The get form returns the value of a parameter or setting and is an informational command.
- Responses to get commands are followed by **Ready**.

- The set form is an action that changes the value of a parameter or configuration setting. It may require a **SaveConfiguration** command and a restart of the system before it is implemented. The restart can be accomplished as part of the **SaveConfiguration** command or by using a separate **FirmwareRestart** command. A number of set commands may be issued before the **SaveConfiguration** command.
- Responses to **set** commands are either an error message or **Ready**. \*. The asterisk indicates you must use a **SaveConfiguration** command to finalize the **set** command. **SaveConfiguration** asks if you want to restart the system or not.
- Set commands which do not require a **SaveConfiguration** command, defined as Immediate commands, are executed.
- Responses to Immediate commands are either an error message or data results followed by **Ready**.

*Exhibit 0.0-1 Symbols, typefaces and abbreviations used to indicate functions and elements of the command line interface used in this manual.*

### Command conventions

Symbol	Indicates
[ ]	Required entry
< >	Optional entry
	pick one of
...	Ellipses, repetition of preceding item
\n	end of line
-	a range (6 – 9 = 6, 7, 8, 9)
fl	Fibre Channel LUN (0 <= fl <= 255)
fp	Fibre Channel port number (1<= fp <=1 or 2)
sb	SCSI bus number (1<= sb <= 2)
sl	SCSI LUN ID (0 <= sl <= 7)
st	SCSI target ID (0 <= st <= 15)
mp1	Ethernet port used to manage the FibreBridge

## CLI error messages

---

*The following error messages may be returned by the Command line Interface*

ERROR. Invalid Command. Type 'Help' for command list.

ERROR. Wrong/Missing Parameters

Usage: <usage string>

ERROR. Command Not Processed

## CLI summary reference

---

A summary of the Command Line Interface commands, their defaults, and where you can find the specifics of the command. Commands which

have no default values associated with them have a blank entry in that column of the table.

Command	Default	Example
AutoLogSense	disabled	set autologsense enabled
AutoMap		automap
BootFibreDelay	0	set bootfibredelay 15
BootScan	disabled	set bootscan enabled
BootScanPorts (FB2400 only)	auto	set bootscanports all
BridgeModel		get bridgemodel
BridgeName	“ “	set bridgename Omega6
ClearEventLog		clear eventlog
ClearTraceLog		clear trace log
Date		set date 03/03/03
DeleteAllMaps		delete all maps
DHCPFixedDelay	0	set dhcpfixeddelay 15
DisplayEventLog		display eventlog
DisplayEventLogFilter	all all all	set displayeventlogfilter all all all
DisplayTraceLog		display trace log
DisplayTraceLogFilter	all all all	set displaytracelogfilter all info all
DumpConfiguration		dump configuration
DumpEventLog		dump eventlog
DumpTraceLog		dump trace log
EmailFromAddress		get emailfromaddress
EmailNotify	disabled	get emailnotify
EmailNotifyAddress		set emailnotifyaddress 5 bw@abc.com
EmailPassword		set emailpassword
EmailServerAddress		get emailserveraddress
EmailUsername		set emailusername beta321

Command	Default	Example
EthernetSpeed	auto	set ethernetspeed 100
EventLog	enabled	set eventlog disabled
EventLogFilter	all all all	set eventlogfilter gen info enabled
Exit		exit
FCConnMode	loop	set fcconnmode all ptp
FCDataRate	auto	get fcdatarate 1
FCHard	disabled	set fchard enabled
FCHardAddress		set fchardaddress 1 122
FCMultiNode (FB2400 only)	enabled	set fcmultinode disabled
FCPortErrors		get fcporterrors all
FCPortList		fcportlist
FCSCSIBusyStatus	busy	set fcscsibusystatus qfull
FCSpeedLED2G (FB2370 only)	disabled	set fcspeedled2g enabled
FCWWName		get fcwwname 1
FirmwareRestart		firmwarerestart
Help		help driveinfo
IdentifyBridge	disabled	set identifybridge enabled
Info		info
IPAddress	10.0.0.1	get ipaddress mp1
IPDHCP	enabled	set ipdhcp mp1 disabled
IPDNSServer		get ipdnsserver
IPGateway	0.0.0.0	set ipgateway mp1 200.10.22.3
IPSubnetMask	255.255.0.0	get ipsubnetmask mp1
IsReserved		isreserved
LogicalUnitAddressing	disabled	set logicalunitaddressing enabled
MaxOpTemp (FB2390, FB2400}	70	get maxoptemp
MinOpTemp (FB2390, FB2400}	0	set minoptemp 10
OpTempWarn (FB2390, FB2400}	5	set optempwarn 15
Password	Password	set password
Performance		get performance 2
Ping		ping 192.42.155.155
ReadOnlyPassword	Password	get readonlypassword
ReadOnlyUsername	user	get readonlyusername
Reserve		reserve
ResetFCPortErrors		resetfcporterrors 1
RestoreConfiguration		restoreconfiguration default
Route		route fc 1 1 bridge
RouteDisplay		routedisplay fc 1 1
SaveConfiguration		saveconfiguration restart

Command	Default	Example
SCSIDomainValidation		scsidomainvalidation
SCSIInitId	0x07	set scsiinitid 2 12
SCSIPortBusSpeed	ultra320	set scsiportbusspeed 2 ultra160
SCSIPortList		scsiportlist
SCSIPortReset		scsiportreset 1
SCSIPortResetOnStartup	enabled	set scsiportresetonstartup 1 disabled
SCSIPortSyncTransfer	enabled	set scsiportsynctransfer 2 disabled
SCSIPortTermination	enabled	set scsiporttermination 1 disabled
SCSIPortWideTransfer	enabled	set scsiportwidetransfer 2 disabled
SCSITargetLUNs	8	set scsitargetluns 1 64
SCSITargets		scsitargets 1
SerialNumber		get serialnumber
SerialPortBaudRate	115200	set serialportbaudrate 19200
SerialPortEcho	enabled	get serialportecho
SNMP	enabled	set SNMP disabled
SNMPDumpMIB		snmpdumpmib
SNMPExtendedTraps	disabled	get snmpextendedtraps
SNMPTrapAddress	0.0.0.0 none	set snmptrapaddress 6 192.42.155.155 all
SNMPTraps	disabled	set snmptraps enabled
SNTP	enabled	get sntp
SNTPServer	192.43.244.18	set sntpserver 129.6.15.28
SpeedWrite	all disabled	get speedwrite scsi all
SpeedWriteDefault	disabled	set speedwritedefault enabled
TailEventLog		taileventlog
Temperature (FB2390, FB2400 only)		get temperature
Time	00:00:00	set time 03:32:30
TimeZone	EST	set timezone pst
TraceLog	disabled	set tracelog enabled
TraceLogFilter	all all all	set tracelogfilter all all all
Username	root	set username Barbara
VerboseMode	enabled	set verbosemode disabled
VirtualDriveResponse	disabled	set virtualdriveresponse enabled
VirtualRobotResponse	disabled	set virtualrobotresponse enabled
Voltage (FB2390, FB2400)		get voltage
WrapEventLog	enabled	set wrapeventlog disabled
WrapTraceLog	enabled	set wraptracelog disabled
zModem		zmodem receive

## Command explanations

---

### AutoLogSense

Controls whether current data from log pages in a SCSI target device is available automatically.

Default: disabled

set AutoLogSense [enabled|disabled]

Requires a SaveConfiguration command

get AutoLogSense

### AutoMap

Automatically assigns a subset of source protocol LUNs to a subset of target destination devices visible to the FibreBridge. All previous maps are deleted. The unit reports a five-second delay while it scans for devices.

[FCMultiNode \(FB2400 only\)](#) enabled: AutoMap <fp>

All other models and FC2400 with FCMultiNode disabled:  
AutoMap

Requires a SaveConfiguration command

### BootFibreDelay

Regulates the delay (in seconds) which the FibreBridge waits until after startup before enabling Fibre Channel ports.

Default: 0 (no delay)

set BootFibreDelay [0 | 15 | 30 | 45| 60 | 75]

Requires a SaveConfiguration command

get BootFibreDelay

### BootScan

Provides dynamic mapping of SCSI devices to the Fibre port/LUN combination via a SCSI bus scan at boot time. All devices discovered during the bus scans are assigned to a Fibre port, Fibre LUN combination until the next reset/power cycle. This dynamic mapping replaces the current, static mapping of the FibreBridge.

Default: disabled

set BootScan [enabled | disabled]

Requires a SaveConfiguration command

get BootScan

### BootScanPorts (FB2400 only)

Regulates the ports to be used for a boot scan.

Default: auto

set BootScanPorts [fp | all | auto]

Requires a SaveConfiguration command

get BootScanPorts

### BridgeModel

Reports model and firmware information about the FibreBridge.

get BridgeModel

### BridgeName

Specifies the eight-character ASCII name assigned to the FibreBridge used to identify individual units. It is not the World Wide Name. The string is alphanumeric, eight characters long. Changes take effect immediately.

Default: " "

set BridgeName [name]

get BridgeName

### ClearEventLog

Clears the contents of the event log. No new entries are recorded until the operation is completed.

ClearEventLog

### ClearTraceLog

Clears the contents of the trace log. No events are recorded until the operation is completed.

ClearTraceLog

### Date

Sets/displays the date. The range is 01/01/2000 to 12/31/2099.

Default: 01/01/2000

set Date [MM] / [DD] / [YYYY]

Requires a SaveConfiguration command

get Date

### DeleteAllMaps

Removes all mapped devices from the map table. Upon the subsequent POST, if no maps are present, the default maps are loaded.

DeleteAllMaps

Requires a SaveConfiguration command

### DHCPFixedDelay

Regulates or displays the delay (in seconds) between DHCP client request intervals.

Default: 0

set DHCPFixedDelay [0-255]

Requires a SaveConfiguration Restart command

get DHCPFixedDelay

## DisplayEventLog

Displays the event log. The event log may be filtered using the [DisplayEventLogFilter](#) command. The optional parameter **n** is the number of lines to be displayed as a single page with no user interaction. After the command has executed, use +, - or = to scroll through the log. Type **quit** and press **Enter** to exit the command.

```
DisplayEventLog <n>
```

## DisplayEventLogFilter

Filters the display of data for specified subsystems and levels if [DisplayEventLog](#) is enabled. Valid event log subsystem entries are platform-dependent. For set commands, the final parameter indicates whether or not events from the specified subsystem and level are displayed.

Default: all all

```
set DisplayEventLogFilter [subsystem | all] [level | all] [all | none]
```

```
get DisplayEventLogFilter [subsystem | all] [level | all]
```

## DisplayTraceLog

Displays the most recent page of trace log entries. The optional parameter **n** is the number of lines to be displayed as a single page with no user interaction. After the command has executed, use +, - or = to scroll through the log. Type **quit** and press **Enter** to exit the command.

```
DisplayTraceLog <n>
```

Fibre Channel trace log entries depict

FC: an FC trace log

PortID the hexadecimal loop ID of the host device

Bus: specifies the hexadecimal SCSI bus number

Target ID: specifies the hexadecimal SCSI target device number

CDB: each **Cx** character represents the hexadecimal byte-wise contents of the command's SCSI Command Descriptor Block. SCSI CDBs with less than 16 bytes are padded with zeros

SCSI trace log entries depict

SCSI: a SCSI trace log

Bus: hexadecimal SCSI bus number

Target ID: hexadecimal SCSI target device number

LUN: hexadecimal SCSI logical unit number

CDB: each **Cx** character represents the hexadecimal byte-wise contents of the command's SCSI

Command Descriptor Block. SCSI CDBs with less than 16 bytes are padded with zeros  
Stat: hexadecimal byte-wise SCSI status return code.  
Sense Data: each **Sx** character represents the hexadecimal byte-wise contents of the sense data returned by a target device in response to an attempted SCSI command. Maximum 18 bytes of sense data is all zeros for commands that did not cause the target device to return sense data.

## DisplayTraceLogFilter

Filters the display of data for specific ports if [DisplayTraceLog](#) is enabled.

```
set DisplayTraceLogFilter [FC | SCSI | all] [fp | sb | all] [none | chkcond | all]
```

```
get DisplayTraceLogFilter [FC | SCSI | all] [fp | sb | all]
```

## DumpConfiguration

Displays the FibreBridge configuration.

```
DumpConfiguration
```

## DumpEventLog

Dumps the entire contents of the event log to the ExpressNAV Advanced page text box, RS-232 or Telnet session.

```
DumpEventLog
```

## DumpTraceLog

Dumps the entire contents of the trace log to the ExpressNAV Advanced page text box, RS-232 or Telnet session.

```
DumpTraceLog
```

## EmailFromAddress

Configures the Email address that the FibreBridge uses to communicate with the Email server. Full Email address is a fully qualified Internet Email address, not more than 128 characters long.

```
set EmailFromAddress [full email address]
```

```
get EmailFromAddress
```

## EmailNotify

Regulates Email notification.

Default: disabled.

```
set EmailNotify [enabled | disabled]
```

```
get EmailNotify
```

### EmailNotifyAddress

Configures notification addresses. Index is a number 1-5.

**Full Email address** is a fully qualified Internet Email address, not more than 128 characters long. Warning level can be **All**, **Warning**, **Critical** or **None**. **None** means no Emails are sent; **Critical** means only critical severity events sends an Email; **Warning** means only warnings and critical events send Email, and **All** means all warnings and critical events warrant an Email.

```
set EmailNotifyAddress [index] [full email address]
[warning level]
get EmailNotifyAddress <index | all>
```

### EmailPassword

Configures the password used to authenticate the login to the SMTP Email server. The password must not be more than 64 characters. A password is not required if the Email server does not require authentication.

```
set EmailPassword
Requires a SaveConfiguration command
```

### EmailServerAddress

Configures the address of the server the FibreBridge must contact in order to send out Email notifications.

```
set EmailServerAddress [IP address]
Requires a SaveConfiguration command
get EmailServerAddress
```

### EmailUsername

Configures the user name used to authenticate the login to the SMTP Email server. The user name must not be more than 128 characters. A user name is not required if the Email server does not require authentication.

```
set EmailUsername
Requires a SaveConfiguration command
get EmailUsername
```

### EthernetSpeed

Sets/displays the current speed of the Ethernet connection. Choices are 10, 100, and Auto.

```
Default: auto
set EthernetSpeed [mp1] [ 10 | 100 | Auto ]
Requires a SaveConfiguration Restart command
get EthernetSpeed [mp1]
If auto enabled, value in parentheses indicates current
speed
```

### EventLog

Regulates event logging. When enabled, records various system events to the event log.

```
Default: enabled
set EventLog [enabled | disabled]
get EventLog
```

### EventLogFilter

Filters data from specific unit subsystems and levels when event logging is enabled. The specific entries supported are platform-dependent. For set commands, the final parameter indicates whether or not events from the specified subsystem and level are displayed.

```
Default: all all all
set EventLogFilter [subsystem | all] [event level | all] [all |
none]
get EventLogFilter [subsystem | all ] [level | all]
```

### Exit

Ends the current Ethernet Telnet CLI session; it has no effect if used during a serial CLI session.

Exit

### FCConnMode

Controls/reports the connection the FibreBridge uses when communication across a FC network, either to an arbitrated loop (FC-AL) when you select **loop**, or point-to-point when you choose **ptp**. If you choose **loop-ptp** or **ptp-loop**, the FibreBridge tries to use the first parameter first, but uses the second if it cannot use the first.

```
Default: loop
set FCConnMode [fp | all] [loop | ptp | loop-ptp | ptp-loop]
Requires a SaveConfiguration Restart command
get FCConnMode [fp | all]
```

### FCDataRate

Specifies the rate the FibreBridge uses, 1 Gb/sec., 2 Gb/sec. 4 Gb/sec. or auto negotiate.

```
Default: auto
set FCDataRate [fp | all] [1Gb | 2Gb | 4Gb | auto]
Requires a SaveConfiguration Restart command
get FCDataRate [fp | all]
```

## FCHard

Regulates FC hard address assignment. Under soft addressing, the FibreBridge loop address is assigned during loop initialization. Use [FCHardAddress](#) if you enable hard addressing.

Default: disabled

set FCHard [enabled | disabled]

Requires a SaveConfiguration Restart command

get FCHard

## FCHardAddress

Specifies the value used as the FC-AL hard address. This value represents the address that is used if hard addressing is enabled (refer to [FCHard](#)). The range of valid FC hard address values are 0 through 125. The **all** option is only available with the **get** command.

Default fp1=3; fp2=4

set FCHard Address [fp | [address]]

Requires a SaveConfiguration Restart command

get FCHardAddress [fp | all]

## FCMultiNode (FB2400 only)

Determines the reported identity of Fibre Channel ports. When enabled, each port reports a separate unique Node Name and logical units may be mapped to either port. When disabled, each port reports the same Node Name and each logical unit mapping is applied to all ports, providing host-side failover and load balancing capabilities.



### Note

Changing this parameter causes all maps to be deleted. Add new maps using the [AutoMap](#) or [Route](#) commands.

Default: enabled

set FCMultiNode [enabled|disabled]

Requires a SaveConfiguration restart command

get FCMultiNode

## FCPortErrors

Displays the number of Fibre Channel errors that have occurred since the last reboot/power-on or [Reset FCPortErrors](#) command at the Fibre Channel controller level.

Errors tracked:

Link Failure: Number of times link has failed due to loss of signal, loss of synchronization for greater than

100ms, link fault, LIPs not being recognized for 45 ms or more in the normal-initialize state, or bad N\_port state transition

Sync Loss: Number of times signal synchronization has been lost when the controller was not in the offline state

Signal Loss: Number of times the FC controller has detected a loss of signal

Invalid Tx: Number of times FC controller has detected an **Invalid Transmission Word during frame reception**

Invalid CRC: Number of times the FC controller has detected a frame received with a bad CRC

get FCPortErrors [fp | all]

## FCPortList

Returns a list of available FC ports and their current status. Valid status values are **Up**, **Down**, **Failed**, **Reserved** and **Disabled**.

FCPortList

## FCSCSIBusyStatus

Specifies the SCSI status value returned when the FibreBridge is unable to accept a SCSI command because of a temporary lack of resources. Choices are **busy** and **queue full**.

Default: busy

set FCSCSIBusyStatus [busy | qfull]

Requires a SaveConfiguration command

get FCSCSIBusyStatus

## FCSpeedLED2G (FB2370E)

Configures the FC speed LED. When enabled, the LED lights for FC speeds of 2 Gb/sec. or 4 GB/sec. and turns off for an FC speed of 1GB/sec. When disabled, the LED lights for an FC speed of 4 Gb/sec. and turns off for FC speeds of 1 Gb/sec. or 2Gb/sec.

Default: disabled

set FCSpeedLED2G [enabled | disabled]

get FCSpeedLED2G

## FCWWName

Reports the Word Wide Name (WWN) of the FC interface. Each FC port has an individual and unique WWN.

get FCWWN [PortNumber]



## FirmwareRestart

Causes the FibreBridge to reboot, then re-initialize its firmware. Use the **forced** option to override any CLI reservation held by other sessions.

FirmwareRestart <forced>

## Help

Displays a list of available commands. If command name is specified, displays detailed command-specific information.

Help [command name]

## IdentifyBridge

Enabling this option causes the Ready LED on the FibreBridge to blink until the parameter is disabled.

set IdentifyBridge [enabled | disabled]  
get IdentifyBridge

## Info

Displays version numbers and other production information for key components within the FibreBridge

Info

## IPAddress

Controls/displays the current FibreBridge IP address. If [IPDHCP](#) is enabled, **get** command reports current IP address assigned by the DHCP server.

Default IP address: 10.0.0.1  
set IPAddress [mp1] [xxx.xxx.xxx.xxx]  
Requires a SaveConfiguration Restart command  
get IPAddress [mp1]

## IPDHCP

Selecting DHCP allows the FibreBridge to request an IP address from the network. The network must have at least one DHCP server.

Default: enabled  
set IPDHCP [mp1] [enabled | disabled]  
Requires a SaveConfiguration Restart command  
get IPDHCP [mp1]

## IPDNSServer

Controls the current DNS Server address. If [IPDHCP](#) is enabled, the DNS Server address is automatically detected. If IPDHCP is disabled, you must set the address manually using this command.

set IPDNSServer [xxx.xxx.xxx.xxx]  
get IPDNSServer

## IPGateway

Regulates/displays the current gateway. If [IPDHCP](#) is enabled, **get** command reports current IP gateway assigned by a DHCP server.

Default: 0.0.0.0  
set IPGateway [mp1] xxx.xxx.xxx.xxx  
Requires a SaveConfiguration Restart command  
get IPGateway [mp1]

## IPSubnetMask

Regulates/displays the current subnet mask. If [IPDHCP](#) is enabled, **get** command reports current subnet mask assigned by DHCP server.

Default: 255.255.0.0  
set IPSubnetMask xxx.xxx.xxx.xxx  
Requires a SaveConfiguration Restart command  
get IPSubnetMask

## IsReserved

Displays the reservation status of the current FibreBridge.

command: IsReserved

## LogicalUnitAddressing

Controls the current device mapping method on the bridge. When disabled, standard peripheral device mapping and formatting is used. Target devices are only made visible to the specific mapped Fibre Channel port. When enabled, static device mapping and formatting is achieved with a discovery bus scan at boot. All target devices are visible to all Fibre Channel ports, with each port sharing a common Fibre Channel Node Name.

Default: disabled  
set LogicalUnitAddressing [enabled|disabled]  
get LogicalUnitAddressing

## MaxOpTemp (FB2390, FB2400 only)

Regulates/displays the maximum enclosure temperature alarm of the FibreBridge in degrees Celsius. If the temperature of the FibreBridge rises above the maximum MaxOpTemp, thermal control event handling occurs. Valid entries are between 55 degrees and 70 degrees

Default: 70  
set MaxOpTemp [55-70]  
Requires a SaveConfiguration Restart command  
get MaxOpTemp

### MinOpTemp (FB2390, FB2400 only)

Regulates/displays the minimum enclosure temperature alarm of the FibreBridge in degrees Celsius. Valid entries are between 0 degrees and 15 degrees

Default: 0

set MinOpTemp [0-15]

Requires a SaveConfiguration Restart command

get MinOpTemp

### OpTempWarn (FB2390, FB2400 only)

Regulates/displays the number of degrees in Celsius before a warning is sent to the user. Valid entries are between 0 degrees and 15 degrees

Default: 5

set OpTempWarn [0-15]

Requires a SaveConfiguration Restart command

get OpTempWarn

### Password

Specifies password for all non-serial sessions: Telnet, FTP and ExpressNAV interface. You are prompted for the current password, to enter the new password, and to confirm the new password. If local Echo is enabled, password echoes all \* characters. If [VerboseMode](#) has been enabled, CLI requests that you re-enter the password. When the password is all 0s, Telnet and FTP do not validate the password and MD5 authentication is disabled. Configure an empty password by pressing the **Enter** key when prompted for the new password and the new password confirmation. Passwords are case sensitive and can be 1-32 characters long with no spaces.

Default: Password

set Password

Requires a SaveConfiguration command

### Performance

Returns the performance data for the FC port you specify. Data includes the average rate (MB per sec.) and number of I/Os measured over the previous sampling period where a sampling period is approximately one second. Successful SCSI Read (08h, 28h) and Write (0ah, 2Ah) commands are considered I/Os. Reported performance may be affected by FC port and SCSI bus availability and saturation, SCSI device speeds and overall system use.

get Performance <fp>

### Ping

Sends an ICMP echo request to the specified host.

Ping [mp1] [xxx.xxx.xxx.xxx] <count <size>>

xi

ATTO Technology Inc. FibreBridge Installation and Operation Manual

### ReadOnlyPassword

Specifies password for all non-serial sessions: Telnet, FTP and ExpressNAV interface. ReadOnlyPassword is case sensitive, 0 to 32 characters, and cannot contain spaces. Configure an empty password by not specifying one.

Default: Password

set ReadOnlyPassword

Requires a SaveConfiguration command

### ReadOnlyUsername

Specifies user name for all Telnet, FTP and ExpressNAV user management console sessions. **Username** is case insensitive, 1-32 characters, no spaces.

Default: User

set ReadOnlyUsername

Requires a SaveConfiguration command

get ReadOnlyUsername

### Reserve

Prevents other CLI sessions from modifying the FibreBridge. When the FibreBridge services interface is reserved, set commands are unavailable but get commands are available. At least one service interface always has access to the FibreBridge at all times. This interface always reports **RELEASED** status, since it may issue set commands. Reservation of the FibreBridge is implicit: if the configuration is changed by any user of CLI sessions, the FibreBridge becomes **RESERVED**. Executing a **SaveConfiguration** command, **RestoreConfiguration** or **FirmwareRestart** forced releases the FibreBridge so that other devices may modify it.

Reserve

### Reset FCPortErrors

Resets all FC error counts for the specified port to zero. Refer to [FCPortErrors](#).

command: ResetFCPortErrors [fp | all]

### RestoreConfiguration

Restores configuration to either the default configuration or the configuration last saved into non-volatile memory. The saved option undoes any changes made since the last save.

RestoreConfiguration [Default | Saved]

## Route

Assigns a Fibre Channel address to a target destination device. If you try to map a new SCSI BTL to the same FC LUN, the new BTL overwrites the previous map. Using the delete identifier removes the map from its table. If [VerboseMode](#) has been enabled, overwriting an existing map requires secondary confirmation.

Route FC [fp] [lun] [SCSI <sb st sl> | Bridge | Delete ]

## RouteDisplay

Displays a list of Fibre Channel to SCSI address mappings on the FibreBridge.

RouteDisplay FC <fp> <lun>

## SaveConfiguration

Many commands require a **SaveConfiguration** command to be executed as indicated by the return **Ready**. \*. When you invoke a **SaveConfiguration** command, the current configuration is permanently saved in the FibreBridge and the new configuration becomes the active configuration. If a firmware restart is required to make the requested change permanent, you are asked to confirm the restart. You can override this request by indicating the override value on the command line. You may make several changes through commands before implementing the restart, but once you have restarted the FibreBridge, all the command changes created before the restart and save are implemented. If you select the restart option, the FibreBridge executes its complete start up cycle.

SaveConfiguration <Restart | NoRestart>

## SCSIDomainValidation

Runs domain validation tests on the SCSI system which may detect problems with SCSI cables, termination or damaged transceivers. Disable [VirtualDriveResponse](#) before running the test. If tape drives are attached to the FibreBridge, ensure they are loaded with media: media is not overwritten with this test. Reboot the FibreBridge after running this test.

SCSIDomainValidation

## SCSIInitID

Specifies or reports the SCSI initiator ID on the specified SCSI port as found in NVRAM. All maps coinciding with the user-specified SCSIInitID are destroyed after the command completes.

Default: 7

set SCSIInitID [sb [0-15] ]

get SCSIInitID

## SCSIPortBusSpeed

Controls the transfer rate at which the FibreBridge negotiates with its SCSI devices. Valid options are Fast SCSI, Ultra SCSI, Ultra 2 SCSI, Ultra160 SCSI and Ultra320 SCSI.

Default: ultra320

set SCSIPortBusSpeed [sb [ fast | ultra | ultra2 | ultra160 | ultra320 ]

Requires a SaveConfiguration command

get SCSIPortBusSpeed [sb]

## SCSIPortList

Returns a list of available SCSI ports and their current status. Valid status values are **OK** and **Failed**

SCSIPortList

## SCSIPortReset

Resets the specified SCSI bus.

SCSIPortReset [sb]

## SCSIPortResetOnStartup

Specifies if the SCSI port should be reset on power-up.

Default: enabled

set SCSIPortResetOnStartup [sb [enabled | disabled] ]

Requires a SaveConfiguration command

get SCSIPortResetOnStartup [sb]

## SCSIPortSyncTransfer

Specifies whether synchronous SCSI transfers should be negotiated with devices on the specified SCSI port.

Default: enabled

set SCSIPortSyncTransfer [sb ] [enabled | disabled]

Requires a SaveConfiguration command

get SCSIPortSyncTransfer [sb]

### **SCSIPortTermination**

*Configures/reports the SCSI internal termination of the SCSI port identified on the FibreBridge. Enabling termination allows the FibreBridge to act as a terminator at the end of a SCSI chain.*

Default: enabled

set SCSIPortTermination [sb] [enabled | disabled]

Requires a SaveConfiguration command

get SCSIPortTermination [sb]

### **SCSIPortWideTransfer**

*Specifies whether wide SCSI transfers should be negotiated. Enabled allows wide transfer negotiation*

Default: enabled

set SCSIPortWideTransfer [sb] [enabled | disabled ]

Requires a SaveConfiguration command

get SCSIPortWideTransfer

### **SCSITargetLUNs**

*Controls the maximum number of SCSI LUNs per target the FibreBridge queries during a SCSI bus scan.*

Default: 8

set SCSITargetLUNs [sb] [8 | 64]

Requires a SaveConfiguration command

get SCSITargetLUNs [sb]

### **SCSITargets**

*Lists the physical devices connected and running on the specified SCSI port.*

SCSITargets [sb]

### **SerialNumber**

*Reports the FibreBridge serial number. The serial number, unique for each FibreBridge, is a 13-character field. The first seven alphanumeric characters are an abbreviation of the FibreBridge name while the remaining six numbers are the individual FibreBridge board's number.*

get SerialNumber

### **SerialPortBaudRate**

*Configures/reports the baud rate for the FibreBridge RS-232 serial port or header. The number of data bits per character is fixed at 8 with no parity. Choices are 9600, 19200, 38400, 57600 and 115200*

Default: 115200

set SerialPortBaudRate [9600 | 19200 | 38400 | 57600 | 115200]

Requires a SaveConfiguration Restart command

get SerialPortBaudRate

### **SerialPortEcho**

*Control/reports the status of the display of keyboard input. When enabled, all non-control character keyboard input is output to the display. Local ASCII terminal (or terminal emulator) echo settings should be set to **disabled** while using **SerialPortEcho enabled***

Default: enabled

set SerialPortEcho [enabled | disabled]

Requires a SaveConfiguration Restart command

get SerialPortEcho

### **SNMP**

*Controls whether or not SNMP functions on the FibreBridge.*

SNMP [enabled | disabled]

Default: enabled

### **SNMPDumpMIB**

*Displays the contents of the ATTO FibreBridge private SNMP MIB to the current CLI session. Consult your network administrator for further assistance with SNMP.*

SNMPDumpMIB

### **SNMPExtendedTraps**

*Controls Extended SNMP trap functioning such as device transition and device error. Consult your network administrator for further assistance with SNMP.*

Default: disabled

set SNMPExtendedTraps [enabled | disabled]

get SNMPExtendedTraps

## SNMPTrapAddress

*Sets/displays the IP trap addresses and levels. Consult your network administrator for further assistance with SNMP.*

Index: value between 1 and 6  
IPAddress: standard IP address for the host receiving messages; must be in the same subnet as the FibreBridge  
Trap Level: severity required for an event to trigger a trap:  
None: no traps are sent to the address  
ALL: all triggering events are sent  
Warning: warning and critical events are sent  
Critical: only critical events trigger a trap  
Default: 0.0.0.0 none  
set SNMPTrapAddress [Index] [IPAddress] [None | All | Warning | Critical ]  
get SNMPTrapAddress [index]

## SNMPTraps

*Controls SNMP trap functions. Consult your network administrator for further assistance with SNMP.*

Default: disabled  
set SNMPTraps [enabled | disabled]  
get SNMPTraps

## SNTP

*Controls whether the FibreBridge contacts a specified SNTP time server to initialize or synchronize the time.*

Default: enabled  
set SNTP [enabled | disabled]  
Requires a SaveConfiguration Restart command  
get SNTP

## SNTPServer

*Controls/displays the main IP address of the SNTP time server. If the FibreBridge is unable to contact the specified SNTP timeserver within 30 seconds, the FibreBridge tries to contact the first auxiliary SNTP time server. If not successful, the FibreBridge tries to contact the second auxiliary server. If not successful, the FibreBridge continues to keep time based on the most recent SNTP time server, physical RTC or manual initialization or synchronization*

Default: 192.43.244.18 (time.nist.gov)  
set SNTPServer xxx.xxx.xxx.xxx  
Requires a SaveConfiguration Restart command  
get SNTPServer

## SpeedWrite

*SpeedWrite is a method to improve the performance of WRITE commands to SCSI tape devices attached to the FibreBridge. You can specify the SCSI bus, target and LUN of a mapped device or specify **all** to control the state of all currently mapped SCSI devices.*

Default: all disabled  
set SpeedWrite SCSI [sb st sl | all] [enabled | disabled]  
Requires a SaveConfiguration command  
get SpeedWrite SCSI [sb st sl | all]

## SpeedWriteDefault

*Specifies the state of [SpeedWrite](#) for any SCSI devices mapped manually or using an [AutoMap](#) command. If enabled, any new SCSI device uses [SpeedWrite](#) automatically.*

Default: disabled  
set SpeedWriteDefault [enabled | disabled]  
Requires a SaveConfiguration command  
get SpeedWriteDefault

## TailEventLog

*Displays new events to the terminal. Type **quit** and press **Enter** to exit.*

TailEventLog

## Temperature (FB2390, FB2400 only)

*Displays the current internal temperature of the FibreBridge in degrees Celsius.*

get Temperature

## Time

*Controls/displays the time in a 24-hour format. The default time is 00:00:00 and is accurate until the FibreBridge is reset or power-cycled when it returns to the default. **Time** cannot be set if [SNTP](#) is enabled.*

Default: 0:00:00  
set Time [HH :MM :SS]  
Requires a SaveConfiguration command  
get Time

## TimeZone

Controls/displays the time zone if [SNTP](#) is disabled. Setting may be EST, CST, MST PST or a numerical offset from GMT in the format +/- HH:MM. When [SNTP](#) is enabled, applies the time zone setting to the time retrieved from a specified SNTP time server to determine local time.

Default: EST  
set TimeZone [EST | CST | MST | PST | [+ / - HH : MM]]  
Requires a SaveConfiguration command  
get TimeZone

## TraceLog

When enabled, records various system events to the trace log.

Default: disabled  
set TraceLog [enabled | disabled]  
get TraceLog

## TraceLogFilter

Filters the display of data for specific FibreBridge ports when [TraceLog](#) is enabled.

Default: all all  
set TraceLogFilter [FC | SCSI | all] [fp | sb | all] [none | ChkCond | all]  
get TraceLogFilter [FC | SCSI | all] [fp | sb | all]

## Username

Specifies user name for all Telnet, FTP and ExpressNAV user management console sessions. **Username** is case insensitive, 1-32 characters, no spaces

Default: root  
set Username  
Requires a SaveConfiguration command  
get Username

## VerboseMode

Specifies the detail of feedback for the command line interface. Disabling this option removes parameter names from action commands and removes descriptions from information commands.

Default: enabled (returns have parameter information)  
set VerboseMode [enabled | disabled]  
get VerboseMode

## VirtualDriveResponse

Provides proxy responses to SCSI INQUIRY and TEST UNIT READY commands if a SCSI device is in a timeout or busy. Host systems may then assign devices consistently despite the device's state during execution of SCSI commands.

Default: disabled  
set VirtualDriveResponse [enabled | disabled]  
Requires a SaveConfiguration restart command  
get VirtualDriveResponse

## VirtualRobotResponse

Provides proxy responses to SCSI INQUIRY commands if an existing SCSI command is outstanding to a Media Changer. All other SCSI commands are returned with a NOT READY check condition.

Default: disabled  
set VirtualRobotResponse [enabled | disabled]  
Requires a SaveConfiguration restart command  
get VirtualRobotResponse

## Voltage (FB2350, FB2400 only)

Displays the voltage levels monitored by the FibreBridge.

VDDA: +3.31 V  
Vddb: +2.49 V  
VDDC: +1.5V  
VDDD: +1.35V  
ALL: all monitored voltages  
get Voltage [VDDA | Vddb | VDDC | VDDD | all]

## WrapEventLog

When enabled, the FibreBridge logs up to 2,048 event entries before wrapping (overwriting the first entries). If disabled, the FibreBridge stops logging event entries when the buffer is full.

Default: enabled  
set WrapEventLog [enabled | disabled]  
Requires a SaveConfiguration command  
get WrapEventLog

## WrapTraceLog

When enabled, the FibreBridge logs up to 2,048 trace entries before wrapping (overwriting the first entries). If disabled, the FibreBridge stops logging trace entries when the buffer is full.

Default: enabled  
set WrapTraceLog [enabled | disabled]  
get WrapTraceLog

## **zModem**

*Allows transfer of a firmware image to or from the FibreBridge using the zModem file transfer protocol. Available only through the RS232 interface.*

zModem [Send filename | Receive]



### **CAUTION**

**After a firmware image is downloaded to the FibreBridge, the image is placed into flash memory. During this time (about 30 seconds), DO NOT remove power to the FibreBridge or the flash may become corrupted.**

## Appendix C Standards and compliances

*The equipment described in this manual generates and uses radio frequency energy. If this equipment is not used in strict accordance with the manufacturer's instruction, it can and may cause interference with radio and television reception. Refer to the ATTO FibreBridge Technical Specification sheet for your particular model for a full list of certifications for that model.*



### FCC Standards: Radio and Television Interference

This equipment has been tested and found to comply with the limits for a Class A digital device, pursuant to Part 15 of the FCC Rules. These limits are designed to provide reasonable protection against harmful interference when the equipment is operated in a commercial environment. This equipment generates, uses and can radiate radio frequency energy and, if not installed and used in accordance with the instruction manual, may cause harmful interference to radio communications. Operation of this equipment in a residential area is likely to cause harmful interference in which case the user will be required to correct the interference at own expense.

If this equipment does cause interference to radio and television reception, which can be determined by turning the equipment off and on, try to correct the interference by one or more of the following measures:

- Move the receiving antenna.
- Relocate the bridge with respect to the receiver, or move the bridge away from the receiver.
- Plug the computer into a different outlet so the computer and receiver are on different branch circuits.
- If necessary, consult an ATTO authorized dealer, ATTO Technical Support Staff, or an experienced radio/television technician for additional suggestions.

The booklet *How to Identify and Resolve Radio/TV Interference Problems* prepared by the Federal Communications Commission is a helpful guide. It is available from the US Government printing office, Washington, DC 20402, Stock No. 004-000-00345-4.



### Canadian Standards

This Class A digital apparatus complies with Canadian ICES-003.

Cet appareil numérique de la classe A est conforme à la norme NMB-003 du Canada.



### European Standards Declaration of Conformity

This following statement applies to the ATTO FibreBridge.

This device has been tested in the basic operating configuration and found to be compliant with the following European Union standards:

Application of Council Directive: 89/336/EEC

Standard(s) to which conformity is declared: EN55022, EN50082-1, EN60950





In addition the FibreBridge 2370E conforms to EN55024.

This Declaration will only be valid when this product is used in conjunction with other CE approved devices and when the entire system is tested to the applicable CE standards and found to be compliant.

The ATTO FibreBridge 2370E, 2390 and 2400 comply with Directive 2002/95/EC on the Restriction of the Use of Hazardous Substances in Electrical and Electronic Equipment (RoHS).

### **Certification for the FibreBridge 2400 only**

UL60950-1/CSA C22.2 No. 60950-1



COMPLIES WITH

**UL 60950-1**

CSA C22.2

NO. 60950

ITE

LISTING NO: E112422

## Appendix D Warranty information

---

### **Manufacturer limited warranty**

Manufacturer warrants to the original purchaser of this product that it will be free from defects in material and workmanship as described in the ATTO Technology website, [www.attotech.com](http://www.attotech.com).

Manufacturer liability shall be limited to replacing or repairing, at its option, any defective product. There will be no charge for parts or labor should Manufacturer determine that this product is defective.

Products which have been subject to abuse, misuse, alteration, neglected, or have been serviced, repaired or installed by unauthorized personnel shall not be covered under this warranty provision. Damage resulting from incorrect connection or an inappropriate application of this product shall not be the responsibility of Manufacturer. Manufacturer's liability is limited

to Manufacturer's product(s); damage to other equipment connected to Manufacturer's product(s) will be the customer's responsibility. This warranty is made in lieu of any other warranty, express or implied. Manufacturer disclaims any implied warranties of merchantability or fitness for a particular purpose. Manufacturer's responsibility to repair or replace a defective product is the sole and exclusive remedy provided to the customer for breach of this warranty. Manufacturer will not be liable for any indirect, special, incidental, or consequential damages irrespective of whether Manufacturer has advance notice of the possibility of such damages. No Manufacturer dealer, agent or employee is authorized to make any modification, extension or addition to this warranty.



## Free Manuals Download Website

<http://myh66.com>

<http://usermanuals.us>

<http://www.somanuals.com>

<http://www.4manuals.cc>

<http://www.manual-lib.com>

<http://www.404manual.com>

<http://www.luxmanual.com>

<http://aubethermostatmanual.com>

Golf course search by state

<http://golfingnear.com>

Email search by domain

<http://emailbydomain.com>

Auto manuals search

<http://auto.somanuals.com>

TV manuals search

<http://tv.somanuals.com>