

DS9106/DS9106PK

9" Portable DVD Player

Table of Contents

A. Introduction	7
B. DVD and Disc Information	7
C. Contents	8
D. Powering and Installation	8
E. Vehicle Installation	9
F. Controls, Indicators, and Connectors.....	10
G. Loading and Playing a Disc	12
H. Basic Operation.....	12
I. Menu	13
J. Display.....	13
K. Playing Audio CDs.....	18
L. Playing JPEG Files.....	19
M. Connecting to Other Electronic Equipment.....	20
N. Setup	21
O. Specifications	29
P. Rechargeable Built-in Battery Use.....	29
Q. Troubleshooting	31



Important Safety Instructions

Some of the following information may not apply to your particular product; however, as with any electronic product, precautions should be observed during handling and use.

- | Read all instructions prior to use.
- | Keep these instructions.
- | Heed all warnings.
- | Follow all instructions.
- | Do not use the DVD Player near water.
- | Clean only with dry cloth.
- | Do not install near any heat sources such as radiators, heat registers, stoves, or other apparatus (including amplifiers) that produce heat.
- | Do not defeat the safety purpose of the polarized or grounding-type plug. A polarized plug has two blades with one wider than the other. A grounding type plug has two blades and a third grounding prong. The wide blade or the third prong is provided for your safety. If the provided plug does not fit into your outlet, consult an electrician for replacement of the obsolete outlet.
- | Protect the power cord from being walked on or pinched particularly at plugs, convenience receptacles, and the point where they exit from the DVD Player.
- | Only use attachments/accessories specified by the manufacturer.
- | Unplug this DVD Player during lightning storms or when unused for long periods of time.
- | Refer all servicing to qualified service personnel. Servicing is required when the DVD Player has been damaged in any way, such as power-supply cord or plug is damaged, liquid has been spilled or objects have fallen into the DVD Player, the DVD Player has been exposed to rain or moisture, does not operate normally, or has been dropped.

Additional Safety Information

- | An LCD panel or video monitor used for television reception, video or DVD play that operates when the vehicle is in gear or when the parking brake is not applied must be installed to the rear of the driver's seat where it will not be visible, directly or indirectly, to the operator of the motor vehicle.
- | CAUTION! CD and DVD products utilize a laser. Do not try to open the product. Refer all servicing to qualified service personnel.
- | CAUTION! Danger of explosion if battery is incorrectly replaced. Replace only with the same or equivalent type.
- | Warning: Your DVD player contains a battery and charging system which is designed to work in temperatures that do not exceed 50°C (122°F). Leaving this product in a closed automobile or in the trunk of an automobile where temperature may exceed 50°C may result in permanent battery damage, fire, or explosion. Please remove your product from the automobile when you exit, do not place your product in the trunk of your automobile, and do not leave your product in any location where temperature may exceed 50°C.

 <p>THE LIGHTNING FLASH AND ARROWHEAD WITHIN THE TRIANGLE IS A WARNING SIGN ALERTING YOU OF "DANGEROUS VOLTAGE" INSIDE THE PRODUCT.</p>	<p>CAUTION</p> <p>RISK OF ELECTRIC SHOCK DO NOT OPEN</p> <p>CAUTION: TO REDUCE THE RISK OF ELECTRIC SHOCK, DO NOT REMOVE COVER (OR BACK). NO USER-SERVICEABLE PARTS INSIDE REFER SERVICING TO QUALIFIED SERVICE PERSONNEL.</p>	 <p>THE EXCLAMATION POINT WITHIN THE TRIANGLE IS A WARNING SIGN ALERTING YOU OF IMPORTANT INSTRUCTIONS ACCOMPANYING THE PRODUCT.</p>
<p>SEE MARKING ON BOTTOM/ BACK OF PRODUCT</p>		

WARNING: TO PREVENT FIRE OR ELECTRICAL SHOCK HAZARD, DO NOT EXPOSE THIS PRODUCT TO RAIN OR MOISTURE.

FCC Information

This device complies with part 15 of the FCC rules. Operation is subject to the following two conditions: (1) this device may not cause harmful interference, and (2) this device must accept any interference received, including interference which may cause undesired operation.

This equipment has been tested and found to comply with the limits for a Class B digital device, pursuant to Part 15 of the FCC Rules. These limits are designed to provide reasonable protection against harmful interference in a residential installation. This equipment generates, uses and can radiate radio frequency energy and, if not installed and used in accordance with the instructions, may cause harmful interference to radio communications. However, there is no guarantee that interference will not occur in a particular installation.

If this equipment does cause harmful interference to radio or television reception, which can be determined by turning the equipment off and on, the user is encouraged to try to correct the interference by one or more of the following measures:

- Reorient or relocate the receiving antenna.
- Increase the separation between the equipment and receiver.
- Connect the equipment into an outlet on a circuit different from that to which the receiver is connected.
- Consult the dealer or an experienced radio / TV technician for help.

In accordance with FCC requirements, changes or modifications not expressly approved by manufacturer could void the user's authority to operate this product.

Manufacturer

Audiovox Electronics Corp.,
150 Marcus Blvd., Hauppauge, NY 11788

Service Information

This product should be serviced only by those specially trained in appropriate servicing techniques. For instructions on how to obtain service, refer to the warranty included in this user manual.

For Your Records

Keep your sales receipt for proof of purchase to obtain warranty parts and service.

In the event that service should be required, you may need both the model number and the serial number. In the space below, record the date and place of purchase, and the serial number:

Model No.

Date of Purchase

Place of Purchase

Serial No.

A. Introduction

Thank you for choosing the DS9106/DS9106PK portable DVD player. The main features include a 9" wide Screen (16:9 Aspect Ratio) Liquid Crystal Display (LCD) monitor and a DVD player. The unit applies the latest state of the art electronics and is designed for use in hotels, offices or your home. The unit is constructed to provide years of reliable, trouble-free service and is compact so that you can take it with you anywhere and is designed for quick and easy installation. Please read the entire instruction manual supplied with this product prior to using. The documentation will assist you in using the system properly to obtain the best equipment performance. Please save this manual for later use.

B. DVD and Disc Information

DVD Copy Protection - This Product incorporates copyright protection technology that is protected by method claims of certain U.S. Patents and other intellectual property rights owned by Macrovision Corporation and other rights owners. Use of this copyright protection technology must be authorized by Macrovision Corporation, and is intended for home and other limited viewing uses only unless otherwise authorized by Macrovision Corporation. Reverse engineering or disassembly is prohibited.

DVD Regional Code - Your DVD player has been designed to process regional management information that is stored on DVD discs. The regional code for your player is 1 (The U.S., & U. S. Territories and Canada). Only DVD discs that have regional codes of 1 or ALL (for all regions) can be played by your player.



Discs - Do not use irregularly shaped discs such as heart or star-shaped discs as they may cause the unit to malfunction. Do not stick paper, tape or glue on the disc. Do not expose the disc to direct sunlight or heat sources such as hot air ducts. Do not touch the surface of the disc. Handle the disc by its edge. Clean the disc by wiping the disc from the center out with a cleaning cloth. Remove the disc from the unit and store it in its case after playing. Some playback operations of discs may be intentionally fixed by software producers. Since this unit plays discs according to the disc contents the software producers designed, some playback features may not be available. Also refer to the instructions supplied with the discs.

C. Contents

1. 1 x 9" Portable DVD Player with built in battery*
2. 1 x AC to DC Power Adapter
3. 1 x Automotive Power Adapter
4. 1 x Carrying Bag**
5. 2 x Foldable Headphones**
6. 1 x Instruction Manual
7. 1 x Product Registration Card
8. 1 x eMusic Card

* DS9106 & DS9106PK can operate on a fully charged battery for six hours.

** Only for DS9106PK.

D. Powering and Installation

1. Powering the System Indoors (Refer to Figure 1)

Plug one end of the AC to DC adapter into the DC input jack on the right side of the main unit, then plug the other end into the 100~240V AC power receptacle.

2. Powering the System in a Car (Refer to Figure 1)

Plug one end of the Automotive Power adapter into the DC input jack on the unit, then plug the other end into the vehicle power outlet.

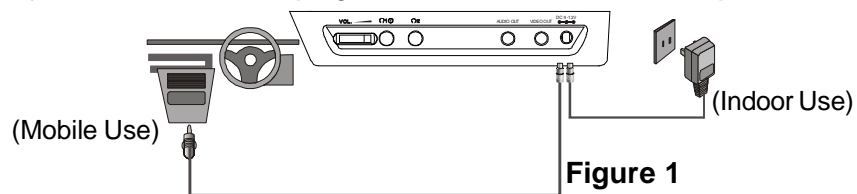

3. To Charge the Built-in Battery

Plug one end of the AC to DC power adapter into the DC jack on the side of the player, as shown in Figure 1, then plug the other end into the 100~240V AC power outlet. If the player is powered off, the charge indicator will turn red indicating the battery is charging.

Once fully charged, the charge indicator will turn off. Once the indicator is off, remove the AC to DC power adapter wall plug.

NOTE: Your new battery must be charged a minimum of eight hours before the first usage. DS9106/DS9106PK needs seven hours to fully recharge the battery.

E. Vehicle Installation *

Installing the DVD Player onto the Seat Back in a Car

(Refer to Figure 2) Carrying Bag Opened

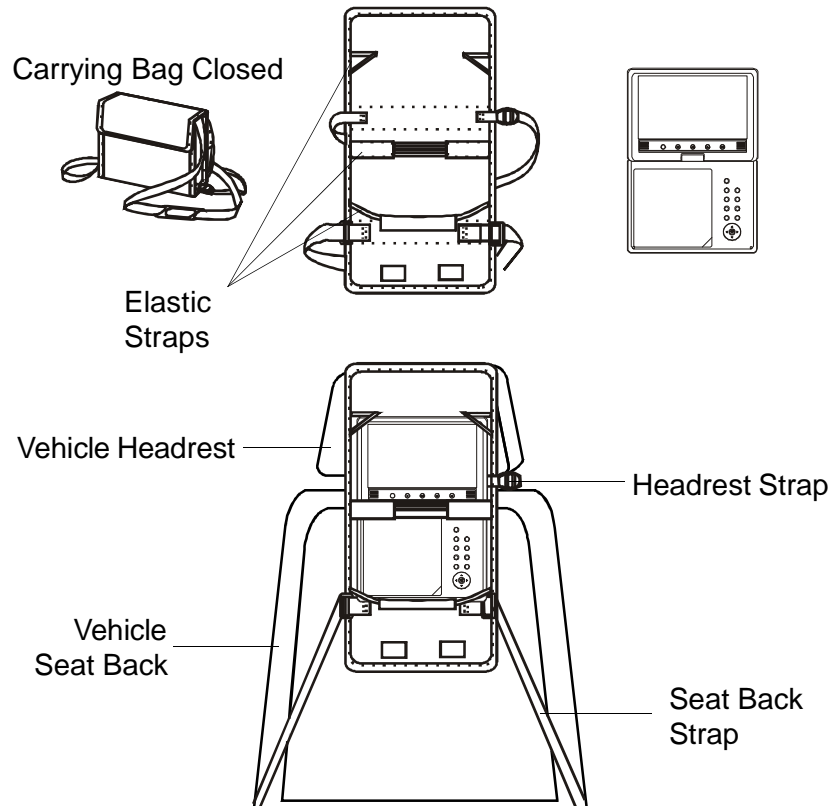

Figure 2

- 1) Unfold the carrying bag, and place the DVD player on the bag beneath the elastic straps. Ensure that the unit's corners are secured by the elastic straps.
- 2) Secure the upper portion of the carrying bag to the headrest support bars using the headrest strap. Adjust the headrest strap until the bag is firmly secured.
- 3) Secure the lower portion of the carrying bag to the vehicle seat back using the seat back strap. Adjust the seat back strap until the bag is firmly secured.

* The bag is only provided for DS9106PK.

F. Controls, Indicators, and Connectors

1. Unit View (Refer to Figure 3)

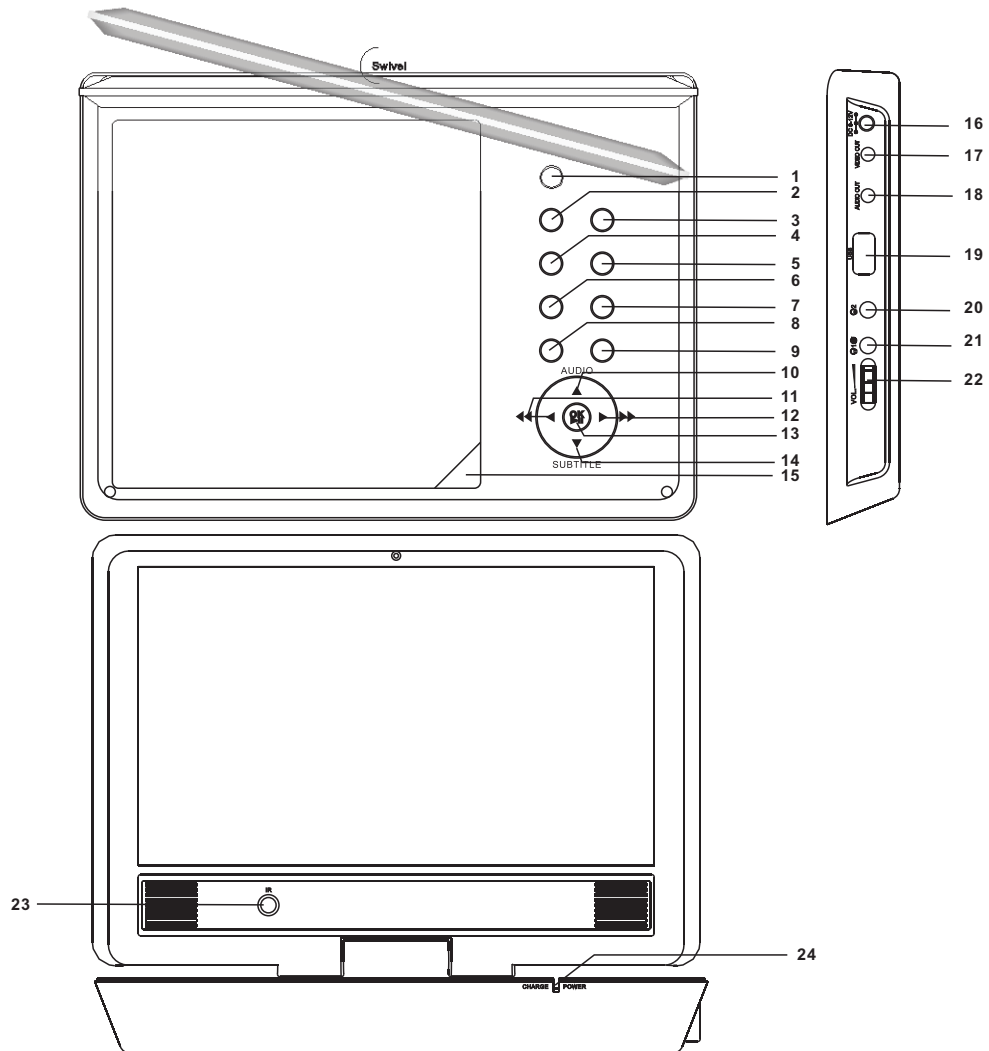

Figure 3

- | | |
|-------------------------------------|----------------------------------|
| 1) ⏻ Power Button | 13) OK/ ▶ OK play/pause Button |
| 2) Setup Button | 14) DOWN/SUBTITLE Button |
| 3) Source Button | 15) Cover Open Button |
| 4) Display Button | 16) DC 9-12 V Input Jack |
| 5) Repeat Button | 17) Video Out Jack |
| 6) ◀◀ Previous Button | 18) Audio Out Jack |
| 7) ▶▶ Next Button | 19) USB Jack |
| 8) Menu Button | 20) Headphone Jack 2 |
| 9) Stop Button | 21) Headphone Jack 1* |
| 10) UP/AUDIO button | 22) Volume Control |
| 11) ◀ /◀◀ Left/Fast Backward Button | 23) IR Window |
| 12) ▶ /▶▶ Right/Fast Forward Button | 24) Charge/Power LED |

* Connecting to the headphone jack will disable the internal speakers.

2.Remote Control View (Refer to Figure 4)

- 1) Setup Button
- 2) Up Button
- 3) Previous Button
- 4) Enter Button
- 5) Reverse Scan /Left Button
- 6) Down Button
- 7) Numeric Keypad
- 8) Display Button
- 9) Zoom Button
- 10) Source Button
- 11) Next Button
- 12) A-B Repeat Button
- 13) Forward Scan /Right Button
- 14) 1/All Repeat Button
- 15) Stop Button
- 16) Menu Button
- 17) Subtitle Button
- 18) Audio Button
- 19) Angle Button

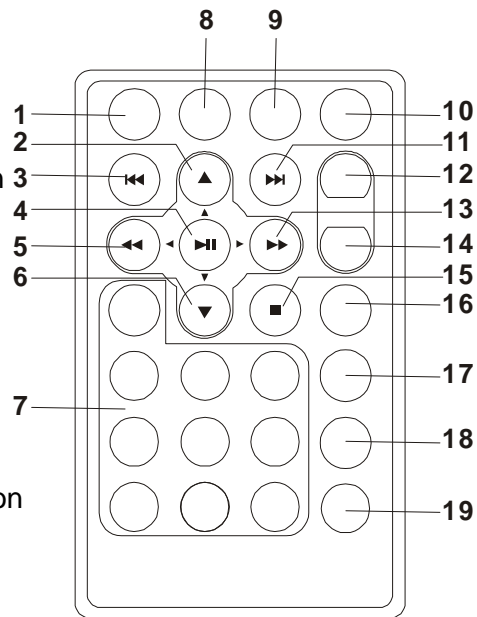

Figure 4

G. Loading and Playing a Disc

- a. After connecting power to the unit, press the $\text{\textcircled{P}}$ button to power ON the unit. The power indicator will turn green.
- b. Open the disc tray by pressing the OPEN button and place a disc into the tray with the label side facing up.
- c. Close the tray cover. The unit will load the disc and start playing.
- d. Rotate VOLUME control to adjust the DVD player's volume.
- e. To stop playing a disc, press the Stop button.
- f. To turn off the DVD player, press the $\text{\textcircled{P}}$ button.

H. Basic Operation

POWER	Turn the unit on
OPEN	Remove/load the disc
PLAY	Start Play/Execute item or setting
PAUSE	Press to pause play and again to restart play
STOP	Press once to stop at the present playing point. Press twice to stop playback of the DVD/CD
NEXT	Go to the next chapter, track or scene during playback
PREVIOUS	Go back to the previous chapter, track or scene during playback
LEFT/RIGHT/UP/DOWN	Use for Menu Navigation
OK	Execute item or confirm setting
MENU	Display the main menu of the disc
REPEAT	Repeat playing title, chapter, or track
DISPLAY	Display information (title, chapter, track, time, etc.)
SUBTITLE	Select the subtitle language or turn it on/off
AUDIO	Select the audio language
ZOOM	Enlarge an image to 2, 3, or 4 times the original size during DVD playback.
SETUP	Display the setup menu to select and set items, and exit the setup menu.

I. Menu

A DVD is divided into sections called titles and chapters. When you play a DVD, a root menu of the disc will appear on the screen of your TV or Monitor. The contents of the menu vary from disc to disc. Press MENU during playback to display the menu. Some DVDs only allow you to select disc playback options using the DVD root menu.

J. Display (Display contents vary from disc to disc.)

1. Playing Time and Remaining Time

- a. During playback press the DISPLAY button to display the current Title Number (1), the total Number of Titles (2), the current Chapter Number (3), the total Number of Chapters (4), and the elapsed playing Time for the title (5).

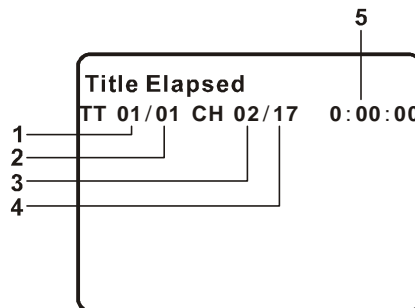

Title, Chapter Number and Time Screen Display

- b. Press the DISPLAY button again to display the Remaining Time of the title.

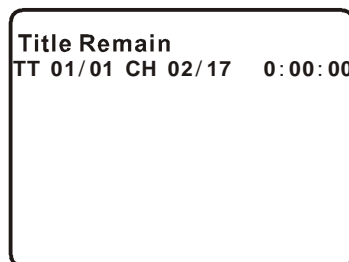

Title Remaining Time Screen Display

- c. Press the DISPLAY button a third time to display the Elapsed Time for the chapter.

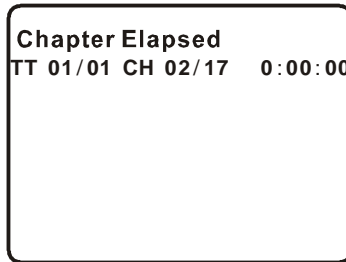

Chapter Elapsed Time Screen Display

- d. Press the DISPLAY button a fourth time to display the Remaining Time for the chapter.

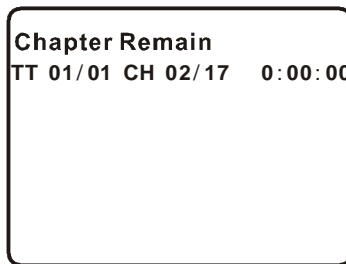

Chapter Remaining Time Screen Display

- e. Press the DISPLAY button a fifth time to exit, "DISPLAY OFF" will be displayed and will disappear automatically in 3 seconds.

2. Subtitle

During disc playback press the SUBTITLE button to select the subtitle language you desire*, with the current Subtitle Language Number (1) and the total Number of Subtitle Languages (2) displayed. If there are multiple languages, press the SUBTITLE button again to select another subtitle language. To turn subtitles OFF, press the SUBTITLE button until 'Subtitle off' is displayed. The Subtitle display will disappear automatically if the SUBTITLE button is not pressed again within 3 seconds.

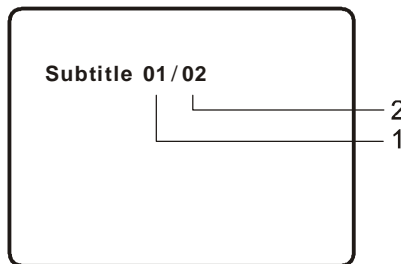

Subtitle Screen Display

* Some DVDs only allow access to this function through the DVD menu.

3. Audio

During playback press the AUDIO button to select the audio language you desire*, with the current Audio Channel Number (1) and the total number of Audio Channels (2) displayed. Press AUDIO again to select another audio language. The audio display will disappear automatically if the AUDIO button is not pressed within 3 seconds.

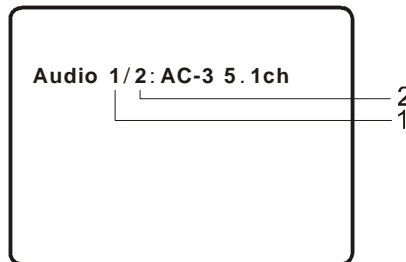

Audio Language Screen Display

* Some DVDs only allow access to this function through the DVD menu.

4. Zoom

During playback press the ZOOM button to enlarge the picture by 2x, 3x or 4X. Press the ZOOM button once, the picture will be enlarged 2X. Press the ZOOM button twice, the picture will be enlarged 3X. Press the ZOOM button a third time, the picture will be enlarged 4X. Press the ZOOM button a fourth time, the picture will return to normal size.

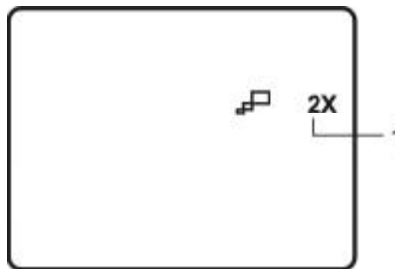

ZOOM Screen Display

5. Repeat

- a. During playback press the REPEAT button once to repeatedly play the current chapter.

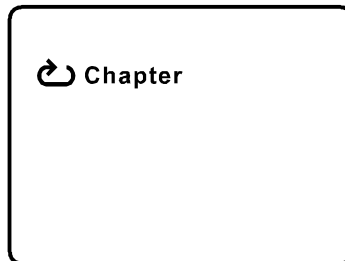

Chapter Repeat ON Screen Display

b. Press the REPEAT button again to repeatedly play the current title.



Title Repeat ON Screen Display

c. Press the REPEAT button a third time to repeat all chapters and titles.



All Repeat ON Screen Display

d. Press the REPEAT button a fourth time to resume normal playback.

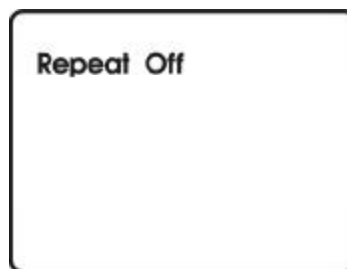

Repeat Off Screen Display

K. Playing Audio CDs

To play an audio CD, load it onto the disc tray and the CD will start playback automatically. Press the DISPLAY button repeatedly on the remote control or the unit to view disc information. The time information is displayed in the the following sequence:

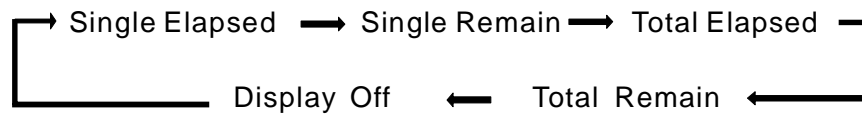

CD Display Mode

Single Elapsed: The current track playing and the elapsed time on that track appears on the screen.

Single Remain: The current track playing and the amount of time remaining on that track appears on the screen.

Total Elapsed: The current track playing and the total elapsed time on the CD appears on the screen.

Total Remain: The current track playing and the amount of time remaining on the CD appears on the screen.

L. Playing JPEG Files

- 1) Load a JPEG disc into the disc tray.
- 2) A screen showing folders or picture files contained on the disc will be displayed automatically after loading.
- 3) Press ▲, ▼ and OK buttons to select a folder or a picture. If a picture is selected, a photo slideshow will start with the selected picture.
- 4) Press the ZOOM button to enlarge the picture size by 100%, 125%, 150%, 200% . When the image is enlarged, you can use the navigation buttons to view the blocked parts of the picture.
- 5) During photo slideshow or in slideshow PAUSE mode:
 - Press ◀ to rotate the picture 90 degrees counterclockwise.
 - Press ▼ to mirror the picture horizontally.
 - Press ▲ to mirror the picture vertically.
 - Press ▶ to rotate the picture 90 degrees clockwise.
 - Press ◀◀ or ▶▶ to view the previous / next photo.
- 6) Press ▶|| button then the slideshow will pause.
Press the button again to resume the slideshow playback.
- 7) Press ■ STOP to view thumbnails. Use the navigation button to select a photo, press ▶|| to start slideshow from the selected photo.
- 8) Press MENU or ■ STOP to go to the folder where the picture is in.

M. Connecting to Other Electronic Equipment

1. Connecting to a TV or Another Monitor (Refer to Figure 4)

- Connect one end (1/8" stereo plug) of the audio cable (not supplied) into the unit's AUDIO OUT jack. Connect the other end (2 RCA jacks) to the Left and Right channel audio input jacks on your TV or monitor. (White = left audio channel, Red = right audio channel)
- Connect one end (1/8" plug) of the video cable (not supplied) into the unit's VIDEO OUT jack. Connect the other end (RCA jack) to the VIDEO INPUT jack on your TV or Monitor. (Yellow = video)

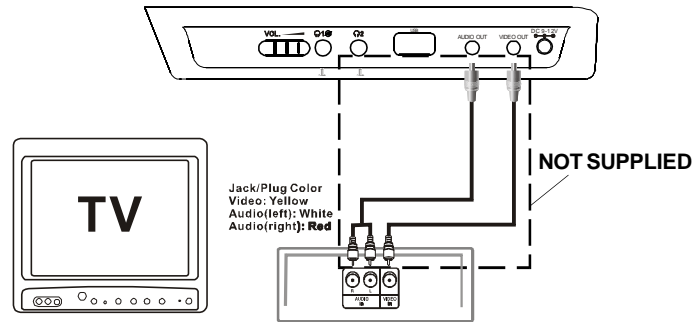

Figure 4

2. Connecting Headphones*

Plug the headphones into either Headphone jack 1 or Headphone jack 2 on the right side of the DVD Player.
(Refer to Figure 5)

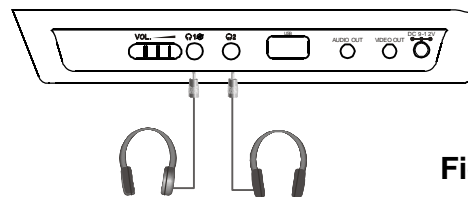

Figure 5

Plugging into Headphone jack 1 will disable the internal speakers.

* The headphones are only provided for DS9106PK.

N. Setup

Press SETUP button to display the Main screen of the SETUP Menu on the screen. Press SETUP button again to exit the SETUP Menu.

1. General Setup Page

Press SETUP, the 'GENERAL SETUP PAGE' will display on the screen.

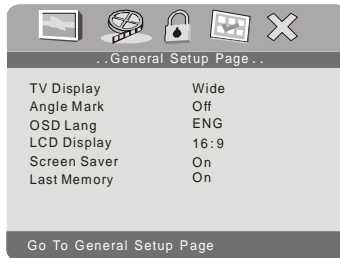

Main SETUP Menu Screen Display

a) TV Display

Select 'TV DISPLAY' using the DOWN button, and then press the Right button enter the submenu. Select the TV display mode on the screen using UP/DOWN button, and press the OK to confirm the setting. Press the LEFT button to exit the TV DISPLAY menu.

*NORMAL/PS: The wide-screen image will be displayed on the normal TV (4:3) in its native aspect ratio with some part on the left and right cut off.

*NORMAL/LB: The wide-screen image will be displayed on the normal TV (4:3) in its native aspect ratio with black bands on the upper and lower sections of the screen.

*WIDE: If the unit is connected to a wide-screen TV set, select this option. The widescreen image will be displayed in full screen in its native aspect ratio.

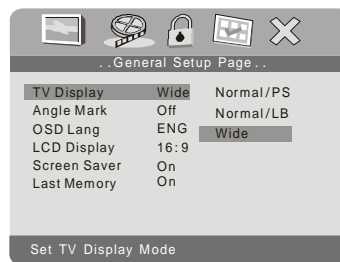

TV Display Screen Display

b) Angle Mark

Select 'ANGLE MARK' using the DOWN button, and then press the RIGHT button to enter the submenu. Choose Angle Mark on or off using the UP/DOWN button and then press the OK button to confirm the setting. Press the LEFT button to return.

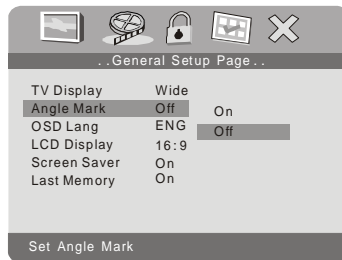

Angle Mark Screen Display

c) OSD Language

Select 'OSD LANG' using the DOWN button, and then press the RIGHT button to enter the submenu. Choose the language you desire as the display language. Press the LEFT button to return.



OSD Language Screen Display

d) LCD Display

Select 'LCD Display' using the DOWN button, and then press the RIGHT button to enter the submenu. Choose the LCD Aspect Ratio you desire as the display. Press the LEFT button to return.

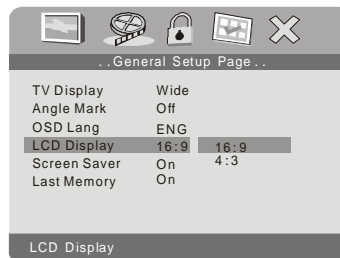

LCD Display Screen Display

e) Screen Saver

Select 'SCREEN SAVER' using the DOWN button and then press the RIGHT button to enter the submenu. Choose Screen saver on or off using the UP/DOWN buttons and then press the OK button to confirm the setting. Press the LEFT button to return.

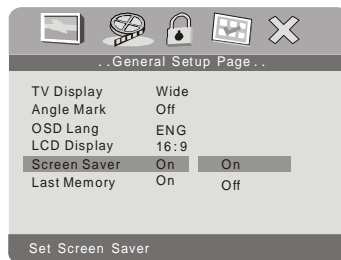

Screen Saver Screen Display

**ON: Enables screen saver.*

**OFF: Disables screen saver.*

NOTE: The DVD player will enter the Screen Saver mode after approximately five minutes if the same image remains on the screen.

f) Last Memory

Select 'LAST MEMORY' by using the DOWN button and then press the RIGHT button to enter the submenu. Choose Last Memory on or off using the UP/DOWN buttons and then press the OK button to confirm the setting. Press the LEFT button to return.



Last Memory Screen Display

**ON: During playback or in the pause mode, if you open the disc tray and then close without changing a disc, the unit will memorize the last playback status and resume playback from the memorized point.*

**OFF: The unit will not return to the last position on the disc.*

2. Video Quality Setup

Select 'VIDEO QUALITY SETUP' page by using the LEFT/RIGHT button, press the OK button to enter the 'VIDEO QUALITY SETUP' page.



Video Setup Page Screen Display

a) Select 'BRIGHTNESS' by using the UP or DOWN button, then press the OK button. Adjust the Brightness by pressing the LEFT or RIGHT button. To exit Brightness Setting, press the OK button again.



Brightness Screen Display

b) The "CONTRAST", "HUE", and "SATURATION" are adjusted in the same manner as the "BRIGHTNESS". Press the LEFT button to exit the VIDEO QUALITY SETUP menu.

3. Password Setup

Select 'PASSWORD SETUP PAGE' () using the LEFT or RIGHT buttons, then press the OK button to enter the submenu.



Password Setup Page Screen Display

Press the OK button twice to enter the PASSWORD CHANGE PAGE. Input the Old Password or the Default Password, the New Password, and the Confirmed New Password. Press the OK button to confirm the change.



Password Change Page Screen Display

NOTE: The Default Password is **3308**. This password is always effective even after you have selected your own password and changed it. To avoid the possibility of others using the default password to set the parental level and change the password, you can record this default password in another area and delete it from this manual. Some discs can be limited depending on the age of users while some discs cannot.

4. Preference page

With no disc inside the player select 'PREFERENCE' () using the LEFT or RIGHT button, then press the OK button to enter the 'PREFERENCE PAGE'.

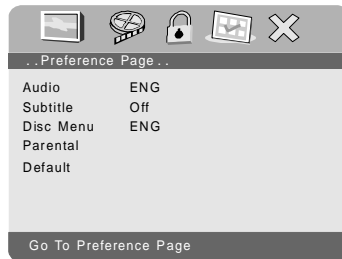

Preference Page Screen Display

a) Audio

Select 'AUDIO' using the DOWN button, then press the OK button to enter the submenu. Select the audio language you desire using the UP or DOWN buttons, then press the OK button to confirm the setting. Press the LEFT button to return.



Preferred Audio Language Screen Display

b) Subtitle

Select 'SUBTITLE' using the DOWN button, then press the OK button to enter the submenu. Select the desired subtitle language or OFF using the UP or DOWN buttons, then press the OK to confirm the setting. Press the LEFT to return.



Preferred Subtitle Language

c) Disc Menu

Select 'DISC MENU' using the DOWN button, then press the OK button to enter the submenu. Select the Disc Menu Language you desire using the UP or DOWN buttons, then press the OK button to confirm the setting. Press the LEFT to return.

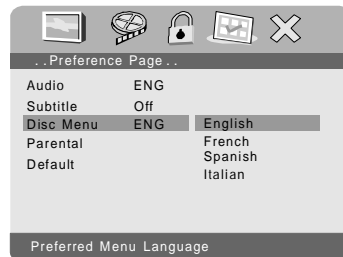

Preferred Disc Menu Language Screen Display

NOTE: Language and subtitle selection is only available for discs that are recorded in the above listed languages. If the selected language is not available, the player will play and display on the screen the original recorded language contained in the disc.

d) Parental

Select 'PARENTAL' using the DOWN button, then press the OK button to enter the submenu.

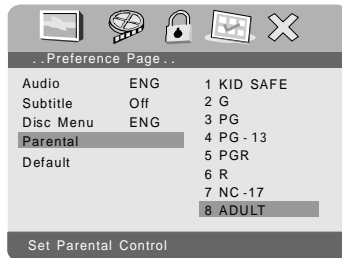

Parental Preference Screen Display

Select the parental level you desire using the UP or DOWN button for discs with lock-out function or multiple rating levels. These are listed from the lowest level (1 KID SAFE) to the highest level (8 ADULT). Enter a 4 digit password, then press the OK button to confirm the parental level setting.

NOTE: The level of 8 ADULT is the factory default.

e) Default

Select 'DEFAULT' using the DOWN button, then press the OK button to enter the submenu. Press the OK button to make the setting return to the factory default mode.

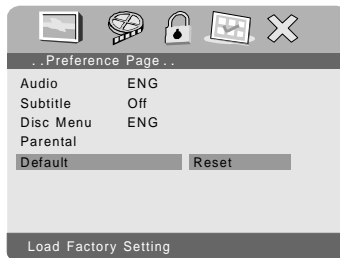

Load Factory Setting Screen Display

NOTE: The parental setting is not affected by the default reset function.

O. Specifications

Compatible DISC: DVD, CD

Signal system: NTSC

Panel size: 9 inch

Frequency response: 20 Hz to 20 kHz

Video output: 1 Vp-p/75 Ohm, unbalanced

Audio output: 1.4Vrms/10kOhm

Audio S/N: Better than 60 dB

Dynamic range : Better than 85 dB

Laser: Semiconductor Laser, Wave Length: 650 nm/795 nm

Power source: DC 9-12V

Power consumption: 7W

Operating temperature: 41~95°F (5~35°C)

Weight : 1.05 kg (2.31 lbs)

Dimensions (W x D x H): 242 x 177 x 41.2 mm

(9.53 X 6.97 X1.62 inches)

Built-in lithium polymer battery: 7.4V,4000mAh

P. Rechargeable Built-in Battery Use

The DVD player utilizes a long-life Li-Polymer battery for portability. Li-Polymer batteries feature high storage capacity and low level of degradation. This means the Li-Polymer batteries do not have “Memory Effect” and thus can be recharged regardless of whether the battery is fully or only partially discharged. **The battery must be charged at least 8 hours prior to first use.**

NOTE: If you do not plan to use the battery for an extended period of time (one week or longer), we recommend that you fully charge the battery. For longer periods of storage, please recharge the battery at least once every two months to maintain the battery in optimum condition.

Each full recharge takes approximately seven hours. During recharge, the red indicator will stay on. Once fully recharged, the red light will turn off. At this point you may remove the wall plug and stop charging.

Precautions Related to Battery Recharge:

1. The DVD player must be set to power off.
2. Once the battery is fully discharged, immediately the battery (regardless of whether you plan to use battery or not) in order to maximize battery life.
3. To charge the battery, please connect the power jack directly into the DVD Player and leave it connected until the red charge indicator turns off.

Using and Maintaining Your Rechargeable Batteries

1. Please make sure you always use **only** the AC adapter included with the player to recharge your battery. The battery can only be charged with the AC adaptor and will **NOT** charge with the car DC adaptor.
2. Recharge efficiency will degrade when environmental temperatures drop below 41°F (5°C) or exceed 95°F (35°C).
3. Do not leave the DVD player in a hot automobile or temperatures exceeding 122°F (50°C). Permanent battery damage, fire, or explosion may result.

Q. Troubleshooting

PROBLEM	SOLUTION
No sound or distorted sound	<ul style="list-style-type: none"> • Make sure the DVD player is connected properly. Make sure all cables are securely inserted into the appropriate jacks.
Can't advance through a movie	<ul style="list-style-type: none"> • You can't advance through the opening credits and warning information that appears at the beginning of movies because the disc is programmed to prohibit that action.
The icon (⏮) appears on screen	<p>The feature or action cannot be completed at this time because:</p> <ol style="list-style-type: none"> 1. The disc's software restricts it. 2. The disc's software doesn't support the feature (e.g., angles) 3. The feature is not available at the moment. 4. You've requested a title or chapter number that is out of range.
Picture is distorted	<ul style="list-style-type: none"> • The disc might be damaged. Try another disc. • It is normal for some distortion to appear during forward or reverse scan.
No forward or reverse scan	<ul style="list-style-type: none"> • Some discs have sections that prohibit rapid scanning or title and chapter skip. • You will not be able to skip through the warning information and credits at the beginning of a movie. This part of the movie is often programmed to prohibit skipping through it.

Troubleshooting (Cont)

PROBLEM	SOLUTION
Disc won't play	<ul style="list-style-type: none"> • Check the type of disc you put into disc tray. This DVD player only plays DVDs and audio CDs.
Play starts, but then stops immediately	<ul style="list-style-type: none"> • Your DVD player has been designed to process regional management information that is stored on DVD discs. The regional code for your player is 1 (The U.S., U.S. Territories and Canada). Only DVD discs that have regional codes of 1 or ALL (for all regions) can be played by your player. • The disc is dirty. Clean it. • Condensation has formed. Allow player to dry out.
Disc stops playing after the unit is bumped	<ul style="list-style-type: none"> • Remove the disc. Go to the Setup menu and set Last Memory to "OFF". Replace disc.
IR sensor inoperative	<ul style="list-style-type: none"> • Verify that the batteries in the remote are fresh. • Verify that the remote sensor eye is not obstructed.

The descriptions and characteristics in this owner's manual are for the purpose of general reference only and not as a guarantee. In order to provide you with the highest quality product, we may make changes or modifications without prior notice. The English version serves as the final reference on all product and operation details should any discrepancies arise in other languages.



AUDIOVOX
ELECTRONICS CORP.

90 DAY LIMITED WARRANTY

Applies to Audiovox Video Products

AUDIOVOX ELECTRONICS CORP. (the Company) warrants to the original retail purchaser of this product that should this product or any part thereof, under normal use and conditions, be proven defective in material or workmanship within ninety (90) days from the date of original purchase, such defect(s) will be repaired or replaced with reconditioned product (at the Company's option) without charge for parts and repair labor. A game controller, if supplied, is similarly warranted for ninety (90) days.

To obtain repair or replacement within the terms of this Warranty, the product is to be delivered with proof of warranty coverage (e.g. dated bill of sale), specification of defect(s), transportation prepaid, to the Company at the address shown below.

This Warranty does not extend to the elimination of externally generated static or noise, to correction of antenna problems, to costs incurred for installation, removal or reinstallation of the product, or to damage to digital memory/media devices, gaming devices, discs, speakers, accessories, or electrical systems.

This Warranty does not apply to any product or part thereof which, in the opinion of the Company, has suffered or been damaged through alteration, improper installation, mishandling, misuse, neglect, accident, or by removal or defacement of the factory serial number/bar code label(s). THE EXTENT OF THE COMPANY'S LIABILITY UNDER THIS WARRANTY IS LIMITED TO THE REPAIR OR REPLACEMENT PROVIDED ABOVE AND, IN NO EVENT, SHALL THE COMPANY'S LIABILITY EXCEED THE PURCHASE PRICE PAID BY PURCHASER FOR THE PRODUCT.

This Warranty is in lieu of all other express warranties or liabilities. ANY IMPLIED WARRANTIES, INCLUDING ANY IMPLIED WARRANTY OF MERCHANTABILITY, SHALL BE LIMITED TO THE DURATION OF THIS WRITTEN WARRANTY. ANY ACTION FOR BREACH OF ANY WARRANTY HEREUNDER INCLUDING ANY IMPLIED WARRANTY OF MERCHANTABILITY MUST BE BROUGHT WITHIN A PERIOD OF 12 MONTHS FROM DATE OF ORIGINAL PURCHASE. IN NO CASE SHALL THE COMPANY BE LIABLE FOR ANY CONSEQUENTIAL OR INCIDENTAL DAMAGES FOR BREACH OF THIS OR ANY OTHER WARRANTY. No person or representative is authorized to assume for the Company any liability other than expressed herein in connection with the sale of this product.

Some states do not allow limitations on how long an implied warranty lasts or the exclusion or limitation of incidental or consequential damage so the above limitations or exclusions may not apply to you. This Warranty gives you specific legal rights and you may also have other rights which vary from state to state.

Audiovox Electronics Corporation, 150 Marcus Blvd., Hauppauge, New York 11788 • 1-800-645-4994
128-5556G

Free Manuals Download Website

<http://myh66.com>

<http://usermanuals.us>

<http://www.somanuals.com>

<http://www.4manuals.cc>

<http://www.manual-lib.com>

<http://www.404manual.com>

<http://www.luxmanual.com>

<http://aubethermostatmanual.com>

Golf course search by state

<http://golfingnear.com>

Email search by domain

<http://emailbydomain.com>

Auto manuals search

<http://auto.somanuals.com>

TV manuals search

<http://tv.somanuals.com>