

# MICRO-AMP<sup>®</sup> System

## MA3-4 and MA3-4P Modulated Amplifiers



Banner MICRO-AMP<sup>®</sup> module models MA3-4 and MA3-4P are modulated amplifiers designed for use with the popular family of Banner high-performance remote sensors. When these modulated remote sensors are used with the MA3-4 or MA3-4P, their optical response is the same as when they are used with the larger MAXI-AMP CM Series modules.

These modules are powered by 10 to 30 volts dc. They feature the patented Banner Alignment Indicator Device (AID<sup>™</sup>) signal strength LED. Sensor sensitivity is adjustable via a top-mounted GAIN potentiometer. Circuitry is epoxy-encapsulated and protected by a tough molded VALOX<sup>®</sup> housing. Connections may be made to these modules via the optional RS8 socket/wiring base, or the module may be mounted directly to a printed circuit board.



The sensors which are used with these modules are totally encapsulated for durability and infinite life. Wide beam angles eliminate alignment problems, and high optical gain permits reliable sensing under severe conditions.

### MICRO-AMP MA3-4 Specifications

**SUPPLY VOLTAGE:** 10 to 30V dc at less than 20 milliamps (exclusive of load); 10% maximum ripple.

**OUTPUT CONFIGURATION:** two open-collector NPN (current sinking) transistor (solid-state) switches; one normally-open (light operate) and one normally closed (dark operate). 150 milliamps maximum, each output. Saturation voltage less than 0.5V dc at 10 milliamp load. Off-state leakage current less than 1 microamp.

**RESPONSE SPEED:** 1 millisecond ON and OFF.

**REPEATABILITY:** 0.3 millisecond.

**SENSOR LEAD LENGTH:** 30 feet (9m) maximum.

**ADJUSTMENT:** GAIN adjustment (single-turn potentiometer; adjust with small flat-blade screwdriver).

**INDICATOR:** exclusive Banner Alignment Indicator Device (AID<sup>™</sup>) system lights a red LED indicator whenever the sensor "sees" its own modulated light source, and pulses at a rate proportional to the strength of the received light signal.

**CONSTRUCTION:** totally encapsulated plug-in package with molded VALOX<sup>®</sup> housing. Gold-flashed connection pins.

**OPERATING TEMPERATURE:** -40 to +70 degrees C (-40 to +158 degrees F).

### Functional Schematic, MA3-4

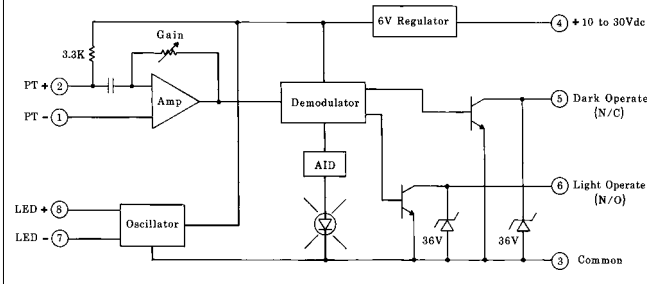

### Hookup Diagram, MA3-4

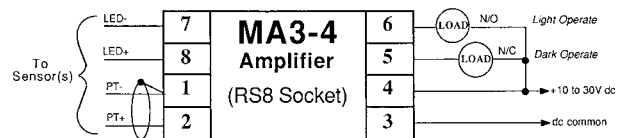

### Model MA3-4P: PNP (current sourcing) output

Model MA3-4P has the same specifications and performance as the MA3-4 amplifier, except that the MA3-4P has complementary PNP outputs in place of the MA3-4's NPN configuration.

**OUTPUT:** two PNP transistors, complementary outputs; one normally open (light operate) and one normally closed (dark operate). 150 milliamps maximum, each output. Saturation voltage less than 1V dc at 10 milliamps. Off-state leakage current less than 1 microamp.

### Hookup Diagram, MA3-4P

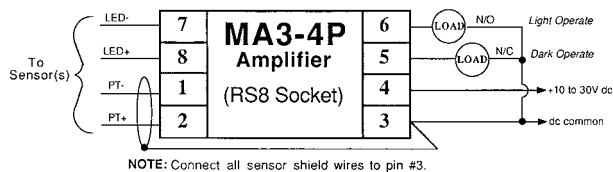

# Sensors for use with the MA3-4 and MA3-4P Modulated Amplifier

Sensors are epoxy-encapsulated and optics are hermetically sealed. Cables are 6 -1/2 feet (2m) long. 30-foot (9m) cables available by special order.

## Models/Dimensions

## Excess Gain

## Beam Pattern

### OPPOSED Mode

#### ALL MODELS

**Range:** 8 feet (2,4m)  
**Beam:** infrared, 880nm  
**Effective Beam:**  
 0.14 inch (3,6mm) dia.

**PT models are receivers**  
**LR models are emitters**

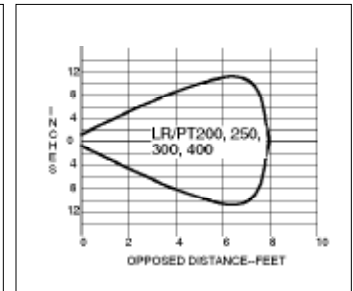
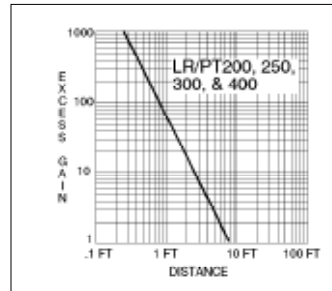
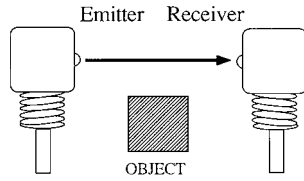

### LR200 & PT200

**Temp. range:** -40 to +100°C  
**Housing material:** black Delrin®

### LR250 & PT250

**Temp. range:** -40 to +100°C  
**Housing material:** black Delrin®

### LR300 & PT300

**Temp. range:** -40 to +80°C  
**Housing material:** black VALOX®

### LR400 & PT400

**Temp. range:** -40 to +100°C  
**Housing material:** anod. aluminum

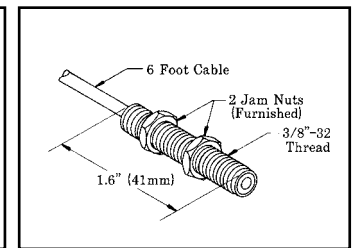
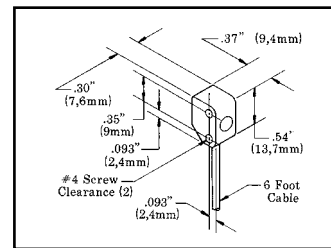
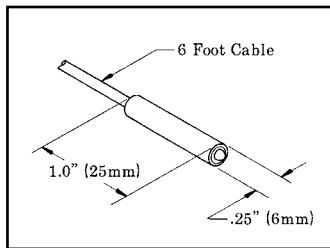
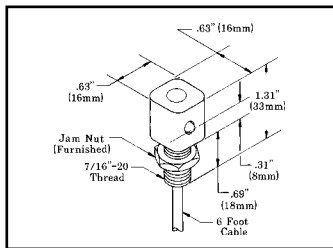
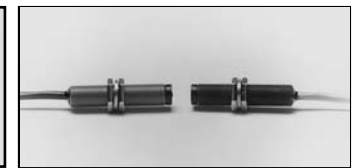
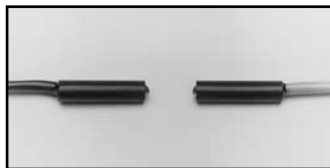

**LR/PT200, 250, 300, and 400 opposed mode remote sensors** are identical electronically and optically, and differ only in their housings. All are totally epoxy-encapsulated and use hermetically sealed glass lenses to eliminate condensation inside the optical chamber. These sensors may be washed down without damage. Operating temperature is determined by the type of cable used (see specifications above). All models have a wide beam angle for forgiving line-of-sight alignment. At the same time, the effective beam of each pair is only 1/8 inch, allowing small-profile resolution and reliable response to fast-moving objects. LR models are emitters, and PT models are receivers.

**LR200 & PT200:** this is a right-angle design which mounts through a 7/16 inch (12mm) diameter hole, using the steel jam nut which is included. This pair is used most commonly on small conveyors when it is desirable to run the cable directly down to a wireway.

**LR250 & PT250:** these sensors feature a 1/4 inch (6,4mm) diameter smooth barrel design, and are usually held in place in a clearance hole with a small set-screw. Optional mounting blocks (shown below) are available. Model SMB250 holds the sensor in place with two set-screws. The block is then mounted to a bracket (such as model SMB300), or directly to a machine frame with two #6 screws. Block model SMB250C holds an LR & PT250 together to converge at approximately 1/2 inch ahead of the block.

**LR & PT300:** this is a miniature right-angle design which is mounted in place using two #4 screws. This pair uses a very flexible, low-profile 2-wire cable. Despite their small size, the optical performance of the LR/PT300 is equal to the other remote sensor pairs.

**LR400 & PT400:** the 3/8 inch (9,5mm) diameter threaded barrel design makes the LR/PT400 the most versatile and most popular remote opposed sensor pair. They are easily mounted through clearance holes using the jam nuts which are supplied. They may be used with optional L4 or L16 lenses for extended range and/or higher excess gain. The addition of an L4 lens on both the LR and PT400 will increase their range from 8 feet to 40 feet and increase the excess gain at any distance by a factor of 25X. A pair of L16 lenses will increase available excess gain by a factor of 250X.



The LR/PT400 pair is often used at close range with optional AP400 aperture assemblies to create a very small and well-defined effective beam for resolving small profiles, increasing sensing repeatability, or easing response time requirements.



Aperture model	Aperture size
AP400-010	.010" dia.
AP400-015	.015" dia.
AP400-040	.040" dia.
AP400-030R	.030" x .125"

# Sensors for use with MA3-4 and MA3-4P Modulated Amplifiers

Sensors are epoxy-encapsulated. Cables are 6-1/2 feet (2m) long. 30-foot (9m) cables available by special order.

## Models/Dimensions

## Excess Gain

## Beam Pattern

### SP300EL & SP300RL

**Range:** 50 feet (15m)  
**Effective Beam:** .5 inch (13mm) dia.

**Temp. range:** -40 to +100°C  
**Housing material:** anodized aluminum

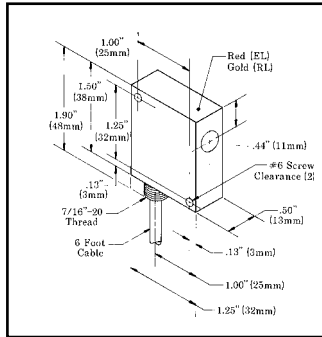

### Long Range OPPOSED Mode

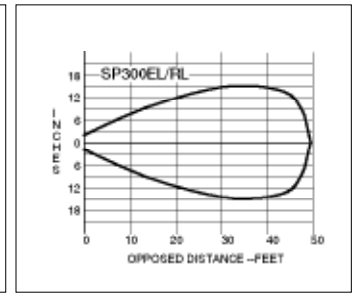
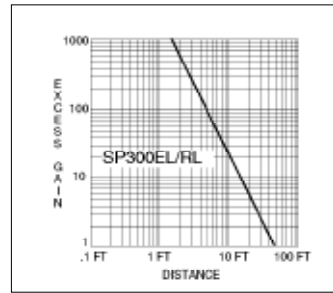
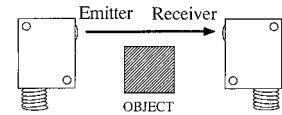

Emitter-receiver pair **SP300EL/RL** are extremely rugged and are totally encapsulated in anodized aluminum housings. The threaded hub at the cable exit allows for the use of flexible armored cable or protective PVC tubing with the addition of compression gland model CF7-16. This pair uses collimating

lenses to increase range. These sensors should also be used at short ranges for their high excess gain or to avoid optical "crosstalk" in situations which require several pairs to be mounted adjacent to one another.

### SP300L

**Range:** 15 feet (4,5m) with BRT-3 retroreflector  
**Temp. range:** -40 to +80°C

**Housing material:** blue anodized aluminum

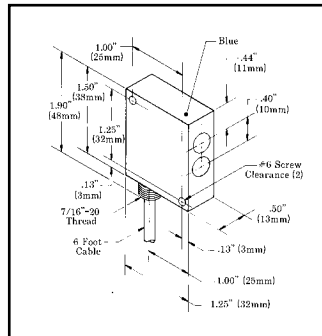
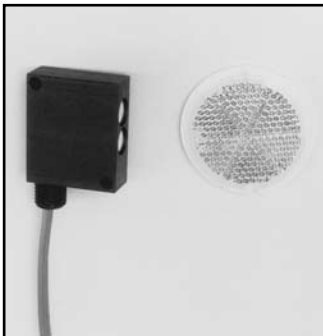

### RETROREFLECTIVE Mode

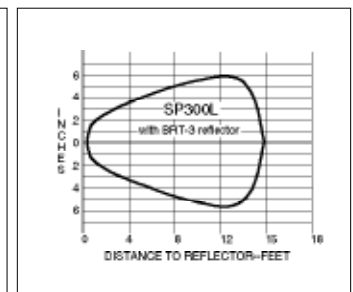
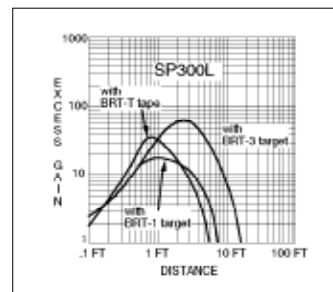
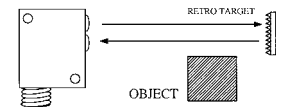

Model **SP300L** is a remote retroreflective sensor with the same rugged design as the SP300EL/RL, described above. Its useable range is from 6 inches to 15 feet (0,2 to 4,5m) using the model BRT-3 retroreflector.

If the object that is to break the beam has a shiny surface, then the SP300L and its retroreflector should be mounted so that the beam is at an angle of 10 degrees or more to that surface in order to eliminate false signals which are caused by proxing.

### LP400WB

### DIVERGENT Mode

**Range:** 3 inches (76mm)  
**Temp. range:** -40 to +80°C  
**Housing material:** blue anodized aluminum

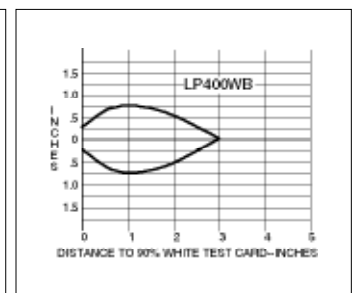
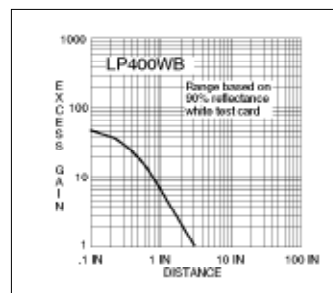
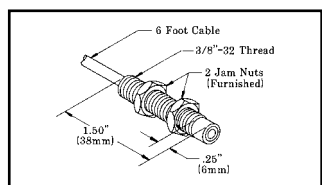
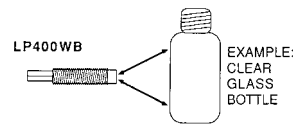

"WB" in this model number designates "wide beam". The **LP400WB** is an infrared divergent mode (wide angle diffuse mode) sensor which is particularly forgiving for reflectively sensing transparent or translucent materials or for

sensing objects with irregular surfaces (e.g.- webs with "flutter"). The optics are such that even small threads or wires .005" (0,1mm) or greater in diameter may be detected when they pass within .25" (6mm) of the sensor's plastic lens. Due to its wide response pattern, the LP400WB should not be used for precise positioning control, nor should it be mounted with its lens recessed into a hole.



# Sensors for use with MA3-4 and MA3-4P Modulated Amplifiers

Sensors are epoxy-encapsulated and optics are hermetically sealed. Cables are 6-1/2 feet (2m) long. 30-foot (9m) cables available by special order.

## Models/Dimensions

## Excess Gain

## Beam Pattern

### FIBER OPTIC Mode glass fiber optics



### LR400 & PT400 with FOF-400 fittings and fiber optics

Range: see excess gain curves  
Temp. range: -40 to +100°C

The threaded barrel design of the LR400 and PT400 permit the connection of any Banner glass fiber optic assembly by using two model FOF-400 fittings. The sensors are typically mounted through a 3/8 inch (10mm) diameter clearance hole, with the FOF-400 fittings threaded onto them after mounting. Setscrews in the fittings lock the fibers in place, but allow rapid replacement without disturbing any electrical wiring.

As the excess gain curves show, the LR/PT400 combination produces a high-performance fiber optic sensing system. With the amplifier's 1 millisecond response time, this system can be used for almost any fiber optic requirement.

**Fiber optic information:**  
**IT13S:** individual assembly .06 in. (1,5mm) dia. bundle  
**IT23S:** individual assembly .12 in. (3mm) dia. bundle  
**BT13S:** bifurcated assembly .06 in. (1,5mm) dia. bundle  
**BT23S:** bifurcated assembly .12 in. (3mm) dia. bundle  
**L9:** .5 in. (12mm) dia. lens  
**L16F:** 1.0 in. (25mm) dia. lens

#### OPPOSED MODE

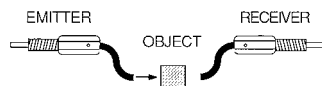

#### RETROREFLECTIVE MODE

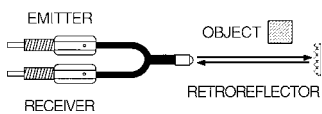

#### DIFFUSE MODE

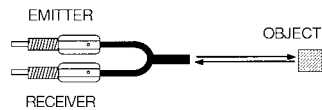

#### FOF-400 fiber optic fitting

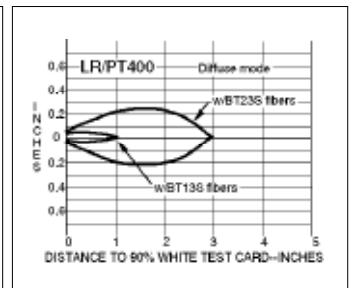
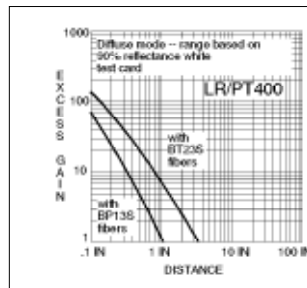
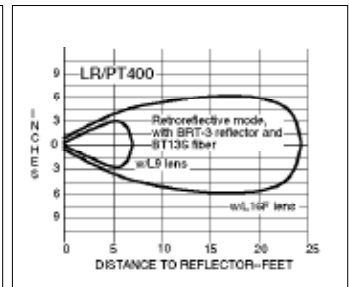
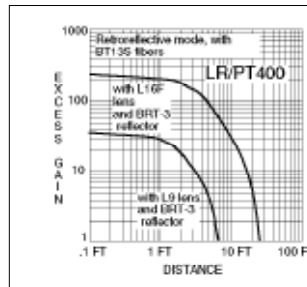
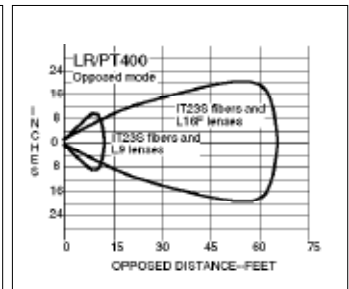
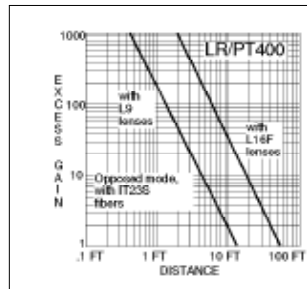
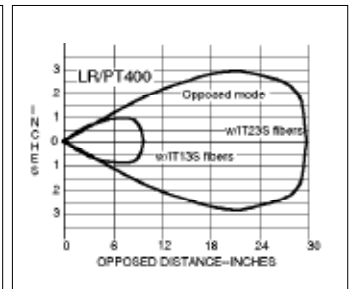
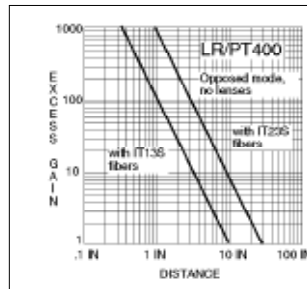
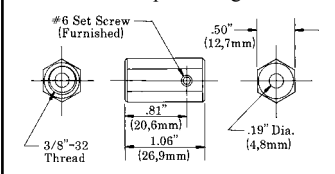

## Sensor Hookup Diagrams for MA3-4 MICRO-AMP Modules (continued on page 6)

The following hookup diagrams include all of the remote sensors for use with the model MA3-4 modulated amplifier module. It is important to note how the shield wire of a remote sensor is wired. The shield wire is the uninsulated wire in each sensor cable. Failure to connect the shield as shown may result in false operation of the amplifier. When wiring emitters, it is good practice to connect the positive wire first. LEDs are sensitive to application of the wrong voltage, and can easily be destroyed.

NOTE: only one sensor may be connected to each MA3-4 amplifier.

### Hookup of LR/PT200, 250, 300, and 400

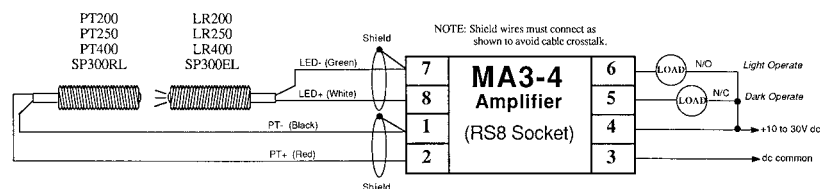

NOTE: Shield wires must be connected as shown to avoid cable crosstalk.

# Sensor Hookup Diagrams for MA3-4 MICRO-AMP Modules (continued)

## Hookup of LR300 and PT300

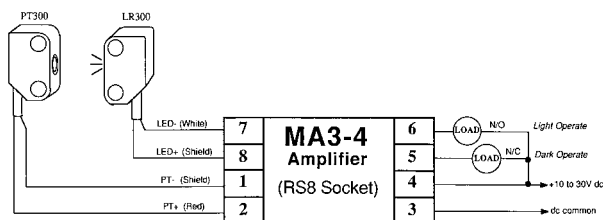

## Hookup of SP300D, SP300L, LP400WB, SP1000V

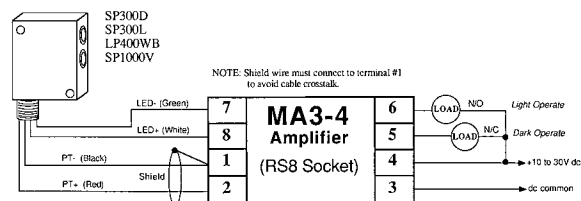

## Hookup of SP320D

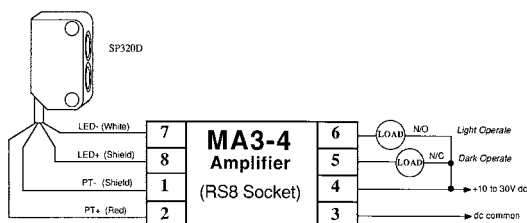

## IMPORTANT : Cable Splicing Information

Remote sensor cables may be run up to 30 feet (9m) away from the MA3-4 amplifier. All sensor models are available from the factory with 30 feet of cable, installed as an option.

When splicing additional cable to the standard 6-1/2 foot length, it is important to use a separate shielded cable for emitter and receiver wires. Combining emitter and receiver wires together in the same cable (even if the cable is shielded) will result in direct coupling of the emitter signal to the receiver leads.

This is called "cable crosstalk" and will not allow full amplifier sensitivity setting without an amplifier "lock on" situation, which appears as a continuous LIGHT condition. Banner offers 100 foot (30m) lengths of sensor extension cable (see below) which, if used for cable splicing, will minimize the chances for cable crosstalk.

## Accessories for High Performance Modulated Remote Sensors

### Extension Cable

Modulated remote sensors require specially designed cable for efficient sensor performance. Extension cable is available in 100 foot (30m) lengths.

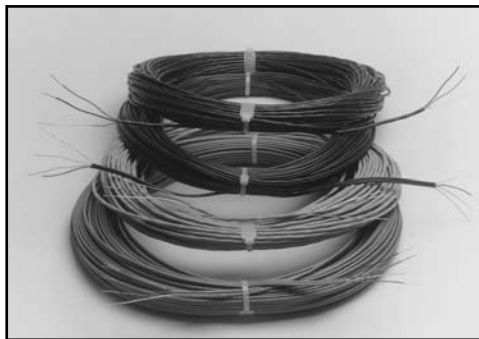

Extension Cable Model	Used on Sensor Models	# of Wires	Wire Colors
ESC-100	LR200, LR250, LR400, SP300EL	3	White, Green, Shield
RSC-100	PT200, PT250, PT400, SP300RL	3	Red, Black, Shield
SSC-100	SP300D, SP300L, LP400WB, SP1000V	5	White, Green, Red, Black, Shield
EC300E-100	LR300	2	White, Shield
EC300R-100	PT300	2	Red, Shield
EC320-100	SP320D	4	White, Shield, Red, Shield

### Cable Protection

AC-6 6 feet (1,8m)

AC-30 30 feet (9m)

This is mild-steel flexible tubing used with the compression fittings, at right, to achieve maximum protection to sensor cables.  
I.D. = 5/16"; O.D. = 7/16".



PVC-6 6 feet (1,8m)

PVC-30 30 feet (9m)

Heavy duty PVC tubing used to protect sensor cable in applications involving moisture and/or corrosive materials. I.D. = 1/4"; O.D. = 3/8".



**WARNING** MICRO-AMP® Systems do NOT include the self-checking redundant circuitry necessary to allow their use in personnel safety applications. A sensor or amplifier failure or malfunction can result in either an energized or a de-energized output condition.

Never use this product as a sensing device for personnel protection. Its use as a safety device may create an unsafe condition which could lead to serious injury or death.

Only MACHINE-GUARD and PERIMETER-GUARD Systems, and other systems so designated, are designed to meet OSHA and ANSI machine safety standards for point-of-operation guarding devices. No other Banner sensors or controls are designed to meet these standards, and they must NOT be used as sensing devices for personnel protection.

## Free Manuals Download Website

<http://myh66.com>

<http://usermanuals.us>

<http://www.somanuals.com>

<http://www.4manuals.cc>

<http://www.manual-lib.com>

<http://www.404manual.com>

<http://www.luxmanual.com>

<http://aubethermostatmanual.com>

Golf course search by state

<http://golfingnear.com>

Email search by domain

<http://emailbydomain.com>

Auto manuals search

<http://auto.somanuals.com>

TV manuals search

<http://tv.somanuals.com>