

POWERPLAY PRO HA4400

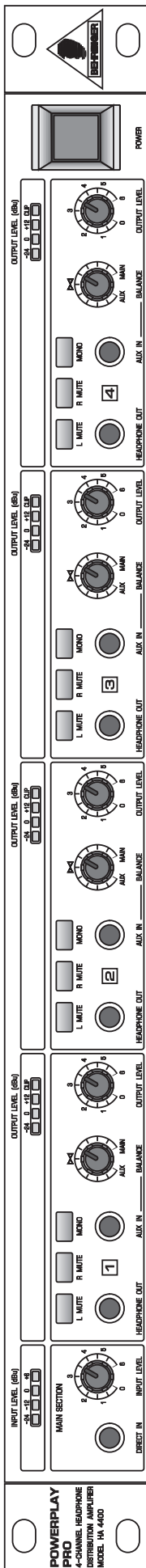

User's Manual

Version 1.1 January 2001

ENGLISH



www.behringer.com

SAFETY INSTRUCTIONS

CAUTION: To reduce the risk of electrical shock, do not remove the cover (or back). No user serviceable parts inside; refer servicing to qualified personnel.



WARNING: To reduce the risk of fire or electrical shock, do not expose this appliance to rain or moisture.



This symbol, wherever it appears, alerts you to the presence of uninsulated dangerous voltage inside the enclosure - voltage that may be sufficient to constitute a risk of shock.



This symbol, wherever it appears, alerts you to important operating and maintenance instructions in the accompanying literature. Read the manual.

DETAILED SAFETY INSTRUCTIONS:

All the safety and operation instructions should be read before the appliance is operated.

Retain Instructions:

The safety and operating instructions should be retained for future reference.

Heed Warnings:

All warnings on the appliance and in the operating instructions should be adhered to.

Follow instructions:

All operation and user instructions should be followed.

Water and Moisture:

The appliance should not be used near water (e.g. near a bathtub, washbowl, kitchen sink, laundry tub, in a wet basement, or near a swimming pool etc.).

Ventilation:

The appliance should be situated so that its location or position does not interfere with its proper ventilation. For example, the appliance should not be situated on a bed, sofa rug, or similar surface that may block the ventilation openings: or placed in a built-in installation, such as a bookcase or cabinet that may impede the flow of air through the ventilation openings.

Heat:

The appliance should be situated away from heat sources such as radiators, heat registers, stoves, or other appliance (including amplifiers) that produce heat.

Power Source:

The appliance should be connected to a power supply only of the type described in the operating instructions or as marked on the appliance.

Grounding or Polarization:

Precautions should be taken so that the grounding or polarization means of an appliance is not defeated.

Power-Cord Protection:

Power supply cords should be routed so that they are not likely to be walked on or pinched by items placed upon or against them, paying particular attention to cords and plugs, convenience receptacles and the point where they exit from the appliance.

Cleaning:

The appliance should be cleaned only as recommended by the manufacturer.

Non-use Periods:

The power cord of the appliance should be unplugged from the outlet when left unused for a long period of time.

Object and Liquid Entry:

Care should be taken so that objects do not fall and liquids are not spilled into the enclosure through openings.

Damage Requiring Service:

The appliance should be serviced by qualified service personnel when:

- The power supply cord or the plug has been damaged; or
- Objects have fallen, or liquid has been spilled into the appliance; or
- The appliance has been exposed to rain; or
- The appliance does not appear to operate normally or exhibits a marked change in performance; or
- The appliance has been dropped, or the enclosure damaged.

Servicing:

The user should not attempt to service the appliance beyond that is described in the Operating Instructions. All other servicing should be referred to qualified service personnel.

FOREWORD

Dear Customer,

Welcome to the team of POWERPLAY PRO users and thank you very much for expressing your confidence in BEHRINGER products by purchasing this unit.

It is one of my most pleasant tasks to write this letter to you, because it is the culmination of many months of hard work delivered by our engineering team to reach a very ambitious goal: making an outstanding device better still. The POWERPLAY has for quite a long time been a standard tool used by numerous studios and P.A. rental companies. The task to improve one of our best-selling products certainly meant a great deal of responsibility, which we assumed by focusing on you, the discerning user and musician. It also meant a lot of work and night shifts to accomplish this goal. But it was fun, too. Developing a product usually brings a lot of people together, and what a great feeling it is when everybody who participated in such a project can be proud of what we've achieved.

It is our philosophy to share our joy with you, because you are the most important member of the BEHRINGER family. With your highly competent suggestions for new products you've greatly contributed to shaping our company and making it successful. In return, we guarantee you uncompromising quality (manufactured under ISO9000 certified management system) as well as excellent technical and audio properties at an extremely favorable price. All of this will enable you to fully unfold your creativity without being hampered by budget constraints.

We are often asked how we can make it to produce such high-grade devices at such unbelievably low prices. The answer is quite simple: it's you, our customers! Many satisfied customers means large sales volumes enabling us to get better conditions of purchase for components, etc. Isn't it only fair to pass this benefit back to you? Because we know that your success is our success, too!

I would like to thank all people whose help on "Project POWERPLAY PRO" has made it all possible. Everybody has made very personal contributions, starting from the designers of the unit via the many staff members in our company to you, the user of BEHRINGER products.

My friends, it's been worth the trouble!

Thank you very much,



Uli Behringer

WARNING!

 It should be pointed out, that extreme output volumes may damage your ears and/or your headphone set. Turn down the LEVEL controls before you switch on the unit.

POWERPLAY PRO

Professional, multi-purpose headphone amplifier system for stage and studio applications

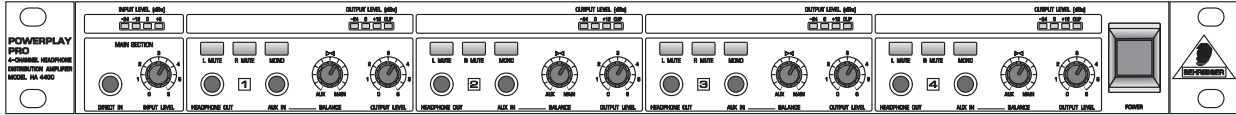

- ▲ Four totally independent stereo high-power amplifiers in 1 RU package
- ▲ Highest sonic quality even with extremely high volume levels
- ▲ Four independent input/aux sections provide up to four stereo mixes
- ▲ Stereo aux input for each channel allows you to mix in any instrument or sound source
- ▲ Output level control for each channel for your needs
- ▲ Mono/stereo switch for each channel for more flexibility
- ▲ Left/right mute switches for each channel enable you to run two different mixes in mono mode
- ▲ One front and two rear output jack connectors for each channel
- ▲ Accurate 4-digit LED meter for output level for each channel
- ▲ Direct input connector on the front for easy connection of any source
- ▲ Paralleled main outputs to chain several headphone amplifiers
- ▲ Servo-balanced, gold-plated XLR and 1/4" TRS inputs and outputs
- ▲ Ultra-low noise 4580 audio operational amplifiers for outstanding sound performance
- ▲ High-quality detented potentiometers and illuminated switches
- ▲ High-quality components and exceptionally rugged construction ensures long life and durability
- ▲ Internal power supply design for professional applications
- ▲ Manufactured under the stringent ISO9000 management system

TABLE OF CONTENT

1. INTRODUCTION	6
2. THE DESIGN CONCEPT	7
2.1 High quality components and design	7
2.2 Inputs and outputs	7
2.2.1 Balanced MAIN inputs	7
3. INSTALLATION	7
3.1 Rack mounting	7
3.2 Mains voltage	7
3.3 Audio connections	8
4. CONTROLS	9
4.1 The front panel control elements	10
4.2 The elements of the rear control panel	11
5. APPLICATION	11
5.1 Using the main inputs	11
5.2 Using the AUX IN inputs	11
5.2.1 Using the amplifiers as independent power amplifiers	12
5.3 Using the DIRECT IN input	13
5.4 Using the mono function	13
5.5 Using the mute function	13
5.5.1 The mute function in mono mode	13
5.5.2 The mute function in stereo mode	13
5.6 Connecting multiple headphones	14
6. SPECIFICATIONS	15
7. WARRANTY	16

1. INTRODUCTION

In purchasing the new POWERPLAY PRO HA4400, you have acquired a headphone amplifier of the high-end class which meets all the demands and requirements of studio work. Due to its extensive functions and the new design the POWERPLAY PRO is an extremely efficient and universal headphone amplifier. It has been designed above all as a reference unit for the sonic evaluation of the final mix as well as a distribution monitor amplifier for musicians in the studio.

The unit features switching possibilities and a sound quality few headphone amplifiers can offer. Apart from its extremely powerful amplifiers the unit also offers a ingenious signal distribution system.

Advanced BEHRINGER Technology

Since its announcement of the first POWERPLAY several years ago, it has caused a sensation. This high-end headphone amplifier is based on our many years of experience and discoveries in the field of professional studio technology. The POWERPLAY finds widespread application throughout the world, in renowned studios, sound reinforcement systems as well as in broadcast and TV studios.

The task to improve our famous POWERPLAY was a big challenge. We are very proud that we succeeded. Compared to its predecessors, the POWERPLAY PRO offers several advanced features and we have succeeded in dramatically refining the audio qualities. The unit features now additional XLR input and output connectors and LED displays for each channel, which give you exact information about the output gain. Moreover, there is an input level meter, which helps you to set up the correct level.

State-of-the-art production processes

For the first time ever, the POWERPLAY PRO is now manufactured with SMD components (Surface Mount Device). Using these sub-miniature components known from aeronautics does not only ensure extreme packing densities, but also improves the POWERPLAY PRO's reliability.

The additional AUX input

In addition to its high-quality amplifiers, the POWERPLAY features a variety of professional switching and mixing options: each of the four stereo amplifiers is equipped with an independent AUX input, which allows for adding a further audio signal to the master signal. The musician can therefore control the volume of his/her own instrument in the master playback signal as desired. This built-in mix function supersedes the external monitor mixer required up to now.

The BEHRINGER distribution matrix

A extremely interesting feature is the intelligent and clearly arranged distribution matrix which allows each channel to be switched over from stereo to mono whilst activating the mute function of the left and/or right input signal source.

In mono mode, two different mixes can be fed into the left and right MAIN inputs on the rear panel. By muting a channel, the signal of the channel which is not muted will appear on BOTH headphone pads. Thus, two completely different mixes can be routed to the headphone set in mono mode.

In stereo mode, any muting action in a particular channel automatically mutes the corresponding headphone output. As a consequence, it is possible to route the playback signal, for instance, to the left channel only, so that the vocalist can hear his/her voice directly via the right channel of the headphones. So moving the unused headphone pad away from the ear – uncomfortable but common practice up to now – will be a thing of the past.



MAIN output jacks are available to link several headphone amps, or to control external power amplifiers.

All power amplifiers are equipped with front and rear panel headphone outputs. Even if the unit is permanently installed in a rack with fixed cabling, additional headphones can be connected without difficulties, which allows for pre-monitoring the individual mixes for the musicians. Each power amplifier features three parallel output connectors for the connection of up to three headphone sets per amplifier, or a maximum of 12 headphones per unit.

The DIRECT IN input

A so-called DIRECT IN connector can be found on the front panel. For instance, it is often necessary to replay a song for the musicians in the studio via a cassette recorder. This can be done easily and rapidly using the DIRECT IN connector. When using this input, the master signal applied on the rear panel will be interrupted automatically.

WARNING!

-  It should be pointed out, that extreme output volumes may damage your ears and/or your headphone set. Turn down the LEVEL controls before you switch on the unit.
-  The following operational manual will introduce you to the BEHRINGER POWERPLAY PRO and its various functions. After reading the manual carefully, make sure it is always on hand for future reference.

2. THE DESIGN CONCEPT

2.1 High quality components and design

The philosophy behind BEHRINGER products guarantees a no-compromise circuit design and employs the best choice of components. The operational amplifiers NJM4580 which are used in the POWERPLAY PRO, are exceptional. They boast extreme linearity and very low distortion characteristics. To complement this design the choice of components includes high tolerance resistors and capacitors, detent potentiometers and several other stringently selected elements.

2.2 Inputs and outputs

2.2.1 Balanced MAIN inputs

As standard, the BEHRINGER POWERPLAY PRO is installed with electronically servo-balanced MAIN inputs. The new circuit design features automatic hum and noise reduction for balanced signals and thus allows for trouble-free operation, even at high operating levels. Externally induced mains hum etc. will be effectively suppressed. The automatic servo-function recognizes the presence of unbalanced connectors and adjusts the nominal level internally to avoid level differences between the input and output signals (correction 6 dB).

3. INSTALLATION

Your BEHRINGER POWERPLAY PRO was carefully packed in the factory and the packaging was designed to protect the unit from rough handling. Nevertheless, we recommend that you carefully examine the packaging and its contents for any signs of physical damage, which may have occurred in transit.

-  **If the unit is damaged, please do not return it to us, but notify your dealer and the shipping company immediately, otherwise claims for damage or replacement may not be granted. Shipping claims must be made by the consignee.**

3.1 Rack mounting

The BEHRINGER POWERPLAY PRO fits into one standard 19" rack unit of space (1 3/4"). Please allow at least an additional 4" depth for the connectors on the back panel. Be sure that there is enough air space around the unit for cooling and please do not place the POWERPLAY PRO on high temperature devices such as power amplifiers etc. to avoid overheating.

3.2 Mains voltage

Before you connect your POWERPLAY PRO to the mains, please make sure that your local voltage matches the voltage required by the unit! The fuse holder on the female mains connector has 3 triangular markers, with two of these triangles opposing each other. Your POWERPLAY PRO is set to the operating voltage printed next to these markers, and can be set to another voltage by turning the fuse holder by 180°. **CAUTION: this instruction does not apply to export models exclusively designed, e.g. for 115 V operation!**

3.3 Audio connections

The MAIN inputs on the BEHRINGER POWERPLAY PRO are fully balanced. If possible, connect the unit to other devices in a balanced configuration to allow for maximum interference immunity.

 **Please ensure that only qualified persons install and operate the POWERPLAY PRO. During installation and operation the user must have sufficient electrical contact to earth. Electrostatic charges might affect the operation of the POWERPLAY PRO!**

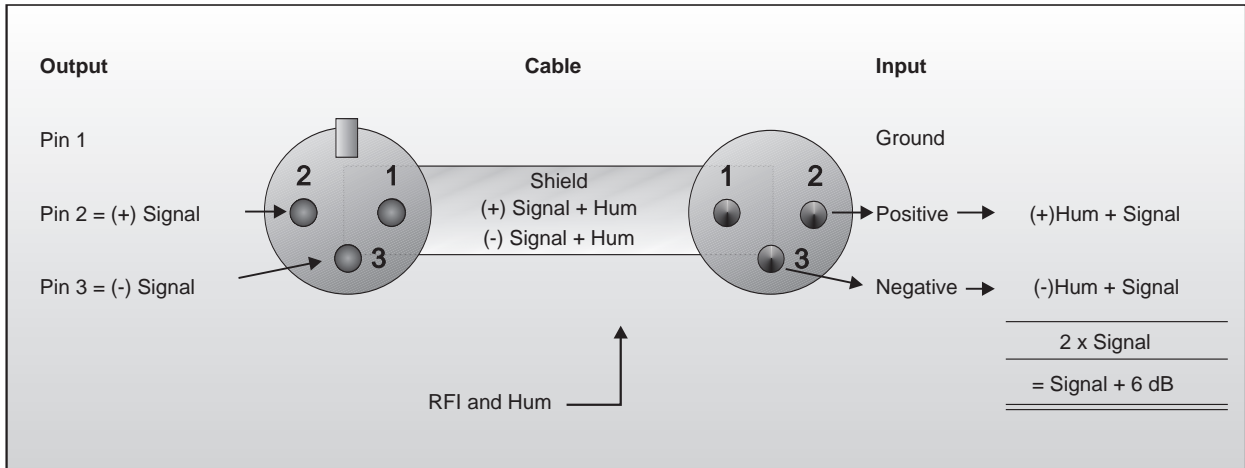

Fig. 3.1: Compensation of interference with balanced connections

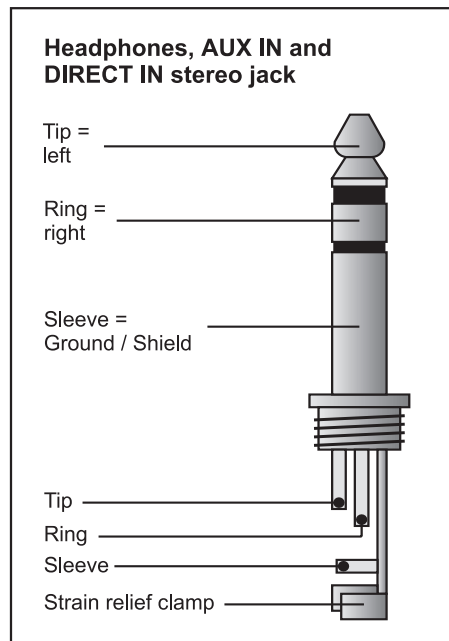

Fig. 3.2: Connector for the headphones, AUX IN and DIRECT IN

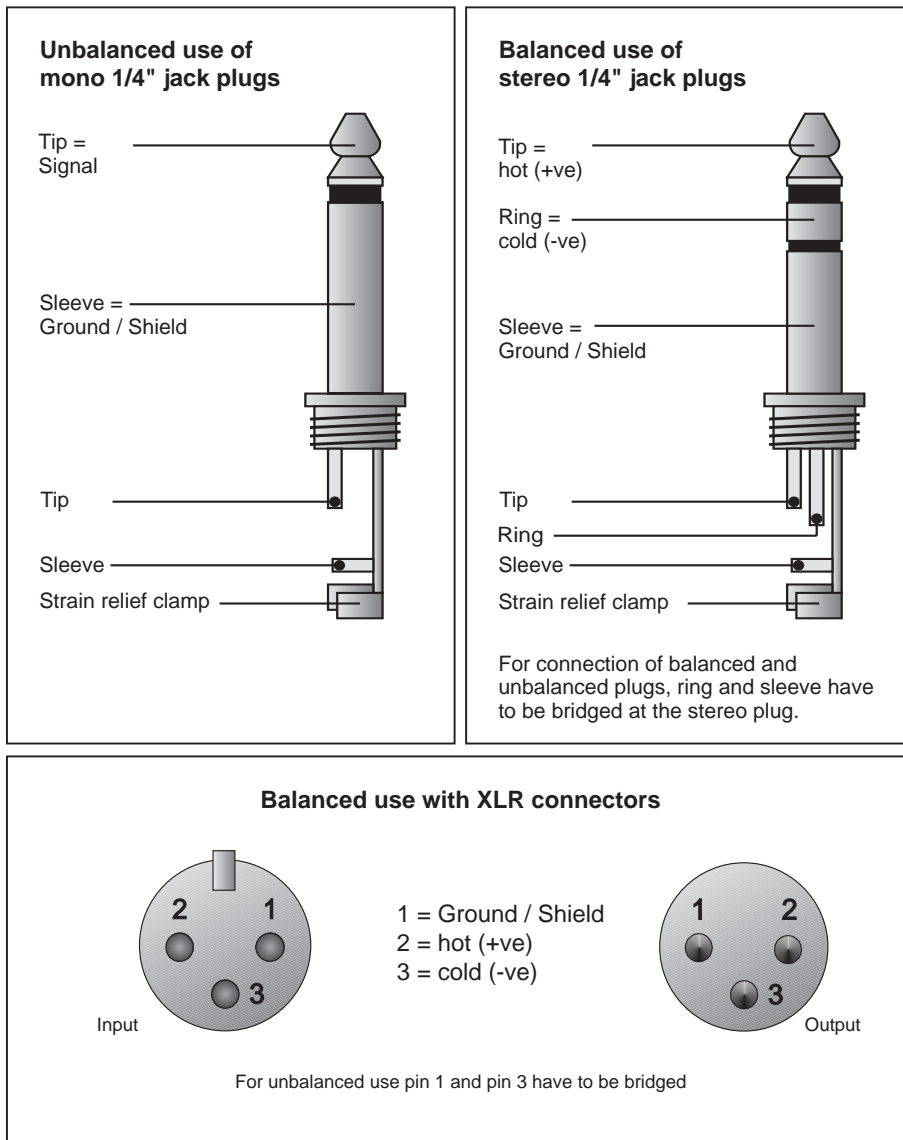

Fig. 3.3: Different plug types

4. CONTROLS

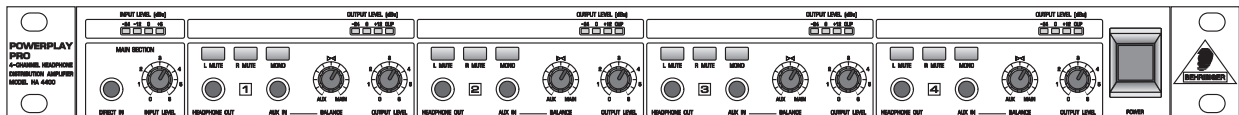

Fig. 4.1: POWERPLAY PRO front panel

The BEHRINGER POWERPLAY PRO has four identical channels and provides 3 illuminated push-button switches, 2 rotary controls, 2 jacks and 4 LEDs per channel. The common main section contains 1 rotary control, 1 jack and 4 LEDs.

4.1 The front panel control elements

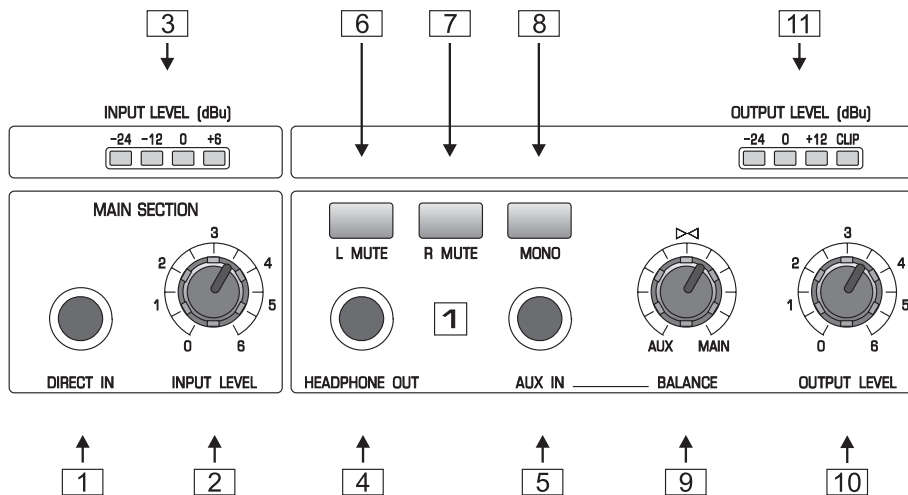

Fig. 4.2: Controls on the front panel

- 1 The *DIRECT IN* stereo input is used to apply the signals coming from an external source. When using the *DIRECT IN* input, the *MAIN* signal applied on the rear panel is interrupted automatically (fig. 3.2).
- 2 The *INPUT LEVEL* control adjusts the level of the input signal inserted via the rear panel *MAIN INPUT* or *DIRECT IN* connectors.
- 3 The 4-digit *INPUT LEVEL* meter informs you about the current input level within a range from -24 dBu to +6 dBu.
- 4 The *HEADPHONE OUT* is connected in parallel to the rear panel output connectors, and provides an additional option to monitor the individual channels. When the unit is permanently installed in rack, this proves to be a useful function.
- 5 A further input signal can be added to the *MAIN* and/or *DIRECT IN* signal via the *AUX IN* (fig. 3.2).
- 6 The *L MUTE* switch mutes the left input signal.
- 7 This *R MUTE* switch mutes the right input signal.
- 8 With the *MONO* switch each of the amplifiers can be switched between stereo to mono mode, and vice versa.
- 9 The *BALANCE* control determines the ratio level between the *MAIN/DIRECT IN* signal and the input signal applied to the *AUX IN* input.
- 10 The *OUTPUT LEVEL* control determines the volume of the individual amplifiers and refers to both the left and right channels.
- 11 The 4-digit *OUTPUT LEVEL* meter informs you about the current output level within a range from -24 dBu to + 12 dBu. If the *CLIP* LED lights up, you have to decrease the *INPUT GAIN*, otherwise distortion will raise.

4.2 The elements of the rear control panel

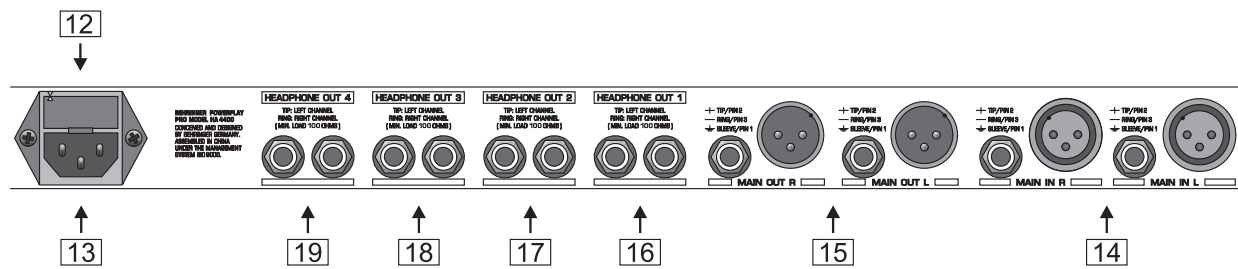

Fig. 4.3: The control elements of the rear panel

- 12 **FUSE HOLDER / VOLTAGE SELECTOR.** Please make sure that your local voltage matches the voltage indicated on the unit, before you attempt to connect and operate the POWERPLAY PRO. Blown fuses may only be replaced by fuses of the same type and rating.
- 13 **MAINS CONNECTION.** Use the enclosed power cord to connect the unit to the mains. Please also note the instructions given in the "INSTALLATION" chapter.
- 14 **AUDIO IN.** These are the audio inputs of your POWERPLAY PRO, available both as balanced 1/4" jack and XLR connectors.
- 15 **AUDIO OUT.** These are the audio outputs of your POWERPLAY PRO. Matching phone jack and XLR connectors are wired in parallel.
- 16 **HEADPHONE OUT 1.** These are the headphone outputs of channel 1.
- 17 **HEADPHONE OUT 2.** These are the headphone outputs of channel 2.
- 18 **HEADPHONE OUT 3.** These are the headphone outputs of channel 3.
- 19 **HEADPHONE OUT 4.** These are the headphone outputs of channel 4.

5. APPLICATION

5.1 Using the main inputs

Connect a program source to the rear panel MAIN inputs and connect the headphone cable to one of the appropriate outputs. Turn up the INPUT LEVEL and the BALANCE controls to center position. The INPUT LEVEL control is used to increase or decrease the general volume of all headphones controlled via the MAIN inputs, while the individual OUTPUT LEVEL controls are used to adjust the desired channel volume.

5.2 Using the AUX IN inputs

Basically, the AUX IN inputs are used to add an additional input signal to the master signal, with the corresponding BALANCE control determining the volume ratio between the two signals. The aux function supercedes the previously required monitor mixer and allows for an application that is frequently used in practice.

Example: suppose a vocalist wants to record a vocal track that is to be added to already existing instrumental tracks. Up to now, it has been common practice that the vocalist listens to the playback by pressing a headphone pad against one ear, while controlling his/her own voice with the other – free – ear.

This kind of application can be achieved much more easily and conveniently with the POWERPLAY PRO. The playback signal is inserted via the MAIN inputs, and the preamplified vocal signal is applied to the AUX connector. The associated BALANCE control is adjusted so that the vocalist hears a perfect mix of both backing tracks and vocals, with the OUTPUT LEVEL control determining the overall volume level.

Owing to the four independent channels of the POWERPLAY PRO, four individual mixes for four musicians can be achieved. If this is not enough, you can interface and link any number of POWERPLAY PROs using the MAIN outputs.

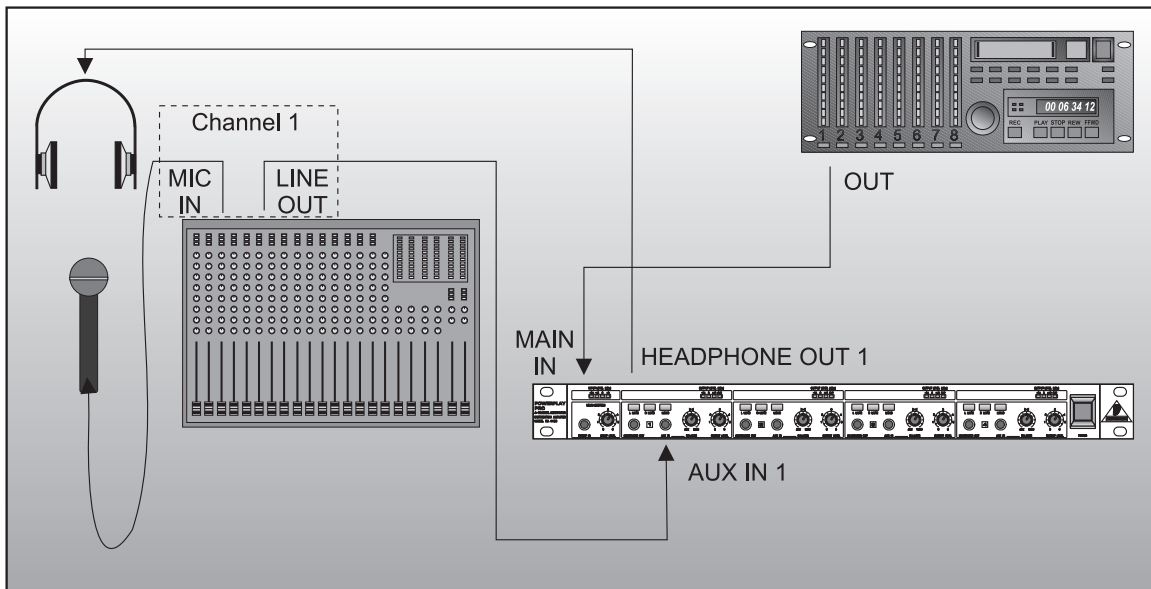

Fig. 5.1: Example of a studio playback application

5.2.1 Using the amplifiers as independent power amplifiers

In addition to the joint control of all channels via the MAIN input, each of the four power amplifiers can also be used independently. The AUX IN inputs in combination with the BALANCE controls serve this purpose.

If the BALANCE control is set to its clockwise stop position (position "AUX"), the MAIN signal is muted; only the input signals applied to the AUX IN input are routed to the power amplifier. By configuring the amplifiers as completely independent power amplifiers, you can insert up to four independent stereo programme sources; thus, four different and individual mixes for up to four musicians can be created. As with a stage monitor system, you can give each musician a specific configuration of instruments and create a personal mix for him or her that is musically inspiring. Or you can set up different signal paths for the interpreters in a conference system.

Configure sub-groups or create pre-mixes using the effects and/or monitor facilities of your mixing console. Fully turn up the BALANCE control and connect the AUX inputs of the BEHRINGER POWERPLAY PRO to the corresponding monitor, sub-group or single outputs of the mixer.

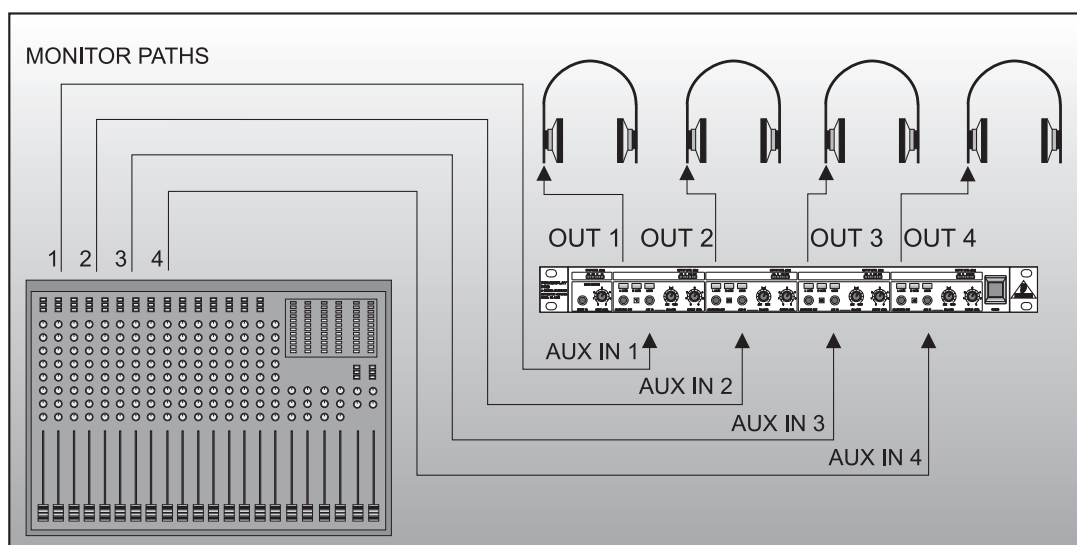

Fig. 5.2: Example of monitor inserts in a stage application

5.3 Using the DIRECT IN input

The DIRECT IN connector can be found on the left side of the front panel. For instance, it is often necessary to replay a song for the musicians in the studio via a cassette recorder. This can be done easily and rapidly using the DIRECT IN connector. When using this input, the signal applied to the rear panel MAIN INPUT connector is bypassed automatically.

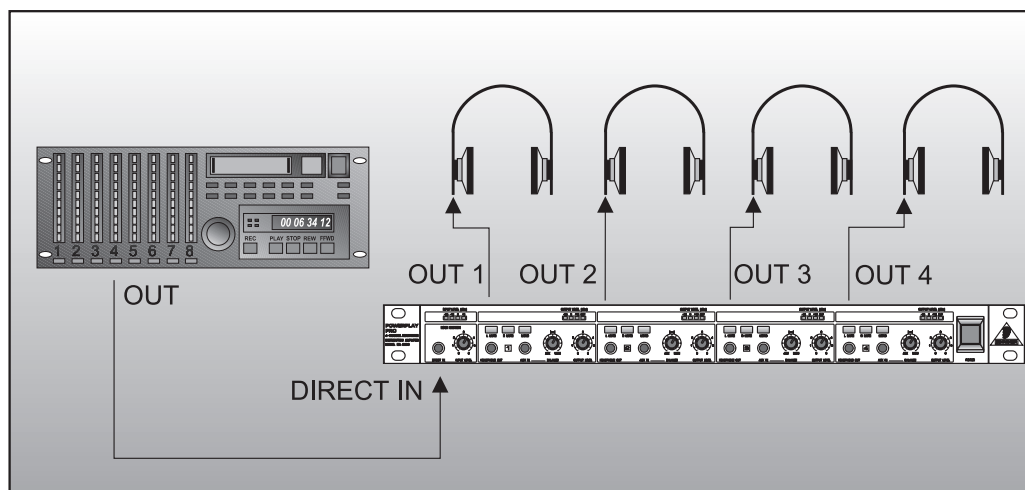

Fig. 5.3: Playback via the DIRECT IN connector

5.4 Using the mono function

The MONO switch allows for mono operation, i.e., linked operation of the left and right channels, without having to use a “Y-adaptor” or special cables.

In certain monitor applications, especially for live stage operation, a stereo programme may have a confusing effect, so the conversion into a mono signal leads to better transmission quality. In particular, this negative effect becomes obvious when the channel separation between the two channels is considerable, i.e., when they contain different information with differing volume levels.

5.5 Using the mute function

The mute function of the individual input sources is a special feature of the BEHRINGER POWERPLAY PRO. Depending on the position of the MONO switch, it offers two highly useful routing options:

5.5.1 The mute function in mono mode

When the MONO switch is pressed, the unit operates in mono mode. In this case, the two input signals are combined and the resulting mono signal is fed into the left and right headphone outputs.

By pressing one of the two MUTE switches, the corresponding input source (left or right input) is muted and the input signal which is not muted appears on BOTH headphone outputs (left and right). This routing option allows for the selection of two different programmes which are fed into the left and right input by muting the unwanted input source.

5.5.2 The mute function in stereo mode

The mute function is also very useful if playback is to be combined with simultaneous recording of a vocal track. Up to now, vocalists have been forced to move one headphone pad away from the ear while recording, in order to hear their own voice clearly.

Now, the BEHRINGER POWERPLAY PRO can mute the unused headphone channel in stereo mode. So moving the unused headphone pad away from the ear – uncomfortable but common practice – will be a thing of the past.

5.6 Connecting multiple headphones

All of the four stereo amplifiers feature one front and one rear panel headphone output connector. Multiple headphones can be connected per channel, on condition that the resulting connection impedance does not fall below 100 Ohms. As the power amplifiers are resistant to temporary short circuits, an impedance drop will not cause any damage, however, it can affect the quality of reproduction, in terms of long-term damage and distortion.

Additional headphones can be connected to the front panel headphone outputs, even if the unit is installed in a rack with fixed cabling. If you wish to connect more than three headphones per amplifier, it is advisable to use a split box or appropriate "Y" cables. Please find additional information on how to connect the headphones in chapter 3, and note that the minimum connection impedance of 100 Ohms is maintained.

6. SPECIFICATIONS

AUDIO INPUT

MAIN input

Connectors	XLR and 1/4" jack
Type	RF filtered, servo balanced input
Impedance	50 kOhms balanced, 25 kOhms unbalanced
Max. input level	+21 dBu balanced and unbalanced (unity gain)
CMRR	typ. 40 dB, >55 dB @ 1 kHz

AUX IN and DIRECT IN input

Connectors	1/4" jack (tip = left, ring = right, sleeve = ground)
Type	unbalanced
Impedance	25 kOhms unbalanced
Max. input level	+21 dBu unbalanced (unity gain)
CMRR	typ. 40 dB, >55 dB @ 1 kHz

AUDIO OUTPUT

Connectors	XLR and 1/4" jack
Type	balanced/unbalanced
Impedance	dependent on input balance
Max. output level	+21 dBu balanced and unbalanced

SYSTEM SPECIFICATIONS

Frequency response	10 Hz to 100 kHz, +/- 3 dB
Noise	>99 dB, unweighted, 22 Hz to 22 kHz
THD	0.005 % typ. @ +4 dBu, 1 kHz, Gain 1

POWER AMPLIFIER

Max. output power	+26.5 dBm
Min. output impedance	100 Ohms
Max. gain	+20 dB

FUNCTION CONTROLS

Input level	variable
Balance per channel	mix between aux and main signal
Output level per channel	variable

FUNCTION SWITCHES

Left mute	mutes the left signal of this channel
Right mute	mutes the right signal of this channel
Mono	switches channel to mono

INDICATORS

Input level	4-digit LED display: -24/-12/0/+6 dBu
Output level	4-digit LED display: -24/0/+12 dBu/CLIP

POWER SUPPLY

Mains voltages	USA/Canada	120 V ~, 60 Hz
	U.K./Australia	240 V ~, 50 Hz
	Europe	230 V ~, 50 Hz
	General export model	100-120 V ~, 200-240 V ~, 50-60 Hz
Power consumption	40 Watts	
Fuse	100-120 V ~:	T 630 mA H
	200-240 V ~:	T 315 mA H
Mains connection	Standard IEC receptacle	

PHYSICAL

Dimension	1 3/4" (44.5 mm) * 19" (482.6 mm) * 8 1/2" (217 mm)
Net weight	approx. 2.7 kg
Shipping weight	approx. 3.5 kg

BEHRINGER is constantly striving to maintain the highest professional standards. As a result of these efforts, modifications may be made from time to time to existing products without prior notice. Specifications and appearance may differ from those listed or shown.

7. WARRANTY

§ 1 WARRANTY CARD/ONLINE REGISTRATION

To be protected by the extended warranty, the buyer must complete and return the enclosed warranty card within 14 days of the date of purchase to BEHRINGER Spezielle Studiotechnik GmbH, in accordance with the conditions stipulated in § 3. Failure to return the card in due time (date as per postmark) will void any extended warranty claims.

Based on the conditions herein, the buyer may also choose to use the online registration option via the Internet (www.behringer.com or www.behringer.de).

§ 2 WARRANTY

1. BEHRINGER (BEHRINGER Spezielle Studiotechnik GmbH including all BEHRINGER subsidiaries listed on the enclosed page, except BEHRINGER Japan) warrants the mechanical and electronic components of this product to be free of defects in material and workmanship for a period of one (1) year from the original date of purchase, in accordance with the warranty regulations described below. If the product shows any defects within the specified warranty period that are not due to normal wear and tear and/or improper handling by the user, BEHRINGER shall, at its sole discretion, either repair or replace the product.

2. If the warranty claim proves to be justified, the product will be returned to the user freight prepaid.

3. Warranty claims other than those indicated above are expressly excluded.

§ 3 RETURN AUTHORIZATION NUMBER

1. To obtain warranty service, the buyer (or his authorized dealer) must call BEHRINGER (see enclosed list) during normal business hours **BEFORE** returning the product. All inquiries must be accompanied by a description of the problem. BEHRINGER will then issue a return authorization number.

2. Subsequently, the product must be returned in its original shipping carton, together with the return authorization number to the address indicated by BEHRINGER.

3. Shipments without freight prepaid will not be accepted.

§ 4 WARRANTY REGULATIONS

1. Warranty services will be furnished only if the product is accompanied by a copy of the original retail dealer's invoice. Any product deemed eligible for repair or replacement by BEHRINGER under the terms of this warranty will be repaired or replaced within 30 days of receipt of the product at BEHRINGER.

2. If the product needs to be modified or adapted in order to comply with applicable technical or safety standards on a national or local level, in any country which is not the country for which the product was originally developed and manufactured, this modification/adaptation shall not be considered a defect in materials or workmanship. The warranty does not cover any such modification/adaptation, irrespective of whether it was carried out properly or not. Under the terms of this warranty, BEHRINGER shall not be held responsible for any cost resulting from such a modification/adaptation.

3. Free inspections and maintenance/repair work are expressly excluded from this warranty, in particular, if caused by improper handling of the product by the user.

This also applies to defects caused by normal wear and tear, in particular, of faders, potentiometers, keys/buttons and similar parts.

4. Damages/defects caused by the following conditions are not covered by this warranty:

- ▲ misuse, neglect or failure to operate the unit in compliance with the instructions given in BEHRINGER user or service manuals.

- ▲ connection or operation of the unit in any way that does not comply with the technical or safety regulations applicable in the country where the product is used.

- ▲ damages/defects caused by force majeure or any other condition that is beyond the control of BEHRINGER.

5. Any repair or opening of the unit carried out by unauthorized personnel (user included) will void the warranty.

6. If an inspection of the product by BEHRINGER shows that the defect in question is not covered by the warranty, the inspection costs are payable by the customer.

7. Products which do not meet the terms of this warranty will be repaired exclusively at the buyer's expense. BEHRINGER will inform the buyer of any such circumstance. If the buyer fails to submit a written repair order within 6 weeks after notification, BEHRINGER will return the unit C.O.D. with a separate invoice for freight and packing. Such costs will also be invoiced separately when the buyer has sent in a written repair order.

§ 5 WARRANTY TRANSFERABILITY

This warranty is extended exclusively to the original buyer (customer of retail dealer) and is not transferable to anyone who may subsequently purchase this product. No other person (retail dealer, etc.) shall be entitled to give any warranty promise on behalf of BEHRINGER.

§ 6 CLAIM FOR DAMAGES

Failure of BEHRINGER to provide proper warranty service shall not entitle the buyer to claim (consequential) damages. In no event shall the liability of BEHRINGER exceed the invoiced value of the product.

§ 7 OTHER WARRANTY RIGHTS AND NATIONAL LAW

1. This warranty does not exclude or limit the buyer's statutory rights provided by national law, in particular, any such rights against the seller that arise from a legally effective purchase contract.

2. The warranty regulations mentioned herein are applicable unless they constitute an infringement of national warranty law.

The information contained in this manual is subject to change without notice. No part of this manual may be reproduced or transmitted in any form or by any means, electronic or mechanical, including photocopying and recording of any kind, for any purpose, without the express written permission of BEHRINGER Spezielle Studiotechnik GmbH.

BEHRINGER is a registered trademark. ALL RIGHTS RESERVED.

© 2001 BEHRINGER Spezielle Studiotechnik GmbH.

BEHRINGER Spezielle Studiotechnik GmbH, Hanns-Martin-Schleyer-Str. 36-38, 47877 Willich-Münchheide II, Germany

Tel. +49 (0) 21 54 / 92 06-0, Fax +49 (0) 21 54 / 92 06-30

Free Manuals Download Website

<http://myh66.com>

<http://usermanuals.us>

<http://www.somanuals.com>

<http://www.4manuals.cc>

<http://www.manual-lib.com>

<http://www.404manual.com>

<http://www.luxmanual.com>

<http://aubethermostatmanual.com>

Golf course search by state

<http://golfingnear.com>

Email search by domain

<http://emailbydomain.com>

Auto manuals search

<http://auto.somanuals.com>

TV manuals search

<http://tv.somanuals.com>