

# USER MANUAL



BlueAnt®

# Z9i

BLUETOOTH HEADSET  
Dual mic with Voice Isolation







# BlueAnt®

## Z9i USER GUIDE

ENGLISH

### Introduction

The BlueAnt Z9i Dual Microphone portable mono headset utilizes Bluetooth Wireless Technology. Its dual microphones combined with the BlueAnt Voice Isolation Technology™ software, provide the BlueAnt Z9i with revolutionary clear and clean voice input enabling high quality voice communications. Winner of the prestigious CES 2007 Design and Engineering award, the BlueAnt Z9i is the next generation in Noise Suppression, Echo Cancellation and Wind Noise Reduction for Bluetooth headsets.

There are two settings of Voice Isolation - **STANDARD** and **MAX**.

**Voice Isolation Standard** is for use in normal environments and gives you a natural sounding voice removing mild noise. **Voice Isolation Max** gives you superior voice clarity in a wide variety of high noise areas.



## Features of the BlueAnt Z9i

- Winner of CES 2007 Innovations Design & Engineering Award
- Two microphones for pure speech
- Voice Isolation Technology™ BlueAnt's revolutionary Digital Signal Processor (DSP) software
- During a call, users can switch between two Voice Isolation modes – Standard and Max
- This world class DSP provides echo suppression, noise reduction and wind noise reduction which separates the desired voice signal from background noise enabling crystal clear conversation in even the noisiest of environments
- The Z9i can be paired with 5 devices
- Multi-point, connect two phones at once and answer whichever rings
- Different ringtones for known and unknown contacts
- Innovative tie clip for attaching to shirt or cuff, when not in use
- Small & lightweight (1.5" in length & weighs only 0.35 oz) (41mm & 10grams)
- Stylish, translucent ear hook
- Up to 5.5 hrs talk-time or 200 hrs standby
- 2 Year Replacement Warranty
- Bluetooth v2.0

## What is Bluetooth wireless technology?

Bluetooth is the most advanced cable-replacement technology available today. It enables effortless wireless connections between your Bluetooth devices within a range of up to 10m (30 ft).

Download from [Www.Somanuals.com](http://www.Somanuals.com). All Manuals Search And Download.

## What devices work with the Z9i Dual Microphone?

Your headset is a Bluetooth V2.0 qualified product and supports both the Headset and Handsfree Bluetooth profiles. The Z9i can store information and wirelessly interact with up to five different Bluetooth V1.1, V1.2 or V2.0 compliant devices (backward and forward compatible), including mobile phones, PDA's, PC's / Mac's or any Bluetooth enabled device that supports Headset profile or Handsfree profile. **This manual focuses on how to use your headset with your Bluetooth enabled phone.**

## What's in the Package?

- > A BlueAnt Z9i Dual Microphone Bluetooth Headset
- > 1 metal ear hook
- > 1 translucent ear hook
- > Small and Large Ear bud
- > USB Cable
- > AC Adaptor
- > Quick Start Guide
- > User Manual
- > Warranty Card

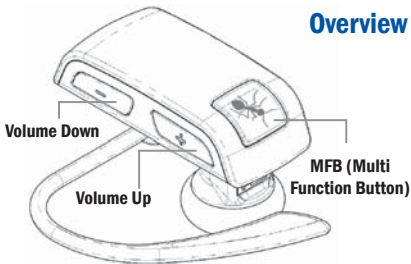

Download from [Www.Somanuals.com](http://www.Somanuals.com). All Manuals Search And Download.



## Getting Started

Before you can use your headset, you must do the following two things:

1. Fully charge your headset using one of the chargers provided.
2. Pair your headset with a Bluetooth enabled device, e.g. Cell phone, PDA, Computer

## Charging

Your Z9i comes with a built-in rechargeable battery. For first time use, you must fully charge your Z9i. During charging, the indicator shows a steady Red light. When the battery is fully charged, the Red light will turn off. It takes 120-150 minutes to fully charge the battery. The more you talk using your headset, the less standby time your battery has. Your headset will require longer charging times when not used over extended periods of time.

### Charging the Z9i with the USB connector

1. Plug the USB charging cable into the PC/Mac's USB port
2. Plug the other end of the USB charging cable into the charging port of your headset. Make sure the USB plug matches up to the USB socket on the headset. Do not force the plug into the socket, it should slide in easily. The Red LED will turn ON.
3. When charging is complete the Red LED will turn OFF. Remove the charging adapter.

### Charging the Z9i with the Wall Charger

1. Plug the AC Charger into a power socket and the cable into the charging port on the Z9i. Make sure the USB plug matches up to the USB socket on the headset. Do not force the plug into the socket it should slide in easily. The Red LED will turn ON.
2. When charging is complete the Red LED will turn OFF. Remove the charging adapter.

## Wearing the BlueAnt Z9i

Push the ear hook through the ear hook hole which sits on the headset clip and adjust its length to fit comfortably on your ear. Ensure that the headset is pointing towards your mouth. You can wear the Z9i on left or right ears.

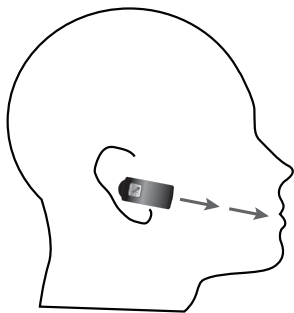
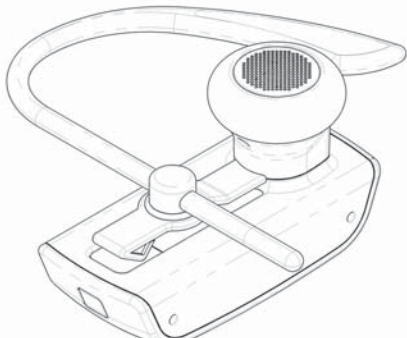

For optimal performance of the Z9i headset, angle the headset so that it points towards your mouth.

Download from [Www.Somanuals.com](http://www.Somanuals.com). All Manuals Search And Download.



## Swapping the Ear Gels

The Z9i comes with two sizes of Ear gels. The larger ear gel is fitted on the unit already.

If you wish to use the smaller ear gel instead, please unscrew (anti-clockwise) the large ear bud and screw on (clockwise) the smaller one.

Be sure to gently unscrew the Ear bud and do not over tighten when fixing the smaller gel.

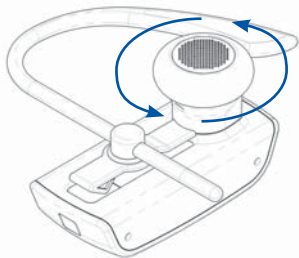



Gently screw anti-clockwise to remove,  
Gently screw clockwise to attach.



## Pairing

Before use, you must pair the headset with your cell phone. Pairing will create a stored connection in both the Z9i and your Bluetooth cell phone. Pairing need only be done once, when first connecting to a new phone. The Z9i can store pairing information for up to five (5) different Bluetooth devices. If you wish to pair another different device once 5 devices are paired, you will need to RESET the Z9i as per the instructions in Basic Headset Functions below.











### Pairing Procedure (This is an example only and may differ from your phone, but the process will be the same.)



1. First turn the phone OFF and then back ON again to refresh its memory.
2. Bring the mobile phone to about 30cm from the Z9i Dual Microphone.
3. Find the Bluetooth menu in your mobile phone. Turn Bluetooth ON. (Check your mobile phone user guide if necessary)
4. With the Z9i OFF, Press and Hold the MFB  for about 6 seconds. The LED will appear a solid Blue, and then will start flashing. The Z9i is now in Pairing mode and ready to be found in searches by other Bluetooth devices. Pairing mode will be active for 2 minutes.
5. Perform a Bluetooth device discovery on your mobile phone to add a new device. (It takes a few seconds to search for and find other Bluetooth devices around you).
6. When Bluetooth devices are found, the phone will display "BlueAnt Z9i". Scroll to it and press OK to confirm that you want to Pair with it.
7. Enter Passkey "0000" when your phone prompts you. The phone and Z9i will now Pair.
8. An additional security setting in your phone may be needed to allow the headset and phone to connect automatically without confirmation each time you connect your Z9i. Generally in the options for the BlueAnt Z9i, it will be referred to as "set as authorized", "add to trusted devices", "allow connection" or similar.
9. If required for first time connection, select the BlueAnt Z9i to connect with your phone. OR, Click the MFB  on the Z9i, to connect.



## Basic Headset Functions

For easy reference, also see the Button/Function Matrix and the Quick Start Guide.

- 1. Power ON:** Press and Hold the MFB  for 3 seconds. The solid Blue LED will light up, and if the battery has ample charge the Blue LED will stay on for up to 5 Seconds. If the battery is low a solid Red LED will be displayed. After powering ON, your headset will automatically connect to your last used phone if it is in operating range. If this phone is not range, the Z9i will enter idle mode after 60 seconds. If no phone has yet been Paired, the Z9i will enter into Pairing mode.
- 2. Power OFF:** Press and Hold the MFB  for 3 seconds. The Red LED flashes three times.
- 3. Enter Pairing Mode:** With the Z9i OFF, Press and Hold the MFB  for about 6 seconds until the LED flashes Blue. The Z9i will stay in pairing mode for 2 minutes then will go into idle mode. To re-enter pairing mode, repeat this step. If you had already paired 5 devices and want to pair again, you will need to RESET the Z9i to enter pairing mode.
- 4. Make a Call:** Dial the number using your phone as normal. Audio will automatically transfer to the headset.
- 5. To Answer or End a call:** Click the MFB  once when there is an incoming call.  
Click the MFB  to end the call.
- 6. Reject\* a call:** Press and Hold the MFB  for 1 second when there is an incoming call.
- 7. Redial\*:** the last call, Press and Hold the Volume  Button for about 3 seconds. To cancel Redial, click the MFB .
- 8. Activate Voice Dialing\*:** While connected to a phone, Press the MFB  once. Voice commands must have been previously recorded into your phone (see your phones user guide for specific instructions).
- 9. Volume level:** Click Volume  or Volume  during a call to adjust the desired level. Volume changes will be remembered for the next call. Be sure to use the headset at a comfortable and safe volume level.

10. **Disconnect / Transfer:** To disconnect the Z9i with the currently connect phone Click Volume ⊕ and Volume ⊖ together once. This will also transfer an ongoing call to the phone.
11. **Reconnect:** To reconnect your phone to the Z9i, simply turn the Z9i ON. Or with the Z9i ON simply press the MFB . Alternatively, you can use the menu of your Bluetooth phone.
12. **Mute/Unmute** the microphone. Press and Hold Volume ⊖ for 3 seconds during a call.
13. **Call Waiting\*:** While on a call and another incoming call appears, (beep tones dependent on your network) Press and Hold Volume ⊕ and Volume ⊖ together for 3 seconds. The current call will be placed on Hold and the incoming call will be answered. To return to the held call, Click Volume ⊕ and Volume ⊖ together again for 3 seconds.
14. **Call Conference\*:** To add a held call to the current conversation, Press and Hold MFB  for 3 seconds
15. **Disable/Enable the LED indicators:** (for night time driving): When your headset is in idle or standby mode Press and Hold Volume ⊕ and Volume ⊖ together for 3 seconds. After turning the headset OFF and back ON, the LED Indicators will be active again by default. Note the LED's are turned OFF while a call is active.
16. **Z9i Reset:** If you have already Paired 5 devices to the Z9i it is not possible to pair another as the memory is full. If you want to pair with another phone you must reset the headset. To reset the Z9i to factory settings; while in idle mode (not connected to any device), Click Volume ⊕ , Volume ⊖ and MFB  together (3 buttons). The Z9i will refresh its memory, delete all current pairing information and automatically go into Pairing mode (LED will flash Blue) ready to pair with a new device.

\* To use these functions, your phone/device must support the Bluetooth Handsfree Profile.

The Bluetooth Headset profile will not activate these features of the BlueAnt Z9i.

Download from [Www.Somanuals.com](http://Www.Somanuals.com). All Manuals Search And Download.



## BlueAnt Voice Isolation Technology™

You can switch between two settings of Voice Isolation - **STANDARD** and **MAX**.

**Voice Isolation Standard** - For use in normal everyday environments and gives you a natural sounding voice while removing mild noise.

**Voice Isolation Max** - Gives you more intelligible voice in a wide variety of high noise environments.

### HOW DO I SWITCH?

To switch between Standard and Max: Hold the MFB  for 1 sec while on a call

- When switching between Standard and Max you will hear a confirmation voice tag played from the Z9i speaker.
- When you first turn the headset ON, it will be in the Standard setting.
- After switching the headset OFF and back ON, the headset will return to the Standard setting by default.
- Standard and Max both use the same amount of battery power.













## LED Indicator Chart

Power ON	Solid Blue for 5 Seconds
Power OFF	Red flash 3 times
Pairing Mode	Blue flashing
Reset	Blue flashing
Charging	Solid Red

Charging with Power ON	Solid Red with a Purple Flash
Charging Complete	Red indicator OFF
Low Battery	All LED's change to Red
Idle	Blue flash every 8 seconds
Standby	2 Blue flashes every 5 seconds
Ongoing call	NO LED's

Download from [www.Somanuals.com](http://www.Somanuals.com). All Manuals Search And Download.

## Button Function Matrix

Z9i Function	Button	Time	Status
Power ON	MFB 	3 Seconds	From OFF
Power OFF	MFB 	3 Seconds	Idle/Standby
Enter Pairing Mode	MFB 	6 Seconds	From OFF
Answer Call	MFB 	Click	Ringing
End Call	MFB 	Click	Active Call
Reject Call	MFB 	1 Second	Ringing
Redial Last Number	Vol 	3 Seconds	Standby
Voice Dial Activate	MFB 	Click	Standby
Switch Voice Isolation between Standard and Max	MFB 	1 Second	Active Call
Volume Up	Vol 	Click	Active Call
Volume Down	Vol 	Click	Active Call
Mute	Vol 	3 Seconds	Active Call

### Standby Mode

means connected to a device but not on a call.













### Idle Mode

means the Z9i is ON but not connected to any device

### Multiple

button presses mean click together

### Advanced Z9i Functions

Z9i Function	Button	Time	Status
Disconnect/ Transfer	 & 	Click	Connected
Multi-Point - Place phone 1 on hold and receive phone 2	Vol 	3 Seconds	Active
Multi-Point - End phone 2, return to phone 1	MFB 	Click	Active
Multi-Point - End phone 1 receive phone 2	Vol 	3 Seconds	Active
Call Conference - Active phone only	MFB 	3 Seconds	Active Call
Call Waiting - Active phone only	 & 	3 Seconds	Active Call
Turn LED's OFF/ON	 & 	3 Seconds	Idle/Standby
Reset Device	MFB  &  & 	Click	Idle



## Advanced Headset Functions





### Pairing your headset with multiple Bluetooth devices

The Z9i will connect to 2 phones at a time but 5 devices can be paired to it.

1. Make sure the last phone used has Bluetooth switched off or is out of range.
2. Follow the procedure in 'Pairing Procedure' above for each device you want to pair.

### Multi-point

With Multi-point you can connect two phones to the Z9i and answer which ever phone rings.

1. **Connect:** The Z9i will connect to the last two phones connected upon powering ON. If you wish to connect a different previously paired phone, do so from that phones Bluetooth menu. After this the Z9i will always connect to that phone.
2. **Answer:** On an incoming call from either phone, just click the MFB  to answer the call.
3. **Answer a second call:** Place phone 1 on hold and receive phone 2 by press and holding Vol  for 3 seconds.
4. **End the second call:** To end phone 2, return to phone 1 on hold, click the MFB .
5. **Answer phone 2, hang up phone 1:** To End phone 1 and answer phone 2 Press and Hold Vol  for 3 seconds.

Note: Redial will dial the first connected phone only.

### Firmware upgrade

The BlueAnt Z9i is firmware upgradeable via the USB port and provided USB cable.

Please see the support section at [www.blueantwireless.com](http://www.blueantwireless.com) for information and downloads for available upgrades.

Download from [Www.Somanuals.com](http://Www.Somanuals.com). All Manuals Search And Download.

## Further Information

### Setting up a Phone Profile (different to Bluetooth Profiles)

In your phone, set up a Profile with appropriate ringing volumes and keypad tones and select and activate when using with the Z9i. Some phones can automatically activate a desired profile when connecting to a Car Kit or Headset Accessory. E.g. Go to Enhancement Settings and select a Default Profile to activate when the headset connects. With some phones you can also personalize levels to make suitable for yourself (see your phone's user manual for instructions on using and activating Phone Profiles). Typical phone Profiles are *General, Outdoor, Meeting, Silent, Handsfree, Headset, Portable handsfree and Carkit*.

### Phone/PDA/Computer Software

Please make sure you have the latest firmware upgrade for your phone especially if you are using a PDA Phone. Go to the support section of the manufacturers' website to check that you have the latest version. Many new mobile phones, PDA's and computer phones require a Bluetooth patch to improve Bluetooth functionality from the original released version.

### Resetting Your Phone/PDA

Phones and PDA's can become prone to software and memory issues which may cause Bluetooth reconnection problems. This can be fixed simply by turning the phone OFF and back ON again. The phone will be reset and the working memory cleared. Resetting your phone weekly can help maintain it's functionality including Bluetooth.

### Troubleshooting and Support Documents

See the support section of [www.blueantwireless.com](http://www.blueantwireless.com) for troubleshooting and Frequently Asked Questions (FAQ) as well as info on using with computers for VOIP application's.

Download from [Www.Somanuals.com](http://Www.Somanuals.com). All Manuals Search And Download.



## Specifications

<b>General Specification</b>	<ul style="list-style-type: none"><li>&gt; Bluetooth v2.0</li><li>&gt; Up to 10 meters RF coverage</li><li>&gt; CE,FCC,BQB, Ctick, RoHS / WEEE Compliant</li><li>&gt; Headset Profile, Hands-Free profile</li></ul>
<b>RF Spec.</b>	<ul style="list-style-type: none"><li>&gt; Carrier Frequency 2.402 ~ 2.480GHz</li><li>&gt; &lt; 0.1% BER at -80 dBm</li><li>&gt; 0 ± 4 dBm (Class 2)</li></ul>
<b>User Interface</b>	<ul style="list-style-type: none"><li>&gt; Blue color LED for operation indication.</li><li>&gt; Red color LED for low battery indication.</li><li>&gt; Mini USB for Charging battery or F/W upgrade</li></ul>
<b>Audio</b>	3GPP with DSP solution
<b>Battery type</b>	3.7V Lithium Polymer battery
<b>Talk Time</b>	Up to 5.5 Hours
<b>Stand-By time</b>	200hrs.
<b>Weight</b>	0.35 oz / 10 grams without ear hook or 11 grams with ear-hook
<b>Dimensions</b>	1.5 x 0.69 x 0.44 (inches) / 41 x 17.5 x 11.2 (mm)



## Z9i Bluetooth Headset

### General

1. What are the main difference between the Z9i and other Bluetooth headsets?
2. What is included in the Z9i package?
3. How does the Z9i use the Bluetooth technology?
4. How do I handle calls when the Z9i is connected?
5. Can I transfer an ongoing call back to my phone to continue it there?
6. How many devices can I pair to the Z9i?
7. Is my phone compatible?
8. What is the passcode/passkey of the Z9i?
9. Can I change the passcode of the Z9i?
10. Can I use voice activated dialling if my phone supports it?
11. Can I use the Z9i to listen to music from my mobile?
12. How often should I charge my Z9i?
13. Can I use my Z9i with my computer for VOIP applications?
14. Do I need to pair the devices every time I use them together?
15. What is Voice Isolation and how do I use it?
16. Can I switch the Voice Isolation prompt off?



## Bluetooth

1. What is Bluetooth Wireless Technology?
2. Is it safe to use Bluetooth devices? I have heard they can allow unauthorized connections.
3. Can somebody else take control of my Z9i if they are in range?
4. What is the difference between Handsfree and Headset Bluetooth Profiles?
5. How do I know if my devices are connected?
6. Can I connect more than one device to my Z9i at the same time?
7. How far can my mobile be from the Z9i and still remain connected?
8. Can other electrical devices cause interference with Bluetooth?
9. If I cup my hand over a Bluetooth device the signal strength and quality suffers. Why does this happen?
10. What is the difference between Bluetooth V1.2 and V2.0?
11. How do I use VOIP?

## Troubleshooting

1. How do I re-connect my Z9i?
2. Why won't my Z9i go into pairing mode?
3. The Z9i won't reset. What can I do?
4. Is my Z9i charged?
5. Why can't I hear any sound from the Speaker?
6. Why is the Z9i noisy and distorted?
7. My Z9i worked great but now it won't connect. What can I do?

8. The Z9i switches off when I hang up a call. What can I do?
9. Why can the talk time and standby time differ with the products specification description?
10. Why does my phones battery not last as long as it used to?
11. I am having trouble pairing a second phone. What can I do?
12. How can I stay near the Z9i but not have calls diverted through it?
13. My phone says "Bluetooth Module not found". What can I do?
14. I have a PDA phone that pairs to the Z9i but has trouble transferring calls. How can I fix this?
15. Why can't I hear the dial tone from headset when I dial?
16. Voice dialling is not successful every time. What can I do?
17. People cannot hear my voice. What am I doing wrong?
18. Is there a smaller rubber earpiece available?
19. Is there a car charger available for the Z9i?
20. Can I purchase extra accessories for the Z9i?
21. I have mixed up my AC charger with my other device chargers. What does the Z9i AC charger look like?
22. The speaker gel has come off. What can I do?
23. How do I upgrade the firmware for my Z9i?
24. Can I upgrade the Firmware on a Mac?
25. I'm having trouble upgrading the firmware and getting error messages. How do I do it?
26. There are so many button combinations to remember. What can I do?
27. I have read all the solutions in this document but I still cannot get my Z9i to work properly. What can I do?



## General

### 1. What are the main difference between the Z9i and other Bluetooth headsets?

The Z9i uses Voice Isolation Technology and has Dual Microphones for clearer voice with less background noise.

The Z9i feature multi-point technology allowing it to connect to 2 phones at the same time and answer either, when they ring, and being able to swap between phones during a call.

### 2. What is included in the Z9i package?

In the box is the Z9i headset, a USB charging cable, an AC charger, 2 x removable ear hooks, Small & Large ear bud, Quick Start Guide, User Manual & Warranty Card.

### 3. How does the Z9i use the Bluetooth technology?

Bluetooth is used to send and receive voice signals over radio waves between your mobile phone and the Z9i. It allows the Z9i to control phone calls on your mobile phone remotely.

### 4. How do I handle calls when the Z9i is connected?

For incoming calls simply press the MFB button (multi-function button) once to answer the call.

To answer a second phone while in a current call, press and hold the Volume up and Volume down buttons together for 3 seconds (if only one phone is connected to the headset, i.e. Multipoint is not in use) this will put the 1st call on hold and answer the 2nd phone.

To return to the 1st call, click the MFB. For detailed multipoint function instructions, please refer to the Quick Start Guide.

For outgoing calls press the MFB button once to activate voice dialling or dial as per normal from your phone and the call will transfer to the Z9i.

For redialling the last number called, press volume up button for 3 seconds.

Download from [Www.Somanuals.com](http://Www.Somanuals.com). All Manuals Search And Download.

**5. Can I transfer an ongoing call back to my phone to continue it there?**

Yes. Simply short press the Volume Up & Volume Down buttons simultaneously to disconnect from the Z9i and transfer the call to the phone.

**6. How many devices can I pair to the Z9i?**

The Z9i can store pairing information for 5 different phone devices.

**7. Is my phone compatible?**

If your phone has Bluetooth it more than likely supports a Handsfree or Headset Bluetooth profile, and so will work with the Z9i. Check your phone's manual for up to date information.

**8. What is the passcode/passkey of the Z9i?**

The Passcode for the Z9i is "0000".

**9. Can I change the passcode of the Z9i?**

No, the passkey is inbuilt and cannot be changed.

**10. Can I use voice activated dialling if my phone supports it?**

Yes. The Z9i supports voice activated dialling if your phone also supports it. Check your phones user manual for information on setting up this feature.

**11. Can I use the Z9i to listen to music from my mobile?**

Some mobiles can send music to the Z9i using the Handsfree profile but it will be a mono signal and sound a bit like an AM radio.

**12. How often should I charge my Z9i?**

You should charge the Z9i when the LED Indicator rapidly starts flashing red instead of blue. The battery will last for about 200 hrs on standby and much longer if the Z9i is switched off in between uses.



**13. Can I use my Z9i with my computer for VOIP applications?**

Yes. You can connect the Z9i to a PC or Mac that supports the Headset or Handsfree profile. To do this you need to have Bluetooth enabled in your computer by using a Bluetooth USB Dongle or having a computer that has Bluetooth inbuilt. Depending on the Bluetooth Software the connection process is different. Simply put the Z9i into Pairing mode, then search for it using your computers Bluetooth Software. Enter the Passkey "0000" then start the Headset/Handsfree service.

**14. Do I need to pair the devices every time I use them together?**

No. The pairing process is required only once for each phone unless the devices are deleted.

**15. What is Voice Isolation and how do I use it?**

Voice Isolation is BlueAnt's own proprietary DSP software which uses sophisticated techniques to separate the voice signal from the background noise using a dual microphone array. This technology is effective against noise sources whether they are stationary, impulsive or even other voices.

The Z9i has two voice Isolation modes: Standard & Max.

Voice Isolation Standard is used for normal environments with little background noise, and is the Default mode for the Z9i.

Voice Isolation Max is used for environments with a lot of background noise.

To switch between modes, while on a call short press the MFB.

**16. Can I switch the Voice Isolation prompt off?**

No. The Voice Isolation prompt cannot be turned off.

## Bluetooth

### 1. What is Bluetooth Wireless Technology?

Bluetooth Wireless Technology is a short-range communications technology using encryption for high security data/voice transmission

### 2. Is it safe to use Bluetooth devices, I have heard they can allow unauthorized connections?

For Bluetooth security reasons, once you have set up your Bluetooth devices we recommend turning OFF the visibility option in the Bluetooth Menu of your phone so that other Bluetooth users cannot see the your phone. (This only applies to a few mainly older Bluetooth enabled phones as most new phones have better security.)

### 3. Can somebody else take control of my Z9i if they are in range?

No, the Z9i can only connect to previously paired devices that have been authenticated. The Pairing procedure creates an encrypted key known only to the two devices paired.

### 4. What is the difference between Handsfree and Headset Bluetooth Profiles?

Handsfree Profile allows for extra features to be used with a mobile phone. Voice Dial, redial, call transfer are some that are included in Handsfree but not Headset. Handsfree also allows for a slightly better call quality.

### 5. How do I know if my devices are connected?

When Bluetooth is turned ON, on your phone you will see a Bluetooth symbol appear on your main screen that changes slightly (colours invert or arrows appear) when connected to the Z9i. Some phones show a Headset or Car symbol to notify you that the devices are connected.

### 6. Can I connect more than one device to my Z9i at the same time?

Yes, the Z9i utilises multi-point technology allowing you to connect to 2 phones at the same time and answer an incoming call from either phone.

Download from [Www.Somanuals.com](http://Www.Somanuals.com). All Manuals Search And Download.



**7. How far can my mobile be from the Z9i and still remain connected?**

The Z9i will remain connected within a range of 10 meters (30 ft). Sound quality may start to deteriorate after about 7 meters depending on your environment.

**8. Can other electrical devices cause interference with Bluetooth?**

Bluetooth technology employs a technique called frequency hopping to constantly change the frequency at which it sends data, reducing interference with wireless devices like wireless LAN's, cordless landline phones. Noise Interference can occur if the Bluetooth device is used in close proximity with a microwave. Check if there are any such devices in the surroundings, and if so keep the distance between the Z9i and such devices to at least 5 - 10m. Usually any interference will only cause a slight crackling sound. The frequency of Bluetooth is much higher than that of radio station bands.

**9. If I cup my hand over a Bluetooth device the signal strength and quality suffers.**

**Why does this happen?**

Bluetooth signals are radio waves and so do not need line of sight to operate. However, radio waves cannot travel through water and as the human body is made up of mostly water they cannot travel through it. Therefore, your hand will create a barrier causing slight interference and a loss of signal quality.

**10. What is the difference between Bluetooth V1.2 and V2.0?**

V2.0 is the current version of Bluetooth with Enhanced Data Rate (EDR) technology, with data transfer rates of up to 3Mbps compared with 1Mbps in V1.2.

Note: All BlueAnt products are forward and backward compatible (Our V1.2 products can be used with V2.0 phones and our V2.0 products can be used with V1.2 phones)



## 11. How do I use VOIP?

In order to use the Z9i for VoIP, you will need to have a Bluetooth enabled PC or laptop. If you are running Windows XP or Vista please ensure to update your Bluetooth driver from your PC/Laptops manufactures web site to ensure you have the latest driver. Once the Z9i has been paired to your PC/Laptop ensure that the VoIP applications audio settings are set to the Bluetooth Headset for both incoming and outgoing audio.

## Troubleshooting

### 1. How do I re-connect my Z9i?

Press the MFB button once shortly to re- connect to the first paired phone. (Voice dial may be activated if enabled in phone, short press MFB again to cancel this). Short press the Volume Up & Volume Down buttons together to disconnect.

### 2. Why won't my Z9i go into pairing mode?

If you have already paired 5 different devices to the Z9i you will need to reset it to pair a new device. To Reset the Z9i, Short press all three buttons, this will delete all pairing information and enter pairing mode.

The Z9i sometimes requires a few seconds to establish a connection.

Please be patient while devices are searching.

Download from [Www.Somanuals.com](http://Www.Somanuals.com). All Manuals Search And Download.



### **3. The Z9i won't reset. What can I do?**

Ensure that the Z9i is not connected to any phone, wait one minute, then and press the Volume up, Volume down and the MFB together to reset. If this does not resolve your issue please contact Technical Support.

### **4. Is my Z9i charged?**

The LED will blink red instead of Blue when the battery is low.

A constant red light will show when the headset is plugged in and charging. It will turn off when fully charged.

If the Z9i is turned on while charging you will see a purple flash while charging.

### **5. Why can't I hear any sound from the Speaker?**

The phone's memory may have become corrupt and can be fixed by rebooting the phone. If this does not resolve the issue, delete the pairing information and re-pair

### **6. Why is the Z9i noisy and distorted?**

Turn the Z9i Volume down to a level that does not give echo or feedback. Also turn the volume down on your phone. A low battery can also cause bad voice quality. Please charge the headset. Some people like to have their phone ring loudly, but this may cause distortion when transferred to the Z9i speaker.

In your phone, set up a Profile with lower ringing volumes and keypad tones and activate for use with the Z9i. (See your phones user manual for instructions on setting up profiles).

Alternatively, you may have low antenna strength from your phone network which may cause signal drop outs or disruption.

Check our web site to confirm that you have the latest firmware installed. If you are running an old version of the Z9i firmware please download the update and follow the instructions to update your firmware

Download from [Www.Somanuals.com](http://Www.Somanuals.com). All Manuals Search And Download.

**7. My Z9i worked great but now it won't connect. What can I do?**

As newer phones are like mini-computers, they may become corrupt over time and you may need to reset them every so often (at least once a week is good). Simply switch off your phone remove the battery for a few seconds, replace and reboot. The Z9i should now connect. If not, remove existing pairing and re-pair the devices.

**8. The Z9i switches off when I hang up a call. What can I do?**

Ensure that you release the MFB when you hear the tone for end call. Alternatively, please check that you have the latest firmware installed on your Z9i Headset.

**9. Why can the talk time and standby time differ with the products specification description?**

The talk time and stand by time will differ based on different brands of mobile phone, different distances between devices and different Bluetooth link status (active, sleep, sniff mode etc.)

**10. Why does my phones battery not last as long as it used to?**

When you switch Bluetooth ON, your phone searches for Bluetooth devices in the area. This will use more battery power than without Bluetooth ON. The Z9i has a standby mode it enters when connected to your phone so that it minimizes battery loss. This allows the Z9i to have such outstanding battery life as well as reducing the power required by the phone.

**11. I am having trouble pairing a second phone. What can I do?**

When pairing a second mobile phone, make sure the first is off or out of range.

If you cannot connect to a previously paired and connected phone, go to the Bluetooth menu in the phone, select the Z9i and Press Connect. Some phones may require this if it is the second device used. You do not have to re-pair the devices just manually connect.



**12. How can I stay near the Z9i but not have calls diverted through it?**

The Z9i will remain connected within a range of 10 meters. If you are staying near the device but want to take calls through the phone simply switch the Z9i off by long pressing the MFB button.

**13. My phone says “Bluetooth Module not found”. What can I do?**

This means that your phone cannot find its internal Bluetooth chip for some reason.

Restarting your phone should fix this problem. If not please contact your phones manufacturer.

**14. I have a PDA phone that pairs to the Z9i but has trouble transferring calls. How can I fix this?**

Go to the phone manufacturers' website and download and install the latest ROM software for your device. Many new PDA phones are software upgradeable and fixes are made available for problems such as this. This is especially the case with newly released devices.

**15. Why can't I hear the dial tone from headset when I dial?**

Check the Bluetooth protocol of your mobile phone to see if it supports in-band ring tone. If it does, then you should hear the dial tone (such as Nokia series) or if it doesn't you cannot (such as some Sony-Ericsson series).

**16. Voice dialling is not successful every time. What can I do?**

Using your headset to record the voice tags can enhance the recognition rate. Please refer to the user guide of your phone.

Noisy environments can affect voice recognition. Record your voice commands in a quiet environment.

**17. People cannot hear my voice. What am I doing wrong?**

Check that the headset is not in mute mode.

**18. Is there a smaller rubber earpiece available?**

Yes there is 2 different size ear pieces available for the Z9i and you should have received one of each when you purchased the Z9i.

**19. Is there a car charger available for the Z9i?**

No the Z9i only comes with an AC wall charger.

**20. Can I purchase extra accessories for the Z9i?**

Z9i spare parts and accessories can be purchase separately from one of our authorised spare parts retailers. Please check our web site [www.blueantwireless.com](http://www.blueantwireless.com) for your nearest retailer.

**21. I have mixed up my AC charger with my other device chargers. What does the Z9i AC charger look like?**

The Z9i charger has the BlueAnt logo and BlueAnt written on the top and has the following specs:

Model DSA-5P-05 FUS

Input 100-240v 50/60hz

Output +5v 0.5a

**22. The speaker gel has come off. What can I do?**

The speaker gel has a screw thread on the inside and can easily be screwed back onto the Z9i Headset.

**23. How do I upgrade the firmware for my Z9i?**

In order to upgrade the firmware on your Z9i you will need to purchase a USB cable and have access to a PC with internet access. Log onto the support section of our web site [www.blueantwireless.com](http://www.blueantwireless.com) and follow the links to download the Z9i upgrade instructions and the Z9i Upgrade zip files. Unzip both files to your computer then follow the instructions to upgrade the firmware.

Download from [Www.Somanuals.com](http://Www.Somanuals.com). All Manuals Search And Download.



**24. Can I upgrade the Firmware on a Mac or Windows x64 (64bit)?**

At this point, the upgrade software will only run on a Windows XP and Vista based system.

**25. I'm having trouble upgrading the firmware and getting error messages. How do I do it?**

Please ensure you are following the upgrade instructions correctly and that all other Bluetooth devices are disabled or turned off. If you are still receiving errors please contact our technical support for assistance.

**26. There are so many button combinations to remember. What can I do?**

The most common Z9i features can be activated by simply using the MFB. Most of the complicated combinations are for features most people will not use regular basis. The Quick Start Guide is also a handy pocket / wallet sized guide that can be taken with you and referred to while you are getting to know your Z9i and its features.

**27. I have read all the solutions in this document but I still cannot get my Z9i to work properly. What can I do?**

Please make an enquiry to [support@blueant.com.au](mailto:support@blueant.com.au) or call the BlueAnt Customer Service Team on 1300 669 049 (AUS) or 0800 443 122 (NZ).

For Nth America call 1 866 891-3032 or [customercare@myblueant.com](mailto:customercare@myblueant.com).

## Help

### BlueAnt Warranty Process

1. Should you be having difficulties in operation please refer to the online FAQ and support documents, or call us. Our number is on the back page of this manual
2. Check our website for more information, updated manuals and troubleshooting. [www.blueantwireless.com](http://www.blueantwireless.com)
3. Call us and speak to one of the BlueAnt Wireless Customer Service Team  
We will clarify whether you have a hardware or connection issue.
4. If your unit is confirmed to be faulty, a Return Merchandise Authorization (RMA) will be issued.
5. Return the unit directly to BlueAnt for testing and replacement of faulty items.



### Warranty Terms and Conditions

1. BlueAnt Warrant the original purchaser of this product only.
2. BlueAnt will replace or repair any faulty product provided it has not been misused or abused in any way.
3. There are no user serviceable parts inside this product. Using a non-authorized repairer will void the warranty.
4. The Warranty is valid for 2 years (24 months) from the date of purchase.
  - Proof of purchase must be provided to obtain warranty service.
  - Headset must be in original packaging with serial number for warranty to be valid.
5. Warranties are effective from the proof of purchase date and not from the date of any subsequent repair or replacement.

Download from [Www.Somanuals.com](http://Www.Somanuals.com). All Manuals Search And Download.



## Disclaimers:

This manual is published by BlueAnt. The information contained in this document is subject to change without notice. All rights reserved. The Bluetooth word, mark and logos are owned by the Bluetooth SIG, Inc. and any use of such marks by BlueAnt is under license. Other trademarks and trade names are those of their respective owners.

## Please protect your ears.

**Warning:** This headset can reach a maximum volume of 101 decibels. Prolonged use of a headset at high volumes may affect your hearing capacity. Using for extensive time periods may result in noise induced hearing loss (NIHL). Hearing loss may occur if the headset is used at maximum volumes for more than 5 minutes per day. Hearing loss may occur if the headset is used at medium volumes if used for more than 1 hour per day. Exposure to sound at such a close range may result in hearing loss, even at low levels. Do not listen at high volume levels. Remember that your ears will adapt to the volume level set and if you change to higher levels your ear may feel no discomfort but may be doing damage to your ear.



## Correct Disposal of This Product (Waste Electrical & Electronic Equipment)



(Applicable in the European Union and other European countries with separate collection)

This marking shown on the product or its literature, indicates that it should not be disposed with other household wastes at the end of its working life. To prevent possible harm to the environment or human health from uncontrolled waste disposal, please separate this from other types of wastes and recycle it responsibly to promote the sustainable reuse of material resources. Household users should contact either the retailer where they purchased this product, or their local government office, for details of where and how they can take this item for environmentally safe recycling. Business users should contact their supplier and check the terms and conditions of the purchase contract. This product should not be mixed with other commercial wastes for disposal.

*This equipment is in compliance with the essential requirements and other relevant provisions of Directive 1999/5/EC*

### FCC Notices

This device contains FCC ID: VHFBLUEANTZ9i which complies with part 15 of the FCC rules. Operation is subject to the following two conditions: (1) This device may not cause harmful interference, and (2) This device must accept any interference received, including interference that may cause undesired operation.

FCC RF Exposure requirements:

“This device and its antenna(s) must not be co-located or operating in conjunction with any other antenna or transmitter.”



BlueAnt®

# GUIDE DE L'UTILISATEUR de BlueAnt Z9i

## Aperçu du produit

BlueAnt Z9i est une oreillette à deux microphones dotée de la technologie sans fil Bluetooth. Profitant de BlueAnt Voice Isolation Technology™, logiciel de synthèse réputé pour sa clarté cristalline, le double microphone révolutionne la saisie vocale et accroît les performances acoustiques de BlueAnt Z9i lors des communications orales en temps réel. BlueAnt Z9i est lauréat du prix « CES Design and Engineering »; ce prix prestigieux contribue à en faire la prochaine génération des micros-casques Bluetooth à grandes capacités antibruit.

L'isolation vocale se fait en deux modes : **STANDARD** et **MAX**.

**Isolation vocale Standard:** Ce mode s'utilise en milieu ordinaire de tous les jours, maintient le naturel de votre voix tout en supprimant les faibles bruits ambiants.

**Isolation vocale MAX:** Ce mode rend votre voix plus audible dans divers milieux très bruyants.

## Caractéristiques de BlueAnt Z9i

- Prix CES Innovations Design & Engineering 2007
- Deux microphones pour une saisie vocale intelligible et naturelle
- Voice Isolation Technology™ issue de Digital Signal Processor (DSP), logiciel de synthèse révolutionnaire de BlueAnt
- Alternance possible entre deux modes d'isolation vocale – Standard et Max – au cours d'un appel
- DSP de première qualité et ultraperformant : suppression d'échos, réduction de bruits, y compris le bruit caractéristique du vent et conversation d'une clarté cristalline, même dans un milieu très bruyant, grâce à une meilleure isolation des signaux vocaux et des bruits de fond
- Fonction Multi Point incorporée pour se connecter à 2 téléphones simultanément
- Témoin de connexion et de reconnexion automatique
- Sonnerie différente selon les correspondants, connus et inconnus
- Prise casque innovante pour une fixation (hors usage) à la chemise ou à la boutonnière
- Poids et taille réduits (3,8 cm de longueur pour un poids de 11 g seulement)
- Crochet auriculaire translucide et élégant
- Autonomie de conversation/veille : 5,5 h/200 h
- Garantie de pièce de rechange de 2 ans
- Bluetooth 2.0

## Technologie sans fil Bluetooth

Bluetooth est la technologie sans fil la plus évoluée aujourd'hui sur le marché. Elle assure facilement la liaison entre vos appareils Bluetooth dans un rayon de 10 mètres (30 pieds).

Download from [Www.Somanuals.com](http://www.Somanuals.com). All Manuals Search And Download.



## Appareils compatibles avec le microphone mixte Z9i

Votre micro-casque est validé Bluetooth 2.0 et gère les profils casque et mains libres. L'oreillette Z9i peut stocker de l'information et se connecter sans fil à cinq appareils homologués Bluetooth 1.1, 1.2 ou 2.0 (compatibilité descendante et ascendante), y compris les téléphones mobiles et les ANP (assistant numérique personnel), sous PC ou Mac, ou tout autre appareil adapté à Bluetooth et prenant en charge les profils casque et mains libres. **Le présent guide vous montre comment utiliser votre oreillette de concert avec votre téléphone validé Bluetooth.**

## Contenu de l'emballage

- > 1 oreillette Bluetooth à microphone mixte BlueAnt Z9i
- > 2 crochets auriculaires
- > Une petite et une grosse oreillette
- > Câble de connexion USB
- > Adaptateur CA
- > Guide de démarrage rapide
- > Guide de l'utilisateur
- > Carte de garantie

## Présentation

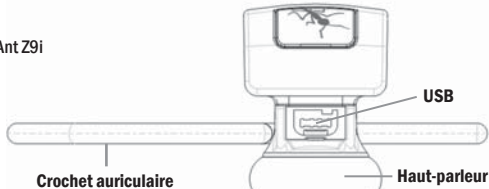
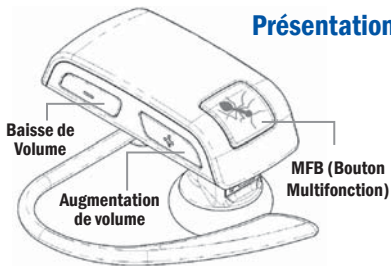

## Mise en service

Avant de pouvoir utiliser votre oreillette, vous devez effectuer les deux étapes suivantes :

1. charger complètement votre oreillette à l'aide de l'un des chargeurs fournis;
2. brancher votre oreillette sur un appareil validé Bluetooth tel qu'un téléphone cellulaire, un ANP ou un ordinateur

## Charge

L'oreillette Z9i est fournie avec une pile rechargeable intégrée. Lorsque vous l'utilisez pour la première fois, vous devez charger complètement votre Z9i. Pendant la charge, un voyant lumineux rouge s'allume en permanence et lorsque la pile est à pleine charge, le voyant rouge s'éteint. La pile prend entre 2 h et 2 h 30 pour être pleinement chargée. Les conversations prolongées réduisent l'autonomie de veille de la batterie. L'oreillette mettra plus de temps à se recharger si elle reste inutilisée pendant de longues périodes.

### Charger la Z9i au moyen du câble USB

1. Branchez le câble USB de charge sur le port USB de votre PC ou Mac.
2. Branchez l'autre extrémité du câble USB sur le port d'alimentation du micro-casque. Assurez-vous que le câble de connexion USB corresponde à la prise d'alimentation USB du micro-casque. Le câble devrait s'insérer facilement dans la prise. Aucune force n'est donc nécessaire. Le voyant DEL rouge s'allume.
3. Lorsque la charge est complète, le voyant DEL rouge s'éteint. Enlevez l'adaptateur du chargeur.

### Charger la Z9i sur une prise murale

1. Branchez le chargeur sur la prise murale d'alimentation secteur et connectez le câble sur le port d'alimentation de la Z9i. Assurez-vous que le câble de connexion USB corresponde à la prise d'alimentation USB du micro-casque. Le câble devrait s'insérer facilement dans la prise. Aucune force n'est donc nécessaire. Le voyant DEL rouge s'allume.
2. Lorsque la charge est complète, le voyant DEL rouge s'éteint. Enlevez l'adaptateur du chargeur.



## Port de l'oreillette BlueAnt Z9i

Passez le crochet auriculaire à travers le trou prévu dans l'attache du micro-casque et ajustez la longueur de manière à ce qu'il s'accroche confortablement à votre oreille. Assurez-vous que le micro-casque est orienté vers la bouche. La Z9i se porte sur l'oreille gauche ou droite.



Pour une performance optimale, l'oreillette Z9i doit être orientée vers la bouche.

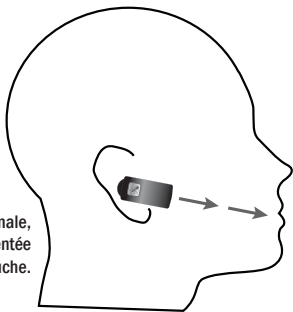

## Pairage

Avant d'utiliser l'oreillette, vous devez créer entre elle et votre téléphone cellulaire une clé de liaison commune. Cette opération de couplage permettra de garder en mémoire une connectivité entre votre oreillette et votre téléphone cellulaire Bluetooth. Le pairage ne devra se faire qu'une seule fois, c'est-à-dire lorsque la Z9i est connectée pour la première fois à un nouveau téléphone. La Z9i peut stocker les données de pairage de cinq (5) périphériques Bluetooth différents. Si vous désirez établir une liaison avec un autre appareil, au-delà des 5 premiers, vous devrez RÉINITIALISER l'oreillette en suivant les instructions ci-dessous (Fonctions micro-casque de base).

Download from [www.Softmanuals.com](http://www.Softmanuals.com). All Manuals Search And Download.

## Pour permuter les embouts d'oreille

Le Z9i est livré avec deux tailles d'embout. Le gros embout d'oreille est déjà monté sur l'unité.

Si vous souhaitez plutôt utiliser le petit embout, veuillez dévisser (sens inverse des aiguilles) le gros embout puis visser (sens des aiguilles) le plus petit.

Assurez-vous de dévisser l'embout d'oreille sans forcer et ne serrez pas excessivement lorsque vous fixez le plus petit embout.

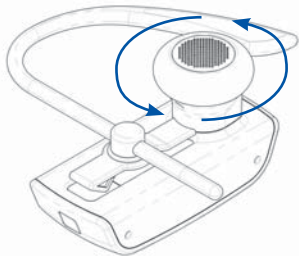



Dévissez sans forcer pour ôter l'embout.

Vissez sans forcer pour l'attacher.



## Procédure de pairage









Les étapes indiquées ci-après ne le sont qu'à titre indicatif, car pouvant varier d'un téléphone à l'autre tout en conservant le même processus.

1. Mettez votre téléphone sur Arrêt, puis sur Marche pour rafraîchir la mémoire.
2. Rapprochez votre téléphone mobile à environ 30 cm du microphone mixte Z9i.
3. Localisez le menu Bluetooth de votre téléphone mobile. Mettez Bluetooth sur Marche.  
(Au besoin, consultez le guide de l'utilisateur de votre téléphone mobile.)
4. Mettez l'oreillette sur Arrêt, puis appuyez sur le bouton MFB  pendant environ 6 secondes, sans le relâcher. Le voyant DEL s'allumera en bleu intense et se mettra à clignoter. A ce stade, l'oreillette est en mode Pairage et prête à se connecter à d'autres périphériques validés Bluetooth en repérage. Le mode Pairage restera actif pendant deux 2 minutes.
5. Pour ajouter un nouveau périphérique Bluetooth, repérez-le sur votre téléphone mobile. (Il ne faut que quelques secondes pour rechercher et trouver d'autres périphériques Bluetooth à proximité.)
6. Une fois la liaison établie avec un périphérique Bluetooth ou plus, votre téléphone affichera « BlueAnt Z9i ». Défilant vers le bas, sélectionnez-le, puis appuyez sur OK pour confirmer le pairage.
7. Entrez la clé de liaison « 0000 » lorsque le téléphone vous y invite. Le téléphone et le Z9i sont maintenant en liaison.
8. Un paramètre de sécurité additionnel pourrait se révéler nécessaire pour assurer la connexion automatique entre l'oreillette et le téléphone, c'est-à-dire sans confirmation préalable. En général, dans le menu des options de BlueAnt Z9i, on se référera à ce paramètre par : « défini comme autorisé », « ajouter aux périphériques sûrs », « connexion autorisée » ou autres.
9. Si nécessaire à la première connexion, sélectionnez l'option BlueAnt Z9i pour vous connecter au téléphone OU appuyez sur le bouton MFB  de l'oreillette pour vous connecter au téléphone.





## Fonctions de base du micro-casque

Pour faciliter la consultation, vous pouvez vous référer également au Tableau des boutons/fonctions et au Guide de démarrage rapide.

- 1. Mise en service** : Appuyez sur le bouton MFB  pendant 3 secondes, sans le relâcher. Le voyant DEL bleu s'allumera en continu et, si la pile est suffisamment chargée, le voyant restera allumé pendant 5 secondes. En revanche, si la pile est en partie déchargée, le voyant DEL rouge s'allumera en continu. Une fois mise en service, votre oreillette se connectera automatiquement au dernier téléphone que vous avez utilisé, à moins qu'il ne soit hors de portée. Si aucun téléphone n'a été mis en liaison, votre Z9i se mettra en mode Pairage. Si aucun des téléphones appariés n'est dans la zone de fonctionnement, votre Z9i se mettra en mode Inactif.
- 2. Mise hors service** : Appuyez sur le bouton MFB  pendant 3 secondes, sans le relâcher. Le voyant Del rouge clignote trois fois.
- 3. Entrer en mode Pairage** : Mettez l'oreillette sur Arrêt, puis appuyez sur le bouton MFB  pendant environ 6 secondes, jusqu'à ce que le voyant Del bleu commence à clignoter. L'oreillette restera en mode Pairage pendant deux minutes, puis passera en mode Veille. Pour passer à nouveau en mode Pairage, répétez cette étape.
- 4. Placer un appel** : Composez le numéro sur le pavé numérique de votre téléphone. La sortie audio se fera automatiquement par le micro-casque.
- 5. Répondre à un appel ou y mettre fin** : Cliquez sur une fois MFB  à l'arrivée d'un appel. Appuyez sur le bouton MFB  pendant 3 secondes, sans le relâcher pour y mettre fin.
- 6. Refuser\* un appel** : Appuyez sur le bouton MFB  pendant 3 secondes, sans le relâcher, à l'arrivée d'un appel.
- 7. Recomposer le dernier numéro\*** : Appuyez, sans le relâcher, sur le bouton Volume  pendant trois secondes environ. Pour annuler la recomposition du dernier numéro, cliquez sur MFB .
- 8. Activer la composition vocale \*** : Appuyez une fois sur MFB  pendant que vous êtes connecté à un téléphone. Les



commandes vocales doivent avoir été enregistrées sur le téléphone (voir le guide de l'utilisateur du téléphone).

9. **Volume** : Pour ajuster le volume à votre convenance, cliquez sur le bouton Volume ⊕ ou Volume ⊖ pendant que vous êtes au téléphone.
10. **Déconnecter / Transférer** : Pour couper la liaison de la Z9i avec le téléphone actuellement connecté ou réacheminer vers le téléphone un appel en cours, cliquez à la fois sur les boutons Volume ⊕ et Volume ⊖
11. **Reconnecter** : Pour reconnecter votre téléphone à l'oreillette Z9i, mettez-la simplement en service. Ou encore, appuyez sur MFB  une fois que Z9i est sur Marche. Autrement, vous pouvez le faire à partir du menu de votre téléphone Bluetooth.
12. **Sourdine / fin de sourdine** : Appuyez, sans relâcher, sur le bouton Volume ⊖ pendant trois secondes pendant que vous êtes au téléphone.
13. **Appel en attente\*** : Si vous êtes au téléphone et qu'un autre appel arrive (timbres sonores variant selon votre réseau), appuyez à la fois sur les boutons Volume ⊕ et Volume ⊖ pendant trois secondes. L'appel en cours sera mis en attente au profit de l'appel entrant. Pour revenir à l'appel en attente, appuyez à la fois sur les boutons ⊕ et Volume ⊖ pendant trois secondes.
14. **Appel conférence\*** : Pour faire entrer un correspondant dans une conversation en cours, appuyez, sans relâcher, sur le bouton MFB  pendant trois secondes.
15. **Désactiver/activer les voyants DEL** : (pour conduite de nuit) : Appuyez à la fois sur les boutons ⊕ et Volume ⊖ pendant trois secondes lorsque votre oreillette est en mode Inactif ou Veille. Si l'oreillette est mise sur Arrêt, puis remis en service, les voyants DEL redeviennent actifs par défaut. Notez que les voyants DEL sont éteints pendant qu'un appel est en cours.
16. **Réinitialisation de l'oreillette Z9i** : Si vous avez déjà apparié 5 périphériques à votre oreillette, la mémoire sera pleine et il ne vous sera plus possible d'en appairier un autre, à moins de réinitialiser l'oreillette. Pour rétablir les paramètres d'usine de l'oreillette Z9i, cliquez à la fois sur Volume ⊕, Volume ⊖ et MFB  (3 boutons) pendant

qu'elle est en mode Inactif (c'est-à-dire non apparié à un appareil). L'oreillette réactualisera sa mémoire, supprimera toutes les données de pairage courantes et se mettra automatiquement en mode Pairage (voyant DEL clignotant en bleu), prêt à établir un pairage avec un nouveau périphérique.

\*Pour accéder à ces fonctions, votre téléphone ou périphérique doit disposer du profil Mains libres de Bluetooth. Ces fonctions de BlueAnt Z9i ne seront pas activées par le profil Micro-casque Bluetooth.

---

## Voice Isolation Technology™ de BlueAnt

Vous pouvez alterner entre deux modes d'isolation vocale : **STANDARD** et **MAX**.

**Voice Isolation Standard :** Ce mode s'utilise en milieu ordinaire de tous les jours, maintient le naturel de votre voix tout en supprimant les faibles bruits ambiants.

**Voice Isolation MAX :** Ce mode rend votre voix plus audible dans divers milieux très bruyants.

### COMMENT PASSER D'UN MODE À L'AUTRE ?

Pour alterner entre les modes Standard et Max : Cliquez sur MFB  pendant que vous parlez au téléphone.

- Lorsque vous alternez entre les modes Standard et Max, Z9i fait retentir un timbre sonore à titre de confirmation.
- Lorsque vous mettez l'oreillette en marche pour la première fois, l'isolation vocale sera en mode Standard.
- Si vous démarrez et arrêtez l'oreillette, elle se remettra par défaut en mode Standard.
- La consommation de pile est la même en mode Standard ou en mode MAX.

Download from [www.Somanuals.com](http://www.Somanuals.com). All Manuals Search And Download.





## Tableau du voyant DEL

Mise en service	Bleu continu pendant 5 secondes
Mise hors service	Clignotant rouge (3 fois)
Mode Pairage	Clignotant bleu
Réinitialiser	Clignotant bleu
Alimentation	Rouge continu
Charge en état de marche	Rouge continu avec clignotant violet
Pleine charge	Voyant rouge éteint
Décharge de pile	Voyants DEL au rouge
Inactif	Clignotant bleu toutes les 8 secondes
Veille	2 clignotements bleus toutes les 5 secondes
Appel en cours	Voyants DEL inactifs

## Tableau des boutons/fonctions

Fonction Z9i	Bouton	Durée	Statut
Marche ON	MFB	3 secondes	A partir de OFF
Arrêt OFF	MFB	3 secondes	Inactif/Standby
Passer en mode couplage	MFB	6 secondes	A partir de OFF
Répondre à un appel	MFB	Clic	Sonnerie
Raccrocher	MFB	Clic	Appel en cours
Refuser un appel	MFB	1 seconde	Sonnerie
Recomposer le dernier numéro	Vol	3 secondes	Standby
Activer la reconnaissance vocale	MFB	Clic	Standby
Sélectionner l'isolation vocale entre Standard et Max	MFB	1 seconde	Appel en cours
Augmenter le volume	Vol	Clic	Appel en cours
Baisser le volume	Vol	Clic	Appel en cours
Fonction muet	Vol	3 secondes	Appel en cours

## Tableau des boutons/fonctions

Fonctions avancées Z9			
Fonction Z9i	Bouton	Durée	Statut
Déconnexion/ Transfert	⊕ & ⊖	Clic	Connecté
Multi-Point - Mise en attente du téléphone 1 réception sur le téléphone 2	Vol ⊕	3 secondes	Actif
Multi-Point - Fin de la réception sur le téléphone 2, retour sur le téléphone 1	MFB 	Clic	Actif
Multi-Point - Fin de la réception sur le téléphone 1 réception sur le téléphone 2	Vol ⊖	3 secondes	Actif
Appel conférence - Seulement sur le téléphone actif	MFB 	3 secondes	Appel en cours
Appel en attente - Seulement sur le téléphone	⊕ & ⊖	3 secondes	Appel en cours
Eteindre/allumer les LEDs	⊕ & ⊖	3 secondes	Inactif/Standby
Remise à zéro	MFB  & ⊕ & ⊖	Clic	Inactif

### Mode Veille

Connexion à un appareil mais aucun appel n'est en cours

### Mode Inactif

Z9i sur Marche mais non connectée à un périphérique

**Appuyer sur boutons multiples**  
Boutons à cliquer ensemble







## Fonctions avancées du casque

### Couplage du casque avec plusieurs dispositifs Bluetooth

Il est possible de connecter 2 téléphones au Z9i simultanément bien qu'il soit possible d'y connecter 5 dispositifs.

1. Assurez-vous que le dernier téléphone utilisé a le Bluetooth éteint ou est hors de portée.
2. Suivez la procédure décrite dans 'Procédure de couplage' ci-dessus pour chacun des dispositifs que vous souhaitez connecter.

**Multi-point** La fonction Multi-point vous permet de connecter deux téléphones au Z9i et de répondre à celui qui sonne.

1. **Connexion:** le Z9i se connectera aux deux derniers téléphones qui étaient connectés à la mise sous tension. Si vous souhaitez raccorder un autre téléphone qui était connecté auparavant, servez-vous du menu Bluetooth de celui-ci. Une fois cette opération terminée le Z9i sera toujours connecté à ce téléphone.
2. **Répondre:** quand un appel arrive de l'un des deux téléphones, contentez-vous de cliquer sur MFB  pour répondre à cet appel.
3. **Répondre à un deuxième appel:** mettez le téléphone 1 en attente et recevez l'appel sur le téléphone 2 en maintenant enfoncée la touche Vol  pendant 3 secondes.
4. **Terminer le deuxième appel:** pour terminer l'appel sur le téléphone 2, retournez sur le téléphone 1 qui est en attente, cliquez sur MFB .
5. **Répondre au téléphone 2, raccrocher le téléphone 1:** pour raccrocher le téléphone 1 et répondre au téléphone 2, maintenez enfoncée la touche Vol  pendant 3 secondes.

Note: la recombinaison du numéro se fera seulement sur le premier téléphone qui était connecté.

### Mise à jour du micrologiciel

BlueAnt Z9i est un micrologiciel actualisable via le port USB et au moyen du câble USB fourni. Pour en savoir plus sur le micrologiciel et les mises à jour disponibles, consultez la rubrique Assistance sur [www.blueantwireless.com](http://www.blueantwireless.com).

Download from [www.Somanuals.com](http://www.Somanuals.com). All Manuals Search And Download.

## Information complémentaire

### Définition d'un profil téléphonique (autre que les profils Bluetooth)

Sur votre téléphone, définissez un profil selon la sonnerie et la tonalité, puis procédez à la sélection et à l'activation lorsque vous utilisez votre oreillette Z9i. Certains téléphones peuvent activer automatiquement le profil voulu lorsqu'ils se connectent à un Kit auto ou à un accessoire pour micro-casque. A titre d'exemple, cliquez sur le menu Amélioration et choisissez un profil à activer par défaut lorsque se connecte le micro-casque. Certains téléphones vous permettent aussi de personnaliser les niveaux à l'envie (consultez le guide de l'utilisateur de votre téléphone pour savoir comment activer et utiliser les profils téléphoniques). Voici les profils téléphoniques types : *Général, Plein air, Réunion, Muet, Mains libres, Micro-casque, Portable mains libres et Kit auto.*

### Micrologiciel pour téléphone, ANP et ordinateur

Assurez-vous d'avoir la mise à jour la plus récente du micrologiciel, surtout si vous utilisez un téléphone ANP. Pour en être sûr, consultez la rubrique Assistance sur le site Web du fabricant. Nombreux sont les nouveaux téléphones mobiles, ANP et ordinateurs qui nécessitent un correctif Bluetooth pour en améliorer les fonctionnalités acquises depuis la version d'origine.

### Réinitialisation de votre téléphone/ANP

Les téléphones et les ANP sont sujets à des problèmes informatiques (logiciel et mémoire) qui pourraient entraîner des problèmes de reconnexion Bluetooth. Ces problèmes peuvent être réglés facilement dès lors que vous mettez le téléphone hors service puis en service à nouveau. Le téléphone s'en trouvera réinitialisé et la mémoire de travail effacée. La réinitialisation hebdomadaire de votre téléphone aidera au maintien des fonctionnalités dont Bluetooth.

### Dépannage et assistance

Pour obtenir des documents d'assistance (dépannage, FAQ) et savoir tirer partie des applications voix sur IP sur l'ordinateur

Download from [www.SonyManuals.com](http://www.SonyManuals.com) App Manuals Search And Download.



## Specifications

<b>Spécifications générales</b>	<ul style="list-style-type: none"><li>&gt; Bluetooth 2.0</li><li>&gt; Portée RF de 10 m</li><li>&gt; Certifiée CE, FCC, BQB, RoHS / WEEE</li><li>&gt; Profils Micro-casque et Mains libres</li></ul>
<b>Spécifications RF</b>	<ul style="list-style-type: none"><li>&gt; Fréquence de service 2.402 ~ 2.480 GHz</li><li>&gt; TEB &lt; 0.1% à -80 dBm</li><li>&gt; 0 ± 4 dBm (classe 2)</li></ul>
<b>Interface utilisateur</b>	<ul style="list-style-type: none"><li>&gt; Voyant Del bleu (indicateur fonctionnel)</li><li>&gt; Voyant DEL rouge (indicateur de décharge de la batterie)</li><li>&gt; Mini USB pour charger la pile ou actualiser le micrologiciel</li></ul>
<b>Audio</b>	3GPP avec technologie DSP
<b>Type de pile</b>	Pile au lithium-polymère 3.7V
<b>Temps de conversation</b>	Jusqu'à 5,5 heures
<b>Veille</b>	200 heures
<b>Poids</b>	10/11 g sans/avec crochet auriculaire
<b>Dimensions (mm)</b>	41 x 17,5 x 11,2 (mm) / 1,61 x 0,69 x 0,44 (inches)



## Aide

### Garantie BlueAnt : processus

1. Si vous avez des difficultés à faire fonctionner l'oreillette, veuillez consulter les documents d'assistance en ligne (FAQ) ou n'hésitez pas à nous appeler. Notre numéro de téléphone se trouve au verso du présent guide.
2. Visitez aussi notre site Web et vous y trouverez des informations complémentaires y compris des guides d'utilisation et de dépannage actualisés. [www.blueantwireless.com](http://www.blueantwireless.com)
3. Appelez-nous et parlez à un membre de notre équipe du Service à la clientèle  
Nous pourrons déterminer si vous avez un problème de matériel ou de connexion.
4. Si votre oreillette s'avère défectueuse, un numéro d'autorisation de retour d'article (RMA) vous sera émis.
5. Retournez l'oreillette directement à BlueAnt pour dépannage et remplacement de pièces défectueuses.

### Garantie : conditions générales

1. BlueAnt garantie ce produit seulement à l'acheteur d'origine.
2. BlueAnt remplacera ou réparera un produit défectueux à condition qu'il n'ait pas été utilisé à mauvais escient ou été mal exploité de quelque manière que ce soit.
3. Le produit ne contient aucune pièce à entretenir par l'utilisateur.  
Le recours à un réparateur non autorisé annulera la garantie.
4. La garantie est valable pour deux (2) ans (24 mois) à compter de la date d'achat.
  - Le service prévu par la garantie ne sera assuré que si la demande est accompagnée d'une preuve d'achat.
  - Pour que la garantie soit valide, l'oreillette doit être dans l'emballage d'origine portant le numéro de série.
5. La garantie est valable seulement à partir de la date d'achat et non de celle d'une réparation ou d'un remplacement quelconque.





### Avis de non-responsabilité :

Le présent guide est publié par BlueAnt. Les renseignements que renferme le présent guide sont sujets à modification sans préavis. Tous droits réservés. Le mot Bluetooth de même que la marque et les logos Bluetooth appartiennent à Bluetooth SIG, Inc. et sont exploités ici par BlueAnt sous licence. Toutes les autres marques de commerce et appellations commerciales mentionnées dans la présente restent la propriété des détenteurs respectifs.

## Veillez protéger vos oreilles.

**Mise en garde :** L'oreillette peut atteindre 101 décibels en volume maximum. L'utilisation prolongée à volume élevé risque de porter atteinte à votre capacité auditive. De même, l'utilisation de l'oreillette pendant de longues périodes peut entraîner la perte d'audition due au bruit. La perte d'audition peut se produire si l'oreillette est utilisée à des volumes maximums au-delà de 5 minutes par jour. La perte d'audition peut se produire si l'oreillette est utilisée à des volumes moyens pendant plus d'une heure par jour. L'exposition au son dans un champ rapproché peut provoquer la perte d'audition, même à des faibles volumes.



Par la présente [nom du fabricant] déclare que l'appareil [type d'appareil] est conforme aux exigences essentielles et aux autres dispositions pertinentes de la directive 1999/5/CE.

Download from [Www.Somanuals.com](http://Www.Somanuals.com). All Manuals Search And Download.





# BlueAnt®

# Z9i GUÍA DEL USUARIO

## Introducción

El auricular portátil mono BlueAnt Z9i con micrófono dual utiliza tecnología inalámbrica Bluetooth. Sus dos micrófonos, combinados con el software de Voice Isolation Technology™ de BlueAnt, ofrecen al BlueAnt Z9i una entrada clara y nítida del tono de la voz, y con ello, una comunicación de alta calidad. Galardonado con el prestigioso premio CES Design and Engineering, el BlueAnt Z9i representa la próxima generación de auriculares Bluetooth con reducción de ruido y cancelación de eco.

Hay dos configuraciones para aislamiento de voz: **STANDARD** y **MAX**.

El **aislamiento de voz Standard**, para uso en ambientes normales, elimina ruidos leves y ofrece un sonido natural de la voz.

El **aislamiento de voz Max** ofrece una claridad de voz superior en una gran variedad de zonas de alto ruido.



## Características del BlueAnt Z9i

- Ganador del premio CES 2007 Innovations Design & Engineering
- Dos micrófonos para voz
- Voice Isolation Technology™ Digital Signal Processor (DSP), el software revolucionario de BlueAnt
- Durante una llamada, los usuarios pueden cambiar entre dos modos de aislamiento de voz: Standard y Max
- Este DSP de calidad internacional brinda supresión de eco, reducción de ruido ambiental y de viento, lo cual separa la señal deseada de voz del ruido de fondo para permitir conversaciones cristalinas en medio de los ambientes más ruidosos.
- Cuenta con Multi-Point, que permite el emparejamiento con 2 teléfonos al mismo tiempo
- Notificación de conexión y reconexión automática
- Diferentes tonos de timbre para contactos conocidos y desconocidos
- Clip para corbata innovador que se sujeta a la camisa o al puño, cuando la unidad no está en uso
- Pequeño y liviano (sólo 1,5 pulgadas [3,8 cm] de longitud y pesa apenas 0,35 oz [10 g])
- Gancho para la oreja transparente y elegante
- Hasta 5,5 horas de tiempo de habla o 200 horas en inactividad
- 2 años de garantía de reemplazo
- Bluetooth v2.0

## ¿Qué es la tecnología inalámbrica Bluetooth?

Bluetooth es la tecnología de comunicación sin cables más avanzada en la actualidad. Permite comunicaciones inalámbricas sin dificultades entre equipos Bluetooth dentro de perímetros de hasta 10 m (30 pies) a la redonda.

## ¿Qué equipos son compatibles con el Z9i con micrófono dual?

Su auricular es un producto calificado para Bluetooth V2.0 y es compatible con ambos perfiles Bluetooth: Auricular (Headset) y Manos Libres (Handsfree). El Z9i puede almacenar información e interactuar de manera inalámbrica con hasta cinco equipos compatibles con Bluetooth V1.1, V1.2 o V2.0 (compatibilidad con versiones anteriores o posteriores), incluidos teléfonos celulares, PDA, PC/Mac o cualquier equipo con capacidad Bluetooth compatible con los perfiles Auricular (Headset) o Manos Libres (Handsfree). **Este manual se enfocará en cómo utilizar el auricular con un teléfono con capacidad Bluetooth.**

## ¿Qué contiene el paquete?

- > Un auricular BlueAnt Z9i Bluetooth con micrófono dual
- > 2 ganchos para la oreja
- > Auricular interno grande y pequeño
- > Cable USB
- > Adaptador de CA
- > Guía de inicio rápido
- > Manual del usuario
- > Tarjeta de Download

## Overview

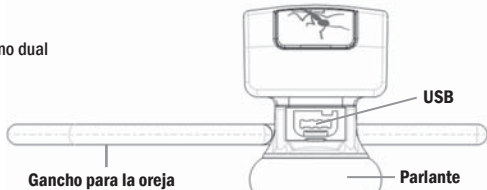
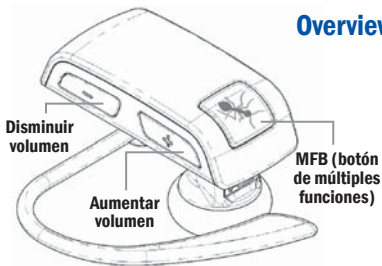



## Para comenzar

Antes de poder utilizar el auricular, se deberá hacer lo siguiente:

1. Cargar el auricular por completo utilizando uno de los cargadores suministrados.
2. Asociar el auricular con un equipo con capacidad Bluetooth; p. ej., teléfono celular, PDA, computador.

## Carga

El Z9i está acompañado de una batería integrada recargable. Esta se deberá cargar por completo antes de utilizar el Z9i por primera vez, este proceso tendrá un tiempo de duración de aproximadamente 120 a 150 minutos. Durante el proceso de carga, el indicador mostrará una luz roja constante. Cuando la batería esté cargada por completo, la luz roja se apagará. Mientras más tiempo se utilice el auricular para hablar, menor será el tiempo que la batería permanecerá cargada durante períodos de inactividad. Si el auricular no se utiliza durante un largo periodo, requerirá un mayor tiempo de carga.

## Cargar el Z9i a través de un conector USB

1. Conecte el cable de carga USB en el puerto USB de la PC/Mac.
2. Conecte el otro extremo del cable de carga USB en el puerto de carga del auricular. Asegúrese de que el conector USB coincida con el enchufe USB del auricular. No fuerce el conector en el enchufe; éste debería deslizarse con facilidad. El LED rojo se encenderá.
3. Cuando la carga esté completa, el LED rojo se apagará. Desconecte el adaptador de carga.

## Cargar el Z9i a través de un cargador de pared

1. Conecte el cargador de CA en el enchufe de la pared y el cable en el puerto de carga del Z9i. Asegúrese de que el conector USB coincida con el enchufe USB del auricular. No fuerce el conector en el enchufe; éste debería deslizarse con facilidad. El LED rojo se encenderá.
2. Cuando la carga esté completa, el LED rojo se apagará. Desconecte el adaptador de carga.

## Colocación del BlueAnt Z9i

Empuje el gancho hacia la oreja a través del orificio ubicado en el clip del auricular y gradúe su longitud para que se ajuste cómodamente sobre la oreja. Asegúrese de que el auricular apunte en dirección a la boca. Puede ponerse el Z9i en la oreja derecha o la izquierda.

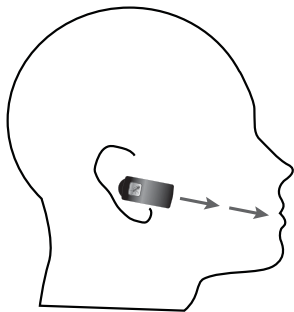
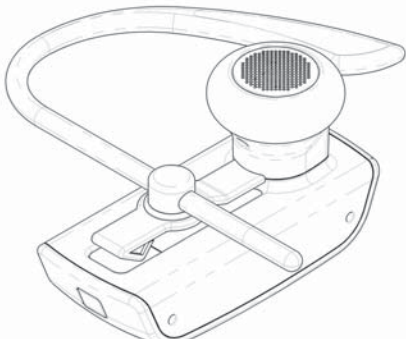

Para un funcionamiento óptimo, coloque el auricular Z9i en un ángulo tal que apunte en dirección a la boca.



## Intercambio de las almohadillas de gel

El Z9i se suministra con almohadillas de gel de dos tamaños.

La almohadilla de gel más grande ya viene colocada en la unidad.

Si desea usar la almohadilla de gel más pequeña, desenrosque (en el sentido contrario al de las agujas del reloj) el auricular interno grande y enrosque (en el sentido de las agujas del reloj) el más pequeño.

Desenrosque el auricular interno con cuidado y no apriete de forma excesiva la almohadilla de gel más pequeña cuando la coloque.

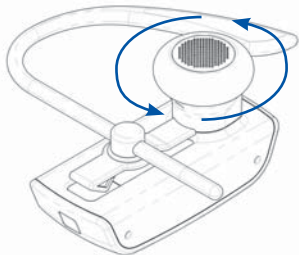

Desenrosque con cuidado en el sentido contrario al de las agujas del reloj para retirarla,

enrosque con cuidado en el sentido de las agujas del reloj para acoplarla.



## Asociar el auricular con otro equipo

Antes de utilizar el Z9i, deberá asociar el auricular con su teléfono celular. La asociación creará una conexión que se almacenará tanto en el Z9i como en el teléfono celular con capacidad Bluetooth. El proceso de asociación se deberá efectuar solamente una vez, la primera vez que se conecte el auricular a un teléfono nuevo. El Z9i puede almacenar asociaciones hasta con cinco (5) equipos Bluetooth diferentes. Si se desea asociar otro equipo después de haber asociado 5 equipos, se deberá REINICIAR (RESET) el Z9i siguiendo las instrucciones en la sección Funciones básicas del auricular.

## Proceso de asociación

El siguiente es simplemente un ejemplo y podría diferir con respecto a su teléfono, pero el proceso será el mismo.

1. Primero, apague el teléfono y préndalo nuevamente para actualizar la memoria.
2. Coloque el teléfono celular a unos 30 cm del Z9i con micrófono dual.
3. Ingrese al menú de Bluetooth en su teléfono celular. Active la capacidad Bluetooth (verifique en la guía del usuario de su teléfono celular si esto es necesario).
4. Con el Z9i apagado, oprima y mantenga oprimido el MFB  por unos 6 segundos. El LED se encenderá tomando un color azul, ésta luz será fija; se debe esperar a que la luz se vuelva intermitente, lo cual indicará que el Z9i se encuentra en la modalidad de Asociación listo para ser identificado por otros equipos Bluetooth. La modalidad Asociación permanecerá activa por 2 minutos.
5. Inicie el proceso de detección de equipos Bluetooth en su teléfono celular para agregar una nueva unidad. (El proceso tomará algunos segundos para detectar otros equipos Bluetooth en las cercanías.)
6. Cuando se detecte el equipo Bluetooth, la pantalla del teléfono mostrará "BlueAnt Z9i". Seleccione esta opción y oprima

Download from [Www.Somanuals.com](http://www.Somanuals.com). All Manuals Search And Download.

















OK para confirmar que desea asociar su teléfono con el Z9i.

7. Ingrese el código "0000" cuando el teléfono se lo pida. El teléfono y el Z9i se encuentran ahora asociados.
8. Puede que su teléfono requiera una configuración de seguridad adicional para permitir que el auricular y el teléfono se conecten automáticamente sin que se necesite confirmar cada vez que conecte el Z9i. Por lo general, esta configuración aparece como "set as authorized", "add to trusted devices", "allow connection" o algo similar en las opciones del BlueAnt Z9i.
9. De ser requerido la primera vez que se conecte, seleccione el BlueAnt Z9i para que se conecte a su teléfono. O bien, presione el MFB  en el Z9i para conectarse al teléfono.



## Funciones básicas del auricular

Para referencia rápida, véase también la Tabla de botones/funciones y la Guía de inicio rápido.

1. **Encendido:** Mantenga oprimido el MFB  por 3 segundos. El LED se iluminará azul. Si la batería tiene suficiente carga, ésta permanecerá iluminada por 5 segundos, de lo contrario, el LED cambiará a color rojo indicando así que la batería está baja. Después de ser encendido, el auricular se conectará automáticamente al último teléfono utilizado que se encuentre en alcance operacional. Si todavía no se ha asociado un teléfono, el Z9i ingresará en modalidad Asociación. Si no hay un teléfono en alcance operacional, el Z9i ingresará en modalidad Reposo.
2. **Apagado:** Oprima y mantenga oprimido el MFB  por 3 segundos. El LED rojo tomará intermitente durante unos segundos.
3. **Ingresar en modalidad Asociación:** Con el Z9i apagado, oprima y mantenga oprimido el MFB  por unos 6 segundos hasta que el LED se ilumine azul intermitente. El Z9i permanecerá en modalidad de Asociación por 2 minutos para luego pasar a modalidad Inactiva. Si desea ingresar nuevamente a la modalidad de Asociación, repita este paso.

4. **Efectuar una llamada:** Marque el número como lo hace normalmente en su teléfono. El audio se transferirá automáticamente al auricular.
5. **Para responder o Terminar una llamada:** Oprima el MFB  una vez cuando entre una llamada. Oprima y mantenga oprimido el MFB  por 3 segundos para terminar la llamada.
6. **Rehusar\*: una llamada:** Oprima y mantenga oprimido el MFB  por 3 segundos cuando entre una llamada.
7. **Marcar de nuevo\*:** Para marcar de nuevo la última llamada, oprima y mantenga oprimido el botón  del Volumen por unos 3 segundos. Para cancelar Marcar de nuevo, oprima el MFB .
8. **Activar Marcado por voz\*:** Mientras se encuentre conectado a un teléfono, oprima el MFB  una vez. Los comandos de voz deben haber sido grabados con anterioridad en el teléfono (véase la guía del usuario del teléfono).
9. **Nivel de volumen:** Oprima el botón  o  del Volumen durante una llamada para ajustar el nivel deseado.
10. **Desconectar / Transferir:** Para desconectar el Z9i del teléfono actualmente conectado o para transferir la llamada actual nuevamente al teléfono, oprima simultáneamente los botones  y  del Volumen una vez. Esto también transferirá la llamada activa al teléfono.
11. **Reconectar:** Para reconectar su teléfono se puede utilizar cualquiera de los siguientes pasos: Encienda el Z9i; oprima el MFB  on el Z9i encendido; o también, puede utilizar el menú de su teléfono Bluetooth.
12. **Activar/Desactivar el micrófono:** Oprima y mantenga oprimido el botón  del Volumen por 3 segundos durante una llamada.



- 13. Llamada en espera\*:** Si entra una llamada en medio de una llamada existente (el tono de notificación varía según el proveedor de servicio), oprima y mantenga oprimidos simultáneamente los botones ⊕ y ⊖ del Volumen por tres segundos. La llamada actual se pondrá en espera y se podrá atender la llamada entrante. Para regresar a la llamada en espera, oprima y mantenga oprimidos simultáneamente los botones ⊕ y ⊖ del Volumen por tres segundos.
- 14. Conferencia telefónica\*:** Para agregar una llamada retenida a una conversación existente, oprima y mantenga oprimido el botón de MFB  por 3 segundos.
- 15. Activar/Desactivar los indicadores de LED:** (para conducción nocturna): Cuando el auricular esté en modalidad Reposo o Inactiva, oprima y mantenga oprimidos simultáneamente los botones ⊕ y ⊖ del Volumen por tres segundos. Después de apagar y volver a encender el auricular, los indicadores de LED se activarán nuevamente de manera automática. Note que los LED se encuentran apagados durante una llamada activa.
- 16. Reiniciar el Z9i:** Si ya se han asociado 5 equipos con el Z9i, no será posible asociar otro ya que la memoria se encuentra llena. Si desea asociar el Z9i con otro teléfono, deberá reiniciar el auricular.  
Para reiniciar el Z9i a la configuración de fábrica: en la modalidad Reposo (no conectado a ningún equipo), oprima simultáneamente los botones ⊕ y ⊖ del Volumen y MFB  (3 botones). El Z9i actualizará la memoria, borrará todos los archivos de asociación e ingresará automáticamente en modalidad Asociación (el LED se iluminará intermitentemente en azul), listo para asociarse con un nuevo equipo.

\* Para utilizar estas funciones, su teléfono/equipo debe ser compatible con el perfil Manos Libres de Bluetooth.

El perfil Manos Libres de Bluetooth no activará estas funciones del BlueAnt Z9i.

## Voice Isolation Technology™ de BlueAnt

Se puede cambiar entre las dos configuraciones para aislamiento de voz: **STANDARD** y **MAX**.

**Aislamiento de voz Standard** - Para uso en ambientes normales cotidianos. Brinda un sonido natural de voz por medio de la eliminación de ruido leve.

**Aislamiento de voz Max** - Brinda una calidad más clara de voz en una amplia variedad de áreas con altos niveles de ruido.

### ¿CÓMO SE HACE PARA CAMBIAR?

Para cambiar entre Standard y Max: Oprima el MFB  durante la llamada

- Durante el cambio entre Standard y Max escuchará una confirmación auditiva a través del parlante del Z9i.
- El auricular estará en configuración Standard al encenderse por primera vez.
- Después de apagar y volver a encender el auricular, el auricular regresará a la configuración Standard de manera automática.
- Ambas configuraciones, Standard y Max, consumen la misma cantidad de energía de la batería.

## Cuadro de indicadores de LED

Encendido	Azul permanente durante 5 segundos
Apagado	Rojo se enciende intermitente 3 veces
Modalidad Asociación	Iluminación intermitente azul
Reiniciar	Iluminación intermitente azul
Carga	Rojo permanente

Carga con el equipo encendido	Rojo permanente con iluminación intermitente en violeta
Carga completa	Apagado indicador rojo
Batería baja	Todos los indicadores de LED cambian a rojo
Reposo	Iluminación intermitente en azul cada 8 segundos
Inactivo (Stand-by)	2 iluminaciones intermitentes en azul cada 5 segundos
Llamada en curso	Indicadores de LED apagados

Download from [www.Somanuals.com](http://www.Somanuals.com) All Manuals Search And Download.



## Tabla de botones/Funciones

Función del Z9i	Botón	Tiempo	Estado
Encendido	MFB	3 segundos	Desde apagado
Apagado	MFB	3 segundos	Inactivo/en espera
Entrar en modo de emparejamiento	MFB	6 segundos	Desde apagado
Responder llamada	MFB	Clic	Sonando
Finalizar llamada	MFB	Clic	Llamada activa
Rechazar llamada	MFB	1 segundo	Sonando
Volver a marcar último número	Vol	3 segundos	En espera
Activación de marcación por voz	MFB	Clic	En espera
Ajustar aislamiento de voz entre Estándar y Máximo	MFB	1 segundo	Llamada activa
Aumentar volumen	Vol	Clic	Llamada activa
Reducir volumen	Vol	Clic	Llamada activa
Silencio	Vol	3 segundos	Llamada activa

**Modalidad Inactiva** significa que está conectado a un equipo pero no en una llamada.

**Modalidad Reposo** significa que el Z9i está encendido pero que no está conectado a ningún equipo

**Presionar botones** significa oprimir a la vez

### Funciones avanzadas del Z9

Función del Z9i	Botón	Tiempo	Estado
Desconectar/ transferir	&	Clic	Conectado
Multi-Point - Colocar teléfono 1 en espera y recibir teléfono 2	Vol	3 segundos	Activo
Multi-Point - Finalizar teléfono 2 y volver a teléfono 1	MFB	Clic	Activo
Multi-Point - Finalizar teléfono 1 y recibir teléfono 2	Vol	3 segundos	Activo
Conferencia telefónica - Sólo teléfono activo	MFB	3 segundos	Llamada activa
Llamada en espera - Sólo teléfono activo	&	3 segundos	Llamada activa
Encender/apagar LEDs	&	3 segundos	Inactivo/en espera
Restablecer dispositivo	MFB  &  &	Clic	Inactivo





## Funciones avanzadas del auricular

### Emparejamiento del auricular con varios dispositivos Bluetooth

El Z9i puede conectarse a 2 teléfonos de forma simultánea pero puede emparejarse con un máximo de hasta 5 dispositivos.

1. Asegúrese de que en el último teléfono utilizado Bluetooth esté desactivado o se encuentre fuera del radio de alcance.
2. Siga el procedimiento que se describe en la sección “Procedimiento de emparejamiento” anterior con cada dispositivo que desee emparejar.

**Multi-Point** Con Multi-Point puede conectar dos teléfonos al Z9i y responder el que suene.

1. **Conectar:** Cuando se encienda, el Z9i se conectará a los dos últimos teléfonos conectados. Si desea conectar otro teléfono previamente emparejado, hágalo desde el menú de Bluetooth de ese teléfono. A partir de ese momento, el Z9i siempre se conectará a dicho teléfono.
2. **Responder:** Al recibir una llamada entrante en cualquiera de los teléfonos, sólo tiene que hacer clic en el MFB  para responder a la llamada.
3. **Responder a una segunda llamada:** Coloque el teléfono 1 en espera y reciba el teléfono 2; para ello, mantenga pulsado Vol  durante 3 segundos.
4. **Finalizar la segunda llamada:** Para finalizar el teléfono 2, vuelva al teléfono 1 en espera y haga clic en el MFB .
5. **Responder teléfono 2 y colgar teléfono 1:** Para finalizar el teléfono 1 y responder el teléfono 2, mantenga pulsado Vol  durante 3 segundos.

Nota: Con la función de rellamada sólo se marcará el primer teléfono conectado.

### Actualización del *firmware*

Se puede actualizar el *firmware* del BlueAnt Z9i a través del puerto USB con el cable USB suministrado. Véase la sección de asistencia técnica en [www.blueantwireless.com](http://www.blueantwireless.com) para obtener información y descargar de cualquier actualización disponible.

Download from [www.Softmanuals.com](http://www.Softmanuals.com). All Manuals Search And Download.



## Información adicional

### Configuración de perfil del teléfono (diferente de perfiles Bluetooth)

En su teléfono, configure un perfil con volúmenes de repique y tonos de teclado apropiados. Selecciónelo y actívelo cuando utilice el Z9i. Algunos teléfonos pueden activar automáticamente el perfil deseado cuando se los conecta a un accesorio vehicular o auricular. Ejemplo: vaya a Configuraciones especiales (*Enhancement Settings*) y seleccione un perfil predeterminado para que se active cuando se conecte el auricular. En algunos teléfonos es posible ajustar los niveles para adecuarlos al uso personal (véase el manual del usuario de su teléfono para instrucciones acerca de cómo utilizar y activar los diferentes perfiles). Los perfiles más comunes son *General*, *Exteriores*, *Reunión*, *Silencioso*, *Manos Libre*, *Auricular*, *Manos Libres portátil* y *Accesorio vehicular*.

### Software para teléfono/PDA/computador

Asegúrese de tener la última actualización del *firmware* para su teléfono, especialmente si utiliza un teléfono PDA. Vaya a la sección de asistencia técnica en la página web del fabricante para verificar que tenga la última versión. Muchos de los nuevos teléfonos celulares, PDA y teléfonos por computador necesitan un paquete de actualización de Bluetooth para mejorar la funcionalidad Bluetooth con respecto a la última versión disponible.

### Reiniciar el teléfono/PDA

Los teléfonos y PDA pueden a menudo presentar problemas de memoria que pueden causar problemas de reconexión con Bluetooth. Para solucionar esto, basta con apagar el equipo y encenderlo nuevamente. El teléfono se reiniciará y la memoria activa quedará actualizada en limpio. Reiniciar el teléfono semanalmente puede ayudar a mantener su funcionalidad en orden, incluida la funcionalidad Bluetooth.

### Solución de problemas y documentos de respaldo

Véase la sección de asistencia técnica de [www.blueantwireless.com](http://www.blueantwireless.com) para solución de problemas y preguntas frecuentes (FAQ), además de información sobre uso de computadores con aplicaciones de VOIP.

Download from [Www.Somanuals.com](http://Www.Somanuals.com). All Manuals Search And Download.



## Especificaciones

<b>Especificaciones generales</b>	<ul style="list-style-type: none"> <li>&gt; Bluetooth v2.0</li> <li>&gt; Hasta 10 metros de cobertura RF</li> <li>&gt; De conformidad con CE, FCC, BQB, RoHS / WEEE</li> <li>&gt; Perfil de auricular, Perfil de Manos Libres v1.0</li> </ul>
<b>Especificaciones RF</b>	<ul style="list-style-type: none"> <li>&gt; Frecuencia de transmisión 2,402 ~ 2,480 GHz</li> <li>&gt; &lt; 0,1% BER a -80 dBm</li> <li>&gt; 0 ± 4 dBm (Clase 2)</li> </ul>
<b>Interfaz del usuario</b>	<ul style="list-style-type: none"> <li>&gt; LED color azul para indicación de funcionamiento</li> <li>&gt; LED color rojo para indicación de batería baja</li> <li>&gt; Mini USB para cargar la batería o actualización de firmware</li> </ul>
<b>Audio</b>	3GPP con solución DSP
<b>Tipo de batería</b>	Batería de litio-polímero de 3,7 V
<b>Tiempo de habla</b>	Hasta 5,5 horas
<b>Tiempo de inactividad (Stand-by)</b>	200 horas
<b>Peso</b>	10 g sin gancho para la oreja; 11 g con gancho para la oreja
<b>Dimensiones (mm)</b>	1,5 x 0,69 x 0,44 (inches) / 41 x 17,5 x 11,2 (mm)

Download from [www.Somanuals.com](http://www.Somanuals.com). All Manuals Search And Download.



## Ayuda

### Proceso de garantía de BlueAnt

1. En caso de experimentar dificultades de funcionamiento, consulte las preguntas frecuentes (FAQ) y los documentos de respaldo en línea; si lo desea puede llamarnos a nuestro número telefónico que se encuentra en la contraportada de este manual
2. Consulte nuestra página web ([www.blueantwireless.com](http://www.blueantwireless.com)) para obtener más información, manuales actualizados y ayuda para la resolución de problemas.
3. Llámenos para hablar con un representante del equipo de atención al cliente de BlueAnt Wireless  
Le indicaremos si su problema es de hardware o de conexión.
4. Si se determina que su unidad está defectuosa, se le emitirá una Autorización de devolución de mercadería (RMA).
5. Devuelva la unidad directamente a BlueAnt para evaluación y reemplazo de los elementos defectuosos.

### Términos y condiciones de la garantía

1. BlueAnt ofrece garantía solamente al comprador original de este producto.
2. BlueAnt reemplazará o reparará cualquier producto defectuoso siempre y cuando éste no haya sido usado descuidadamente o abusado de alguna manera.
3. Este producto no cuenta con ningún elemento que pueda ser reparado por el usuario.  
El uso de servicios de reparación no autorizados anulará la garantía.
4. La garantía es válida por 2 años (24 meses) a partir de la fecha de compra.
  - Se deberá suministrar comprobante de compra para obtener el servicio de garantía.
  - El auricular deberá estar en el paquete original con su número de serie correspondiente para que la garantía sea válida.
5. Las garantías tienen efecto a partir de la fecha del comprobante de compra y no a partir de la fecha de cualquier reparación o reemplazo.



## Limitaciones:

Este manual fue publicado por BlueAnt. La información contenida en este documento está sujeta a cambio sin previo aviso. Todos los derechos reservados. La palabra Bluetooth, marca y logotipos son propiedad de Bluetooth SIG, Inc. Todo uso de tales marcas por parte de BlueAnt se encuentra bajo licencia. Las otras marcas registradas y nombres comerciales pertenecen a sus respectivos dueños.

## Protéjase los oídos.

**Advertencia:** Este auricular puede alcanzar un volumen máximo de 101 decibeles. El uso prolongado del auricular a volúmenes altos puede afectar su capacidad auditiva. El uso por períodos extensos puede ocasionar la pérdida de la audición inducida por el ruido (NIHL). La pérdida de la audición puede producirse si el auricular se utiliza a volúmenes máximos por más de 5 minutos al día, o si el auricular se utiliza a volúmenes intermedios por más de 1 hora al día. La exposición a sonidos provenientes de fuentes emisoras tan cercanas al oído puede ocasionar pérdida de la audición, incluso a niveles bajos.



Por medio de la presente [nombre del fabricante] declara que el [clase de equipo] cumple con los requisitos esenciales y cualesquiera otras disposiciones aplicables o exigibles de la Directiva 1999/5/CE.

Download from [Www.Somanuals.com](http://Www.Somanuals.com). All Manuals Search And Download.



## Contact BlueAnt:

### Nth America

customercare@myblueant.com  
1 866 891-3032

### Australia

customercare@blueant.com.au  
1300 669 049

### New Zealand

customercare@blueant.com.au  
0800 443 122



BlueAnt®

[www.blueantwireless.com](http://www.blueantwireless.com)

## Free Manuals Download Website

<http://myh66.com>

<http://usermanuals.us>

<http://www.somanuals.com>

<http://www.4manuals.cc>

<http://www.manual-lib.com>

<http://www.404manual.com>

<http://www.luxmanual.com>

<http://aubethermostatmanual.com>

Golf course search by state

<http://golfingnear.com>

Email search by domain

<http://emailbydomain.com>

Auto manuals search

<http://auto.somanuals.com>

TV manuals search

<http://tv.somanuals.com>