



Intrusion Alarm Systems

Databook EMEA 12/2008



BOSCH

Invented for life



Control Panels, Control Centers, and Keypads	1
Accessories for Control Panels and Keypads	2
Software	3
Arming Devices	4
Detectors and Accessories	5
LSN Peripherals	6
Conettix - Information Transport Solutions	7
Wireless Local Security Network (wLSN)	8
DSRF Premises Wireless	9
Signaling Devices	10

Control Panels, Control Centers, and Keypads

Easy Series	2
Easy Series Intrusion Control Panel	2
IUI-EZ1 Oval Control Center	9
ICP-EZM2-EU Intrusion Control Panel	10
ICP-EZM2-UK Intrusion Control Panel	10
ICP-EZM2-LC Intrusion Control Panel	11
ITS-300GSM Communicator	12
ICP-EZPS-FRA AFNOR Power Supply	14
ICP-EZPS Wire-in Power Supply	15
ICP-EZPK Programming Key	15
Easy Series Voice Modules	16
Solution Series	20
CC408 Solution 880 Control Panel	20
CC488 Solution Ultima 880 Control Panel	22
CC880 Solution 16 Control Panel	24
VR8 Desktop Alarm System	27
CP500ALW Area Addressable LCD Codepad	29
CP500AW Area Addressable LED Codepad	30
CP500PW Partitionable LED Codepad	31
CP508W LED Codepad	32
CP516LW LCD Codepad	33
CP516W LED Codepad	34
DS7080i	35
DS7080iP32 Eight-zone Control Panels	35
7000 Line	38
DS7220V2 Control Panel	38
DS7240V2 Control Panel	42
DS7400Xi Series Addressable Control Panels	46
DS7446KP Series LCD Keypads	49
DS7447V2 Series LCD Keypads	51
DS7447E Series LCD Keypads	53
DS7445V2 Series LED Keypads	55
DS7445i Series LED Keypads	57
UEZ 2000	59
UEZ 2000/1 LSN, UEZ 2000 LSN, Intrusion Control Centers	59
NZ 300	63
NZ 300 LSN Hold-up and Intrusion Control Panel	63
BE 300 LSN remote operating unit	66

Accessories for Control Panels and Keypads

Expansion Modules	68
DX2010 Series Input Expander	68
DX3010 Series Octo-output Expander	69
DS7430 Multiplex Expansion Module	70
DS7432 Series Eight-input Remote Modules	71
DS7433 Series Eight-input Modules	73
DS7436 Multiplex Expansion Module	74
DS7457i Series Single Zone Input Modules	75
DS7457iE Single Zone Input Module	77
DS7460i Dual-zone Input Module	78
DS7465i Input-Output Module	80

Interface Modules	82
Conettix DX4020 Ethernet Network Interface Module	82
Conettix C900V2 Dialer Capture Ethernet Module	84
DX4010i RS-232 Serial Interface Module	87
DS7420i Dual Phoneline/Bell Supervision Module	89
Door Access Control Modules	91
Door Access Control Module (DACM)	91
IUI-CARD/DACM Proximity Cards	93
IUI-FOB/DACM Proximity Key Fobs	94
IUI-CABLE/DACM Cable	94
IUI-CNTRL/DACM Controller	95
IUI-DTU/DACM Data Transfer Unit (DTU)	95
IUI-READER/DACM Proximity Reader	96
IUI-READKP/DACM Proximity Reader with Keypad	96
IUI-SWCD/DACM PC Software	97
Enclosures	98
AE1 Standard Enclosure (Gray)	98
AE3 Large Enclosure (Gray)	98
AE20 Universal Plastic Enclosure	99
D203 Enclosure	99
Power Supplies and Batteries	100
Battery 12 V / 10 Ah	100
Battery 12 V / 17 Ah	101
Battery 12 V / 24 Ah	102
Battery 12 V / 65 Ah	103
D1222 Battery (12 V, 2.2 Ah)	104
D1250 Battery (12 V, 5 Ah)	105
D126 Standby Battery (12 V, 7 Ah)	106
ICP-EZPS Wire-in Power Supply	107
ICP-EZPS-FRA AFNOR Power Supply	107
NEV 300 LSN power supply	108
Cables, Switches, and Programmers	110
ICP-EZPK Programming Key	110
CC808 Direct Link Cable	110
Control Center and Keypad Accessories	111
IUI-EZT-5 Easy Series Token Package	111

Software	113
Programming Software	114
Remote Programming Software International	114
WDSRP Remote Programming	
Software for Windows	116

Arming Devices	119
Conventional	120
SE 50 GLT SmartKey Blocking Unit	120
SE 100 GLT SmartKey Arming Device	122
LSN	124
SE 60 LSNi SmartKey Blocking Unit	124
SE 120 LSNi SmartKey Arming Device	126
SE 220 LSNi SmartKey Arming Device	128
SE 320 LSNi SmartKey Arming Device	131

Detectors and Accessories	135	DS484Q and DS486Q Quad-Beam Photoelectric Detectors	228
Motion PIR	136	Holdup	230
ISC-PPR1-W16 Professional Series PIR Detector	136	ND 100 GLT Panic Button	230
ISC-PPR1-WA16x Professional Series PIR Detectors with Anti-mask	139	Smoke	231
ISM-BLP1 Blue Line PIR Detector	142	F220 Photoelectric Smoke Detectors	231
ISM-BLP1-P Blue Line Pet-Friendly PIR Detector	145	F220 Heat Detectors	234
ISM-BLQ1 Blue Line Quad PIR Detector	148	F220-B6 Series Conventional Detector Bases	236
DS306E PIR Detector	151	F220-B6RS 24 VDC Four-wire Detector Base with Sounder	238
DS308EA Quad PIR Detector with Anti-mask	153	Magnetic Contacts Recessed Mount	240
MX775i Multiplex PIR Intrusion Detector	156	ISN-CSTB-10 Compact Contacts (9.5 mm)	240
MX934i Multiplex PIR Intrusion Detector	159	ISN-CSTB-10DM Contacts with Thin Magnet (9.5 mm)	241
DS304 PIR Detector with Replaceable Mirrors	162	ISN-CSTB-TC Terminal Connection Contacts (16 mm)	242
Motion PIR/Microwave	164	ISN-CTC75 Terminal Connection Contacts (19 mm)	244
ISC-PDL1-W18x Professional Series TriTech Detectors	164	ISN-CTAP-10 Contacts (9.5 mm)	245
ISC-PDL1-WA18x Professional Series TriTech+ Detectors with Anti-mask	168	ISN-CTAP-15 Contacts (6.35 mm)	247
ISM-BLD1 Blue Line TriTech Detectors	172	ISN-CRFM-25 Oval Flange Contacts (6.35 mm)	248
ISM-BLD1-P Blue Line Pet Friendly TriTech Detectors	174	ISN-CMINI-10 Miniature Contacts (9.5 mm)	249
DS825 and DS840 Series TriTech PIR Detectors	177	ISN-CMINI-10D Miniature Contacts with Thin Magnet (9.5 mm)	250
DS860 Series TriTech PIR/Microwave Detector	180	ISN-CMINI-15 Miniature Contacts (6.35 mm)	251
Motion Outdoor	183	ISN-C22 Compact Ball Reed Contacts	252
OD850 Series Outdoor TriTech Detectors	183	ISN-CPB52 Reed Plunger Contacts	253
Motion Ceiling Mount	186	ISN-CAS Adjustable Screw Head Contacts	255
DS936 Low Profile Panoramic PIR Detector	186	ISN-CRB32 Roller Ball Contacts	256
DS937 Panoramic Detector	188	ISN-CSD70 and ISN-CSD80 Compact Contacts	257
DS938Z and ZX938Z Series Panoramic PIR Detectors	190	EMK 46 S Z Flush-Mount Magnetic Contact	259
DS939 Panoramic Detector	192	EMK 46 Z Built-in magnetic contact	261
DS9360 Panoramic TriTech Detector	194	MS-LZ Flush-Mount Magnetic Contact	262
DS9370 Series Panoramic TriTech Detector	196	MS-LZS Flush-Mount Magnetic Contact	263
DS9371 Panoramic TriTech Detector	198	ADM 2000 Spring-loaded mechanism	264
MX938i Multiplex Intrusion Detector	200	ADB Spring-loaded bolts for wooden windows	265
Motion Long Range	202	Magnetic Contacts Surface Mount	266
DS720i Long Range TriTech PIR Detector (10.525 GHz)	202	ISN-CMICRO Ultra Miniature Contacts	266
DS778 Long Range PIR Detector	205	ISN-C50 Terminal Connection Contacts with Cover	267
DS794Z and ZX794Z Series Long Range PIR Detectors	207	ISN-C60 Slim Terminal Connection Contacts	268
MX794i Long Range Multiplex PIR Detector	209	ISN-CSM35 Standard and Wide Gap Contacts	269
Request-to-Exit	211	ISN-CSM20-WG Commercial Contacts	270
DS150i Series Request-to-exit Detectors	211	ISN-CSS-40 Super Stick Contacts with Side Leads	271
DS160 Series High Performance Request-to-exit Detectors	213	ISN-C45 Miniature Super Stick Contacts with Side Leads	272
Glass Break	216	ISN-CFM-102 Flange Mount Contacts with Side Leads	273
DS1100i Series Glassbreak Detectors	216	ISN-CFM-106 Flange Mount Contacts with Center Leads	274
DS1109i Glassbreak Detector	218	ISN-CMET-4418 Overhead Door Contact	275
Seismic	220	ISN-CMET-200AR Commercial Metal Contact	276
ISN-SM Seismic Detectors	220	ISN-C66 Track Mounted Overhead Door Contact	277
Photoelectric Beam	223	EMK 46 AT Z Surface-Mount Magnetic Contact	278
DS415i and DS435i Single Beam Photoelectric Detectors	223	MK 48 SZ surface-mount magnetic contact	280
DS422i and DS426i Dual-Beam Photoelectric Detectors	225	MSA-LZ Surface-Mount Magnetic Contact	282
DS453Q and DS455Q Quad Beam Photoelectric Detectors	226	MSA-LZS Surface-Mount Magnetic Contact	283
		AMK 4 Z Overhead door contact	284
		AMK 4 S Z Shutter Door Contact	285
		Accessories	286
		ISM-BLA1-CC Blue Line Color Camera Modules	286
		ISM-BLA1-LM Blue Line Nightlight Module	288

ISM-BLA1-SM Blue Line Sounder Module	290	NVK 100 LSN Coupler	374
B328 Gimbal-mount Bracket	291	IC 400 LSN Universal Expander	377
Swiveling B335-3 low-profile mount	292	KD 55/1 LSN 2 Zone Expander Modules	379
B800 Ceiling-mount Bracket	292	LSN Display Panels	381
DS1110i Glassbreak Tester	293	BAT 100 LSN Display Panel	381
MP1 Metal Pole, 1 m (3 ft)	293	LSN Power Supplies	383
MP2 Metal Pole, 1.2 m (4 ft)	294	NEV 300 LSN power supply	383
MP3 L-Curved Metal Pole	294		
OA120-2 Mirror	295		
OLR92-3 Long-range Lens	295		
OMB77-3 Barrier Mirror	296		
OMLR77-3 Long-range Mirror	296		
OMLR93-3 Long-range Mirror	297		
PC1A Weather Enclosure	297		
PEH-2 Heater	298		
TP160 Trim Plate	299		
TP161 Trim Plate	299		
LSN Peripherals	301	Conettix - Information Transport Solutions	385
LSN Motion PIR/Microwave	302	Conettix - Receiver/Gateway	386
ISP-PPR1-WA16x Professional Series LSN PIR Detectors with Anti-mask	302	Conettix D6600 Communications Receiver/Gateway	386
ISP-PDL1-WA18x Professional Series LSN TriTech + Detectors with Anti-mask	306	Conettix D6100 Communications Receiver/Gateway	391
DS 935 LSN Infrared Motion Detector	310	Conettix D6100i Communications Receiver/Gateway	395
DS840LSN TriTech PIR/MW Dual Motion Detector	312	Conettix - Receiver/Gateway Accessories	399
IR 200 LSN Infrared Motion Detector	314	D6600 CD ROM	399
IR 270 T LSNi Infrared Motion Detector, Antimask	317	Conettix D6200CD CD-ROM	399
UP 370 T LSN Matchtec Detector, Antimask	320	Conettix D6641 Telephone Line Card	400
		Conettix D6645 Telephone Line Terminator Card	400
LSN Seismic	322	Conettix D6672 Com 1 Expansion Kit	401
GM 570 LSN Seismic Detector	322	Conettix D6680 Ethernet Network Adapter	402
		Conettix D6610 CPU Line Card	403
LSN Glassbreak	325	Conettix D6615 CPU Terminator Card	404
GBS 2036 LSN Passive Glass Break Detector	325	P6601 Battery Cable	404
		P6602 Input and Output Cable	405
LSN Smoke	327	P6603 Acknowledgement Button	405
MAGIC.SENS Automatic LSN Fire Detectors	327	Conettix D6100 Rack Mount Kit	406
MAGIC.SENS Detector Base Sounders	331	Conettix GSM	407
FAP-520 Automatic Fire Detectors LSN improved version	334	ITS-300GSM Communicator	407
FAP-420/FAH-420 Automatic Fire Detectors LSN improved version	339	Conettix IP	409
		Conettix D6680 Ethernet Network Adapter	409
LSN Magnetic Contacts	343	Conettix D6201 Series IP Security Keys	411
EMK 36 LSN Built-in Magnetic Contact	343	Conettix C900V2 Dialer Capture Ethernet Module	412
EMK 36 AT LSN Surface-Mount Magnetic Contact	345	Conettix DX4020 Ethernet Network Interface Module	415
EMK 36 S LSN Built-In Magnetic Contact	347	Conettix - AT2000/ATE	417
MK 36 S LSN Surface-Mount Magnetic Contact	349	AT 2000 Analog Transmission System	417
MSE-LSN B Built-In Magnetic Contact	351	AT 2000 ISDN Transmission System	419
MSA-LSN B Surface-Mount Magnetic Contact	353	AT 2000 TSN ISDN Transmission System	421
MSE-LSN C Built-In Magnetic Contact	355	AT 2000 IP ISDN Transmission System	424
MSA-LSN C Surface-Mount Magnetic Contact	357	ATE TSN ISDN Alarm Receiver	427
AMK 4 LSN Shutter Door Contact	359		
AMK 4 S LSN Shutter Door Contact	361		
SKA 100 LSN Bolt Contact	363		
SKI 100 LSN Bolt Contact	365		
LSN Holdup	366	Wireless Local Security Network (wLSN)	429
ND 200 LSN Panic Button	366	wLSN Peripherie	430
		wLSN Hub	430
LSN Expansion Modules	367	wLSN Relay Module	432
IPB-IF100 LSN 16 Zone Expander Module	367	wLSN Siren (Indoor)	434
NAK 100 LSN Branch Interface	369	wLSN Door-Window Contact	436
NNK 110 LSN Emergency Call Coupler	371	wLSN Smoke Detector for Europe	438
		wLSN Glassbreak Detector	440
		wLSN Inertia Sensor	442
		wLSN Dual Motion Detectors	444

wLSN PIR Motion Detector	447
wLSN Key Fob	450
wLSN Mini Door-Window Contact	452
wLSN Recessed Door-Window Contact	454
wLSN Water Sensor/Low-temperature Sensor	456
wLSN Accessories	458
wLSN Installation Tool	458

DSRF Premises Wireless 461

Bosch DSRF Receivers	462
RF3212 Series RF Receivers	462
RF3222E RF Receiver (433.42 MHz)	464
RF3227E RF Receiver (433.42 MHz)	466
Bosch DSRF Transmitters	468
RF280THS Series Wireless Photoelectric Smoke Detectors	468
RF835 Series Wireless TriTech Detectors	470
RF940E Wireless PIR Detector	473
RF1100E Glassbreak Transmitter	475
RF3332 Series Key Fobs	477
RF3334 Series Key Fobs	479
RF3401 Series RF Point Transmitters	481
RF3405E Wireless (RF) Inertia Transmitter	483
RF3501LE Panic Transmitter (433.42 MHz)	485
RF3503E Panic-Medical Fob	487

Signaling Devices 489

Signaling Devices	490
BES External Signaling Device, Audio/Visual	490
BL 200 Strobes	492

Control Panels, Control Centers, and Keypads

1

Easy Series	2
Solution Series	20
DS7080i	35
7000 Line	38
UEZ 2000	59
NZ 300	63

1 Easy Series Intrusion Control Panel



Features

- ▶ Supports up to 32 total input points (hard-wired, wireless, or combination)
- ▶ Advanced false alarm reduction
- ▶ Integrated proximity reader
- ▶ Speaks language of choice
- ▶ wireless Local SecurityNetwork (wLSN) support
- ▶ Remote Programming Software (RPS) support
- ▶ Simple icon-based control center
- ▶ Integrated digital dialer, voice dialer, text messaging, and two-way audio verification

Designed for residential and small commercial applications, the Easy Series Intrusion Control Panel requires minimal training and support and is easy to install, configure, and test. The control center speaks while showing animated icons, so that the user quickly understands the information and tasks.

Optional wireless Local SecurityNetwork (wLSN) support is available in Europe. wLSN provides two-way wireless communication using the 868 MHz security band, easy installation, automatic configuration, and a variety of wireless devices.

Note wLSN support is available only in Easy Series Intrusion Control Panels, Release 2 (ICP-EZM2) or later.

System Overview

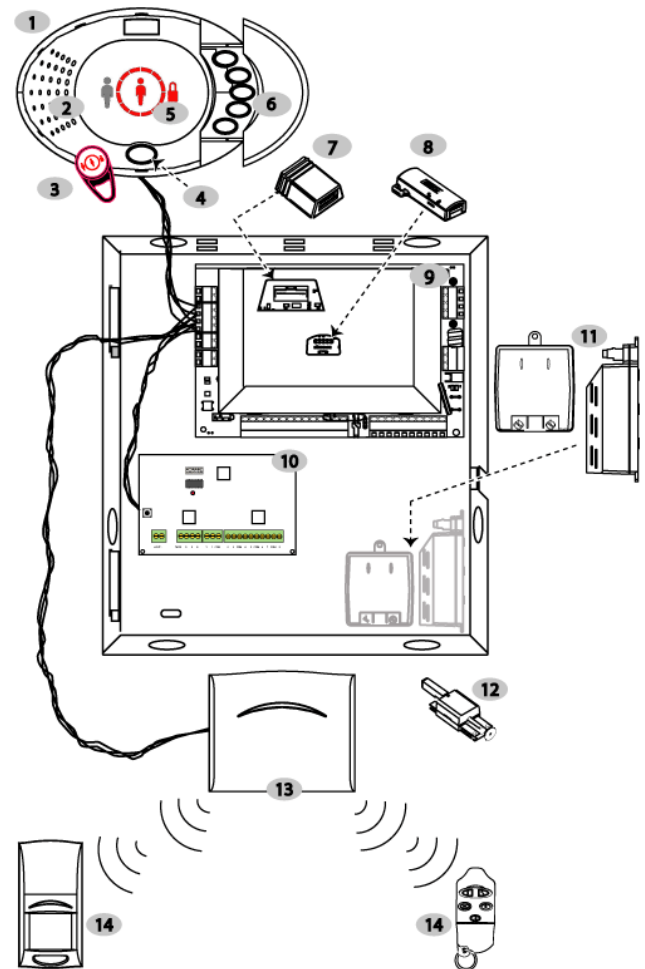

1. Control Center
2. Sensor and Audio Components
3. Radio Frequency Identification (RFID) Reader and Token
4. Information Button
5. Icon Indicators
6. Function Buttons
7. Voice Module
8. Programming Key
9. Easy Series Intrusion Control Panel
10. DX2010 Input Expander Module
11. Power Supplies
The Easy Series Intrusion Control Panel can use a wired-in power supply or transformer, according to regional primary voltage input requirements.
12. Optional Dual Tamper Switch
13. Optional wireless Local SecurityNetwork (wLSN) Hub
14. Optional wLSN Devices

Terminal Blocks

Easy Series terminal blocks are color-coded to clearly show where to connect the power supply, telephone line, control center, and assorted devices such as smoke detectors or motion detectors. Each input and output has a dedicated pair of terminals, making installing and wiring the system easier to understand and execute.

Functions

Advanced False Alarm Reduction

The Easy Series Intrusion Control Panel system guards against user-generated false alarms through design features such as Graduated Annunciation and Intelligent Threat Assessment. Easy Series uses enhanced false alarm verification methods that exceed industry false alarm reduction standards.

Graduated Annunciation

The system gradually increases the control center volume, changes the animation of the control center display, and incrementally pulses the warning devices. The control center notifies users when the system is preparing to send an alarm and provides options to cancel reports, reducing false alarms.

Alarm Verification

The following alarm verification methods reduce false alarms without compromising usability or reliability.

1. **Two-way Audio Verification:** Provides remote customers the ability to listen to and speak with users at the protected premises.
2. **Sequential Verification:** When two or more input sensors activate within a specified time period, an intrusion alarm is considered verified. For example, if a door sensor and a motion detector both sense alarms, the system sends a verified alarm report.
3. **Intelligent Threat Assessment:** The Easy Series Intrusion Control Panel uses protection levels, input types, input conditions, and system event timing to assess a potential threat. If the threat reaches a specific threshold, the system sends a verified alarm report.

Easy Series Intrusion Control Panel Configuration

Users can configure the Easy Series Intrusion Control Panel with the necessary regional parameters for a specific country without changing hardware. Installers can configure the system using their language of choice and then set the system to the appropriate language for the user. Installers can remotely program the system using a telephone or Remote Programming Software (RPS). A voice prompted installer mode reduces service and installation costs while ensuring accurate programming.

Remote Programming Software (RPS)

RPS is a separate software package that allows computers equipped with the Microsoft Windows operating system and a modem to act as a remote programming, record storage, remote control, and troubleshooting tool for specific control panels.

Certifications and Approvals

Region	Certification	
Europe	CE	1999/5/EC, 2006/95/EC, 2004/108/EC; EN 55022:2006 + A1:2007, Class B; EN 50130-4 w/A1:1998 + A2:2003; EN61000-3-2:2006; EN61000-3-3:1995; EN 60950-1:2001; TBR21:1998
Belgium	INCERT	B-509-0044/b
USA	UL	AMCX: Central Station Alarm Units (UL1610, UL1635), AMCX7: Central Station Alarm Units Certified for Canada (cULus), AMTB: Control Panels, SIA False Alarm Reduction, AOTX: Local Alarm Units (UL464, UL609), AOTX7: Local Alarm Units Certified for Canada (cULus), APAAW: Police Station Alarm Units (UL365, UL464), APAAW7: Police Station Alarm Units Certified for Canada (cULus), APOU: Proprietary Alarm Units (UL1076), APOU7: Proprietary Alarm Units Certified for Canada (cULus), NBSX: Household Burglar Alarm System Units (UL1023), NBSX7: Household Burglar Alarm System Units Certified for Canada (cULus), UTOU: Control Units and Accessories - Household System Type (UL985), UTOU7: Control Units and Accessories - Household System Type Certified for Canada (cULus)
	CSFM	7167-1615: 223 July 2008
Canada	IC	1249A-EZM1
Sweden	INTYG	Nr08-423 Centralapparat Nr08-424 Centralapparat-trådlös

Compliance with specific standards, such as SIACP-01 and DD243, reduces false alarms and is required in many locations. In addition to the certifications and approvals listed above, the Easy Series Intrusion Control Panel is designed to comply with the following certifications, approvals, and standards:

EN50131-1 Grade 2

DD243

PD6662

CCC

FCC

A-Tick

C-Tick

TBR21 for PSTN

Japan Approvals Institute for Telecommunications Equipment (JATE)

Installation/Configuration Notes

Compatibility Information

PSTN Communicator (Integrated)	Formats: BSIA Fast Format, Contact ID, SIA, (Voice Dialer) Personal Messaging: SMS Text and Voice
IP Communicator ^{1,3}	Conetrix IP C900V2 Dialer Capture Module
GSM Communicator ^{1,3}	Conetrix ITS-300GSM Communicator
Radio Communicators (SAFECOM) ^{1,2}	SC2104 Series Slave Communicators SC3100 Series Data Transfer Radio Communicators SC4000 Series Full Data Transfer Radio Communicator
Magnetic Contacts ¹	All Bosch magnetic contacts, including recessed, terminal connection, miniature, overhead door, and surface mount.
Intrusion Detectors ¹	All conventional Bosch intrusion detectors, including Blue Line, seismic, PIR, TriTech, photoelectric, and TriTech PIR Microwave.
Two-wire and Four-wire Smoke Detectors ^{1,3}	Conventional Bosch 12 V smoke, heat, and photoelectric smoke detectors.
Hardwire Expansion Module	DX2010 Input Expander
Interface Module ^{1,2}	D132A Smoke Detector Reversing Relay
wireless Local SecurityNetwork (wLSN) Devices ¹	All Bosch wLSN devices, including the wLSN Hub (wireless expansion module), wLSN PIR and dual technology motion detectors, wLSN glass break detectors, wLSN key fobs, wLSN inertia sensors, wLSN door and window contacts, wLSN relay outputs, and wLSN sirens.

¹Assorted literature is available. Refer to the appropriate data sheet, brochure, installation guide, or user guide for additional details.

²Only sold in specific countries. Does not comply with CE.

³Availability varies according to sales regions.

Technical Specifications

Dimensions

Control Center:	12 cm x 17.7 cm x 2.5 cm (4.7 in. x 7 in. x 1 in.)
AE1 Enclosure:	37 cm x 31.75 cm x 8.5 cm (14.5 in. x 12.5 in. x 3.4 in.)

Environmental Considerations

Relative Humidity:	93% ±5% at 32°C ±2°C (+90°F ±2°F)
Temperature (Operating):	-10°C to +49°C (+14°F to +120°F)
Temperature (Storage):	-10°C to +55°C (+14°F to +130°F)

Environmental Class II

Input Points

Maximum Number of Input Points: 32

Hardwire, Wireless, or Combination Input Points:	Eight on-board <ul style="list-style-type: none"> • Hard-wire single, zone-doubling, dual end-of-line (EOL) tamper, or wireless. • Input 1 also supports two-wire smoke detectors, all input points support four-wire detectors. • Enclosure tamper input (does not reduce input point capacity).
--------------------------------------------------	------------------------------------------------------------------------------------------------------------------------------------------------------------------------------------------------------------------------------------------------------------------------------------------------------------------------------------

Hardwire Expansion Input Points:	Up to 24 with three DX2010 Input Expander Modules (32 total). Each DX2010 provides eight additional input points. The Easy Series Intrusion Control Panel supports up to three modules.
----------------------------------	--------------------------------------------------------------------------------------------------------------------------------------------------------------------------------------------

Wireless Expansion Input Points:	Up to 32 with the wLSN Hub
----------------------------------	----------------------------

Outputs

On-board:	Four <ul style="list-style-type: none"> • Configurable solid state • Internal siren driver option for speakers (output 4 only)
-----------	--------------------------------------------------------------------------------------------------------------------------------------------------------

Wireless:	Four
-----------	------

Number of...

Control Centers:	Four <ul style="list-style-type: none"> • Audible voice prompts included • Accepts passcodes, token, or the wLSN key fob for user arming and disarming
------------------	--------------------------------------------------------------------------------------------------------------------------------------------------------------------------------

DX2010 Expansion Modules:	Three on the Option Bus
---------------------------	-------------------------

wLSN Hubs:	One on the Option Bus
------------	-----------------------

Users:	Up to 20 (20 passcodes, 20 tokens, and 20 wLSN key fobs)
--------	----------------------------------------------------------

Events:	500 history events, stamped with time and date
---------	------------------------------------------------

Power Requirements

Primary Voltage Source:	110 V, +10% or -15% (47 Hz to 62 Hz) 230 V, +10% or -15% (47 Hz to 62 Hz)
-------------------------	------------------------------------------------------------------------------

Primary Voltage Input (AC):	18 V (47 Hz to 62 Hz)
-----------------------------	-----------------------

Primary Voltage Input (DC):	18 V non-polarized
-----------------------------	--------------------

Secondary Voltage Input (DC):	12 VDC, 7 Ah or 18 Ah sealed lead acid rechargeable battery
-------------------------------	-------------------------------------------------------------

Total Power:	1.4 A
--------------	-------

Auxiliary Power:	1.0 A
------------------	-------

Easy Series Kit Ordering Information Europe, Middle East, and Africa

Kits include one control panel, enclosure, tamper switch, oval control center, wire-in power supply (100 V to 250 V), and two RFID tokens unless noted otherwise.

Language	Commercial Type Numbers	
	Kit	Voice Module
None ¹	ICP-EZUAWT-00 ²	None ¹
None ¹	ICP-EZ2AWT-00	None ¹
English	ICP-EZ2AWT-01	ICP-EZV2-ENF

Easy Series Kit Ordering Information Europe, Middle East, and Africa

British English	ICP-EZ2AWT-02	ICP-EZV2-ENUKF
German	ICP-EZ2AWT-03	ICP-EZV2-DEF
Dutch	ICP-EZ2AWT-04	ICP-EZV2-NLF
Hungarian	ICP-EZ2AWT-05	ICP-EZV2-HUF
Czech	ICP-EZ2AWT-06	ICP-EZV2-CSF
Polish	ICP-EZ2AWT-07	ICP-EZV2-PLF
Italian	ICP-EZ2AWT-08	ICP-EZV2-ITF
Spanish	ICP-EZ2AWT-09	ICP-EZV2-ESF
Swedish	ICP-EZ2AWT-10	ICP-EZV2-SVF
French	ICP-EZ2AWT-11	ICP-EZV2-FRF
Portuguese	ICP-EZ2AWT-12	ICP-EZV2-PTF
Russian	ICP-EZ2AWT-14	ICP-EZV2-RUF
Greek	ICP-EZ2AWT-15	ICP-EZV2-ELF
Norwegian	ICP-EZ2AWT-16	ICP-EZV2-NOF
Danish	ICP-EZ2AWT-17	ICP-EZV2-DAF
Finnish	ICP-EZ2AWT-18	ICP-EZV2-FIF
Turkish	ICP-EZ2AWT-19	ICP-EZV2-TRF
Arabic	ICP-EZ2AWT-21	ICP-EZV2-ARF
Bulgarian	ICP-EZ2AWT-22	ICP-EZV2-BGF
Croatian	ICP-EZ2AWT-25	ICP-EZV2-HRF
Flemish	ICP-EZ2AWT-27	ICP-EZV2-NLBEF
Romanian	ICP-EZ2AWT-29	ICP-EZV2-ROF
Slovak	ICP-EZ2AWT-30	ICP-EZV2-SKF
Slovenian	ICP-EZ2AWT-31	ICP-EZV2-SLF
Serbian	ICP-EZ2AWT-32	ICP-EZV2-SRF

¹Requires a separately purchased voice module for operation.

²This kit is suitable for use in the UK and includes a wire-in power supply (230 V).

wLSN Kit 1 Ordering Information Europe, Middle East, and Africa

wLSN kits include the indicated Easy Series Kit plus one wLSN Hub, one wLSN PIR Motion Detector, one wLSN Mini Door/Window Contact, and one wLSN Keyfob.

Language	Commercial Type Numbers	
	wLSN Kit 1	Easy Series Kit
English	ICP-EW1AWT-01	ICP-EZ2AWT-01
British English	ICP-EW1AWT-02	ICP-EZ2AWT-02
Dutch	ICP-EW1AWT-04	ICP-EZ2AWT-04
Hungarian	ICP-EW1AWT-05	ICP-EZ2AWT-05
Polish	ICP-EW1AWT-07	ICP-EZ2AWT-07
Italian	ICP-EW1AWT-08	ICP-EZ2AWT-08
Spanish	ICP-EW1AWT-09	ICP-EZ2AWT-09
Swedish	ICP-EW1AWT-10	ICP-EZ2AWT-10
Portuguese	ICP-EW1AWT-12	ICP-EZ2AWT-12
Russian	ICP-EW1AWT-14	ICP-EZ2AWT-14
Greek	ICP-EW1AWT-15	ICP-EZ2AWT-15
Danish	ICP-EW1AWT-17	ICP-EZ2AWT-17

wLSN Kit 1 Ordering Information Europe, Middle East, and Africa

Turkish	ICP-EW1AWT-19	ICP-EZ2AWT-19
Arabic	ICP-EW1AWT-21	ICP-EZ2AWT-21
Romanian	ICP-EW1AWT-29	ICP-EZ2AWT-29

wLSN Kit 2 Ordering Information Europe, Middle East, and Africa

wLSN kits include the indicated Easy Series Kit plus one wLSN Hub, one wLSN Dual Motion Detector, one wLSN Mini Door/Window Contact, and one wLSN Keyfob.

Language	Commercial Type Numbers	
	wLSN Kit 2	Easy Series Kit
Dutch	ICP-EW2AWT-04	ICP-EZ2AWT-04
Greek	ICP-EW2AWT-15	ICP-EZ2AWT-15

wLSN Kit 3 Ordering Information Europe, Middle East, and Africa

wLSN kits include the indicated Easy Series Kit plus one wLSN Hub, one wLSN PIR Motion Detector, one wLSN Smoke Detector, one wLSN Mini Door/Window Contact, and one wLSN Keyfob.

Language	Commercial Type Numbers	
	wLSN Kit 3	Easy Series Kit
German	ICP-EW3AWT-03	ICP-EZ2AWT-03
Finnish	ICP-EW3AWT-18	ICP-EZ2AWT-18

wLSN Kit 4 Ordering Information Europe, Middle East, and Africa

wLSN kits include the indicated Easy Series Kit plus one wLSN Hub, two wLSN PIR Motion Detectors, one wLSN Mini Door/Window Contact, and one wLSN Keyfob.

Language	Commercial Type Numbers	
	wLSN Kit 4	Easy Series Kit
French	ICP-EW4AWT-11	ICP-EZ2AWT-11

Easy Series Kit Ordering Information Asia Pacific, Central and South America

Kits include one control panel, enclosure, oval control center, wire-in power supply (100 V to 250 V), and two RFID tokens unless noted otherwise.

Language	Commercial Type Numbers	
	Kit	Voice Module
None ¹	ICP-EZ2AWU-00	None ¹
None ²	ICP-EZ0AVU-00	None ²
English	ICP-EZ2AWU-01	ICP-EZV2-ENF
Mandarin	ICP-EZ2AWU-13	ICP-EZV2-ZHF
Japanese	ICP-EZ2AWU-20	ICP-EZV2-JAF
Australian	ICP-EZ2AWU-23	ICP-EZV2-ENAU
Spanish	ICP-EZ2AWU-24	ICP-EZV2-ESLXF
Cantonese	ICP-EZ2AWU-26	ICP-EZV2-ZHHKF
Portuguese	ICP-EZ2AWU-28	ICP-EZV2-PTBRF
Thai	ICP-EZ2AWU-33	ICP-EZV2-THF
Korean	ICP-EZ2AWU-34	ICP-EZV2-KOF

¹Requires a separately purchased voice module for operation.

²Requires a separately purchased voice module, power supply, and enclosure for operation.

Easy Series Kit Ordering Information United States

Kits include one control panel, enclosure, oval control center, plug-in power supply (110 V for US), and two RFID tokens unless noted otherwise.

Language	Commercial Type Numbers	
	Kit	Voice Module
None ¹	ICP-EZ2AXU-00	None ¹
English	ICP-EZ2AXU-01	ICP-EZV2-ENF
Spanish	ICP-EZ2AXU-24	ICP-EZV2-ESLXF
Korean	ICP-EZ2AXU-34	ICP-EZV2-KOF

¹Requires a separately purchased voice module for operation.

Easy Series Kit Ordering Information Canada

Kits include one control panel, enclosure, oval control center, plug-in power supply (110 V for Canada), and two RFID tokens unless noted otherwise.

Language	Commercial Type Numbers	
	Kit	Voice Module
None ¹	ICP-EZ2AYU-00	None ¹
English	ICP-EZ2AYU-01	ICP-EZV2-ENF
French	ICP-EZ2AYU-11	ICP-EZV2-FRF

¹Requires a separately purchased voice module for operation.

Ordering Information

ICP-EZ2AWT-01

English Easy Series Kit with Tamper Switch
Appropriate for use in Europe, the Middle East, and Africa.

One control panel with English female voice module, tamper switch, wire-in power supply, enclosure, oval control center, and two tokens.

ICP-EZ2AWT-01

ICP-EZ2AWT-02

British Easy Series Kit with Tamper Switch
Appropriate for use in Europe, the Middle East, and Africa.

One control panel with British English female voice module, tamper switch, wire-in power supply, enclosure, oval control center, and two tokens.

ICP-EZ2AWT-02

ICP-EZ2AWT-03

German Easy Series Kit with Tamper Switch
Appropriate for use in Europe, the Middle East, and Africa.

One control panel with German female voice module, tamper switch, wire-in power supply, enclosure, oval control center, and two tokens.

ICP-EZ2AWT-03

ICP-EZ2AWT-04

Dutch Easy Series Kit with Tamper Switch
Appropriate for use in Europe, the Middle East, and Africa.

One control panel with Dutch female voice module, tamper switch, wire-in power supply, enclosure, oval control center, and two tokens.

ICP-EZ2AWT-04

ICP-EZ2AWT-05

Hungarian Easy Series Kit with Tamper Switch

Appropriate for use in Europe, the Middle East, and Africa.

One control panel with Hungarian female voice module, tamper switch, wire-in power supply, enclosure, oval control center, and two tokens.

ICP-EZ2AWT-05

ICP-EZ2AWT-06

Czech Easy Series Kit with Tamper Switch
Appropriate for use in Europe, the Middle East, and Africa.

One control panel with Czechoslovakian female voice module, tamper switch, wire-in power supply, enclosure, oval control center, and two tokens.

ICP-EZ2AWT-06

ICP-EZ2AWT-07

Polish Easy Series Kit with Tamper Switch
Appropriate for use in Europe, the Middle East, and Africa.

One control panel with Polish female voice module, tamper switch, wire-in power supply, enclosure, oval control center, and two tokens.

ICP-EZ2AWT-07

ICP-EZ2AWT-08

Italian Easy Series Kit with Tamper Switch
Appropriate for use in Europe, the Middle East, and Africa.

One control panel with Italian female voice module, tamper switch, wire-in power supply, enclosure, oval control center, and two tokens.

ICP-EZ2AWT-08

Ordering Information		Ordering Information	
ICP-EZ2AWT-09 Spanish [European] Easy Series Kit with Tamper Switch Appropriate for use in Europe, the Middle East, and Africa. One control panel with Spanish [European] female voice module, tamper switch, wire-in power supply, enclosure, oval control center, and two tokens.	ICP-EZ2AWT-09	ICP-EZ2AWT-18 Finnish Easy Series Kit with Tamper Switch Appropriate for use in Europe, the Middle East, and Africa. One control panel with Finnish female voice module, tamper switch, wire-in power supply, enclosure, oval control center, and two tokens.	ICP-EZ2AWT-18
ICP-EZ2AWT-10 Swedish Easy Series Kit with Tamper Switch Appropriate for use in Europe, the Middle East, and Africa. One control panel with Swedish female voice module, tamper switch, wire-in power supply, enclosure, oval control center, and two tokens.	ICP-EZ2AWT-10	ICP-EZ2AWT-19 Turkish Easy Series Kit with Tamper Switch Appropriate for use in Europe, the Middle East, and Africa. One control panel with Turkish female voice module, tamper switch, wire-in power supply, enclosure, oval control center, and two tokens.	ICP-EZ2AWT-19
ICP-EZ2AWT-11 French Easy Series Kit with Tamper Switch Appropriate for use in Europe, the Middle East, and Africa. One control panel with French female voice module, tamper switch, wire-in power supply, enclosure, oval control center, and two tokens.	ICP-EZ2AWT-11	ICP-EZ2AWT-21 Arabic Easy Series Kit with Tamper Switch Appropriate for use in Europe, the Middle East, and Africa. One control panel with Arabic female voice module, tamper switch, wire-in power supply, enclosure, oval control center, and two tokens.	ICP-EZ2AWT-21
ICP-EZ2AWT-12 Portuguese [European] Easy Series Kit with Tamper Switch Appropriate for use in Europe, the Middle East, and Africa. One control panel with Portuguese [European] female voice module, tamper switch, wire-in power supply, enclosure, oval control center, and two tokens.	ICP-EZ2AWT-12	ICP-EZ2AWT-22 Bulgarian Easy Series Kit with Tamper Switch Appropriate for use in Europe, the Middle East, and Africa. One control panel with Bulgarian female voice module, tamper switch, wire-in power supply, enclosure, oval control center, and two tokens.	ICP-EZ2AWT-22
ICP-EZ2AWT-14 Russian Easy Series Kit with Tamper Switch Appropriate for use in Europe, the Middle East, and Africa. One control panel with Russian female voice module, tamper switch, wire-in power supply, enclosure, oval control center, and two tokens.	ICP-EZ2AWT-14	ICP-EZ2AWT-25 Croatian Easy Series Kit with Tamper Switch Appropriate for use in Europe, the Middle East, and Africa. One control panel with Croatian female voice module, tamper switch, wire-in power supply, enclosure, oval control center, and two tokens.	ICP-EZ2AWT-25
ICP-EZ2AWT-15 Greek Easy Series Kit with Tamper Switch Appropriate for use in Europe, the Middle East, and Africa. One control panel with Greek female voice module, tamper switch, wire-in power supply, enclosure, oval control center, and two tokens.	ICP-EZ2AWT-15	ICP-EZ2AWT-27 Flemish Easy Series Kit with Tamper Switch Appropriate for use in Europe, the Middle East, and Africa. One control panel with Flemish female voice module, tamper switch, wire-in power supply, enclosure, oval control center, and two tokens.	ICP-EZ2AWT-27
ICP-EZ2AWT-16 Norwegian Easy Series Kit with Tamper Switch Appropriate for use in Europe, the Middle East, and Africa. One control panel with Norwegian female voice module, tamper switch, wire-in power supply, enclosure, oval control center, and two tokens.	ICP-EZ2AWT-16	ICP-EZ2AWT-29 Romanian Easy Series Kit with Tamper Switch Appropriate for use in Europe, the Middle East, and Africa. One control panel with Romanian female voice module, tamper switch, wire-in power supply, enclosure, oval control center, and two tokens.	ICP-EZ2AWT-29
ICP-EZ2AWT-17 Danish Easy Series Kit with Tamper Switch Appropriate for use in Europe, the Middle East, and Africa. One control panel with Danish female voice module, tamper switch, wire-in power supply, enclosure, oval control center, and two tokens.	ICP-EZ2AWT-17	ICP-EZ2AWT-30 Slovak Easy Series Kit with Tamper Switch Appropriate for use in Europe, the Middle East, and Africa. One control panel with Slovak female voice module, tamper switch, wire-in power supply, enclosure, oval control center, and two tokens.	ICP-EZ2AWT-30

Ordering Information**ICP-EZ2AWT-31 ICP-EZ2AWT-31****Slovenian Easy Series Kit with Tamper Switch**

Appropriate for use in Europe, the Middle East, and Africa.

One control panel with Slovenian female voice module, tamper switch, wire-in power supply, enclosure, oval control center, and two tokens.

ICP-EZ2AWT-32 ICP-EZ2AWT-32**Serbian Easy Series Kit with Tamper Switch**

Appropriate for use in Europe, the Middle East, and Africa.

One control panel with Serbian female voice module, tamper switch, wire-in power supply, enclosure, oval control center, and two tokens.

ICP-EZUAWT-00 ICP-EZUAWT-00**Easy Series Kit with Tamper Switch for UK**

Appropriate for use in the United Kingdom. One control panel with tamper switch, wire-in power supply, ICP-EZM2-UK enclosure, oval control center, and two tokens. Requires a separately purchased voice module for operation.

Accessories**ICP-EZPK Programming Key ICP-EZPK**

Blue key for transferring information to and from Easy Series Intrusion Control Panels.

ICP-EZPS Wire-in Power Supply ICP-EZPS

For use in Europe, the Middle East, Asia Pacific, Central and South America. 100 VAC to 240 VAC primary voltage input (AC).

ICP-EZPS-FRA AFNOR Power Supply ICP-EZPS-FRA

For use in France. Provides 14 VDC and isolated auxiliary power outputs.

IUI-EZT-5 Easy Series Token Package IUI-EZT-5

Five Easy Series proximity tokens.

DX2010 Input Expander DX2010

Provides hard-wired expansion for an additional eight input points. Includes the DX2010 board.

wLSN Hub (Czech) ISW-BHB1-WXCS

Serves as the link between the wireless Local SecurityNetwork (wLSN) devices and the control panel

wLSN Hub (German) ISW-BHB1-WXDE

Serves as the link between the wireless Local SecurityNetwork (wLSN) devices and the control panel

wLSN Hub (Danish) ISW-BHB1-WXDA

Serves as the link between the wireless Local SecurityNetwork (wLSN) devices and the control panel

wLSN Hub (English) ISW-BHB1-WXEN

Serves as the link between the wireless Local SecurityNetwork (wLSN) devices and the control panel

wLSN Hub (Spanish) ISW-BHB1-WXES

Serves as the link between the wireless Local SecurityNetwork (wLSN) devices and the control panel

Ordering Information**wLSN Hub (Finnish) ISW-BHB1-WXFI**

Serves as the link between the wireless Local SecurityNetwork (wLSN) devices and the control panel

wLSN Hub (French) ISW-BHB1-WXFR

Serves as the link between the wireless Local SecurityNetwork (wLSN) devices and the control panel

wLSN Hub (Greek) ISW-BHB1-WXEL

Serves as the link between the wireless Local SecurityNetwork (wLSN) devices and the control panel

wLSN Hub (Hungarian) ISW-BHB1-WXHU

Serves as the link between the wireless Local SecurityNetwork (wLSN) devices and the control panel

wLSN Hub (Italian) ISW-BHB1-WXIT

Serves as the link between the wireless Local SecurityNetwork (wLSN) devices and the control panel

wLSN Hub (Dutch) ISW-BHB1-WXNL

Serves as the link between the wireless Local SecurityNetwork (wLSN) devices and the control panel

wLSN Hub (Norwegian) ISW-BHB1-WXNO

Serves as the link between the wireless Local SecurityNetwork (wLSN) devices and the control panel

wLSN Hub (Polish) ISW-BHB1-WXPL

Serves as the link between the wireless Local SecurityNetwork (wLSN) devices and the control panel

wLSN Hub (Portuguese) ISW-BHB1-WXPT

Serves as the link between the wireless Local SecurityNetwork (wLSN) devices and the control panel

wLSN Hub (Russian) ISW-BHB1-WXRU

Serves as the link between the wireless Local SecurityNetwork (wLSN) devices and the control panel

wLSN Hub (Swedish) ISW-BHB1-WXSV

Serves as the link between the wireless Local SecurityNetwork (wLSN) devices and the control panel

IUI-EZ1 Oval Control Center



The user interface for the Easy Series Intrusion Control Panel. It speaks in your local language while showing animated, color-coded icons on the screen to reinforce the spoken words. It includes a speaker and a microphone; the speaker projects tones and speaks instructions, you use the microphone to speak with monitoring facility personnel. For core functions (protection level, silence, reset), you can either use a proximity token or use keys to type in a PIN. Use the function buttons to control volume; control chime mode; add, delete, or change users; and sends alarms for fire, police, or medical personnel.

Includes a bubble level tool to help you quickly and accurately position the control center during installation.

Certifications and Approvals

Region	Certification	
Europe	CE	1999/5/EC, 2006/95/EC, 2004/108/EC; EN 55022:2006 + A1:2007, Class B; EN 50130-4 w/A1:1998 + A2:2003; EN61000-3-2:2006; EN61000-3-3:1995; EN 60950-1:2001; TBR21:1998
Russia	GOST	12997-84, 60065-2002, 50009-2000, 51317.3.2-99, and 51317.3.3-99

Region	Certification	
USA	UL	AMCX: Central Station Alarm Units (UL1610, UL1635), AMCX7: Central Station Alarm Units Certified for Canada (cULus), AMTB: Control Panels, SIA False Alarm Reduction, AOTX: Local Alarm Units (UL464, UL609), AOTX7: Local Alarm Units Certified for Canada (cULus), APAW: Police Station Alarm Units (UL365, UL464), APAW7: Police Station Alarm Units Certified for Canada (cULus), APOU: Proprietary Alarm Units (UL1076), APOU7: Proprietary Alarm Units Certified for Canada (cULus), NBSX: Household Burglar Alarm System Units (UL1023), NBSX7: Household Burglar Alarm System Units Certified for Canada (cULus), UTOU: Control Units and Accessories - Household System Type (UL985), UTOU7: Control Units and Accessories - Household System Type Certified for Canada (cULus)
	CSFM	7167-1615:223

Ordering Information

IUI-EZ1 Oval Control Center	IUI-EZ1
Oval control center that includes a speaker, microphone, function buttons, and a bubble level.	

Accessories

IUI-EZ1-FM Flush Mount Kit	IUI-EZ1-FM
Flush mount kit for IUI-EZ1 Control Center.	

ICP-EZM2-EU Intrusion Control Panel



Certifications and Approvals

Region	Certification	
Europe	CE	1999/5/EC, 2006/95/EC, 2004/108/EC; EN 55022:2006 + A1:2007, Class B; EN 50130-4 w/A1:1998 + A2:2003; EN61000-3-2:2006; EN61000-3-3:1995; EN 60950-1:2001; TBR21:1998
Sweden	INTYG	Centralapparat - trådlös: Nr08-424 Centralapparat: Nr08-423

Ordering Information

ICP-EZM2-EU Intrusion Control Panel

One control panel with AE1 Standard Enclosure, assorted hardware, and two tokens.

ICP-EZM2-EU

ICP-EZM2-UK Intrusion Control Panel



Certifications and Approvals

Region	Certification	
Europe	CE	1999/5/EC, 2006/95/EC, 2004/108/EC; EN 55022:2006 + A1:2007, Class B; EN 50130-4 w/A1:1998 + A2:2003; EN61000-3-2:2006; EN61000-3-3:1995; EN 60950-1:2001; TBR21:1998

Ordering Information

ICP-EZM2-UK Intrusion Control Panel

One control panel with UK Enclosure, transformer, assorted hardware, and two tokens.

ICP-EZM2-UK

ICP-EZM2-LC Intrusion Control Panel

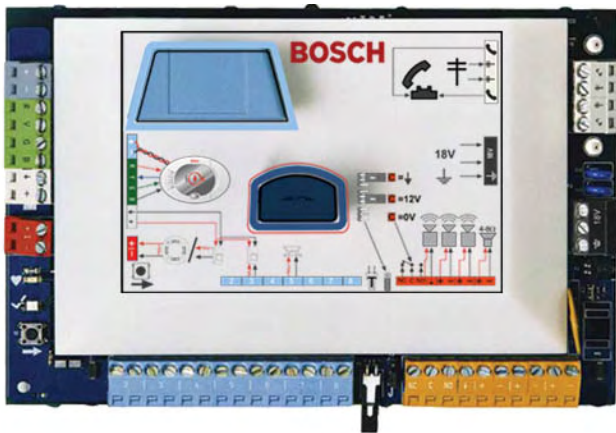

Certifications and Approvals

Region	Certification
Europe	CE 1999/5/EC, 2006/95/EC, 2004/108/EC; EN 55022:2006 + A1:2007, Class B; EN 50130-4 w/A1:1998 + A2:2003; EN61000-3-2:2006; EN61000-3-3:1995; EN 60950-1:2001; TBR21:1998

Ordering Information

ICP-EZM2-LC Intrusion Control Panel **ICP-EZM2-LC**
One control panel printed circuit board without an enclosure.

ITS-300GSM Communicator



Features

- ▶ **Monitoring of the telephone line statically and dynamically**
- ▶ **Backup path transmission via the GSM network in the event of a fault in the telephone line**
- ▶ **Calls from house phone via the GSM network are possible**
- ▶ **Transmission of own events via the GSM network**
- ▶ **Local programming and remote programming**

The ITS-300GSM is used to automatically transmit control panel reports via the analog telephone network with backup transmission via the GSM network.

It is compatible with control panels from various manufacturers with integrated communicator for the analog telephone network.

System Overview

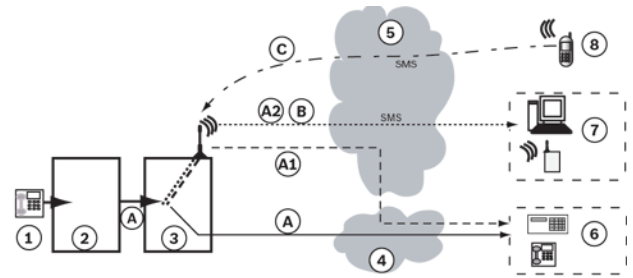

- (1) House phone
- (2) Control panel
- (3) ITS-300GSM
- (4) Analog telephone network
- (5) GSM mobile network
- (6) Telephone network receiver
- (7) SMS receiver
- (8) Cell phone
- (A) Outgoing calls and reports
- (A1) Transparent transmission
- (A2) SMS transmission
- (B) ITS-300GSM messages
- (C) Remote programming

Functions

Outgoing calls and reports are transmitted via the analog telephone network as standard. The ITS-300GSM monitors the telephone line statically and dynamically and switches to GSM transmission under certain conditions.

Static monitoring

The voltage of the telephone line is checked regularly. If the voltage is too low, the ITS-300GSM switches to GSM transmission and activates the fault relay. This allows the control panel to transmit the fault message via the GSM network, if necessary.

Dynamic monitoring

Dynamic monitoring is activated during report transmission. The switch to GSM transmission occurs if manipulation of the telephone line is detected or after three unsuccessful redial attempts from the control panel. After successful transmission, the ITS-300GSM reverts to the telephone line.

Backup path transmission

Backup path transmission via the GSM network is carried out either transparently or as an SMS message. In the event of transparent transmission, sent tones are transmitted transparently in the voice channel to the phone number dialed by the control panel. For SMS transmission, the contact ID report is sent to an SMS receiver in the form of an SMS message.

Calls from house phone

If the analog telephone network fails, calls from the house phone can be allowed or disallowed via the GSM network in accordance with the programming.

Transmission of own events

If necessary, the device can transmit test calls and fault/restoration of telephone line as an SMS message.

Programming

Programming is carried out with a cell phone via entries on the SIM card. In transparent transmission, no programming is necessary for standard applications. Remote programming is possible with a cell phone via SMS messages.

Display

The device has an LED display for device status, GSM field strength and active GSM transmission.

Voltage range	10 to 14 V DC
Dimensions	12.5 x 7 cm

Ordering Information**ITS-300GSM Communicator**

For backup transmission from a control panel's telephone dialer over the GSM network, if telephone line transmission is not working. Transmits reports and voice. Compatible with control panels from different manufacturers.

ITS-300GSM**Certifications and Approvals**

Region	Certification
Europe	CE

Country	Approval	ITS-300GSM Communicator

Installation/Configuration Notes

There must be sufficient GSM field strength at the antenna location. The ITS-300GSM supports SIM cards with a deactivated or default PIN.

	Transparent transmission	SMS transmission
SIM card required	Voice card	Data card (SMS)
Formats supported	Audio, transmission formats of the control panel (contact ID or DTMF-based formats recommended)	Contact ID
Alarm receiver	Standard receiver for telephone network (e.g. D6600)	Special SMS receiver

Parts Included

Type	Number	Component
ITS-300GSM	1	ITS-300GSM module with mounting frame, antenna, pre-assembled cable

Technical Specifications

Telephone line fault output	Normally closed
Telephone line fault limit value	3.5 V
Telephone network connection	RJ-11 socket or screw terminal
Supported GSM networks	800/900/1800 MHz
Power supply	Connection to control panel battery
Power intake	Standby: 30 mA; GSM transmission 350 mA

ICP-EZPS-FRA AFNOR Power Supply

Technical Specifications

Primary Voltage Input 110 V +10/-15% (60 Hz)
(AC): 230 V +10/-15% (50 Hz)

Ordering Information

ICP-EZPS-FRA AFNOR Power Supply **ICP-EZPS-FRA**

For use in France. Provides 14 VDC and isolated auxiliary power outputs.

ICP-EZPS Wire-in Power Supply



For use in Europe, the Middle East, Asia Pacific, Central and South America. 100 VAC to 240 VAC primary voltage input (AC).

Certifications and Approvals

Region	Certification
Europe	CE 1999/5/EC, 2006/95/EC, 2004/108/EC; EN 55022:2006 + A1:2007, Class B; EN 50130-4 w/A1:1998 + A2:2003; EN61000-3-2:2006; EN61000-3-3:1995; EN 60950-1:2001; TBR21:1998

Technical Specifications

Primary Voltage Input (AC):	110 V +10/-15% (60 Hz) 230 V +10/-15% (50 Hz)
-----------------------------	--------------------------------------------------

Ordering Information

ICP-EZPS Wire-in Power Supply

For use in Europe, the Middle East, Asia Pacific, Central and South America. 100 VAC to 240 VAC primary voltage input (AC).

ICP-EZPS

ICP-EZPK Programming Key



Transfers program information to and from the control panel. Use the programming key to quickly program a group of Easy Series Intrusion Control Panels with the same characteristics. The programming key is color-coded blue.

Certifications and Approvals

Region	Certification
Europe	CE 1999/5/EC, 2006/95/EC, 2004/108/EC; EN 55022:2006 + A1:2007, Class B; EN 50130-4 w/A1:1998 + A2:2003; EN61000-3-2:2006; EN61000-3-3:1995; EN 60950-1:2001; TBR21:1998

Ordering Information

ICP-EZPK Programming Key

Blue key for transferring information to and from Easy Series Intrusion Control Panels.

ICP-EZPK

Easy Series Voice Modules



Easy Series voice modules allow the IUI-EZ1 Oval Control Center to provide spoken instructions and information. Bosch offers voice modules in 34 languages. Each voice module uses a female voice.

For ultimate flexibility, specific Easy Series kits do not include voice modules. The voice module in a preferred language can be ordered separately and used in the system.

Europe, Middle East, and Africa				
Language	Kit Commercial Type Number	Power	Tamper	Voice Module Commercial Type Number
None ¹	ICP-EZ2AWT-00	Wire-in, 100 V to 250 V	Yes	None ¹
English	ICP-EZ2AWT-01	Wire-in, 100 V to 250 V	Yes	ICP-EZV2-ENF
British English	ICP-EZ2AWT-02	Wire-in, 100 V to 250 V	Yes	ICP-EZV2-ENUKF
German	ICP-EZ2AWT-03	Wire-in, 100 V to 250 V	Yes	ICP-EZV2-DEF
Dutch	ICP-EZ2AWT-04	Wire-in, 100 V to 250 V	Yes	ICP-EZV2-NLF
Hungarian	ICP-EZ2AWT-05	Wire-in, 100 V to 250 V	Yes	ICP-EZV2-HUF
Czech	ICP-EZ2AWT-06	Wire-in, 100 V to 250 V	Yes	ICP-EZV2-CSF
Polish	ICP-EZ2AWT-07	Wire-in, 100 V to 250 V	Yes	ICP-EZV2-PLF
Italian	ICP-EZ2AWT-08	Wire-in, 100 V to 250 V	Yes	ICP-EZV2-ITF
Spanish	ICP-EZ2AWT-09	Wire-in, 100 V to 250 V	Yes	ICP-EZV2-ESF
Swedish	ICP-EZ2AWT-10	Wire-in, 100 V to 250 V	Yes	ICP-EZV2-SVF
French	ICP-EZ2AWT-11	Wire-in, 100 V to 250 V	Yes	ICP-EZV2-FRF
Portuguese	ICP-EZ2AWT-12	Wire-in, 100 V to 250 V	Yes	ICP-EZV2-PTF
Russian	ICP-EZ2AWT-14	Wire-in, 100 V to 250 V	Yes	ICP-EZV2-RUF
Greek	ICP-EZ2AWT-15	Wire-in, 100 V to 250 V	Yes	ICP-EZV2-ELF
Norwegian	ICP-EZ2AWT-16	Wire-in, 100 V to 250 V	Yes	ICP-EZV2-NOF
Danish	ICP-EZ2AWT-17	Wire-in, 100 V to 250 V	Yes	ICP-EZV2-DAF
Finnish	ICP-EZ2AWT-18	Wire-in, 100 V to 250 V	Yes	ICP-EZV2-FIF
Turkish	ICP-EZ2AWT-19	Wire-in, 100 V to 250 V	Yes	ICP-EZV2-TRF
Arabic	ICP-EZ2AWT-21	Wire-in, 100 V to 250 V	Yes	ICP-EZV2-ARF
Bulgarian	ICP-EZ2AWT-22	Wire-in, 100 V to 250 V	Yes	ICP-EZV2-BGF
Croatian	ICP-EZ2AWT-25	Wire-in, 100 V to 250 V	Yes	ICP-EZV2-HRF
Flemish	ICP-EZ2AWT-27	Wire-in, 100 V to 250 V	Yes	ICP-EZV2-NLBEF
Romanian	ICP-EZ2AWT-29	Wire-in, 100 V to 250 V	Yes	ICP-EZV2-ROF
Slovak	ICP-EZ2AWT-30	Wire-in, 100 V to 250 V	Yes	ICP-EZV2-SKF
Slovenian	ICP-EZ2AWT-31	Wire-in, 100 V to 250 V	Yes	ICP-EZV2-SLF
Serbian	ICP-EZ2AWT-32	Wire-in, 100 V to 250 V	Yes	ICP-EZV2-SRF
United Kingdom				
Language	Kit Commercial Type Number	Power	Tamper	Voice Module Commercial Type Number
None ¹	ICP-EZUAWT-00	Wire-in, 230 V	Yes	None ¹
British English	ICP-EZUAWT-02	Wire-in, 230 V	Yes	ICP-EZV2-ENUKF
Asia Pacific, Central and South America				
Language	Kit Commercial Type Number	Power	Tamper	Voice Module Commercial Type Number
None ¹	ICP-EZ2AWU-00	Wire-in, 100 V to 250 V	No	None ¹
English	ICP-EZ2AWU-01	Wire-in, 100 V to 250 V	No	ICP-EZV2-ENF
Mandarin	ICP-EZ2AWU-13	Wire-in, 100 V to 250 V	No	ICP-EZV2-ZHF
Japanese	ICP-EZ2AWU-20	Wire-in, 100 V to 250 V	No	ICP-EZV2-JAF
Korean	ICP-EZ2AWU-34	Wire-in, 100 V to 250 V	No	ICP-EZV2-KOF
None ²	ICP-EZ0AVU-00	None ²	No	None ²
Australian	ICP-EZ2AWU-23	Wire-in, 100 V to 250 V	No	ICP-EZV2-ENAFU
Cantonese	ICP-EZ2AWU-26	Wire-in, 100 V to 250 V	No	ICP-EZV2-ZHHKF
Thai	ICP-EZ2AWU-33	Wire-in, 100 V to 250 V	No	ICP-EZV2-THF
Spanish	ICP-EZ2AWU-24	Wire-in, 100 V to 250 V	No	ICP-EZV2-ESLXF
Portuguese	ICP-EZ2AWU-28	Wire-in, 100 V to 250 V	No	ICP-EZV2-PTBRF
United States				
Language	Kit Commercial Type Number	Power	Tamper	Voice Module Commercial Type Number
None ¹	ICP-EZ2AXU-00	Plug-in, 110 V for US	No	None ¹
English	ICP-EZ2AXU-01	Plug-in, 110 V for US	No	ICP-EZV2-ENF
Korean	ICP-EZ2AXU-34	Plug-in, 110 V for US	No	ICP-EZV2-KOF
Spanish	ICP-EZ2AXU-24	Plug-in, 110 V for US	No	ICP-EZV2-ESLXF
Canada				
Language	Kit Commercial Type Number	Power	Tamper	Voice Module Commercial Type Number
None ¹	ICP-EZ2AYU-00	Plug-in, 110 V for Canada	No	None ¹
English	ICP-EZ2AYU-01	Plug-in, 110 V for Canada	No	ICP-EZV2-ENF
French	ICP-EZ2AYU-11	Plug-in, 110 V for Canada	No	ICP-EZV2-FRF

¹ Requires a separately purchased voice module for operation.

² Requires a separately purchased voice module, power supply, and enclosure for operation.

Ordering Information

Arabic Voice Module Arabic language module programmed with a female voice. Works as part of the Easy Series Intrusion Control Panel system to provide spoken instructions and information.	ICP-EZV2-ARF
British Voice Module British English language module programmed with a female voice. Works as part of the Easy Series Intrusion Control Panel system to provide spoken instructions and information.	ICP-EZV2-ENUKF
Bulgarian Voice Module Bulgarian language module programmed with a female voice. Works as part of the Easy Series Intrusion Control Panel system to provide spoken instructions and information.	ICP-EZV2-BGF
Croatian Voice Module Croatian language module programmed with a female voice. Works as part of the Easy Series Intrusion Control Panel system to provide spoken instructions and information.	ICP-EZV2-HRF
Czech Voice Module Czechoslovakian language module programmed with a female voice. Works as part of the Easy Series Intrusion Control Panel system to provide spoken instructions and information.	ICP-EZV2-CSF
Danish Voice Module Danish language module programmed with a female voice. Works as part of the Easy Series Intrusion Control Panel system to provide spoken instructions and information.	ICP-EZV2-DAF
Dutch Voice Module Dutch language module programmed with a female voice. Works as part of the Easy Series Intrusion Control Panel system to provide spoken instructions and information.	ICP-EZV2-NLF
English Voice Module English language module programmed with a female voice. Works as part of the Easy Series Intrusion Control Panel system to provide spoken instructions and information.	ICP-EZV2-ENF
Finnish Voice Module Finnish language module programmed with a female voice. Works as part of the Easy Series Intrusion Control Panel system to provide spoken instructions and information.	ICP-EZV2-FIF
Flemish Voice Module Flemish language module programmed with a female voice. Works as part of the Easy Series Intrusion Control Panel system to provide spoken instructions and information.	ICP-EZV2-NLBEF
French Voice Module French language module programmed with a female voice. Works as part of the Easy Series Intrusion Control Panel system to provide spoken instructions and information.	ICP-EZV2-FRF
German Voice Module German language module programmed with a female voice. Works as part of the Easy Series Intrusion Control Panel system to provide spoken instructions and information.	ICP-EZV2-DEF

Ordering Information

Greek Voice Module Greek language module programmed with a female voice. Works as part of the Easy Series Intrusion Control Panel system to provide spoken instructions and information.	ICP-EZV2-ELF
Hungarian Voice Module Hungarian language module programmed with a female voice. Works as part of the Easy Series Intrusion Control Panel system to provide spoken instructions and information.	ICP-EZV2-HUF
Italian Voice Module Italian language module programmed with a female voice. Works as part of the Easy Series Intrusion Control Panel system to provide spoken instructions and information.	ICP-EZV2-ITF
Norwegian Voice Module Norwegian language module programmed with a female voice. Works as part of the Easy Series Intrusion Control Panel system to provide spoken instructions and information.	ICP-EZV2-NOF
Polish Voice Module Polish language module programmed with a female voice. Works as part of the Easy Series Intrusion Control Panel system to provide spoken instructions and information.	ICP-EZV2-PLF
Portuguese [European] Voice Module Portuguese language module programmed with a female voice. Works as part of the Easy Series Intrusion Control Panel system to provide spoken instructions and information.	ICP-EZV2-PTF
Romanian Voice Module Romanian language module programmed with a female voice. Works as part of the Easy Series Intrusion Control Panel system to provide spoken instructions and information.	ICP-EZV2-ROF
Russian Voice Module Russian language module programmed with a female voice. Works as part of the Easy Series Intrusion Control Panel system to provide spoken instructions and information.	ICP-EZV2-RUF
Serbian Voice Module Serbian language module programmed with a female voice. Works as part of the Easy Series Intrusion Control Panel system to provide spoken instructions and information.	ICP-EZV2-SRF
Slovak Voice Module Slovak language module programmed with a female voice. Works as part of the Easy Series Intrusion Control Panel system to provide spoken instructions and information.	ICP-EZV2-SKF
Slovenian Voice Module Slovenian language module programmed with a female voice. Works as part of the Easy Series Intrusion Control Panel system to provide spoken instructions and information.	ICP-EZV2-SLF
Spanish [European] Voice Module Spanish language module programmed with a female voice. Works as part of the Easy Series Intrusion Control Panel system to provide spoken instructions and information.	ICP-EZV2-ESF

Ordering Information

Swedish Voice Module**ICP-EZV2-SVF**

Swedish language module programmed with a female voice. Works as part of the Easy Series Intrusion Control Panel system to provide spoken instructions and information.

Turkish Voice Module**ICP-EZV2-TRF**

Turkish language module programmed with a female voice. Works as part of the Easy Series Intrusion Control Panel system to provide spoken instructions and information.

CC408 Solution 880 Control Panel



Features

- ▶ **Eight programmable user codes and eight radio remote user codes**
- ▶ **Two areas**
- ▶ **DTMF telephone remote arming**
- ▶ **Three arming modes**
- ▶ **Day alarm, duress alarm, and codepad tamper alarm**
- ▶ **Built-in telephone line fault monitor**
- ▶ **Zone lockout**
- ▶ **Automatic battery testing**
- ▶ **Event memory recall**
- ▶ **Programmable ring burst time**

The CC408 Solution 880 Control Panel provides eight programmable zones.

Functions

Functions for All Models

Eight Programmable User Codes and Eight Radio Remote User Codes

Users can program up to eight user codes and eight radio user codes. Only the Master Code holder can add or change other system user codes.

Two Areas

The control panel is partitioned into two areas. Users can operate both areas from one master codepad or from multiple separate area addressable codepads.

Three Arming Modes

Users can arm the system using one of three modes:

AWAY Mode: Arms the entire system.

STAY Mode 1: Arms most zones. Does not arm zones programmed as isolated (installer).

STAY Mode 2: Arms most zones. Does not arm zones programmed as isolated (Master Code holder).

Dual-tone Multi-frequency (DTMF) Telephone Remote Arming

Users can arm the system from any remote location using a DTMF telephone. Once a communication link is established between a DTMF telephone and the system, users can operate the system using the telephone in the same way as a codepad.

Day Alarm

Day alarm monitors a group of zones when the system is disarmed. For example, the front door of a shop has a pressure mat or electronic beam that customers turn on as they enter or exit. The codepad beeps each time the mat or beam turns on.

Duress Alarm

A codepad duress alarm can work as a silent hold-up alarm and is useful when the system reports to a monitoring station or pocket pager.

Codepad Tamper Alarm

Codepad tamper limits the number of times that someone can try to enter the wrong user code. When someone exceeds the limit, the system starts an alarm and sends a report to a security monitoring station.

End-Of-Line (EOL) Resistor Value Choice

Users can choose different EOL resistor values when programming the control panel. The selected value applies to all zones at once. Users can add the control panel into an existing system without changing the EOL resistors.

Built-in Telephone Line Fault Monitor

When the system detects a telephone line failure, it creates a telephone line fault. Users can program the system to sound an alarm if the telephone line is cut while the control panel is armed.

Zone Lockout

The first zone to send an alarm condition is locked and a siren runs for a specified time. All other zones that send alarm conditions are reset when the sirens reset, but continue to report if another alarm condition occurs. This prevents an intruder from setting off the alarms in all zones, waiting for the sirens to stop, and then entering the site.

Automatic Battery Testing

The system performs a battery test each time a user arms the system, and automatically every four hours. When the system detects a low capacity back-up battery, it creates a low battery fault.

Event Memory Recall

Event Memory Recall plays the last 40 system events, including all alarms, system arming, and system disarming. If the control panel is partitioned, Event Memory Recall plays the last 10 system events.

Programmable Ring Burst Time

Telephone ring times might be longer or shorter depending on the technology in a system. Different timing can cause control panels to answer calls that should be answered by an answering machine, fax, or a person. Users can program the control panel for the correct ring burst time. Adjust the ring time by 5 ms up to a total of 75 ms, or by 80 ms up to a total of 1200 ms.

Functions for CC408 Models

Call Forwarding

The telecommunications provider must offer a call forward option. Users can program call forwarding modes to operate when the system is armed in the AWAY Mode.

Call Forward Modes

- **Immediate On:** Redirects all incoming calls to another number, including mobile phone, pagers, and answering services. The telephone called first does not ring.
- **No Answer:** Redirects all incoming calls to another number when the telephone that was called first is not answered within 20 seconds. Outgoing calls can still be made from the first telephone.

Certifications and Approvals

Region	Certification
Europe	CE
China	CCC
A-Tick Supplier Code	N663
New Zealand Telepermit	PTC 211/98/083

Installation/Configuration Notes

Compatibility Information

RF Receivers	RE005E RF Receiver with Outputs WE800E RF Receiver
RF Transmitters	RE012E Two-channel Hand-held Transmitter RE013E Four-channel Hand-held Transmitter
Codepads	<ul style="list-style-type: none"> • CP105A Night Arm Station • CP500AW LED Area Addressable • CP500ALW LCD Area Addressable • CP500PW LED Partitionable • CP516LW LCD • CP516W LED
Modules	MO144 Universal Timer Module

Technical Specifications

Specifications for All Models

Environmental Considerations

Relative Humidity:	10% to 95% non-condensing
Temperature (Operating):	0°C to +45°C (+32°F to +113°F)

Power Requirements

Current Draw (Standby):	65 mA
Current Draw (Alarm):	115 mA
Current Draw (with Codepad):	105 mA
Primary:	240 VAC, 18 VAC at 1.3 A from a TF008 Plug Pack
Secondary:	12 VDC, 6 Ah from a rechargeable sealed lead acid battery

Specifications for CC408 Solution 880 Control Panel

Enclosure

Dimensions:	30.6 cm x 26.2 cm x 8.4 cm (12 in x 10.3 in x 3.3 in) Packed in carton
Weight:	2.5 kg (5.5 lb)

Ordering Information

CC408P Solution 880 Control Panel	CC408P
Includes assembled printed circuit board (PCB), power connector, EOL resistors, terminals, and battery leads.	
CC408PSP Solution 880 Control Panel	CC408PSP
Includes assembled printed circuit board (PCB), power connector, EOL resistors, terminals, battery leads, and literature in Spanish.	

Accessories

CC808 Direct Link Cable	CC808
Cable to connect CC816 Alarm Link Software (A-Link) to Solution 862, Solution 880 Ultima, and Solution 16 Control Panels.	
CC811S Modem Module	CC811S
Modem module for Solution 862, 880, and Ultima Control Panels for SMS reporting.	
CC891 Programming Key	CC891
Uploads and downloads program settings for Solution 16, Solution 862, Solution 880, and Ultima Control Panels.	

CC488 Solution Ultima 880 Control Panel



Features

- ▶ **Eight programmable user codes and eight radio remote user codes**
- ▶ **Two areas**
- ▶ **DTMF telephone remote arming**
- ▶ **Remote programming**
- ▶ **Three arming modes**
- ▶ **Day alarm, duress alarm, and codepad tamper alarm**
- ▶ **Built-in telephone line fault monitor**
- ▶ **Zone lockout**
- ▶ **Automatic battery testing**
- ▶ **Event memory recall**

The CC488 Solution Ultima 880 Control Panel provides eight programmable hard-wired or wireless burglary zones. Remote programming provides added convenience and adaptability.

Functions

Eight Programmable User Codes and Eight Radio Remote User Codes

Users can program up to eight user codes and eight radio user codes. Only the Master Code holder can add or change other system user codes.

Two Areas

The control panel is partitioned into two areas. Operate both areas from one master codepad or from multiple separate area addressable codepads.

Remote Programming

Users can program the zones remotely with CC816 Alarm Link (A-Link) software on a PC with MS-DOS® and a modem. Users can run diagnostics, arm systems, and bypass zones with an off-site computer. This reduces service visits to a site and provides quick customer service, saving time and money. Remote programming is useful for country locations where a control panel might be located hundreds of kilometers (miles) from an office.

Three Arming Modes

Users can arm the system using one of three modes:

AWAY Mode: Arms the entire system.

STAY Mode 1: Arms most zones. Does not arm zones programmed as isolated (installer).

STAY Mode 2: Arms most zones. Does not arm zones programmed as isolated (Master Code holder).

Dual-tone Multi-frequency (DTMF) Telephone Remote Arming

Users can arm the system from any remote location using a DTMF telephone. Once a communication link is established between a DTMF telephone and the system, users can operate the system using the telephone in the same way as a codepad.

Day Alarm

Day alarm monitors a group of zones when the system is disarmed. For example, the front door of a shop has a pressure mat or electronic beam that customers turn on as they enter or exit. The codepad beeps each time the mat or beam turns on.

Duress Alarm

A codepad duress alarm can work as a silent hold-up alarm and is useful when the system reports to a monitoring station or pocket pager.

Codepad Tamper Alarm

Codepad tamper limits the number of times that someone can try to enter the wrong user code. When someone exceeds the limit, the system starts an alarm and sends a report to a security monitoring station.

Choice of End-Of-Line (EOL) Resistor Value

Users can choose different EOL resistor values when programming the control panel. The selected value applies to all zones at once. Users can add the control panel into an existing system without changing the EOL resistors.

Built-in Telephone Line Fault Monitor

When the system detects a telephone line failure, it creates a telephone line fault. Users can program the system to sound an alarm if the telephone line is cut while the control panel is armed.

Zone Lockout

The first zone to send an alarm condition is locked and a siren runs for a specified time. All other zones that send alarm conditions are reset when the sirens reset, but continue to report if another alarm condition occurs. This prevents an intruder from setting off the alarms in all zones, waiting for the sirens to stop, and then entering the site.

Automatic Battery Testing

The system performs a battery test each time a user arms the system, and automatically every four hours. When the system detects a low capacity back-up battery, it creates a low battery fault.

Event Memory Recall

Event Memory Recall plays the last 40 system events, including all alarms, system arming, and system disarming. If the control panel is partitioned, Event Memory Recall plays the last 10 system events.

Programmable Ring Burst Time

Telephone ring times might be longer or shorter depending on the technology in a system. Different timing can cause control panels to answer calls that should be answered by an answering machine, fax, or a person. Users can program the control panel for the correct ring burst time. Adjust the ring time from 0 ms to 1200 ms in 5 ms increments.

Call Forwarding

The telecommunications provider must offer a call forwarding option. Users can program call forwarding modes to operate when the system is armed in the AWAY Mode.

Call Forward Modes

- **Immediate On:** Redirects all incoming calls to another number, including mobile phones, pagers, and answering services. The telephone called first does not ring.
- **No Answer:** Redirects all incoming calls to another number when the telephone that was called first is not answered within 20 seconds. Outgoing calls can still be made from the first telephone.

Certifications and Approvals

Region	Certification
Europe	CE
A-Tick Supplier Code	N663
New Zealand Telepermit	PTC 211/98/083

Installation/Configuration Notes

Compatibility Information

RF Receivers	RE005E RF Receiver with Outputs
RF Transmitters	RE012E Two-channel Hand-held Transmitter RE013E Four-channel Hand-held Transmitter
Codepads	<ul style="list-style-type: none"> • CP105A Night Arm Station • CP500AW LED Area Addressable • CP500ALW LCD Area Addressable • CP500PW LED Partitionable • CP516LW LCD • CP516W LED
Modules	MO144 Universal Timer Module

Technical Specifications

Enclosure

Dimensions:	30.6 cm x 26.2 cm x 8.4 cm (12 in x 10.3 in x 3.3 in) Packed in carton
-------------	------------------------------------------------------------------------------

Weight:	2.5 kg (5.5 lb)
---------	-----------------

Environmental Considerations

Relative Humidity:	10% to 95% non-condensing
Temperature (Operating):	0°C to +45°C (+32°F to +113°F)

Power Requirements

Current Draw (Standby):	65 mA
Current Draw (Alarm):	115 mA
Current Draw (with Codepad):	105 mA
Primary:	240 VAC, 18 VAC at 1.3 A from a TF008 Plug Pack
Secondary:	12 VDC, 6 Ah from a rechargeable sealed lead/acid battery

Trademarks

MS-DOS® is a registered trademark of Microsoft Corporation in the United States and/or other countries.

Ordering Information

CC488P Solution Ultima 880 Control Panel	CC488P
Includes assembled printed circuit board (PCB), power connector, EOL resistors, terminals, and battery leads.	
CC808 Direct Link Cable	CC808
Cable to connect CC816 Alarm Link Software (A-Link) to Solution 862, Solution 880 Ultima, and Solution 16 Control Panels.	
CC811S Modem Module	CC811S
Modem module for Solution 862, 880, and Ultima Control Panels for SMS reporting.	
CC891 Programming Key	CC891
Uploads and downloads program settings for Solution 16, Solution 862, Solution 880, and Ultima Control Panels.	
Enclosure with Transformer (220 VAC)	EDM-ENCL-KIT
Metal enclosure with 220 VAC transformer, fuse and terminal block, front and rear tamper switch, and key lock on door.	

CC880 Solution 16 Control Panel



Features

- ▶ 16 zones
- ▶ 32 programmable codes
- ▶ Four areas
- ▶ Remote programming
- ▶ DTMF telephone remote arming (optional)
- ▶ Three arming modes
- ▶ Day alarm, duress alarm, and codepad tamper alarm
- ▶ Telephone line fault monitor (optional)
- ▶ Automatic battery testing
- ▶ Event memory recall

The CC880 Solution 16 Control Panel is part of an electronic surveillance system suitable for home or business needs. The control panel supports 16 zones. Eight zones use programmable end-of-line (EOL) resistor values. Add an eight-zone expansion board or use zone doubling to achieve 16 zones.

Functions

Functions for All Models

32 Programmable User Codes

The control panel system supports 32 personal identification number (PIN) user codes. Each PIN can have up to seven digits. Any number of users can be assigned a master PIN. Master PIN users can program other PINs and perform general system configuring. All other user PINs are assigned to one of five authority levels.

Four Areas

The control panel is partitioned into four areas. One master codepad or multiple separate area addressable codepads can operate each area.

Remote Programming

Users can program the zones remotely with CC816 Alarm Link (A-Link) software on a PC with MS-DOS® and a modem. Users can run diagnostics, arm systems, and bypass zones with an off-site computer. This reduces service visits to a site and provides quick customer service, saving time and money. Remote programming is invaluable for country locations where a control panel might be located hundreds of kilometers (miles) from an office.

Dual-tone Multi-frequency (DTMF) Telephone Remote Arming

The optional CC886 Telephone DTMF Command Module allows a DTMF telephone to arm the system from any remote location. Once a communication link is established between a DTMF telephone and the system, users can operate the system using the telephone in the same way as a codepad.

Three Arming Modes

Users arm the system in one of three modes:

AWAY Mode: Arms the entire system.

STAY Mode 1: Arms most zones. Does not arm zones programmed as isolated (Installer).

STAY Mode 2: Arms most zones. Does not arm zones programmed as isolated (Master Code holder).

Day Alarm

Day alarm monitors a group of zones when the system is disarmed. For example, the front door of a shop has a pressure mat or electronic beam that customers turn on as they enter or exit. The codepad beeps each time the mat or beam turns on.

Duress Alarm

A codepad duress alarm can work as a silent hold-up alarm and is useful when the system reports to a monitoring station or pocket pager.

Codepad Tamper Alarm

Codepad tamper limits the number of times that someone can try to enter the wrong user code. When someone exceeds the limit, the system starts an alarm and sends a report to a security monitoring station.

Telephone Line Fault Monitor Option

The optional CC887 Telephone Line Fault Module creates a telephone line fault when a telephone line fails. Users can program the system to sound an alarm if the telephone line is cut while the control panel is armed.

Automatic Battery Testing

The system performs a battery test each time a user arms the system, and automatically every four hours. When the system detects a low capacity back-up battery, it creates a low battery fault.

Event Memory Recall

Event Memory Recall plays the last 40 system events, including all alarms, system arming, and system disarming. If the control panel is partitioned, Event Memory Recall plays the last 10 system events.

End-Of-Line (EOL) Resistor Value Choice

Users can choose from different EOL resistor values when programming the control panel. The selected value applies to all eight programmable zones at once. Users can add a control panel into an existing system without changing the EOL resistors.

For 16 zones, use zone doubling or add an eight zone expansion board. With zone doubling, zones one to eight are 3 K3, and zones nine to 16 are 6 K8. The CC883 Eight Zone Expansion Board supports adjustable EOL resistor values.

Functions for CC880 Models

Call Forwarding

The telecommunications provider must offer a call forwarding option. Users can program call forwarding modes to operate when the system is armed in the AWAY Mode.

Call Forward Modes

- **Immediate On:** Redirects all incoming calls to another number, including mobile phones, pagers, and answering services. The telephone called first does not ring.
- **No Answer:** Redirects all incoming calls to another number when the telephone that was called first is not answered within 20 seconds. Outgoing calls can still be made from the first telephone.

Functions for CC880PSP Models

Programmable Ring Burst Time

Telephone ring times might be longer or shorter depending on the technology in a system. Different timing can cause control panels to answer calls that should be answered by an answering machine, fax, or a person. Users can program the control panel for the correct ring burst time. Adjust the ring time from 0 ms to 1200 ms in 5 ms increments.

Certifications and Approvals

Region	Certification
Europe	CE
A-Tick Supplier Code	N663
New Zealand Telepermit	PTC 211/95/246

Installation/Configuration Notes

Compatibility Information

RF Receivers	RE005E RF Receiver with Outputs
RF Transmitters	RE012E Two-channel Hand-held Transmitter RE013E Four-channel Hand-held Transmitter
Codepads	<ul style="list-style-type: none"> • CP105A Night Arm Station • CP500AW LED Area Addressable • CP500ALW LCD Area Addressable • CP500PW LED Partitionable • CP516LW LCD • CP516W LED
Modules	MO144 Universal Timer Module

Technical Specifications

Enclosure

Dimensions (case, packed in carton):	30.6 cm x 26.2 cm x 8.4 cm (12 in. x 10.3 in. x 3.3 in.)
Weight:	2.5 kg (5.5 lb)

Environmental Considerations

Relative Humidity:	10% to 95% non-condensing
Temperature Range:	0°C to +45°C (+32°F to +113°F)

Power Requirements

Current Draw (Stand-By):	65 mA
Current Draw (Alarm):	115 mA
Current Draw (with Codepad):	105 mA
Primary:	240 VAC to 18 VAC at 1.3 A from a TF008 Plug Pack
Secondary:	12 VDC, 7 Ah from a rechargeable sealed lead acid battery

Trademarks

MS-DOS® is a registered trademark of Microsoft Corporation in the United States and/or other countries.

Ordering Information
CC880P Solution 16 Control Panel **CC880P**

Includes assembled printed circuit board (PCB), power connector, EOL resistors, terminals, battery leads, and spare fuses.

CC880PSP Solution 16 Control Panel **CC880PSP**

Includes assembled printed circuit board (PCB), power connector, EOL resistors, terminals, battery leads, and spare fuses. Has a programmable ring burst time option.

Accessories
CC808 Direct Link Cable **CC808**

Cable to connect CC816 Alarm Link Software (A-Link) to Solution 862, Solution 880 Ultima, and Solution 16 Control Panels.

CC811S Modem Module **CC811S**

Modem module for Solution 862, 880, and Ultima Control Panels for SMS reporting.

CC883 Eight-zone Expansion Board **CC883**

Works with Solution 16 Control Panels. Has adjustable EOL resistor values. Plugs on the control panel, providing space for wiring.

CC886 Telephone DTMF Command Module **CC886**

Works with Solution 16 Control Panels. Allows a touch-tone telephone to arm and disarm.

CC887 Telephone Line Fault Module **CC887**

Works with Solution 16 Control Panels. Monitors the telephone line connection and activates an alarm if the line fails or disconnects.

CC888 Programmable Voice Control Module **CC888**

Works with the Solution 16 Control Panel. Plays a 16 second recording as an alarm message.

CC891 Programming Key **CC891**

Uploads and downloads program settings for Solution 16, Solution 862, Solution 880, and Ultima Control Panels.

D126 Standby Battery (12 V, 7 Ah) **D126**

Sealed lead-acid standby and auxiliary rechargeable power supply.

VR8 Desktop Alarm System



Features

- ▶ **Eight zones**
- ▶ **16 supervised wireless sensors**
- ▶ **Built-in RF receiver, LCD keypad, analog dialer, and acoustic sounder**
- ▶ **16 user codes including eight keyfob users**
- ▶ **Background memory for 40 events**
- ▶ **Remote programming**

The VR8 Intruder Alarm System includes a control panel and assorted detectors such as magnetic, motion, and smoke. Operate the system using the keypad or keyfob.

Functions

Built-in Receiver

The system has a built-in receiver that connects up to 16 radio frequency (RF) devices such as PIR, door contacts, and smoke detectors.

Built-in Acoustic Sounder

Internal piezo siren provides at least 90 dBA/100 cm sound pressure level (SPL) to sound an alarm.

Built-in Tamper Switch

The built-in tamper notifies the control panel when someone removes the enclosure cover or lifts the unit from the desktop.

Arming and Disarming

Users can arm the VR8 using the keypad, a keyfob, or the telephone. Users can disarm the VR8 using the keypad or a keyfob. Programmable exit and entry time delay values determine the amount of time a user has to arm or disarm before the alarm sounds.

Programming

Program the VR8 System using the integrated keypad, a laptop, a plug-in programming key for standard programs, or compatible programming software.

Zone Types

Users can configure three zone types for the system.

Zone Type	Description
Burglary	Sounds an alarm when a fault is detected and the VR8 is armed.
24-Hour	Sounds an alarm when a fault is detected, such as a tamper switch. The VR8 can be armed or disarmed.
Fire	Sounds an alarm when a fault is detected by a smoke detector. The VR8 can be armed or disarmed.

Certifications and Approvals

Region Certification

Europe	CE
--------	----

CE

A-Tick

Installation/Configuration Notes

Compatibility Information

Keyfobs RF3332E and RF3334E

Smoke Detectors RF280ETHS

PIR Detectors RF940E

TriTech Detectors RF835E

RF Point Transmitters (Reed Switch) RF3401E

Programming Software CC816 Alarm Link Software (A-Link)

Wiring Considerations

Base includes cable routing channels for AC power and telephone cord.

Power Considerations

Requires locally approved, limited power Class I AC adaptor with 18 VAC, 1.3 A output and protective earth connection.

Parts Included

Each standard system includes:

Quantity Component

1	VR8 including built-in keypad, LCD display, and siren
---	-------------------------------------------------------

Technical Specifications

Data Bus	Internal ports for auxiliary and programming modules
-----------------	-------------------------------------------------------------

Enclosure Design

Color:	White
Indicators:	Eight zone LCD display
Material:	ABS
Dimensions:	20.8 cm x 25.5 cm x 8.4 cm (8 in. x 10 in. x 3 in.)

Weight without Battery and AC Adaptor:	1 kg (2 lb)
----------------------------------------	-------------

Environmental Considerations

Relative Humidity:	10% to 95% non-condensing
Temperature (Operating):	0°C to 45°C (32°F to 113°F)

Keypads

Number Supported:	One built-in keypad
-------------------	---------------------

Outputs

Alarm Relay:	One Form C contact rated at 1 A, 30 VDC
Solid-State:	Three open collector

Power Requirements

Current Draw:	65 mA from battery when idle and with AC fail
Primary Voltage Input:	Varies according to local adaptor
Secondary Voltage Input:	18 VAC, 1.3 A

Telephone Interface	Terminal block and 6p4c FCC68 Modules
----------------------------	---------------------------------------

Zone Characteristics

EOL Resistors:	Programmable for wired zones (if used)
----------------	----------------------------------------

Ordering Information

VR8 Desktop Alarm System

VR8488EU

Includes a control panel and assorted detectors. Operate the system using the keypad or keyfob.

CP500ALW Area Addressable LCD Codepad



Features

- ▶ **Single button arming of alarm system**
- ▶ **Fire, medical and panic alarms**
- ▶ **Stylish and modern design**
- ▶ **Clear and easy to use**
- ▶ **Backlit buttons for illuminated operation during day or night**

The CP500ALW is an eight zone LCD codepad with protective door that is compatible with the Solution 16 Control Panel when partitioned. The display is designed with a combination of numbers and ICONS to display the alarm systems condition and creates an easy interface for users.

The codepad will notify you when a zone is unsealed, when there has been an alarm and in which zone the alarm has occurred.

Also included as a standard feature are a number of single button functions that will allow a user to perform various system operations by simply holding down a button for two seconds. For example, holding the AWAY button will arm the system, holding the 1 button will test the sirens and holding the 3 button will test the strobe lights.

System Overview

If programmed to do so Fire, Panic and Medical alarms can be easily triggered from any codepad by pressing the outside buttons of a row at the same time.

Arming Methods

- **Method #1:** Enter the User code followed by the AWAY button. The AWAY indicator will display.

- **Method #2:** Hold down the AWAY button for two seconds. The AWAY indicator will display.

For further details on codepad operation please see the Solution panels listed in the Install and Configuration Notes, and then refer to the appropriate Operator Guide for the panel.

To disarm the system in AWAY mode, enter the user code followed by the AWAY button.

Installation/Configuration Notes

Compatibility Information

Control Panels	Solution 16 partitioned Solution 880 partitioned Solution Ultima 880 partitioned
----------------	----------------------------------------------------------------------------------------

Mounting Considerations

The CP500ALW can be surface mounted indoors through two to four screws.

Technical Specifications

Enclosure Design

Dimensions:	7.2 cm x 12.7 cm x 2.3 cm (2.8 in. x 5 in. x 1 in.)
-------------	--------------------------------------------------------

Environmental Considerations

Storage Temperature:	+0°C to +50°C (+32°F to 122°F)
Relative Humidity:	20% to 90% (non-condensing)

Power Requirements

Operating Voltage:	11 VDC to 14VDC
Current Draw:	50 mA (maximum)
Radio Frequency Interference (RFI) Immunity:	Complies with AS/NZS3548

Ordering Information

CP500ALW Area Addressable LCD Codepad CP500ALW

Shows 8 zones, provides LCD, and provides a protective door. Compatible with Solution 16 Control Panels when partitioned.

CP500AW Area Addressable LED Codepad



Features

- ▶ **Single button arming of alarm system**
- ▶ **Fire, medical and panic alarms**
- ▶ **Stylish and modern design**
- ▶ **Clear and easy to use**
- ▶ **Backlit buttons for illuminated operation during day or night**

The CP500AW is an eight zone LCD codepad with protective door that is compatible with the Solution 16 Control Panel when partitioned. The display is designed with a combination of numbers and words to display the alarm systems condition and creates an easy interface for users.

The codepad will notify you when a zone is unsealed, when there has been an alarm and in which zone the alarm has occurred.

Also included as a standard feature are a number of single button functions that will allow a user to perform various system operations by simply holding down a button for two seconds. For example, holding the AWAY button will arm the system, holding the 1 button will test the sirens and holding the 3 button will test the strobe lights.

System Overview

If programmed to do so Fire, Panic and Medical alarms can be easily triggered from any codepad by pressing the outside buttons of a row at the same time.

Arming Methods

- **Method #1:** Enter the User code followed by the AWAY button. The AWAY indicator will display.

- **Method #2:** Hold down the AWAY button for two seconds. The AWAY indicator will display.

For further details on codepad operation please see the Solution panels listed in the Install and Configuration Notes, and then refer to the appropriate Operator Guide for the panel.

To disarm the system in AWAY mode, enter the user code followed by the AWAY button.

Installation/Configuration Notes

Compatibility Information

Control Panels	Solution 16 partitioned Solution 880 partitioned Solution Ultima 880 partitioned
-----------------------	-------------------------------------------------------------------------------------------------------------

Mounting Considerations

The CP500AW can be surface mounted indoors through two to four screws.

Technical Specifications

Enclosure Design

Dimensions:	7.2 cm x 12.7 cm x 2.3 cm (2.8 in. x 5 in. x 1 in.)
-------------	--------------------------------------------------------

Environmental Considerations

Storage Temperature:	+0°C to +50°C (+32°F to 122°F)
Relative Humidity:	20% to 90% (non-condensing)

Power Requirements

Operating Voltage:	11 VDC to 14VDC
Current Draw:	50 mA (maximum)
Radio Frequency Interference (RFI) Immunity:	Complies with AS/NZS3548

Ordering Information

CP500AW Area Addressable LED Codepad	CP500AW
Shows 8 zones, provides LCD, and provides a protective door. Compatible with the Solution 16 Control Panel when partitioned.	

CP500PW Partitionable LED Codepad



Features

- ▶ **Single button arming of alarm system**
- ▶ **Fire, medical and panic alarms**
- ▶ **Stylish and modern design**
- ▶ **Clear and easy to use**
- ▶ **Backlit buttons for illuminated operation during day or night**

The CP500PW is a master partitioned codepad for use with the Solution 16 Control Panel when partitioned into areas. Comes with protective codepad lid.

The Master Partitioned codepad has eight zone indicators to notify you when a zone is unsealed, or when there has been an alarm, and in which zone the alarm has occurred.

At a touch of the # key, you can also select which area the eight zone information corresponds to. The area On/Off LED's tell you which areas are armed at a glance.

System Overview

If programmed to do so Fire, Panic and Medical alarms can be easily triggered from any codepad by pressing the outside buttons at the same time.

Arming Methods

- **Method #1:** Enter the User code followed by the AWAY button. The AWAY indicator will display.
- **Method #2:** Hold down the AWAY button for two seconds. The AWAY indicator will display.

The back DIP switches can be set to select the codepad area. For further details on codepad operation please see the Solution panels listed in the Install and Configuration Notes, and then refer to the appropriate Operator Guide for the panel.

To disarm the system in AWAY mode, enter the user code followed by the AWAY button.

Installation/Configuration Notes

Compatibility Information

Control Panels	Solution 16 partitioned Solution 880 partitioned Solution Ultima 880 partitioned
----------------	----------------------------------------------------------------------------------------

Mounting Considerations

The CP500PW can be surface mounted indoors through two to four screws.

Technical Specifications

Enclosure Design

Dimensions:	7.2 cm x 12.7 cm x 2.3 cm (2.8 in. x 5 in. x 1 in.)
-------------	--------------------------------------------------------

Environmental Considerations

Storage Temperature:	+0°C to +50°C (+32°F to 122°F)
Relative Humidity:	20% to 90% (non-condensing)

Power Requirements

Operating Voltage:	11 VDC to 14VDC
Current Draw:	50 mA (maximum)
Radio Frequency Interference (RFI) Immunity:	Complies with AS/NZS3548

Ordering Information

CP500PW Partitionable LED Codepad	CP500PW
Master codepad for viewing status of all areas of partitioned systems.	

CP508W LED Codepad



Features

- ▶ **Single button arming of alarm system**
- ▶ **Fire, medical and panic alarms**
- ▶ **Stylish and modern design**
- ▶ **Clear and easy to use**
- ▶ **Backlit buttons for illuminated operation during day or night**

The CP508W is an eight zone LED codepad, with protective door, which is compatible with the Solution range of alarm panels. The display is designed with a combination of numbers and words to display the alarm systems condition and creates an easy interface for users.

The codepad will notify you when a zone is unsealed, when there has been an alarm and in which zone the alarm has occurred.

Also included as a standard feature are a number of single button functions that will allow a user to perform various system operations by simply holding down a button for two seconds. For example, holding the AWAY button will arm the system, holding the 1 button will test the sirens and holding the 3 button will test the strobe lights.

System Overview

If programmed to do so Fire, Panic and Medical alarms can be easily triggered from any codepad by pressing the outside buttons at the same time.

To arm the system in AWAY Mode:

- Method #1: Enter the User code followed by the AWAY button.

The AWAY indicator will display:

- Method #2: Hold down the AWAY button for two seconds.

The AWAY indicator will display.

For further details on codepad operation please see the Solution panels listed in the Install and Configuration Notes, and then refer to the appropriate Operator Guide for the panel.

To Disarm the system in AWAY mode:

- Enter the user code followed by the AWAY button.

Installation/Configuration Notes

Compatibility Information

Control Panels	Solution 4 + 4 (Older Panel), Solution 6, Solution 6 + 6, Solution 8, Solution 862, Solution 880, Solution Ultima 880, Solution Ultima 862, Solution 16
----------------	---------------------------------------------------------------------------------------------------------------------------------------------------------

Mounting Considerations

The CP508W can be surface mounted indoors through two to four screws.

Technical Specifications

Enclosure Design

Dimensions:	7.2 cm x 12.7 cm x 2.3 cm (2.8 in. x 5 in. x 1 in.)
-------------	--------------------------------------------------------

Environmental Considerations

Storage Temperature:	+0°C to +50°C (+32°F to 122°F)
Relative Humidity:	20% to 90% (non-condensing)

Power Requirements

Operating Voltage:	11 VDC to 14VDC
Current Draw:	50 mA (maximum)
Radio Frequency Interference (RFI) Immunity:	Complies with AS/NZS3548

Ordering Information

CP508W LED Codepad	CP508W
Shows 8 zones and provides a protective door. Compatible with Solution Alarm Panels.	

CP516LW LCD Codepad



Features

- ▶ **Single button arming of alarm system**
- ▶ **Fire, medical and panic alarms**
- ▶ **Stylish and modern design**
- ▶ **Clear and easy to use**
- ▶ **Backlit buttons for illuminated operation during day or night**

The CP516LW is a 16 zone LCD codepad with protective door that is compatible with the Solution 16 alarm panel. The display is designed with a combination of numbers and ICONS to display the alarm systems condition and creates an easy interface for users.

The codepad will notify you when a zone is unsealed, when there has been an alarm and in which zone the alarm has occurred.

Also included as a standard feature are a number of single button functions that will allow a user to perform various system operations by simply holding down a button for two seconds. For example, holding the AWAY button will arm the system, holding the 1 button will test the sirens and holding the 3 button will test the strobe lights.

System Overview

If programmed to do so Fire, Panic and Medical alarms can be easily triggered from any codepad by pressing the outside buttons at the same time.

To arm the system in AWAY Mode:

- Method #1: Enter the User code followed by the AWAY button.

The AWAY indicator will display:

- Method #2: Hold down the AWAY button for two seconds.

The AWAY indicator will display.

For further details on codepad operation please see the Solution panels listed in the Install and Configuration Notes, and then refer to the appropriate Operator Guide for the panel.

To Disarm the system in AWAY mode:

- Enter the user code followed by the AWAY button.

Installation/Configuration Notes

Compatibility Information

Control Panels Solution 16

Mounting Considerations

The CP516LW can be surface mounted indoors through two to four screws.

Technical Specifications

Enclosure Design

Dimensions: 7.2 cm x 12.7 cm x 2.3 cm
(2.8 in. x 5 in. x 1 in.)

Environmental Considerations

Storage Temperature: +0°C to +50°C (+32°F to 122°F)
Relative Humidity: 20% to 90% (non-condensing)

Power Requirements

Operating Voltage: 11 VDC to 14VDC
Current Draw: 50 mA (maximum)
Radio Frequency Interference (RFI) Immunity: Complies with AS/NZS3548

Ordering Information

CP516LW LCD Codepad

Shows 16 zones, provides LCD, provides a protective door, and is compatible with Solution 16 Alarm Panels.

CP516LW

CP516W LED Codepad



Features

- ▶ **Single button arming of alarm system**
- ▶ **Fire, medical and panic alarms**
- ▶ **Stylish and modern design**
- ▶ **Clear and easy to use**
- ▶ **Backlit buttons for illuminated operation during day or night**

The CP516W is a 16 zone LED codepad, with protective door, that is compatible with the Solution 16 alarm panel. The CP516W has a user-friendly design. It uses a combination of numbers and words to display the alarm system condition and creates easy operation for users.

The codepad will notify you when a zone is unsealed, when there has been an alarm and in which zone the alarm has occurred.

Also included as a standard feature are a number of single button functions that will allow a user to perform various system operations by simply holding down a button for two seconds. For example, holding the AWAY button will arm the system, holding the 1 button will test the sirens and holding the 3 button will test the strobe lights.

System Overview

If programmed to do so Fire, Panic and Medical alarms can be easily triggered from any codepad by pressing the outside buttons at the same time.

Arming Methods

- **Method #1:** Enter the User code followed by the AWAY button. The AWAY indicator will display.
- **Method #2:** Hold down the AWAY button for two seconds. The AWAY indicator will display.

For further details on codepad operation please see the Solution panels listed in the Install and Configuration Notes, and then refer to the appropriate Operator Guide for the panel.

To disarm the system in AWAY mode, enter the user code followed by the AWAY button.

Installation/Configuration Notes

Compatibility Information

Control Panels Solution 16

Mounting Considerations

The CP516W can be surface mounted indoors through two to four screws.

Technical Specifications

Enclosure Design

Dimensions: 7.2 cm x 12.7 cm x 2.3 cm
(2.8 in. x 5 in. x 1 in.)

Environmental Considerations

Storage Temperature: +0°C to +50°C (+32°F to 122°F)

Relative Humidity: 20% to 90% (non-condensing)

Power Requirements

Operating Voltage: 11 VDC to 14VDC

Current Draw: 50 mA (maximum)

Radio Frequency Interference (RFI) Immunity: Complies with AS/NZS3548

Ordering Information

CP516W LED Codepad

Shows 16 zones and provides a protective door. Compatible with the Solution 16 Alarm Panel.

CP516W

DS7080iP32 Eight-zone Control Panels



Features

- ▶ Keypad programmable
- ▶ Remotely programmable
- ▶ Custom-programmable alpha display
- ▶ Two partitions
- ▶ History buffer
- ▶ Auto arming
- ▶ 24 PINs

The DS7080iP-32 Eight-zone Control Panels can be partitioned, and expanded to 32 zones. They accept up to 24 Personal ID numbers (PINs), are keypad or remotely programmable, support multiple languages, and have a wide range of features.

Functions

Keypad Programmable

Uses the DS7447E or DS7447V2 liquid-crystal display (LCD) keypads. There is no need for expensive hand-held programmers.

Remotely Programmable

Uses a standard Hayes modem and WDSRP2 software for Windows®, and a computer running Windows to program remotely. Using an off-site computer to run diagnostics, arm systems, and bypass zones reduces service visits.

Two Partitions

The DS7080iP-32 can be split into two partitions. Assign users to one or both partitions. Program common zones to allow users access to areas (foyers and entrance ways). Partitions and common zones can be accessed by assigned users from all keypads.

24 PINs

Supports 24 PINs in any combination of four or six digits. Designate PINs as master PINs that can be used to reprogram PINs. PINs can be programmed with seven levels of authority and restricted from bypassing, testing, and disarming the system.

100-event History Buffer

A 100-event history buffer, that can be read at the DS7447E or DS7447V2 keypads or uploaded to the WDSRP2 Remote Programming Software, tracks Open and Close, Alarm, and Trouble events by time and date. The installer can program which events are stored.

Eight Zones, Expandable to 32 Zones

The DS7080iP-32 accepts up to eight input zones. The zones are flexible, and can be programmed to provide different functions. Add up to 24 additional zones using EX8 expansion modules.

Answering Machine Override

This function is built into the DS7080iP-32 Control Panels. No external hardware is required.

Anti-takeover Protection

All or part of the programming can be locked so the program cannot be changed if someone attempts to takeover the account.

Automatic Arming or Delayed Arming

Program an automatic arming time for each partition daily, override automatic arm time, or specify a time for the panel to arm.

Cross-zoning Control

Program zones to cause an alarm only when specific zone pairs activate to reduce false alarms. Program cross-zoning to cause an alarm when zones activate in sequence for detecting the direction in which an intruder moved.

Custom Arming Configurations

Use different arming configurations to automatically bypass a group of zones.

Easy Function-Key User Interface

- Six labeled function keys eliminate the need for multi-button commands. Enter a PIN followed by the function key to perform functions such as arming, disarming, and resetting smoke detectors.
- The interface has easy to follow procedures. The interface does not use cumbersome menu driven formats, so expert users can quickly access the items they need.
- A programmable Quick Arm feature allows users to turn the system on without a PIN; however, a PIN is needed to turn off the system, silence alarms, or perform system tests. Residential Mode requires a PIN to disarm the system, silence alarms, and reset the system.

Program Memory

The control panel retains all program memory and the arm-disarm state during a power failure. When power restores, alarms are delayed to prevent false alarms from detectors that can take several minutes to become operational. None of the system programming or user codes are lost.

Flexible Digital Communication

The communicator works with most alarm receivers used today. It supports 3/1, 4/1, 4/2, SIA, Contact ID, High Speed 4/9, BFSK digital communicator formats, and a pager format. The pager format allows the control panel to dial a digital pager service and leave a numeric message representing the account number and event code.

Keypad Support

- The DS7443S LED Keypad has one LED per zone (LEDs 1 to 6 for main board zones) and four system status LEDs that indicate conditions such as armed, fire alarm, and trouble.
- The DS7445i or DS7445V2 Light-emitting Diode (LED) Keypads have one LED per zone (LEDs 1 to 8 for main board zones and LEDs 9 to 16 for expansion zones) and eight system status LEDs that indicate conditions such as armed, fire alarm, and trouble.
- The DS7447E or DS7447V2 Alphanumeric Keypads have two lines of custom-programmable display. You can program 16 characters of custom text for zone and partition descriptions. The user can adjust the sounder volume and backlight intensity using easy two-button commands. The DS7447E or DS7447V2 Keypad is required for system programming.

Note LED and LCD keypads can be mixed in the same system. Up to four keypads can be used, but no more than two keypads on any 300 m run.

Optional Eight-relay Output Module

The DS7488 module has eight Form C relays with fixed functions such as alarm output, system ready, and panic.

Optional Solid-state Output Module

The DS7489 module has eight current-sink outputs, with fixed functions, to operate devices such as LEDs and sounders. Total current sink is 750 mA for all eight outputs.

Smoke Detector Alarm Verification

Program the DS7080iP-32 Control Panels to perform an automatic reset on the smoke detectors if an alarm occurs. If a second alarm occurs within the verification window, an immediate fire alarm results. Fast response to a fire is maintained while potential false alarms are reduced.

Three Telephone Numbers

The system supports two 20-digit telephone numbers with a three- or four-digit account code. Configure each of the two phone number's communication format and choice of pulse or tone dialing. The third phone number is reserved for remote programming.

Two Independent Entry Delays

Program zones to select one of two entry delay times. You can select a longer entry delay time for zones that are located a long distance from the keypad.

Certifications and Approvals

Region	Certification	
Europe	CE	1999/5/EC, EN60950 Dec. 1992 (2nd edition) +A1 (1992) +A2 (1993), EN50081-1 (1992), EN50081-2 (1992)/61000-4 series
Belgium	INCERT	B-509-0003/a Jan 2004
USA	UL	AMCX: Central Station Alarm Units (UL1610, UL1635), AOTX: Local Alarm Units (UL464, UL609), APAW: Police Station Alarm Units (UL365, UL464), APOU: Proprietary Alarm Units (UL1076), NBSX: Household Burglar Alarm System Units (UL1023)
USA	FCC	

Installation/Configuration Notes

Compatible Products

The following products are compatible with the DS7080iP-32 Control Panels:

Keypads and Annunciators	DS7443S LED Keypad DS7445i LED Keypad DS7445V2 LED Keypad DS7447E LCD Keypad DS7447V2 LCD Keypad
Modules	C900 Dialer Capture Module C900TTL-E Dialer Capture Module DS7480 Bell Supervision Module DS7481 Single Phone Line Monitor DS7488 Octal Relay Module DS7489 Solid-state Output Module

Technical Specifications

Communicator

Phone Numbers:	2 phone numbers are available for reporting. A third number is available for remote programming.
Report Formats:	Full single, double and backup reporting
Communication Formats:	SIA, 3/1 Ext, 4/1, 4/2, Contact ID, High Speed 4/9, BFSK, and pager format
Ringer Equivalence:	0.1 B

Enclosure

Material:	1.0 mm, cold-rolled steel
Dimensions:	32 cm x 37 cm x 7.6 cm

Environmental Considerations

Relative Humidity:	5% to 85% at +30°C non-condensing
Temperature (Operating):	0°C to +49°C

Fire Signal Initiating Circuit (Two-Wire Mode)

Circuit Type:	Class B, latching
Supervisory Current:	5 mA
Circuit Voltage:	8.5 VDC to 14.1 VDC
Circuit Resistance:	60 Ω maximum
Current for Alarm:	12 mA minimum
Impedance for Alarm:	1000 Ω maximum
Short Circuit Current:	22 mA maximum
Detector Standby Current:	2.5 mA total
Detectors per Zone:	20 detectors (two-wire) maximum

Inputs

Burglar/Fire Zone:	8 circuits on-board, 24 off-board zones can be added. End-of-line resistor: 2.21 k Ω (P/N: 19809)
System Trouble:	A separate terminal can be used to monitor multiple external devices such as phone line monitors, without using 1 of the 8 zones. A dry contact output from such a device causes a system trouble.

Keypads

Keypads:	4 maximum
----------	-----------

Outputs

Alarm Output:	Normally-open, 1.0 A contact connected to auxiliary power. Can be programmed for steady or pulsed output.
Programmable Output 1:	Solid-state current sink (500 mA maximum) can be used for alarm, arming state, or access control. This output is generally programmable.
Programmable Output 2:	Solid-state voltage source (500 mA maximum). This is the smoke power reset for Zone 1 when it is used as a fire zone for two-wire smoke detectors. Can be used for alarm, arming state, or access control.

Power Requirements

Input Power:	18 VAC, 50 VA, 50 Hz
Output Power:	1.5 A maximum
Auxiliary Power:	10.2 VDC to 14.1 VDC
Auxiliary Current:	Total current for all auxiliary devices, including keypads and smoke detectors, is 1.0 A standby and 1.5 A alarm.
Panel Standby Current:	115 mA

Ordering Information

DS7080IP32-BEL Control Panel	DS7080iP32-BEL
For use in Belgium. Includes one control panel for 220 VAC operation, one enclosure, one lock set, one transformer, one resistor, and one hardware pack.	

DS7080IP32-FRA Control Panel	DS7080IP32-FRA
For use in France. Includes one control panel for 220 VAC operation, one enclosure, one lock set, one transformer, one resistor, and one hardware pack.	

Accessories

AE1 Standard Enclosure (Gray)	AE1
Standard gray enclosure with keyed lock. Measures 35.6 cm x 31.8 cm x 7.6 cm (14 in. x 12.5 in. x 3 in.).	

AE3 Large Enclosure (Gray)	AE3
Large gray enclosure with keyed lock. Measures 52.7 cm x 38.1 cm x 10.8 cm (20.7 in. x 15 in. x 4.25 in.).	

DS7220V2 Control Panel



Features

- ▶ Eight on-board zones
- ▶ Eight programmable Skeds
- ▶ RF compatibility
- ▶ Up to 32 users with optional keyfob operation available
- ▶ Four programmable authority levels
- ▶ Two communications routing destinations
- ▶ 254 event log
- ▶ Remote-programmable with RPS-INTL
- ▶ Optional Door Access Control Module (DACM)
- ▶ Network communication option (LAN/WAN)

The DS7220V2 has eight zones expandable to 24, four outputs expandable to 12, and two areas. It is suitable for commercial burglary and residential fire/burglary applications.

System Overview

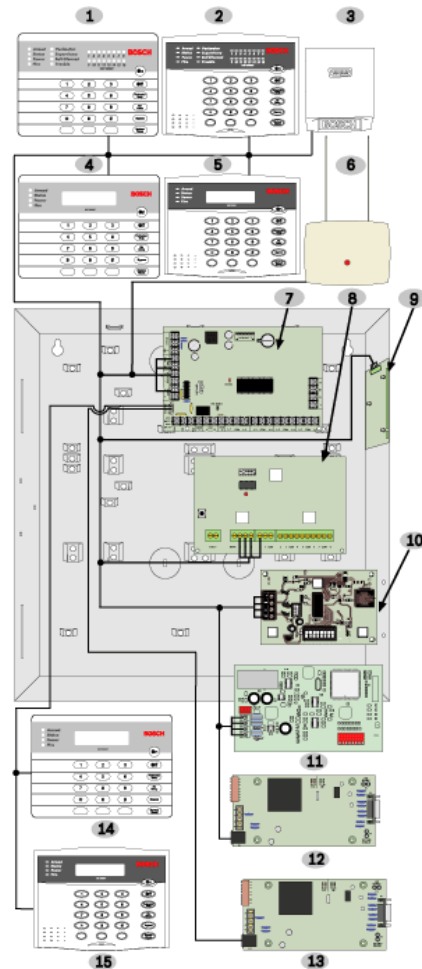

1. DS7445i LED Keypad
2. DS7445V2 LED Keypad
3. Door Access Control Module (DACM)
4. DS7447E LCD Keypad
5. DS7447V2 LCD Keypad
6. RF3227E RF Receiver
7. DS7220V2 Control Panel
8. DX3010 Octo-output Expander
9. DX2010 Input Expander
10. DX3020 X-10 Interface Module
11. DX4020 Network Interface Module
12. DX4010i RS-232 Serial Interface Module
13. DX4010i RS-232 Serial Interface Module
14. DS7447E LCD Keypad
15. DS7447V2 LCD Keypad

Functions

Alarm Verification Option

Central station personnel can verify alarms with a two-way voice session with the premises, or visually through an on-premises camera connected to the optional rvm4c Remote Video Module.

Eight On-board Zones

The DS7220V2 Control Panel has eight on-board zones. It can have hard-wired expanded zones and wireless zones. Program any of these zones to follow one of 15 zone functions.

The DS7220V2 Control Panel also allows configuration using two resistors for each sensor loop. The control panel monitors two zones for each sensor loop, making 16 on-board zones available. Zone doubling is also available on hard-wired expanded zones.

When programming zones for entry or exit delay times, you can choose a longer delay time for zones located a longer distance from the keypad.

Authority Levels and PINs

The system supports 32 Personal Identification Numbers (PIN). The PIN default is four digits, but can range between three and seven digits. Designate an unlimited number of master PINs. Use the master PINs to reprogram existing PINs. Program PINs using up to four different authority levels, which can restrict the PIN from bypassing, testing, and disarming the system.

Locally or Remotely Programmable

The system is completely keypad programmable (DS7447E or DS7447V2 Keypad required). An Installer's Keypad feature is also available that allows quick access to the programming menu.

Remote Programming Software (RPS) is a Windows®-based account management and panel programming and diagnostic utility. It is designed to remotely (or locally using the DX4010i Aux Data pins) set up and program the DS7220V2 Control Panels.

LED and LCD Keypad Support

Keypad	Description
DS7445i LED Keypad DS7445V2 LED Keypad	Provide 16 operating LEDs, and eight system status LEDs that indicate conditions such as armed, fire alarm, and trouble.
DS7446KP LCD Keypad DS7447E LCD Keypad DS7447V2 LCD Keypad	Two-line displays allow custom zone and area descriptions up to 16 characters. The end user can adjust the sounder volume and back-light intensity using easy button commands.

LED and LCD keypads can be used in the same DS7220V2 Control Panel system.

PK32

The DS7220V2 Control Panel has an optional PK32 Programming Key that can copy one control panel's programming to another control panel. This can be used as an installer's template. The installer could store a residential template in one PK32 and a commercial template in another PK32. The on-board LED illuminates when information is sent to or from the key, and blinks when functional diagnostics are performed on the key.

Flexible Digital Communications

The DS7220V2 Control Panel works with most alarm receivers that support Contact ID and SIA 300 digital communicator formats and pager format. The pager format allows control panels to dial a digital pager service and leave a numeric message representing the account number, event number, area number, and zone or user number.

Network Communication Option

Adding a DX4020 Network Interface Module provides bi-directional communications over an Ethernet network. The network can also be used for both remote programming sessions with RPS and central station (ARC) reporting.

Event History Log

A 254-event history log keeps a record of open and close events, alarms, and troubles organized by time and date. View the log information using the DS7447E and DS7447V2 LCD Keypads or RPS. The log also tracks the area, zone (device), user, and communication information relevant to each event. All 254 events are in non-volatile memory.

Scheduled Events (Skeds)

Skeds are programmed events that occur at a specific time of day and day of week. These events include Auto On, Auto Perimeter Only On, Auto Partial On, Auto Off and Sked Output Function. Users can use the Extend Auto On Time function to add an additional hour to the setting for Auto On, Auto Perimeter Only On and Auto Partial On. Depending on the assigned authority level, users can change a sked. Eight skeds are available.

Fire Alarm Verification

The DS7220V2 Control Panel can automatically reset smoke detectors after an initial alarm. If a second alarm occurs within the verification window, an immediate fire alarm results. This reduces potential false alarms, while still providing fast response to an alarm.

Door Access Control Modules (DACMs)

A DACM grants or restricts access through a door using a keypad, credential reader, Request-to-Exit (REX) input, or a door contact. Each DACM replaces one system keypad and supervises one door. The DACM can also function as a stand-alone device.

Zones

The DS7220V2 Control Panel accepts up to 24 zones in any combination of the available on-board zones, hard-wired expanded zones, or wireless zones.

Areas

The DS7220V2 Control Panel can be divided into two independently-configurable areas. Each area can have separate keypads and a separate reporting ID.

Outputs

The DS7220V2 Control Panel has four on-board programmable outputs that can be expanded up to 12.

PO 1: terminals can be configured as an alarm power output. The default configuration for PO 1 makes it a dry contact, Normally-Open (NO) relay.

PO 2: can be used with Alarm + as a supervised siren driver. Connect an approved 4 Ω or 8 Ω speaker. Alternatively, PO 2 can sink up to 500 mA, 12 VDC.

PO 3 and PO 4: can be configured for Alarm Output. These outputs can sink 500 mA, 12 VDC each.

Certifications and Approvals

Region	Certification	
Europe	CE	1999/5/EC, 2006/95/EC, 2004/108/EC; EN 55022:2006 + A1:2007, Class B; EN 50130-4 w/A1:1998 + A2:2003; EN61000-3-2:2006; EN61000-3-3:1995; EN 60950-1:2001; TBR21:1998
Russia	GOST	GOST 12997-84, GOST R MEK 60065-2002, GOST R 50009-2000, GOST R 51317.3.2-99, GOST R 51317.3.3-99
France	AFNOR	NF, A2P (122077-00)
China	CCC	2005031902000137
Sweden	INTYG	Nr05-303
Brazil	ANATEL	1240-05-1855

The DS7220V2 Control Panel is designed to comply with the following certifications, approvals, and standards.

EN50131-1 grade 2

Installation/Configuration Notes

Compatibility Information

Batteries	D126 12 V, 7 Ah Standby Battery D1218 12 V, 18 Ah Standby Battery D1240 12 V, 4 Ah Standby Battery
Keypads	DS7445i LED Keypad DS7445V2 LED Keypad DS7446KP LCD Keypad DS7447E LCD Keypad DS7447V2 LCD Keypad
Fire Detectors	D132A Smoke Detector Reversing Relay DS250 Photoelectric Smoke Detector DS250TH Photoelectric Smoke Detector with heat-sensing thermistor DS284 Photoelectric Smoke Detector DS284TH Photoelectric Smoke Detector with heat-sensing thermistor DS284THS Photoelectric Smoke Detector with heat-sensing thermistor and sounder
Wireless Products	RF280ETHS Wireless Photoelectric Smoke Detector with heat-sensing thermistor and sounder RF835E Wireless TriTech® Detector RF940E Wireless PIR Detector RF1100E RF Glass Break Detector

Batteries

D126 12 V, 7 Ah Standby Battery

RF3227E RF Receiver
RF3332E Two-button Keyfob
RF3334E Four-button Keyfob
RF3401E RF Transmitter
RF3405E RF Inertia Transmitter
RF3501E RF Panic Pendant
RF3503E RF Panic Button

Modules

DACM Door Access Control Module
DX2010 Eight-input Expander
DX2011 Eight-input Expander - D203 Metal Enclosure
DX2012 Eight-input Expander - AE20 Plastic Enclosure
DX3010 Octo-output Expander
DX3020 X-10 Control Module
DX4010 RS-232 Serial Interface Module
DX4010i RS-232 Serial Interface Module
DX4020 Network Interface Module
rvm4c Remote Video Module

Wiring Considerations

- Up to 305 m (1,000 ft) allowed between panel/external power supply and keypad or DACM when using 0.8 mm wire.
- Up to 610 m (2,000 ft) allowed between panel/external power supply and keypad or DACM when using 1.2 mm wire.
- No more than two keypads/DACMs (0.8 mm) or three keypads/DACMs (1.2 mm) are recommended on any 305 m (1,000 ft) run when powered from the panel.

Parts Included

Each standard system includes:

Quantity	Component
1	DS7220V2 control board
1	Universal enclosure
1	Transformer (18 VAC, 50 VA)
1	Hardware/resistor pack

Technical Specifications

Data Bus

Data Bus: 12 VDC nominal

Enclosure

Material: 1.0 mm, cold-rolled steel
Dimensions: 36.8 cm x 31.8 cm x 7.6 cm (14.5 in. x 12.5 in. x 3 in.)

Environmental Considerations

Relative Humidity: 5% to 85% at +30°C (+86°F) non-condensing
Temperature (Operating): 0°C to +49°C (+32°F to +120°F)

Keypads and Door Access Control Module (DACM)

Number supported: 8 maximum in any combination of keypads or DACMs

Power Outputs

Continuous Power: 1.2 A maximum
 Alarm Power: 1.85 A maximum at 11.5 VDC to 12.4 VDC

Power Requirements

Primary Voltage Input: 18 VAC, 50 VA transformer
 Secondary Voltage Input: Two 12 VDC, 7 Ah or 12 VDC, 18 Ah sealed lead-acid rechargeable batteries
 Current Requirements: 100 mA

Telephone Interface

Telephone Interface: Terminal block

Trademarks

Windows[®] is either a registered trademark or trademark of Microsoft Corporation in the United States and/or other countries.

Ordering Information

DS7220V2-BEL Control Panel Dutch language version for Belgium.	DS7220V2-BEL
DS7220V2-EXP Control Panel Export version.	DS7220V2-EXP
DS7220V2-FRA Control Panel French language version.	DS7220V2-FRA
DS7220V2-SPA Control Panel Spanish language version.	DS7220V2-SPA
DS7220V2-UK Control Panel British English language version.	DS7220V2-UK
DS7220V2-SWE Control Panel Swedish language version.	DS7220V2-SWE
DS7220V2-DE Control Panel German language version.	DS7220V2-DE
DS7220V2-IT Control Panel Italian language version.	DS7220V2-IT

DS7240V2 Control Panel



Features

- ▶ Eight on-board zones
- ▶ Eight programmable Skeds
- ▶ RF compatibility
- ▶ Up to 32 users with optional key fob operation available
- ▶ Four programmable authority levels
- ▶ Two communications routing destinations
- ▶ 254 event log
- ▶ Remote-programmable with RPS
- ▶ Optional Door Access Control Module (DACM)
- ▶ Network communication option (LAN/WAN)

The DS7240V2 Control Panel has eight zones expandable to 40, four outputs expandable to 20, and four areas. It is suitable for commercial burglary and residential fire/burglary applications.

System Overview

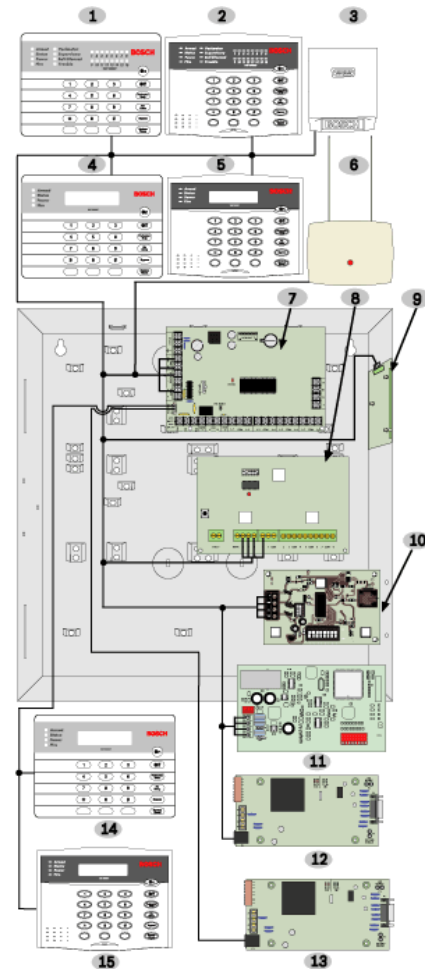

1. DS7445i LED Keypad
2. DS7445V2 LED Keypad
3. Door Access Control Module (DACM)
4. DS7447E LCD Keypad
5. DS7447V2 LCD Keypad
6. RF3227E RF Receiver
7. DS7220V2 Control Panel
8. DX3010 Octo-output Expander
9. DX2010 Input Expander
10. DX3020 X-10 Interface Module
11. DX4020 Network Interface Module
12. DX4010i RS-232 Serial Interface Module
13. DX4010i RS-232 Serial Interface Module
14. DS7447E LCD Keypad
15. DS7447V2 LCD Keypad

Functions

Alarm Verification Option

Central station personnel are able to verify alarms with a two-way voice session with the premises and/or visually through an on-premises camera connected to the optional rvm4c Remote Video Module.

Eight On-board Zones

The DS7240V2 Control Panel has eight on-board zones. It can have hard-wired expanded zones and wireless zones. Program any of these zones to follow one of 15 zone functions.

The DS7240V2 Control Panel also allows configuration using two resistors for each sensor loop. The control panel monitors two zones for each sensor loop, making 16 on-board zones available. Zone doubling is also available on hard-wired expanded zones.

When programming zones for entry or exit delay times, you can choose a longer delay time for zones located a longer distance from the keypad.

Authority Levels and PINs

The system supports 32 Personal Identification Numbers (PIN). The PIN default is four digits, but can range between three and seven digits. Designate an unlimited number of master PINs. Use the master PINs to reprogram existing PINs. Program PINs using up to four different authority levels, which can restrict the PIN from bypassing, testing, and disarming the system.

Locally or Remotely Programmable

The system is completely keypad programmable (DS7447E or DS7447V2 Keypad required). An Installer's Keypad feature is also available that allows quick access to the programming menu.

Remote Programming Software (RPS) is a Windows®-based account management and panel programming and diagnostic utility. It is designed to remotely (or locally using the DX4010i Aux Data pins) set up and program the DS7240V2 Control Panels.

LED and LCD Keypad Support

Keypad	Description
DS7445i LED Keypad DS7445V2 LED Keypad	Provide 16 operating LEDs, and eight system status LEDs that indicate conditions such as armed, fire alarm, and trouble.
DS7446KP LCD Keypad DS7447E LCD Keypad DS7447V2 LCD Keypad	Two-line displays allow custom zone and area descriptions up to 16 characters. The end user can adjust the sounder volume and back-light intensity using easy button commands.

LED and LCD keypads can be used in the same DS7240V2 Control Panel system.

PK32

The DS7240V2 Control Panel has an optional PK32 Programming Key that can copy one control panel's programming to another control panel. This can be used as an installer's template. The installer could store a residential template in one PK32 and a commercial template in another PK32. The on-board LED illuminates when information is sent to or from the key, and blinks when functional diagnostics are performed on the key.

Flexible Digital Communications

The DS7240V2 Control Panel works with most alarm receivers that support Contact ID and SIA 300 digital communicator formats and pager format. The pager format allows control panels to dial a digital pager service and leave a numeric message representing the account number, event number, area number, and zone or user number.

Network Communication Option

Adding a DX4020 Network Interface Module provides bi-directional communications over an Ethernet network. The network can also be used for both remote programming sessions with RPS and central station (ARC) reporting.

Event History Log

A 254-event history log keeps a record of open and close events, alarms, and troubles organized by time and date. View the log information using the DS7447E and DS7447V2 LCD Keypads or RPS. The log also tracks the area, zone (device), user, and communication information relevant to each event. All 254 events are in non-volatile memory.

Scheduled Events (Skeds)

Skeds are programmed events that occur at a specific time of day and day of week. These events include Auto On, Auto Perimeter Only On, Auto Partial On, Auto Off and Sked Output Function. Users can use the Extend Auto On Time function to add an additional hour to the setting for Auto On, Auto Perimeter Only On and Auto Partial On. Depending on the assigned authority level, users can change a sked. Eight skeds are available.

Fire Alarm Verification

The DS7240V2 Control Panel can automatically reset smoke detectors after an initial alarm. If a second alarm occurs within the verification window, an immediate fire alarm results. This reduces potential false alarms, while still providing fast response to an alarm.

Door Access Control Modules (DACMs)

A DACM grants or restricts access through a door using a keypad, credential reader, Request-to-Exit (REX) input, or a door contact. Each DACM replaces one system keypad and supervises one door. The DACM can also function as a stand-alone device.

Zones

The DS7240V2 accepts up to 40 zones in any combination of the available on-board zones, hard-wired expanded zones, or wireless zones.

Areas

The DS7240V2 can be divided into four independently-configurable areas. Each area can have separate keypads and a separate reporting ID.

Area 1 can be programmed as a common area that follows the arming state of all the other areas. The common area arms only when all areas are armed. This allows for protection of shared areas such as foyers and entryways, while still maintaining separate areas.

Outputs

The DS7240V2 has four on-board programmable outputs that may be expanded up to 20.

PO 1: terminals can be configured as an alarm power output. The default configuration for PO 1 makes it a dry contact, Normally-Open (NO) relay.

PO 2: can be used with Alarm + as a supervised siren driver. Connect an approved 4 Ω or 8 Ω speakers. Alternatively, PO 2 can sink up to 500 mA, 12 VDC.

PO 3 and PO 4: can be configured for Alarm Output. These outputs can sink 500 mA, 12 VDC each.

Certifications and Approvals

Region	Certification	
Europe	CE	1999/5/EC, 2006/95/EC, 2004/108/EC; EN 55022:2006 + A1:2007, Class B; EN 50130-4 w/A1:1998 + A2:2003; EN61000-3-2:2006; EN61000-3-3:1995; EN 60950-1:2001; TBR21:1998 EN501-31 Compliance
Russia	GOST	GOST 12997-84, GOST R MEK 60065-2002, GOST R 50009-2000, GOST R 51317.3.2-99, GOST R 51317.3.3-99
France	AFNOR	NF, A2P (122076-00)
China	CCC	2005031902000137
Sweden	INTYG	Nr05-14
Brazil	ANATEL	1240-05-1855

The DS7240V2 Control Panel complies with the following certifications, approvals, and standards.

Country	Certification/Listing Number
Europe	EN50131-1 grade 2
Sweden	SSF 1014

Installation/Configuration Notes

Compatibility Information

Batteries	D126 12 V, 7 Ah Standby Battery
	D1218 12 V, 18 Ah Standby Battery
	D1240 12 V, 4 Ah Standby Battery
Keypads	DS7445i LED Keypad
	DS7445V2 LED Keypad
	DS7446KP LCD Keypad
	DS7447E LCD Keypad
	DS7447i Alpha Numeric Keypad
	DS7447V2 LCD Keypad
Fire Detectors	D132A Smoke Detector Reversing Relay
	DS250 Photoelectric Smoke Detector

DS250TH Photoelectric Smoke Detector with heat-sensing thermistor

DS284 Photoelectric Smoke Detector

DS284TH Photoelectric Smoke Detector with heat-sensing thermistor

DS284THS Photoelectric Smoke Detector with heat-sensing thermistor and sounder

Wireless Products RF280ETHS Wireless Photoelectric Smoke Detector with heat-sensing thermistor and sounder

RF835E Wireless TriTech® Detector

RF940E Wireless PIR Detector

RF1100E RF Glass Break Detector

RF3227E RF Receiver

RF3332E Two-button Key Fob

RF3334E Four-button Key Fob

RF3401E RF Transmitter

RF3405E RF Inertia Transmitter

RF3501E RF Panic Pendant

RF3503E RF Panic Button

Modules DACM Door Access Control Module

DX2010 Eight-input Expander

DX3010 Octo-output Expander

DX3011 Octo-output Expander Package

DX3012 Octo-output Expander Package

DX4010 RS-232 Serial Interface Module

DX4010i RS-232 Serial Interface Module

DX4020 Network Interface Module

RVM4C Remote Video Module

Wiring Considerations

- Up to 305 m (1,000 ft) allowed between control panel external power supply and keypad or DACM when using 0.8 mm wire.
- Up to 610 m (2,000 ft) allowed between panel/external power supply and keypad or DACM when using 1.2 mm wire.
- No more than two keypads or DACMs (0.8 mm) or three keypads/DACMs (1.2 mm) are recommended on any 305 m (1,000 ft) run when powered from the panel.

Parts Included

Each standard system includes:

Quantity	Component
1	DS7240V2 control board
1	Universal enclosure
1	Transformer (18 VAC, 50 VA)
1	Hardware/resistor pack

Technical Specifications

Data Bus

Data Bus: 12 VDC nominal

Enclosure

Material:	1.0 mm, cold-rolled steel
Dimensions:	36.8 cm x 31.8 cm x 7.6 cm (14.5 in. x 12.5 in. x 3 in.)

Environmental Considerations

Relative Humidity:	5% to 85% at +30°C (+86°F) non-condensing
Temperature (Operating):	0°C to +49°C (+32°F to +120°F)

Keypads and Door Access Control Module (DACM)

Number supported:	8 maximum in any combination of keypads or DACMs
-------------------	--------------------------------------------------

Power Outputs

Continuous Power:	1.2 A maximum
Alarm Power:	1.85 A maximum at 11.5 VDC to 12.4 VDC

Power Requirements

Primary Voltage Input:	18 VAC, 50 VA transformer
Secondary Voltage Input:	Two 12 VDC, 7 Ah or 12 VDC, 18 Ah sealed lead-acid rechargeable batteries
Current Requirements:	100 mA

Telephone Interface

Telephone Interface:	Terminal block
----------------------	----------------

Trademarks

Windows® is either a registered trademark or trademark of Microsoft Corporation in the United States and/or other countries.

Ordering Information

DS7240V2-BEL Control Panel Dutch language version for Belgium.	DS7240V2-BEL
DS7240V2-BEF Control Panel French language version for Belgium.	DS7240V2-BEF
DS7240V2-EXP Control Panel Export version.	DS7240V2-EXP
DS7240V2-FRA Control Panel French language version.	DS7240V2-FRA
DS7240V2-DE Control Panel German language version.	DS7240V2-DE
DS7240V2-IT Control Panel Italian language version.	DS7240V2-IT
DS7240V2-NL Control Panel Dutch language version.	DS7240V2-NL
DS7240V2-SPA Control Panel Spanish language version.	DS7240V2-SPA
DS7240V2-SWE Control Panel Swedish language version.	DS7240V2-SWE
DS7240V2-UK Control Panel British English language version.	DS7240V2-UK

DS7400Xi Series Addressable Control Panels



Features

- ▶ Up to 248 zones in up to eight areas
- ▶ 400-event history buffer
- ▶ Up to 200 personal ID numbers (PINs)
- ▶ Up to 112 wireless devices
- ▶ Up to 15 keypads and/or door access control modules (DACMs)
- ▶ Up to 240 addressable points including up to 60 outputs
- ▶ Ethernet network connectivity
- ▶ Remote programming over serial interface, Ethernet network, or phonenumber

The DS7400Xi Series Addressable Control Panels can be programmed for up to eight areas, are keypad or remotely programmable, and have a wide range of features.

Functions

Answering Machine Override

Each control panel model has a built-in answering machine override function. No external hardware is required.

Automatic Arming and Delayed Arming

Program an automatic arming time for each area daily. Use delayed arming to override automatic arm time or to specify a time for the panel to arm.

Common Area Arming

Program one area to follow the arming state of some or all of the other areas. The common area arms only when all areas linked to it are armed, protecting shared areas such as foyers and entry-ways while maintaining separate areas.

Custom Arming Configurations

Program the system to arm in different configurations to automatically bypass a group of zones.

Easy Function Key User Interface

- Six labeled function keys eliminate the need for multi-button commands. Enter a PIN followed by the function key to perform functions such as arming, disarming, and resetting smoke detectors.
- The interface provides new users with easy to follow procedures. Expert users can quickly access items.
- A programmable Quick Arm feature allows users to turn the system on without a PIN. The system requires a PIN to turn off the system, silence alarms, or perform system tests.

EEPROM Technology

The control panel uses electronically erasable programmable read-only memory (EEPROM). The EEPROM retains program memory, system programming, user codes, and the arm/disarm state through a power failure. There is a delay on power restore that prevents false alarms from space sensors that might take several minutes to become operational.

Eight Areas

Divide the control panel into eight separate system areas, each area with its own keypads and reporting ID. Keypads can be programmed as master keypads, allowing access to all areas.

Flexible Digital Communication

The communicator works with most alarm receivers, and supports 3/1, 4/1, 4/2, Contact ID, SIA, BFSK digital communicator formats and pager format. The pager format allows the control to dial a digital pager service and leave a numeric message representing the account number and event code.

Input and Output Cross Matrix

Input and output cross matrix allows output functions to follow the status of specific input zones. Outputs can be programmed to follow any combination of one or two zones, open or closed, with the system armed or disarmed.

LED and Alphanumeric Keypad Support

- **DS7445V2 LED Keypad:** Provides an LED per zone (LEDs 1-8 for main board zones and LEDs 9-16 for expansion zones), and eight system status LEDs that show conditions such as armed, fire alarm, and trouble.
- **DS7445i LED Keypad:** Provides an LED per zone (for main board zones 1-8 only), and eight system status LEDs that show conditions such as armed, fire alarm, and trouble.
- **DS7447V2 Alphanumeric Keypad:** Two line, freely programmable display allows 16 characters of custom text to be programmed for zone and area descriptions. The user can adjust the sounder volume and backlight intensity using easy two-button commands. The DS7447V2 is required for system programming.

Note: LED and LCD keypads may be mixed in the same system.

Octal Relay Modules

The DS7400Xi Series Control Panels support up to two DX3010 Octo-Output Expander Modules. Each module supplies eight relay or solid state outputs to follow system events or to follow programmed Output Functions from the control panel.

Output Functions

Program the output functions to follow system events or to follow one or two specific zones in a cross matrix (see Input and Output Cross Matrix). Output functions can control octal relay outputs or addressable bus outputs.

Programmable from Keypad or Remotely

- The system is completely keypad programmable. No need for expensive handheld programmers.
- RPS-INTL provides remotely programming through an IBM® PC (or IBM compatible) running a Microsoft® Windows® operating system and communicating through a standard Hayes modem. Using an off-site computer to run diagnostics, arm systems, and bypass zones reduces service visits to a premise and provides quick customer assistance.

Smoke Detector Alarm Verification

The DS7400Xi Series Control Panels can automatically reset the smoke detectors following an alarm. If a second alarm occurs within the verification window, an immediate fire alarm occurs, reducing potential false alarms while providing fast response to an alarm.

Two Independent Entry Delays

Program zones to select from one of the two entry delay times. Users can select a longer entry delay time for zones located a long distance from the keypad.

Certifications and Approvals

Region	Certification	
Europe	CE	1999/5/EC, EN60950 Dec 1992 (2nd edition) +A1: 1992 +A2: 1993, EN50081-1: 1992, EN50082-1: 1992
Belgium	INCERT	B-509-0003/a Jan 2004
Sweden	INTYG	DS7400Xi16 only: Nr04-755 Nr04-630

Installation/Configuration Notes

Compatible Products

Category	Product
Keypads	DS7445Vi LED Keypad
	DS7445V2 LED Keypad
	DS7447E LCD Keypad
	DS7447V2 LCD Keypad
Modules	Conettix IP C900V2 Dialer Capture Module
	C900TTL-E Dialer Capture Module
	Conettix IP DX4020 Network Interface Module
	Door Access Control Module (DACM)

Category

Product

	DS7420i Dual Phone Line/Bell Supervision Module
	DS7430 Multiplex Bus Driver Module
	DS7432/E Eight-Input Remote Module
	DS7433/E Eight-Input Direct Module
	DS7436 Addressable Expansion Module
	DS7457i/iF Single-Zone Input Module
	DS7457iE Single-Zone Input Module
	DS7460i Double-Input Module
	DS7461i Single-Input Module
	DS7465i Input/Output Module
	DS7480 Bell Supervision Module
	DS7481 Single Phone Line Monitor
	DS7489 Solid State Output Module
	DX3010 Octo-output Expander
	DX4010i RS-232 Serial Interface Module
Multiplex Detectors	D7050/TH Multiplex Photoelectric Smoke Detector
	MX250/TH Multiplex Photoelectric Smoke Detector
	MX775i Multiplex PIR Intrusion Detector
Intrusion Detectors	MX794i Long-Range Multiplex PIR Detector
	MX934i Multiplex PIR Intrusion Detector
	MX938i Multiplex Intrusion Ceiling Mount Detector
	All conventional Bosch intrusion detectors, including Blue Line, seismic, PIR, TriTech, photoelectric, and Tri-Tech PIR Microwave.
Two-wire and Four-wire Smoke Detectors ¹	Conventional Bosch 12 V smoke, heat, and photoelectric smoke detectors.

¹ Availability varies according to sales regions.

Wiring

Use four-conductor 1.2 mm to 0.8 mm (18 AWG to 22 AWG) cable. The maximum wire length of each sensor loop is 305 m (1000 ft). The maximum multiplex bus wire length per system is 610 m (2000 ft) if using 0.8 mm (#22 AWG) wire or 1525 m (5000 ft) if using 1.0 mm (#18 AWG) wire.

Keypads

No more than two keypads per 305 m (1000 ft) run with a total of no more than 15 keypads in the system.

Technical Specifications

Burglar and Fire Zone Inputs

Number of Circuits:	8 circuits on board
End of Line Resistor:	2.2 + 1.5 kΩ

Environmental Considerations

Operating Temperature:	0°C to +49°C (+32°F to +120°F)
------------------------	-----------------------------------

Fire Signal Initiating Circuit

Fire circuits will work with two-wire or four-wire detectors and have optional alarm verification.

Number of Circuits:	8 circuits on board, expandable to 16
Type of Circuit:	Class B, latching
End of Line Resistor:	2.21 k Ω
Supervisory Current:	5 mA
Minimum Current for Alarm:	12 mA
Maximum Short Circuit Current:	22 mA
Maximum Circuit Resistance:	60 Ω
Circuit Voltage Range:	8.5 VDC to 14.1 VDC
Maximum Impedance for Alarm:	1000 Ω
Maximum Detectors per Zone:	20 detectors (two-wire)
Total Detector Standby Current:	2.5 mA

Lightning Suppression

MOVs and spark gaps provide suppression of lightning surges and static discharges.

Outputs

The system provides three programmable outputs that can be controlled by alarms, access control, ground start, smoke detector reset, or the control's arming state.

Alarm Output:	Normally Open, 1.75 A contact connected to auxiliary power.
Programmable Output 1:	Solid state current sink (1 A maximum). Can be used for alarm, arming state, or access control.
Programmable Output 2:	Solid state voltage source (500 mA maximum). Can be used for alarm, arming state, or access control.

Power Requirements

Input:	18 VAC, 50 VA, 50 Hz or 60 Hz
Total Power Output:	12 VDC, 2.5 A
Keypad Regulated Power:	12 VDC, 1.0 A
UL Listed Auxiliary Power:	12 VDC, 1.0 A
UL Listed Alarm Power Output:	1.75 A

Trademarks

IBM[®] is a registered trademark of IBM in the United States. Microsoft[®] and Windows[®] are either registered trademarks or trademarks of Microsoft Corporation in the United States and other countries.

Ordering Information

DS7400XI-EXP Control Panel For export. Includes a transformer and enclosure.	DS7400XI-EXP
DS7400XI-BEL Control Panel For use in Belgium. Includes a large enclosure. Always has 128 points enabled.	DS7400XI-BEL
DS7400XI-DK Control Panel For use in Denmark.	DS7400XI-DK
DS7400XI-GR Control Panel For use in Greece. Includes an enclosure.	DS7400XI-GR

Ordering Information

DS7400XI-FI Control Panel For use in Finland.	DS7400XI-FI
DS7400XI-FRA Control Panel For use in France.	DS7400XI-FRA
DS7400XI-HU Control Panel For use in Hungary. Includes an enclosure.	DS7400XI-HU
DS7400XI-ITA Control Panel For use in Italy.	DS7400XI-ITA
DS7400XI-NOR Control Panel For use in Norway. Includes an enclosure.	DS7400XI-NOR
DS7400XI-SPA Control Panel For use in Spain.	DS7400XI-SPA
DS7400XI-SWE Control Panel For use in Sweden. Includes an enclosure.	DS7400XI-SWE
DS7400XI-BEL Control Panel Provides 16 zones. For use in Belgium.	DS7400XI16-BEL
DS7400XI16-SWE Control Panel Provides 16 zones. For use in Sweden.	DS7400XI16-SWE

Accessories

AE1 Standard Enclosure (Gray) Standard gray enclosure with keyed lock. Measures 35.6 cm x 31.8 cm x 7.6 cm (14 in. x 12.5 in. x 3 in.).	AE1
AE3 Large Enclosure (Gray) Large gray enclosure with keyed lock. Measures 52.7 cm x 38.1 cm x 10.8 cm (20.7 in. x 15 in. x 4.25 in.).	AE3

DS7446KP Series LCD Keypads



Features

- ▶ **Contemporary vertical design**
- ▶ **Flip door that covers or uncovers the illuminated keys**
- ▶ **Area indicator**
- ▶ **Adjustable volume**
- ▶ **Programmable emergency keys**

The DS7446KP is a four-wire alphanumeric liquid crystal display (LCD) keypad that works with DS7200 Series Control Panels. It supports all system functions. The keypad is required for programming the control panel locally.

Functions

Contemporary Design

The compact vertical design uses less wall space and blends well into surroundings. Close the flip door to protect the keys from dirt and damage, and to conceal the illumination.

Area Indicator

The keypad display can show area icons. The state of the icon (on, fast flash, slow flash, or off) indicates information about an area such as: the area is armed, the area is in alarm, the area has a zone trouble condition, or the area is disarmed. The keypad display can also show the area it is currently assigned to if the keypad is outside its home area.

Indicators and Tones

The keypad display has four light emitting diodes (LEDs) across the faceplate to indicate the status for perimeter, power, arming, and command. The keypad can emit eight tones to indicate a situation such as an alarm, trouble, error, or entry delay.

Programmable Keys

Each DS7446KP Keypad model has 19 illuminated keys for specific functions. Your installing company can program the [A], [B], and [C] keys with functions such as Emergency, Fire, or Panic. When pressed, each key emits a muted beep.

Adjustable Volume

You can adjust the keypad volume. When the sounder is active, pressing any key on the keypad momentarily silences the sounder.

Certifications and Approvals

CE

Built to comply with EN50131 Grades 1, 2, and 3

Installation/Configuration Notes

Compatibility Information

The DS7446KP Keypad works with the DS7200 Series Control Panels.

Wiring Considerations

Wire Type	Keypad Distance from Control Panel
Unshielded, 0.8 mm (#22 AWG)	Up to 305 m (1000 ft)
Unshielded, 1.2 mm (#18 AWG)	Up to 610 m (2000 ft)

Parts Included

Quantity	Component
1	Keypad
1	Wall tamper spring

Technical Specifications

Environmental Considerations

Relative Humidity	80% at 40°C (100°F), non-condensing
Temperature (Operating):	+5°C to +40°C (40°F to 100°F)
Temperature (Storage):	-10°C to +55°C (14°F to 130°F)

Power Requirements

Current (Standby):	35 mA
Current (Alarm):	100 mA
Voltage (Operating):	10.2 VDC

Product Characteristics

Dimensions:	13.7 cm x 7.6 cm x 2.4 cm (5 in. x 3 in. x 1 in.)
Weight:	0.168 kg (0.37 lb)

Ordering Information**DS7446KP-EX LCD Keypad** **DS7446KP-EX**

For export. Provides volume controls and three programmable emergency keys.

DS7446KP-SE LCD Keypad **DS7446KP-SE**

For use in Sweden. Provides volume controls and three programmable emergency keys.

DS7446KP-FR LCD Keypad **DS7446KP-FR**

For use in France. Provides volume controls and three programmable emergency keys.

DS7446KP-NL LCD Keypad **DS7446KP-NL**

For use in the Netherlands. Provides volume controls and three programmable emergency keys.

DS7446KP-DE LCD Keypad **DS7446KP-DE**

For use in Germany. Provides volume controls and three programmable emergency keys.

DS7446KP-ES LCD Keypad **DS7446KP-ES**

For use in Spain. Provides volume controls and three programmable emergency keys.

DS7447V2 Series LCD Keypads



Features

- ▶ Adjustable volume, display brightness, and display contrast
- ▶ Accessible instruction label
- ▶ Programmable emergency keys

The DS7447V2 is a four-wire alphanumeric liquid crystal display (LCD) keypad that works with the DS7060, DS7080iP-32, DS7200 Series, and DS7400Xi Series Control Panels. It supports all system functions. The keypad is required for programming the control panel locally.

Functions

Adjustable Volume and Display

Adjust the non-alarm volume, display brightness, and display contrast at the keypad.

Accessible Instruction Label

Basic user instructions are on a pull-out slide that you can install to pull from either the left or the right.

Programmable Emergency Keys

The three unmarked keys across the bottom row of the keypad are programmable as a fire emergency key, a special emergency key, and a panic key. Adhesive labels are provided.

Certifications and Approvals

Region	Certification	
Europe	CE	1999/5/EC, 2006/95/EC, 2004/108/EC; EN 55022:2006 + A1:2007, Class B; EN 50130-4 w/A1:1998 + A2:2003; EN61000-3-2:2006; EN61000-3-3:1995; EN 60950-1:2001; TBR21:1998 89/336/EEC, EN55022: 1998, EN50130-4: 1995, EN60950: 2000, EN61000-3-2, EN61000-3-3, EN61000-4-2, EN61000-4-3, EN61000-4-4, EN61000-4-5, EN61000-4-6, EN61000-4-11
Belgium	INCERT	B-509-0004/b
All DS7447V2 Keypad Models:	CE	EN50131-1 Grades 1, 2, and 3
DS7447V2-FRA Keypad:		NF A2P Type 2 Certification number: 122000076-01

Installation/Configuration Notes

Compatibility Information

Control Panels DS7060, DS7080iP-32, DS7400Xi Series, DS7200 Series

Wiring and Mounting Considerations

The wire length between the keypad and the control panel cannot exceed 305 m (1000 ft). Do not mount the keypad outdoors.

Number of Keypads	Wire Type	Keypad Distance from Control Panel
Up to two	Unshielded, four-wire, 0.8 mm (#22 AWG)	Up to 305 m (1000 ft)
Up to three	Unshielded, four-wire, 1.2 mm (#18 AWG)	Up to 305 m (1000 ft)

Parts Included

Quant.	Component
1	Keypad assembly
1	Info card slide
2	Info cards
1	Ferrite bead with installation instructions
1	Literature – Installation manual

Technical Specifications

Environmental Considerations

Relative Humidity:	5% to 93% at +32°C (+90°F), non-condensing
Temperature (Operating):	0°C to +50°C (+32°F to +122°F)

Power Requirements

Current Draw:	95 mA idle; 200 mA max (with speaker volume and backlight brightness on)
Voltage (Operating):	12 VDC

Product Characteristics

Dimensions:	12 cm x 21 cm x 2 cm (4.6 in. x 8.2 in. x 0.8 in.)
Weight:	439 g (15.5 oz)

Ordering Information**DS7447V2-EXP LCD Keypad****DS7447V2-EXP**

For export. Provides volume controls, display brightness controls, display contrast controls, and three programmable emergency keys.

DS7447V2-BEL LCD Keypad**DS7447V2-BEL**

For use in Belgium. For export. Provides volume controls, display brightness controls, display contrast controls, and three programmable emergency keys.

DS7447V2-DK LCD Keypad**DS7447V2-DK**

For use in Denmark. Provides volume controls, display brightness controls, display contrast controls, and three programmable emergency keys.

DS7447V2-FI LCD Keypad**DS7447V2-FI**

For use in Finland. Provides volume controls, display brightness controls, display contrast controls, and three programmable emergency keys.

DS7447V2-FRA LCD Keypad**DS7447V2-FRA**

For use in France. Provides volume controls, display brightness controls, display contrast controls, and three programmable emergency keys. NF A2P Type 2 Certification number: 122000076-01.

DS7447V2-DE LCD Keypad**DS7447V2-DE**

For use in Germany. Provides volume controls, display brightness controls, display contrast controls, and three programmable emergency keys.

DS7447V2-GR LCD Keypad**DS7447V2-GR**

For use in Greece. Provides volume controls, display brightness controls, display contrast controls, and three programmable emergency keys.

DS7447V2-HU LCD Keypad**DS7447V2-HU**

For use in Hungary. Provides volume controls, display brightness controls, display contrast controls, and three programmable emergency keys.

DS7447V2-IT LCD Keypad**DS7447V2-IT**

For use in Italy. Provides volume controls, display brightness controls, display contrast controls, and three programmable emergency keys.

DS7447V2-NL LCD Keypad**DS7447V2-NL**

For use in the Netherlands. Provides volume controls, display brightness controls, display contrast controls, and three programmable emergency keys.

Ordering Information**DS7447V2-NOR LCD Keypad****DS7447V2-NOR**

For use in Norway. Provides volume controls, display brightness controls, display contrast controls, and three programmable emergency keys.

DS7447V2-SPA LCD Keypad**DS7447V2-SPA**

For use in Spain. Provides volume controls, display brightness controls, display contrast controls, and three programmable emergency keys.

DS7447V2-SWE LCD Keypad**DS7447V2-SWE**

For use in Sweden. Provides volume controls, display brightness controls, display contrast controls, and three programmable emergency keys.

DS7447E Series LCD Keypads

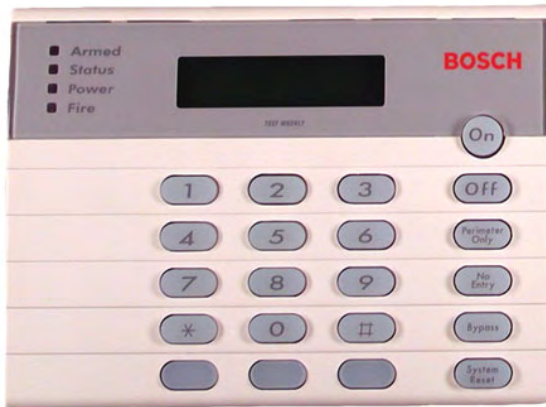

Features

- ▶ Controls for volume, display brightness, and display contrast
- ▶ Easily-accessible instruction label
- ▶ Three programmable emergency keys

The DS7447E is a four-wire alphanumeric LCD keypad that can be used with the DS7060, DS7080iP-32, DS7200 Series, and DS7400Xi Series Control Panels. It supports all system functions. The keypad is required for local programming of the control panel. The keypad can be mounted on a surface or on standard single- or double-gang boxes, or four-inch square boxes.

Functions

Controls for Volume and Display

The non-alarm volume, display brightness, and display contrast are easily adjusted at the keypad.

Easily-accessible Instruction Label

Basic user instructions are located in a pull-out slide that can be installed to pull from either the left or the right.

Three Programmable Emergency Keys

The three unmarked keys across the bottom row of the keypad are programmable as a fire emergency key, a special emergency key, and a panic key. Adhesive labels are provided for use if the keys are programmed.

Certifications and Approvals

Region	Certification	
Europe	CE	1999/5/EC, 2006/95/EC, 2004/108/EC; EN 55022:2006 + A1:2007, Class B; EN 50130-4 w/A1:1998 + A2:2003; EN61000-3-2:2006; EN61000-3-3:1995; EN 60950-1:2001; TBR21:1998 DS7447E: 89/336/EEC, EN55022: 1998, EN50130-4: 1995, EN60950: 2000, EN61000-3-2, EN61000-3-3, EN61000-4-2, EN61000-4-3, EN61000-4-4, EN61000-4-5, EN61000-4-6, EN61000-4-11
USA	UL	DS7447E: AMCX: Central Station Alarm Units (UL1610, UL1635), AOTX: Local Alarm Units (UL464, UL609), APAX: Police Station Alarm Units (UL365, UL464), APOU: Proprietary Alarm Units (UL1076), NBSX: Household Burglar Alarm System Units (UL1023), UOXX: Control Unit Accessories, System (UL864, 9th edition), UTOU: Control Units and Accessories - Household System Type (UL985)

Installation/Configuration Notes

Compatibility Information

Control Panels DS7060, DS7080iP-32, DS7400Xi Series, DS7240V2 and DS7220V2 Series

Wiring

The wire length between the keypad and the control panel must be no more than 305 m (1000 ft). Up to two keypads can be placed along any single 305 m (1000 ft) run of 0.8 mm (22 AWG) non-shielded, quad (four-wire) cable. Three keypads can be used on any single 305 m (1000 ft) run of 1.2 mm (18 AWG) non-shielded, quad (four-wire) cable.

Note Do not mount outdoors.

Commercial Fire Applications

The DS7447E can be used in commercial fire applications with the DS7400Xi Control Panels as follows:

- **Single Keypad Use in Commercial Fire Systems:** The keypad must be used on the keypad bus and must be assigned as keypad address 1. It can be mounted on the front of the control enclosure. If it is not mounted on the front of the control enclosure, you must mount it in the same room as and within 6 m (20 ft) of the control equipment, and run the wire in conduit or provide equivalent protection against mechanical damage).

- **Multiple Keypad Use in Commercial Fire Systems:** One keypad must be used on the keypad bus and must be assigned as keypad address 1. It can be mounted on the front of the control enclosure. If it is not mounted on the front of the control enclosure, you must mount it in the same room as and within 6 m (20 ft) of the control equipment, and run the wire in conduit or provide equivalent protection against mechanical damage. Connect keypads 2 through 10 to the keypad bus and place as needed within the wiring limits. Use only one keypad on the option bus and assign it as keypad address 11, 12, 13, or 14.

- Note** Keypad 15 is not available on commercial fire systems because Option Bus Address 15 is used for the DS7420i Dual Phone Line/Bell Supervision Module.
- Note** On the DS7400Xi Control Panels, up to 11 keypads can be used in commercial fire mode. Install one keypad on the option bus and up to ten keypads on the keypad bus.
- Note** When using multiple keypads in a commercial fire application, a UL Listed auxiliary power supply might be required.

Technical Specifications

Environmental Considerations

Relative Humidity:	5% to 93% at +32°C (+90°F), non-condensing
Temperature (Operating):	0°C to +50°C (+32°F to +122°F)

Power Requirements

Current Draw:	95 mA idle; 200 mA max (with speaker volume and backlight brightness at maximum)
Voltage (Operating):	12 VDC

Product Characteristics

Dimensions:	12 cm x 21 cm x 2 cm (4.6 in. x 8.2 in. x 0.8 in.)
Weight:	439 g (15.5 oz)

Ordering Information

DS7447E LCD Keypad Provides volume controls, display brightness controls, display contrast controls, and three programmable emergency keys.	DS7447E
DS7447E-EXP LCD Keypad For export. Provides volume controls, display brightness controls, display contrast controls, and three programmable emergency keys.	DS7447E-EXP
DS7447E-BEL LCD Keypad For use in Belgium. Provides volume controls, display brightness controls, display contrast controls, and three programmable emergency keys.	DS7447E-BEL
DS7447E-ITA LCD Keypad For use in Italy. Provides volume controls, display brightness controls, display contrast controls, and three programmable emergency keys.	DS7447E-ITA
DS7447E-SWE LCD Keypad For use in Sweden. Provides volume controls, display brightness controls, display contrast controls, and three programmable emergency keys.	DS7447E-SWE

DS7445V2 Series LED Keypads



Features

- ▶ Adjustable volume
- ▶ Accessible instruction label
- ▶ Programmable emergency keys

The DS7445V2 is a four-wire light emitting diode (LED) keypad that works with the DS7060, DS7080iP-32, DS7200 Series, and DS7400Xi Series Control Panels.

The DS7445V2 has 16 LEDs representing the first 16 detector groups in the keypad area. Different control panels can operate a different number of the LEDs.

Functions

Adjustable Volume

Adjust the non-alarm volume at the keypad.

Accessible Instruction Label

Basic user instructions are on a pull-out slide that you can install to pull from either the left or the right.

Programmable Emergency Keys

The three unmarked keys across the bottom row of the keypad are programmable as a fire emergency key, a special emergency key, and a panic key. Adhesive labels are included.

Certifications and Approvals

Region	Certification	
Europe	CE	89/336/EEC, EN55022: 1998, EN50130-4: 1995, EN60950: 2000, EN61000-3-2, EN61000-3-3, EN61000-4-2, EN61000-4-3, EN61000-4-4, EN61000-4-5, EN61000-4-6, EN61000-4-11 1999/5/EC, 2006/95/EC, 2004/108/EC; EN 55022:2006 + A1:2007, Class B; EN 50130-4 w/A1:1998 + A2:2003; EN61000-3-2:2006; EN61000-3-3:1995; EN 60950-1:2001; TBR21:1998
Belgium	INCERT	DS7445V2: B-509-004/b
Russia	GOST	DS7445V2-RU: GOST 12997-84, GOST R MEK 60065-2002, GOST R 50009-2000, GOST R 51317.3.2-99, GOST P 51317.3.3-99
Europe		Conforms to EN50131 Grade 1

Installation/Configuration Notes

Compatibility Information

Control Panel	Number of Operating LEDs on DS7445V2 Keypad
DS7080iP-32 and DS7400Xi Series Control Panels	8
DS7060 Control Panel	6
DS7220V2 and DS7240V2 Series Control Panels	16

Wiring and Mounting Considerations

Number of Keypads	Wire Type	Keypad Distance from Control Panel
Up to two	Unshielded, four-wire, 0.8 mm (#22 AWG)	Up to 305 m (1000 ft)
Up to three	Unshielded, four-wire, 1.2 mm (#18 AWG)	Up to 305 m (1000 ft)

The wire length between the keypad and the control panel cannot exceed 305 m (1000 ft). Do not mount the keypad outdoors.

Parts Included

Quant.	Component
1	Keypad assembly
1	Info card slide
2	Info cards
1	Ferrite bead with installation instructions
1	Literature – Installation manual

Technical Specifications

Environmental Considerations

Relative Humidity: 5% to 93% at +32°C (+90°F), non-condensing

Temperature (Operating): 0°C to +50°C (+32°F to +122°F)

Power Requirements

Current Draw: 95 mA idle; 200 mA max (with speaker volume and backlight brightness on)

Voltage (Operating): 12 VDC

Product Characteristics

Dimensions: 12 cm x 21 cm x 2 cm
(4.6 in. x 8.2 in. x 0.8 in.)

Weight: 439 g (15.5 oz)

Ordering Information

DS7445V2-EXP LED Keypad

DS7445V2-EXP

For export. Provides has 16 LEDs representing the first 16 detector groups in the keypad area.

DS7445V2-BEL LED Keypad

DS7445V2-BEL

For use in Belgium. Provides has 16 LEDs representing the first 16 detector groups in the keypad area.

DS7445V2-FRA LED Keypad

DS7445V2-FRA

For use in France. Provides has 16 LEDs representing the first 16 detector groups in the keypad area.

DS7445V2-DE LED Keypad

DS7445V2-DE

For use in Germany. Provides has 16 LEDs representing the first 16 detector groups in the keypad area.

DS7445V2-IT LED Keypad

DS7445V2-IT

For use in Italy. Provides has 16 LEDs representing the first 16 detector groups in the keypad area.

DS7445V2-NL LED Keypad

DS7445V2-NL

For use in the Netherlands. Provides has 16 LEDs representing the first 16 detector groups in the keypad area.

DS7445V2-NOR LED Keypad

DS7445V2-NOR

For use in Norway. Provides has 16 LEDs representing the first 16 detector groups in the keypad area.

DS7445V2-RU LED Keypad

DS7445V2-RU

For use in Russia. Provides has 16 LEDs representing the first 16 detector groups in the keypad area.

DS7445V2-SPA LED Keypad

DS7445V2-SPA

For use in Spain. Provides has 16 LEDs representing the first 16 detector groups in the keypad area.

DS7445V2-SWE LED Keypad

DS7445V2-SWE

For use in Sweden. Provides has 16 LEDs representing the first 16 detector groups in the keypad area.

DS7445i Series LED Keypads



Features

- ▶ **Easily-accessible instruction label**
- ▶ **Three programmable emergency keys**

The DS7445i is a four-wire LED keypad that can be used with the DS7060, DS7080iP-32, DS7200 Series, and DS7400Xi Series Control Panels. The keypad can be mounted on a surface or on standard single- or double-gang boxes, or four-inch square boxes.

The DS7445i has 16 LEDs representing up to eight hard-wired zones and eight expansion zones. The eight hard-wired zones on the DS7080iP-32 Control Panel are represented by the first eight LEDs (the next eight LEDs do not operate). When using the DS7060 6-Zone Control Panel, only the first six LEDs operate.

Functions

Easily-accessible Instruction Label

Basic user instructions are located in a pull-out slide that can be installed to pull from either the left or the right.

Three Programmable Emergency Keys

The three unmarked keys across the bottom row of the keypad are programmable as a fire emergency key, a special emergency key, and a panic key. Adhesive labels are provided for use if the keys are programmed.

Certifications and Approvals

Region	Certification	
Europe	CE	1999/5/EC, 2006/95/EC, 2004/108/EC; EN 55022:2006 + A1:2007, Class B; EN 50130-4 w/A1:1998 + A2:2003; EN61000-3-2:2006; EN61000-3-3:1995; EN 60950-1:2001; TBR21:1998
Belgium	INCERT	DS7445i: B-509-004/b

Installation/Configuration Notes

Compatibility Information

Control Panel	Number of Operating LEDs on DS7445V2 Keypad
---------------	---------------------------------------------

DS7080iP-32 and DS7400Xi Series Control Panels	8
------------------------------------------------	---

DS7060 Control Panel	6
----------------------	---

DS7220V2 and DS7240V2 Series Control Panels	16
---------------------------------------------	----

Wiring

The wire length between the keypad and the control panel must be no more than 1000 ft (305 m). Up to two keypads can be placed along any single 1000 ft (305 m) run of 22 AWG (0.8 mm) non-shielded, quad (four-wire) cable. Three keypads can be used on any single 1000 ft (305 m) run of 18 AWG (1.2 mm) non-shielded, quad (four-wire) cable.

Note Do not mount outdoors.

Commercial Fire Applications

The DS7445i can be used in commercial fire applications with the DS7400Xi Series Control Panels as follows:

- **Single Keypad Use in Commercial Fire Systems:** The keypad must be used on the keypad bus and must be assigned as keypad address 1. It can be mounted on the front of the control enclosure. If it is not mounted on the front of the control enclosure, you must mount it in the same room as and within 20 ft (6 m) of the control equipment, and run the wire in conduit or provide equivalent protection against mechanical damage.
- **Multiple Keypad Use in Commercial Fire Systems:** One keypad must be used on the keypad bus and must be assigned as keypad address 1. It can be mounted on the front of the control enclosure. If it is not mounted on the front of the control enclosure, you must mount it in the same room as and within 20 ft (6 m) of the control equipment, and run the wire in conduit or provide equivalent protection against mechanical damage. Connect keypads 2 through 10 to the keypad bus and place as needed within the wiring limits. Use only one keypad on the option bus and assign it as keypad address 11, 12, 13, or 14.

Note Keypad 15 is not available on commercial fire systems because Option Bus Address 15 is

used for the DS7420i Dual Phone Line/Bell Supervision Module.

Note On the DS7400Xi Control Panels, up to 11 keypads can be used in commercial fire mode. Install one keypad on the option bus and up to ten keypads on the keypad bus.

Note When using multiple keypads in a commercial fire application, a UL Listed auxiliary power supply might be required.

Technical Specifications

Environmental Considerations

Relative Humidity: 5% to 93% at +90°F (+32°C), non-condensing

Temperature (Operating): +32°F to +122°F (0°C to +50°C)

Power Requirements

Current Draw: 95 mA idle; 200 mA max (with speaker volume and backlight brightness at maximum)

Voltage (Operating): 12 VDC

Product Characteristics

Dimensions: 12 cm x 21 cm x 2 cm
(4.6 in. x 8.2 in. x 0.8 in.)

Weight: 15.5 oz. (439 g)

Ordering Information

DS7445i-EXP LED Keypad **DS7445i-EXP**

For export. Provides 16 LEDs representing up to eight hard-wired zones and eight expansion zones.

DS7445i-BEL LED Keypad **DS7445i-BEL**

For use in Belgium. Provides 16 LEDs representing up to eight hard-wired zones and eight expansion zones.

DS7445i-FRA LED Keypad **DS7445i-FRA**

For use in France. Provides 16 LEDs representing up to eight hard-wired zones and eight expansion zones.

DS7445i-ITA LED Keypad **DS7445i-ITA**

For use in Italy. Provides 16 LEDs representing up to eight hard-wired zones and eight expansion zones.

DS7445i-SWE LED Keypad **DS7445i-SWE**

For use in Sweden. Provides 16 LEDs representing up to eight hard-wired zones and eight expansion zones.

UEZ 2000/1 LSN, UEZ 2000 LSN, Intrusion Control Centers



Features

- ▶ Up to 6 UEZ LSNs can be networked with system loop technology (SRT)
- ▶ Fire alarm peripheral elements can be connected in the LSN loop
- ▶ 4 loop or 8 stub lines with UEZ 2000/1 LSN
- ▶ Max. 254 LSN elements with UEZ 2000/1 LSN
- ▶ 8 loop or 16 stub lines with UEZ 2000 LSN
- ▶ Max. 508 LSN elements with UEZ 2000 LSN
- ▶ TeleService capability

The UEZ LSNs are intrusion control centers designed for monitoring medium-sized properties (monitoring area 6000 to 12,000 m² depending on specification).

The emergency call peripheral elements are connected via the LSN (Local Security Network).

Both systems are equipped with an LVM 100.

- The UEZ 2000/1 LSN **cannot** be extended with an additional LVM 100.
- The UEZ 2000 LSN can be extended with an additional LVM 100.

System Overview

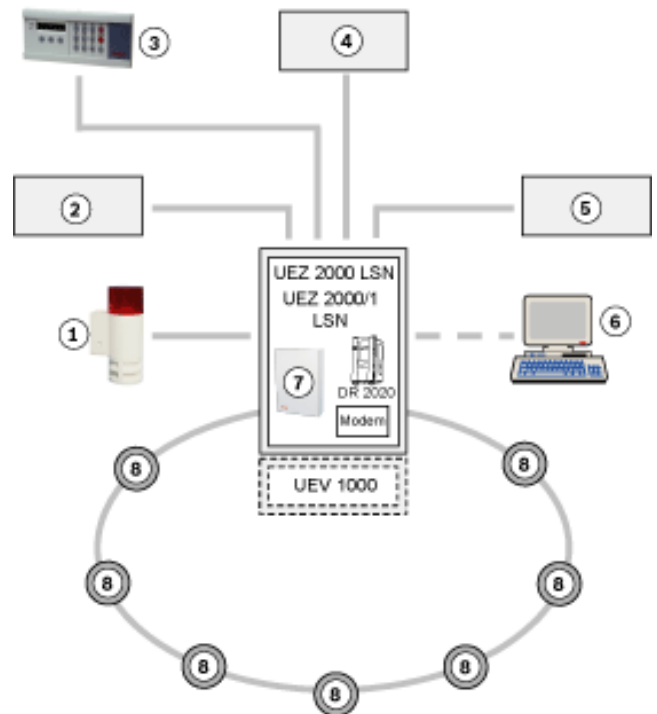

- 1 External signaling devices
- 2 ATBL activation panel
- 3 IUI-UEZ-BE1000s keypad
- 4 Priority Bosch control center
- 5 Transmission unit (ÜE)
- 6 Programmable PC
- 7 Receiver / communicator
- 8 LSN elements

Functions

A combined operation of fire and emergency call is possible within the framework of the control unit. In addition, a combination of various LSN elements on an LSN line is possible.

False alarm protection is provided by an internal program: Alarm delay and/or dual detector/cross zoning (only with smoke detectors).

Full functionality is maintained on the loop in the event of short-circuit or interruption.

Encrypted data transmission is possible for the priority Bosch control panel or in the SRT loop.

Message processing

In the LVM 100 line processing module, the information from all LSN elements is scanned cyclically, and processed and digitized by the line processors on the LVM. Information prepared in this way is transmitted via interfaces from the line processing units to the ZVM 100 central processing module; at that point it is analyzed and generated as a message, for example to a display/operating panel, recording device, priority Bosch control panel, etc.

Message display and operation

The integrated operating unit (ADT) or a remote operating panel can be used to process incoming messages and operate the system.

Saving messages

A log printer can be integrated to record messages. Up to 1000 events can be stored in an event database.

System loop technology (SRT)

- Up to 6 control panels in one SRT loop (UEZ 2000 and/or UEZ 2000)
- Central or decentralized assignment as required
- Cost-effective networking using standard cabling (4-wire) up to 1000 m
- Greater coverage via modem or fiber optic cable
- High level of operating reliability through fault-tolerant operation in the event of a line short-circuit or interruption
- Malfunction message reported to all systems to aid in malfunction localization
- One or more transmitters can be integrated into the cluster as required
- All information is available at each control panel
- Complete simultaneous operation is possible and permitted on all control panels
- Up to 508 detector zones
- Up to 2032 LSN elements
- Built-in operating panel and printer (optional) per control panel
- Up to 4 remote BE 1000 operating panels per control panel
- Encrypted data transmission in the SRT loop
- Up to 48 LSN loops or 96 stubs or a combination of both with the **UEZ 2000 LSN SRT**

Additional function with the UEZ 2000 LSN

The UEZ 2000 LSN can also be equipped with an additional LVM 100. This increases the connection potential to 8 loop or 16 stub lines and/or a max. of 508 connectable LSN elements.

Certifications and Approvals

Region	Certification	
Europe	CE	UEZ 2000 LSN UEZ 2000 LSN A2
Germany	VdS-S	S 184507, B NMZ 300 H S 196602, B NMZ 1000 B S 196001, C NMZ 1000 C S 17370, C NMZ 300
	VdS	G 197009, C UEZ 2000 N

Installation/Configuration Notes

- One-man test
- Automatic service request in the event of detector contamination
- 127 detector zones
- 99 detectors per detector zone (not VdS)
- 32 detector area

- 5 fixed and 19 variable control panel C points

Internal and external expansion options

Components	Number	Short description
Internal extension		
SEMO1	1	Module with 2 serial interfaces and SEZU (encrypted data transmission)
AT 2000	1	Dial-up modem for transmitting information via the telephone network to a monitoring station and/or TeleService
DIP	1	Switching an internal program on or off from multiple independent points
NRK-N	2	For 230 V switching outputs; C point activation
TRSP	1	Integration of up to 5 x TRN
SIV	1	For additional monitored protection of users connected to the UEZ 2000 LSN
LSA+	1	Additional connection strip
ASE	1	For connecting 2 x 2 BES in parallel, can be plugged into AVM 100
TRN	6	For zero-potential outputs of control panel functions; can be plugged into AVM 100
RTP	6	For zero-potential outputs of 4 control panel functions each; can be plugged into AVM 100
SM 20	5	Interface module for 20 mA interface; for connecting a printer, UGM 2020, RUBIN 2020NT or BoVis NT
SM24	3	Interface module for V.24 interface; for connecting UGM 2020, RUBIN 2020NT, Bovis NT or SRT
SM 485	1	Interface module for RS-485 interface, for connecting 4 x BE 1000
Printer	1	Message logging
ATE 100 LSN	1	Parallel display of 32 detector zones (can be installed in operating panel)
Key switch	8 or 1 and 6	With 2 activation settings With 3 switch setting options (1-0-2) in the operating panel With 2 switch settings
12 V/10 Ah battery	2	Uninterrupted power supply (UPS) to the system

External extension

External signaling device	8	Up to 8 independently activated BESs can be connected via ASE and NSB 100
ATBL	8	For connecting remote display panels, each with 64 outputs
Transmission equipment (VdS)	1	For transmitting emergency call alarms to a receiving center
SD	1	Connection is made at the AVM 100
UEV 1000	1	For additional energy requirements; contains one 12 V/5.4 A power supply unit and 2 12 V/40 Ah batteries

SRT system parameters

Signaling devices	32 per system, max. 99 in the cluster
Transmission equipment	48 in the cluster
Auto dialer	1 per system
Printer	1 per system
Timer channels	9 per system
BE 1000 operating unit	4 per system
Priority control panel	2 per system
Alarm counter	2 per system
Event database	1 per system
Internal programs	14 in cluster
User ID	Up to 255 in cluster
Monitoring texts	Up to 20 in cluster
Alarm texts	Up to 40 in cluster
System short texts	Up to 300 in cluster
Detector short texts (location)	2032 in cluster
Hold-up camera	6 per system
Partitions	32 in cluster

Creating loop and stub lines**Basic version with 1 x LVM 100**

(4 loops or 8 stubs or any preferred combination of the two)

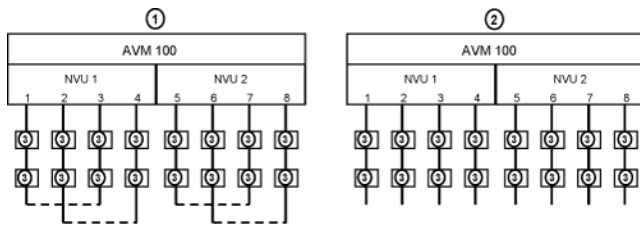
**Extension with second LVM 100 (only with UEZ 2000 LSN)**

(Additional 4 loops or 8 stubs or any preferred combination of the two)

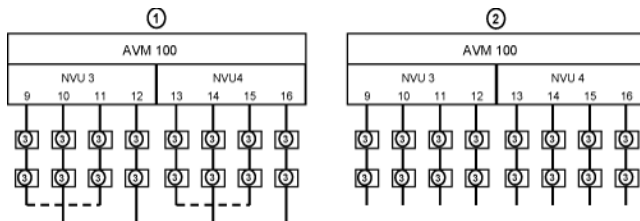

- 1 Loop connection
- 2 Stub connection
- 3 LSN elements

NVU parameters: 2 loops or 4 stubs, up to 1000 m in cable length, up to 100 mA current consumption, up to 127 LSN elements

Quantity structure for the SRT system cluster with UEZ 2000 LSN**Maximum number of detectors**

Number of systems	1	2	3	4	5	6
	508	1016	1524	2032	2032	2032

Maximum number of detector zones

Number of systems	1	2	3	4	5	6
	127	256	381	508	508	508

Module quantity structure in UEZ 2000 LSN emergency call SRT

Loops	Quantity structure				
	UEZ 2000	LVM 100	SEMO	SM20*	SM24*
4	1				
8	1	1			
12	2	1	2	4	4
16	2	2	2	4	4
20	3	2	3	6	6
24	3	3	3	6	6
28	4	3	4	8	8
32	4	4	4	8	8
36	5	4	5	10	10
40	5	5	5	10	10
44	6	5	6	12	12
48	6	6	6	12	12

*Either a modem or a fiber optics converter is required in addition to the SM 24

Note The limit values for each NVU or LVM 100 must be observed.

Note For mixed configurations, the number of SM20 and SM24 modules required changes (increases or decreases).

Parts Included

Qty.	UEZ 2000/1 LSN	UEZ 2000 LSN
1	AVM 010 Connection of the lines and internal connection board of ZVM 100, LVM 100, SEMO1, ASE, RTP, TRN, SM 20 and SM 485 modules	AVM 100 Connection board for connecting all detector and peripheral elements and internally linking the ZVM 100, LVM 100, SEMO1, ASE, RTP or TRN, SM 20 or SM 485 modules
	Housing cover Metal, secured with a lock and a tamper contact including document bag	
	Wall frame Metal, basic version	
	ZVM 100 Analysis of the LVM 100 and SEMO1 modules, processing of the operating panel, surveillance and control of the peripherals	
	LVM 100 Line processor for connecting 4 loop or 8 stub lines	
	ADT Display keyboard with 8-line graphic display	
	Key switch With 3 programmable switch settings (1-0-2)	
	Power supply unit 12 V/5.4 A	

Technical Specifications

Housing	
• Dimensions (H x W x D)	• 763 x 523 x 300.5 mm
• Color	Light gray
• Color of front parts	NCS1502 R (pale gray)
• Weight incl. power pack without battery	23 kg
Environmental conditions	
• Operating temperature	-5 °C to +45 °C
• Storage temperature	-20 °C to +60 °C
• Housing protection type	IP 40
Power supply	
• Power supply unit	12 V/5.4 A
• Line voltage	230 V/50 Hz
• Operating voltage	11 V to 15 V
• Battery capacity	2 x 38 Ah
• Backup time	Max. 60 hours
• Current consumption	To calculate the power requirement, please use the applicable version of UEZ Pro
2-4 loop version (2000 m cable length)	1.1 A
4-8 loop version (4000 m cable length)	1.85 A
Transmission equipment	
Principle	Zero-potential contact with standby state ON

External signaling devices	
• Principle	Pole reversal
• Line voltage	Approx. 2.8 V to 3.6 V
• Control voltage	12/24 V
• Terminal resistance	12.1 kOhm
• Activation Acoustics/optics	1 - 180 s/continuous
System interfaces	
Serial signaling interface	
• V.24 range	Max. 25 m
• Range 20 mA interface	Max. 1000 m
• Modem range	20 km with attenuation < 20 dB
Interface for remote operating panels	
RS-485 interface	
• Range	Max. 500 m
LSN technology	
• Line voltage	Approx. 30 V
• Line current per NVU	Max. 100 mA
• Subscribers per NVU	Up to 127 (depending on current consumption)
• Loop network with 2 LVMS	Max. of 8 loops or 16 stubs up to 4000 m

Ordering Information

UEZ 2000/1 LSN Intrusion Control Center	4998116570
For monitoring medium-sized properties, high security through LSN technology features with LVM 100 for connecting 4 loop or 8 stub lines	
UEZ 2000 LSN Intrusion Control Center	3002120270
For monitoring medium-sized properties, high security through LSN technology features with LVM 100 for connecting 4 loop or 8 stub lines, can be extended by an additional LVM 100 for connecting a further 4 loop or 8 stub lines	
Accessories	
LVM 100 Line Extension	3902120280
For extending the UEZ 2000 LSN for connecting an additional 4 loops or 8 stub lines	
Code EPROM for SEMO1	3002185970
For use of SEMO1 interfaces outside VS zone	
SM 20 Interface Module	SM 20
For connecting DR 500 T/AV, BE 500, UGM 2020 or RUBIN	
Enclosure for UEZ	2799381000
With dimensions 1200 x 800 x 400 mm (incl. base H = 100 mm)	
AT mounting kit in UEZ 2000/BZ 500	3902130725
For installation of an AT 2000 installation module in UEZ 2000 LSN or BZ 500 LSN	
DIP module	3002104150
For dynamic switching of the internal program	
RTP Panel Relay Module	RTP
four relays, each relay with a double-throw contact for potential-free outputs	

NZ 300 LSN Hold-up and Intrusion Control Panel



Features

- ▶ **8 detection areas**
- ▶ **8 keypads**
- ▶ **4 inter programs**
- ▶ **1 LSN loop or 2 LSN stubs with 127 LSN elements and up to 140 detector addresses**
- ▶ **Identification of individual detectors**
- ▶ **All connected switch outputs freely programmable**
- ▶ **Simple programming with NzPara**
- ▶ **Integrated AWUG (dialing modem)**
- ▶ **TeleService-compliant**
- ▶ **40 users**

The NZ 300 LSN emergency call control panel and the BE 300 LSN keypad ensure a high level of flexibility and reliability.

This is achieved through use of the local security network LSN. A characteristic feature of the local security network LSN is that the detectors and control elements of a security system are all connected to the control panel with a single transmission unit, making efficient use of cables and ensuring compliance with regulations.

The BE 300 LSN remote keypad is deployed for operation, for signaling alarms and for displaying the status.

The NZ 300 LSN is TeleService-compliant.

System Overview

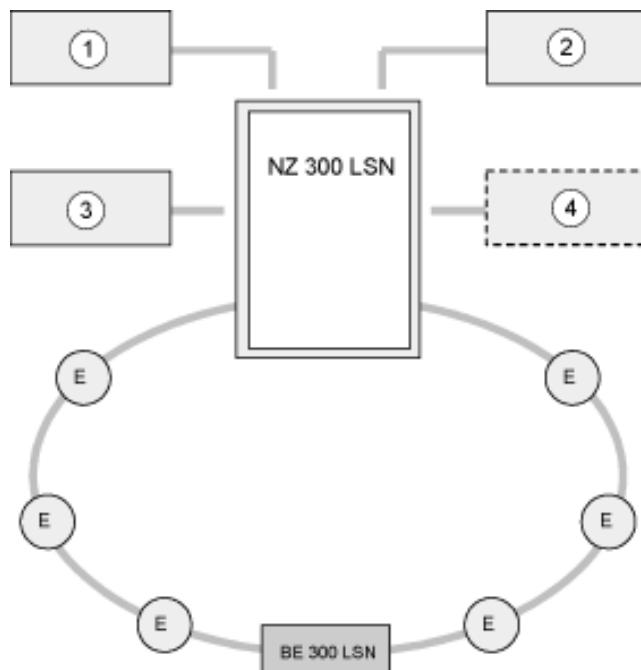

- 1 Telephone network
- 2 Transmission unit
- 3 External signaling device
- 4 Configuration PC
- E LSN element

Functions

- The BE 300 LSN keypad acts as a remote display/control panel for the NZ 300 LSN. The BE 300 LSN is built into an LSN loop or LSN stub. Up to eight BE 300 LSN units can be connected.
- Assistance providers can be informed alternatively via:
 - Transmission units (ÜE)
 - Integrated dialing modems (AWUG)
 - Integrated dialers or communicators such as AT 2000 (built-in or housing-on-housing)
 - 2 x acoustic and 1 x optical external warning devices (local alarm signaling).
- The following switch outputs are available:
 - Switch output for faults (1 x fault relay)
 - Switch output for alarms (1 x ÜE relay)
 - Freely programmable switch output (1 x relay)
 - Freely programmable control panel points (2 x open collector outputs)
- Up to 8 detection areas can be programmed with the NZ 300 LSN. Only detection area 1 can be the main area or control panel area. The areas are defined when programming the NZ 300 LSN.
- Four internal detection areas (4 inter-programs) can be formed by allocating detectors (freely programmable). Each area can be "internally activated" on an individual basis.

- The NZ 300 LSN is equipped with an event database for the last 1024 events. All alarms, malfunctions, deactivations and control panel resets are stored. The events, which are saved together with the date and time, can be shown on the display of the BE 300 LSN or using a PC. In addition, a print-out can be produced via a PC.

Certifications and Approvals

Region	Certification	
Europe	CE	NZ 300 LSN
Germany	VdS-S	S 188709, A NMZ 300 A
		S 184507, B NMZ 300 H
		S 196602, B NMZ 1000 B
	VdS	S 196001, C NMZ 1000 C
		G 100070, C NZ 300 LSN
	G 101806, A AWUG-NZ 300	
	G 105079, C Zentralenumschrank NZ300/NZ500	

Installation/Configuration Notes

Energy balance

The energy balance is determined according to VDE 0833 and created using the "uezpro" planning and current calculation program. The limits of the NZ 300 LSN are automatically calculated and displayed.

The integrated power supply can be used to charge batteries with a capacity of up to 34 Ah. The max. power supply unit current (battery current + standby current) is 2.4 A. The bridging time is max. 60 hours.

For additional remote power supply, the NEV 300 LSN power supply can also be used.

LSN planning

Applications/requirements	NZ 300 LSN
Allocation of loops and stub lines.	1 x loop or max. 2 x stubs possible. Using loop lines is recommended because loop lines provide greater security than stub lines.
Combining LSN expansion modules and LSN detectors.	It is possible to combine LSN expansion modules and LSN detectors on a loop or stub line.
Combining automatic and non-automatic LSN detectors.	Combining automatic and non-automatic LSN detectors is possible.
Connecting conventional detectors.	To connect conventional emergency call detectors, use the NNK 100 LSN expansion module and 4 DC primary lines, or the KD 55-1 LSN with 2 primary lines.

Power supply +V/0 V	When calculating the cable length +V/0 V of the NNK 100 LSN and NVK 100 LSN expansion modules, it is important to note that LSN expansion modules require a minimum power supply of 9 V.
Connecting LSN elements (E) ¹ .	Max. 127 LSN elements (depending on current requirement).
Input addresses ² .	Max. 140
Output addresses ³ .	Max. 64
Permissible current	Max. 100 mA LSN line voltage
Length of line	Max. 1000 m for loops Max. 1000 m for stubs in total

- LSN elements (E) are LSN expansion modules, LSN detectors etc.
- Input addresses for detectors, expansion modules, activation units etc.
- Output addresses of e.g. LEDs.

Arming devices

The following arming devices can be deployed in conjunction with the NZ 300 LSN: SmartKey, block-type lock, key switch (only contact key switches), BE 300 LSN (user code).

The block-type lock must be connected using the NVK 100 LSN expansion module. The key switch can be connected at any expansion module input. The key switch should be positioned in the vicinity of a BE 300 LSN, in order to ensure that the activation/deactivation process can be monitored.

The SmartKey key administration is performed at the control panel via NzPara with max. 40 SmartKey keys.

Parts Included

Type	Qty.	Component
NZ 300 LSN	1	Case and connection circuit board with integrated dialing modem (AWUG) and power supply unit

Technical Specifications

Approval for telecommunications device CE 0682

Housing

- Dimensions (H x W x D) 460 x 380 x 97 mm
- Color Light gray/RAL 7035
- Weight (excl. batteries) 2 kg
- Weight (incl. batteries) 15 kg

Environmental conditions	
• Ambient temperature (in operation)	-5 °C to +45 °C
• Storage and transport temperature	-20 °C to +60 °C
• Environmental class	II (VdS 2110)
• Housing protection category	IP 40
Electromagnetic compatibility (EMC)	
• Interference immunity	DIN EN 50130-4
• Interference emissions	DIN EN 50081-1
Power supply	
• Protection class	I (DIN VDE 0106 Part 1)
• Mains voltage	230 V
• Mains frequency	50 Hz
• Power supply unit	12 V/2.4 A
• Output voltage	13.2 V at 50 °C to 14.5 V at 0 °C
• Battery capacity	12 V/2 x 17 Ah
• Backup time	Min. 60 hrs
• Current consumption	180 mA
The max. power supply unit current (battery charge current + standby current) is 2.4 A.	
LSN technology	
• Line voltage	Approx. 30 V
• LSN line current (loop or, if stubs are used, in total)	Max. 100 mA
• Cable network	1 loop with max. 1000 m or 2 stubs with max. 1000 m in total
Transmission unit	
• Principle	Zero potential operating contact
• Contact load	30 W/1 A
• Activation time	3–180 sec, continuous
External signaling devices	
• Principle	Pole reversal
• Line voltage	Approx. 6 V
• Terminal resistance	12.1 kilohm
• Activation time	3–180 sec, continuous
Transmission protocol AWUG	
• Telephone network	Analog
• Procedure/protocol	Telim
• Telephone/ID numbers	max. 4
Serial interface	
• V.24 range	Max. 25 m
• Transmission speed	9600 bit/sec
• Transmission protocol	VdS 2465
Switch outputs central panel points	
• Principle	Open collector (short-circuit resistant)
• Max. voltage	11 V to 15 V
• Maximum current	100 mA

Switch output fault relay	
• Principle	Zero potential operating contact
• Contact load	30 W/1 A
• Activation time	3–180 sec, continuous
Switch output free relay	
• Principle	Standby contact
• Contact load	30 W/1 A
• Activation time	3–180 sec, continuous

Ordering Information

NZ 300 LSN Hold-up and Intrusion Control Panel **4998031142**

For monitoring small objects, high security through LSN technology features, housing and connector board with integrated dialing modem (AWUG) and power supply unit

Accessories

Cabinet for NZ 500/NZ 300 **4998014116**

For installing the control panel in a protected area, 760 x 600 x 210 mm

Mounting kit AT 2000 in NZ 300 LSN **4998068041**

For installing an AT 2000 installation module in NZ 300 LSN

28 V voltage converter **4998108857**

For installation in NZ 300 LSN, from 12 V to 28 V, max. output current 2 x 0.3 A at 28 V

BE 300 LSN remote operating unit **4998031457**

For displaying and executing operating states and functions of the NZ 300 LSN

NEV 300 LSN power supply **4998111983**

For additional power supply to LSN control panels, housing incl. 12 V/4.0 A power supply unit, a maximum of two 12 V/17 Ah batteries can be used

BE 300 LSN remote operating unit



The BE 300 LSN keypad acts as a remote display/control panel for the NZ 300 LSN. The BE 300 LSN is integrated into an LSN loop or LSN stub.

Up to eight BE 300 LSN units can be connected.

The display/control panel consists of: buzzer to signal alarm, general displays (LEDs) for alarms, faults and operation. Clear text display with 2 lines each of 16 alphanumerical characters (illuminated in event of dialogue) to show all current reports and information.

Keyboard operation.

Certifications and Approvals

Region	Certification	
Europe	CE	BE 300 LSN
Germany	VdS	G 100070, C NZ 300 LSN

Technical Specifications

Operating voltage		
• LSN part		+15 V to +31 V
• Control center		+9.6 V to +30 V
Current consumption		
• LSN part		2.9 mA
• Control center		20 mA standby/50 mA with illumination
Tamper surveillance		Tamper contact
Environmental conditions		
• Operating temperature		-5 °C to +45 °C
• Storage temperature		-20 °C to +60 °C
• Housing protection category		IP 40

Housing	
• Material	ABS
• Color	RAL 9010
Dimensions (H x W x D)	112 x 162 x 29 mm
Weight	0.25 kg

Ordering Information

BE 300 LSN remote operating unit	4998031457
For displaying and executing operating states and functions of the NZ 300 LSN	

Accessories for Control Panels and Keypads

2

Expansion Modules	68
Interface Modules	82
Door Access Control Modules	91
Enclosures	98
Power Supplies and Batteries	100
Cables, Switches, and Programmers	110
Control Center and Keypad Accessories	111

DX2010 Series Input Expander

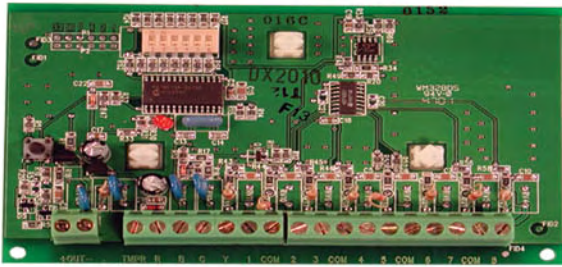

Features

- ▶ Up to eight sensor input loops
- ▶ Directly connects to the control panel data bus

The DX2010 Input Expander connects directly to the data bus of a compatible control panel. Each expander adds eight input loops. Install up to five expanders in a control panel's enclosure (three on the interior sidewalls and two on the back wall of the enclosure).

Certifications and Approvals

Region	Certification	
Europe	CE	DX2010: 1999/5/EC, 2006/95/EC, 2004/108/EC; EN 55022:2006 + A1:2007, Class B; EN 50130-4 w/ A1:1998 + A2:2003; EN61000-3-2:2006; EN61000-3-3:1995; EN 60950-1:2001; TBR21:1998
Belgium	INCERT	DX2010 and DX2012 only
USA	UL	DX2010: AMCX: Central Station Alarm Units (UL1610, UL1635), AMTB: Control Panels, SIA False Alarm Reduction, AOTX: Local Alarm Units (UL464, UL609), APAW: Police Station Alarm Units (UL365, UL464), APOU: Proprietary Alarm Units (UL1076), NBSX: Household Burglar Alarm System Units (UL1023), UTOU: Control Units and Accessories - Household System Type (UL985)
	CSFM	DX2010: 7167-1615: 183 and 7167-1615: 223 July 2008
France	AFNOR	NF, A2P Type 2 (122000076-03)

Installation/Configuration Notes

Compatibility Information

Control Panels	Easy Series (ICP-EZM2-NA, ICP-EZM2-UK, ICP-EZM2-LC), D4412, D6412, DS7220V2, and DS7240V2
----------------	-------------------------------------------------------------------------------------------

Technical Specifications

Outputs

Outputs:	100 mA, 12 VDC supervised output for accessories
----------	--------------------------------------------------

Environmental Considerations

Operating Temperature:	0°C to +50°C (+32°F to +122°F)
Relative Humidity:	5% to 85% at +30°C (+86°F), non-condensing

Loop

Inputs:	Up to eight inputs Input contacts may be normally-open (NO) or normally-closed (NC) with appropriate end-of-line resistor(s) for supervision.
---------	--------------------------------------------------------------------------------------------------------------------------------------------------

Resistance:	60Ω maximum
Terminal Wire Size:	1.8 mm (14 AWG) to 0.8 mm (22 AWG)

Power Requirements

Current (Maximum):	35 mA standby 35 mA maximum with connected accessories
Voltage (Operating):	8 VDC to 14 VDC

Ordering Information

DX2010 Input Expander Provides hard-wired expansion for an additional eight input points. Includes the DX2010 board.	DX2010
DX2011 Package Includes a DX2010 Input Expander with a D203 Metal Enclosure.	DX2011
DX2012 Package Includes a DX2010 Input Expander with an AE20 Plastic Enclosure.	DX2012
Accessories	
AE20 Universal Plastic Enclosure Mounts to a single gang/double gang box, a 9 cm (3.5 in.) octagonal box, or a 10 cm (4 in.) square box. The dimensions are 12 cm x 16 cm x 4 cm (4.7 in. x 6.2 in. x 1.5 in.). Accommodates wall tamper switches on the modules.	AE20
D203 Enclosure	D203

DX3010 Series Octo-output Expander



Features

- ▶ Up to eight fully programmable and individual operating outputs
- ▶ Remotely mount in a D203 enclosure

The DX3010 Octo-output Expander connects directly to the data bus of a compatible control panel. Each expander adds eight fully programmable Form C relay outputs. Each output operates individually from the other seven outputs for complete flexibility. Install up to three expanders in a control panel enclosure.

Certifications and Approvals

Region	Certification	
Europe	CE	DX3010: 1999/5/EC, 2006/95/EC, 2004/108/EC; EN 55022:2006 + A1:2007, Class B; EN 50130-4 w/ A1:1998 + A2:2003; EN61000-3-2:2006; EN61000-3-3:1995; EN 60950-1:2001; TBR21:1998
Belgium	INCERT	DX3010 only
USA	UL	DX3010: AMCX: Central Station Alarm Units (UL1610, UL1635), AMTB: Control Panels, SIA False Alarm Reduction, AOTX: Local Alarm Units (UL464, UL609), APAW: Police Station Alarm Units (UL365, UL464), APOU: Proprietary Alarm Units (UL1076), NBSX: Household Burglar Alarm System Units (UL1023), UTOU: Control Units and Accessories - Household System Type (UL985)
	CSFM	DX3010: 7167-1615: 183 July 2008
France	AFNOR	NF, A2P Type 2 (122000076-04)

Installation/Configuration Notes

Compatibility Information

Control Panels D4412, D6412, and CC7240-A

Technical Specifications

Outputs

Outputs: Dry contacts, rated 5.0 A at 28 VDC (maximum for resistive loads)

Environmental Considerations

Operating Temperature: 0°C to +50°C (+32°F to +122°F)

Relative Humidity: 5% to 85% at +30°C (+86°F), non-condensing

Loop

Terminal Wire Size: 1.8 mm (14 AWG) to 0.8 mm (22 AWG)

Power Requirements

Current (Maximum): 10 mA, + 40 mA for each energized relay

Voltage (Operating): 8 VDC to 14 VDC

Ordering Information

DX3010 Octo-output Expander **DX3010**
Package includes only the DX3010 board.

DX3011 Package **DX3011**
Includes a DX3010 Octo-output Expander with a D203 Metal Enclosure.

DX3012 Package **DX3012**
Includes a DX3010 Octo-output Expander with an AE20 Plastic Enclosure.

Accessories

AE20 Universal Plastic Enclosure **AE20**
Mounts to a single gang/double gang box, a 9 cm (3.5 in.) octagonal box, or a 10 cm (4 in.) square box. The dimensions are 12 cm x 16 cm x 4 cm (4.7 in. x 6.2 in. x 1.5 in.). Accommodates wall tamper switches on the modules.

D203 Enclosure **D203**

DS7430 Multiplex Expansion Module



The DS7430 is a Multiplex Expansion Module for use with the DS7400Xi Series control panels. It connects directly to the control panel and provides a two-wire multiplex bus for the connection of up to 120 multiplex sensors and interface modules.

Certifications and Approvals

Region	Certification	
Europe	CE	89/336/EEC, EN55022: 1998, EN50130-4: 1995, EN60950: 2000, EN61000-3-2, EN61000-3-3, EN61000-4-2, EN61000-4-3, EN61000-4-4, EN61000-4-5, EN61000-4-6, EN61000-4-11 1999/5/EC, EN60950 Dec 1992 (2nd edition) +A1: 1992 +A2: 1993, EN50081-1: 1992, EN50082-1: 1992
Belgium	INCERT	
USA	UL	AMCX: Central Station Alarm Units (UL1610, UL1635), AOTX: Local Alarm Units (UL464, UL609), APAX: Police Station Alarm Units (UL365, UL464), NBSX: Household Burglar Alarm System Units (UL1023), UTOU: Control Units and Accessories - Household System Type (UL985)
	NYC-MEA	274-93-E, Vol. III 274-93-E, Vol. III 274-93-E, Vol. IV 274-93-E, Vol. IV

Installation/Configuration Notes

Compatibility Information

Control Panels DS7400Xi Series

Powering Modules and Detectors

The Bus Power output is for connection of separately powered multiplex devices, such as the DS7432 Eight-input Remote Module. If using separate powered detectors, they should be powered from the auxiliary power terminals of the control panel.

Wiring

Up to 610 m (2000 ft) of 0.8 mm (22 AWG) or 1525 m (5000 ft) of 1.2 mm (18 AWG) wire may be used for the multiplex loop. Do not use shielded cable. Do not share cable with the keypad lines.

Technical Specifications

Outputs

Current (DC Bus):	200 mA
Current (MUX Bus):	75 mA

Power Requirements

Current Required:	65 mAh Standby or Alarm
-------------------	-------------------------

Ordering Information

DS7430 Multiplex Expansion Module	DS7430
Provides a two-wire multiplex bus for connecting up to 120 multiplex sensors and interface modules to the DS7400Xi Series Control Panels.	

DS7432 Series Eight-input Remote Modules

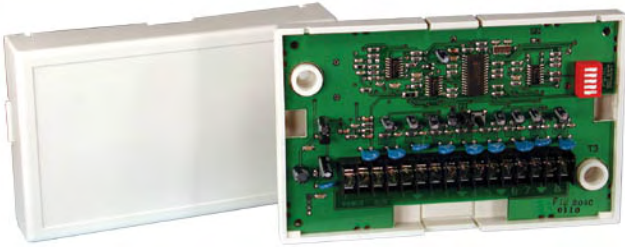

Features

- ▶ Address up to eight input loops
- ▶ Serial dual end-of-line (EOL) wiring with tamper status (DS7432E)

The DS7432 Series Eight-input Remote Modules include the DS7432 and the DS7432E. Both modules address up to eight input loops of conventional contacts to the multiplex bus of the control panel. The DS7432E has an additional serial dual end-of-line (EOL) wiring configuration. The DS7432E addresses up to sixteen input contacts (alarm and tamper for each loop). The DS7432 uses one 47 k Ω resistor per input. The DS7432E uses 22 k Ω + 47 k Ω per input.

Certifications and Approvals

Region	Certification		
Europe	CE	DS7432	
		DS7432E	
Belgium	INCERT		
USA	UL	DS7432: AMCX: Central Station Alarm Units (UL1610, UL1635), AOTX: Local Alarm Units (UL464, UL609), APAW: Police Station Alarm Units (UL365, UL464), NBSX: Household Burglar Alarm System Units (UL1023), UOXX: Control Unit Accessories, System (UL864, 9th edition), UTOU: Control Units and Accessories - Household System Type (UL985)	
		CSFM	DS7432: 7165-1615: 113, 7165-1615: 119, 7170-1615: 144, and 7170-1615: 145
		NYC-MEA	DS7432: 274-94-E, Vol. IV DS7432: 274-94-E, Vol. III

Installation/Configuration Notes

Compatibility Information

The DS7432 Series modules can only connect to the following control panels with an attached multiplex expansion module.

Control Panels	D9412GV2 Control Panel
	D7412GV2 Control Panel
	D9412G Control Panel
	D7412G Control Panel
	DS7400XiV4 Control Panel
	DS7400Xi Control Panel
Multiplex Modules	D8125MUX Multiplex Bus Interface
	DS7430 Multiplex Expansion Module
	DS7436 Multiplex Expansion Module

Note

The DS7432E is compatible with the D9412GV2, D9412G, D7412GV2, and D7412G when the PCB jumper is set to DS7432 mode.

Number of Modules

The number of DS7432 Series Modules connected to a system depends on the control panel.

Control Panel	Number of Multiplex Expansion Modules
DS7400Xi	Up to 15
DS7400XiV4	Up to 30
D9412GV2, D9412G	Up to 30
D7412GV2, D7412G	Up to 8

Wiring

Refer to the multiplex expansion module's reference guide for multiplex wiring requirements.

Maximum Impedance: 4.05 Ω at +20°C (+68°F) nominal

Distance (approximate)	Size
76 m	0.65 mm
193 m	1.02 mm
250 ft	22 AWG
600 ft	18 AWG

The recommended wiring to the control panel is quad (four-wire) cable. Do not use shielded or twisted pair cable.

Note

If used in fire applications, 18 AWG wire is required.

Parts Included

Quantity	Component
1	Eight-input remote module
1	Literature pack

Technical Specifications

Circuit Parameters

Initiating Device Type:	Class B, Style A
-------------------------	------------------

Signaling Line Circuit Type:	Class B, Style 4
------------------------------	------------------

Environmental Considerations

Temperature (operating):	0°C to +50°C (+32°F to +122°F)
--------------------------	--------------------------------

Power Requirements

Current Draw:	10 mA maximum
---------------	---------------

DS7432 EOL Resistor:	47 kΩ
----------------------	-------

DS7432E EOL Resistor:	22 kΩ+47 kΩ per input
-----------------------	-----------------------

Voltage:	12 VDC nominal
----------	----------------

Ordering Information

DS7432E Eight-Input Remote Module

DS7432E

Includes serial dual end-of-line (EOL) wiring configuration. Addresses up to sixteen input contacts (alarm and tamper for each loop).

DS7433 Series Eight-input Modules

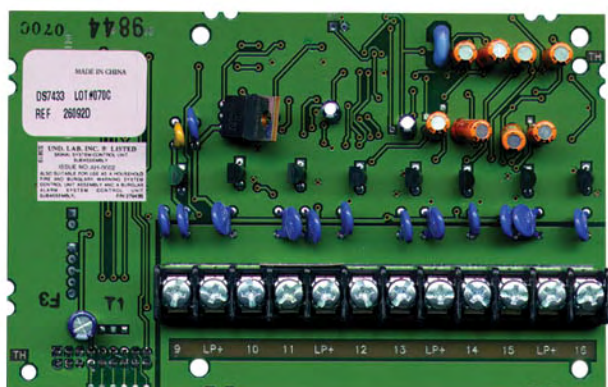

Features

- ▶ Expand up to 16 hard-wired control panel points
- ▶ Compatible with DS7400Xi Series Control Panels

The DS7433 Series Eight-input Modules include the DS7433 and the DS7433E. The modules connect to DS7400Xi Series Control Panels and expand them to supervise sixteen hard-wired points. Use expansion points nine to 16 to connect normally-open (N/O) or normally-closed (N/C) alarm contacts. The expansion points can also be used with compatible two-wire smoke detectors. Use one module per DS7400Xi system.

Functions

Selectable End-of-Line (EOL) Resistor Mode for DS7433E

A jumper located on the printed circuit board (PCB) selects single or serial dual EOL resistor mode for the DS7433E.

Certifications and Approvals

Region	Certification
Europe	CE DS7433: 1999/5/EC, EN60950 Dec 1992 (2nd edition) +A1: 1992 +A2: 1993, EN50081-1: 1992, EN50082-1: 1992 DS7433E: 89/336/EEC, EN55022: 1994 +A1: 1995 +A2: 1997 Class A, EN50130-4: 1995 +A1: 1998 +A2: 2003, EN60950-1: 2001, EN61000-3-2: 2000, EN61000-3-3: 1995 +A1: 2001
Belgium	INCERT

Region	Certification
USA	UL DS7433: AMCX: Central Station Alarm Units (UL1610, UL1635), AOTX: Local Alarm Units (UL464, UL609), APAW: Police Station Alarm Units (UL365, UL464), NBSX: Household Burglar Alarm System Units (UL1023), UTOU: Control Units and Accessories - Household System Type (UL985) NYC-MEA DS7433: 274-93-E, Vol. III 274-93-E, Vol. III DS7433: 274-93-E, Vol. IV 274-93-E, Vol. IV

Installation/Configuration Notes

Compatibility Information

Compatible Panels DS7400Xi Series

Technical Specifications

Power Requirements

Current Draw:	<ul style="list-style-type: none"> • 65 mA standby • 80 mA with one point in alarm • Add 15 mA for each additional point in alarm
---------------	--------------------------------------------------------------------------------------------------------------------------------------------------------------------

DS7433 EOL Resistor:	2.21 k Ω
DS7433E EOL Resistor:	<ul style="list-style-type: none"> • 2.2 kΩ • 2.2 kΩ + 1.5 kΩ
Loop Impedance:	60 Ω maximum
Voltage (Operating):	12 VDC nominal

Ordering Information

DS7433E Eight-Input Module

Expands DS7400Xi Series Control Panels to supervise sixteen hard-wired points. Use one module per DS7400Xi system. Provides selectable end-of-line (EOL) resistor mode.

DS7433E

DS7436 Multiplex Expansion Module

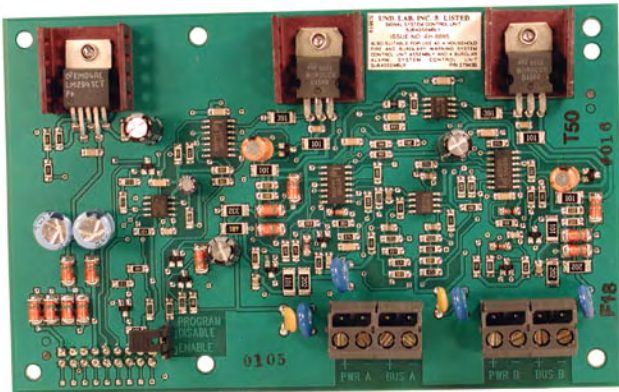

The DS7436 is a two-loop Multiplex Expansion Module for use with the DS7400Xi Series Control Panels. It connects directly to the DS7400Xi board and provides a two-wire multiplex bus for the connection of up to 120 remote points. Each bus is isolated so that failure in one bus will not cause failure in the other.

Certifications and Approvals

Region	Certification
Europe	CE 89/336/EEC, EN55022: 1998, EN50130-4: 1995, EN60950: 2000, EN61000-3-2, EN61000-3-3, EN61000-4-2, EN61000-4-3, EN61000-4-4, EN61000-4-5, EN61000-4-6, EN61000-4-11
Belgium	INCERT
USA	UL AMCX: Central Station Alarm Units (UL1610, UL1635), AOTX: Local Alarm Units (UL464, UL609), APAW: Police Station Alarm Units (UL365, UL464), NBSX: Household Burglar Alarm System Units (UL1023), UTOU: Control Units and Accessories - Household System Type (UL985)

Installation/Configuration Notes

Compatibility Information

Control Panels DS7400Xi Series

Powering Modules and Detectors

The Bus Power output is for connection of separately powered multiplex devices, such as the DS7432 Eight-input Remote Module. If using separate powered detectors, they should be powered from the auxiliary power terminals of the control panel.

Wiring

Up to 610 m (2000 ft) of 0.8 mm (22 AWG) or 1525 m (5000 ft) of 1.2 mm (18 AWG) wire may be used for the multiplex loop. Do not use shielded cable. Do not share cable with the keypad lines.

Technical Specifications

Outputs

Current (DC Bus):	200 mA per bus
Current (MUX Bus):	75 mA per bus

Power Requirements

Current Required:	130 mAh Standby or Alarm
-------------------	--------------------------

Ordering Information

DS7436 Multiplex Expansion Module DS7436

Connects directly to the DS7400Xi Control Panel and provides a two-wire multiplex bus for connecting up to 120 remote points.

DS7457i Series Single Zone Input Modules



Features

- ▶ Power-limited and supervised input zones
- ▶ Compact enough to fit within most back boxes and enclosures
- ▶ Address settings through DIP switches

The DS7457i Series Single Zone Input Modules includes the DS7457i and the DS7457iF. Each model has a supervised input zone for connecting normally-open (NO) or normally-closed (NC) contacts. The DS7457i Series supervises the contacts using 47 kΩ end-of-line(EOL) resistors. Each model operates with compatible multiplex expansion modules and occupies one multiplex zone address on the system. The DS7457i is designed for intrusion applications while the DS7457iF is designed for fire applications.

Certifications and Approvals

Region	Certification	
Europe	CE	DS7457iF: 89/336/EEC, EN55022: 1998, EN50130-4: 1995, EN60950: 2000, EN61000-3-2, EN61000-3-3, EN61000-4-2, EN61000-4-3, EN61000-4-4, EN61000-4-5, EN61000-4-6, EN61000-4-11
USA	UL	Both models: AMCX: Central Station Alarm Units (UL1610, UL1635), AOTX: Local Alarm Units (UL464, UL609), APAW: Police Station Alarm Units (UL365, UL464) DS7457iF only: NBSX: Household Burglar Alarm System Units (UL1023), UOXX: Control Unit Accessories, System (UL864, 9th edition), UTOU: Control Units and Accessories - Household System Type (UL985)
	CSFM	DS7457iF only: 7165-1615: 113, 7165-1615: 199, 7170-1615: 144, and 7170-1615: 145 July 2008

Installation/Configuration Notes

Compatibility Information

Control Panels	D9412GV2, D7412GV2, and D7212GV2 Control Panel D9412G, D7412G, and D7212G Control Panels D9412, D7412, and D7212 Control Panels DS7400Xi Control Panel
Multiplex Modules	D8125MUX Multiplex Bus Interface DS7430 Multiplex Expansion Module DS7436 Multiplex Expansion Module

The DS7457i Series Modules require a multiplex expansion module to connect to the control panels.

Wiring Considerations

Maximum Impedance: 4.05 Ω at +20°C (+68°F) nominal

Distance (approximate)	Size
76 m	0.65 mm
193 m	1.02 mm
250 ft	22 AWG
600 ft	18 AWG

Refer to the intended control panel's installation guide for multiplex wiring requirements.

The recommended wiring to the control panel is quad (four-wire) cable. Do not use shielded or twisted pair cable.

Note If used in fire applications, 18 AWG wire is required.

Parts Included

Quantity Component

1	Single-zone input module
1	Literature pack

Technical Specifications

Circuit Parameters

Initiating Circuit Type (DS7457iF):	Class B (Style A)
-------------------------------------	-------------------

Signaling Line Circuit Type:	Class B (Style 4)
------------------------------	-------------------

Environmental Considerations

Temperature (Operating):	0°C to +49°C (+32°F to +120°F)
--------------------------	--------------------------------

Power Requirements

Current Draw:	0.5 mA maximum
---------------	----------------

Voltage (Operating):	8 VDC peak (minimum)
----------------------	----------------------

Ordering Information

DS7457i Single Zone Input Module **DS7457i**

Connects normally-open (NO) or normally-closed (NC) contacts, and supervises the contacts using 47 kΩ end-of-line(EOL) resistors. Designed for intrusion applications.

DS7457iF Single Zone Input Module **DS7457iF**

Connects normally-open (NO) or normally-closed (NC) contacts, and supervises the contacts using 47 kΩ end-of-line(EOL) resistors. Designed for fire applications.

DS7457iE Single Zone Input Module



Features

- ▶ Power-limited and supervised input zones
- ▶ Compact enough to fit within most backboxes and enclosures
- ▶ Address settings through DIP switches

The DS7457iE is a Single Zone Input Module designed for intrusion applications. It has a dual-resistor supervised input zone for connecting normally-open (NO) or normally-closed (NC) contacts. The DS7457iE controls the contacts using 22k Ω +47k Ω resistors for serial dual end-of-line (EOL) wiring. Each DS7457iE operates with compatible multiplex expansion modules and occupies one multiplex zone address on the system.

Certifications and Approvals

Region	Certification
Europe	CE 89/336/EEC, EN55022: 1998, EN50130-4: 1995, EN60950: 2000, EN61000-3-2, EN61000-3-3, EN61000-4-2, EN61000-4-3, EN61000-4-4, EN61000-4-5, EN61000-4-6, EN61000-4-11

Installation/Configuration Notes

Compatibility Information

Control Panels	DS7400Xi Control Panel
Multiplex Modules	DS7430 Multiplex Expansion Module DS7436 Multiplex Expansion Module

Wiring Considerations

Refer to the intended control panel's installation guide for multiplex wiring requirements. The recommended wiring to the control panel is four-wire 0.8 mm cable. Do not use shielded or twisted pair cable.

Note The length of the wiring connected to the protection loop (and tamper loop) must be less than 76 m.

Technical Specifications

Environmental Considerations

Temperature (Operating): 0°C to +49°C

Power Requirements

Current Draw: 0.5 mA Standby and alarm

Voltage (Operating): 8 VDC peak (minimum)

Circuit Parameters

Zone Response Time: 400 ms

Ordering Information

DS7457iE Single Zone Input Module **DS7457iE**

Designed for intrusion applications. Includes a dual-resistor supervised input zone for connecting normally-open (NO) or normally-closed (NC) contacts.

DS7460i Dual-zone Input Module



Features

- ▶ Supervises two protection loops
- ▶ Can be used in UL Listed fire and security applications
- ▶ DIP switch programmable

The DS7460i Dual-zone Input Module works with compatible multiplex systems, uses two multiplex zone addresses, and monitors up to two separate zones. It is DIP switch programmable and provides two supervised input zones to connect conventional normally-open (NO) or normally-closed (NC) contacts.

Functions

Supervises Two Protection Loops

The two protection zones are designed to monitor NO or NC dry contacts. They are supervised using 47 kΩ end-of-line (EOL) resistors.

Zone 1 may be used as a magnetic contact by mounting a magnet in conjunction with the reed switch and removing the EOL resistor for Zone 1. Zone 1 may not be used as a magnetic contact and used to monitor other contacts at the same time.

Certifications and Approvals

Region	Certification	
Europe	CE	89/336/EEC, EN55022: 1998, EN50130-4: 1995, EN60950: 2000, EN61000-3-2, EN61000-3-3, EN61000-4-2, EN61000-4-3, EN61000-4-4, EN61000-4-5, EN61000-4-6, EN61000-4-11
USA	UL	NBSX: Household Burglar Alarm System Units (UL1023), UOXX: Control Unit Accessories, System (UL864, 9th edition), UTOU: Control Units and Accessories - Household System Type (UL985)
	CSFM	7165-1615: 113, 7165-1615: 119, 7170-1615: 144, and 7170-1615: 145 July 2008

Installation/Configuration Notes

Compatibility Information

Control Panels	D9412GV2, D7412GV2, and D7212GV2 Control Panel
	D9412G, D7412G, and D7212G Control Panel
	D9124 Fire Alarm Control Panel
	DS7400Xi Control Panel
Multiplex Modules	D8125MUX Multiplex Bus Interface
	DS7430 Multiplex Expansion Module
	DS7436 Multiplex Expansion Module

The DS7460i Module requires a multiplex expansion module to connect to the control panels.

Fire Applications

For UL Listed fire installations, normally-open (NO) contacts must be used. For fire installations, order Multiplex Fire Zone EOL Resistors (P/N: 28010) in the quantity needed.

Wiring

Maximum Impedance: 4.05 Ω at +20°C (+68°F) nominal

Distance (approximate)	Size
76 m	0.65 mm
193 m	1.02 mm
250 ft	22 AWG
600 ft	18 AWG

Refer to the multiplex expansion module's reference guide for multiplex wiring requirements. The recommended wiring to the control panel is quad (four-wire) cable. Do not use shielded or twisted pair cable.

Note If used in fire applications, 18 AWG wire is required.

Parts Included

Quantity Component

1	Dual-zone input module
2	Multiplex-zone EOL resistor (P/N: 26069)
1	Hardware pack
1	Literature pack

Technical Specifications

Circuit Parameters

Initiating Device Circuit Type:	Class B (Style A)
Signaling Line Circuit Type:	Class B (Style 4)
Zone Requirements:	Two multiplex addresses

Environmental Considerations

Temperature (Operating): 0°C to +50°C (32°F to +122°F)

Power Requirements

Current Draw: 1 mA maximum

Ordering Information

DS7460i Dual-zone Input Module

DS7460i

Provides two supervised input zones to connect conventional normally-open (NO) or normally-closed (NC) contacts. It is DIP switch programmable.

DS7465i Input-Output Module



Features

- ▶ Supervises one power-limited input zone
- ▶ Provides one output relay
- ▶ Can be used in UL Listed fire and security applications
- ▶ DIP switch programmable

The DS7465i Input-Output Module works with compatible multiplex systems and uses two multiplex zone addresses. It supplies a DIP switch programmable Form C relay (output zone) that activates on several different system events. The DS7465i Module provides an input zone for monitoring conventional normally-open (NO) or normally-closed (NC) contacts. The module reports the contact status as a multiplex address to the control panel. Use up to sixty DS7465i Modules with compatible control panels or multiplex expansion modules.

Functions

Supervised Input Zone

The power-limited input zone is designed to monitor NO or NC dry contacts. It is supervised using 47 k Ω end-of-line (EOL) resistors.

Output Relay

Use the output relay only on power-limited circuits. The relay contacts are rated 1 A at 30 VDC for resistive loads. Do not use the output relay with inductive or capacitive loads.

Certifications and Approvals

Region	Certification	
Europe	CE	89/336/EEC, EN55022: 1998, EN50130-4: 1995, EN60950: 2000, EN61000-3-2, EN61000-3-3, EN61000-4-2, EN61000-4-3, EN61000-4-4, EN61000-4-5, EN61000-4-6, EN61000-4-11
USA	UL	NBSX: Household Burglar Alarm System Units (UL1023), UOXX: Control Unit Accessories, System (UL864, 9th edition), UTOU: Control Units and Accessories - Household System Type (UL985)
	CSFM	7165-1615: 113, 7165-1615: 119, 7170-1615: 144, and 7170-1615: 145 July 2008

Installation/Configuration Notes

Compatibility Information

Control Panels	D9412GV2, D7412GV2, and D7212GV2 Control Panel
	D9412G, D7412G, and D7212G Control Panel
	D9124 Fire Alarm Control Panel
	DS7400Xi Control Panel
Multiplex Modules	D8125MUX Multiplex Bus Interface
	DS7430 Multiplex Expansion Module
	DS7436 Multiplex Expansion Module

The DS7465i Series Modules require a multiplex expansion module to connect to the control panels.

Fire Applications

For UL Listed fire installations, normally-open (NO) contacts must be used. For fire installations, order Multiplex-zone Fire EOL resistors (P/N: 28010) in the quantity needed.

Wiring

Maximum Impedance: 4.05 Ω at +20°C (+68°F) nominal

Distance (approximate)	Size
76 m	0.65 mm
193 m	1.02 mm
250 ft	22 AWG
600 ft	18 AWG

Refer to the multiplex expansion module's reference guide for multiplex wiring requirements.

The recommended wiring to the control panel is quad (four-wire) cable. Do not use shielded or twisted pair cable.

Note If used in fire applications, 18 AWG wire is required.

Parts Included

Quantity Component

1	Input-output module
1	Multiplex-zone EOL resistor (P/N: 26069)
1	Hardware pack
1	Literature pack

Technical Specifications

Circuit Parameters

Initiating Device Circuit Type:	Class B (Style A)
Signaling Line Circuit Type:	Class B (Style 4)
Zone Requirements:	One multiplex address

Environmental Considerations

Temperature (Operating): 0°C to +50°C (32°F to +122°F)

Outputs

Relay Contact Rating: 1 A at 30 VDC

Power Requirements

Current Draw: 1 mA maximum

Ordering Information

DS7465i Input-Output Module

DS7465i

Supervises one power-limited input zone and provides one output relay. DIP switch programmable. Designed for fire and security applications.

Conettix DX4020 Ethernet Network Interface Module

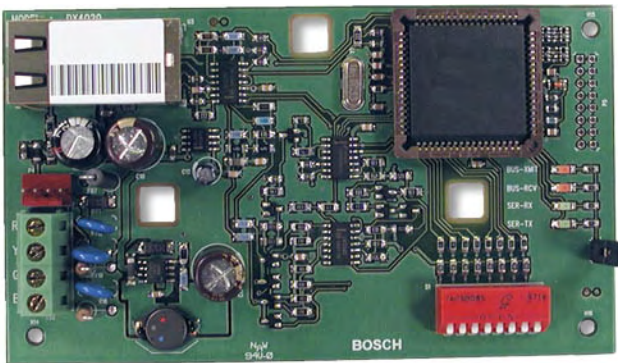

Features

- ▶ **Built-in IP-based alarm transport, programming, and control**
- ▶ **10BASE-T or 100BASE-T network connection**
- ▶ **Full-duplex and half-duplex support**
- ▶ **Three-hole mounting pattern**
- ▶ **Support for dynamic or static IP addresses**
- ▶ **DIP switches for option bus or SDI bus address programming**
- ▶ **Light emitting diodes (LEDs) provide control panel status**
- ▶ **Supports 128-bit AES Rijndael encryption**

The Conettix DX4020 Ethernet Network Interface Module creates two-way communications over Ethernet networks for compatible control panels. Typical uses include:

- Reporting to the Conettix D6600 Communications Receiver/Gateway
- Remote administration with Remote Programming Software (RPS) or RPS-Lite
- Connecting to a PC for programming with PC9000 Software or Building Integration System (BIS) Security Engine

System Overview

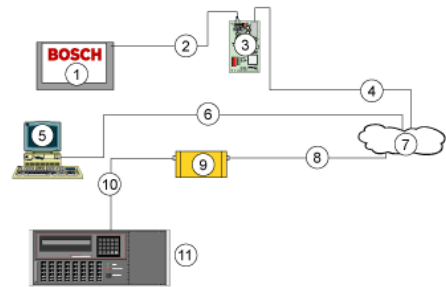

1. Compatible Control Panel
2. Compatible Control Panel Option Bus or SDI Bus Connection
3. Conettix DX4020 Ethernet Network Interface Module
4. Ethernet Network Connection to DX4020
5. Host PC running Conettix D6200 Programming/Administration Software
6. Ethernet Network Connection to Host PC Ethernet Network Interface Card (NIC)
7. Ethernet Network, Local Area Network (LAN), Metropolitan Area Network (MAN), Wide Area Network (WAN), or Internet
8. Ethernet Network Connection to Conettix D6680 Ethernet Network Adapter
9. Conettix D6680 Ethernet Network Adapter
10. Conettix D6680 Ethernet Network Adapter Connection to Conettix D6600 Communications Receiver/Gateway COM4 Port
11. Conettix D6600 Communications Receiver/Gateway

The system overview diagram shows a system using a compatible control panel, Conettix DX4020 Ethernet Network Interface Module, Conettix D6600 Communications Receiver/Gateway, and a Conettix D6680 Ethernet Network Adapter.

Functions

LEDs

Red LEDs	Function
BUS-RCV	Data bus receives data from control panel
BUS-XMIT	Data bus transmits data to control panel
Green LEDs	Function
SER-RX	RS-232 receives data from serial device
SER-TX	RS-232 transmits data to serial device

Four LEDs provide information about the transmission and receipt of data. There are also two network diagnostic LEDs that provide information about the network connection. Refer to the DX4020 Installation Guide (P/N 49522) for details about the network diagnostic LED functions.

DIP Switches

Use the DIP switches to easily assign a bus address to the DX4020.

Programmable IP Address

Use ARP and Telnet commands from any PC to program the DX4020 IP address. The IP address can be dynamic using DHCP or the IP address can be static.

Certifications and Approvals

Region	Certification	
Europe	CE	89/336/EEC, EN55022: 1997 +A2: 2002, EN50130-4: 1995 +A1: 1998 +A2: 2003, EN60950: 2000, EN61000-3-2: 2001, EN61000-3-3A1: 2001, EN61000-4-2: 1995 +A1: 1998 +A2: 2001, EN61000-4-3: 1996 +A1: 1998 +A2: 2000, EN61000-4-4: 1995 +A1: 2001 +A2: 2001, EN61000-4-5: 1995 +A1: 2001, EN61000-4-6: 1996 +A1: 2000, EN61000-4-11: 1994 +A1: 2001
USA	UL	AMCX: Central Station Alarm Units (UL1610, UL1635), AMCX7: Central Station Alarm Units Certified for Canada (cULus), APAW: Police Station Alarm Units (UL365, UL464), APAW7: Police Station Alarm Units Certified for Canada (cULus), APOU: Proprietary Alarm Units (UL1076), APOU7: Proprietary Alarm Units Certified for Canada (cULus), NBSX7: Household Burglar Alarm System Units Certified for Canada (cULus), UTOU7: Control Units and Accessories - Household System Type Certified for Canada (cULus) UL864, 9th edition
	FM	
	CSFM	7167-1615: 100, 7165-1615: 119, 7170-1615: 145, and 7300-1615: 180 July 2008
	NYC-MEA	12-92-E, Vol. XIII and 12-92-E, Vol. 15
France	AFNOR	NF, A2P Type 2 (122000076-05)
Note		FM Approval applies when the DX4020 is used with the Conetix D6600 Communications Receiver/Gateway.

Installation/Configuration Notes

Compatibility information

Applications

RPS:	Supported on all compatible control panels.
PC9000:	Supported on the following control panels: D9412G, D7412G, D7212G, D9112, D7412, and D7212.
Building Integration System (BIS) Security Engine:	Supported on the following SDI bus control panels (version 6.3 and higher): D9412GV2, D7412GV2, D7212GV2, D9412G, D7412G, and D7212G.
CMS 7000:	Supported on DS7400Xi-CHI Control Panels (option bus) set at Mode 18 (version 4.10 or higher).

SDI Bus Control Panels (version 6.0 or higher)

- D9412GV2, D7412GV2, and D7212GV2
- D9412G, D7412G, and D7212G
- D9412, D7412, and D7212
- D9112

Option Bus Control Panels

- DS7400Xi (version 4.10 or higher)
- CC7420-A
- DS7220 and DS7240 (version 2.10 or higher)
- FPD-7024

Connection Considerations

The DX4020 uses a standard Category 3 or Category 5 cable with an RJ-45 plug to connect to the network, a two-wire connection from the control panel bus, and two wires that connect to the control panel or a power supply for DC power. For 10BASE-T, use Category 3 or better. For 100BASE-T, use Category 5 or better.

Mounting Considerations

The DX4020 mounts to the standard three-hole patterns in supported control panel enclosures. With the D137 mounting bracket, the DX4020 mounts to other enclosures.

Parts Included

Quant.	Component
1	Ethernet network interface module
1	Cable assembly, quick connect
1	Hardware pack
1	Literature - Installation Guide

Technical Specifications

Environmental Considerations

Dimensions:	7.6 cm x 12.7 cm (3 in. x 5 in.)
Operating Temperature:	0°C to +50°C (+32°F to +122°F)
Relative Humidity:	5% to 85% at 30°C (86°F) non-condensing

Power Requirements

Current:	10Base-T: 110 mA maximum 100Base-T: 135 mA maximum
Voltage (Operating):	12 VDC nominal

Ordering Information

Conetix DX4020 Ethernet Network Interface Module	DX4020
Creates two-way communications over Ethernet networks for compatible control panels.	

Accessories

AE1 Standard Enclosure (Gray)	AE1
Standard gray enclosure with keyed lock. Measures 35.6 cm x 31.8 cm x 7.6 cm (14 in. x 12.5 in. x 3 in.).	

Conettix C900V2 Dialer Capture Ethernet Module

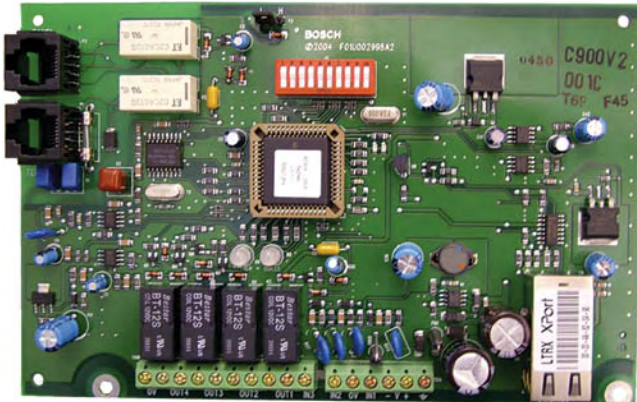

Features

- ▶ Captures alarm and event data from dialer-based control panels using CONTACT ID, SIA, Modem II, Modem IIe, Modem IIIa², Pulse, and other formats
- ▶ Performs full data transmissions without changing the data
- ▶ 12 VDC to 24 VDC voltage range
- ▶ Re-routes signals using UDP/IP-based data networks
- ▶ Convenient connection (RJ-45 Jack) to Ethernet networks
- ▶ Integrated 10/100 Network Interface Module (NIM)
- ▶ Provides acknowledgement from the receiver to the control panel
- ▶ Supports 128-bit AES Rijndael encryption

The Conettix C900V2 Dialer Capture Ethernet Module works with most control panels using a standard digital dialer format and provides end-to-end security. The module links the digital dialer to the Public Switched Telephone Network (PSTN), the digital dialer's telephone interface, and an Ethernet network. With the Ethernet link, the C900V2 can:

- Communicate with the control panel dialer
- Decode and deliver signals to a Conettix D6600 Communications Receiver/Gateway
- Relay a confirmation message back to the control panel dialer

Whether a control panel dials through a telephone line or through the C900V2, the data remains the same. The C900V2 empowers digital dialer control panels to work over an IP network such as a Local Area Network (LAN), a Wide Area Network (WAN), or the Internet.

System Overview

When the dialer has a message to report, the C900V2 simulates dial tone and line voltages, causing the dialer to behave as though it is connected to a monitoring center digital receiver through the PSTN. The C900V2 decodes and converts the transmitted dialer message to data for transport over any UDP/IP network.

After the Conettix D6600 Communications Receiver/Gateway receives a message or event, it sends an acknowledgement message to the C900V2. The C900V2 returns an appropriate response to the dialer, maintaining end-to-end acknowledgment.

The C900V2 operates in Intercept Mode, connecting the dialer to the network under normal circumstances. If the C900V2 loses contact with the Conettix D6600 Communications Receiver/Gateway, the unit goes into Fallback Mode, connecting the dialer to the PSTN telephone line.

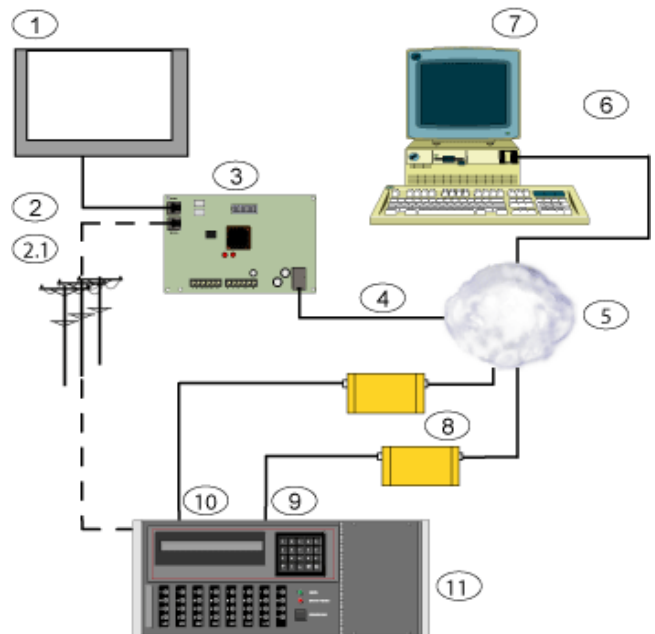

1. Control Panel
2. Dialer Connection
 - 2.1 Dialer Output to RJ-31x Jack and PSTN
3. Conettix C900V2 Dialer Capture Ethernet Module
4. Ethernet or LAN Connection
5. LAN, WAN, or the Internet
6. Connection To Ethernet Network Interface Card (NIC)
7. Host PC with Conettix D6200 Programming/Administration Software
8. Conettix D6680 Ethernet Network Adapter
9. Com 1 (Optional)
10. Com 4
11. Conettix D6600 Communications Receiver/Gateway

Functions

Communication Formats

ADT-SIA
 BFSK (2300Hz ACK Tone or 1400Hz ACK Tone)
 DTMF (Contact ID, High Speed and 4/2 Express)
 FBI Superfast DTMF (1400 Hz ACK Tone or 2300 Hz ACK Tone)
 Pulse 3/1, 3/1 Checksum, 4/2 (1400 Hz ACK Tone or 2300 Hz ACK Tone)
 Radionics Modem II, Radionics Modem IIe , and Modem IIIa²
 Seriee FSK and DTMF
 SIA V.21, 110/300 baud
 SIA Bell 103, 110/300 baud
 Robofon
 Telim

Inputs

Input	Description
1	Used as an end-of-line (EOL) supervised loop. Detects open, short, and normal states. Terminate this input with a 10 kΩ EOL resistor.
2	Used for intercept inhibit to force the C900V2 into Fallback mode for at least two minutes.
3	Used for intercept override, allowing users to switch between intercept and fallback modes.

Outputs

Output	Description
1	Provides local annunciation if the power to the C900V2 is lost or the CPU fails.
2	Provides local annunciation if the connection to the monitoring center is lost.
3	Provides local annunciation whenever the C900V2 is in intercept mode.
4	Controllable from the monitoring center and the Conettix D6200 Programming/Administration Software (default is open).

Intercept and Fallback Modes

- **Intercept Mode:** The C900V2 connects the dialer to the network. Intercept mode remains on as long as the C900V2 remains in continuous contact with the Conettix D6600 Communications Receiver/Gateway.
- **Fallback Mode:** The C900V2 connects the dialer to the telephone line, removing itself from the telephone circuit. Fallback mode occurs if the C900V2 loses contact with the Conettix D6600 Communications Receiver/Gateway, loses power, or stops operating correctly.

LED Indicators

The C900V2 has two dual-colored LEDs that indicate the module's status (the SYSTEM LED and the DIALER LED).

Modular Jacks

The C900V2 module has three modular jacks.

- **Panel Jack:** Connects to a dialer through a modular telephone cord (D162).
- **TELCO Jack:** Connects to a PSTN line through a modular telephone cord (D162).
- **Ethernet Jack:** Connects to the Ethernet data network through an Ethernet cable. For 10BASE-T, the cable must be Category 3 or better. For 100BASE-T, the cable must be Category 5 or better.

Polling and Supervision

Conettix C900V2 polling helps the Conettix D6600 Communications Receiver/Gateway to perform supervision.

Web Programming Tool

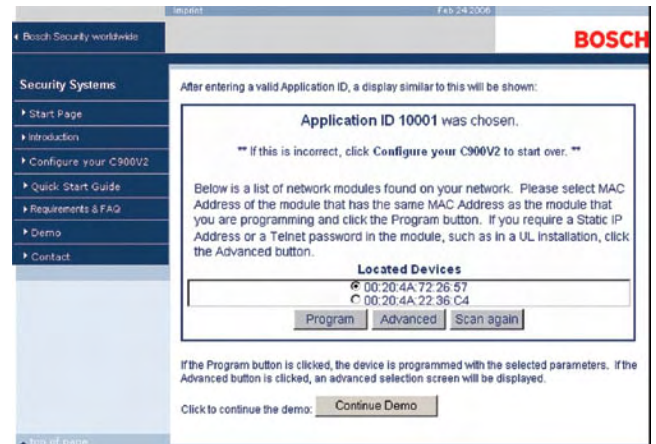

The web programming tool makes the C900V2 configuration process simple and convenient, similar to browsing a web site. After obtaining an Application ID, installers can go to www.c900v2.com from a computer with internet access and configure the C900V2 for the preferred central station.

Certifications and Approvals

Region	Certification	
Europe	CE	1999/5/EC, EN55022: 1998, EN50130-4: 1996+A1: 1998+A2: 2003, EN60950-1: 2001, EN61000-3-2, EN61000-3-3, EN61000-4-2: 1995+A1: 1998, EN61000-4-3: 1995+A1: 1998, EN61000-4-4: 1995, EN61000-4-5: 1995, EN61000-4-6: 1996, EN61000-4-11: 1994, TBR21: 1998
Belgium	INCERT	B-509-0040/a
USA	UL	AMCX: Central Station Alarm Units (UL1610, UL1635), AMCX7: Central Station Alarm Units Certified for Canada (cULus), APAW: Police Station Alarm Units (UL365, UL464), APAW7: Police Station Alarm Units Certified for Canada (cULus), APOU: Proprietary Alarm Units (UL1076), APOU7: Proprietary Alarm Units Certified for Canada (cULus), NBSX: Household Burglar Alarm System Units (UL1023), NBSX7: Household Burglar Alarm System Units Certified for Canada (cULus), UTOU: Control Units and Accessories - Household System Type (UL985), UTOU7: Control Units and Accessories - Household System Type Certified for Canada (cULus) UL864, 9th edition
	FM	
	CSFM	7300-1615: 180 and 7167-1615: 223 July 2008

Australia	A-Tick	
Canada	IC	
USA	FCC	Part 15 Radiated/Conducted Emissions

Note FM approval applies when the C900V2 is used with the Conettix D6600 Communications Receiver/Gateway.

Installation/Configuration Notes

Compatibility Information

Numerous UL Listed Fire Alarm Control Panels (FACPs) have proven compatible with the C900V2. For a complete list, refer to the *Network Dialer Capture Module C900V2 Compatibility List* (F01U010036).

Technical Specifications

Connectors

Control Panel:	RJ-45 Modular Jack
Telco:	RJ-45 Modular Jack
LAN/WAN:	RJ-45 Modular Jack
Ethernet Cable:	Unshielded twisted pair 100 m (328 ft) For 10BASE-T, use Category 3 or better. For 100BASE-T, use Category 5 or better.

Environmental Considerations

Temperature (Operating): 0°C to +49°C (+32°F to +120°F)

Indicators

Module Status LEDs: 2 dual-colored

Module

Dimensions:	17.8 cm x 11.4 cm (7 in. x 4.5 in.)
Interface:	IEEE 802.3

Power Requirements

Current (Maximum):	280 mA
Voltage Range:	12 VDC to 24 VDC nominal
Alarm Outputs:	Normally-open (NO) dry contacts

Protocols

Output To LAN or WAN: UDP/IP packets

Ordering Information

Conettix C900V2 Dialer Capture Ethernet Module **C900V2**

Compatible with control panels using a standard digital dialer format. Provides end-to-end security. Allows digital dialer control panels to work over an IP network (such as LAN, WAN, or the Internet).

Accessories

AE1 Standard Enclosure (Gray) **AE1**

Standard gray enclosure with keyed lock. Measures 35.6 cm x 31.8 cm x 7.6 cm (14 in. x 12.5 in. x 3 in.).

DX4010i RS-232 Serial Interface Module

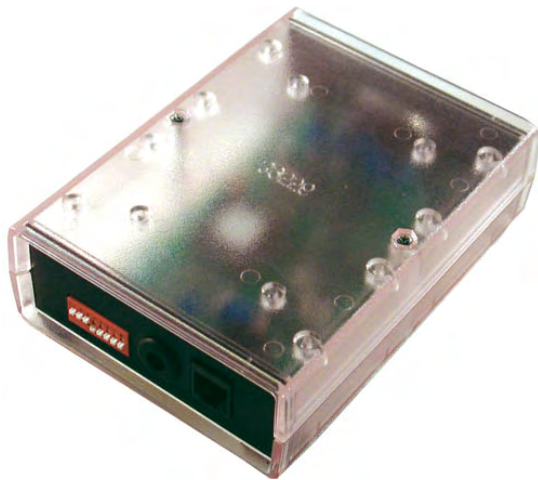

Features

- ▶ Transparent enclosure
- ▶ Diagnostic light emitting diodes (LEDs)
- ▶ RJ-16 data bus connector
- ▶ DIP switches for address and bus programming
- ▶ Enhanced direct connection for Remote Programming Software (RPS)
- ▶ DB9 DTE RS-232 connector

The DX4010i RS-232 Serial Interface Module creates a local connection between compatible control panels and approved applications or other RS-232 devices. The module connects to the control panel's data bus which provides power and data.

System Overview

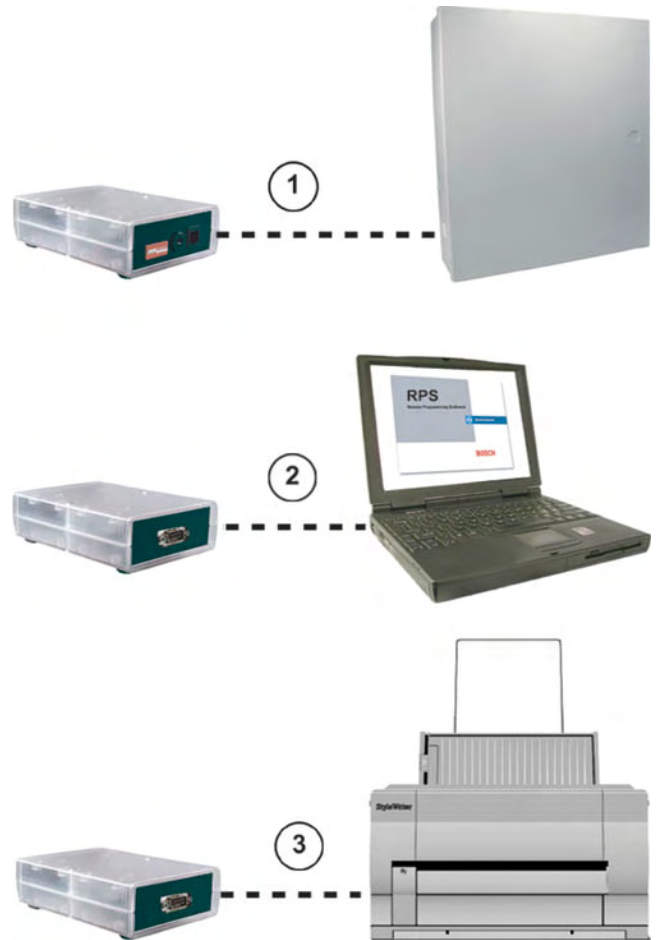

The DX4010i RS-232 Serial Interface Module connects to:

1. A control panel's option or serial device interface (SDI) bus through the data bus connector.
2. A PC for RPS, BIS, or other third party applications through the RS-232 connector.
3. A serial printer or parallel printer with a converter cable box (not shown) through the RS-232 connector with a compatible control panel. Refer to *Compatibility Information* for details.

Functions

DIP Switches

Use the external DIP switches to easily assign an address to the DX4010i RS-232 Serial Interface Module.

RJ-16 Data Bus Connector and DB9 DTE RS-232 Connector

Use the RJ-16 data bus connector for a remote programming connection. Use the DB9 DTE RS-232 connector to connect to approved RS-232 devices.

Transparent enclosure

The diagnostic LEDs show through the transparent enclosure, making troubleshooting easy and convenient.

Diagnostic LEDs

There are four diagnostic LEDs that provide information about the transmission and receipt of data.

Two Red LEDs	Function
BUS RX	Data bus receives data from control panel
BUS TX	Data bus transmits data to control panel
Two Green LEDs	Function
SER RX	RS-232 receives data from serial device
SER TX	RS-232 transmits data to serial device

United States	D9133 Serial Interface Module	For use with BIS, PC9000, or other third party applications on SDI bus control panels.
	D9133DC Serial Interface Module	For use with RPS or other third party applications on SDI bus control panels.
	D9533 RS-232 Serial Interface Module	For use with RPS, CMS 7000*, or printers on option bus control panels
Europe, United States, and China	DX4010 RS-232 Serial Interface Module	For use with RPS, CMS 7000*, or printers on option bus control panels.

*CMS 7000 is available in China only.

Certifications and Approvals

Region	Certification
Europe	CE 89/336/EEC, EN55022: 1994 +A1: 1995 +A2: 1997 Class A, EN50130-4: 1995 +A1: 1998 +A2: 2003, EN60950-1: 2001, EN61000-3-2: 2000, EN61000-3-3: 1995 +A1: 2001
Australia	C-Tick

Installation/Configuration Notes

Compatibility Information

Applications and RS-232 Devices

United States	RPS:	Supported on all compatible control panels.
	PC9000:	Supported on all the following control panels: D9412G, D7412G, D7212G, D9112, D7412, and D7212.
	Building Integration Software (BIS):	Supported on the following SDI bus control panels (version 6.3 and higher): D9412G, D7412G, and D7212G.
China	CMS 7000:	Supported on DS7400Xi Control Panels (option bus) set at Mode 18 (version 3.09 or higher).
All	Printers:	Supported on option bus control panels.

SDI Bus Control Panels (version 6.0 or higher)

United States	<ul style="list-style-type: none"> D7212G, D7412G, and D9412G D7212, D7412, and D9412 D9112
---------------	------------------------------------------------------------------------------------------------------------------------------

Option Bus Control Panels

Europe	<ul style="list-style-type: none"> DS7400Xi (version 2.02 or higher) DS7220 and DS7240
Australia	<ul style="list-style-type: none"> CC7420-A
United States	<ul style="list-style-type: none"> D4412 and D6412

The DX4010i RS-232 Serial Interface Module replaces the following modules:

Technical Specifications

Environmental Considerations

Operating Temperature:	0°C to +50°C (+32°F to +122°F)
Relative Humidity:	5% to 85% at +30°C (+86°F) non-condensing

Power Requirements

Current (Maximum):	50 mA nominal, 55 mA with LED
Voltage (Operating):	8 VDC to 14 VDC

Ordering Information

DX4010i RS-232 Serial Interface Module	DX4010i
Locally connects compatible control panels and approved applications or other RS-232 devices.	

DS7420i Dual Phonenumber/ Bell Supervision Module

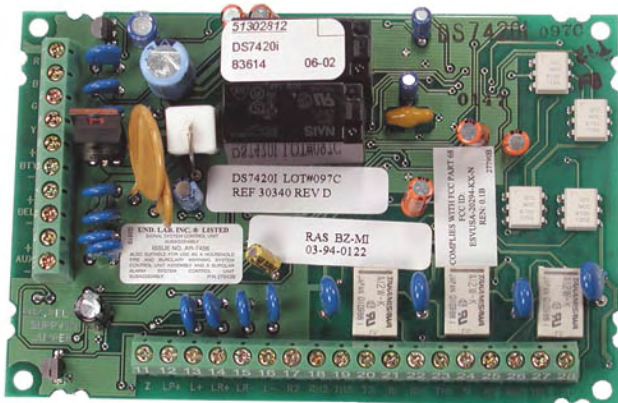

Features

- ▶ **One Class A input zone**
- ▶ **Two supervised 12 VDC signaling outputs**

The DS7420i is an accessory board designed for use with the DS7400Xi control panel. It allows the control to be used in NFPA 72 installations. The DS7420i provides two supervised 12 VDC signaling outputs, one Class A (Style D) input zone, and dual phone line transmission and supervision.

Functions

One Class A Input zone

The Initiating Device Circuit (Terminals 13-16) is a Class A (Style D) loop intended for connection of normally-open (N/O) dry contact initiating devices such as waterflow switches.

Note The Class A loop will not support loop powered devices such as two-wire smoke detectors.

Two Supervised 12 VDC Signaling Outputs

There are two supervised outputs:

- **Auxiliary Output Circuit:** A 12 VDC, special application supervised output that latches on alarm and resets upon system reset. It is intended for strobes/indicating appliances and supplies up to 1.0 A.
- **Indicating Appliance Circuit (Bell Output):** A 12 VDC, special application supervised output that supplies up to 1.75 A for vibrating bells.

Certifications and Approvals

Region	Certification	
Europe	CE	89/336/EEC, EN55022:1994 +A1:1995 +A2:1997 Class A, EN50130-4:1995 +A1:1998 +A2:2003, EN60950-1:2001, EN61000-3-2:2000, EN61000-3-3:1995 +A1:2001 1999/5/EC, EN60950 Dec 1992 (2nd edition) +A1:1992 +A2:1993, EN50081-1:1992, EN50082-1:1992
USA	UL	AMCX: Central Station Alarm Units (UL1610, UL1635), AOTX: Local Alarm Units (UL464, UL609), APAW: Police Station Alarm Units (UL365, UL464), UTOU: Control Units and Accessories - Household System Type (UL985)
	NYC-MEA	274-93-E, Vol. IV
USA	FCC	Rules, Part 15 - Class B digital device and Part 68
Canada	IC	Canadian Interference-Causing Equipment Regulations - Class A digital apparatus

Installation/Configuration Notes

Commercial Fire Applications

For Commercial Fire applications, the TR1850 transformer must be enclosed in the AE-TR16 Transformer Enclosure. The wiring from the AE-TR16 to the control and the wiring to the outlet box in conduit must also be enclosed in the AE-TR16 Enclosure.

Wiring

The DS7400Xi control panel must be installed in accordance with NFPA 72 guidelines. The system is power limited except for battery terminals. All wiring entering the system enclosure must be power limited.

Technical Specifications

Auxiliary Power Requirements

Current (Alarm):	140 mA
Current (Supervisory):	20 mA
Voltage:	12 VDC nominal

Environmental Considerations

Temperature (Operating): 0°C to +49°C (+32° to +120°F)

Inputs Initiating Device Circuit

Max. Loop Resistance: 150 Ω total

Output (Auxiliary Output Circuit)

Current Supplied: up to 1.0 A

Output (Indicating Appliance Circuit Bell Output)

Current Supplied: up to 1.75 A

Reference Numbers

DOC number: 1249 5895 A

FCC Registration number: ESVUSA-20294-KX-N

Load Number: 2

REN: 0.1B

Ordering Information**DS7420i Dual Phonenumber/Bell Supervision Module DS7420i**

Provides two supervised 12VDC signaling outputs, one Class A (Style D) input zone, and dual telephone line transmission.

Door Access Control Module (DACM)



Features

- ▶ Supports up to 500 users without PC software and up to 2,000 users with PC software
- ▶ Operates as an integrated security system component or as a stand-alone door controller
- ▶ Works with a variety of reader types and credential formats
- ▶ Users can administer the DACM from the reader keypad, security system keypad, or PC software

You can use the DACM as a stand-alone single door controller, or integrate the DACM into a building's security system. Use an integrated DACM to arm and disarm the security system. You can use credentials (cards and key fobs), personal identification numbers (PINs), or both.

System Overview

The DACM supports the following devices separately or combined: a proximity reader with keypad, a request-to-exit (REX) input, a door contact.

1. DACM Controller
2. Optional electric door strike
3. Proximity reader with keypad
4. Control panel
5. Proximity card and key fob
6. Optional door contact
7. Optional REX input
8. Desktop or laptop PC
9. Optional data transfer unit (DTU)
10. 12 VDC power supply for stand-alone systems

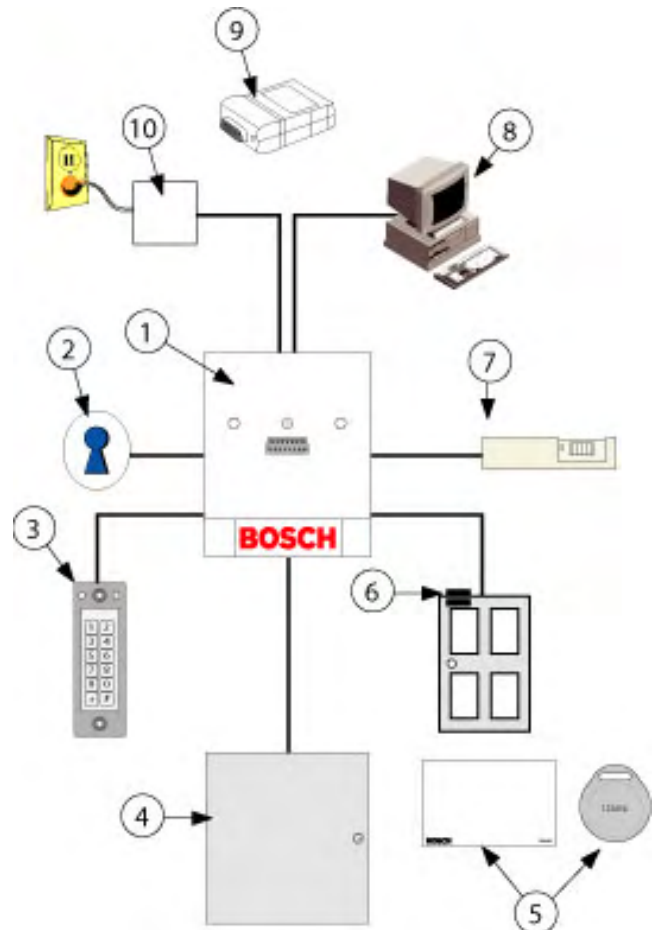

In a system with a DACM and an integrated control panel, you can use a credential to arm an area (partition), disarm an area (partition), or silence an alarm.

Certifications and Approvals

Country

Europe, Middle East, Africa, and others

Listings, Certifications, and Approvals

EN50133-1

Alarm Systems – Access Control Systems for use in Security Applications

Installation/Configuration Notes

Compatibility Information

Control Panels	<ul style="list-style-type: none"> DS7240V2 and DS7220V2 Control Panels DS7400Xi V4+ Control Panel firmware revision 4.10 or greater
Credential Formats	<p>Compatibility is subject to encryption type, encoding, and format type.</p> <ul style="list-style-type: none"> Proximity ISO 50 bit Wiegand 8 to 50 bit Magstripe AXM Proximity 125 KHz 13.56 MHz Smart cards Key fobs
Reader Types	<p>Compatibility is subject to interface and card format.</p> <ul style="list-style-type: none"> HID Myfare Idesco Indala CASI-RUSCO Paxton Mr Access Integrated Engineering Bioscrypt® Banquetech Deister

Parts Included

Components	Kit 1	Kit 2	Kit 3	Kit 4	Kit 5
DACM controller	X	X	X	X	X
Proximity reader with keypad	X	X	X	X	
Package of 10 proximity cards	X	X			
Package of 10 proximity key fobs			X	X	
Program card	X	X	X	X	
DACM hardware pack	X	X	X	X	X
Proximity reader with keypad hardware pack	X	X	X	X	
PC serial communication cable	X		X		X
Installation guide	X	X	X	X	X
PC software CD	X	X	X	X	X

Kit 5 is for use with third party readers (not supplied). The DACM supports Wiegand interfaces between 8 bit to 50 bit (subject to format type) such as 26 bit open standard. If you use a third party proximity reader, you can only program the DACM from the PC and some of the enhanced LED functions for alarm indication become unavailable.

The standard supplied proximity reader is based on 125 KHz and supports third party cards such as EM Marin, Sokymat, and Temic.

Technical Specifications

DACM

Input Power:	12 VDC
Current Draw:	65 mA
Lock Relay Rating:	5 A maximum at 12 VDC; 3 A maximum at 24 VDC
Dimensions:	87 mm x 106 mm x 30 mm

Proximity Reader with Keypad

Input Power:	12 VDC
Current Draw:	45 mA
Dimensions:	119 mm x 40 mm x 17 mm

PC Software

Processor Speed:	400 MHz minimum
Memory:	128 MB RAM minimum
Hard Drive:	100 MB free space minimum
Hardware:	CD-ROM drive and serial COM port
Operating System:	Windows® 98SE, 2000, Me, XP, and Windows NT®
Screen Resolution:	800 x 600 or 1024 x 768
Video Memory:	At least 8 MB

Trademarks

Bioscrypt® is a registered trademark of Bioscrypt, Inc. Windows® 98SE, Windows® 2000, Windows® Me, and Windows® XP are registered trademarks of Microsoft Corporation in the United States and/or other countries.

Windows NT® is a registered trademark of Microsoft Corporation in the United States and/or other countries.

Ordering Information

IUI-DACM/K1-EX Kit 1

Standalone or PC programmable. Includes one package of 10 proximity cards.

IUI-DACM/K1-EX

IUI-DACM/K2-EX Kit 2

Standalone only. Includes one package of 10 proximity cards.

IUI-DACM/K2-EX

IUI-DACM/K3-EX Kit 3

Standalone or PC programmable. Includes one package of 10 proximity key fobs.

IUI-DACM/K3-EX

IUI-DACM/K4-EX Kit 4

Standalone only. Includes one package of 10 proximity key fobs.

IUI-DACM/K4-EX

IUI-DACM/K5-EX Kit 5

PC programmable only. Excludes readers and cards.

IUI-DACM/K5-EX

Accessories

IUI-CNTRL/DACM Controller

For use with all DACM kits.

IUI-CNTRL/DACM

IUI-DTU/DACM Data Transfer Unit (DTU)

Transfers programming information from the computer to the controller without a direct computer connection.

IUI-DTU/DACM

IUI-CABLE/DACM Cable

Provides PC serial communication.

IUI-CABLE/DACM

Ordering Information

IUI-READKP/DACM Proximity Reader with Keypad Graphite gray case with integrated keypad.	IUI-READKP/DACM
IUI-READER/DACM Proximity Reader Graphite gray case.	IUI-READER/DACM
IUI-CARD/DACM Proximity Cards Each package contains ten cards.	IUI-CARD/DACM
IUI-FOB/DACM Proximity Key Fobs Each package contains ten key fobs.	IUI-FOB/DACM

Software Options

IUI-SWCD/DACM PC Software Stores over 60 database fields per user, adds or deletes users, and sets personal identification numbers.	IUI-SWCD/DACM
-----------------------------------------------------------------------------------------------------------------------------------------------	----------------------

IUI-CARD/DACM Proximity Cards

2

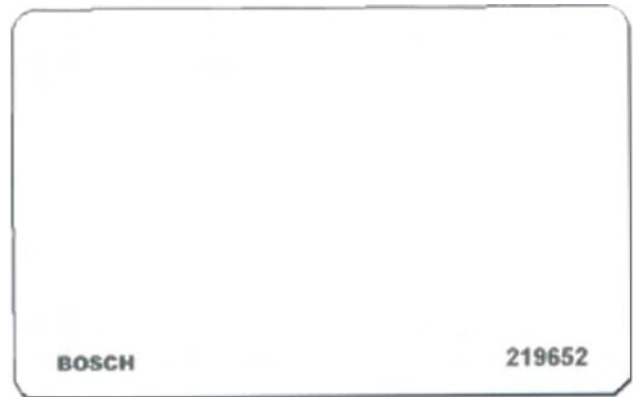
**Ordering Information**

IUI-CARD/DACM Proximity Cards Each package contains ten cards.	IUI-CARD/DACM
--------------------------------------------------------------------------	----------------------

IUI-FOB/DACM Proximity Key Fobs



Ordering Information

IUI-FOB/DACM Proximity Key Fobs
Each package contains ten key fobs.

IUI-FOB/DACM

IUI-CABLE/DACM Cable



Ordering Information

IUI-CABLE/DACM Cable
Provides PC serial communication.

IUI-CABLE/DACM

IUI-CNTRL/DACM Controller



Ordering Information

IUI-CNTRL/DACM Controller
For use with all DACM kits.

IUI-CNTRL/DACM

IUI-DTU/DACM Data Transfer Unit (DTU)



Ordering Information

IUI-DTU/DACM Data Transfer Unit (DTU)
Transfers programming information from the computer to the controller without a direct computer connection.

IUI-DTU/DACM

IUI-READER/DACM Proximity Reader

Ordering Information

IUI-READER/DACM Proximity Reader
Graphite gray case.

IUI-READER/DACM

IUI-READKP/DACM Proximity Reader with Keypad



Ordering Information

IUI-READKP/DACM Proximity Reader with Keypad

Graphite gray case with integrated keypad.

IUI-READKP/DACM

IUI-SWCD/DACM PC Software



The DACM PC software allows you to add or delete DACM users, set PIN length for stand-alone DACMs, and set door-open time. Use the software to store over 60 database fields per user, including photograph, company details, department, personnel data, and vehicle details. Search, door-open alarm, and door contact settings functions are available. The DACM PC software immediately recognizes new controllers when they are connected to the PC running the software.

Ordering Information

IUI-SWCD/DACM PC Software

Stores over 60 database fields per user, adds or deletes users, and sets personal identification numbers.

IUI-SWCD/DACM

AE1 Standard Enclosure (Gray)



The AE1 is a gray enclosure that accommodates an optional tamper switch for monitoring the door. It is made of 1.0 mm cold-rolled steel and includes a keyed lock. The dimensions are 35.6 cm x 31.8 cm x 7.6 cm (14 in. x 12.5 in. x 3 in.).

Certifications and Approvals

Region	Certification	
Belgium	INCERT	B-509-0048
USA	UL	NBSX: Household Burglar Alarm System Units (UL1023), UOJZ: Control Units, System (UL864), UTOU: Control Units and Accessories - Household System Type (UL985)
	CSFM	7167-1615: 223 July 2008
	NYC-MEA	274-93-E, Vol. IV

Ordering Information

AE1 Standard Enclosure (Gray)

Standard gray enclosure with keyed lock. Measures 35.6 cm x 31.8 cm x 7.6 cm (14 in. x 12.5 in. x 3 in.).

AE1

AE3 Large Enclosure (Gray)



The AE3 is a large gray enclosure that accommodates an optional tamper switch for monitoring the door. It is made of 1.2 mm cold-rolled steel with a keyed lock. It measures 52.7 cm x 38.1 cm x 10.8 cm (20.7 in. x 15 in. x 4.25 in.).

Certifications and Approvals

Region	Certification	
Belgium	INCERT	B-509-0048
USA	UL	NBSX: Household Burglar Alarm System Units (UL1023), UOJZ: Control Units, System (UL864), UTOU: Control Units and Accessories - Household System Type (UL985)
	NYC-MEA	274-93-E, Vol. IV

Ordering Information

AE3 Large Enclosure (Gray)

Large gray enclosure with keyed lock. Measures 52.7 cm x 38.1 cm x 10.8 cm (20.7 in. x 15 in. x 4.25 in.).

AE3

AE20 Universal Plastic Enclosure



The AE20 Enclosure's flexible design accommodates a number of input, output and receiver modules whose circuit boards have either through-hole or three-point mounting systems.

The enclosure can be mounted to a single gang/double gang box, a 9 cm (3.5 in.) octagonal box, or a 10 cm (4 in.) square box. It may also be surface mounted. The enclosure measures 12 cm x 16 cm x 4 cm (4.7 in. x 6.2 in. x 1.5 in.) and has provisions to accommodate wall tamper switches on the modules.

Ordering Information

AE20 Universal Plastic Enclosure

AE20

Mounts to a single gang/double gang box, a 9 cm (3.5 in.) octagonal box, or a 10 cm (4 in.) square box. The dimensions are 12 cm x 16 cm x 4 cm (4.7 in. x 6.2 in. x 1.5 in.). Accommodates wall tamper switches on the modules.

D203 Enclosure



2

Certifications and Approvals

Region	Certification	
USA	UL	NBSX: Household Burglar Alarm System Units (UL1023), UTOU: Control Units and Accessories - Household System Type (UL985)

Ordering Information

D203 Enclosure

Works with input, output, and receiver modules where the circuit boards have through-hole or three-point mounting systems.

D203

Battery 12 V / 10 Ah

2

Certifications and Approvals

VdS-Approval number: **G 189 231, G 189 170, G 193 064**

Region	Certification
Germany	VdS G 104057, C Batterie 12 Ah

Parts Included

Qty.	Components
1	12 V / 10 Ah battery, with connection accessories

Technical Specifications

12 V / 10 Ah dry batteries

Rated voltage	12 V DC
Rated capacity (K ₂₀)	10 Ah
Recommended charge voltage	13.8 V DC at 20°C
Recommended charge current	0.1 A
Dimensions (W x H x D)	151 x 94 x 102 mm
Connection	Flat pole

Ordering Information

Battery 12 V / 10 Ah	IPP-12V-10Ah
-----------------------------	---------------------

Battery 12 V / 17 Ah

Certifications and Approvals

Region	Certification
Germany	VdS G 104058, C Batterie 18 Ah

Parts Included

Qty.	Components
2	12V / 17Ah battery, with connection accessories

Technical Specifications

12V / 17Ah dry batteries

Rated voltage	12V DC
Rated capacity (K ₂₀)	17Ah
Recommended charge voltage	13.8V DC at 20°C
Recommended charge current	0.1 to 0.2A
Weight	9.6kg
Dimensions (W x H x D)	183 x 78 x 169mm
Connection	Flat pole, M5 inner thread

Ordering Information

Battery 12 V / 17 Ah	4998045208
-----------------------------	-------------------

Battery 12 V / 24 Ah

2

Certifications and Approvals

VdS-Approval number: **G 196 025, G 182 026, G 196 022, G 102 004**

Region	Certification
Germany	VdS G 104059, C Batterie 26 Ah

Parts Included

Qty.	Components
2	12 V / 24 Ah battery

Technical Specifications

12V / 24 Ah dry batteries

Rated voltage	13,8 V DC
Rated capacity (K ₂₀)	24 Ah
Recommended charge current	0.1 to 0.2 A
Weight	9.6 kg
Dimensions (W x H x D)	167 x 127 x 176 mm
Connection	Flat pole

Ordering Information

Battery 12 V / 24 Ah	IPP-12V-24Ah
-----------------------------	---------------------

Battery 12 V / 65 Ah

Certifications and Approvals

Region	Certification
Germany	VdS G 104048, C Batterie 65 Ah

Parts Included

Qty.	Components
1	Battery 12 V / 65 Ah

Technical Specifications

12 V / 65 Ah dry battery

Rated capacity	65 Ah
Rated voltage	13.8 V DC
Recommended charge current	0.1 to 0.2A
Dimensions (W x H x D)	271mm x 166mm x 190mm
Connection	Flat pole, 16,5mm or with M5 thread

Ordering Information

Battery 12 V / 65 Ah	4998120915
-----------------------------	-------------------

D1222 Battery (12 V, 2.2 Ah)

Features

- ▶ **12 VDC sealed lead-acid**
- ▶ **Fully rechargeable**
- ▶ **Maintenance-free**
- ▶ **Long service life**
- ▶ **Appropriate for use as uninterruptible power supplies**

A 12 VDC valve-regulated lead-acid rechargeable battery that withstands overcharge or over-discharge, and resists vibration and shock. The compact design saves installation space, while providing full and reliable power.

System Overview

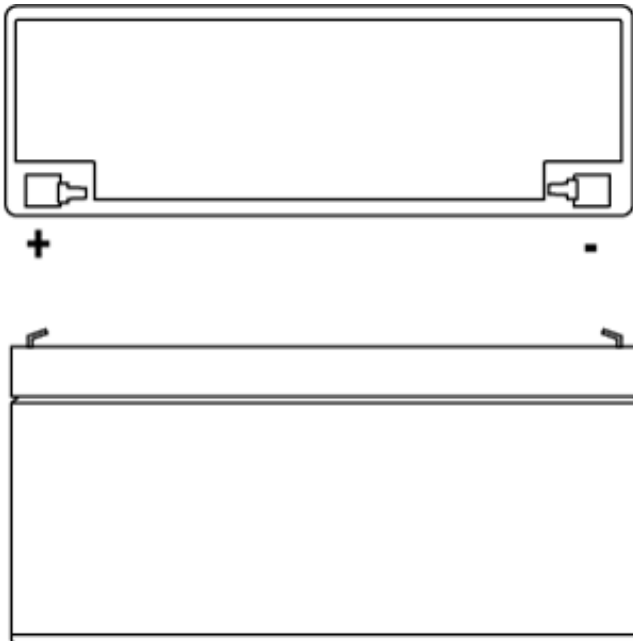

The D1222 terminals are uniquely positioned.

Certifications and Approvals

UL approval certificate MH25408

Installation/Configuration Notes

It is recommended to use constant-voltage charging and to recharge the battery immediately after use.

Technical Specifications

Nominal Voltage:	12 VDC
Rated Capacity:	2.2 Ah (20 hr)
Internal Resistance:	50 mΩ (20°C full charge)
Compatible Control Panels	VR8 Desktop Alarm System
Dimensions:	178 mm x 34 mm x 60 mm (7 in. x 1.3 in. x 2.3 in.)
Weight:	1.0 kg (2.2 lbs)
Terminal Position:	C
Terminal Type:	Fasten Tab 187E
Temperature Affect on Capacity:	40°C (104°F) = 105% 20°C (68°F) = 100% 0°C (32°F) = 85%
Capacity Rates:	20 hr, 0.11 A, 2.2 Ah 10 hr, 0.19 A, 1.9 Ah 5 hr, 0.35 A, 1.75 Ah 1 hr, 1.32 A, 1.32 Ah

Ordering Information

D1222 Battery (12 V, 2.2 Ah)

D1222

A 12 VDC valve-regulated lead-acid rechargeable battery that withstands overcharge or over-discharge, and resists vibration and shock.

D1250 Battery (12 V, 5 Ah)



Features

- ▶ **12 VDC sealed lead-acid**
- ▶ **Fully rechargeable**
- ▶ **Maintenance-free**
- ▶ **For use as secondary power for accessory modules**
- ▶ **Long service life**

A 12 V sealed lead-acid battery. It acts as a maintenance-free standby and auxiliary power supply that provides long service life and dependability. Use the battery only with charging circuits calibrated for lead-acid batteries. It is suitable for supplying backup power for fire, security, and access control systems during AC power failures.

Installation/Configuration Notes

Standby Power Requirements

Refer to the appropriate control panel installation manual for information on calculating the standby battery requirements for the system. Total continuous and intermittent current requirements must not exceed the amp hour capacity of the battery.

Technical Specifications

Physical Specifications

Nominal Voltage:	12 V
Nominal Capacity (20 Hour)	5 Ah
Weight:	1.85 kg (4 lb)
Dimensions:	10 cm x 9 cm x 7 cm (4 in. x 3.5 in. x 2.8 in.)
Height with Terminals:	10.6 cm (4.2 in.)
Standard Terminal:	FI-Faston Tab No. 187

Capacity

20 Hour rate (0.25 A):	5 Ah
10 hour rate (0.45 A):	4.5 Ah
5 hour rate (1 A):	4 Ah
1 hour rate (5 A):	3 Ah

Capacity Affected by Temperature

40°C (104°F):	105%
30°C (68°F):	100%
0°C (32°F):	85%

Constant Voltage Charge

Cycle:	Initial charging current less than 1.3 A. Voltage 7.20 V to 7.50 V at 20°C (68°F). Temperature Coefficient -15 mV/C.
Standby:	Initial charging current less than 1.26 A. Voltage 6.75 V to 6.90 V at 20°C (68°F). Temperature Coefficient = 10 mV/C.

Ordering Information

D1250 Battery (12 V, 5 Ah)

D1250

A 12 V sealed lead-acid battery for standby and auxiliary power. Suitable for supplying backup power for fire, security, and access control systems during AC power failures.

D126 Standby Battery (12 V, 7 Ah)



Features

- ▶ **12 VDC sealed lead-acid**
- ▶ **Fully rechargeable**
- ▶ **Maintenance-free**
- ▶ **For use as secondary power for accessory modules**
- ▶ **Long service life**

A maintenance-free, sealed lead-acid, standby and auxiliary power supply that provides long service life and dependability.

The battery is for use only with charging circuits calibrated for lead-acid batteries. It is suitable for supplying backup power for fire, security, and access control systems during AC power failures.

The D126 fits in any of the currently offered enclosures and connects to the two color-coded battery leads supplied with the control panel or module. Use a D122 Dual Battery Harness to connect two D126 batteries in parallel and double the amp hour output.

Certifications and Approvals

Region	Certification	
USA	UL	ALVY: Access Control Systems Units (UL294), APOU: Proprietary Alarm Units (UL1076), UEHX7: Signaling Appliances, Miscellaneous Certified for Canada (cUL)
	FM	
	CSFM	7167-1615: 100, 7165-1615: 112, 7165-1615: 113, 7165-1615: 119, 7167-1615: 124, 7170-1615: 144, and 7170-1615: 145 July 2008
	NYC/BSA	582-85-SA
	DSI	CDFM

Installation/Configuration Notes

Standby Power Requirements

Refer to the appropriate control panel installation manual for information on calculating the standby battery requirements for the system. Total continuous and intermittent current requirements must not exceed the amp hour capacity of the battery.

Technical Specifications

Capacity:	12 V, 7 Ah
Compatible Panels:	Compatible with all control panels
Dimensions:	15 cm x 8 cm (6 in. x 3 in.)
Height with Terminals:	10 cm (4 in.)
Weight:	2.5 kg (5.5 lb)

Ordering Information

D126 Standby Battery (12 V, 7 Ah)

Sealed lead-acid standby and auxiliary rechargeable power supply.

D126

ICP-EZPS Wire-in Power Supply



For use in Europe, the Middle East, Asia Pacific, Central and South America. 100 VAC to 240 VAC primary voltage input (AC).

Certifications and Approvals

Region	Certification
Europe	CE 1999/5/EC, 2006/95/EC, 2004/108/EC; EN 55022:2006 + A1:2007, Class B; EN 50130-4 w/A1:1998 + A2:2003; EN61000-3-2:2006; EN61000-3-3:1995; EN 60950-1:2001; TBR21:1998

Technical Specifications

Primary Voltage Input (AC): 110 V +10/-15% (60 Hz)
230 V +10/-15% (50 Hz)

Ordering Information

ICP-EZPS Wire-in Power Supply **ICP-EZPS**
For use in Europe, the Middle East, Asia Pacific, Central and South America. 100 VAC to 240 VAC primary voltage input (AC).

ICP-EZPS-FRA AFNOR Power Supply

Technical Specifications

Primary Voltage Input (AC): 110 V +10/-15% (60 Hz)
230 V +10/-15% (50 Hz)

Ordering Information

ICP-EZPS-FRA AFNOR Power Supply **ICP-EZPS-FRA**
For use in France. Provides 14 VDC and isolated auxiliary power outputs.

NEV 300 LSN power supply

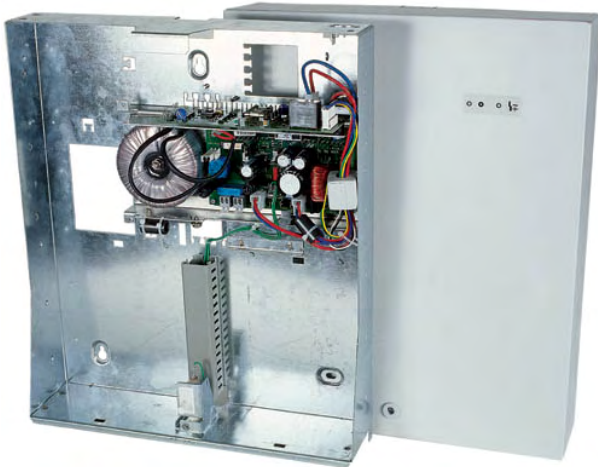

Features

- ▶ Can be connected to all LSN control panels (centralized or decentralized)
- ▶ A maximum of two 12 V/17 Ah batteries can be used
- ▶ Monitoring of mains and battery voltage
- ▶ Tamper protection (tamper contact)
- ▶ 3 freely programmable open collector outputs
- ▶ Slot for optional voltage converter (to 28 V)

The NEV 300 LSN is an additional power supply for LSN control panels.

System Overview

This additional power supply for LSN control panels is connected to the LSN local security network in an LSN loop or in max. 2 LSN stubs.

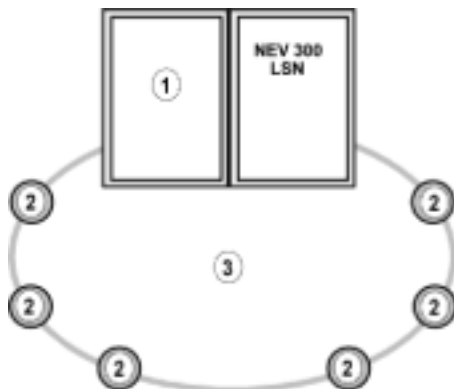

- 1 LSN control panel
- 2 LSN element
- 3 Connection in an LSN loop or in up to 2 LSN stubs

Functions

Control assembly:

- 230 V mains supply
- Power failure protection, transformer connection, rectifier
- Battery charge control and monitoring
- Battery check
- Voltage surge protection
- Fault recognition and display

Connector board

- LSN lines with power supply connection
- Battery connection
- External user connection
- Slot for 28 V voltage converter
- Fuses for voltage outputs
- 3 open collector outputs (C points), 2 relay modules can be plugged in if needed

The power supply is a separate LSN element and is programmed from the control panel with the corresponding program. Message types such as tampering with tamper contacts and power supply or battery faults are transmitted to the control panel via LSN.

The battery charge voltage is set at the factory. The controller and the internal temperature sensor ensure temperature-adjusted battery charging. A remote PTK tracker can be used if needed. Should readjustment be necessary, this is carried out via a potentiometer on the control assembly.

The battery monitor identifies when voltage falls below discharge level, interruption and short-circuit of the battery cable. The test cycle can be set to 1 min. or 15 mins. The battery load test lasts for 2 seconds and is switched off if the regulator is inoperative (power failure).

Device display

The display visible from the outside contains the operating indicator (green LED) that is lit when the battery and/or 230 V is connected, and the power supply failure indicator (yellow LED) that is lit when a battery and/or mains fault occurs.

Certifications and Approvals

Region	Certification	
Europe	CE	NEV 300 LSN
Germany	VdS	G 103030, C NEV 300 LSN

Installation/Configuration Notes

- The energy balance is determined according to VDE 0833 and created using the "uezpro" planning and current calculation program. The limits are calculated automatically. Any external peripheral devices connected must be included in the calculation.
- Current consumption at 12 V; 1.2 A per connection point

- The LSN a/b line current, max. 100 mA, is supplied by the control panel.
- The NEV 300 LSN can be operated directly next to the control panel (centralized) or remotely (decentralized).
- Installation cable for LSN technology: J-Y(St)Y
- Shielding (drain wire) must be routed to the ground connectors for each LSN line. There must be no connection between the housing potential and the LSN cable shielding.

28 V voltage converter (optional)

The basic voltage of the power supply is 12 V. If the voltage drop is too high due to cable length, a 28 V voltage converter (optional) can be plugged into the connector board. 28 V for 2 x +V/0 V and 1 x user output as needed. Power intake for the three outputs totals 500 mA.

TRN panel relay module (optional)

Panel module with 2 relays for zero potential outputs, one switching contact per relay. Up to 2 units can be plugged into the connector board.

Parts Included

Type	Qty.	Component
NEV 300 LSN	1	Housing, control assembly, connector board, and cable set without batteries, panic button incl. adhesive seal

Technical Specifications

Power supply		
• Protection class	I (DIN VDE 0106 Part 1)	
• Mains voltage	230 V (+10% to -15%)	
• Mains frequency	50 Hz	
LSN technology		
• Operating voltage	+15 V to +31 V	
• Current consumption	Max. 3.85 mA	
Control unit		
• Battery charge voltage	From 0 °C to 50 °C according to the battery charge discharge characteristics (factory setting: 13.8 V at 20 °C)	
• Battery charge	Bk/20 at 34 Ah = 1.7 A	
• Battery capacity	12 V/2 x 17 Ah	
• Output voltage	Corresponds to battery charge voltage	
• Output current (battery charge current + user current)	Max. 4.0 A	
Current available on connector board		
• +V/0 V and external users	Max. 2.3 A	
• With bridging time of 60 hrs	< 600 mA	
• With bridging time of 30 hrs	< 1.2 A	
• Current available at 28 V from connector board (+V/0 V and ext. users)	500 mA in total	

Voltage control protection	
• Protection for control	> 16 V
• Voltage surge protection	> 5.5 A
Monitoring	
• Network fault	< 130 V
• Battery fault (discharge battery)	≤ 10.5 V
• Total battery discharge protector (TES)	< 10 V
Switch outputs (C points)	
• Principle	Open collector (short-circuit resistant)
• Max. voltage	10 V to 30 V
• Maximum current	300 mA
28 V voltage converter (optional)	
Load current	Max. 500 mA in total
Electromagnetic compatibility (EMC)	
• Interference immunity	DIN EN 50130-4
• Interference emissions	DIN EN 50081-1
Environmental conditions	
• Ambient temperature (in operation)	-5 °C to +45 °C
• Storage and transport temperature	-25 °C to +70 °C
• Environmental class	II (VdS 2110)
Housing protection category	IP 30
Humidity	+40 °C, 93% rel. humidity
Housing	
• Dimensions (H x W x D)	460 x 380 x 97 mm
• Color	Light gray/RAL 7035
Weight (without batteries/with batteries)	2 kg/15 kg

Ordering Information

NEV 300 LSN power supply **4998111983**

For additional power supply to LSN control panels, housing incl. 12 V/4.0 A power supply unit, a maximum of two 12 V/17 Ah batteries can be used

Accessories

TRN panel relay module **ICP-TRN**

With 2 relays, one switching contact per relay for zero potential outputs

ERWE 10 voltage converter **ERWE 10**

For connecting NBK 100 LSN, NTK 100 LSN, NSB 100 LSN, MSS 401, ERT 100, FK 100 LSN, can be plugged into the NEV 300 LSN connector board

ICP-EZPK Programming Key



Transfers program information to and from the control panel. Use the programming key to quickly program a group of Easy Series Intrusion Control Panels with the same characteristics. The programming key is color-coded blue.

Certifications and Approvals

Region	Certification
Europe	CE 1999/5/EC, 2006/95/EC, 2004/108/EC; EN 55022:2006 + A1:2007, Class B; EN 50130-4 w/A1:1998 + A2:2003; EN61000-3-2:2006; EN61000-3-3:1995; EN 60950-1:2001; TBR21:1998

Ordering Information

ICP-EZPK Programming Key

Blue key for transferring information to and from Easy Series Intrusion Control Panels.

ICP-EZPK

CC808 Direct Link Cable



Ordering Information

CC808 Direct Link Cable

Cable to connect CC816 Alarm Link Software (A-Link) to Solution 862, Solution 880 Ultima, and Solution 16 Control Panels.

CC808

IUI-EZT-5 Easy Series Token Package



Five Easy Series proximity tokens.

Ordering Information

IUI-EZT-5 Easy Series Token Package
Five Easy Series proximity tokens.

IUI-EZT-5

Software

3

Programming Software

114

Remote Programming Software International



3

Features

- ▶ Supports multiple workstations on a network
- ▶ Supports SQL database
- ▶ Works with Microsoft® Windows® 2000 and Windows XP Service Pack 2
- ▶ Supports either static IP or hostname addressing
- ▶ Allows users to select a modem appropriate for the control panel type
- ▶ Supports a modem connected to each workstation

Remote Programming Software International (RPS-INTL) is an account management and panel-programming utility for the Microsoft® Windows® operating system. It is designed to remotely or locally program specific control panels.

Functions

Control Panel Management Tasks

RPS-INTL allows users with a Microsoft Windows-based computer and a modem to perform remote programming, record storage, remote control, and troubleshooting for specific control panels.

Interface

The interface allows users to:

- Sort columns in ascending or descending order
- Log in or log out without terminating the software

The interface provides users with:

- An animated progress dialog box during control panel synchronization and downloading
- A toolbar link to quickly access specified accounts

The interface automatically times out when communication is inactive.

Report Capability

All report types are fully functional. Users can select a range of pages and either print them or save them as an HTML, .pdf, .rtf, .xls, or .txt file.

Context-sensitive and Quick Help

Selectable, context-sensitive Help files correspond to the program record sheet items for each control panel. The control panel's account window provides Quick Help information regarding the fields in the control panel's settings pane. The Quick Help information changes when the cursor moves over the fields.

Local- and Wide-area Network Accessibility

RPS-LITE uses static IP addresses or a host name, including Domain Name System (DNS), to connect to control panels on a local-area network (LAN) or wide-area network (WAN). The connection provides fast uploads and downloads.

Remote Diagnostics

Remote diagnostics allow users to:

- View control panel and point status
- Bypass and reset points
- Arm and disarm
- Silence bells
- Reset sensors
- Perform relay, time, and date functions
- Retrieve and view control panel history
- View SDI and option bus device status

Installation/Configuration Notes

Compatible Products

Control Panels	Easy Series¹, DS7220, DS7220-SPA (version 1.52 and higher), DS7220V2-EXP, DS7220V2-FRA, DS7220V2-SWE, and DS7220V2-UK DS7240, DS7240csc, DS7240-EXP, DS7240-HUN, DS7240-FRA, DS7240-NOR, DS7240-SPA (version 1.05 and version 1.52 and higher), DS7240-SWE, DS7240-UK, DS7240V2-EXP, DS7240V2-SWE DS7400XiV4-EXP (version 4.10 and higher)
Fire Alarm Control Panels (FACP)	FPA-5000 DS9400
Modems	MODEM-KIT-2400B
Modules	DX4010i RS-232 Serial Interface Module Conetix DX4020 Network Interface Module

Access to products can vary depending on the installation configuration.

¹ IP communication is not available in Easy Series systems.

Technical Specifications

Mechanical

Compatible Modems

Refer to the online Help file included in the RPS installation for a list of compatible modems. Generally, modems must originate a call in Answer Mode but must not use data compression, flow control, or error correction (LAPM, MNP).

Answer Tones:	Must transmit 2025 Hz or 2270 Hz answer tones
Protocol:	Must be capable of BELL System 103 or V.21 protocol
Transmission Rate:	300 bps
Transmission Type:	Asynchronous

Computer System Requirements

Hard Disk Space:	Approximately 250 MB
Operating System:	Microsoft Windows 2000 Windows XP Service Pack 2
Processor:	Pentium® III, 800 MHz minimum
RAM:	256 MB
Video:	VGA monitor capable of supporting 1024 x 768 resolution. The software will support 24-bit color palettes and lower. Font settings should be set to "Small Fonts."

Trademarks

Microsoft® and Windows® are either registered trademarks or trademarks of Microsoft Corporation in the United States and/or other countries.

Pentium® is a registered trademark of Intel Corporation or its subsidiaries in the United States and other countries.

Ordering Information

Remote Programming Software International

RPS-INTL

Software for remote or local control panel programming. Requires a Microsoft® Windows® operating system.

WDSRP Remote Programming Software for Windows



3

Features

- ▶ **Windows 3.1/ 95/ 98/ 2000 compatible**
- ▶ **Unattended service**
- ▶ **Remote diagnostics**
- ▶ **Quick uploads/downloads**
- ▶ **Report capability**
- ▶ **Anti-takeover lockout**
- ▶ **Context sensitive on screen help**
- ▶ **IBM PC/Hayes modem (2400B Modem Kit) or DC110 SecureCom modem compatible**

WDSRP is a remote programming software package that provides a means of programming and alarm control panels. It operates on standard IBM compatible PCs running Microsoft® Windows® with an industry standard modem. It provides unattended remote programming, and unique account data base features.

Functions

Account Service

When it comes to finding or sorting accounts, few programs approach the flexibility of our Key Search. Accounts contained in the WDSRP database can be located or sorted based on phone numbers, names, addresses, account numbers, and sort keys. Unlike most programs, you do not need to know the account number to find a customer file.

Anti-takeover Lockout

Some control panels feature an anti-takeover lockout that will deny unauthorized people the ability to reprogram the control panel from the keypad. This feature can be set to lock out phone number changes only, thus preventing account takeover, while allowing local service of other features, or it can be set to lock out all keypad programming.

Context-sensitive On-screen Help

Help prompts explain each screen item as it is selected. At any time a full page of additional context-sensitive help information may be displayed on the screen. The Help system provides an on-screen manual for complete details on the operation of the program.

Enhanced Security

With all the power of the WDSRP software, we have not forgotten about the security of your sensitive account data. We have provided multiple authority levels that can be customized to your requirements. You can restrict program users from changing panel arm states, deny them access to sensitive information, or blank out whole screens of data. You can assign each program operator their own password and the WDSRP system provides a transaction record of the last user to make changes, thus providing operator accountability.

The WDSRP control to phone link is also secure since each DS7060, DS7080, DS7090, DS7100 and DS7400 panel contains a 10-digit password (one trillion unique combinations). This password cannot be changed or read at the panel. Selecting the remote callback option can enhance security and reduction of phone costs. Panels can be programmed to send a digital central station report of remote programming sessions.

Flexible Phone Call Handling

The supported control panels, together with the WDSRP software, support unattended remote programming even when both the panel and WDSRP are unattended, and they also support optional call back.

Multiple Phone Line Capability

WDSRP can be configured to use up to four different modems and phone lines simultaneously. This allows multiple control panels to communicate at the same time.

Pulse/Tone Dialing

The WDSRP program can initiate calls on either a pulse or tone dial format so you will have no problem with phone system compatibility.

Quick Uploads/Downloads

Proprietary data compression technique reduces the time it takes to upload or download panel programming. One parameter can be changed in as little as eight seconds. Programmed values are not up/downloaded unless they have been modified.

Reduced Liability

The supported control panels maintain all local functionality while remote programming sessions are in progress. No indication of remote program access is visible from the keypad. The control panel can still be armed, disarmed, bypassed with all alarm sounders operational. Your liability is limited since remote programming sessions will not result in lengthy periods of panel in-operation that could result in delayed response to emergencies. An alarm that occurs while the remote programmer is on-line will automatically stop and disconnect the remote programming session and report the alarm to central station.

Remote Diagnostics

Gives the ability to:

- Upload and view the control panel history and see zone status in real time
- See all troubles
- Remote trouble reset and battery test and remote smoke reset and total system reset
- Remotely see and change alarm outputs and relay states
- Remote EEPROM re-initialization

Report Capability

Provides the ability to print reports of history and general account information to a standard printer, to a disk file, or to a window. Reports can be for a single account or a group of accounts. History reports can be selected by the type of event such as all alarms or all supervisory events.

Template Files

The WDSRP System also simplifies account maintenance through the use of Template Files. Each WDSRP system can have 100 template files that store the common characteristics of similar accounts. Changing any item in the template file will automatically change the database of all accounts that reference it. For example, many systems share the same information as central station phone numbers, reporting formats, bell timers, etc. A template can be created which contains these values. Subsequent accounts created using the template would automatically have this information. To set up a new account, the programmer would have to enter only the information that was specific to each account such as user codes and zone configuration.

Unattended Service

WDSRP gives you the timesaving convenience of unattended service changes, so you do not have to chain your most valuable service person to a computer screen. Simply make program changes to the account in the WDSRP database. WDSRP software can receive calls unattended so your changes will be made automatically the next time the control panel "calls in."

Technical Specifications

Free Hard Disk Space	10 MB
Modems	IBM PC/Hayes Smartmodem (300, 1200, 1200B, 2400, or 2400B)
Operating System	Microsoft Windows 3.1 with DOS version 5.0 or higher, Windows 95, Windows 98, or Windows 2000.
Processor	486DX or greater
RAM	8 MB
Video	A VGA or better monitor.
Operator Input	Mouse or other pointing device.

Trademarks

Microsoft® and Windows® are either registered trademarks or trademarks of Microsoft Corporation in the United States and/or other countries. Pentium® is a registered trademark of Intel Corporation or its subsidiaries in the United States and other countries.

Ordering Information**WDSRP Remote Programming Software for Windows**

Remote programming software for control panels.

WDSRP/3

Arming Devices

4

Conventional	120
LSN	124

SE 50 GLT SmartKey Blocking Unit

4

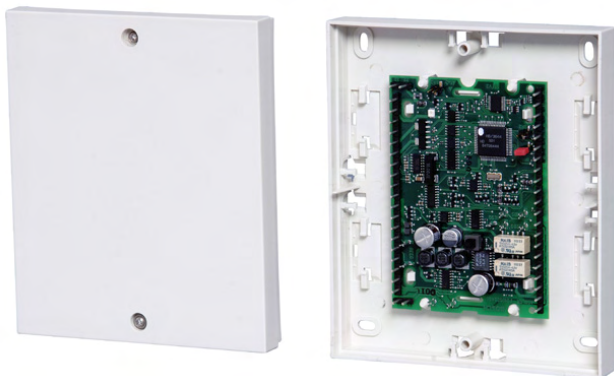

Features

- ▶ The SE 50 conventional control unit is programmable via the control panel
- ▶ The SPE blocking element is controlled via the intrusion control panel
- ▶ The SPE blocking element is suitable for various types of doors

The SmartKey blocking unit (conventional) is used to mechanically lock doors.

System Overview

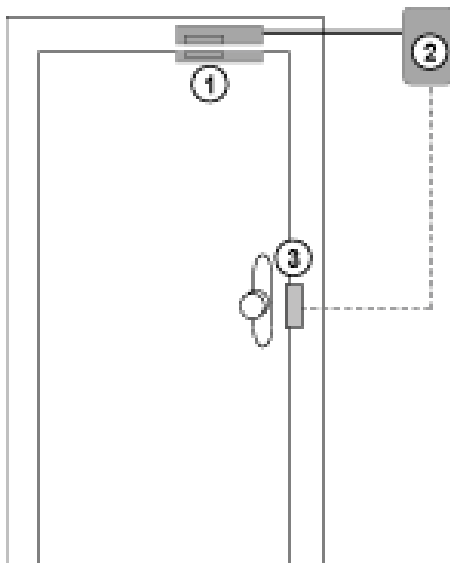

- 1 SPE Blocking element
- 2 SE 50 conventional (GLT) control unit
- 3 Bolt contact

Functions

The SE 50 GLT control unit controls the blocking element depending on the state of the bolt contact and/or the intrusion control panel. When the door is closed (bolt contact is activated), the bolt of the blocking element is automatically engaged. When the door is unlocked, the bolt is disengaged if the detection area is disarmed. When the detection area is activated, the bolt remains engaged, thus preventing unintended access to the area. If no bolt contact is present, the bolt of the blocking element is engaged by the activation signal issued by the control panel.

SE 50 GLT

The SE 50 conventional (GLT) control unit processes the status reports of all components in the system, communicates these reports to the intrusion alarm system and controls the blocking element. The control unit is mounted in the secure area.

SPE blocking element

The SPE blocking element is an additional lock for the door and is intended to prevent unauthorized entry to the armed area. The blocking element must always be mounted in the secure area with a kit to allow it to be fitted out for different door types.

A conventional bolt contact should be fitted to the control unit (not part of the scope of delivery).

A conventional standard magnet contact can be connected to the control unit (not part of the scope of delivery).

Certifications and Approvals

Region	Certification	
Europe	CE	SE 50 GLT SmartKey
Germany	VdS	G 106066, C SE 50 GLT

Installation/Configuration Notes

The blocking element is always mounted in the secure area with a mounting kit.

Parts Included

Type	Qty.	Component
SE 50 GLT	1	Control unit

Technical Specifications

SE 50 GLT control unit

Operating voltage	10.8 V to 30.0 V
Total current consumption including blocking element	
• Bolt disengaged	38 mA
• Bolt engaged	53 mA
• When being engaged	140 mA for 300 ms
• When blocking	200 mA for 200 ms
Environmental conditions	
• Protection category	IP 30
• Operating temperature	-5 °C to +45 °C
• Storage temperature	-40 °C to +85 °C
Housing	
• Material	ABS
• Color	RAL 9002
Dimensions (H x W x D)	160 x 135 x 35 mm
Weight	0.25 kg
SPE blocking element	
Bolts max. distance to locking plate	4 mm
Break force for emergency open	0.8 to 1 kN
Cable to control unit	Max. 6 m, 6-pin, shielded, permanently cast
Environmental conditions	
• Protection category	IP 44
• Operating temperature	-25 °C to +55 °C
• Storage temperature	-40 °C to +85 °C
Housing	
• Material	ABS
• Color	RAL 9002
Dimensions (H x W x D)	28 x 118 x 16 mm
Weight	
• Surface mounting models	0.45 kg
• Flush mounting models	0.40 kg

Ordering Information

SE 50 GLT SmartKey Blocking Unit For mechanically locking doors	IUI-SKCU0C-50
Accessories	
Blocking element	4998149110
Kit for surface mounting, space for magnetic contact	4998013609C20
Kit for recessed mounting (door frame)	4998021691C20
Kit for mounting in glas doors	4998019339C20
Kit for upgrading NBS 10	4998040651C20

SE 100 GLT SmartKey Arming Device

4

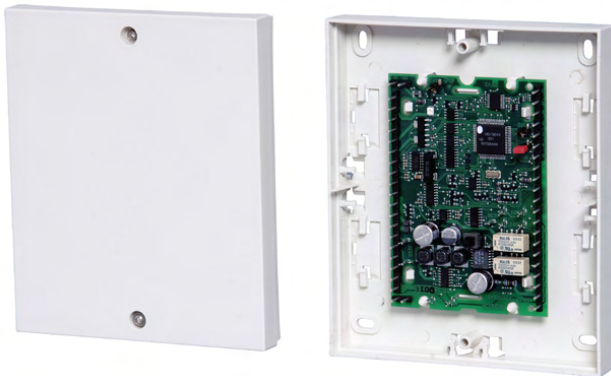

Features

- ▶ The arming device is programmable via the control panel
- ▶ Suitable for various types of doors
- ▶ High security through “Challenge & Response” procedure
- ▶ No manipulation or tampering possible

The SmartKey arming device is a system solution for arming/disarming intrusion alarm systems.

System Overview

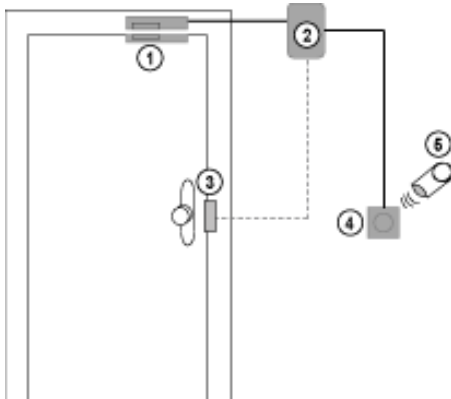

- 1 SPE blocking element
- 2 SE 100 GLT control unit
- 3 Bolt contact
- 4 Reader
- 5 SmartKey keys

Functions

The individual components of the system can be put together as required for the intended usage. The SE 100 GLT can be operated with or without the blocking element.

SE 100 GLT

The SE 100 conventional (GLT) control unit processes the status reports of all components in the system, communicates these reports to the intrusion alarm system and controls the blocking element. The control unit is mounted in the secure area.

Reader

Arming and disarming is done using an electronic key on the reader. LED and buzzer provide information about the status of the system as well as operation. The reader can be surface mounted or flush mounted (outside the secure area).

Keys with a security card

The system operates like a locking device. The key kit consists of a set number of valid keys and a security card. The control unit is initialized using the security card, and accepts only the keys of the key kit. To order additional keys, the security card must be sent to the manufacturer together with the order. The keys are labeled with a consecutive key number, a security card number and an 8-digit identification number.

Standard key (without security card)

The keys are not numbered and can be read in as often as required. The keys are labeled with an 8-digit identification number.

SPE blocking element

The SPE blocking element is an additional lock for the door and is intended to prevent unauthorized entry to the armed area. The blocking element must always be mounted in the secure area with a kit to allow it to be fitted out for different door types. The SE 100 GLT can be operated with or without the blocking element.

A conventional bolt contact can be connected to the control unit (not part of the scope of delivery).

A conventional standard magnet contact can be connected to the control unit (not part of the scope of delivery).

Certifications and Approvals

Region	Certification	
Europe	CE	SE 100 GLT SmartKey
Germany	VdS	G 106067, C SE 100 GLT

Installation/Configuration Notes

- A maximum of 16 SmartKey keys per system can be used. The keys are read in at the reader.

- The input unit should primarily be installed flush-mounted.

Parts Included

Type	Qty.	Component
SE 100 GLT	1	Control unit
	1	Reader

Technical Specifications

SE 100 GLT control unit

Operating voltage	10.8 V to 30 V
Total current consumption including blocking element and reader	
<ul style="list-style-type: none"> Standby armed 	53 mA
<ul style="list-style-type: none"> Standby disarmed 	68 mA
<ul style="list-style-type: none"> When being engaged 	140 mA for 300 ms
<ul style="list-style-type: none"> When blocking 	200 mA for 200 ms
Environmental conditions	
<ul style="list-style-type: none"> Protection category 	IP 30
<ul style="list-style-type: none"> Operating temperature 	-5 °C to +45 °C
<ul style="list-style-type: none"> Storage temperature 	-40 °C to +85 °C
Housing	
<ul style="list-style-type: none"> Material 	ABS
<ul style="list-style-type: none"> Color 	RAL 9002
Dimensions (H x W x D)	160 x 135 x 35 mm
Weight	0.25 kg
Reader	
Range	Max. 20 mm
Frequency	125 kHz
Transmission power	250 mW
Transmission power	250 mW
Cable to control unit	Max. 6 m, 6-pin, shielded, permanently cast
Environmental conditions	
<ul style="list-style-type: none"> Environmental class 	3
<ul style="list-style-type: none"> Protection category 	IP 65
<ul style="list-style-type: none"> Operating temperature 	-25 °C to +70 °C
<ul style="list-style-type: none"> Storage temperature 	-40 °C to +85 °C
Housing	
<ul style="list-style-type: none"> Material 	ASA Luran S
<ul style="list-style-type: none"> Color 	Titanium white (similar to RAL 9010)
Dimensions (H x W x D)	80 x 80 x 30 mm
For installation in 55 mm surface-mounted/flush-mounted junction box	
Weight	0.35 kg

Ordering Information

SE 100 GLT SmartKey Arming Device	IUI-SKCU1C-100
For arming/disarming an intrusion alarm system via the reader as a system solution	
Accessories	
Kit for recessed mounting (door frame)	4998021691C20
Kit for surface mounting, space for magnetic contact	4998013609C20
Kit for upgrading NBS 10	4998040651C20
Blocking element	4998149110
Kit for mounting in glas doors	4998019339C20

SE 60 LSNi SmartKey Blocking Unit

4



Features

- ▶ The SE 50 LSNi conventional control unit is programmable via the control panel
- ▶ The SPE blocking element is controlled via the intrusion control panel
- ▶ The SPE blocking element is suitable for various types of doors

The SE 60 LSNi SmartKey blocking unit is used as a mechanical lock for doors.

System Overview

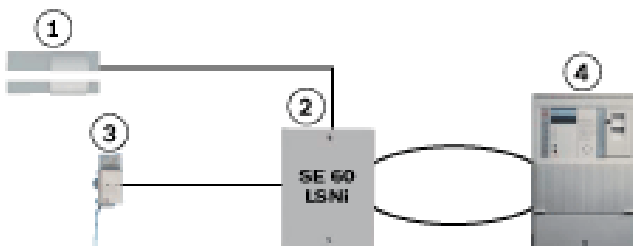

- 1 SPE blocking element
- 2 SE 60 LSNi control unit
- 3 Bolt contact
- 4 LSN control panel

Functions

The SE 60 LSNi control unit controls the SPE blocking element depending on the state of the bolt contact and/or the intrusion control panel. When the door is closed (bolt contact is activated), the bolt of the SPE blocking element is automatically engaged. When the door is unlocked, the bolt is disengaged if the detection area is disarmed. When

the detection area is activated, the bolt remains engaged, thus preventing unintended access to the area. If no bolt contact is realized, the bolt of the SPE blocking element is engaged by the activation signal issued by the control panel.

SE 60 LSNi

The SE 60 LSNi control unit processes the status reports of all components in the system, communicates these reports to the intrusion alarm system and controls the SPE blocking element. The control unit has a lock line for connecting bolt contacts and two primary lines for connecting e.g. magnet contacts. The control unit is mounted in the secure area.

SPE blocking element

The SPE blocking element is an additional lock for the door and is intended to prevent unauthorized entry to the armed area. The SPE blocking element must always be mounted in the secure area with a kit to allow it to be fitted out for different door types.

Motorized block function: All blocking elements for an area are engaged and disengaged simultaneously.

A conventional bolt contact should be fitted to the control unit (not part of the scope of delivery).

A conventional standard magnet contact can be connected to the control unit (not part of the scope of delivery).

Certifications and Approvals

Region	Certification	
Europe	CE	SE 60 LSNi SmartKey
Germany	VdS	G 106062, C SE 60 LSNi
Coun-try	Certification	SE 60 LSNi
DE	VdS	G 106062, C

Installation/Configuration Notes

Note The SmartKey is fully operational only in conjunction with a blocking element.

The SPE blocking element is always mounted in the secure area with a mounting kit.

If several LSN SmartKey systems need to block simultaneously in one area (motorized block locking function), the control units must be in the same LSN processing assembly (on LVM for UEZ, on NV 120 for UGM).

SE 60 LSNi without bolt contact:

Due to the time shift caused by the LSN, up to four SE 60 LSNi can be activated in 200 ms (not arming time). In general, a bolt contact should be mounted.

Parts Included

Type	Qty.	Component
SE 60 LSNi	1	SmartKey blocking unit, control unit

Ordering Information

SE 60 LSNi SmartKey Blocking Unit
For mechanically locking doors

IUI-SKCUOL-60

Technical Specifications**SE 60 LSNi control unit**

Operating voltage	9.6 V to 30 V
Total current consumption including blocking element at an input voltage of 9.6 V	
• Standby LSN part	3.53 mA
• Standby additional supply	41 mA
• Bolt is engaged	110 mA for 200 ms
• Bolt blocked	470 mA for 200 ms
Total current consumption including blocking element at an input voltage of 28 V	
• Standby LSN part	2.5 mA
• Standby additional supply	30 mA
• Bolt is engaged	65 mA for 200 ms
• Bolt blocked	200 mA for 200 ms
Environmental conditions	
• Environmental class	2
• Protection category	IP 30
• Operating temperature	-5 °C to +45 °C
• Storage temperature	-40 °C to +85 °C
Housing	
• Material	ABS
• Color	RAL 9002
Dimensions (H x W x D)	160 x 135 x 35 mm
Weight	0.25 kg
SPE blocking element	
Bolt max. distance to locking plate	4 mm
Break force for emergency open	0.8 to 1 kN
Cable to control unit	Max. 6 m, 6-pin, shielded, permanently cast
Environmental conditions	
• Environmental class	3
• Protection category	IP 44
• Operating temperature	-25 °C to +55 °C
• Storage temperature	-40 °C to +85 °C
Housing	
• Material	ABS
• Color	RAL 9002
Weight	
• Surface mounting models	0.45 kg
• Flush mounting models	0.40 kg
Dimensions (H x W x D)	28 x 118 x 16 mm

SE 120 LSNi SmartKey Arming Device



4

Features

- ▶ **Simple, non-contact operation**
- ▶ **High security through “Challenge & Response” procedure**
- ▶ **Clear signaling prevents operational errors**
- ▶ **No manipulation or tampering possible**
- ▶ **Detailed logging of arming via the LSN control panel**
- ▶ **The arming device is programmable via the control panel**
- ▶ **Motorized block locking function: All blocking elements for an area are engaged and disengaged simultaneously.**
- ▶ **Suitable for various types of doors**

The SmartKey arming device is a system solution for arming/disarming intrusion alarm systems.

System Overview

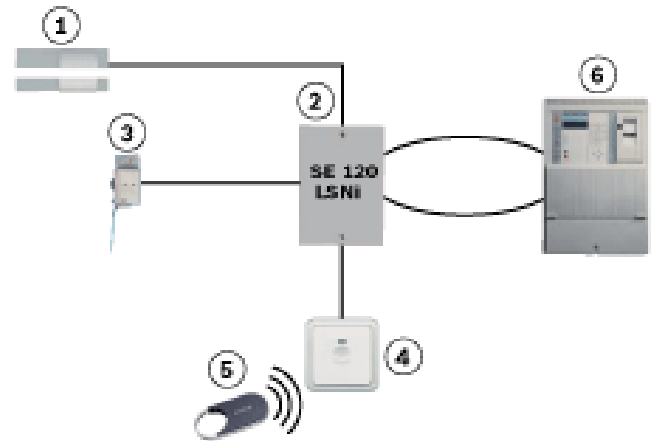

- 1 SPE blocking element
- 2 SE 120 LSNi control unit
- 3 Bolt contact
- 4 Reader
- 5 SmartKey keys
- 6 LSN control panel

Functions

Individual system components can be put together depending on the usage conditions required. Operation modes with or without the SPE blocking element are possible.

SE 120 LSNi

The SE 120 LSNi control unit processes the status reports of all components in the system, communicates these reports to the intrusion alarm system and controls the blocking element. The control unit has a lock line for connecting bolt contacts and two primary lines for connecting e.g. magnet contacts. The control unit is mounted in the secure area.

Reader

Arming and disarming is done using an electronic key on the reader. LED and buzzer provide information about the status of the system as well as operation. The reader can be surface mounted or flush mounted (outside the secure area).

Keys with a security card

The system operates like a locking device. The key kit consists of a set number of valid keys and a security card. The control unit is initialized using the security card, and accepts only the keys of the key kit. To order additional keys, the security card must be sent to the manufacturer together with the order. The keys are labeled with a consecutive key number, a security card number and an 8-digit identification number.

Standard key (without security card)

The keys are not numbered and can be read in as often as required. The keys are labeled with an 8-digit identification number.

SPE blocking element

The SPE blocking element is an additional lock for the door and is intended to prevent unauthorized entry to the armed area. The SPE blocking element must always be mounted in the secure area with a kit to allow it to be fitted out for different door types.

Motorized block locking function: All blocking elements for an area are simultaneously engaged and disengaged.

A conventional bolt contact should be fitted to the control unit (not part of the scope of delivery).

A conventional standard magnet contact can be connected to the control unit (not part of the scope of delivery).

Certifications and Approvals

Region	Certification	
Europe	CE	SE 120 LSNi SmartKey
Germany	VdS	G 106063, C SE 120 LSNi
Coun-try	Certification	SE 120 LSNi
DE	VdS	G 106063, C

Installation/Configuration Notes

Number of SmartKey keys

A maximum of 16 SmartKey keys can be used per system if the SmartKey key is read in at the reader. In other respects, the number of SmartKey keys depends on the control panel: NZ 300 LSN = 40 keys, UEZ = 255 keys.

SE 120 LSNi without bolt contact

Due to the time shift caused by the LSN, up to four SE 120 LSNi can be activated in 200 ms (not arming time). In general, a bolt contact should be mounted.

SPE blocking element

- If several LSN SmartKey systems need to block simultaneously in one area (motorized block locking function), the control units must be in the same LSN processing assembly (on LVM for UEZ, on NV 120 for UGM).
- The SPE blocking element is always mounted in the secure area with a mounting kit.

Parts Included

Type	Qty.	Component
SE 120 LSNi	1	SmartKey Arming device control unit

Technical Specifications

SE 120 LSNi control unit

Operating voltage	9.6 V to 30 V
Total current consumption including blocking element at an input voltage of 9.6 V	

• Standby LSN part	3.53 mA
• Standby additional supply	41 mA
• Bolt is engaged	110 mA for 200 ms
• Bolt blocked	470 mA for 200 ms

Total current consumption including blocking element at an input voltage of 28 V	
----------------------------------------------------------------------------------	--

• Standby LSN part	3.53 mA
• Standby additional supply	30 mA
• Bolt is engaged	65 mA for 200 ms
• Bolt blocked	200 mA for 200 ms

Environmental conditions

• Environmental class	2
• Protection type	IP 30
• Operating temperature	-5 °C to +45 °C
• Storage temperature	-40 °C to +85 °C

Housing

• Material	ABS
• Color	RAL 9002

Dimensions (H x W x D)	160 x 135 x 35 mm
------------------------	-------------------

Weight	0.25 kg
--------	---------

Ordering Information

SE 120 LSNi SmartKey Arming Device

For arming/disarming an intrusion alarm system via the reader as a system solution

IUI-SKCU1L-120

SE 220 LSNi SmartKey Arming Device



4

Features

- ▶ **SmartKey code keypad can be used as a "coded arming device" with integrated reader**
- ▶ **Code keypads can be used as a "coded arming device" in conjunction with the reader**
- ▶ **Simple, non-contact operation**
- ▶ **High security through "Challenge & Response" procedure**
- ▶ **Clear signaling prevents operational errors**
- ▶ **No manipulation or tampering possible**
- ▶ **Detailed logging of arming via the LSN control panel**
- ▶ **The arming device is programmable via the control panel**
- ▶ **Motorized block locking function: All blocking elements for an area are engaged and disengaged simultaneously.**
- ▶ **Suitable for various types of doors**

The SE 220 LSNi SmartKey arming device with connectable code keypad/reader is a system solution for arming/disarming intrusion alarm systems.

Arming/disarming is carried out by using the SmartKey key then entering the user code.

The arming device meets BSI requirements.

System Overview

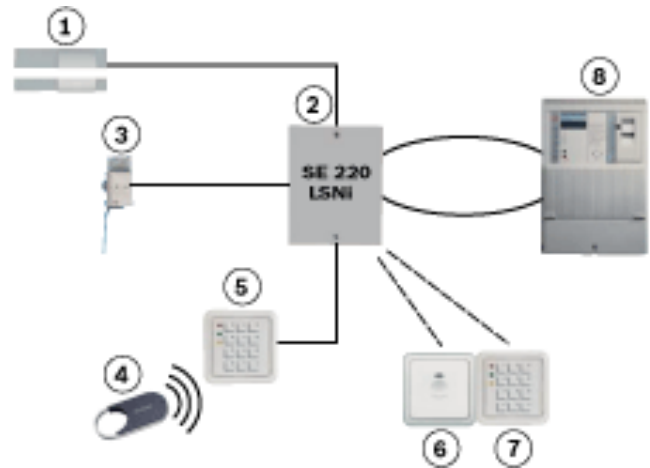

- 1 SPE blocking element
- 2 SE 220 LSNi control unit
- 3 Bolt contact
- 4 SmartKey keys
- 5 Code keypad with integrated reader
- 6 Reader
- 7 Code keypad
- 8 LSN control panel

Functions

Individual system components can be put together depending on the usage conditions required. Operation modes with or without the SPE blocking element are possible.

The SE 220 LSNi control unit processes the status reports of all components in the system, communicates these reports to the intrusion alarm system and controls the SPE blocking element. The control unit has a connection line for connecting bolt contacts and two primary lines. The control unit is mounted in the secure area.

SmartKey code keypad with integrated reader

The SmartKey code keypad with integrated reader combines the function of the reader and the SmartKey code keypad in one unit. Initial set-up and operation is the same as with one reader + one code keypad.

The reader for the SmartKey key is located in the middle of the unit (not visible from the outside). To operate, you hold the SmartKey key in the middle of the SmartKey code keypad (with integrated reader) at a maximum distance of 2 cm. The code keypad with integrated reader allows arming and disarming of the intrusion alarm system only after the correct combination of numbers has been entered at the code keypad.

Arming/disarming is carried out by using the SmartKey key then entering the user code.

If someone is forced to disarm the intrusion alarm system, a silent alarm (hold-up alarm) can be set off remotely via the code keypad. The code keypad can be surface mounted or flush mounted (outside the secure area).

Reader

Arming and disarming is carried out using an electronic key on the reader. LED and buzzer provide information about the status of the system as well as operation. The reader can be surface mounted or flush mounted (outside the secure area).

Reader and code keypad

The code keypad, used in conjunction with the reader, allows arming and disarming of the intrusion alarm system only after the correct combination of numbers has been entered at the keypad.

Arming/disarming is carried out by using the SmartKey key then entering the user code.

If someone is forced to disarm the intrusion alarm system, a silent alarm (hold-up alarm) can be set off remotely via the code keypad.

It can be surface mounted or flush mounted (outside the secure area). For flush mounting, two IP55 flush-mounted junction boxes may be used in combination, if required. One on top of the other or next to each other.

Reader and lockable code keypad

The code keypad, used in conjunction with the reader, allows arming and disarming of the intrusion alarm system only after the correct combination of numbers has been entered at the keypad. If someone is forced to disarm the intrusion alarm system, a silent alarm (hold-up alarm) can be set off remotely via the code keypad. The code keypad can be surface mounted or flush mounted (outside the secure area).

Keys with a security card

The system operates like a locking device. The key kit consists of a set number of valid keys and a security card. The control unit is initialized using the security card, and accepts only the keys of the key kit. To order additional keys, the security card must be sent to the manufacturer together with the order. The keys are labeled with a consecutive key number, a security card number and an 8-digit identification number.

Standard key (without security card)

The keys are not numbered and can be read in as often as required. The keys are labeled with an 8-digit identification number.

SPE blocking element

The SPE blocking element is an additional lock for the door and is intended to prevent unauthorized entry to the armed area. The SPE blocking element must always be mounted in the secure area with a kit to allow it to be fitted out for different door types.

A conventional bolt contact should be fitted to the control unit (not part of the scope of delivery).

A standard magnetic contact can be connected to the control unit (not part of the scope of delivery).

Certifications and Approvals

Region	Certification	
Europe	CE	SE 220 LSNi SmartKey
Germany	VdS	G 106064, C SE 220 LSNi
Coun-try	Certification	SE 220 LSNi
DE	VdS	G 106064, C

Installation/Configuration Notes

Number of SmartKey keys

A maximum of 16 SmartKey keys can be used per system if the SmartKey key is read in at the reader. In other respects, the number of SmartKey keys depends on the control panel: NZ 300 LSN = 40 keys, UEZ = 255 keys.

SE 220 LSNi without bolt contact

Due to the time shift caused by the LSN, up to four SE 220 LSNi can be activated in 200 ms (not arming time). In general, a bolt contact should be mounted.

SPE blocking element

- If several LSN SmartKey systems need to block simultaneously in one area (motorized block locking function), the control units must be in the same LSN processing assembly (on LVM for UEZ, on NV 120 for UGM).
- The SPE blocking element is always mounted in the secure area with a mounting kit.

Parts Included

Type	Qty.	Component
SE 220 LSNi	1	SmartKey arming device control unit

Technical Specifications

SE 220 LSNi control unit

Operating voltage	9.6 V to 30 V
Total current consumption including blocking element at an input voltage of 9.6 V	
• Standby LSN part	3.53 mA
• Standby additional supply	41 mA
• Bolt is engaged	110 mA for 200 ms
• Bolt blocked	470 mA for 200 ms

SE 220 LSNi control unit

Total current consumption including blocking element at an input voltage of 28 V

• Standby LSN part	3.53 mA
• Standby additional supply	30 mA
• Bolt is engaged	65 mA for 200 ms
• Bolt blocked	200 mA for 200 ms

Environmental conditions

• Environmental class	2
• Protection category	IP 30
• Operating temperature	-5 °C to +45 °C
• Storage temperature	-40 °C to +85 °C

Housing

• Material	ABS
• Color	RAL 9002

Dimensions (H x W x D) 160 x 135 x 35 mm

Weight 0.25 kg

Ordering Information

SE 220 LSNi SmartKey Arming Device **IUI-SKCU2L-220**

For arming/disarming an intrusion alarm system via the code keypad with integrated reader as a system solution

SE 320 LSNi SmartKey Arming Device

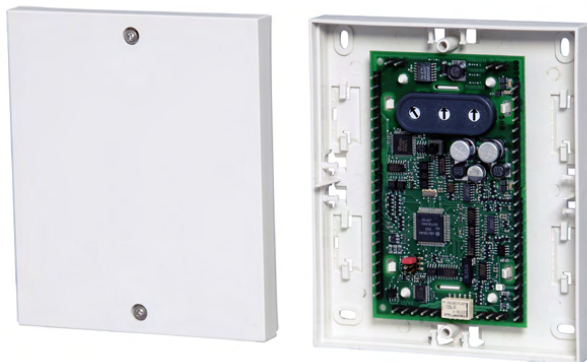

Features

- ▶ **SmartKey code keypad can be used as a "coded arming device" with integrated reader**
- ▶ **Code keypads can be used as a "coded arming device" in conjunction with the reader**
- ▶ **The SmartKey code keypad with integrated reader can also be connected as an autonomous code keypad.**
- ▶ **Blocking element connection options for vault doors**
- ▶ **Connection option for door opener relay**
- ▶ **Simple, non-contact operation**
- ▶ **High security through "Challenge & Response" procedure**
- ▶ **Clear signaling prevents operational errors**
- ▶ **No manipulation or tampering possible**
- ▶ **Detailed logging of arming via the LSN control panel**

The SE 320 LSNi SmartKey arming device with connectable code keypad/reader or just with code keypad is a system solution for arming/disarming intrusion alarm systems.

Arming/disarming is carried out by using the SmartKey key then entering the user code.

The arming device meets BSI requirements.

System Overview

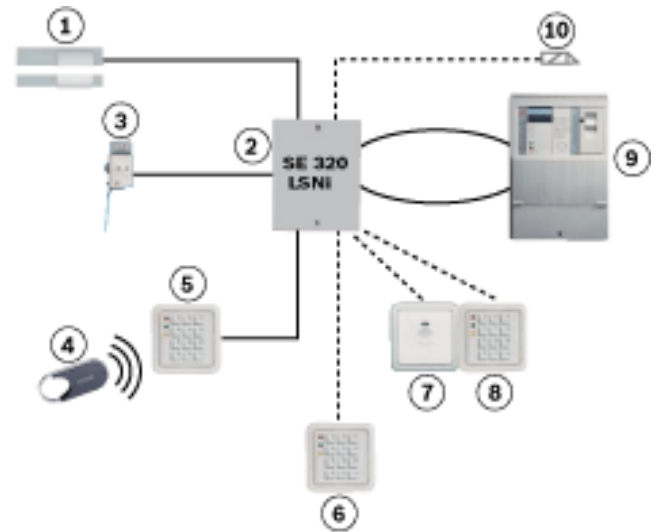

- 1 SPE blocking element
- 2 SE 320 LSNi control unit
- 3 Bolt contact
- 4 SmartKey keys
- 5 Code keypad with integrated reader
- 6 Code keypad (as autonomous code keypad)
- 7 Reader
- 8 Code keypad
- 9 LSN control panel
- 10 Door opener relay or blocking element for vault doors

Functions

Individual system components can be put together depending on the usage conditions required. Further connection options for blocking elements for vault doors and door openers are possible. Operation modes with or without the SPE blocking element are possible.

The SE 320 LSNi control unit processes the status reports of all components in the system, communicates these reports to the intrusion alarm system and controls the blocking element. The control unit has a connection line for connecting bolt contacts and two primary lines. The control unit is mounted in the secure area.

SmartKey code keypad with integrated reader

The SmartKey code keypad with integrated reader combines the function of the reader and the SmartKey code keypad in one unit. Initial set-up and operation is the same as with one reader + one code keypad.

The reader for the SmartKey key is located in the middle of the unit (not visible from the outside). To operate, you hold the SmartKey key in the middle of the SmartKey code keypad (with integrated reader) at a maximum distance of 2 cm. The code keypad with integrated reader allows arming and disarming of the intrusion alarm system only after the correct combination of numbers has been entered at the code keypad.

Arming/disarming is carried out by using the SmartKey key then entering the user code.

If someone is forced to disarm the intrusion alarm system, a silent alarm (hold-up alarm) can be set off remotely via the code keypad. The code keypad can be surface mounted or flush mounted (outside the secure area).

Reader

Arming and disarming is carried out using an electronic key on the reader. LED and buzzer provide information about the status of the system as well as operation. The reader can be surface mounted or flush mounted (outside the secure area).

Reader and code keypad

The code keypad, used in conjunction with the reader, allows arming and disarming of the intrusion alarm system only after the correct combination of numbers has been entered at the keypad.

Arming/disarming is carried out by using the SmartKey key then entering the user code.

If someone is forced to disarm the intrusion alarm system, a silent alarm (hold-up alarm) can be set off remotely via the code keypad.

It can be surface mounted or flush mounted (outside the secure area). For flush mounting, two IP55 flush-mounted junction boxes may be used in combination, if required. One on top of the other or next to each other.

Reader and lockable code keypad

The code keypad, used in conjunction with the reader, allows arming and disarming of the intrusion alarm system only after the correct combination of numbers has been entered at the keypad. If someone is forced to disarm the intrusion alarm system, a silent alarm (hold-up alarm) can be set off remotely via the code keypad. The code keypad can be surface mounted or flush mounted (outside the secure area).

Code keypad (as autonomous code keypad)

The SmartKey code keypad with integrated reader can also be connected as an autonomous code keypad. The code keypad allows arming and disarming of the intrusion alarm system only after the correct combination of numbers has been entered at the code keypad. If someone is forced to disarm the intrusion alarm system, a silent alarm (hold-up alarm) can be set off remotely via the code keypad. The code keypad can be surface mounted or flush mounted (outside the secure area).

Keys with a security card

The system operates like a locking device. The key kit consists of a set number of valid keys and a security card. The control unit is initialized using the security card, and accepts only the keys of the key kit. To order additional keys, the security card must be sent to the manufacturer together with the order. The keys are labeled with a consecutive key number, a security card number and an 8-digit identification number.

Standard key (without security card)

The keys are not numbered and can be read in as often as required. The keys are labeled with an 8-digit identification number.

SPE blocking element

The SPE blocking element is an additional lock for the door and is intended to prevent unauthorized entry to the armed area. The SPE blocking element must always be mounted in the secure area with a kit to allow it to be fitted out for different door types.

Blocking elements for vault doors

The E4.4 and E4.3 blocking elements are electromechanical blocking units that are intended for installation in vault doors or doors on safes or automatic teller machines. The blocking elements are not used as switching equipment; arming occurs via SmartKey. The blocking element for vault doors is included in the forced actuation system for arming. It is not possible to simultaneously connect an E4.4/E4.3 blocking element and an SPE blocking element and/or a door opener relay.

Door opener relay

There is a relay for activating a door opener relay on the control unit; 60 W DC (2 A, 30 V DC). Parameters must be defined for connecting the door opener; activation is only possible with an unarmed control panel and an open bolt contact. Setting of a time delay and an activation time is programmable. The door opener relay can also be activated using a push-button via PL2. Simultaneous connection to a blocking element is not possible for vault doors.

Switching point activation

There is a freely programmable C point switch output (open collector output) 12 V, max. 80 mA on the control unit.

Bolt contact/magnetic contact

A conventional bolt contact should be fitted to the control unit (not part of the scope of delivery).

A standard magnetic contact can be connected to the control unit (not part of the scope of delivery).

Certifications and Approvals

Region	Certification	
Europe	CE	SE 320 LSNi SmartKey
Germany	VdS	G 106065, C SE 320 LSNi
Coun-try	Certification	SE 320 LSNi
DE	VdS	G 106065, C

Installation/Configuration Notes

Number of SmartKey keys

A maximum of 16 SmartKey keys can be used per system if the SmartKey key is read in at the reader. In other respects, the number of SmartKey keys depends on the control panel: NZ 300 LSN = 40 keys, UEZ = 255 keys.

SE 320 LSNi without bolt contact

Due to the time shift caused by the LSN, up to four SE 320 LSNi can be activated in 200 ms (not arming time). In general, a bolt contact should be mounted.

SPE blocking element

- If several LSN SmartKey systems need to block simultaneously in one area (motorized block locking function), the control units must be in the same LSN processing assembly (on LVM for UEZ, on NV 120 for UGM).
- The SPE blocking element is always mounted in the secure area with a mounting kit.

Connection options

- E4.4 blocking elements for vault doors/conversion kit: When connecting an E4.4 blocking element/conversion kit, no SPE blocking element or door opener relay may be connected.
- Door opener relay: When connecting a door opener relay, no E4.4 blocking element/conversion kit may be connected for vault doors.
- Push-button for door opener relay: A lockable code keypad cannot be connected when connecting a push-button for the door opener.

Activation switching point

There is a freely programmable C point switch output (open-collector output) 12 V, max. 80 mA on the control unit. The max. length for a connected cable is 3 meters.

The yellow LED on the SmartKey code keypad is connected to the C point as standard. An appropriate series resistor is fitted for connecting the C point to the yellow LED on the SmartKey code keypad. If the C point is assigned for a use other than the yellow LED on the SmartKey code keypad, this series resistor must be bypassed by connecting the solder points (back of circuit boards).

Parts Included

Type	Qty.	Component
SE 320 LSNi	1	SmartKey arming device control unit

Technical Specifications

SE 320 LSNi control unit

Operating voltage	9.6 V to 30 V
Total current consumption including blocking element at an input voltage of 9.6 V	
• Standby LSN part	3.53 mA
• Standby additional supply	41 mA
• Bolt is engaged	110 mA for 200 ms
• Bolt blocked	470 mA for 200 ms
Total current consumption including blocking element at an input voltage of 28 V	
• Standby LSN part	3.53 mA
• Standby additional supply	30 mA
• Bolt is engaged	65 mA for 200 ms
• Bolt blocked	200 mA for 200 ms
C-point switch output (open collector output)	12 V, max. 80 mA. The max. length for a connected cable is 3 meters.
Relay outputs with 2 changeover contact sets	
• Switching performance	60 WDC (2 A, 30 V DC)
• Activation current with input voltage 9.6 V	20 mA
• Activation current with input voltage 28 V	8 mA
Environmental conditions	
• Environmental class	2
• Protection category	IP 30
• Operating temperature	-5 °C to +45 °C
• Storage temperature	-40 °C to +85 °C
Housing	
• Material	ABS
• Color	RAL 9002
Dimensions (H x W x D)	160 x 135 x 35 mm
Weight	0.25 kg

Ordering Information

SE 320 LSNi SmartKey Arming Device

IUI-SKCU3L-320

For arming/disarming an intrusion alarm system via a code keypad with integrated reader or just with a code keypad as a system solution

Detectors and Accessories

5

Motion PIR	136
Motion PIR/Microwave	164
Motion Outdoor	183
Motion Ceiling Mount	186
Motion Long Range	202
Request-to-Exit	211
Glass Break	216
Seismic	220
Photoelectric Beam	223
Holdup	230
Smoke	231
Magnetic Contacts Recessed Mount	240
Magnetic Contacts Surface Mount	266
Accessories	286

ISC-PPR1-W16 Professional Series PIR Detector



5

Features

- ▶ **16 m x 21 m (50 ft x 70 ft) coverage, selectable to 8 m x 10 m (25 ft x 33 ft)**
- ▶ **EN50131-2-2 Grade 2 and VdS G107504 Class B compliant**
- ▶ **Sensor data fusion technology**
- ▶ **Tri-focus optics technology**
- ▶ **Active white light suppression**
- ▶ **Dynamic temperature compensation**
- ▶ **Remote walk test**
- ▶ **Alarm memory**
- ▶ **Draft and insect immunity**
- ▶ **2 m to 3 m (7 ft to 10 ft) mounting height, no adjustments required**

The ISC-PPR1-W16 Professional Series PIR Detector is exceptionally suited for commercial indoor applications. Sensor data fusion technology ensures that the detector sends alarm conditions based on precise information. Tri-focus optics eliminate coverage gaps and respond efficiently to intruders. The powerful combination of unique features in the Professional Series delivers superior catch performance and virtually eliminates false alarms.

The self-locking two-piece enclosure, built-in bubble level, flexible mounting height, and three optional mounting brackets simplify installation and reduce service time.

Functions

Sensor Data Fusion Technology

Sensor data fusion technology is a unique feature that uses a sophisticated software algorithm to gather signals from multiple sensors: two pyroelectric sensors, a room temperature sensor, and a white light level sensor. The microcontroller analyzes and compares the sensor data to make the most intelligent alarm decisions in the security industry.

Tri-focus Optics Technology

Tri-focus optics technology uses optics with three specific focal lengths: long-range coverage, middle-range coverage, and short-range coverage. The detector applies the three focal lengths to 86 detection zones, which combine to make 11 solid curtains of detection. Tri-focus optics technology also includes two pyroelectric sensors, which deliver twice the standard optical gain. The sensors process multiple signals to deliver precise performance virtually free of false alarms.

Active White Light Suppression

An internal light sensor measures the level of light intensity directed at the face of the detector. Sensor data fusion technology uses this information to eliminate false alarms from bright light sources.

Field Selectable Coverage (16 m x 21 m or 8 m x 10 m)

Installers can use a DIP switch to select 16 m x 21 m or 8 m x 10 m (50 ft x 70 ft or 25 ft x 33 ft) coverage.

Dynamic Temperature Compensation

The detector automatically adjusts PIR sensitivity to identify human intruders at critical temperatures. Dynamic temperature compensation detects human body heat accurately, avoids false alarms, and delivers consistent catch performance at all operating temperatures.

Cover and Wall Tamper Switch

When an intruder removes the cover or attempts to separate the detector from the wall, a normally-closed contact opens to alert the control panel.

Self-adjusting LED

The LED brightness adjusts automatically to the surrounding light level. A blue light-emitting diode (LED) indicates an alarm condition and activates during a walk test.

Remote Walk Test LED

Users can enter a command through a keypad, a control center, or programming software to remotely enable or disable the walk test LED. Users can locally enable or disable the walk test LED through the DIP switch.

Alarm Memory

Alarm memory flashes the alarm LED to indicate stored alarms for use in multiple unit applications. A switched voltage from the control panel controls the alarm memory.

Solid State Relays

Solid state relays send silent alarm output signals to provide a higher level of security and reliability. An external magnet does not activate the relay. The solid state relay uses less current than a mechanical relay, providing longer standby capacity during a power loss.

Draft, Insect, and Small Animal Immunity

The sealed optic chamber provides immunity to drafts and insects, reducing false alarms. Small animal immunity reduces false alarms caused by animals less than 4.5 kg (10 lb), such as rodents.

Remote Self Test

A remote self test initiates when the walk test input switches to its true state. The alarm relay and alarm LED activate for four seconds following a successful test. The trouble relay activates, and the alarm LED flashes following a failed test.

Input Power Supervision

When the power is lower than 8 V, a low input power trouble condition activates the trouble relay and causes the LED to flash. The trouble condition clears automatically when power reaches or exceeds 8 V.

DIP Switch Programming

The following functions are all programmed using DIP switch settings:

- Remote Walk Test LED
- Long and Short Range Select

Trouble Memory

When the walk test input switches to its true state for less than two seconds, the LED flashes to indicate the most recent trouble condition. If there is no trouble in memory, the LED does not flash. After twelve hours, or after the detector receives a second walk test pulse for two seconds or less, the LED stops flashing and the trouble memory clears.

Certifications and Approvals

Region	Certification
Europe	CE 89/336/EEC, EN55022:1998+A2:2003 (CISPR 22:1997), EN50130-4:1995+A2:2003, EN61000-4-2:1995+A2:2001, EN61000-4-3:1996+A1:2002, EN61000-4-4:1995+A2:2001, EN61000-4-5:1995+A1:2001, EN61000-4-6:2003, EN61000-4-11:1994+A1:2001, EN60950-1:2001 1st edition EN50131 Tested to EN 50131-1 Grade 2, TS 50131-2-2 August 2004, EN 50130-4, EN 50130-5
Belgium	INCERT B-509-0051
Poland	TECHOM 128/06

Region	Certification
USA	UL ANSR: Intrusion Detection Units (UL639), ANSR7: Intrusion Detection Units Certified for Canada (cULus)
Italy	IMQ
France	AFNOR Type 2 (*), NF et A2P (NF 324 - H 58)
China	CCC 2007031901000293
Sweden	INTYG Nr07-168
the Netherlands	REQ 07223000/AA/00
The detector is also designed to comply with following standards and approvals.	
Australia	C-Tick
Germany	VdS Schadenverhütung GmbH G107504, Class B
Norway	FGL D-169/07, D-620/07

Installation/Configuration Notes

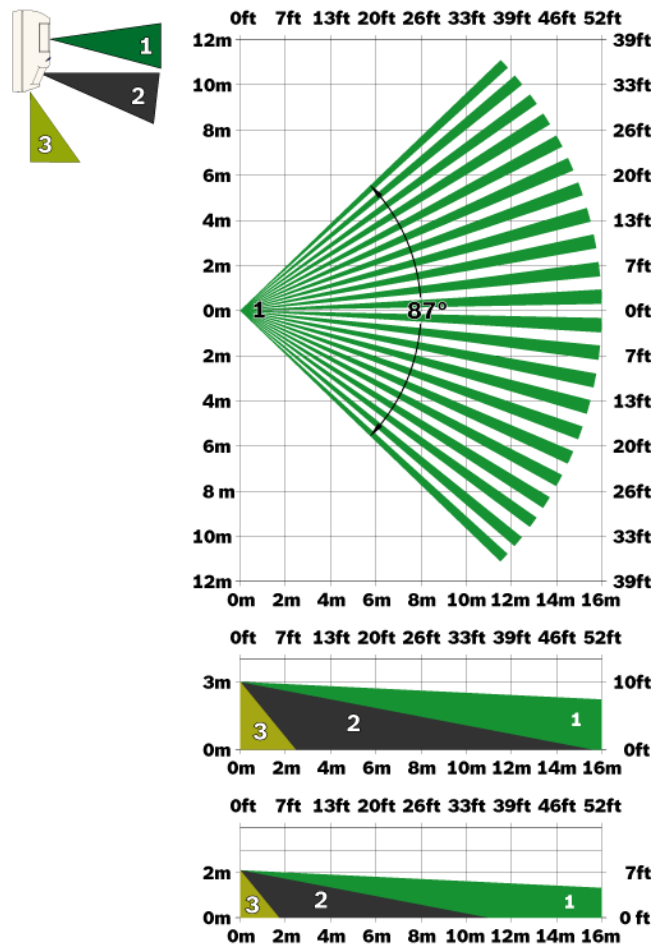

Long-range Coverage: 16 m x 21 m (50 ft x 70 ft)

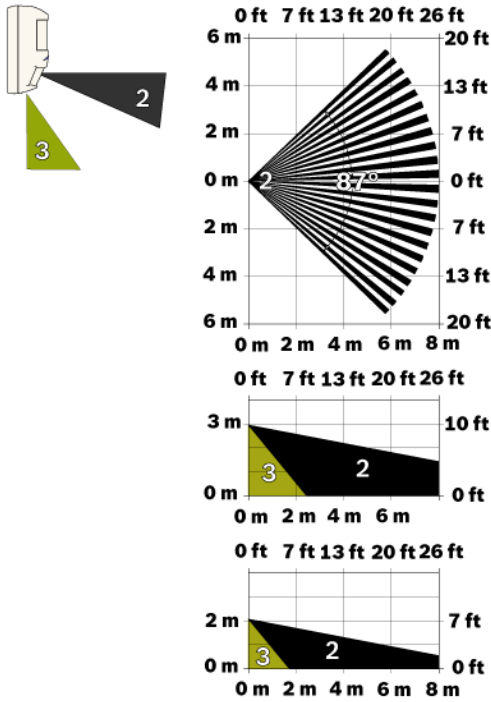

Selectable Short-range Coverage: 8 m x 10 m (25 ft x 33 ft)

Mounting Considerations

The recommended mounting height is 2 m to 3 m (7 ft to 10 ft).

Use an optional B328 Gimbal-mount Bracket or B335-3 Low-profile Swivel-mount Bracket to surface-mount the detector on a flat wall or a corner.

Use an optional B338 Universal Ceiling Bracket to mount the detector on the ceiling.

Wiring Considerations

Recommended wire size is 0.2 mm² to 1 mm² (26 AWG to 16 AWG).

Parts Included

Quantity	Component
1	Detector
2	Flat-head screws
2	Screw anchors
1	Nylon cable tie
1	Pattern Mask
1	Installation Guide

Technical Specifications

Electrical

Power Requirements

Voltage (Operating):	9 VDC to 15 VDC
Current (Maximum):	< 15 mA
Current (Standby):	< 10 mA at 12 VDC
Relay:	Solid state relay, normally-closed (NC) contacts, power supervised. 3 W, 125 mA, 25 VDC, resistance < 10 Ω
Tamper:	Normally-closed (NC) contacts (with cover on) rated at 25 VDC, 125 mA maximum. Connect tamper circuit to 24-hour protection circuit.

Mechanical

Enclosure Design

Color:	White
Dimensions:	127 mm x 69 mm x 58 mm (5 in. x 2.75 in. x 2.25 in.)
Material:	High-impact ABS plastic

Indicators

Alarm Indicator:	Blue alarm LED
------------------	----------------

Zones

Zones:	86
--------	----

Environmental

Relative Humidity:	0 to 95%, non-condensing
Temperature (Operating and Storage):	-29°C to +55°C (-20°F to +130°F) <i>For UL Certificated installations, 0°C to +49°C (+32°F to +120°F)</i>
Environmental Class II	EN 50130-5
Protection Rating:	IP41, IK04 (EN 60529, EN 50102)

Ordering Information

ISC-PPR1-W16 Professional Series PIR Detector **ISC-PPR1-W16**

ISC-PPR1-W16 Professional Series PIR Detector for commercial indoor applications

Accessories

B328 Gimbal-mount Bracket **B328**

Mounts on a single-gang box and allows rotation of a detector. Wires are hidden inside.

Swiveling B335-3 low-profile mount **B335-3**

Swiveling, low-profile, plastic mount for wall mounting. The vertical swivel range is +10° to -20°, while the horizontal swivel range is ±25°. Available in triple packs.

ISC-PPR1-WA16x Professional Series PIR Detectors with Anti-mask



Features

- ▶ **16 m x 21 m (50 ft x 70 ft) standard coverage; 8 m x 10 m (25 ft x 33 ft) selectable short range coverage**
- ▶ **EN50131-2-2 Grade 3 compliant**
- ▶ **Sensor data fusion technology**
- ▶ **Tri-focus optics technology**
- ▶ **MANTIS anti-mask**
- ▶ **Active white light suppression**
- ▶ **Dynamic temperature compensation**
- ▶ **Remote walk test**
- ▶ **Alarm memory**
- ▶ **Draft and insect immunity**

The ISC-PPR1-WA16x Professional Series PIR Detectors with Anti-mask are exceptionally suited for commercial indoor applications. MANTIS anti-mask technology makes obscuring the detector view nearly impossible for intruders. Sensor data fusion technology ensures that the detector sends alarm conditions based on precise information. Tri-focus optics eliminate coverage gaps and respond efficiently to intruders. The powerful combination of unique features in the Professional Series delivers superior catch performance and virtually eliminates false alarms.

The self-locking two-piece enclosure, built-in bubble level, flexible mounting height, and three optional mounting brackets simplify installation and reduce service time.

Functions

Sensor Data Fusion Technology

Sensor data fusion technology is a unique feature that uses a sophisticated software algorithm to gather signals from multiple sensors: two pyroelectric sensors, a microwave assist sensor, a room temperature sensor, and a white light level sensor. The microcontroller analyzes and compares the sensor data to make the most intelligent alarm decisions in the security industry.

Microwave Assist Technology

Microwave assist technology provides additional input into the sensor data fusion signal processing algorithm to improve alarm decisions when PIR signals are similar to false alarm sources.

Tri-focus Optics Technology

Tri-focus optics technology uses optics with three specific focal lengths: long-range coverage, middle-range coverage, and short-range coverage. The detector applies the three focal lengths to 86 detection zones, which combine to make 11 solid curtains of detection. Tri-focus optics technology also includes two pyroelectric sensors, which deliver twice the standard optical gain. The sensors process multiple signals to deliver precise performance virtually free of false alarms.

MANTIS Anti-mask Technology

MANTIS (**M**ulti-point **A**nti-mask with **I**ntegrated **S**pray detection) uses patented prism lenses and active infrared detection to provide industry-leading protection against all known forms of attack. MANTIS complies with the latest worldwide regulatory standards for detecting objects covering or placed in front of the detector. MANTIS is sensitive to materials regardless of texture or color, including fabric, paper, metal, plastic, tape, and spray. When MANTIS identifies a masking material, the detector sends a supervision anti-mask signal to the control panel.

Active White Light Suppression

An internal light sensor measures the level of light intensity directed at the face of the detector. Sensor data fusion technology uses this information to eliminate false alarms from bright light sources.

Available Coverage

The standard coverage is 16 m x 21 m (50 ft x 70 ft). Installers can set a DIP switch at the detector to select short range coverage of 8 m x 10 m (25 ft x 33 ft).

Dynamic Temperature Compensation

The detector automatically adjusts PIR sensitivity to identify human intruders at critical temperatures. Dynamic temperature compensation detects human body heat accurately, avoids false alarms, and delivers consistent catch performance at all operating temperatures.

Cover and Wall Tamper Switch

When an intruder removes the cover or attempts to separate the detector from the wall, a normally-closed contact opens to alert the control panel.

Self-adjusting LED

The LED brightness adjusts automatically to the surrounding light level. A blue light-emitting diode (LED) indicates an alarm condition and activates during a walk test.

Remote Walk Test LED

Users can enter a command through a keypad, a control center, or programming software to remotely enable or disable the walk test LED.

Alarm Memory

Alarm memory flashes the alarm LED to indicate stored alarms for use in multiple unit applications. A switched voltage from the control panel controls the alarm memory.

Solid State Relays

Solid state relays send silent alarm output signals to provide a higher level of security and reliability. An external magnet does not activate the relay. The solid state relay uses less current than a mechanical relay, providing longer standby capacity during a power loss.

Draft, Insect, and Small Animal Immunity

The sealed optic chamber provides immunity to drafts and insects, reducing false alarms. Small animal immunity reduces false alarms caused by animals less than 4.5 kg (10 lb), such as rodents.

Remote Self Test

A remote self test initiates when the walk test input switches to its true state. The alarm relay and alarm LED activate for four seconds following a successful test. The trouble relay activates, and the alarm LED flashes following a failed test.

Input Power Supervision

When the power is lower than 8 V, a low input power trouble condition activates the trouble relay and causes the LED to flash. The trouble condition clears automatically when power reaches or exceeds 8 V.

Trouble Memory

When the walk test input switches to its true state for less than two seconds, the LED flashes to indicate the most recent trouble condition. If there is no trouble in memory, the LED does not flash. After twelve hours, or after the detector receives a second walk test pulse for two seconds or less, the LED stops flashing and the trouble memory clears.

DIP Switch Programming

The following functions are all programmed using DIP switch settings:

- Local Walk Test LED
- Remote Walk Test Input Polarity
- Alarm Memory Polarity
- Long and Short Range Select
- MANTIS Anti-mask On and Off

Certifications and Approvals

Region	Certification	
Europe	CE	2004/108/EC EMC Directive; 1999/5/EC Radio Equipment and Telecommunications Terminal Equipment, Annex V, EN 55022: 1998, +A2: 2003, ClassB; EN 50130-4: 1995, +A1: 1998, +A2: 2003; IEC 60950-1: 2001, EN 60950-1: 2001; EN 300 440-2, V1.1.2 (2004-07)
	EN50131	EN 50131-1, TS 50131-2-2 August 2004, RT 50131-2-2 July 2007, EN 50130-4, EN 50130-5

Belgium	INCERT	B-509-0051/a
Sweden	INTYG	ISC-PPR1-WA16G only: Nr08-234

The detectors are also designed to comply with the following standards and approvals.

Europe	EN50131	EN50131-2-2 Grade 3
USA	UL	cULus -UL639, Intrusion Detection Units
	FCC	Complies with Part 15

Installation/Configuration Notes

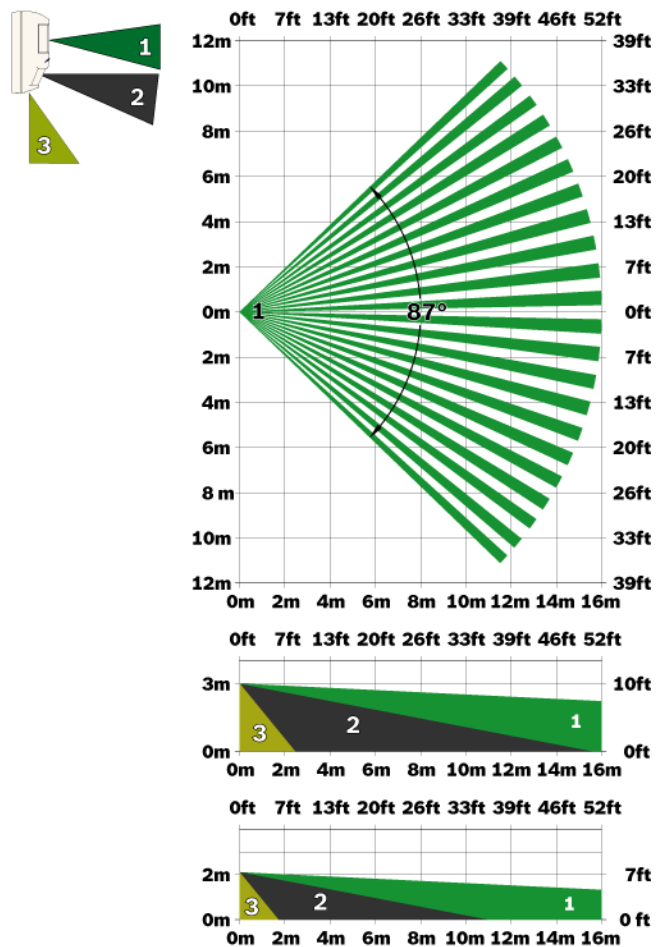

Long-range Coverage 16 m x 21 m (50 ft x 70 ft)

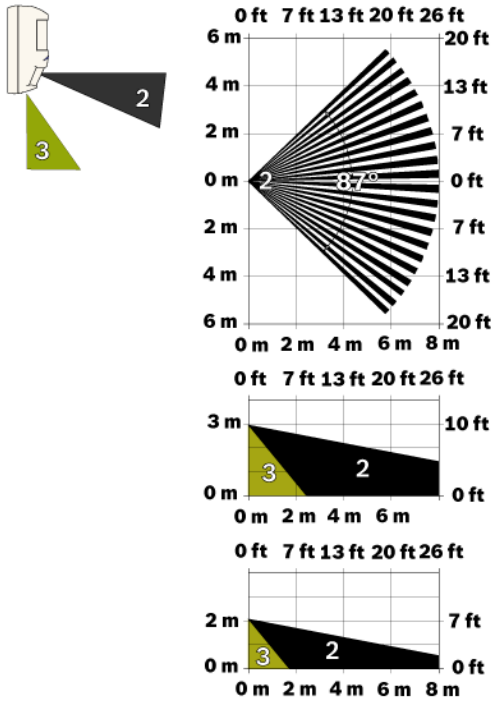

Selectable Short-range Coverage 8 m x 10 m (25 ft x 33 ft)

Mounting Considerations

The recommended mounting height is 2 m to 3 m (7 ft to 10 ft).

Use an optional B328 Gimbal-mount Bracket or B335-3 Low-profile Swivel-mount Bracket to surface-mount the detector on a flat wall or in a corner.

Use an optional B338 Universal Ceiling Bracket to mount the detector on the ceiling.

Wiring Considerations

Recommended wire size is 0.2 mm² to 1 mm² (26 AWG to 16 AWG).

Parts Included

Quantity	Component
1	Detector
2	Flat-head screws
2	Screw anchors
1	Nylon cable tie
1	Pattern Mask
1	Installation Guide

Technical Specifications

Electrical

Power Requirements

Voltage (Operating):	9 VDC to 15 VDC
Current (Maximum):	< 26 mA with alarm, trouble, and LEDs active.
Current (Standby):	18 mA at 12 VDC
Relay:	Solid state relay, normally-closed (NC) contacts, power supervised. 3 W, 125 mA, 25 VDC, resistance < 10 Ω.
Tamper:	Normally-closed (NC) contacts (with cover on) rated at 25 VDC, 125 mA maximum. Connect tamper circuit to 24-hour protection circuit.
Trouble:	Solid state relay normally-closed (NC) contacts.

Mechanical

Enclosure Design

Color:	White
Dimensions:	127 mm x 69 mm x 58 mm (5 in. x 2.75 in. x 2.25 in.)
Material:	High-impact ABS plastic

Indicators

Alarm Indicator:	Blue alarm LED
------------------	----------------

Zones

Zones:	86
--------	----

Environmental

Relative Humidity:	0 to 95%, non-condensing
Temperature (Operating and Storage):	-30°C to +55°C (-22°F to +130°F) For AFNOR certificated installations, -10°C to +55°C (+14°F to +130°F) For UL Certificated installations, 0°C to +49°C (+32°F to +120°F)
Environmental Class II	EN 50130-5
Protection Rating:	IP 41, IK04 (EN 60529, EN 50102)

Ordering Information

ISC-PPR1-WA16G PIR Detector with Anti-mask 10.525 GHz frequency.	ISC-PPR1-WA16G
ISC-PPR1-WA16H PIR Detector with Anti-mask 10.588 GHz frequency used in France and the United Kingdom.	ISC-PPR1-WA16H

Accessories

B328 Gimbal-mount Bracket Mounts on a single-gang box and allows rotation of a detector. Wires are hidden inside.	B328
Swiveling B335-3 low-profile mount Swiveling, low-profile, plastic mount for wall mounting. The vertical swivel range is +10° to -20°, while the horizontal swivel range is ±25°. Available in triple packs.	B335-3

ISM-BLP1 Blue Line PIR Detector



5

Features

- ▶ **11 m x 11 m (35 ft x 35 ft) broad coverage**
- ▶ **EN50131-2-2 Grade 2 compliant**
- ▶ **First Step Processing (FSP)**
- ▶ **Flexible mounting height from 2.3 m to 2.7 m (7.5 ft to 9 ft)**
- ▶ **No range or height adjustments required**
- ▶ **Installation-friendly two-piece design**
- ▶ **Easy wiring access with plug-in terminals**
- ▶ **Draft and insect immunity**
- ▶ **Eight detection layers including optional look-down zone**
- ▶ **Temperature compensation**

The ISM-BLP1 Detector uses a high-density (77 zone) Fresnel lens designed to produce sharply-focused images throughout the field of view providing superior response to intruders. Easy installation and flexible mounting options provide state-of-the-art detection.

Functions

Signal Processing

First Step Processing (FSP) almost instantly responds to human targets without producing false alarms from other sources. FSP adjusts the detector's sensitivity based on signal amplitude, polarity, slope, and timing. This eliminates the need for the installer to select the sensitivity level.

Test Features

The externally-visible alarm LED can be disabled after installation.

Draft and Insect Immunity

The sealed optical chamber prevents drafts and insects from affecting the detector.

Temperature Compensation

The detector adjusts its sensitivity so that it can identify human intruders at critical temperatures.

Certifications and Approvals

Region	Certification	
Europe	CE	89/336/EEC, EN55022: 1998 +A1: 2000 +A2: 2003 (ANSI C63.4: 2001), EN50130-4: 1996 +A1: 1998 +A2: 2003, EN61000-3-3: 1995 +A1: 2001, EN61000-4-2: 1995 +A1: 1998 +A2: 2001, EN61000-4-3: 2002 +A1: 2002, EN61000-4-4: 1995 +A1: 2000 +A2: 2001, EN61000-4-5: 1995 +A1: 2001, EN61000-4-6: 1996 +A1: 2001, EN61000-4-11: 1994 +A1: 2001, EN300440: 1996, TS 50131-2-2: 2004 (Version 1)
	EN50131	EN 50131-1, TS 50131-2-2 August 2004, EN 50130-4, EN 50130-5
Belgium	INCERT	B-509-0009/a
Poland	CNBOP	80/04
Russia	GOST	IEC 60839-1-3-2001, IEC 60839-2-2-2001, IEC 60839-2-6-2001, GOST 26342-84, GOST 27990-88
		GOST 12997-84, GOST R 50009-2000, GOST R 51317.3.2-99, GOST R 51317.3.3-99, GOST R MEK 60065-2002
USA	UL	ANSR: Intrusion Detection Units (UL639), ANSR7: Intrusion Detection Units Certified for Canada (cULus)
Italy	IMQ	
Czech Republic	NBU	T1207/2004
France	AFNOR	NF, A2P (262262-00)
Sweden	INTYG	05-132
		Nr05-132
Australia	C-tick	
Ukraine		IEC 60839-1-3-2001, IEC 60839-2-2-2001, IEC 60839-2-6-2001, GOST 26342-84, GOST 27990-88
Europe		Complies with EN50131-2-2 Grade 2

Installation/Configuration Notes

Coverage Patterns

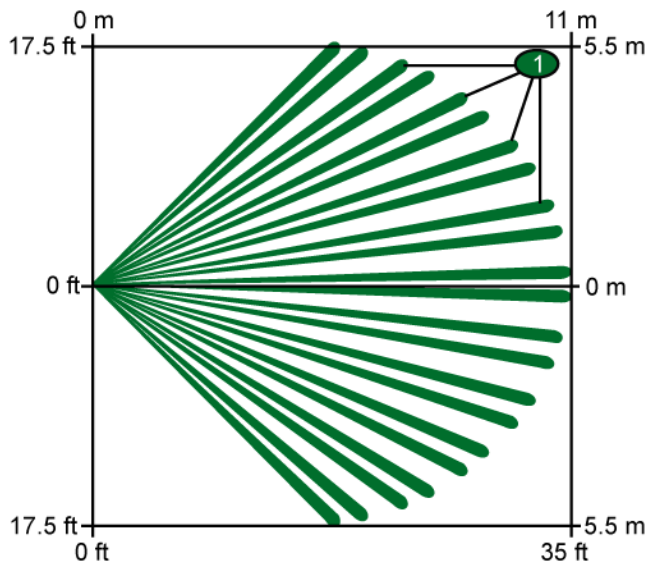

Top View Broad: 11 m x 11 m (35 ft x 35 ft)

1 PIR coverage pattern

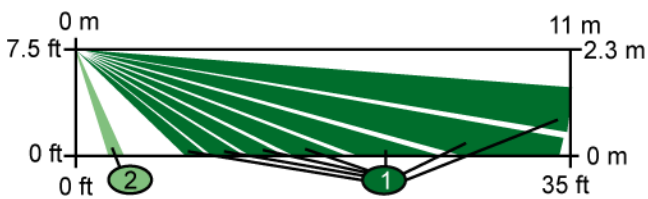

Side View Broad: 11 m x 11 m (35 ft x 35 ft)

1 PIR coverage pattern 2 Look-down zone

Mounting

The recommended mounting height is 2.3 m to 2.7 m (7.5 ft to 9 ft).

The detector can be mounted:

- On a flat wall (surface, semi-flush) with the optional B335 Swivel-mount Bracket, or with the optional B328 Gimbal-mount Bracket,
- In the junction of two perpendicular walls, or
- On the ceiling with the optional B338 Ceiling-mount Bracket.

Note The use of optional mounting brackets can reduce the detector's range and increase the dead zone areas.

Power Considerations

Power Limits

Input power must be provided by an Approved Limited Power Source. All outputs must be connected to SELV (safety extra-low voltage) circuits only.

Standby Power

This detector has no internal standby battery. *For UL Listed product installations, 4 hr (40 mAh) of standby power must be supplied by the control unit or by a UL Listed burglary power supply.*

Parts Included

Quant.	Component
1	Detector
1	Hardware pack
1	Literature pack

Technical Specifications

Environmental Considerations

Designed to comply with EN50131-2-2 Environmental Class II, Security Grade 2

Relative Humidity: 0 to 85%, non-condensing

Temperature (operating): -29°C to +49°C (-20°F to +120°F)
For UL Listed product installations, 0°C to +49°C (+32°F to +120°F)

Mechanical Properties

Color: White

Dimensions: 10.7 cm x 6.1 cm x 4.8 cm (4.2 in. x 2.4 in. x 1.9 in.)

Material: High-impact ABS plastic

Radio Frequency Interference (RFI) Immunity: No alarm or setup on critical frequencies in the range from 26 MHz to 950 MHz at field strengths less than 50 V/m.

Outputs

Digital Alarm: 5 V normally, grounded for 4 sec during alarm.

Relay: Solid state, supervised, Form A normally-closed (NC) contacts rated for 125 mA, 28 VDC, 3 W.

Tamper: Normally-closed (NC) contacts (with cover on) rated at 28 VDC, 125 mA maximum. Connect tamper circuit to 24-hour protection circuit.

Power Requirements

Current (Alarm): 18 mA

Current (Standby): 10 mA maximum at 12 VDC

Voltage (Operating): 10 VDC to 14 VDC

Ordering Information

ISM-BLP1 Blue Line PIR Detector	ISM-BLP1
Produces sharply-focused images throughout the field of view providing superior response to intruders	

Accessories

ISM-BLA1-CC Blue Line Color Camera Module (NTSC format) NTSC format	ISM-BLA1-CC-N
ISM-BLA1-CC Blue Line Color Camera Module (PAL format) PAL format	ISM-BLA1-CC-P
ISM-BLA1-LM Blue Line Nightlight Module Fits all Blue Line detectors	ISM-BLA1-LM
ISM-BLA1-SM Blue Line Sounder Module Fits all Blue Line detectors	ISM-BLA1-SM

Ordering Information

B328 Gimbal-mount Bracket**B328**

Mounts on a single-gang box and allows rotation of a detector. Wires are hidden inside.

Swiveling B335-3 low-profile mount**B335-3**

Swiveling, low-profile, plastic mount for wall mounting. The vertical swivel range is +10° to -20°, while the horizontal swivel range is ±25°. Available in triple packs.

ISM-BLP1-P Blue Line Pet-Friendly PIR Detector



Features

- ▶ **11 m x 11 m (35 ft x 35 ft) broad coverage**
- ▶ **EN50131-2-2 Grade 2 compliant**
- ▶ **Pet Friendly®**
- ▶ **First Step Processing (FSP)**
- ▶ **Flexible mounting height from 2.3 m to 2.7 m (7.5 ft to 9 ft)**
- ▶ **No range or height adjustments required**
- ▶ **Installation-friendly two-piece design**
- ▶ **Easy wiring access with plug-in terminals**
- ▶ **Eight detection layers including optional look-down zone**
- ▶ **Draft and insect immunity**

The ISM-BLP1-P Pet Friendly® Detector can distinguish between signals caused by humans and signals caused by one or two animals with a combined total weight of 13.6 kg (30 lb).

Functions

Signal Processing

First Step Processing (FSP) almost instantly responds to human targets without producing false alarms from other sources. FSP adjusts the detector's sensitivity based on signal amplitude, polarity, slope, and timing. This eliminates the need for the installer to select the sensitivity level.

Test Features

The externally-visible alarm LED can be disabled after installation.

Draft and Insect Immunity

The sealed optical chamber prevents drafts and insects from affecting the detector.

Temperature Compensation

The detector adjusts its sensitivity to maintain its ability to identify human intruders at critical temperatures.

Certifications and Approvals

Region	Certification	
Europe	CE	89/336/EEC, EN55022:1998 +A1:2000 +A2:2003 (ANSI C63.4:2001), EN50130-4:1996 +A1:1998 +A2:2003, EN61000-3-3:1995 +A1:2001, EN61000-4-2:1995 +A1:1998 +A2:2001, EN61000-4-3:2002 +A1:2002, EN61000-4-4:1995 +A1:2000 +A2:2001, EN61000-4-5:1995 +A1:2001, EN61000-4-6:1996 +A1:2001, EN61000-4-11:1994 +A1:2001, EN300440:1996, TS 50131-2-2:2004 (Version 1)
	EN50131	EN 50131-1, TS 50131-2-2 August 2004, EN 50130-4, EN 50130-5
Belgium	INCERT	B-509-0009/a
Poland	CNBOP	83/04
Russia	GOST	IEC 60839-1-3-2001, IEC 60839-2-2-2001, IEC 60839-2-6-2001, GOST 26342-84, GOST 27990-88
		GOST 12997-84, GOST R 50009-2000, GOST R 51317.3.2-99, GOST R 51317.3.3-99, GOST R MEK 60065-2002
USA	UL	ANSR: Intrusion Detection Units (UL639), ANSR7: Intrusion Detection Units Certified for Canada (cULus)
Italy	IMQ	
Czech Republic	NBU	T1207/2004
France	AFNOR	NF, A2P (262263-00)
Sweden	INTYG	Nr05-134
Ukraine		IEC 60839-1-3-2001, IEC 60839-2-2-2001, IEC 60839-2-6-2001, GOST 26342-84, GOST 7990-88
Europe		Complies with EN50131-2-2 Grade 2

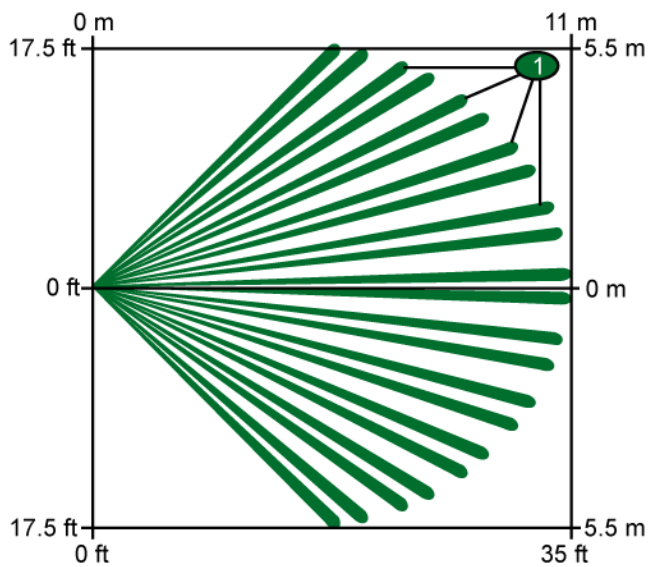
Installation/Configuration Notes**Coverage Patterns**

Top View Broad: 11 m x 11 m (35 ft x 35 ft)

1 PIR coverage pattern

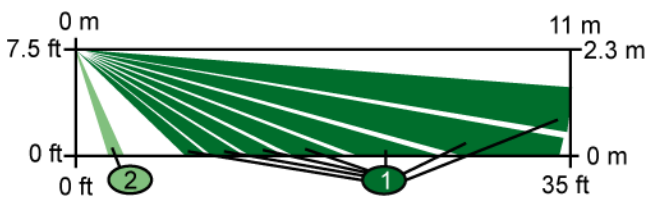

Side View Broad: 11 m x 11 m (35 ft x 35 ft)

1 PIR coverage pattern 2 Look-down zone

Mounting

The recommended mounting height is 2.3 m to 2.7 m (7.5 ft to 9 ft).

The detector can be mounted:

- On a flat wall (surface, semi-flush) with the optional B335 Swivel-mount Bracket, or with the optional B328 Gimbal-mount Bracket,
- In the junction of two perpendicular walls, or
- On the ceiling with the optional B338 Ceiling-mount Bracket.

Note The use of optional mounting brackets can reduce the detector's range and increase the dead zone areas.

Power Considerations**Power Limits**

Input power must be provided by an approved limited power source. All outputs must be connected to SELV (safety extra-low voltage) circuits only.

Standby Power

This detector has no internal standby battery. *For UL Listed product installations, 4 hr (40 mAh) of standby power must be supplied by the control unit or by a UL Listed burglary power supply.*

Parts Included

Quant.	Component
1	Detector
1	Hardware pack
1	Literature pack

Technical Specifications**Environmental Considerations**

Complies with EN50131-2-2 Environmental Class II, Security Grade 2

Relative Humidity: 0 to 85%, non-condensing

Temperature (operating): -29°C to +49°C (-20°F to +120°F)
For UL Listed product installations,
 0°C to +49°C (+32°F to +120°F)

Mechanical Properties

Color: White

Dimensions: 10.7 cm x 6.1 cm x 4.8 cm (4.2 in. x 2.4 in. x 1.9 in.)

Material: High-impact ABS plastic

Radio Frequency Interference (RFI) Immunity: No alarm or setup on critical frequencies in the range from 26 MHz to 950 MHz at field strengths less than 50 V/m.

Outputs

Digital Alarm: 5 V normally, grounded for 4 sec during alarm.

Relay: Solid state, supervised, Form A normally-closed (NC) contacts rated for 125 mA, 28 VDC, 3 W.

Tamper: Normally-closed (NC) contacts (with cover on) rated at 28 VDC, 125 mA maximum.
 Connect tamper circuit to 24-hour protection circuit.

Power Requirements

Current (Alarm): 18 mA

Current (Standby): 10 mA maximum at 12 VDC

Voltage (Operating): 10 VDC to 14 VDC

Trademarks

Pet Friendly® is a registered trademark of Bosch Security Systems in the United States.

Ordering Information

ISM-BLP1-P Blue Line Pet-Friendly PIR Detector **ISM-BLP1-P**

Distinguish between signals caused by humans and signals caused by small animals

Accessories

ISM-BLA1-CC Blue Line Color Camera Module (NTSC format) **ISM-BLA1-CC-N**
 NTSC format

ISM-BLA1-CC Blue Line Color Camera Module (PAL format) **ISM-BLA1-CC-P**
 PAL format

ISM-BLA1-LM Blue Line Nightlight Module **ISM-BLA1-LM**
 Fits all Blue Line detectors

Ordering Information

ISM-BLA1-SM Blue Line Sounder Module Fits all Blue Line detectors	ISM-BLA1-SM
-----------------------------------------------------------------------------	--------------------

B328 Gimbal-mount Bracket Mounts on a single-gang box and allows rotation of a detector. Wires are hidden inside.	B328
-----------------------------------------------------------------------------------------------------------------------------	-------------

Swiveling B335-3 low-profile mount Swiveling, low-profile, plastic mount for wall mounting. The vertical swivel range is +10° to -20°, while the horizontal swivel range is ±25°. Available in triple packs.	B335-3
------------------------------------------------------------------------------------------------------------------------------------------------------------------------------------------------------------------------	---------------

ISM-BLQ1 Blue Line Quad PIR Detector



5

Features

- ▶ **11 m x 11 m (35 ft x 35 ft) broad coverage**
- ▶ **EN50131-2-2 Grade 2 compliant**
- ▶ **Dual sensor, quad element design (two separate pyroelectric elements)**
- ▶ **Flexible mounting height from 2.3 m to 2.7 m (7.5 ft to 9 ft)**
- ▶ **No range or height adjustments required**
- ▶ **Installation-friendly two-piece design**
- ▶ **Easy wiring access with plug-in terminals**
- ▶ **Eight detection layers including optional look-down zone**
- ▶ **Draft and insect immunity**
- ▶ **Cover tamper**

The ISM-BLQ1 Quad PIR Detector uses two individual sensors that operate like two PIRs in one. Each sensor processes signals separately. Both must activate to cause an alarm. This increases reliability, because false alarm sources such as noise spikes and small animals are ignored. Quad detectors combine an unsurpassed level of catch performance with the highest level of false alarm immunity. Therefore, they are particularly well suited for challenging installation situations; for example, cases where cross catch of intruders cannot be guaranteed or where intruders are able to cross the detection pattern very quickly.

Functions

First Step Processing (FSP)

First Step Processing (FSP) almost instantly responds to human targets without producing false alarms from other sources. FSP adjusts the detector's sensitivity based on signal amplitude, polarity, slope, and timing. This eliminates the need for the installer to select the sensitivity level. Each of the two PIR sensors processes signals individually, and both sensors must agree there is an alarm before the alarm relay activates.

Test Features

Externally visible alarm LED can be disabled after installation.

Tamper

The switch opens when the cover is removed.

Draft and Insect Immunity

The sealed optical chamber prevents drafts and insects from affecting the detector.

Certifications and Approvals

Region	Certification	
Europe	CE	89/336/EEC, EN55022:1998+A1:2000+A2:2003 (ANSI C63.4:2001), EN50130-4:1996+A1:1998+A2:2003, EN61000-3-3:1995+A1:2001, EN61000-4-2:1995+A1:1998+A2:2001, EN61000-4-3:2002+A1:2002, EN61000-4-4:1995+A1:2000+A2:2001, EN61000-4-5:1995+A1:2001, EN61000-4-6:1996+A1:2001, EN61000-4-11:1994+A1:2001, EN300440:1996, TS 50131-2-2:2004 (Version 1)
	EN50131	EN50131-1, TS 50131-2-2 August 2004, EN 50130-4, EN 50130-5
Belgium	INCERT	B-509-0009/a
Poland	CNBOP	81/04
Russia	GOST	IEC 60839-1-3-2001, IEC 60839-2-2-2001, IEC 60839-2-6-2001, GOST 26342-84, GOST 27990-88
		GOST 12997-84, GOST R 50009-2000, GOST R 51317.3.2-99, GOST R 51317.3.3-99, GOST R MEK 60065-2002
USA	UL	ANSR: Intrusion Detection Units (UL639), ANSR7: Intrusion Detection Units Certified for Canada (cULus)
Italy	IMQ	
Czech Republic	NBU	T1207/2004
France	AFNOR	NF, A2P (262264-00)
Sweden	INTYG	Nr05-133

Australia	C-tick	
Ukraine		IEC 60839-1-3-2001, IEC 60839-2-2-2001, IEC 60839-2-6-2001, GOST 26342-84, GOST 27990-88
Europe	Complies with EN50131-2-2 Grade 2	

Input power must be provided by an approved limited power source. All outputs must be connected to SELV (safety extra-low voltage) circuits only.

Standby Power

This detector has no internal standby battery. *For UL Listed product installations, 4 hr (40 mAh) of standby power must be supplied by the control unit or by a UL Listed burglary power supply.*

Installation/Configuration Notes

Coverage Patterns

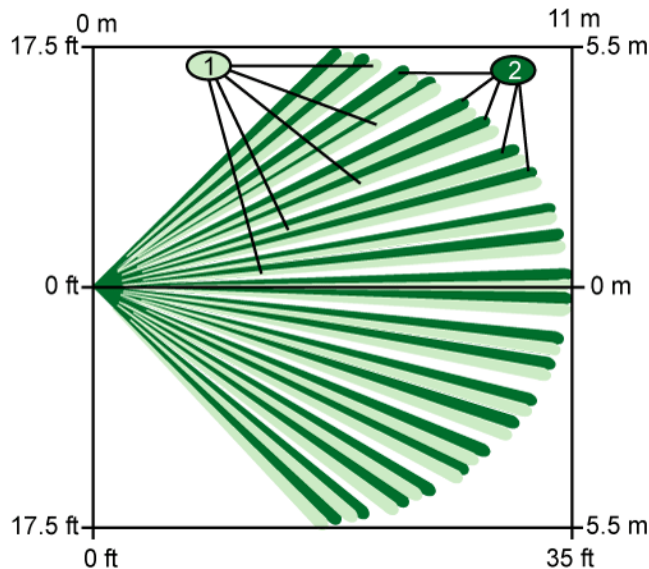

Top View Broad: 11 m x 11 m (35 ft x 35 ft)

1 PIR pattern 1 2 PIR pattern 2

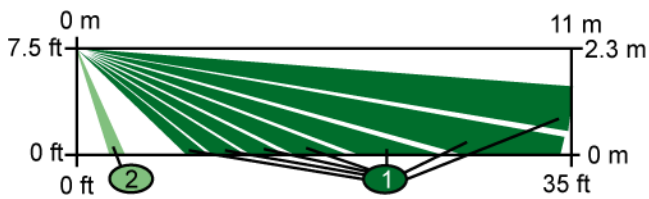

Side View Broad: 11 m x 11 m (35 ft x 35 ft)

1 PIR coverage patterns (1 and 2) 2 Look-down zone

Mounting

The recommended mounting height is 2.3 m to 2.7 m (7.5 ft to 9 ft).

The detector can be mounted:

- On a flat wall (surface, semi-flush), with the optional B335 Swivel-mount Bracket, or with the optional B328 Gimbal-mount Bracket.
- In a corner (the junction of two perpendicular walls).
- On the ceiling with the optional B338 Ceiling-mount Bracket.

Note The use of optional mounting brackets can reduce the detector's range and increase the dead zone areas.

Power Considerations

Power Limits

Parts Included

Quant.	Component
1	Detector
1	Hardware pack
1	Literature pack

Technical Specifications

Environmental Considerations

Complies with EN50131-2-2 Environmental Class II, Security Grade 2

Relative Humidity: 0 to 85%, non-condensing

Temperature (operating): -29°C to +49°C (-20°F to +120°F)
For UL Listed product installations, 0°C to +49°C (+32°F to +120°F)

Mechanical Properties

Color: white

Dimensions: 13.2 cm x 6.1 cm x 4.8 cm (5.2 in. x 2.4 in. x 1.9 in.)

Material: High-impact ABS plastic

Radio Frequency Interference (RFI) Immunity: No alarm or setup on critical frequencies in the range from 26 MHz to 2 GHz at field strengths less than 30 V/m.

Outputs

Digital Alarm: 5 V normally, grounded for 4 sec during alarm.

Relay: Solid state, supervised, Form A normally-closed (NC) contacts rated for 125 mA, 28 VDC, 3 W.

Tamper: Normally-closed (NC) contacts (with cover on) rated at 28 VDC, 125 mA maximum. Connect tamper circuit to 24-hour protection circuit.

Power Requirements

Current (alarm): 18 mA

Current (standby): 10 mA maximum at 12 VDC

Voltage (operating): 10 VDC to 14 VDC

Ordering Information**ISM-BLQ1 Blue Line Quad PIR Detector** **ISM-BLQ1**

Uses two individual sensors that operate like two PIRs in one

Accessories**ISM-BLA1-CC Blue Line Color Camera Module (NTSC format)** **ISM-BLA1-CC-N**

NTSC format

ISM-BLA1-CC Blue Line Color Camera Module (PAL format) **ISM-BLA1-CC-P**

PAL format

ISM-BLA1-LM Blue Line Nightlight Module **ISM-BLA1-LM**

Fits all Blue Line detectors

ISM-BLA1-SM Blue Line Sounder Module **ISM-BLA1-SM**

Fits all Blue Line detectors

B328 Gimbal-mount Bracket **B328**

Mounts on a single-gang box and allows rotation of a detector. Wires are hidden inside.

Swiveling B335-3 low-profile mount **B335-3**

Swiveling, low-profile, plastic mount for wall mounting. The vertical swivel range is +10° to -20°, while the horizontal swivel range is ±25°. Available in triple packs.

DS306E PIR Detector

France AFNOR NF, A2P



Features

- ▶ Motion Analyzer II processing
- ▶ Field replaceable pointable mirrors
- ▶ Three coverage patterns
- ▶ Four mounting options

The wall mount DS306E PIR Detector has field replaceable pointable mirrors and uses Motion Analyzer II signal processing to reduce false alarms. The detector's optics, coverage patterns, and mounting options provide installation flexibility.

Functions

Signal Processing

Motion Analyzer II uses multiple thresholds and timing windows to analyze timing, amplitude, duration, and signal polarity to make an alarm decision.

Certifications and Approvals

Region	Certification	
Europe	CE	89/336/EEC, EN55022: 1998 +A1: 2000 +A2: 2003, EN50130-4: 1996 +A1: 1998 +A2: 2003, EN61000-4-2: 1995 +A1: 1998 +A2: 2001, EN61000-4-3: 2002 +A1: 2003, EN61000-4-4: 1995 +A1: 2000 +A2: 2001, EN61000-4-5: 1995 +A1: 2001, EN61000-4-6: 1996 +A1: 2001 +A2: 2001, EN61000-4-11: 1994 +A1: 2001, EN60950-1: 2001
USA	UL	DS306E only:
Sweden	INTYG	DS306E only: Nr04-753

Installation/Configuration Notes

Mounting Considerations

The DS306E PIR Detector tolerates temperature changes resulting from heaters, air conditioners, and drafts. It also tolerates light fluctuations resulting from sunlight, lightning, and moving headlights.

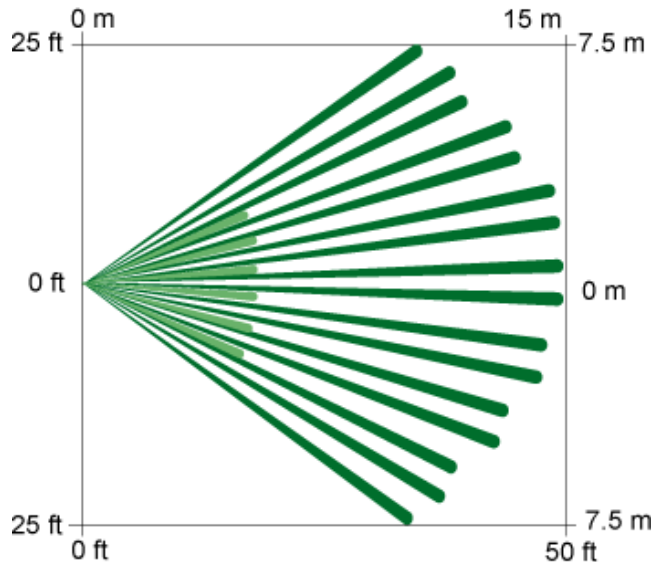

Top View
Standard Broad Coverage 15 m x 15 m (50 ft x 50 ft)



Side View
Standard Broad Coverage 15 m x 15 m (50 ft x 50 ft)

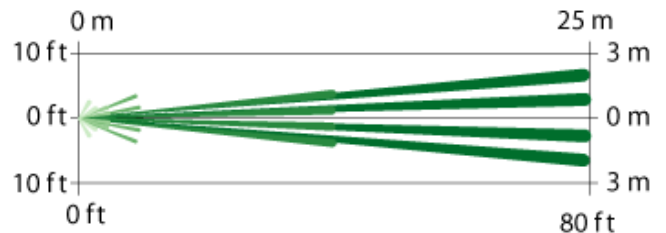

Top View
Optional Barrier Coverage: (OMB77) 25 m x 5 m (80 ft x 16 ft)

**Side View**

Optional Barrier Coverage: (OMB77) 25 m x 5 m (80 ft x 16 ft)

**Top View**

Optional Long Range Coverage: (OMLR77) 40 m x 3 m (120 ft x 10 ft)

**Side View**

Optional Long Range Coverage: (OMLR77) 40 m x 3 m (120 ft x 10 ft)

Technical Specifications

Enclosure Design

Material: High impact ABS plastic enclosure

Dimensions: 14.6 cm x 9.5 cm x 6.4 cm
(5.75 in. x 3.75 in. x 2.5 in.)

Environmental Considerations

Operating Temperature: -40°C to +49°C (-40°F to +120°F)
For UL Listed applications, +0°C to +49°C (+32°F to 120°F).

Radio Frequency Interference (RFI) Immunity: No alarm or setup on critical frequencies in the range from 26 MHz to 950 MHz at 50 V/m.

Mounting

Height Range: 2 m to 2.6 m (6.5 ft to 8.5 ft) recommended

Location: Surface or corner mount

Pattern Pointability: Coverage is adjustable $\pm 10^\circ$ horizontally, $+1^\circ$ to -17° vertically.

Outputs

Alarm: Form A contacts rated at 3.0W, 125 mA at 28VDC for resistive loads.

Tamper: Normally-closed. Contacts rated at 28 VDC, 125 mA maximum.

Power Requirements

Current Draw: 15 mA at 12 VDC

Voltage: 6 VDC to 15 VDC

Ordering Information

DS306E Wall Mount PIR Detector DS306E
DS306E Wall Mount PIR Detector

DS306E Wall Mount PIR Detector for France DS306E-FRA
DS306E Wall Mount PIR Detector; for use in France

Accessories

B328 Gimbal-mount Bracket B328
Mounts on a single-gang box and allows rotation of a detector. Wires are hidden inside.

Swiveling B335-3 low-profile mount B335-3
Swiveling, low-profile, plastic mount for wall mounting. The vertical swivel range is $+10^\circ$ to -20° , while the horizontal swivel range is $\pm 25^\circ$. Available in triple packs.

OMB77-3 Barrier Mirror OMB77-3
Provides barrier coverage with a 25 m x 5 m (80 ft x 16 ft) pattern. Shipped in packages of three.

OMLR77-3 Long-range Mirror OMLR77-3
Provides long-range coverage with a 40 m x 3 m (120 ft x 10 ft) pattern. Shipped in packages of three.

DS308EA Quad PIR Detector with Anti-mask



Features

- ▶ Anti-mask with spray detect
- ▶ Quad element design
- ▶ Microprocessor controlled self-test supervision systems
- ▶ Q-map signal processing
- ▶ Field replaceable pointable mirrored optics
- ▶ Temperature compensation
- ▶ Motion Monitor

The wall mount DS308EA Quad PIR Detector uses Q-map signal processing and a four-element (Quad), dual opposed sensor design to provide excellent catch performance with freedom from false alarms. The Anti-masking feature can detect a cover-up or an intentional or accidental blocking by sending a trouble signal to the panel. Test features, including Motion Monitor, provide coverage integrity.

Functions

Anti-mask with Spray Detect

PIR Anti-mask feature detects objects placed over the cover of the detector or sprayed on the lens area. Anti-mask sensitivity is selectable, and anti-mask activation can be delayed to reduce false alarms.

Q-map Signal Processing

Analyzes the signals from each channel to eliminate false alarms. The horizontally opposed signals must match with specific timing, amplitude, and signatures to cause an alarm. Q-map adjusts for small targets that cause signals in one channel but not the adjacent, opposing channel. This reduces false alarms from small targets such as rodents, while maintaining catch performance of human-sized targets.

Test Features

- LED flashes to indicate a trouble condition. Dual channel internal noise voltage test pins use standard analog meter to provide precise pattern location and background disturbance evaluation.
- Remote Walk Test Control: The walk test LED can be activated remotely through a control panel command.

Temperature Compensation

Automatically monitors the ambient temperature and adjusts the Signal processing to maintain proper catch performance at critical temperature ranges.

Alarm Memory

Provides indication of stored alarms. Controlled by a switched voltage from the control panel.

Certifications and Approvals

Region	Certification	
Europe	CE	89/336/EEC, EN55022: 1998, EN50130-4: 1995 +A1: 1998 +A2: 2003, EN61000-4-2: 1995 +A1: 1998 +A2: 2001, EN61000-4-3: 2002 +A1: 2002, EN61000-4-4: 1995 +A1: 2000 +A2: 2001, EN61000-4-5: 1995 +A1: 2001, EN61000-4-6: 1996 +A1: 2001
Poland	CNBOP	DS308EA only: 92/03
USA	UL	DS308EA only: ANSR: Intrusion detection Units (UL639)
Italy	IMQ	DS308EA-ITA: U0616
China	CCC	DS308EA-CHI: 2004031901000034
Sweden	INTYG	DS308EA only: Nr04-754
France	AFNOR	NF, A2P
Europe		DS308EA complies with EN50131-1 grade 3

Installation/Configuration Notes

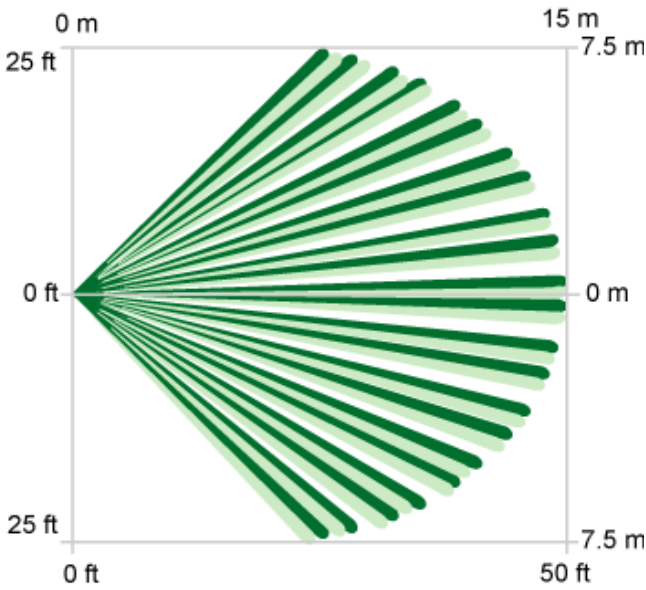

Top View
Standard Broad Coverage 15 m x 15 m (50 ft x 50 ft)



Side View
Standard Broad Coverage 15 m x 15 m (50 ft x 50 ft)

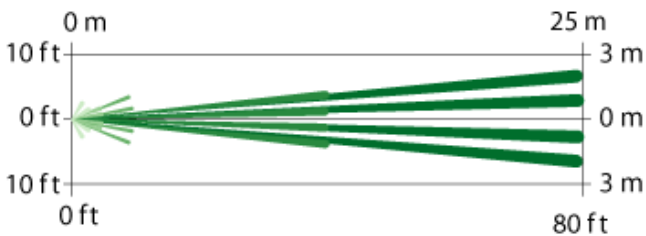

Top View
Optional Barrier Coverage: (OMB77) 25 m x 5 m (80 ft x 16 ft)



Side View
Optional Barrier Coverage: (OMB77) 25 m x 5 m (80 ft x 16 ft)



Top View
Optional Long Range Coverage: (OMLR77) 40 m x 3 m (120 ft x 10 ft)



Side View
Optional Long Range Coverage: (OMLR77) 40 m x 3 m (120 ft x 10 ft)

Technical Specifications

Enclosure Design

Dimensions: 14.6 cm x 9.5 cm x 6.35 cm (5.75 in. X 3.75 in. X 2.5 in)

Material: High impact ABS plastic enclosure

Environmental Considerations

Operating Temperature: -29°C to +49°C (-20°F to +120°F)
 For UL Listed Applications, 0°C to +49°C (+32°F to +120°F)

Radio Frequency Interference: No alarm or setup on critical frequencies in the range from 26 MHz to 950 MHz at 50 V/m.
 (RFI) Immunity:

DS308EA: Complies with Environmental Class II (EN50130-5)

Mounting

Height Range: 2.3 m (7.5 ft) recommended

Location: Surface or corner

Internal Pointability: Coverage is adjustable to ±10° horizontally, +2° to -18° vertically.

Outputs

Alarm: Form C contacts rated at 3.0 W, 125 mA at 28 VDC for resistive loads.

Tamper: Normally-closed (with cover in place). Contacts rated at 28 VDC, 125 mA maximum.

Trouble: Normally-closed dry contacts rated at 28 VDC, 125 mA maximum. Open during trouble.

Power Requirements

Current Draw: 25 mA at 12 VDC

Voltage: 6 VDC to 15 VDC

Ordering Information
DS308EA Quad PIR Intrusion Detector **DS308EA**

Provides 15 m x 15 m (50 ft x 50 ft) coverage, anti-masking with spray detect, quad element design, microprocessor controlled self-test supervision systems and Q-map signal processing.

DS308EA-FRA Quad PIR Intrusion Detector **DS308EA-FRA**

For use in France. Provides 15 m x 15 m (50 ft x 50 ft) coverage, anti-masking with spray detect, quad element design, microprocessor controlled self-test supervision systems and Q-map signal processing.

DS308EA-ITA Quad PIR Intrusion Detector **DS308EA-ITA**

For use in Italy. Provides 15 m x 15 m (50 ft x 50 ft) coverage, anti-masking with spray detect, quad element design, microprocessor controlled self-test supervision systems and Q-map signal processing.

Accessories
B328 Gimbal-mount Bracket **B328**

Mounts on a single-gang box and allows rotation of a detector. Wires are hidden inside.

Swiveling B335-3 low-profile mount **B335-3**

Swiveling, low-profile, plastic mount for wall mounting. The vertical swivel range is +10° to -20°, while the horizontal swivel range is ±25°. Available in triple packs.

OMB77-3 Barrier Mirror **OMB77-3**

Provides barrier coverage with a 25 m x 5 m (80 ft x 16 ft) pattern. Shipped in packages of three.

OMLR77-3 Long-range Mirror **OMLR77-3**

Provides long-range coverage with a 40 m x 3 m (120 ft x 10 ft) pattern. Shipped in packages of three.

MX775i Multiplex PIR Intrusion Detector



5

Features

- ▶ **Interchangeable, pointable mirrors**
- ▶ **Selectable sensitivity**
- ▶ **Built-in tamper switch**

The MX775i is a PIR intrusion detector that provides a variety of coverage patterns through the use of interchangeable mirrors and the choice of mirror angle settings. It is designed to be surface or corner mounted, but can be mounted with any of three optional brackets. This provides further flexibility in aiming the detector. It is designed to connect to the Multiplex Bus of a control panel and optionally to an auxiliary 12 VDC power source. It is compatible with the DS7400Xi Series Control Panels with a DS7430 or DS7436 Multiplex Expansion Module or with GV2 and G Series Control Panels with a D8125MUX Module installed.

Note The DS7400 and DS7400Xi require ROM version 1.07 or greater.

Functions

Interchangeable, Pointable Mirrors

The detector comes with a standard broad pattern mirror and two optional mirrors are available: a long-range pattern mirror and a barrier pattern mirror. To change the mirror, pull it out from its resting grooves. To adjust the mirror vertically (from +1° to -18°) slide the mirror forward or back. To adjust the mirror horizontally (±10°) rock the mirror from side to side.

Three Sensitivity Settings

Selectable for Standard, Intermediate or High:

- **Standard:** Recommended setting for maximum false alarm immunity. Tolerates environment extremes on this setting. Not recommended for Long Range or Barrier type patterns. The detector is shipped in Standard Sensitivity mode.
- **Intermediate:** Recommended setting for any location where an intruder is expected to cover only a small portion of the protected area. Tolerates normal environments on this setting. This setting will improve your intruder catch performance.
- **High:** Fast response to intruder signals. For use in quiet environments where thermal and illumination transients are not anticipated.

Internal Tamper Switch

The internal tamper switch sends a signal to the control panel's Multiplex Bus for display at the keypads when the detector's cover is removed.

Certifications and Approvals

Region	Certification	
Europe	CE	89/336/EEC, EN55022: 1998, EN50130-4: 1995, EN60950: 2000, EN61000-3-2, EN61000-3-3, EN61000-4-2, EN61000-4-3, EN61000-4-4, EN61000-4-5, EN61000-4-6, EN61000-4-11
USA	UL	ANSR: Intrusion Detection Units (UL639)

Installation/Configuration Notes

Wiring

Do not use shielded cable. Use wire that is no smaller than 0.8 mm (22 AWG) to connect the detector to the control panel.

Coverage

The recommended mounting height range is 2 m to 2.6 m (6.5 ft to 8.5 ft). Misalignment of the detector when using an optional mounting bracket may reduce range.

Height and Range listed in feet (meters)

Mounting Height	Broad		Barrier		Long-Range	
	30 (9)	50 (15)	50 (15)	80 (25)	80 (25)	120 (36)
6.5 (2.0)	-6°	-5°	-3°	-2°	-2°	-1°
7.5 (2.3)	-8°	-6°	-5°	-3°	-3°	-2°
8.5 (2.6)	-9°	-7°	-6°	-4°	-4°	-2°

The range is variable depending on the vertical angle setting of the mirror. The chart indicates vertical angle settings for the desired mounting height, mirror type, and range.

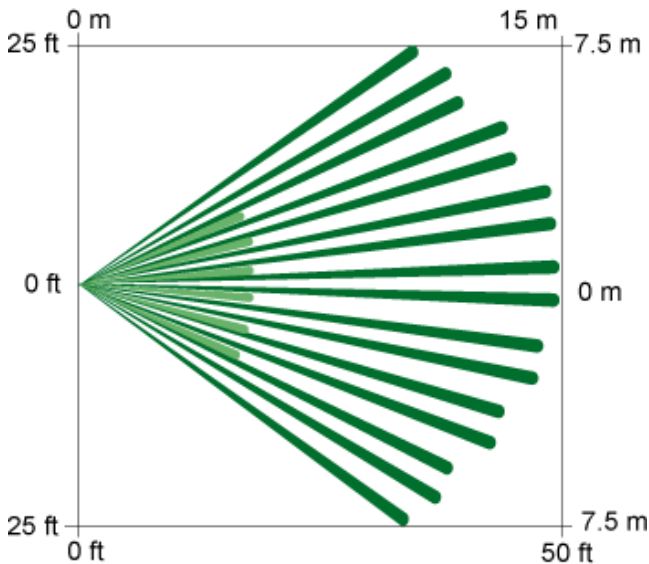

Top View
Standard Broad Coverage: 9 m to 15 m x 15 m
(30 ft to 50 ft x 50 ft)



Side View
Standard Broad Coverage: 9 m to 15 m x 15 m
(30 ft to 50 ft x 50 ft)

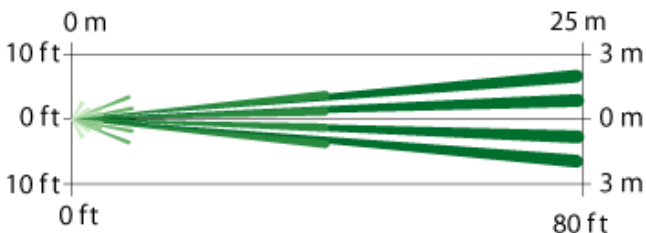

Top View
Optional Barrier Coverage: 15 m to 25 m x 5 m
(50 ft to 80 ft x 16 ft)



Side View
Optional Barrier Coverage: 15 m to 25 m x 5 m
(50 ft to 80 ft x 16 ft)



Top View
Optional Long Range Coverage: 25 m to 36 m x 3 m
(80 ft to 120 ft x 10 ft)



Side View
Optional Long Range Coverage: 25 m to 36 m x 3 m
(80 ft to 120 ft x 10 ft)

Technical Specifications

Environmental Considerations

Temperature (Operating): -29°C to +49°C (-20°F to +120°F). For UL Listed Requirements, the temperature range is 0°C to +49°C (+32°F to +120°F).

Power Requirements

Standby Power: There is no internal standby battery. Connect to DC power sources capable of supplying standby power if primary power fails. For each hour of standby time needed, 350 µAh are required. For UL Listed Requirements, 4 hrs. (1400 µAh) minimum is required.

Voltage (Input): 12 VDC from panel's MUX bus and optionally from an auxiliary power supply.

Current Draw (two-wire):

LED Off: < 350 µA draw on MUX bus

In Alarm; LED On: 2 mA draw on MUX bus

Current Draw (four-wire):

LED Off: < 350 µA draw on MUX bus, 0 mA draw on Aux. power

In Alarm; LED On: < 350 µA draw on MUX bus, 3 mA draw on Aux. power

Ordering Information

MX775i Multiplex PIR Intrusion Detector **MX775i**
 Provides a tamper switch, movable mirrors, and selectable sensitivity.

Accessories

B328 Gimbal-mount Bracket **B328**
 Mounts on a single-gang box and allows rotation of a detector. Wires are hidden inside.

Swiveling B335-3 low-profile mount **B335-3**
 Swiveling, low-profile, plastic mount for wall mounting. The vertical swivel range is +10° to -20°, while the horizontal swivel range is ±25°. Available in triple packs.

OMB77-3 Barrier Mirror **OMB77-3**
 Provides barrier coverage with a 25 m x 5 m (80 ft x 16 ft) pattern. Shipped in packages of three.

Ordering Information

OMLR77-3 Long-range Mirror

Provides long-range coverage with a 40 m x 3 m (120 ft x 10 ft) pattern. Shipped in packages of three.

OMLR77-3

MX934i Multiplex PIR Intrusion Detector



Features

- ▶ Motion Analyzer II processing
- ▶ Unique address switch settings
- ▶ Insect and draft immunity
- ▶ Three sensitivity settings

The wall mount MX934i PIR Intrusion Detector uses Motion Analyzer II signal processing to reduce false alarms. Alarm and tamper conditions are transmitted to the control panel through the two-wire multiplex bus. The detector's replaceable and pointable mirrors, three coverage patterns, and three mounting options provide installation flexibility.

Functions

Motion Analyzer II Processing

Motion Analyzer II uses multiple thresholds and timing windows to analyze timing, amplitude, duration, and polarity of signals to make an alarm decision. It tolerates extreme levels of heat and light disturbances caused by heaters and air conditioners, hot and cold drafts, sunlight, lightning, and moving headlights.

Insect and Draft Immunity

The sealed optical chamber provides immunity to drafts and insects.

Three Sensitivity Settings

- **Standard Sensitivity:** Recommended setting for maximum false alarm immunity. Tolerates environment extremes on this setting. Not recommended for long range or barrier type coverage patterns. The detector is shipped in Standard Sensitivity mode.

- **Intermediate Sensitivity:** Recommended setting for any location where an intruder is expected to cover only a small portion of the protected area. Tolerates normal environments on this setting. This setting identifies intruders more accurately.
- **High Sensitivity:** Fast response to intruder signals. For use in quiet environments where heat and light fluctuations are not anticipated.

Certifications and Approvals

Region	Certification	
Europe	CE	89/336/EEC, 93/68/EEC, EN55022 (1998), EN50130-4: 1995, EN61000-4: 1995, EN61000-4-2: 1995, EN61000-4-3: 1995, EN61000-4-4: 1995, EN61000-4-5: 1995, EN61000-4-6: 1996, EN61000-4-11: 1994 73/23/EEC, IEC 60950: 1999
USA	UL	ANSR: Intrusion Detection Units (UL639)

Installation/Configuration Notes

Compatibility Information

Control Panels

- DS7400Xi Series
- G Series

Multiplex Expansion Modules

- DS7430
- DS7436
- D8125MUX

Note The DS7400Xi Series Control Panels require ROM version 1.07 or greater.

Mounting Considerations

Select a location that is most likely to intercept an intruder moving across the coverage pattern. Ensure the mounting surface is solid and vibration free. Avoid hot and cold drafts, windows, moisture, direct or reflected sunlight, and small animals. The MX934i is not for outdoor mounting.

Note Misaligning the detector in an optional mounting bracket can reduce range and increase dead zones.

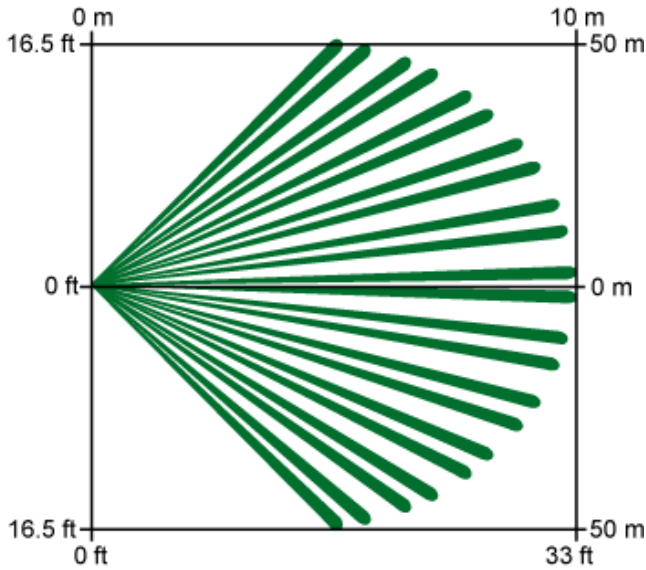

Top View
Standard Broad Coverage: 10 m x 10 m (35 ft x 35 ft)



Side View
Standard Broad Coverage: 10 m x 10 m (35 ft x 35 ft)

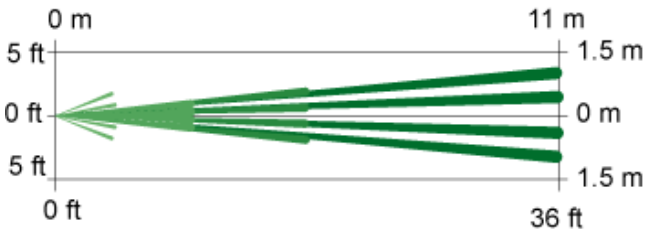

Top View
Optional Barrier Coverage: 10 m x 3 m (35 ft x 10 ft)



Side View
Optional Barrier Coverage: 10 m x 3 m (35 ft x 10 ft)



Top View
Optional Long Range Coverage: 21 m x 3 m (70 ft x 10 ft)



Side View
Optional Long Range Coverage: 21 m x 3 m (70 ft x 10 ft)

Technical Specifications

Enclosure Design

Dimensions: 10.8 cm x 7 cm x 4.6 cm
 (4.25 in. x 2.75 in. x 1.8 in.)

Environmental Considerations

Temperature (Operating): -29°C to +49°C (-20°F to +120°F)
 For UL Listed Applications, 0°C to +49°C (+32°F to +120°F)

Radio Frequency Interference (RFI) Immunity: No alarm or setup on critical frequencies in the range from 26 MHz to 950 MHz at 50 V/m.

Mounting

Height (recommended): 2 m to 2.6 m (6.5 ft to 8.5 ft)
 Location: Surface or corner mount. Ceiling mount with the appropriate mounting bracket.

Internal Pointability: Coverage is adjustable ±10° horizontally, +1° to -18° vertically.

Outputs

Alarm: Signals through the multiplex bus
 Tamper: A tamper condition is signaled through the multiplex bus and displays at the keypads.

Power Requirements

Current Draw (two-wire): LED off: <0.4 mA draw on MUX bus
 LED on: 2 mA draw on MUX bus

Current Draw (four-wire): LED off: <0.4 mA draw on MUX bus
 0 mA draw on Aux. power
 LED on: <0.4 mA draw on MUX bus
 3 mA draw on Aux. power

Input (Voltage): Connects directly to the multiplex (MUX) bus of the control panel and optionally to an auxiliary 12 VDC source

Standby Power: There is no internal standby battery. Connect to DC power sources capable of supplying standby power if primary power fails. For each hour of standby time needed, 0.4 mAh are required. For UL Listed Requirements, four hours (1.4 mAh) minimum are required.

Ordering Information

MX934i Multiplex PIR Intrusion Detector Provides Motion Analyzer II processing, unique address switch settings, insect and draft immunity, and three sensitivity settings.	MX934i
--------------------------------------------------------------------------------------------------------------------------------------------------------------------------------------	---------------

Accessories

Swiveling B335-3 low-profile mount Swiveling, low-profile, plastic mount for wall mounting. The vertical swivel range is +10° to -20°, while the horizontal swivel range is ±25°. Available in triple packs.	B335-3
------------------------------------------------------------------------------------------------------------------------------------------------------------------------------------------------------------------------	---------------

OMLR93-3 Long-range Mirror Provides long-range coverage with a 21 m x 3 m (70 ft x 10 ft) pattern. Shipped in packages of three.	OMLR93-3
--------------------------------------------------------------------------------------------------------------------------------------------	-----------------

DS304 PIR Detector with Replaceable Mirrors



5

Features

- ▶ **First step processing**
- ▶ **Temperature compensation**
- ▶ **Adjustable and replaceable mirrors**
- ▶ **Two coverage patterns**
- ▶ **Three mounting options**
- ▶ **Solid state relay output**
- ▶ **Alarm memory**
- ▶ **Walk test remote control**

The DS304 Passive Infrared (PIR) Detector uses first step processing to reduce false alarms. The detector's mirrors, coverage patterns, and mounting options provide installation flexibility.

Functions

First Step Processing

First step processing (FSP) responds to human intruders while ignoring other sources of motion, minimizing false alarms. You do not need to select the sensitivity levels for the application because FSP adjusts the detector's sensitivity based on signal amplitude, polarity, slope, and timing.

Adjustable and Replaceable Mirrors

You can remove and replace the mirrors. You can also adjust the vertical angle of the mirror to a recommended angle according to the mounting height of the detector and the type of mirror.

Test Features

The DS304 Detector has an external alarm LED (light emitting diode). Walk test remote control means that you can enter a command at the control panel to activate the walk test LED.

Alarm Memory

Provides indication of stored alarms. Controlled by a switched voltage from the control panel.

Certifications and Approvals

Region	Certification	
Europe	CE	89/336/EEC, EN55022: 1998, EN50130-4: 1996, IEC 1000-4-2: 1995, IEC 1000-4-3: 1997, IEC 1000-4-4: 1995, IEC 1000-4-5: 1995, IEC 1000-4-6: 1996 73/23/EEC, 73/23/EEC Annex 1, EN60950-1, EN60825
Belgium	INCERT	B-509-0023
Poland	CNBOP	103/03
France	AFNOR	NF, A2P (262252-00)
Sweden	INTYG	Nr05-135
Europe		Complies with EN50131-1 grade 2

Installation/Configuration Notes

Mounting Considerations

- Mount the detector in an area where an intruder must move across the coverage pattern.
- Mount the detector within the height range of 2 m to 2.6 m; the recommended height is 2.3 m.
- Mount multiple detectors so that the coverage pattern from each detector intersects with another coverage pattern.
- Do not mount the detector on or near windows.
- Do not mount the detector directly in sunlight, in hot air, or in cold air.
- Do not mount the detector near air conditioning outlets, heat sources, or animals.

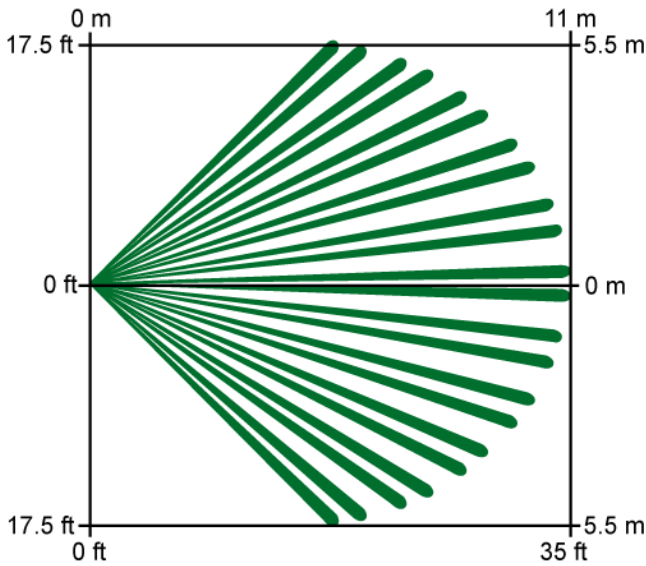

Top View
Standard Broad Coverage 11 m x 11 m
 Walking speed range is 0.2 m/s to 3.0 m/s



Side View
Standard Broad Coverage 11 m x 11 m
 Walking speed range is 0.2 m/s to 3.0 m/s



Top View
Optional Long Range Coverage 21 m x 3 m
 Requires OMLR93-3 Long Range Mirror. Walking speed range is 0.2 m/s to 4.0 m/s.



Side View
Optional Long Range Coverage 21 m x 3 m
 Requires OMLR93-3 Long Range Mirror. Walking speed range is 0.2 m/s to 4.0 m/s.

Technical Specifications

Enclosure Design

Dimensions: 10.8 cm x 7 cm x 4.6 cm
 Material: High impact ABS plastic enclosure

Environmental Considerations

Operating Temperature:	-10°C to +55°C
Relative Humidity:	<95%, non-condensing
Storage Temperature:	-20°C to +60°C
Radio Frequency Interference (RFI) Immunity:	No alarm or setup on critical frequencies in the range from 10 MHz to 1 GHz at 30 V/m.
Complies with Environmental Class II (EN50130-5)	

Mounting

Height Range:	2 m to 2.6 m
Location:	Wall, corner, and ceiling*
*with B338-3 Ceiling Mount Bracket	

Outputs

Relay Contact:	Normally-closed solid state relay 100 mA at 30 VDC maximum.
Tamper:	Normally-closed (with cover in place) tamper switch. Contacts rated at 28 VDC, 125 mA maximum.
Pattern:	Coverage is adjustable -18° to +2° vertically

Power Requirements

Input Power:	Use only an approved limited power source.
Standby Power:	No internal standby battery. Standby power must be provided by an approved limited power source. For each hour of standby time needed, 22 mAh is required.
Supply Voltage Range:	8.0 VDC to 16.0 VDC
Supply Voltage Nominal:	12.0 VDC nominal
Supply Voltage Maximum Ripple (0 to 100 Hz):	2.0 Vpp
Supply Voltage Monitoring:	Alarm at less than 4.0 V

Ordering Information

DS304 PIR Detector with Replaceable Mirrors	DS304
Provides first step processing, two coverage patterns, temperature compensation and three mounting options.	

Swiveling B335-3 low-profile mount	B335-3
Swiveling, low-profile, plastic mount for wall mounting. The vertical swivel range is +10° to -20°, while the horizontal swivel range is ±25°. Available in triple packs.	

OMLR93-3 Long-range Mirror	OMLR93-3
Provides long-range coverage with a 21 m x 3 m (70 ft x 10 ft) pattern. Shipped in packages of three.	

ISC-PDL1-W18x Professional Series TriTech Detectors



5

Features

- ▶ **18 m x 25 m (60 ft x 80 ft) coverage, field selectable to 8 m x 10 m (25 ft x 33 ft)**
- ▶ **EN50131-2-4 Grade 2 compliant**
- ▶ **Sensor data fusion technology**
- ▶ **Tri-focus optics technology**
- ▶ **Range adaptive radar**
- ▶ **Microwave anti-mask**
- ▶ **Active white light suppression**
- ▶ **Dynamic temperature compensation**
- ▶ **Remote walk test**
- ▶ **Alarm memory**

The ISC-PDL1-W18x Professional Series TriTech Detectors are exceptionally suited for commercial indoor applications. Sensor data fusion technology ensures that the detectors send alarm conditions based on precise information. Tri-focus optics eliminate coverage gaps and respond efficiently to intruders. The powerful combination of unique features in the Professional Series delivers superior catch performance and virtually eliminates false alarms.

The self-locking two-piece enclosure, built-in bubble level, flexible mounting height, and three optional mounting brackets simplify installation and reduce service time.

Functions

Sensor Data Fusion Technology

Sensor data fusion technology is a unique feature that uses a sophisticated software algorithm to gather signals from five sensors: two pyroelectric sensors, range adaptive radar, a room temperature sensor, and a white light level sensor. The microcontroller analyzes and compares the sensor data to make the most intelligent alarm decisions in the security industry.

Tri-focus Optics Technology

Tri-focus optics technology uses optics with three specific focal lengths: long-range coverage, middle-range coverage, and short-range coverage. The detector applies the three focal lengths to 86 detection zones, which combine to make 11 solid curtains of detection. Tri-focus optics technology also includes two pyroelectric sensors, which deliver twice the standard optical gain. The sensors process multiple signals to deliver precise performance virtually free of false alarms.

Range Adaptive Radar

The microwave transceiver automatically adjusts its detection thresholds based on input from the PIR sensors. Integrating the target audience distance information from the PIR significantly reduces false alarms from the microwave Doppler radar.

Microwave Anti-mask

The detector sends a supervision-trouble signal if microwave reflective material is placed within 30.5 cm (1 ft) of the detector.

Supervised Microwave and PIR

The detector provides single technology coverage if the microwave subsystem fails.

Active White Light Suppression

An internal light sensor measures the level of light intensity directed at the face of the detector. Sensor data fusion technology uses this information to eliminate false alarms from bright light sources.

Field Selectable Coverage (18 m x 25 m or 8 m x 10 m)

Installers can use a DIP switch to select 18 m x 25 m or 8 m x 10 m (60 ft x 80 ft or 25 ft x 33 ft) coverage.

Dynamic Temperature Compensation

The detector automatically adjusts PIR sensitivity to identify human intruders at critical temperatures. Dynamic temperature compensation detects human body heat accurately, avoids false alarms, and delivers consistent catch performance at all operating temperatures.

Cover and Wall Tamper Switch

When an intruder removes the cover or attempts to separate the detector from the wall, a normally-closed contact opens to alert the control panel.

Self-adjusting LED

The LED brightness adjusts automatically to the surrounding light level. A blue light-emitting diode (LED) indicates dual alarms and activates during a walk test. A yellow LED indicates microwave alarms, and a red LED indicates PIR alarms.

Remote Walk Test LED

Users can type a command through a keypad, a control center, or programming software to remotely enable or disable the walk test LED. Users can locally enable or disable the walk test LED through the DIP switch.

Alarm Memory

Alarm memory flashes the alarm LED to indicate stored alarms for use in multiple unit applications. A switched voltage from the control panel controls the alarm memory.

Solid State Relays

Solid state relays send silent alarm output signals to provide a higher level of security and reliability. An external magnet does not activate the relay. The solid state relay uses less current than a mechanical relay, providing longer standby capacity during a power loss.

Draft, Insect, and Small Animal Immunity

The sealed optic chamber provides immunity to drafts and insects, reducing false alarms. Small animal immunity reduces false alarms caused by animals less than 4.5 kg (10 lb), such as rodents.

Remote Self Test

A remote self test initiates when the walk test input switches to its true state. The alarm relay and alarm LED activate for four seconds following a successful test. The trouble relay activates, and the alarm LED flashes following a failed test.

Input Power Supervision

When the power is lower than 8 V, a low input power trouble condition activates the trouble relay and causes the LED to flash. The trouble condition clears automatically when power reaches or exceeds 8 V.

Trouble Memory

When the walk test input switches to its true state for less than two seconds, LED flashes to indicate the most recent trouble condition. If there is no trouble in memory, the LED does not flash. After twelve hours, or after the detector receives a second walk test pulse for two seconds or less, the LED stops flashing and the trouble memory clears.

Certifications and Approvals

Region	Certification	
Europe	CE	89/336/EEC European Council Directive; EN 55022: 1998 +A2: 2003 (CISPR 22: 1997); EN 50130-4: 1995 +A2: 2003; EN 61000-4-2: 1995 +A2: 2001; EN 61000-4-3: 1996 +A1: 2002; EN 61000-4-4: 1995 +A2: 2001; EN 61000-4-5: 1995 +A1: 2001; EN 61000-4-6: 2003; EN 61000-4-11: 1994 +A1: 2001; EN 60950-1: 2001 1st edition (IEC 60950-1: 2001); EN 300 440-1, V1.2.2: 1999; EN 301 489-1 V1.4.1: 2002 and -3 V1.2.1: 2000; TS 50131-2-4: 2004 (v0)
	EN50131	ISC-PDL1-WA18H tested to EN 50131-1 Grade 2, TS 50131-2-2 August 2004, TS 50131-2-4 August 2004, EN 50130-4, EN 50130-5
Belgium	INCERT	(B-509-0052)
Poland	TECHOM	ISC-PDL1-W18G
USA	UL	W18G only: ANSR: Intrusion Detection Units (UL639), ANSR7: Intrusion Detection Units Certified for Canada (cULus)
	FCC	(T3XISC-PDL1-W18G)
Italy	IMQ	(CA12.00833)
Canada	IC	(1249A-W18G)
France	AFNOR	W18H: Type 3(*), NFetA2P (NF 324-H58)
China	CCC	2007031901000294
Sweden	INTYG	ISC-PDL1-W18G only: Nr07-169
Brazil	ANATEL	1282-06-1855
the Netherlands	REQ	07223002/AA/00 (ISC-PDL1-W18G)
The detectors are also designed to comply with the following standards and approvals.		
Australia	C-Tick	

Installation/Configuration Notes

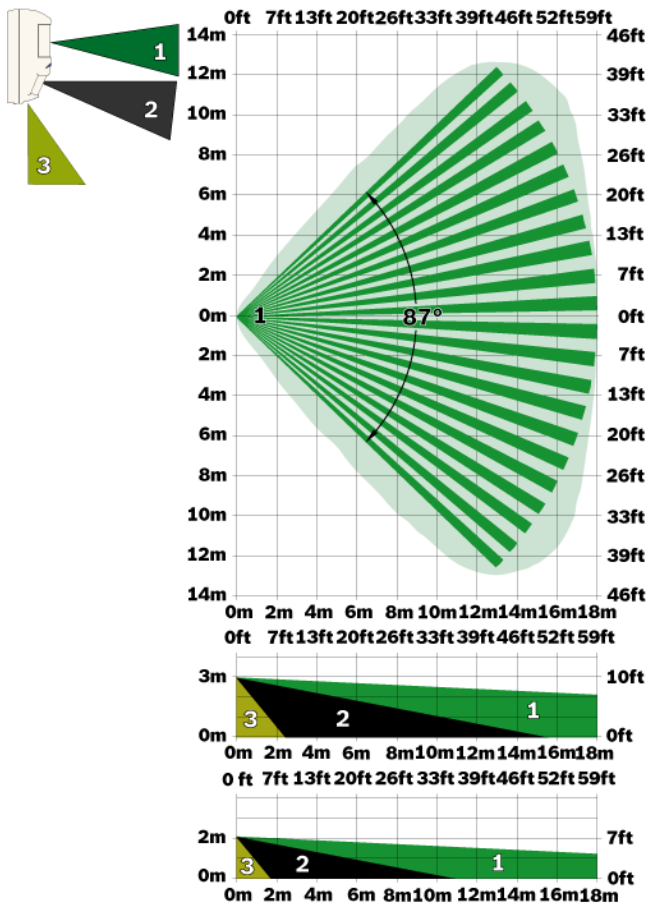

Long-range Coverage 18 m x 25 m (60 ft x 80 ft)

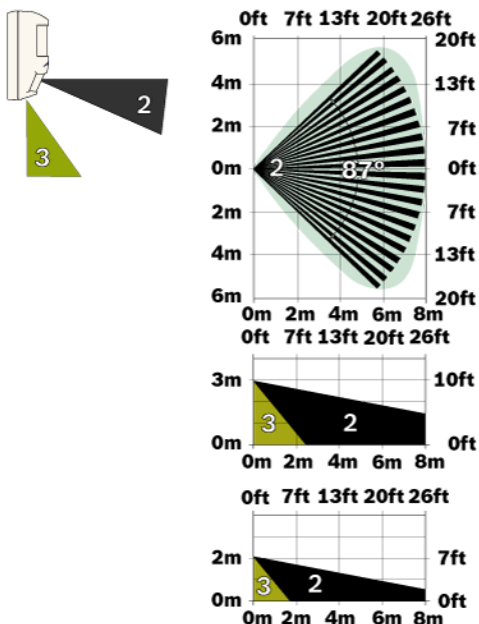

Selectable Short-range Coverage 8 m x 10 m (25 ft x 33 ft)

Mounting Considerations

The recommended mounting height is 2 m to 3 m (7 ft to 10 ft).

Use an optional B328 Gimbal-mount Bracket or B335-3 Low-profile Swivel-mount Bracket to surface-mount the detector on a flat wall or in a corner.

Use an optional B338 Universal Ceiling Bracket to mount the detector on the ceiling.

Wiring Considerations

Recommended wire size is 0.2 mm² to 1 mm² (26 AWG to 16 AWG).

Parts Included

Quantity	Component
1	Detector
2	Flat-head screws
2	Screw anchors
1	Nylon cable tie
1	Pattern Mask
1	Installation Guide

Technical Specifications

Electrical

Power Requirements

Voltage (Operating):	9 VDC to 15 VDC
Current (Maximum):	< 25 mA
Current (Standby):	13 mA

Outputs

Relay:	Solid state relay, normally-closed (NC) contacts power supervised. 3 W, 125 mA, 25 VDC, resistance < 10 Ω.
Tamper:	Normally-closed (NC) contacts (with cover on) rated at 25 VDC, 125 mA maximum. Connect tamper circuit to 24-hour protection circuit.
Trouble:	Solid-state relay normally-closed (NC) contacts.

Mechanical

Enclosure Design

Color:	White
Dimensions:	136 mm x 69 mm x 58 mm (5.25 in. x 2.75 in. x 2.25 in.)
Material:	High-impact ABS plastic

Indicators

Alarm Indicator:	<ul style="list-style-type: none"> Blue LED for TriTech+ alarms Yellow LED for microwave alarms Red LED for PIR alarms
------------------	---------------------------------------------------------------------------------------------------------------------------------------------------------

Zones

Zones:	86
--------	----

Frequency Information

Radio Frequency Interference (RFI) immunity:	No alarm or setup on critical frequencies in the range from 26 MHz to 1 GHz at 50 V/m.
----------------------------------------------	----------------------------------------------------------------------------------------

Environmental

Relative Humidity:	0 to 95%, non-condensing
Temperature (Operating and Storage):	-29°C to +55°C (-20°F to +130°F) <i>For UL Certificated installations, 0°C to +49°C (+32°F to +120°F)</i>
Environmental Class II	EN 50130-5
Protection Rating:	IP41, IK04 (EN 60529, EN 50102)

Ordering Information

ISC-PDL1-W18G Professional Series TriTech+ Detector 10.525 GHz frequency.	ISC-PDL1-W18G
ISC-PDL1-W18H Professional Series TriTech+ Detector 10.588 GHz frequency. For use in France and the United Kingdom.	ISC-PDL1-W18H

Accessories

B328 Gimbal-mount Bracket Mounts on a single-gang box and allows rotation of a detector. Wires are hidden inside.	B328
Swiveling B335-3 low-profile mount Swiveling, low-profile, plastic mount for wall mounting. The vertical swivel range is +10° to -20°, while the horizontal swivel range is ±25°. Available in triple packs.	B335-3

ISC-PDL1-WA18x Professional Series TriTech+ Detectors with Anti-mask



Features

- ▶ **18 m x 25 m (60 ft x 80 ft) standard coverage, 8 m x 10 m (25 ft x 33 ft) selectable short range coverage**
- ▶ **EN50131-2-4 Grade 3 compliant**
- ▶ **Sensor data fusion technology**
- ▶ **Tri-focus optics technology**
- ▶ **Range adaptive radar**
- ▶ **MANTIS anti-mask**
- ▶ **Active white light suppression**
- ▶ **Dynamic temperature compensation**
- ▶ **Remote walk test**
- ▶ **Alarm memory**

The ISC-PDL1-WA18x Professional Series TriTech+ Detectors with Anti-mask are exceptionally suited for commercial indoor applications. MANTIS anti-mask technology makes obscuring the detector view nearly impossible for intruders. Sensor data fusion technology ensures that the detector sends alarm conditions based on precise information. Tri-focus optics eliminate coverage gaps and respond efficiently to intruders. The powerful combination of unique features in the Professional Series delivers superior catch performance and virtually eliminates false alarms.

The self-locking two-piece enclosure, built-in bubble level, flexible mounting height, and three optional mounting brackets simplify installation and reduce service time.

Functions

Sensor Data Fusion Technology

Sensor data fusion technology is a unique feature that uses a sophisticated software algorithm to gather signals from five sensors: two pyroelectric sensors, a range adaptive radar sensor, a room temperature sensor, and a white light level sensor. The microcontroller analyzes and compares the sensor data to make the most intelligent alarm decisions in the security industry.

Tri-focus Optics Technology

Tri-focus optics technology uses optics with three specific focal lengths: long-range coverage, middle-range coverage, and short-range coverage. The detector applies the three focal lengths to 86 detection zones, which combine to make 11 solid curtains of detection. Tri-focus optics technology also includes two pyroelectric sensors, which deliver twice the standard optical gain. The sensors process multiple signals to deliver precise performance virtually free of false alarms.

Range Adaptive Radar

The microwave transceiver automatically adjusts its detection thresholds based on input from the PIR sensors. Integrating the target distance information from the PIR significantly reduces false alarms from the microwave Doppler radar.

MANTIS Anti-mask Technology

MANTIS (**M**ulti-point **A**nti-mask with **I**ntegrated **S**pray detection) uses patented prism lenses and active infrared detection to provide industry-leading protection against all known forms of attack. MANTIS complies with the latest worldwide regulatory standards for detecting objects covering or placed in front of the detector. MANTIS is sensitive to materials regardless of texture or color, including fabric, paper, metal, plastic, tape, and spray. When MANTIS identifies a masking material, the detector sends a supervision anti-mask signal to the control panel.

Active White Light Suppression

An internal light sensor measures the level of light intensity directed at the face of the detector. Sensor data fusion technology uses this information to eliminate false alarms from bright light sources.

Available Coverage

The standard coverage is 18 m x 25 m (60 ft x 80 ft). Installers can set a DIP switch at the detector to select short range coverage of 8 m x 10 m (25 ft x 33 ft).

Dynamic Temperature Compensation

The detector automatically adjusts PIR sensitivity to identify human intruders at critical temperatures. Dynamic temperature compensation detects human body heat accurately, avoids false alarms, and delivers consistent catch performance at all operating temperatures.

Cover and Wall Tamper Switch

When an intruder removes the cover or attempts to separate the detector from the wall, a normally-closed contact opens to alert the control panel.

Self-adjusting LEDs

The LED brightness adjusts automatically to the surrounding light level. A blue light-emitting diode (LED) indicates TriTech+ alarms and activates during a walk test. A yellow LED indicates microwave alarms, and a red LED indicates PIR alarms.

Remote Walk Test LED

Users can enter a command through a keypad, a control center, or programming software to remotely enable or disable the walk test LED.

Alarm Memory

Alarm memory flashes the alarm LED to indicate stored alarms for use in multiple unit applications. A switched voltage from the control panel controls the alarm memory.

Solid State Relays

Solid state relays send silent alarm output signals to provide a higher level of security and reliability. An external magnet does not activate the relay. The solid state relay uses less current than a mechanical relay, providing longer standby capacity during a power loss.

Draft, Insect, and Small Animal Immunity

The sealed optic chamber provides immunity to drafts and insects, reducing false alarms. Small animal immunity reduces false alarms caused by animals less than 4.5 kg (10 lb), such as rodents.

Remote Self Test

A remote self test initiates when the walk test input switches to its true state. The alarm relay and alarm LED activate for four seconds following a successful test. The trouble relay activates, and the alarm LED flashes following a failed test.

Input Power Supervision

When the power is lower than 8 V, a low input power trouble condition activates the trouble relay and causes the LED to flash. The trouble condition clears automatically when power reaches or exceeds 8 V.

Trouble Memory

When the walk test input switches to its true state for less than two seconds, the LED flashes to indicate the most recent trouble condition. If there is no trouble in memory, the LED does not flash. After twelve hours, or after the detector receives a second walk test pulse for two seconds or less, the LED stops flashing and the trouble memory clears.

DIP Switch Programming

The following functions are all programmed using DIP switch settings:

- Local Walk Test LED
- Remote Walk Test Input Polarity
- Alarm Memory Polarity
- Long and Short Range Select
- MANTIS Anti-mask On and Off

Certifications and Approvals

Region	Certification	
Europe	CE	2004/108/EC EMC Directive; 1999/5/EC Radio Equipment and Telecommunications Terminal Equipment, Annex V, EN 55022: 1998, +A2: 2003, ClassB; EN 50130-4: 1995, +A1: 1998, +A2: 2003; IEC 60950-1: 2001, EN 60950-1: 2001; EN 300 440-2, V1.1.2 (2004-07)
	EN50131	G or H only: EN 50131-1, TS 50131-2-2 August 2004, RT 50132-2-2 July 2007, TS 50131-2-4 July 2007, RT 50131-2-4 July 2007, EN 50130-4, EN50130-5
Belgium	INCERT	B-509-0052/a
Sweden	INTYG	ISC-PDL1-WA18G only: Nr08-235

The detectors are also designed to comply with the following standards and approvals.

Europe	EN50131	EN50131-2-4 Grade 3
USA	UL	cULus –UL639, Intrusion Detection Units
	FCC	Complies with Part 15

Installation/Configuration Notes

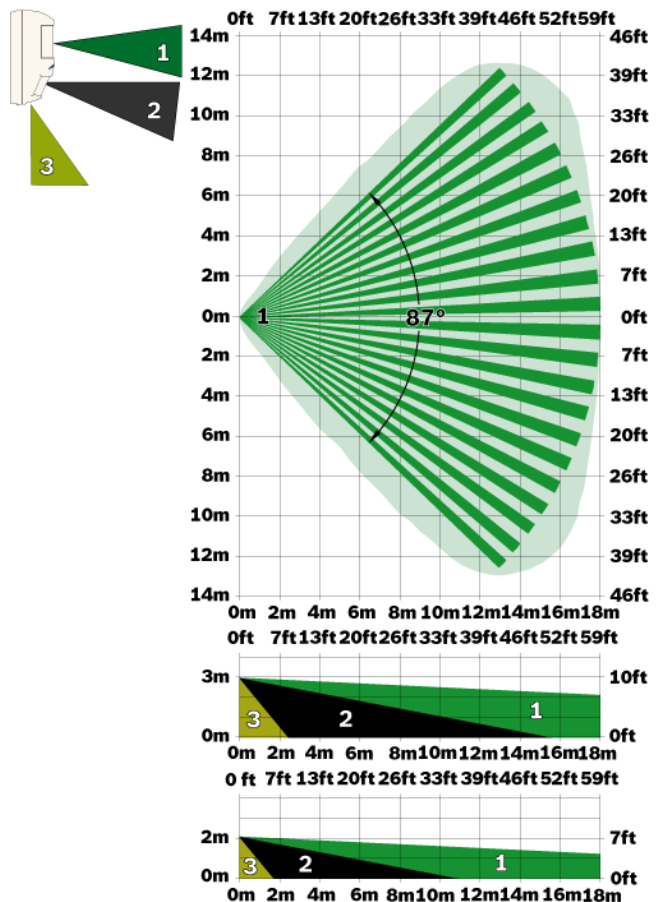

Long-range Coverage 18 m x 25 m (60 ft x 80 ft)

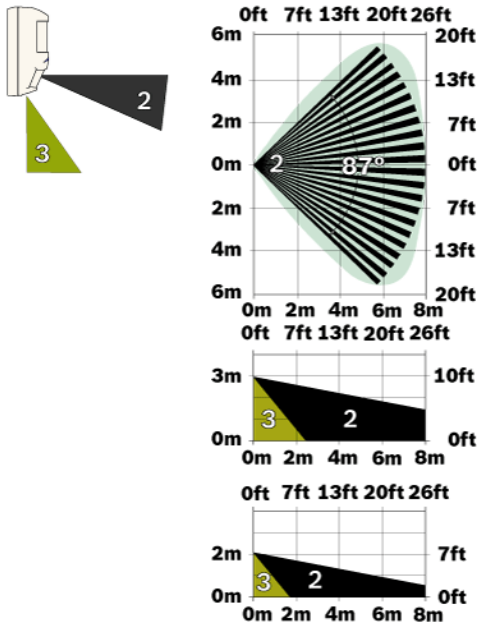

Selectable Short-range Coverage 8 m x 10 m (25 ft x 33 ft)

Mounting Considerations

The recommended mounting height is 2 m to 3 m (7 ft to 10 ft).

Use an optional B328 Gimbal-mount Bracket or B335-3 Low-profile Swivel-mount Bracket to surface-mount the detector on a flat wall or in a corner.

Use an optional B338 Universal Ceiling Bracket to mount the detector on the ceiling.

Wiring Considerations

Recommended wire size is 0.2 mm² to 1 mm² (26 AWG to 16 AWG).

Parts Included

Quantity	Component
1	Detector
2	Flat-head screws
2	Screw anchors
1	Nylon cable tie
1	Pattern Mask
1	Installation Guide

Technical Specifications

Electrical

Power Requirements

Voltage (Operating):	9 VDC to 15 VDC
Current (Maximum):	< 26 mA with alarm, trouble, and LEDs active.
Current (Standby):	18 mA at 12 VDC

Outputs for All Models

Tamper:	Normally-closed (NC) contacts (with cover on) rated at 25 VDC, 125 mA maximum. Connect tamper circuit to 24-hour protection circuit.
Trouble:	Solid state relay normally-closed (NC) contacts.

Outputs for ISC-PDL1-WA18G and ISC-PDL1-WA18H

Relay:	Solid state relay, normally-closed (NC) contacts, power supervised. 3 W, 125 mA, 25 VDC, resistance < 10 Ω.
--------	-------------------------------------------------------------------------------------------------------------

Outputs for ISC-PDL1-WA18GB

Relay:	Solid state relay, normally-open (NO) contacts, power supervised. 3 W, 125 mA, 25 VDC, resistance < 10 Ω.
--------	-----------------------------------------------------------------------------------------------------------

Mechanical

Enclosure Design

Color:	White
Dimensions:	127 mm x 69 mm x 58 mm (5 in. x 2.75 in. x 2.25 in.)
Material:	High-impact ABS plastic

Indicators

Alarm Indicator:	<ul style="list-style-type: none"> Blue LED for TriTech+ alarms Yellow LED for microwave alarms Red LED for PIR alarms
------------------	---------------------------------------------------------------------------------------------------------------------------------------------------------

Zones

Zones:	86
--------	----

Environmental

Relative Humidity:	0 to 95%, non-condensing
Temperature (Operating and Storage):	-30°C to +55°C (-22°F to +130°F) For AFNOR certificated installations, -10°C to +55°C (+14°F to +130°F) For UL Certificated installations, 0°C to +49°C (+32°F to +120°F)
Environmental Class II	EN 50130-5
Protection Rating:	IP 41, IK04 (EN 60529, EN 50102)

Ordering Information

ISC-PDL1-WA18G TriTech+ Detector with Anti-mask 10.525 GHz frequency.	ISC-PDL1-WA18G
---------------------------------------------------------------------------------	-----------------------

ISC-PDL1-WA18GB TriTech+ Detector with Anti-mask 10.525 GHz frequency. Includes solid state relay, normally-open (NO) alarm contacts.	ISC-PDL1-WA18GB
-------------------------------------------------------------------------------------------------------------------------------------------------	------------------------

ISC-PDL1-WA18H TriTech+ Detector with Anti-mask 10.588 GHz frequency. For use in France and the United Kingdom.	ISC-PDL1-WA18H
---------------------------------------------------------------------------------------------------------------------------	-----------------------

Accessories

B328 Gimbal-mount Bracket Mounts on a single-gang box and allows rotation of a detector. Wires are hidden inside.	B328
-----------------------------------------------------------------------------------------------------------------------------	-------------

Swiveling B335-3 low-profile mount Swiveling, low-profile, plastic mount for wall mounting. The vertical swivel range is +10° to -20°, while the horizontal swivel range is ±25°. Available in triple packs.	B335-3
------------------------------------------------------------------------------------------------------------------------------------------------------------------------------------------------------------------------	---------------

ISM-BLD1

Blue Line TriTech Detectors



5

Features

- ▶ **11 m x 11 m (35 ft x 35 ft) broad coverage**
- ▶ **EN50131-2-4 Grade 2 compliant**
- ▶ **Dual detection technologies with advanced signal processing**
- ▶ **Flexible mounting height from 2.3 m to 2.7 m (7.5 ft to 9 ft)**
- ▶ **No range or height adjustments required**
- ▶ **Supervised microwave; microwave range can be adjusted**
- ▶ **Eight detection layers including optional look-down zone**
- ▶ **Draft and insect immunity**
- ▶ **Temperature compensation**
- ▶ **Combined cover and wall tamper**

The ISM-BLD1 TriTech® Detectors use a combination of passive infrared (PIR) and microwave detection technologies with advanced signal processing. These unobtrusive detectors are simple to install and do not need field adjustments.

These detectors are available in three frequencies:

Frequency	Detector
9.9 GHz	ISM-BLD1-F3
10.525 GHz	ISM-BLD1-F1
10.687 GHz	ISM-BLD1-F4

Functions

Advanced Signal Processing

Adaptive processing adjusts to background disturbances, reducing false alarms without sacrificing intruder detection.

First Step Processing (FSP) almost instantly responds to human targets without producing false alarms from other sources. FSP adjusts the detector's sensitivity based on signal amplitude, polarity, slope, and timing. This eliminates the need for the installer to select the sensitivity level. Each sensor (PIR and microwave) processes signals individually, and both sensors must agree there is an alarm before the alarm relay activates.

Test Features

An externally-visible, tricolor (blue, yellow, green) alarm LED (light-emitting diode) indicates each sensor's status.

Supervised Microwave

The microwave circuit is fully-supervised. If the microwave subsystem fails, the PIR subsystem provides single technology coverage.

Draft and Insect Immunity

The sealed optical chamber prevents drafts and insects from affecting the detector.

Temperature Compensation

The detector adjusts its sensitivity to maintain its ability to identify human intruders at critical temperatures.

Certifications and Approvals

Region	Certification	
Belgium	INCERT	ISM-BLD1-F1: B-509-0014/c
Russia	GOST	ISM-BLD1-F1: GOST 12997-84, GOST R 50009-2000, GOST R 51317.3.2-99, GOST 51317.3.3-99, GOST R MEK 60065-2002
France	AFNOR	ISM-BLD1-F3: NF, A2P (282112-00)
Brazil	ANATEL	ISM-BLD1-F1: 0251-06-1855
Europe		ISM-BLD1-F1 complies with EN50131-2-4 Grade 2

Installation/Configuration Notes

Application Information

Coverage Patterns

Note An alarm occurs only when an intruder is detected in areas in which the PIR and microwave patterns overlap.

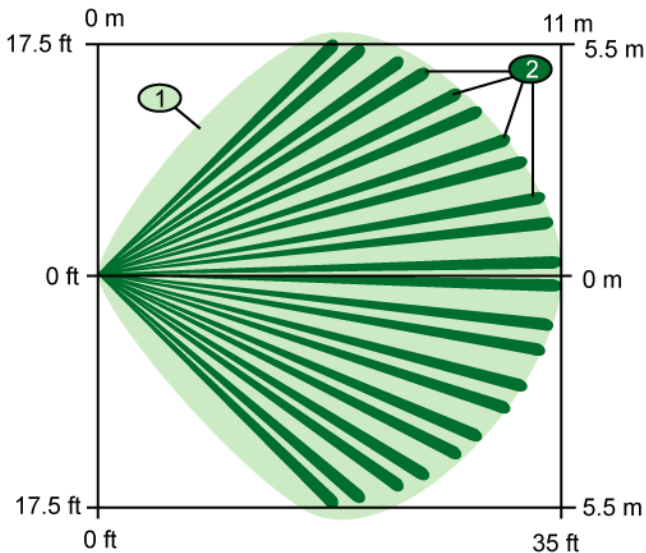

Top View Broad: 11 m x 11 m (35 ft x 35 ft)

- 1 Microwave coverage area
- 2 PIR coverage pattern

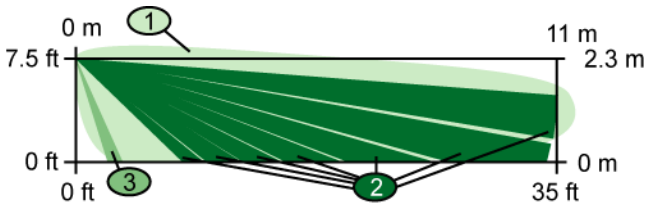

Side View Broad: 11 m x 11 m (35 ft x 35 ft)

- 1 Microwave coverage area
- 2 PIR coverage pattern
- 3 Look-down zone

Mounting

The recommended mounting height is 2.3 m to 2.7 m (7.5 ft to 9 ft).

The detector can be mounted:

- On a flat wall (surface, semi-flush), with the optional B335 Swivel-mount Bracket, or with the optional B328 Gimbal-mount Bracket.
- At the junction of two perpendicular walls.
- On the ceiling with the optional B338 Ceiling-mount Bracket.

Standby Power

This detector has no internal standby battery.

Parts Included

Quant.	Component
1	Detector
1	Hardware pack
1	Literature pack

Technical Specifications

Environmental Considerations

Complies with EN50131-2-4 Environmental Class II, Security Grade 2	
Relative Humidity:	0 to 85%, non-condensing
Temperature (operating):	-29°C to +49°C (-20°F to +120°F)

Mechanical Properties

Color:	White
Dimensions:	13.2 cm x 6.1 cm x 4.8 cm (5.2 in. x 2.4 in. x 1.9 in.)
Material:	High-impact ABS plastic
Radio Frequency Interference (RFI) Immunity:	No alarm or setup on critical frequencies in the range from 26 MHz to 950 MHz for field strengths less than 50 V/m.

Outputs

Digital Alarm:	5 V normally, grounded for 4 sec during alarm.
Relay:	Solid state, supervised, Form A normally-closed (NC) contacts rated for 125 mA, 28 VDC, 3 W.
Tamper:	Normally-closed (NC) contacts (with cover on) rated at 28 VDC, 125 mA maximum. Connect tamper circuit to 24-hour protection circuit.

Power Requirements

Current (Alarm):	22 mA
Current (Standby):	15 mA maximum at 12 VDC
Voltage (Operating):	10 VDC to 14 VDC

Trademarks

TriTech® is a registered trademark of Bosch Security Systems, Inc. in the United States.

Ordering Information

Accessories

ISM-BLA1-CC Blue Line Color Camera Module (NTSC format) NTSC format	ISM-BLA1-CC-N
ISM-BLA1-CC Blue Line Color Camera Module (PAL format) PAL format	ISM-BLA1-CC-P
ISM-BLA1-LM Blue Line Nightlight Module Fits all Blue Line detectors	ISM-BLA1-LM
ISM-BLA1-SM Blue Line Sounder Module Fits all Blue Line detectors	ISM-BLA1-SM
B328 Gimbal-mount Bracket Mounts on a single-gang box and allows rotation of a detector. Wires are hidden inside.	B328
Swiveling B335-3 low-profile mount Swiveling, low-profile, plastic mount for wall mounting. The vertical swivel range is +10° to -20°, while the horizontal swivel range is ±25°. Available in triple packs.	B335-3

ISM-BLD1-P Blue Line Pet Friendly TriTech Detectors



5

Features

- ▶ **11 m x 11 m (35 ft x 35 ft) broad coverage**
- ▶ **EN50131-2-4 Grade 2 compliant**
- ▶ **Pet Friendly®**
- ▶ **Dual detection technologies with advanced signal processing**
- ▶ **Flexible mounting height from 2.3 m to 2.7 m (7.5 ft to 9 ft)**
- ▶ **No range or height adjustments required**
- ▶ **Supervised microwave; microwave range can be adjusted**
- ▶ **Eight detection layers including optional look-down zone**
- ▶ **Draft and insect immunity**
- ▶ **Temperature compensation**

The ISM-BLD1-P Pet Friendly® TriTech® Detectors use a combination of passive infrared (PIR) and microwave detection technologies. With advanced signal processing and these detection technologies, the detectors generate alarms for human intruders without generating false alarms for pets. These small unobtrusive detectors are simple to install and do not need field adjustments.

These detectors are available in three frequencies:

Frequency	Detector
9.9 GHz	ISM-BLD1-P-F3
10.525 GHz	ISM-BLD1-P-F1
10.687 GHz	ISM-BLD1-P-F4

Functions

Advanced Signal Processing

Adaptive processing adjusts to background disturbances, reducing false alarms without sacrificing the ability to respond to an intruder.

First Step Processing (FSP) almost instantly responds to human targets without producing false alarms from other sources. FSP adjusts the detector's sensitivity based on signal amplitude, polarity, slope, and timing. This eliminates the need for the installer to select the sensitivity level. Each sensor (PIR and microwave) processes signals individually, and both sensors must agree there is an alarm before the alarm relay activates.

Test Features

An externally-visible, tri-color (blue, yellow, green) alarm LED (light-emitting diode) indicates each sensor's status.

Supervised Microwave

The microwave circuit is fully supervised. If the microwave subsystem fails, the PIR subsystem provides single technology coverage.

Pet Immunity (not tested by UL)

The detector can distinguish between signals caused by humans and signals caused by pets. It ignores signals caused by one or two pets up to 45 kg (100 lb) or numerous rodents.

Draft and Insect Immunity

The sealed optical chamber prevents drafts and insects from affecting the detector.

Temperature Compensation

The detector adjusts its sensitivity to maintain its ability to identify human intruders at critical temperatures.

Certifications and Approvals

Region	Certification
Europe	CE 89/336/EEC, EN55022: 1998 +A1: 2000 +A2: 2003 (ANSI C63.4: 2001), EN50130-4: 1996 +A1: 1998 +A2: 2003, EN61000-3-3: 1995 +A1: 2001, EN61000-4-2: 1995 +A1: 1998 +A2: 2001, EN61000-4-3: 2002 +A1: 2002, EN61000-4-4: 1995 +A1: 2000 +A2: 2001, EN61000-4-5: 1995 +A1: 2001, EN61000-4-6: 1996 +A1: 2001, EN61000-4-11: 1994 +A1: 2001, EN300440: 1996, TS 50131-2-2: 2004 (Version 1)
Belgium	INCERT ISM-BLD1-P-F1: B-509-0014/c
Poland	CNBOP ISM-BLD1-P-F1: 82/04

Region	Certification	
Russia	GOST	ISM-BLD1-P-F1: IEC 60839-1-3-2001, IEC 60839-2-2-2001, IEC 60839-2-6-2001, GOST 26342-84, GOST 27990-88 ISM-BLD1-P-F1: GOST 12997-84, GOST R 50009-2000, GOST R 51317.3.2-99, GOST R 51317.3.3-99, GOST R MEK 60065-2002
USA	UL	ANSR: Intrusion Detection Units (UL639), ANSR7: Intrusion Detection Units Certified for Canada (cULus)
	FCC	ISM-BLD1-P-F1: ESVD1
Italy	IMQ	
Canada	IC	ISM-BLD1-P-F1: 1249A-ISMBLD1
Czech Republic	NBU	SIM-BLD1-P-F1: T1209/2004
France	AFNOR	ISM-BLD1-P-F3: NF, A2P (282111-00)
Sweden	INTYG	ISM-BLD1-P-F1 only: Nr05-270
Brazil	ANATEL	ISM-BLD1-P-F1: 0251-06-1855
Australia	C-tick	F1 model only
Ukraine		IEC 60839-1-3-2001, IEC 60839-2-2-2001, IEC 60839-2-6-2001, GOST 26342-84, GOST 27990-88
Europe		Complies with EN50131-2-4 Grade 2

Installation/Configuration Notes

Application Information

Coverage Patterns

Note An alarm occurs only when an intruder is detected in areas in which the PIR and microwave patterns overlap.

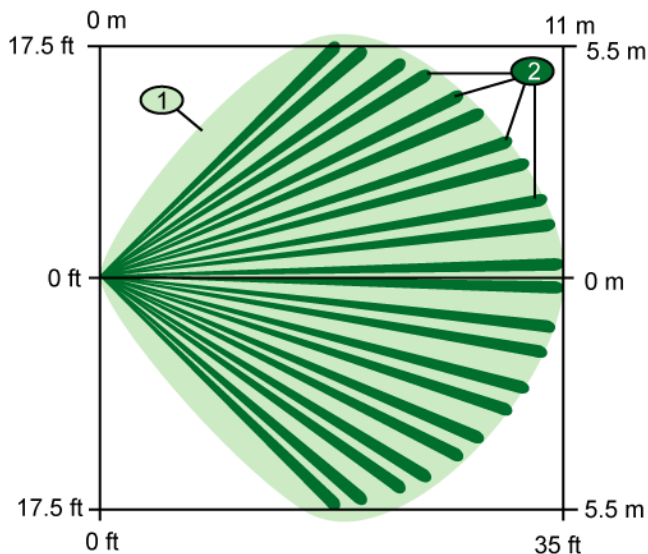

Top View Broad: 11 m x 11 m (35 ft x 35 ft)

- 1 Microwave coverage area
- 2 PIR coverage pattern

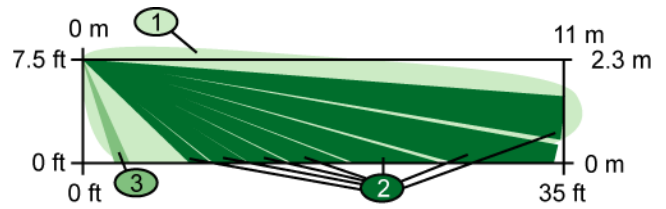

Side View Broad: 11 m x 11 m (35 ft x 35 ft)

- 1 Microwave coverage area
- 2 PIR coverage pattern
- 3 Look-down zone

Mounting

The recommended mounting height is 2.3 m to 2.7 m (7.5 ft to 9 ft).

The detector can be mounted:

- On a flat wall (surface, semi-flush) with the optional B335 Swivel-mount Bracket, or with the optional B328 Gimbal-mount Bracket,
- In the junction of two perpendicular walls, or
- On the ceiling with the optional B338 Ceiling-mount Bracket.

Standby Power

This detector has no internal standby battery. For UL Listed product installations, 4 hr (60 mAh) of standby power must be supplied by the control unit or by a UL Listed burglary power supply.

Parts Included

Quant.	Component
1	Detector
1	Hardware pack
1	Literature pack

Technical Specifications

Environmental Considerations

Complies with EN50131-2-4 Environmental Class II, Security Grade 2

Relative Humidity: 0 to 85%, non-condensing

Temperature (operating): -29°C to +49°C (-20°F to +120°F)
For UL Listed product installations, 0°C to +49°C (+32°F to +120°F)

Mechanical Properties

Color: White

Dimensions: 13.2 cm x 6.1 cm x 4.8 cm (5.2 in. x 2.4 in. x 1.9 in.)

Material: High-impact ABS plastic

Radio Frequency Interference (RFI) Immunity: No alarm or setup on critical frequencies in the range from 26 MHz to 950 MHz at field strengths less than 50 V/m.

Outputs

Digital Alarm:	5 V normally, ground for 4 sec during alarm.
Relay:	Solid state, supervised Form A normally-closed (NC) contacts rated for 125 mA, 28 VDC, 3 W.
Tamper:	Normally-closed (NC) contacts (with cover on) rated at 28 VDC, 125 mA maximum. Connect tamper circuit to 24-hour protection circuit.

Power Requirements

Current (Alarm):	22 mA
Current (Standby):	15 mA maximum at 12 VDC
Voltage (Operating):	10 VDC to 14 VDC

Trademarks

Pet Friendly® and TriTech® are registered trademarks of Bosch Security Systems in the United States.

Ordering Information**Accessories**

ISM-BLA1-CC Blue Line Color Camera Module (NTSC format) NTSC format	ISM-BLA1-CC-N
ISM-BLA1-CC Blue Line Color Camera Module (PAL format) PAL format	ISM-BLA1-CC-P
ISM-BLA1-LM Blue Line Nightlight Module Fits all Blue Line detectors	ISM-BLA1-LM
ISM-BLA1-SM Blue Line Sounder Module Fits all Blue Line detectors	ISM-BLA1-SM
B328 Gimbal-mount Bracket Mounts on a single-gang box and allows rotation of a detector. Wires are hidden inside.	B328
Swiveling B335-3 low-profile mount Swiveling, low-profile, plastic mount for wall mounting. The vertical swivel range is +10° to -20°, while the horizontal swivel range is ±25°. Available in triple packs.	B335-3

DS825 and DS840 Series TriTech PIR Detectors



Features

- ▶ Artificial intelligence
- ▶ First step processing
- ▶ Pointable mirrored optics
- ▶ Supervised microwave and PIR
- ▶ Pet and animal immunity
- ▶ Temperature compensation

The DS825 and DS840 Series Detectors provide immunity to false alarms caused by pets. Passive infrared and microwave processing provides excellent catch performance with freedom from false alarms.

Functions

Signal Processing

Uses passive infrared and microwave technologies to provide an alarm condition when both fields of protection are simultaneously activated. Alarm signals must meet the signaling requirements of both technologies to activate an alarm. Adjustable PIR and microwave sensitivity.

First Step Processing (FSP)

First Step Processing (FSP) allows virtually instant response to human targets without sacrificing false alarm immunity to other sources. By adjusting its sensitivity based upon signal amplitude, polarity, slope and timing, FSP eliminates the need for the installer to select the sensitivity level for the application. Each sensor is processed individually and both must agree there is an alarm before the alarm relay is activated.

Microwave Signal Processing

Pattern recognition circuitry identifies and ignores repetitive false alarm sources. Adaptive processing adjusts to background disturbances. This helps to reduce false alarms while maintaining catch performance.

Pet and Animal Immunity

The detector is able to distinguish between signals caused by humans and signals caused by pets (one dog up to 27 kg [100 lb], up to 10 cats, and other small animals such as birds and rodents). This provides immunity to false alarms while maintaining proper catch performance of human targets.

Temperature Compensation

The sensor provides compensation at critical temperatures.

Supervised Microwave and PIR

Patented fully supervised microwave and PIR circuitry provides single technology coverage in the event the microwave subsystem fails.

Test Features

Externally visible, tricolor alarm LED indicates each technology independently and flashes to indicate a trouble condition.

Certifications and Approvals

Region	Certification	
Europe	CE	All DS825T and DS840T models: 89/336/EEC and 1999/5/EC, EN55022: 1998 +A1:2000 +A2:2003, EN50130-4: 1996 +A1: 1998 +A2: 2003, EN61000-4-2: 1995 +A1: 1998 +A2: 2001, EN61000-4-3: 2002 +A1: 2003, EN61000-4-4: 1995 +A1: 2000 +A2: 2001, EN61000-4-5: 1995 +A1: 2001, EN61000-4-6: 1996 +A1: 2001 +A2: 2001, EN61000-4-11:1994 +A1: 2001, EN60950-1: 2001 +A11: 2004, EN 300 440-2 V1.1.1 (2001-09), EN 301 489 Parts -1 and -3 V1.2.1 (2000-08)
Belgium	INCERT	DS825T and DS840T: B-509-0014/c
Poland	CNBOP	DS825T and DS840T: 104/03
USA	UL	DS825, DS825T, DS840, DS840T: ANSR: Intrusion Detection Units (UL639)
	FCC	DS825, DS825T, DS840, DS840T: ESVD5730 ESVD5730
China	CCC	DS825T-CHI and DS840T-CHI: 2004031901000037
Sweden	INTYG	DS825T only: Nr04-681
		DS840T only: Nr04-682
Brazil	ANATEL	DS825, DS825T, DS840, DS840T: 0843-03-1855
France	AFNOR	DS825T-B, DS840T-B: NF, A2P
Europe		DS825T-A and DS840T-A comply with EN50131-1 Grade 2

Installation/Configuration Notes

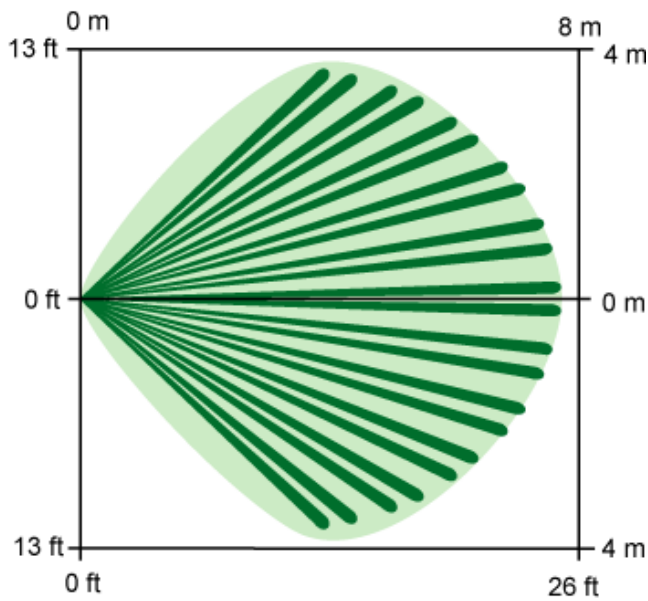

Top View
DS825 Broad Coverage 7.5 m x 7.5 m (25 ft x 25 ft)



Side View
DS825 Broad Coverage 7.5 m x 7.5 m (25 ft x 25 ft)

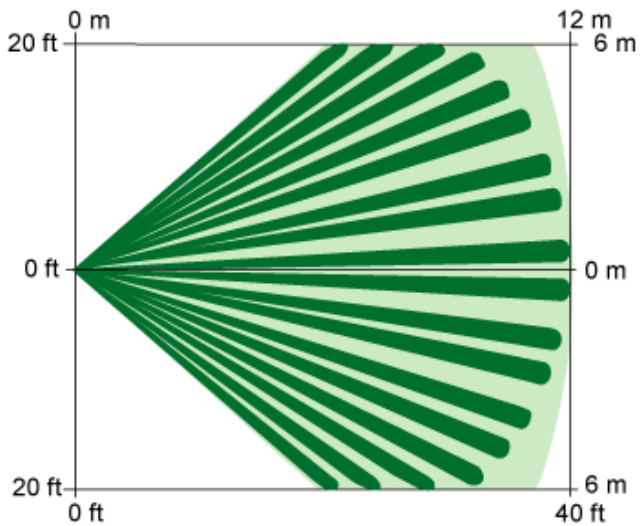

Top View
DS840 Broad Coverage 12 m x 12 m (40 ft x 40 ft)

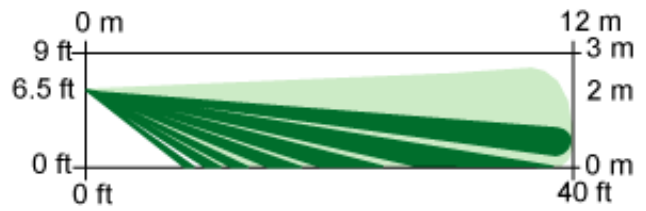

Side View
DS840 Broad Coverage 12 m x 12 m (40 ft x 40 ft)

Technical Specifications

Enclosure Design

Dimensions: 10.8 cm x 7 cm x 4.6 cm
 (4.25 in. X 2.75 in. X 1.8 in.)

Material: High impact ABS plastic enclosure

Environmental Considerations

Operating Temperature: -40°C to +49°C (-40°F to +120°F)
 For UL Listed installations, 0°C to +49°C (+32°F to +120°F)

Radio Frequency Interference (RFI) Immunity: No alarm or setup on critical frequencies in the range from 26 MHz to 950 MHz at 50 V/m.

DS825TA and DS840TA: Comply with Environmental Class II (EN50130-5)

Mounting

Location: Surface or corner mount

Height: 2 m (6.5 ft)

Outputs

Alarm: Normally-closed reed relay rated at 3.0 W, 125 mA at 28 VDC for resistive loads and protected by a 4.7 Ω resistor in the common C leg.

Tamper: Normally-closed tamper switch with contacts rated at 28 VDC, 125 mA maximum

Power Requirements

Current Draw: 16 mA at 12 VDC

Voltage: 6 VDC to 15 VDC

Ordering Information
DS825 Detector (10.525 GHz) DS825

Operates at 10.525 GHz. Provides 7.5 m x 7.5 m (25 ft x 25 ft) coverage, first step processing, movable mirrors, pet and animal immunity.

DS825T Detector (10.525 GHz) DS825T

Operates at 10.525 GHz. Includes a tamper switch. Provides 7.5 m x 7.5 m (25 ft x 25 ft) coverage, first step processing, movable mirrors, pet and animal immunity.

DS825TA Detector (10.687 GHz) DS825TA

Operates at 10.687 GHz. Includes a tamper switch. Provides 7.5 m x 7.5 m (25 ft x 25 ft) coverage, first step processing, movable mirrors, pet and animal immunity.

DS825TB Detector (9.9 GHz) DS825TB

Operates at 9.9 GHz. Includes a tamper switch. Provides 7.5 m x 7.5 m (25 ft x 25 ft) coverage, first step processing, movable mirrors, pet and animal immunity.

DS825TB-FRA Detector DS825TB-FRA

Operates at 9.9 GHz. Includes a tamper switch. For use in France. Provides 7.5 m x 7.5 m (25 ft x 25 ft) coverage, first step processing, movable mirrors, pet and animal immunity.

DS840 Detector (10.525 GHz) DS840

Operates at 10.525 GHz. Provides 12 m x 12 m (40 ft x 40 ft) coverage, first step processing, movable mirrors, pet and animal immunity.

DS840T Detector (10.525 GHz) DS840T

Operates at 10.525 GHz. Includes a tamper switch. Provides 12 m x 12 m (40 ft x 40 ft) coverage, first step processing, movable mirrors, pet and animal immunity.

DS840TA Detector (10.687 GHz) DS840TA

Operates at 10.687 GHz. Includes a tamper switch. Provides 12 m x 12 m (40 ft x 40 ft) coverage, first step processing, movable mirrors, pet and animal immunity.

DS840TB Detector (9.9 GHz) DS840TB

Operates at 9.9 GHz. Includes a tamper switch. Provides 12 m x 12 m (40 ft x 40 ft) coverage, first step processing, movable mirrors, pet and animal immunity.

DS840TB-FRA Detector (9.9 GHz) DS840TB-FRA

Operates at 9.9 GHz. Includes a tamper switch. For use in France. Provides 12 m x 12 m (40 ft x 40 ft) coverage, first step processing, movable mirrors, pet and animal immunity.

Accessories
Swiveling B335-3 low-profile mount B335-3

Swiveling, low-profile, plastic mount for wall mounting. The vertical swivel range is +10° to -20°, while the horizontal swivel range is ±25°. Available in triple packs.

DS860 Series TriTech PIR/ Microwave Detector



5

Features

- ▶ **Artificial Intelligence**
- ▶ **Five layers of detection including look-down zone**
- ▶ **Supervised microwave and PIR**
- ▶ **Selectable PIR sensitivity**
- ▶ **Draft/insect immunity**
- ▶ **Five mounting options**
- ▶ **Two coverage patterns**
- ▶ **Vertical and horizontal pointability**

The DS860 Series TriTech® Detectors with their passive infrared and microwave processing provide excellent catch performance with freedom from false alarms. These surface or corner mount detectors are available with three different microwave frequencies:

Model	Microwave Frequency
DS860	10.525 GHz
DS860-A	10.687 GHz
DS860-B	9.9 GHz

Functions

Signal Processing

Uses passive infrared and microwave technologies to provide an alarm condition when both fields of protection are simultaneously activated. Alarm signals must meet the signaling requirements of both technologies to activate an alarm.

Adjustable PIR and Microwave Sensitivity

- **PIR Signal Processing:** Motion Analyzer II uses multiple thresholds and timing windows to analyze timing, amplitude, duration and polarity of signals to make an alarm decision. Will not alarm on extreme levels of thermal and illumination disturbances caused by heaters and air conditioners, hot and cold drafts, sunlight, lightning, and moving headlights. Two sensitivity settings are provided.
- **Microwave Signal Processing:** Pattern recognition circuitry identifies and ignores repetitive false alarm sources. Adaptive processing adjusts to background disturbances. This helps to reduce false alarms while maintaining catch performance.

Test Features

Externally visible alarm LED flashes to indicate a trouble condition.

Supervised Microwave and PIR

Patented fully supervised microwave and PIR circuitry provides single technology coverage in the event the microwave subsystem fails. Use the memory circuit to force a self-test at anytime.

Draft and Insect Immunity

The sealed optical chamber provides immunity to drafts and insects.

Certifications and Approvals

Region	Certification	
Europe	CE	All models: 89/336/EEC, 1999/5/EC, EN55022:1998 +A1:2000 +A2:2003, EN50130-4:1996 +A1:1998 +A2:2003, EN61000-4-2: 1995 +A1:1998 +A2:2001, EN61000-4-3: 2002 +A1:2003, EN61000-4-4: 1995 +A1:2000 +A2:2001, EN61000-4-5: 1995 +A1:2001, EN61000-4-6: 1996 +A1:2001 +A2:2001, EN61000-4-11: 1994 +A1:2001, EN60950-1: 2001 +A11:2004, EN 300 400-2 V1.1.1 (2001-09), EN 301 489 Parts -1 and -3 V1.2.2 (2000-08) DS860 only: 1999/5/EC, ETS 300 400 April 1996, ETS 300 683 April 1997, EN60950 Dec. 1992
Belgium	INCERT	DS860 only: B-509-0014/c
Poland	CNBOP	DS860 only: PN-EN50130-5, PN-93/E-8390-22
USA	UL	DS860 only: ANSR: Intrusion Detection Units (UL639)
	FCC	DS860 only: ESVDS730 ESVDS730
Italy	IMQ	DS860-ITA only: U0627
Canada	ULC	DS860 only: ANSRC: Intrusion Detection Units
	IC	DS860 only: 12499102781
China	CCC	DS860-CHI only: 20040319001000037

Region	Certification	
Brazil	ANATEL	DS860 only: 0667-03-1855
Singapore	iDA	DS860 only: LPREQ-S0150-2004
Europe	DS860-A complies with EN50131-1 Grade 2	

Installation/Configuration Notes

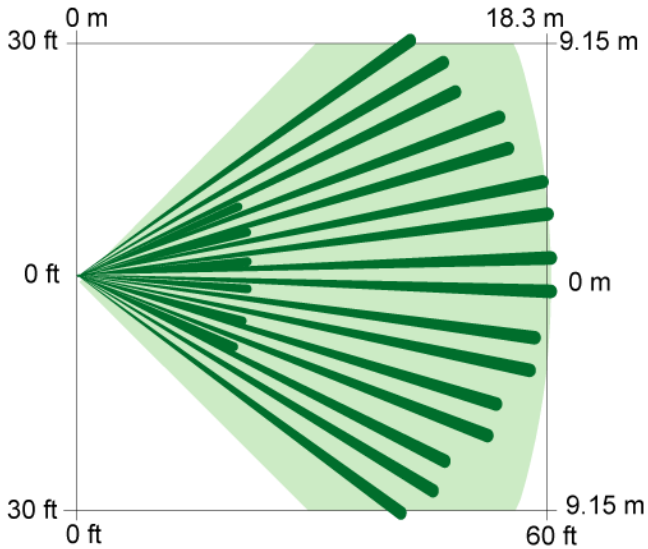

Top View
Standard Broad Coverage: 18.3 m x 18.3 m (60 ft x 60 ft)

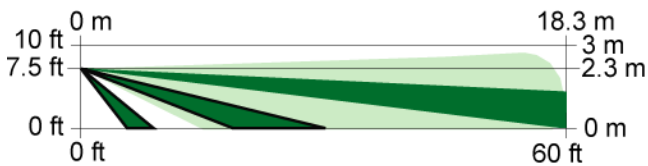

Side View
Standard Broad Coverage: 18.3 m x 18.3 m (60 ft x 60 ft)



Top View
Optional Long Range Coverage: 30.5 m x 3 m (100 ft x 10 ft)
Requires optional ORL92-3 lens.



Side View
Optional Long Range Coverage: 30.5 m x 3 m (100 ft x 10 ft)
Requires optional ORL92-3 lens.

Mounting

The recommended mounting height is 2.3 m (7.5 ft). Mounts to a standard single gang electrical box.

Technical Specifications

Enclosure Design

Dimensions: 12.7 cm x 7.1 cm x 5.6 cm (5 in. X 2.8 in. X 2.2 in.)

Material: High impact ABS plastic enclosure.

Environmental Considerations

Operating Temperature: -40°C to +49°C (-40°F to +120°F)
 For UL Certified installations, 0°C to +49°C (+32°F to +120°F)

Radio Frequency Interference (RFI) immunity: No alarm or setup on critical frequencies in the range from 26 MHz to 950 MHz at 50 V/m.

DS860-A: Complies with Environmental Class II (EN50130-5)

Mounting

Height Range: 1.8 m to 2.4 m (6 ft to 8 ft)

Location: Surface or corner mount

Outputs

Alarm: Normally-closed reed relay rated at 3.0W, 125 mA at 28VDC for resistive loads and protected by a 4.7 Ω resistor in the common C leg.

Tamper: Normally-closed tamper switch. Contacts rated at 28 VDC, 125 mA maximum.

Power Requirements

Current Draw: 16 mA at 12 VDC

Voltage: 9 VDC to 15 VDC

Trademarks

TriTech® is a registered trademark of Bosch Security Systems in the United States.

Ordering Information

DS860 Detector (10.525 GHz) Operates at 10.525 GHz. Provides five layers of detection, supervised microwave and PIR. selectable sensitivity, draft and insect immunity, five mounting options, and two coverage patterns.	DS860
DS860-A Detector (10.687 GHz) Operates at 10.687 GHz. Provides five layers of detection, supervised microwave and PIR. selectable sensitivity, draft and insect immunity, five mounting options, and two coverage patterns.	DS860-A
DS860B-FRA Detector (9.9 GHz) Operates at 9.9 GHz. For use in France. Provides five layers of detection, supervised microwave and PIR. selectable sensitivity, draft and insect immunity, five mounting options, and two coverage patterns.	DS860B-FRA
DS860B-ITA Detector (9.9 GHz) Operates at 9.9 GHz. For use in Italy. Provides five layers of detection, supervised microwave and PIR. selectable sensitivity, draft and insect immunity, five mounting options, and two coverage patterns.	DS860B-ITA

Ordering Information

Accessories**B328 Gimbal-mount Bracket****B328**

Mounts on a single-gang box and allows rotation of a detector. Wires are hidden inside.

Swiveling B335-3 low-profile mount**B335-3**

Swiveling, low-profile, plastic mount for wall mounting. The vertical swivel range is +10° to -20°, while the horizontal swivel range is ±25°. Available in triple packs.

B800 Ceiling-mount Bracket**B800**

Surface mounts detectors to the ceiling. The vertical pivot range is +7° to -16°; the horizontal pivot range is ±45°. Do not use for pet applications.

OLR92-3 Long-range Lens**OLR92-3**

Provides long-range coverage with a 30.5 m x 3 m (100 ft x 10 ft) pattern. Shipped in packages of three.

OD850 Series Outdoor TriTech Detectors



Features

- ▶ **Motion Analyzer II PIR signal processing**
- ▶ **Linear travel distance (LTD) microwave signal processing**
- ▶ **Two sensitivity levels**
- ▶ **Timed relay output adjustable from two sec to 10 min**
- ▶ **AND/OR mode**
- ▶ **Draft and insect immunity**

The OD850 Series TriTech detectors are for use outdoors and in other harsh environments. They use a combination of passive-infrared (PIR) and microwave detection with advanced signal processing.

The OD850 Series is intended for use in the following countries:

Model	Countries
OD850-F1	Belgium, Czech Republic, Denmark, Greece, Hungary, Italy, Netherlands, Norway, Poland, Romania, Spain, Sweden, Ukraine, the Americas and the Asia/Pacific Region
OD850-F2	France, UK

System Overview

The detectors process PIR signals with Motion Analyzer II signal processing and microwave signals with Linear Travel Distance (LTD) signal processing.

The detectors can distinguish between small, repetitive motions such as tree limbs moving in the wind and the more purposeful motions of intruders. These advanced processing techniques and the detectors' mechanical design combine to provide superior performance in a wide range of weather conditions.

Functions

Motion Analyzer II Processing

This PIR signal processor uses multiple thresholds and timing windows to analyze timing, amplitude, duration, and polarity of signals to make an alarm decision. Extreme levels of thermal and illumination disturbances caused by hot and cold drafts, sunlight, or lightning do not cause an alarm.

LTD Microwave Signal Processing

This microwave signal processor measures the linear travel distance of a target to make an alarm decision. It eliminates alarms for objects that move but do not travel, such as tree limbs and hanging signs.

Two Sensitivity Levels

The detectors have two user-selectable PIR sensitivity settings:

Standard sensitivity is the recommended setting for a minimum of false alarms. The detector tolerates environment extremes on this setting.

Intermediate sensitivity is the recommended setting for any location where an intruder is expected to cover only a small portion of the protected area. The detector tolerates normal environments on this setting. This setting identifies intruders more quickly, but may produce more false alarms.

Adjustable Timed Relay Output

In addition to an alarm relay, there is a Form C, unsupervised, timed relay contact that alternates state 1 sec after an alarm and follows a user-selectable timer. The time expires at the set time after the last alarm (it resets on each new alarm).

AND/OR Mode

This DIP-switch setting specifies whether the detector reports alarm situations in the AND mode (when both technologies simultaneously sense an alarm condition) or in the OR mode (when either the PIR or microwave technology senses an alarm state). OR mode provides faster detection in some conditions as the detector activates the alarm relay based on a single technology input.

LEDs

The high-efficiency LEDs (one red and one green) use the same technology as traffic lights to make them visible in sunlight. A DIP-switch setting allows the user to disable these LEDs during standard operation to save power.

Draft and Insect Immunity

The sealed optical chamber prevents drafts and insects from affecting the detector.

Certifications and Approvals

Region	Certification	
Europe	CE	89/336/EEC, EN55022: 1998 +A1:2000 +A2:2003, EN50130-4: 1996 +A1:1998 +A2:2003, EN61000-3-3: 1995 +A1:2001, EN61000-4-2: 1995 +A1:1998 +A2:2001, EN61000-4-3: 2002 +A1:2002, EN61000-4-4: 1995 +A1:2000 +A2:2001, EN61000-4-5: 1995 +A1:2001, EN61000-4-6: 1996 +A1:2001, EN61000-4-11" 1994 +A1:2001, EN300 440-1 V1.3.1: 2001-09, EN300 440-2 V1.1.1: 2001-09
Belgium	INCERT	B-509-0038
Poland	CNBOP	58/03
Russia	GOST	OD850-F1 only: DE.AE63.B03457
USA	UL	OD850-F1 only: ANSR: Intrusion Detection Units (UL639), ANSR7: Intrusion Detection Units Certified for Canada (ULC-S306)
	FCC	OD850-F1 only: ESVOD850-F1
China	CCC	OD850-F1-CHI only: 2004031901000039
Brazil	ANATEL	OD850-F1 only: 0873-03-1855
Singapore	iDA	OD850-F1 only: #LPREQ-S0155-2004
Australia	C-tick	
Europe	IEC	IP=54 per IEC 60529
		OD850-F2 only: Complies with EN50131-1 grade 2

Installation/Configuration Notes

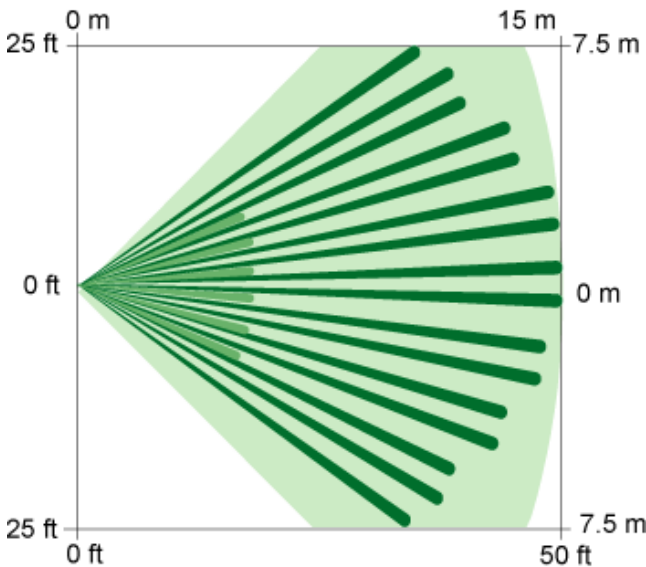

Top View
Standard Broad Coverage: 15 m x 15 m (50 ft x 50 ft)



Side View
Standard Broad Coverage: 15 m x 15 m (50 ft x 50 ft)

Mounting Considerations

- **Wall Mounting:** The OD850 detectors can be mounted directly on a wall or on the supplied B335 Swivel Mount Bracket. Alternatively, they can be mounted directly on a standard rectangular electrical box.
- **Ceiling Mounting:** The detectors can be mounted on a ceiling using the optional B338 Ceiling-Mount Bracket.

Power Considerations

- **Power Limits:** Input power must be provided by an Approved Limited Power Source. All outputs must be connected to SELV (safety extra-low voltage) circuits only.
- **Standby Power:** This detector has no internal standby battery. For UL Listed product installations, 4 hr (248 mAh) of standby power must be supplied by the control unit or by a UL Listed burglary power supply.

Technical Specifications

Enclosure Design

Dimensions: 16.5 cm x 8.25 cm x 6.35 cm (6.5 in. x 3.25 in. x 2.5 in.)

Material: Polycarbonate

Properties: Weather and vandal resistant

Weight: 1.4 oz (40 g)

Environmental Considerations

IP Rating: 54

Relative Humidity: 0% to 95% non-condensing

Temperature (Operating): -40°C to +54°C (-40°F to +130°F)

OD850-F2: Complies with Environmental Class III (EN50130-5)

Outputs

Alarm: Do not use with capacitive or inductive loads.

Form A: Normally-closed contact opens on alarm.

Form C: Timed relay contact alternates state on alarm and follows an installer programmable timer.

Contact Rating: 3 W, 125 mA maximum, 25 VDC maximum for DC resistive loads; and protected by a 4.7 Ω, ½ W resistor in the common C leg of the relay.

Tamper: Normally-closed (with cover on) contacts rated 125 mA maximum, 25 VDC maximum

Power Requirements

Current: 62 mA maximum

Input Power: 10 VDC to 15 VDC at 22 mA standby.

Ordering Information**OD850-F1 Outdoor TriTech Detector (10.525 GHz) OD850-F1**

For use in Belgium, Czech Republic, Denmark, Greece, Hungary, Italy, Netherlands, Norway, Poland, Romania, Spain, Sweden, Ukraine, the Americas and the Asia/Pacific Region. Operates at 10.525 GHz. For use outdoors or in harsh environments. Provides Motion Analyzer II PIR signal processing, two sensitivity levels, draft and insect immunity, and 15 m x 15 m (50 ft x 50 ft) coverage.

OD850-F2 Outdoor TriTech Detector (10.588 GHz) OD850-F2

For use in France and the United Kingdom. Operates at 10.588 GHz. For use outdoors or in harsh environments. Provides Motion Analyzer II PIR signal processing, two sensitivity levels, draft and insect immunity, and 15 m x 15 m (50 ft x 50 ft) coverage.

DS936 Low Profile Panoramic PIR Detector



5

Features

- ▶ Enhanced signal processing
- ▶ 360° x 7.5 m (24 ft) pattern
- ▶ Surface/semi-flush mountable
- ▶ Internal pointability
- ▶ Sealed detector chamber
- ▶ Mounting height 2 m to 3.6 m (7 ft to 12 ft)

The ceiling mount, low profile panoramic DS936 PIR Detector uses alternate polarity pulse count. It also uses a pointable Fresnel lens to provide up to 7.5 m (24 ft) of coverage and can be mounted on the surface, or semi-flush directly to a ceiling or a standard octagonal electrical box.

Functions

Enhanced Signal Processing

Field-selectable for standard, intermediate or high.

Test Features

External visible alarm LED. Internal noise voltage test pins provide precise pattern location and background disturbance evaluation using a standard analog meter.

Certifications and Approvals

Region	Certification	
Europe	CE	DS936: 89/336/EEC, EN55022: 1998 +A1: 2000 +A2: 2003, EN50130-4: 1996 +A1: 1998 +A2: 2003, EN61000-4-2: 1995 +A1: 1998 +A2: 2001, EN61000-4-3: 2002 +A1: 2003, EN61000-4-4: 1995 +A1: 2000 +A2: 2001, EN61000-4-5: 1995 +A1: 2001, EN61000-4-6: 1996 +A1: 2001 +A2: 2001, EN61000-4-11: 1994 +A1: 2001, EN60950-1: 2001 +A11: 2004
USA	UL	DS936: ANSR: Intrusion Detection Units (UL639)
China	CCC	DS936: 2002031901000002 DS936-CHI: 2004031901000036
Europe		DS936 complies with EN50131-1, Grade 2

Installation/Configuration Notes

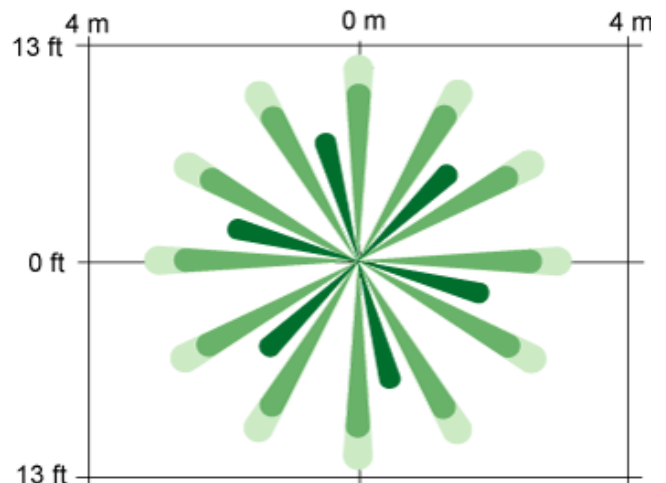

Top View

Broad Coverage: Up to 7.5 m x 360° (24 ft x 360°). Provides 360° coverage pattern. Coverage diameter is approximately two times the mounting height.

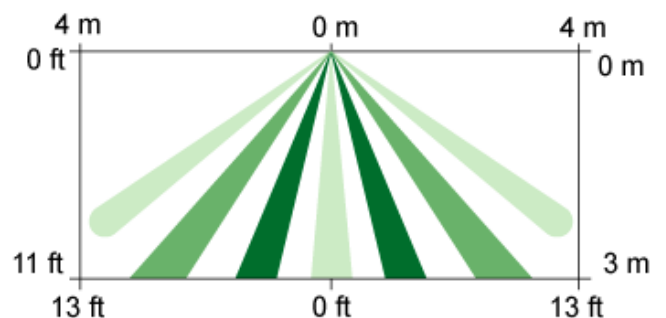

Side View

Broad Coverage: Up to 7.5 m x 360° (24 ft x 360°). Provides 360° coverage pattern. Coverage diameter is approximately two times the mounting height.

Technical Specifications

Enclosure Design

Material:	High impact ABS plastic enclosure
Dimensions:	3.05 cm x 11.7 cm (1.2 in. x 4.6 in.)

Environmental Considerations

Operating Temperature:	-29°C to +49°C (-20°F to +120°F) <i>For UL Certificated installations, 0°C to +49°C (+32°F to +120°F)</i>
Radio Frequency Interference (RFI) Immunity:	No alarm or setup on critical frequencies in the range from 26 MHz to 950 MHz at 50 V/m.
DS936:	Complies with Environmental Class II (EN50130-5)

Mounting

Height Range:	2 m to 3.6 m (7 ft to 12 ft)
Location:	Surface or semi-flush on ceiling or on standard 10 cm (4 in.) octagonal electrical box
Pattern Pointability:	±15° rotational

Outputs

Alarm:	Normally-closed reed relay rated at 3.0 W, 125 mA at 28 VDC for resistive loads and protected by a 4.7 Ω resistor in the common C leg.
Tamper:	Normally-closed cover activated tamper switch with separate terminals. Tamper contacts rated 125 mA at 28 VDC maximum.

Power Requirements

Current:	20 mA at 12 VDC
Voltage:	10 VDC to 15 VDC

Ordering Information

DS936 Low Profile Panoramic PIR Detector	DS936
Provides enhanced signal processing, 360° x 7.5 m (24 ft) pattern, mounts to surfaces, or mounts semi-flush into a ceiling.	

DS936-FRA Low Profile Panoramic PIR Detector	DS936-FRA
For use in France. Provides enhanced signal processing, 360° x 7.5 m (24 ft) pattern, mounts to surfaces, or mounts semi-flush into a ceiling.	

DS937 Panoramic Detector



5

Features

- ▶ Low profile design
- ▶ 360° up to 14 m (50 ft) coverage
- ▶ Easy installation
- ▶ First to alarm and alarm memory control
- ▶ AC or DC operating voltage

The ceiling mount DS937 PIR Detector provides panoramic coverage (360° x 14 m [50 ft]). Its low profile design provides a recessed-mount look, even when surface mounted. The wiring and programming options can be accessed without having to remove the detector from the ceiling. With a 14 m (50 ft) diameter coverage pattern, it is an ideal ceiling mounting choice for applications that require spot or 360° detection.

Functions

Alarm Display

Red LED (on/off selectable) lights on detection for 2.0 ±0.5 sec.

Alarm Memory

Memory Input allows LED to latch if detector alarms during alarm period. First-to-alarm signal allows indication of first detector to alarm when multiple units are used on the same loop.

Certifications and Approvals

Region	Certification	
Europe	CE	EN 50081-1: 1992 (EN 55022: 1998, Class B), EN 50130-4: 1995 +A1: 1998, IEC 61000-4-2: 1995, IEC 61000-4-3: 1995, IEC 61000-4-4: 1995, IEC 61000-4-5: 1995, ENV 50141: 1993
USA	UL	ANSR: Intrusion Detection Units (UL639)

Installation/Configuration Notes

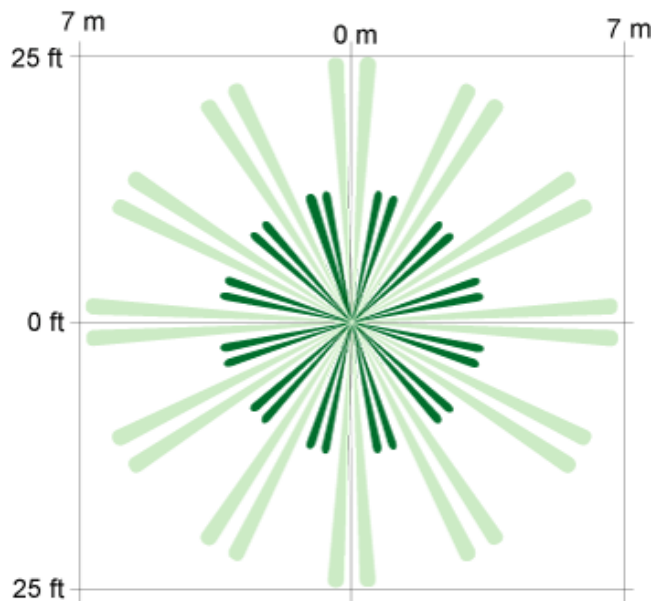

Top View

Standard coverage varies by mounting height. 360° x 14 m (50 ft) diameter when mounted at 3.7 m (12 ft).

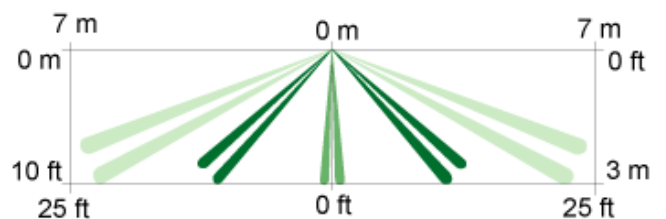

Side View

Standard coverage varies by mounting height. 360° x 14 m (50 ft) diameter when mounted at 3.7 m (12 ft).

Technical Specifications

Detection

Zones:	A total of 50 detection zones
Speed:	0.2 m/s ~ 5.0 m/s (0.5 ft/s ~ 15 ft/s)
Pulse Count Selectability:	1, 2, 3, or 4 pulses

Enclosure Design

Dimensions: 12.7 cm x 3.8 cm
(5 in. x 1.5 in.)

Weight: 176 g (6.2 oz)

Environmental Considerations

Humidity: 0 to 95% humidity non-condensing

Operating Temperature: -10°C to +49°C (+14°F to +120°F)
For UL Listed Applications, 0°C to +49°C (+32°F to +120°F)

Mounting

Height Range: 2.4 m to 3.7 m (8 ft to 12 ft) recommended

Outputs

Relay: Dry Contact (NC) rated at 30 VDC, 500 mA, 10 W maximum

Tamper Switch: Integral NC, cover-activated

Power Requirements

Current Draw: 17 mA maximum at 12 VDC

Voltage: 9 VDC to 30 VDC, 7.5 VAC to 24 VAC

Warm-Up Period: 35 ±3 seconds

Ordering Information**DS937 Panoramic Detector****DS937**

Provides low profile design and 360° x 14 m (50 ft) panoramic coverage.

DS938Z and ZX938Z Series Panoramic PIR Detectors



5

Features

- ▶ **Motion Analyzer II processing**
- ▶ **Motion Monitor**
- ▶ **Self-test supervision systems**
- ▶ **Changeable mirrors**
- ▶ **360° x 18 m (60 ft) diameter pattern**
- ▶ **2.5 m to 6 m (8 ft to 18 ft) mounting height**

These ceiling mount, 18 m (60 ft) panoramic PIR Detectors use Motion Analyzer II processing to reduce false alarms.

The series consists of the:

- DS938Z Panoramic Detector
- ZX938Z Panoramic Detector with POPIT

Several unique self-test features, including Motion Monitor, provide coverage integrity. Field replaceable mirrored optics allow them to be mounted on ceilings from 2.5 m to 6 m (8 ft to 18 ft) in height.

Functions

Motion Analyzer II Processing

Motion Analyzer II uses multiple thresholds and timing windows to analyze timing, amplitude, duration, and polarity of signals to make an alarm decision. It will not alarm on extreme levels of thermal and illumination disturbances caused by heaters and air conditioners, hot and cold drafts, sunlight, lightning, and moving headlights. Provides three sensitivity settings.

PIR Supervision

PIR supervision provides trouble output in the event that PIR circuitry fails.

Motion Monitor

Switch-selectable four or thirty day Motion Monitor supervision timers provide the detector with the ability to verify that there is a clear view of the protection area and that it has not been blocked.

Test Features

Three externally visible high output alarm LEDs visible from any angle, flash to indicate trouble condition. Internal noise voltage test pins provide precise pattern location and background disturbance evaluation using a standard analog meter.

Certifications and Approvals

Region	Certification	
Europe	CE	DS938Z, DS938Z-CHI, and DS938Z-FRA: 89/336/EEC, EN55022: 1998 +A1: 2000 +A2: 2003, EN50130-4: 1996 +A1: 1998 +A2: 2003, EN61000-4-2: 1995 +A1: 1998 +A2: 2001, EN61000-4-3: 2002 +A1: 2003, EN61000-4-4: 1995 +A1: 2000 +A2: 2001, EN61000-4-5: 1995 +A1: 2001, EN61000-4-6: 1996 +A1: 2001 +A2: 2001, EN61000-4-11: 1994 +A1: 2001, EN60950-1: 2001 +A11: 2004
Poland	CNBOP	DS938Z
USA	UL	DS938Z: ANSR: Intrusion Detection Units (UL639) ZX938Z: ANSR: Intrusion Detection Units (UL639)
China	CCC	DS938Z: 2002031901000002 DS938Z-CHI: 2004031901000036
Sweden	INTYG	DS938Z only: Nr04-683
Europe		DS938Z complies with EN50131-1, Grade 2
France	AFNOR	NF, A2P

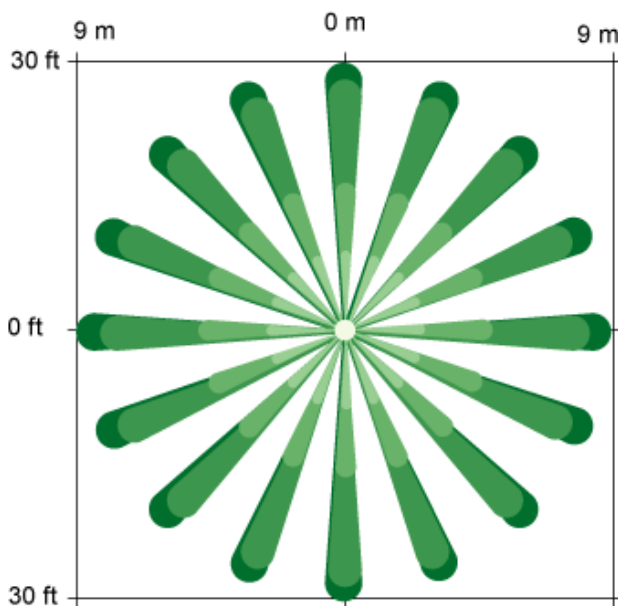
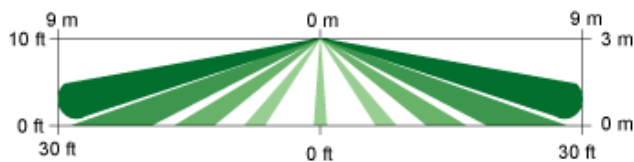
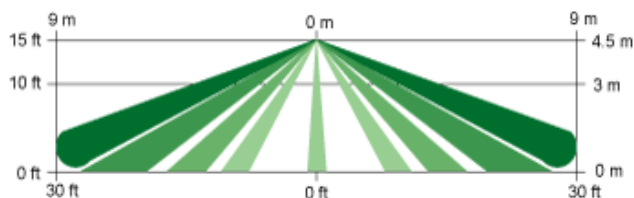
Installation/Configuration Notes**Top View****360° x 18 m (60 ft) diameter****AR8-13 Side View****360° x 18 m (60 ft) diameter****AR13-18 Side View****360° x 18 m (60 ft) diameter****Technical Specifications****Enclosure Design**

Material: High impact ABS plastic enclosure

Dimensions: 8.4 cm x 13.3 cm
(3.3 in. x 5.25 in.)**Environmental Considerations**Operating Temperature: -29°C to +49°C (-20°F to +120°F)
For UL Listed Applications,
0°C to +49°C (+32°F to +120°F)

Radio Frequency Interference (RFI) Immunity: No alarm or setup on critical frequencies in the range from 26 MHz to 950 MHz at 50 V/m.

DS938Z: Complies with Environmental Class II (EN50130-5)

Mounting

Height (recommended): 2.5 m to 6 m (8 ft to 18 ft)

Location: Mounts directly to ceiling or to standard octagonal electrical box.

Internal Pointability: Coverage is adjustable $\pm 10^\circ$ horizontally, $+2^\circ$ to -18° vertically.**Outputs (DS models)**

Alarm: Form C reed relay at 3.0 W, 125 mA at 28 VDC for resistive loads

Tamper: Normally-closed. Contacts rated at 28 VDC, 125 mA maximum.

Outputs (ZX model)

Alarm: Signal through POPEX data bus.

Tamper: Signal through POPEX data bus. Signaled as missing.

Trouble: Signal through POPEX data bus.

Power Requirements (DS models)

Current: 18 mA at 12 VDC

Voltage: 6 VDC to 15 VDC

Power Requirements (ZX model)

Current: < 0.5 mA nominal, 2 mA in alarm with LED enabled

Voltage: Power comes from two-wire POPEX bus.

Note: Do not leave Walk Test LEDs enabled.

Ordering Information**DS938Z Panoramic Detector****DS938Z**

Provides Motion Analyzer II processing, movable mirrors, and 360° x 18 m (60 ft) diameter coverage.

DS938Z-FRA Panoramic Detector**DS938Z-FRA**

For use in France. Provides Motion Analyzer II processing, movable mirrors, and 360° x 18 m (60 ft) diameter coverage.

DS939 Panoramic Detector



5

Features

- ▶ **Up to 7.6 m (25 ft) mounting height**
- ▶ **Fully adjustable optics for coverage integrity and customization**
- ▶ **Hinged chassis and base plate for easy installation**
- ▶ **High efficiency LED and light pipe system for easy walk testing**
- ▶ **First Step Processing (FSP)**
- ▶ **360° x 21 m (70 ft) diameter pattern**

The ceiling mount DS939 PIR Detector provides a 21 m (70 ft) panoramic coverage pattern and can be used on ceilings as high as 7.6 m (25 ft). With three separate PIR sections that are fully adjustable, the DS939 provides coverage integrity at all mounting heights, plus the ability to customize the coverage for specific areas. The DS939 uses several patented processing techniques to provide excellent catch performance with freedom from false alarms.

Functions

Signal Processing

Uses passive infrared technologies to provide an alarm condition when the field of protection is activated. Alarm signals must meet the signaling requirements to activate an alarm.

First Step Processing

First Step Processing (FSP) allows virtually instant response to human targets without sacrificing false alarm immunity to other sources. By adjusting its sensitivity based upon signal amplitude, polarity, slope and timing, FSP eliminates the need for the installer to select the sensitivity level for the application. Each sensor is processed individually and both must agree there is an alarm before the alarm relay is activated.

Test Features

- High efficiency LED and light-pipe system provide walk test indication that is easily viewable from any angle and at any mounting height.
- Alarm memory feature allows detector to latch the alarm LED to aid in response.
- Remote LED walk-test control allows the LED to be enabled or disabled using a switched input without accessing the detector.

Certifications and Approvals

Region	Certification	
Europe	CE	89/336/EEC, EN55022: 1998 +A1: 2000 +A2: 2003, EN50130-4: 1996 +A1: 1998 +A2: 2003, EN61000-4-2: 1995 +A1: 1998 +A2: 2001, EN61000-4-3: 2002 +A1: 2003, EN61000-4-4: 1995 +A1: 2000 +A2: 2001, EN61000-4-5: 1995 +A1: 2001, EN61000-4-6: 1996 +A1: 2001 +A2: 2001, EN61000-4-11: 1994 +A1: 2001, EN60950-1: 2001 +A11: 2004
Poland	CNBOP	
USA	UL	ANSR: Intrusion Detection Units (UL639), ANSR7: Intrusion Detection Units Certified for Canada (cULus)
Europe		Complies with EN50131-1, Grade 2

Installation/Configuration Notes

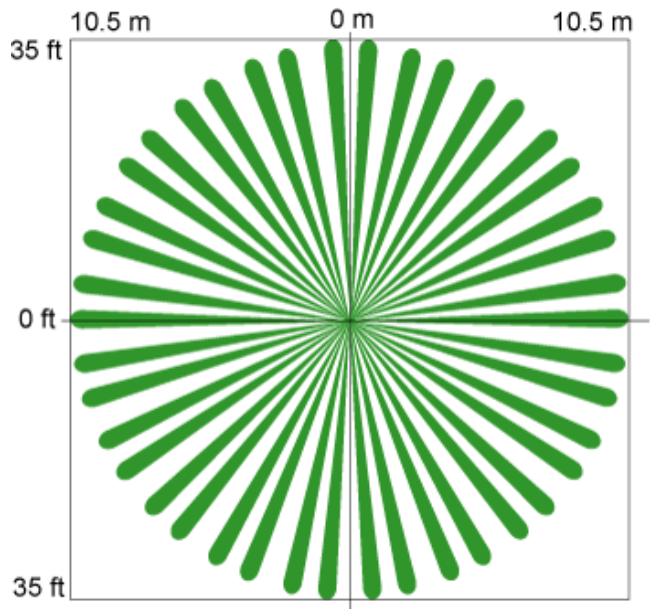

Top View

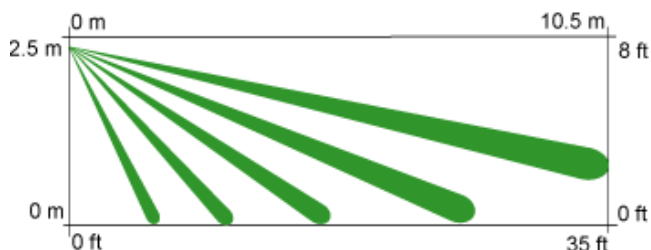

Side View

Coverage Information

Coverage is 360° x 21 m (70 ft) diameter when the detector is mounted 3.7 to 7.6 m (12 ft to 25 ft).

Coverage is 15 m (50 ft) diameter when the detector is mounted at 3 m (10 ft).

Coverage is 12 m (40 ft) when the detector is mounted at 2.4 m (8 ft).

Pattern consists of 69 zones in 21 barriers. Each barrier is 11 m (35 ft) long and 1.5 m (5 ft) wide at 11 m (35 ft). The barriers are grouped into three groups of seven barriers each. Each group has vertical adjustment for customized coverage.

Ordering Information

DS939 Panoramic Detector

DS939

Provides a 21 m (70 ft) panoramic coverage pattern and can be used on ceilings as high as 7.6 m (25 ft).

Technical Specifications

Enclosure Design

Properties: Modular chassis and hinged mounting base design provide easy access to field setup switches and wiring.

Dimensions: 8.9 cm x 17.8 cm
(3.5 in. x 7 in.)

Environmental Considerations

Operating Temperature: -40°C to +49°C (-40°F to +120°F)
For UL Certificated installations, 0°C to +49°C (+32°F to +120°F)

Sensitivity: Low/High gain settings

Complies with Environmental Class II (EN50130-5)

Mounting

Height Range: 3 m to 7.6 m (8 ft to 25 ft) recommended

Location: Mounts directly to ceiling or to standard 10.2 cm (4 in.) octagonal electrical box.

Internal Pointability: Coverage is adjustable $\pm 10^\circ$ horizontally, $+2^\circ$ to -18° vertically.

Outputs

Alarm Relay: Silent-operating form C relay. Contacts rated 125 mA, 28 VDC, 3 W maximum for DC resistive loads.

Tamper: Normally-closed (with cover in place) tamper switch. A wall (base) tamper is included. Contacts rated at 28 VDC, 125 mA, 3 W maximum.

Power Requirements

Current: 12 mA standby; 39 mA in alarm with LEDs enabled

Voltage: 9 VDC to 15 VDC

DS9360 Panoramic TriTech Detector



5

Features

- ▶ **Motion Analyzer II processing**
- ▶ **Microwave adaptive processing**
- ▶ **Self-test supervision systems**
- ▶ **Changeable mirrors (two mirrors provided)**
- ▶ **360° x 18 m (60 ft) diameter pattern**
- ▶ **2.5 m to 6 m (8 ft to 18 ft) mounting height**

The ceiling mount panoramic DS9360 TriTech® PIR/ Microwave Detector uses several patented processing techniques to provide excellent catch performance with freedom from false alarm. Supervised microwave and PIR sections ensure that the detector is working properly. Field replaceable mirrored optics allows it to be mounted on ceilings from 2.5 m to 6 m (8 ft to 18 ft) in height.

Functions

Signal Processing

Uses passive infrared and microwave technologies to provide an alarm condition when both fields of protection are simultaneously activated. Alarm signals must meet the signaling requirements of both technologies to activate an alarm. Adjustable PIR and microwave sensitivity.

PIR Signal Processing

Motion Analyzer II uses multiple thresholds and timing windows to analyze timing, amplitude, duration and polarity of signals to make an alarm decision. Will not alarm on extreme levels of thermal and illumination disturbances caused by heaters and air conditioners, hot and cold drafts, sunlight, lightning, and moving headlights. Two sensitivity settings are provided.

Microwave Signal Processing

Adaptive processing adjusts to background disturbances. This helps to reduce false alarms while maintaining catch performance.

Test Features

Two high output tri-color alarm LEDs visible from any angle, and flash to indicate a trouble condition.

Certifications and Approvals

Region	Certification	
Europe	CE	1999/5/EC, EN50130-4: 1995 +A1: 1998 +A2: 2003, EN61000-4-2: 1995 +A1: 1998 +A2: 2001, EN61000-4-3: 2002 +A1: 2002, EN61000-4-4: 1995 +A1: 2001 +A2: 2001, EN61000-4-5: 1995 +A1: 2001, EN61000-4-6: 1996 +A1: 2001, EN61000-4-11: 1994 +A1: 2001, ETS 300 440: April 1996, ETS 300 683: April 1997, EN60950: Dec 1992
Poland	CNBOP	
USA	UL FCC	ANSR: Intrusion Detection Units (UL639) ESV9360
Brazil	ANATEL	0868-03-1855
Singapore	iDA	LPREQ-S0153-2004
Europe		Complies with EN50131-1, Grade 2

Installation/Configuration Notes

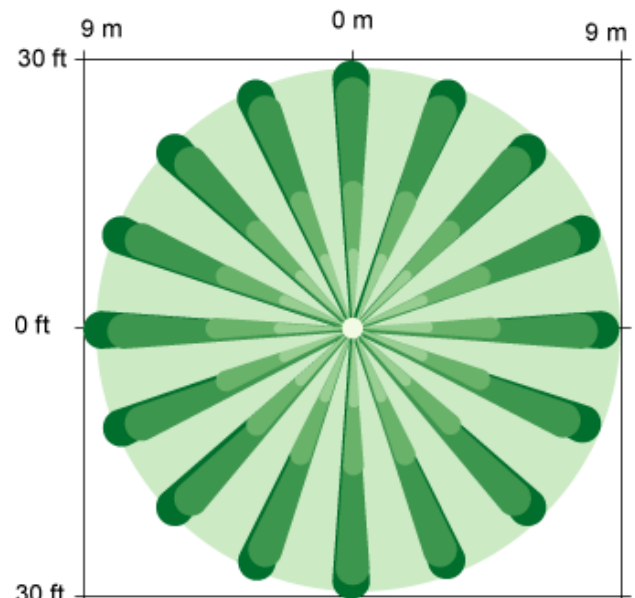

Top View

**One of each type of mirror is shipped with the product.
360° x 18 m (60 ft) diameter**

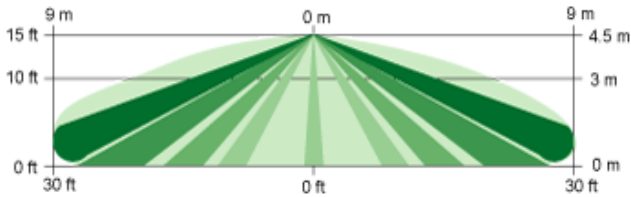
**AR13-18 Side View**

One of each type of mirror is shipped with the product.
360° x 18 m (60 ft) diameter

Technical Specifications
Enclosure Design

Design:	Modular high impact ABS electronic head and mounting/wiring base design with rugged polyethylene dome provides easy access to field setup switches.
Dimensions:	8.5 cm x 13.3 cm (3.5 in. x 5.25 in.)
Material:	High impact ABS plastic enclosure

Environmental Considerations

Operating Temperature:	-40°C to +49°C (-40°F to +120°F) For UL Certified installations, 0°C to +49°C (+32°F to +120°F)
------------------------	-------------------------------------------------------------------------------------------------------

Radio Frequency Interference (RFI) Immunity:	No alarm or setup on critical frequencies in the range from 26 MHz to 950 MHz at 50 V/m.
----------------------------------------------	------------------------------------------------------------------------------------------

Complies with Environmental Class II (EN50130-5)

Mounting

Height Range:	2.5 m to 6 m (8 ft to 18 ft) recommended
Location:	Mounts directly to ceiling or to standard 10.2 cm (4 in.) octagonal electrical box.

Outputs

Alarm:	Form C reed relay rated at 3.0 W, 125 mA at 28 VDC for resistive loads.
Tamper:	Normally-closed (with cover in place) tamper switch. Contacts rated at 28 VDC, 125 mA maximum.

Power Requirements

Current:	18 mA standby; 75 mA in alarm
Voltage:	6 VDC to 15 VDC

Trademarks

TriTech® is a registered trademark of Bosch Security Systems, Inc. in the United States.

Ordering Information

DS9360 Panoramic TriTech Detector	DS9360
Provides two movable mirrors, 360° x 18 m (60 ft) diameter coverage, and 2.5 m to 6 m (8 ft to 18 ft) mounting height.	

DS9370 Series Panoramic TriTech Detector



5

Features

- ▶ Up to 7.6 m (25 ft) mounting height
- ▶ Fully adjustable optics for coverage integrity and customization
- ▶ Hinged chassis and base plate for easy installation
- ▶ High efficiency LED and light pipe system for easy walk testing
- ▶ First Step processing (FSP)
- ▶ Microwave adaptive processing
- ▶ 360° x 21 m (70 ft) diameter pattern

Each DS9370 Series TriTech® PIR/Microwave Detector model is panoramic and uses several patented processing techniques to provide excellent catch performance with freedom from false alarms. Each model can be mounted on ceilings as high as 7.6 m (25 ft). With three separate PIR sections that are fully adjustable, the DS9370 Series provides coverage integrity at all mounting heights, plus the ability to customize the coverage for specific areas.

Functions

Signal Processing

Uses passive infrared and microwave technologies to provide an alarm condition when both fields of protection are simultaneously activated. Alarm signals must meet the signaling requirements of both technologies to activate an alarm.

First Step Processing

FSP allows virtually instant response to human targets without sacrificing false alarm immunity to other sources. By adjusting its sensitivity based upon signal amplitude, polarity, slope and timing, FSP eliminates the need for the installer to select the sensitivity level for the application. Each sensor is processed individually and both must agree there is an alarm before the alarm relay is activated.

Microwave Signal Processing

Adaptive processing adjusts to background disturbances. This helps to reduce false alarms while maintaining catch performance.

Microwave Supervision

Patented fully supervised microwave provides single technology coverage in the event the microwave subsystem fails.

Test Features

- High efficiency LED and light-pipe system provide walk test indication that is easily viewable from any angle and at any mounting height.
- Alarm memory feature allows detector to latch the alarm LED to aid in response.
- Remote LED walk-test control allows the LED to be enabled or disabled using a switched input without accessing the detector.

Certifications and Approvals

Region	Certification	
Europe	CE	DS9370 and DS9370-C: 89/336/EEC, EN55022: 1998 +A1: 2000 +A2: 2003, EN50130-4: 1996 +A1: 1998 +A2: 2003, EN61000-4-2: 1995 +A1: 1998 +A2: 2001, EN61000-4-3: 2002 +A1: 2003, EN61000-4-4: 1995 +A1: 2000 +A2: 2001, EN61000-4-5: 1995 +A1: 2001, EN61000-4-6: 1996 +A1: 2001 +A2: 2001, EN61000-4-11: 1994 +A1: 2001, EN60950-1: 2001 +A11: 2004, EN 300 440-2 V1.1.1: 2001-09, EN 300 489 Parts-1 and -3 V1.2.1: 2000-08
Belgium	INCERT	DS9370: B-509-0013 DS9370-BEL: B-509-0013/a
USA	UL	DS9370: ANSR: Intrusion Detection Units (UL639), ANSR7: Intrusion Detection Units Certified for Canada (cULus)
	FCC	ESV9370
Canada	IC	1249A-12073
Brazil	ANATEL	0871-03-1855
Singapore	iDA	LPREQ-S0154-2004
Australia		DS9370: AUS C-tick
China	CCC	2004031901000038
Europe		Complies with EN50131-1, Grade 2

Installation/Configuration Notes

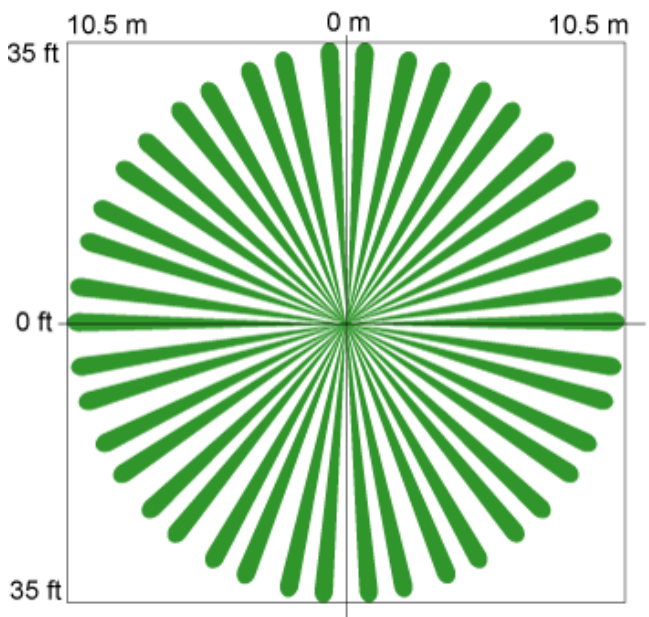

Top View

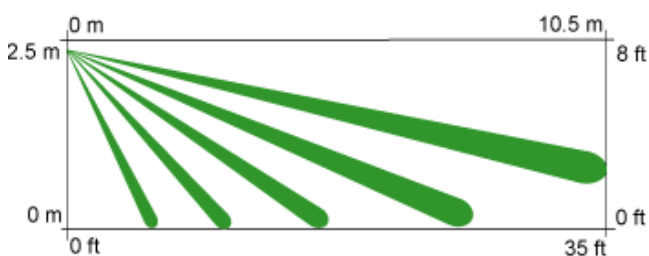

Side View

Coverage Information

Provides 360° x 21 m (70 ft) diameter coverage when the detector is mounted at 3.7 m to 7.6 m (12 ft to 25 ft).
 Provides 360° x 15 m (50 ft) diameter coverage when the detector is mounted at 3 m (10 ft). 12 m (40 ft) when mounted at 2.4 m (8 ft).
 Pattern consists of 69 zones in 21 barriers. Each barrier is 11 m (35 ft) long and 1.5 m (5 ft) wide at 11 m (35 ft). The barriers are grouped into three groups of seven barriers each. Each group has vertical adjustment for customized coverage.

Technical Specifications

Enclosure Design

Design:	Modular chassis and hinged mounting base design provide easy access to field setup switches and wiring.
Dimensions:	8.9 cm x 17.8 cm (3.5 in. X 7 in.)
Material:	High impact ABS plastic enclosure

Environmental Considerations

Operating Temperature:	-40°C to +49°C (-40°F to +120°F) For UL Certified installations, 0°C to +49°C (+32°F to +120°F)
Radio Frequency Interference (RFI) Immunity:	No alarm or setup on critical frequencies in the range from 26 MHz to 950 MHz at 50 V/m.
DS9370-C:	Complies with Environmental Class II (EN50130-5)

Microwave Frequency

DS9370 and DS9370-BEL	10.525 GHz
DS9370-C	10.588 GHz

Mounting

Height Range:	3 m to 7.6 m (8 ft to 25 ft) recommended
Location:	Mounts directly to ceiling or to standard 10.2 cm (3.5 in.) octagonal electrical box.

Outputs

Alarm	Form C reed relay rated at 3.0 W, 125 mA at 28 VDC for resistive loads.
Tamper	Cover and ceiling tamper. Normally Closed (with cover in place) tamper switch. Contacts rated at 28 VDC, 125 mA maximum.

Power Requirements

Current:	19 mA standby, 39 mA in alarm.
Voltage:	9 VDC to 15 VDC

Trademarks

TriTech® is a registered trademark of Bosch Security Systems, Inc. in the United States.

Ordering Information

DS9370 Ceiling Mount Panoramic Detector (10.525 GHz)	DS9370
Operates at 10.525 GHz. Provides first step processing, 360° x 21 m (70 ft) diameter coverage, and up to 7.6 m (25 ft) mounting height.	
DS9370-C Ceiling Mount Panoramic Detector (10.588 GHz)	DS9370-C
Operates at 10.588 GHz. Provides first step processing, 360° x 21 m (70 ft) diameter coverage, and up to 7.6 m (25 ft) mounting height.	
DS9370-BEL Ceiling Mount Panoramic Detector (10.525 GHz)	DS9370-BEL
Operates at 10.525 GHz. For use in Belgium. Provides first step processing, 360° x 21 m (70 ft) diameter coverage, and up to 7.6 m (25 ft) mounting height.	

DS9371 Panoramic TriTech Detector



5

Features

- ▶ Up to 7.6 m (25 ft) mounting height
- ▶ 360° x 20 m (70 ft) diameter pattern
- ▶ Fully-adjustable optical arrays for coverage customization
- ▶ Hinged chassis and base plate for easy installation
- ▶ High-efficiency LED and light-pipe system for easy walk testing
- ▶ First Step Processing (FSP)
- ▶ Microwave adaptive processing

The DS9371 TriTech® detector can be used on ceilings as high as 7.6 m (25 ft). The combination of passive-infrared (PIR) detection, microwave detection, and advanced signal processing techniques allows TriTech detectors to rapidly respond to human targets without triggering false alarms from other sources. With three separate fully-adjustable PIR sections, coverage can be customized for specific areas at all mounting heights.

Functions

Advanced Signal Processing

These detectors use PIR and microwave technologies to signal an alarm when the fields of protection of both technologies are activated at the same time. The PIR and microwave sensitivities are adjustable.

Adaptive Processing uses pattern recognition circuitry to identify and ignore repetitive false alarm sources. It adjusts to background disturbances to reduce false alarms without sacrificing the ability to respond to an intruder.

First Step Processing (FSP) allows virtually instant response to human targets without generating false alarms for other sources. FSP adjusts the detector's sensitivity based on signal amplitude, polarity, slope, and timing. This eliminates the need for the installer to select the sensitivity level. Each sensor (PIR and microwave) is processed individually, and the alarm relay does not activate unless both sensors agree there is an alarm.

Microwave Supervision

The microwave circuit is fully-supervised. If the microwave subsystem fails, the PIR subsystem provides single technology coverage.

Test Features

- The high-efficiency LED and light-pipe system provide Walk Test indication that is easily viewable from any angle and at any mounting height.
- The alarm memory feature allows the detector to latch the alarm LED to aid in response.
- The Walk Test LED can be activated remotely by a control panel command.

Certifications and Approvals

Region	Certification	
Europe	CE	89/336/EEC, EN55022: 1998 +A1: 2000 +A2: 2003, EN50130-4: 1996 +A1: 1998 +A2: 2003, EN61000-4-2: 1995 +A1: 1998 +A2: 2001, EN61000-4-3: 2002 +A1: 2003, EN61000-4-4: 1995 +A1: 2000 +A2: 2001, EN61000-4-5: 1995 +A1: 2001, EN61000-4-6: 1996 +A1: 2001 +A2: 2001, EN61000-4-11: 1994 +A1: 2001, EN60950-1: 2001 +A11: 2004, EN300440-2 V1.1.1: 2001-09, EN 300 489 Parts-1 and -3 V1.2.1: 2000-08
USA	UL	ANSR: Intrusion Detection Units (UL639), ANSR7: Intrusion Detection Units Certified for Canada (cULus)
	FCC	ESV9370
Brazil	ANATEL	0871-03-1855

Installation/Configuration Notes

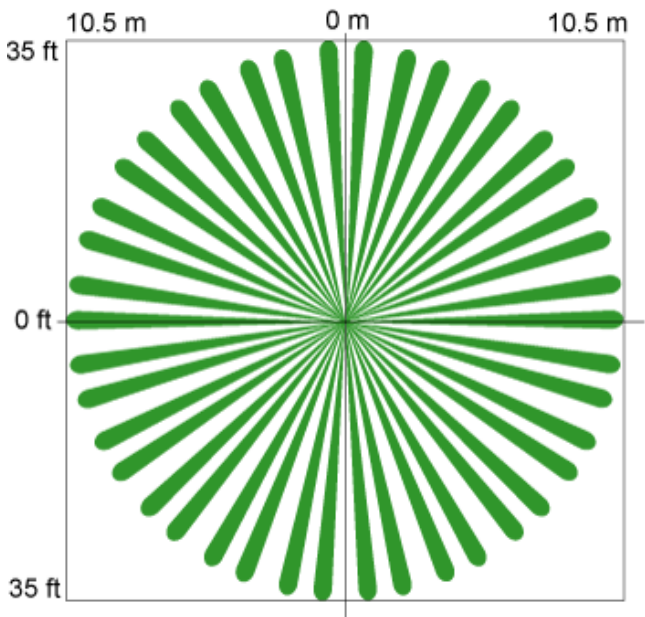

Top View

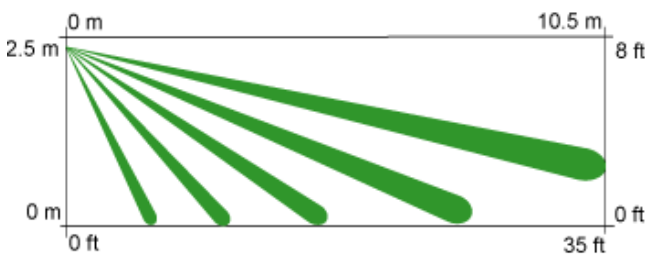

Side View

Coverage Information

The coverage pattern consists of 21 barriers grouped into three groups of seven barriers each. Each barrier is 10 m (35 ft) long and 1.5 m (5 ft) wide at 10 m (35 ft). Each group has vertical adjustments for customized coverage.

Mounting Considerations

The mounting height range is from 2.4 m to 7.6 m (8 ft to 25 ft). The recommended mounting height range is from 3.7 m to 7.6 m (12 ft to 25 ft). The coverage area can be set between 9.1 m and 21.3 m (30 ft and 70 ft). If mounted at 2.4 m (8 ft) high, the coverage area can be set between 6.1 m and 12.2 m (20 ft and 40 ft). If mounted at 3 m (10 ft) high, the coverage area can be set between 6.1 m and 15.2 m (20 ft and 50 ft).

These detectors can be mounted directly on the ceiling or on a standard 9 cm (3.5 in.) rectangular electrical box.

The maximum range of the detector depends on the mounting height and the vertical adjustment of the PIR coverage pattern. In areas where part of the area needs a targeted coverage, the optical modules can be adjusted for the correct coverage.

A masking kit containing two 120° and two 90° masks is included to allow masking unwanted areas. Apply the masks to the outside of the detector. With the supplied masks, you can mask 90°, 120°, 180°, 210°, 240°, or 330°.

Power Considerations

- **Power Limits:** Input power must be provided by an Approved Limited Power Source. All outputs must be connected to safety extra-low voltage (SELV) circuits only.
- **Standby Power:** This detector has no internal standby battery. For UL Listed product installations, four hours (116 mAh in standby; 156 mAh in alarm) of standby power must be supplied by the control unit or by a UL Listed burglary power supply.

Technical Specifications

Enclosure Design

Design:	Modular chassis and hinged mounting base design provide easy access to setup switches and wiring.
Dimensions:	8.9 cm x 17.8 cm (3.5 in. x 7 in.)
Material:	High impact ABS plastic enclosure

Environmental Considerations

Operating Temperature:	-40°C to +49°C (-40°F to +120°F) <i>For UL Certified installations, 0°C to +49°C (+32°F to +120°F)</i>
------------------------	-----------------------------------------------------------------------------------------------------------

Radio Frequency Interference (RFI) Immunity:	No alarm or setup on critical frequencies in the range from 26 MHz to 950 MHz at 50 V/m.
----------------------------------------------	------------------------------------------------------------------------------------------

Outputs

Alarm:	Form C reed relay rated at 3.0 W, 125 mA at 28 VDC for resistive loads.
Cover and Ceiling Tamper:	Normally-closed (with cover on) tamper switch with contacts rated at 28 VDC, 125 mA maximum.

Power Requirements

Current:	19 mA standby, 39 mA in alarm.
Voltage:	9 VDC to 15 VDC

Trademarks

TriTech® is a registered trademark of Bosch Security Systems, Inc. in the United States.

Ordering Information

DS9371 Panoramic TriTech Detector	DS9371
Provides black enclosure, up to 7.6 m (25 ft) mounting height, 360° x 20 m (70 ft) diameter pattern, and movable mirrors.	

MX938i Multiplex Intrusion Detector



5

Features

- ▶ **Interchangeable optical modules**
- ▶ **Selectable sensitivity**
- ▶ **Selectable signal gain**
- ▶ **Internal tamper switch**

The MX938i is a ceiling-mount PIR intrusion detector that provides a 360° coverage pattern consisting of 64 zones grouped into 16 barriers, with one additional zone looking straight down from the unit (sabotage). Through the use of interchangeable optical modules, the detector can be mounted on ceilings from 2.4 m (8 ft) to 5.5 m (18 ft) high. It is designed to connect to the multiplex bus of a control panel and optionally to an auxiliary 12 VDC power source. It is compatible with DS7400Xi Series Control Panels with a DS7430 or DS7436 Multiplex Expansion Module or with GV2 and G Series Control Panels with a D8125MUX Module installed.

Note The DS7400Xi Series Control Panels require ROM version 1.07 or greater.

Functions

Interchangeable, Pointable Mirrors

The detector comes with two optical modules:

- **AR8-13:** For ceilings between 2.4 m (8 ft) and 4.0 m (13 ft) high
- **AR13-18:** For ceilings between 4.0 m (13 ft) and 5.5 m (18 ft) high

Selectable Sensitivity

- **Standard:** Recommended setting for maximum false alarm immunity. Tolerates environment extremes on this setting. Not recommended for Long Range or Barrier type patterns. The detector is shipped in Standard Sensitivity mode.
- **Intermediate:** Recommended setting for any location where an intruder is expected to cover only a small portion of the protected area. Tolerates normal environments on this setting. This setting will improve your intruder catch performance.
- **High:** Fast response to intruder signals. For use in quiet environments where thermal and illumination transients are not anticipated.

Signal Gain

The MX938i permits selection of the signal gain depending upon the environment to be protected. The gain select jumper is located under the optical module.

- **High Gain:** Recommended for large coverage applications up to 18.3 m (60 ft) in diameter. The MX938i is shipped in this setting. If the gain jumper is missing, it will default to high gain.
- **Low Gain:** Recommended for applications where the area to be covered is 12.2 m (40 ft) or less in diameter and for applications where the HIGH signal gain setting may be too sensitive for environmental extremes.

Note Setting the MX938i for the LOW signal gain setting reduces the coverage area to 12.2 m (40 ft) in diameter.

Internal Tamper Switch

The internal tamper switch sends a signal to the panel's multiplex bus for display at the keypads when the detector's cover is removed.

Certifications and Approvals

Region	Certification
USA	UL ANSR: Intrusion Detection Units (UL639)
China	CCC MX938i: 2002031901000002
Europe	CE

Installation/Configuration Notes

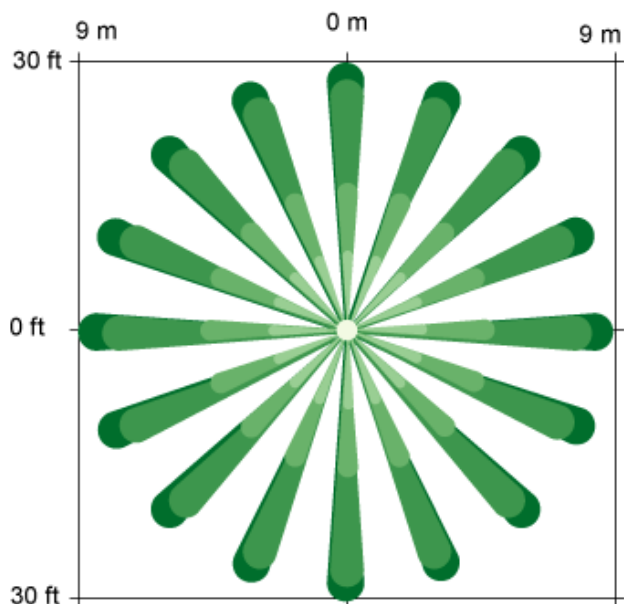

Top View
360° x 18.3 m (60 ft) Diameter

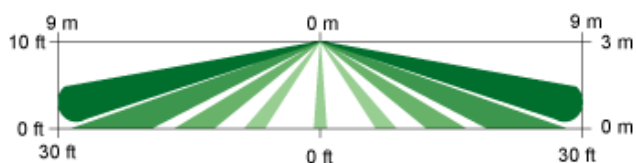

AR8-13 Side View
 The following side views show a cross section of two opposite zones.

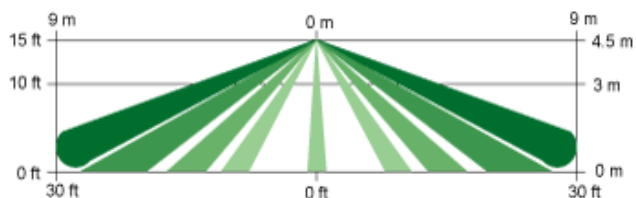

AR13-18 Side View
 The following side views show a cross section of two opposite zones.

Coverage Information

The recommended mounting height range is 2.4 m (8 ft) to 5.5 m (18 ft). The pattern consists of 64 zones grouped into 16 barriers, with one additional zone looking straight down from the unit (sabotage). Each barrier is 9.2 m (30 ft) long and 1.3 m (4.4 ft) wide at 9.2 m (30 ft).

There is a choice of two optical modules depending on ceiling height. These choices provide 360° by 18.3 m (60 ft) diameter coverage when mounted on 2.4 m (8 ft) to 5.5 m (18 ft) high ceilings.

Wiring Considerations

Do not use shielded cable. Use wire that is no smaller than 0.8 mm (22 AWG) to connect the detector to the control panel.

Technical Specifications

Environmental Considerations

Temperature (Operating): -29°C to +49°C (-20°F to +120°F). For UL Listed Requirements, the temperature range is 0°C to +49°C (+32°F to +120°F).

Power Requirements

Standby Power: There is no internal standby battery. Connect to DC power sources capable of supplying standby power if primary power fails. For each hour of standby time needed, 350 µAh are required. For UL Listed Requirements, four hours (1400 µAh) minimum is required.

Voltage (Input): 12 VDC from panel's MUX bus and optionally from an auxiliary power supply.

Current Draw (two-wire):

LED Off: < 350 µA draw on MUX bus

In Alarm; LED On: 2 mA draw on MUX bus

Current Draw (four-wire):

LED Off: < 350 µA draw on MUX bus, 0 mA draw on Aux. power

In Alarm; LED On: < 350 µA draw on MUX bus, 3 mA draw on Aux. power

Ordering Information

MX938i Multiplex Intrusion Detector **MX938i**
 Provides a 360° coverage pattern consisting of 64 zones grouped into 16 barriers.

DS720i Long Range TriTech PIR Detector (10.525 GHz)



5

Features

- ▶ Supervised microwave and PIR
- ▶ Anti-masking with spray detect
- ▶ Motion monitor
- ▶ Motion Analyzer II
- ▶ Field-changeable mirrored optics

The wall or ceiling mount DS720i TriTech[®] PIR and Microwave Detector covers up to 91 m (300 ft). Motion Monitor and Anti-masking protection provides coverage integrity. Field replaceable mirrored optics and three different coverage patterns provide installation flexibility.

Functions

Alarm Memory

- Indicates stored alarms for use in multiple unit applications by latching the alarm LED.
- Controlled by a switched voltage from the control panel.

Signal Processing

Uses passive infrared and microwave technologies to provide an alarm condition when both fields of protection are simultaneously activated. Alarm signals must meet the signaling requirements of both technologies to activate an alarm. Adjustable PIR and microwave sensitivity.

PIR Signal Processing

Uses Motion Analyzer II multiple thresholds and timing windows to analyze timing, amplitude, duration, and polarity of signals to make an alarm decision. Will not alarm on extreme levels of thermal and illumination disturbances caused by heaters and air conditioners, hot and cold drafts, sunlight, lightning, and moving headlights. Two sensitivity settings are provided.

Microwave Signal

Uses pattern recognition circuitry to identify and ignore repetitive false alarm sources. Adaptive processing adjusts to background disturbances to reduce false alarms while maintaining catch performance.

Test Features

High-efficiency walk test LED is visible throughout the coverage pattern (reducing installation time). LED flashes to indicate a trouble condition. Internal noise voltage test pins use standard analog meter to provide precise pattern location and background disturbance evaluation. Separate test LEDs for PIR and microwave activation. Alarm LED can be controlled remotely.

Supervised Microwave and PIR

Patented fully supervised microwave and PIR circuitry provides single technology coverage in the event the microwave subsystem fails. Use the memory circuit to force a self-test at anytime.

Anti-masking With Spray Detect

Selectable to provide a microwave supervision trouble signal if microwave reflective material (metal, wood, plastics) is placed within 30.5 cm (1 ft) of the detector. IR Anti-masking feature detects objects placed to cover the detector or sprayed on the lens area. Anti-mask sensitivity is selectable, and Anti-mask activation can be delayed to reduce false alarms.

Motion Monitor

Switch-selectable four or thirty day Motion Monitor supervision timers provide the detector with the ability to verify that there is a clear view of the protection area and that it has not been blocked.

Certifications and Approvals

Region	Certification	
Poland	CNBOP	
USA	UL	ANSR: Intrusion Detection Units (UL639)
	FCC	ESVDS720I
China	CCC	2004031901000037
Brazil	ANATEL	0844-03-1855
Singapore	iDA	LPREQ-S0156-2004

Installation/Configuration Notes

Standard Broad Coverage

27 m x 21 m (90 ft x 70 ft); the standard broad coverage mirror (OA90) is included.

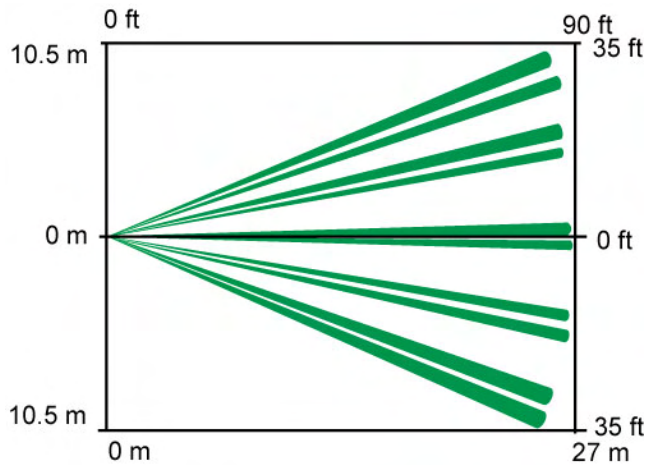

Top View

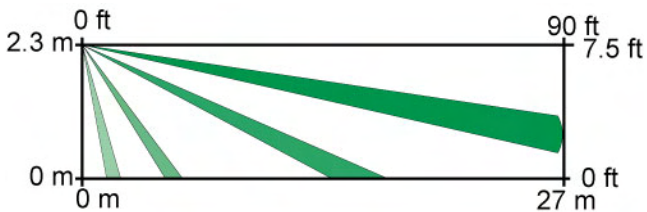

Side View

Standard Long Range Coverage

91 m x 4.6 m (300 ft x 15 ft); the long range coverage mirror (OA300) is installed.

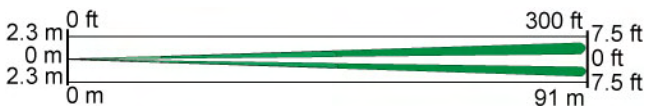

Top View



Side View

Optional Long Range Coverage

37 m x 7.6 m (120 ft x 25 ft); the long range coverage mirror (OA120) is installed.

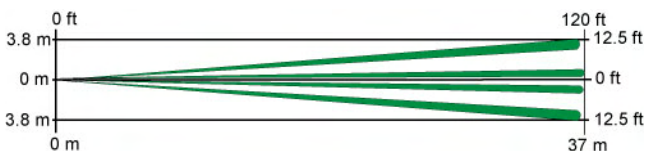

Top View



Side View

Parts Included

Quantity	Component
1	B334 Swivel Mount Bracket
1	Standard Broad Coverage Mirror, labeled OA90
1	Long Range Coverage Mirror, labeled OA300

Note The Long Range Coverage Mirror is installed.

Technical Specifications

Enclosure Design

Dimensions: 20.8 cm x 19.5 cm x 13 cm (8 in. x 7.5 in. x 5 in.)

Material: High impact ABS plastic enclosure

Properties: With steel grid over optics area houses a removable circuit board and minor holder assembly.

Environmental Considerations

Operating Temperature: -29°C to +49°C (-20°F to +120°F)
 For UL Certified installations, 0°C to +49°C (+32°F to +120°F)

Radio Frequency Interference (RFI) Immunity: No alarm or setup on frequencies in the range from 26 MHz to 950 MHz at 50 V/m.

Mounting

Height: 4.6 m (15 ft) maximum

Location: Mounts directly to ceiling or to standard 10.2 cm (4 in.) octagonal electrical box.

Outputs

Alarm: Form C reed relay rated at 3.0 W, 125 mA at 28 VDC for resistive loads and protected by a 4.7 Ω, 0.5 W resistor in the common C leg.

Tamper: Normally-closed tamper switch. Contacts rated at 28 VDC, 125 mA maximum.

Trouble: Normally-closed dry contacts rated at 28 VDC, 125 mA maximum. Open during trouble.

Power Requirements

Current Draw: 32 mA nominal at 12 VDC; up to 60 mA during walk test, stored alarm, or trouble conditions.

Voltage: 9 VDC to 15 VDC

Trademarks

TriTech® is a registered trademark of Bosch Security Systems, Inc. in the United States.

Ordering Information**DS720i Long Range TriTech PIR Detector (10.525 GHz) DS720i**

Operates at 10.525 GHz. Provides 27 m x 21 m (90 ft x 70 ft) standard broad coverage and 91 m x 4.6 m (300 ft x 15 ft) long range coverage. Provides anti-masking with spray detect, motion monitor, and Motion Analyzer II signal processing.

Accessories**OA120-2 Mirror OA120-2**

A 36.5 m (120 ft) optical array module. Shipped in packages of two.

DS778 Long Range PIR Detector



Features

- ▶ Motion Analyzer II processing
- ▶ Pointable mirrored optics
- ▶ Q-map signal processing
- ▶ Long range coverage
- ▶ Four mounting options

The wall mount, long range DS778 PIR Detector uses Motion Analyzer II signal processing to reduce false alarms. To aid in walk testing, the DS778 features a high efficiency alarm LED that is visible throughout the coverage pattern. This allows one installer to install and test the detector. The detector's internally pointable optics and mounting options provide installation flexibility.

Functions

Signal Processing

Motion Analyzer II uses multiple thresholds and timing windows to analyze timing, amplitude, duration, and polarity of signals to make an alarm decision. Will not alarm on extreme levels of thermal and illumination disturbances caused by heaters and air conditioners, hot and cold drafts, sunlight, lightning, and moving headlights. Two sensitivity settings are provided.

Test Features

The high efficiency alarm LED can be seen throughout the walk test area. Internal noise voltage test pins provide precise pattern location and background disturbance evaluation using a standard analog meter.

Insect and Draft Immunity

The sealed optical chamber provides immunity to drafts and insects.

Certifications and Approvals

Region	Certification	
Europe	CE	89/336/EEC, EN55022:1998 +A1:2000 +A2:2003, EN50130-4:1996 +A1:1998 +A2:2003, EN61000-4-2:1995 +A1:1998 +A2:2001, EN61000-4-3:2002 +A1:2003, EN61000-4-4:1995 +A1:2000 +A2:2001, EN61000-4-5:1995 +A1:2001, EN61000-4-6:1996 +A1:2001 +A2:2001, EN61000-4-11:1994 +A1:2001, EN60950-1:2001
Poland	CNBOP	
USA	UL	ANSR: Intrusion Detection Units (UL639)
Europe		Complies with EN50131-1, Grade 2

Installation/Configuration Notes



Top View

Long Range Coverage 60 m x 4.5 m (200 ft x 15 ft)



Side View

Long Range Coverage 60 m x 4.5 m (200 ft x 15 ft)

Technical Specifications

Enclosure Design

Dimensions: 14.6 cm x 9.5 cm x 6.35 cm (5.75 in. x 3.75 in. x 2.5 in.)

Material: High impact ABS plastic enclosure

Environmental Considerations

Operating Temperature: -40°C to +49°C (-40°F to +120°F)
 For UL Listed Applications, 0°C to +49°C (+32°F to +120°F)

Radio Frequency Interference (RFI) Immunity: No alarm or setup on critical frequencies in the range from 26 MHz to 950 MHz at 50 V/m.

Complies with Environmental Class II (EN50130-5)

Mounting

Height Range: Recommended 2 m to 2.6 m (6.5 ft to 8.5 ft)

Internal Pointability: Coverage is adjustable ±10° horizontally, +2° to -18° vertically.

Outputs

Alarm: Form C contacts rated at 3.0W, 125 mA at 28VDC for resistive loads.

Tamper: Normally-closed. Contacts rated at 28 VDC, 125 mA maximum.

Power Requirements

Current Draw: 18 mA at 12 VDC

Voltage: 6 VDC to 15 VDC

Ordering Information**DS778 Long Range PIR Detector****DS778**

Provides Motion Analyzer II processing, movable mirrors, Q-map signal processing, long range coverage, and four mounting options.

Accessories**B328 Gimbal-mount Bracket****B328**

Mounts on a single-gang box and allows rotation of a detector. Wires are hidden inside.

Swiveling B335-3 low-profile mount**B335-3**

Swiveling, low-profile, plastic mount for wall mounting. The vertical swivel range is +10° to -20°, while the horizontal swivel range is ±25°. Available in triple packs.

DS794Z and ZX794Z Series Long Range PIR Detectors



Features

- ▶ Motion Analyzer II processing
- ▶ Motion Monitor
- ▶ PIR supervision
- ▶ Self test supervision systems
- ▶ Field-replaceable optics
- ▶ Three coverage patterns

The surface or corner mount, long-range DS794Z and ZX794Z Series PIR Detectors use Motion Analyzer II signal processing to reduce false alarms. Several unique test features, including Motion Monitor, provide coverage integrity. Field replaceable mirrored optics and three different coverage patterns provide installation flexibility.

Functions

Signal Processing

Motion Analyzer II uses multiple thresholds and timing windows to analyze timing, amplitude, duration, and polarity of signals to make an alarm decision. It will not alarm on extreme levels of thermal and illumination disturbances caused by heaters and air conditioners, hot and cold drafts, sunlight, lightning, and moving headlights. Three sensitivity settings are provided.

Test Features

External visible alarm LED flashes to indicate trouble condition. Internal Noise Voltage Test Pins provide precise pattern location and background disturbance evaluation using a standard analog meter. Internal sounder output for use with Sonalert® sounder (not supplied).

Motion Monitor

Switch-selectable four and thirty day timers verify that there is a clear view of the protection area.

PIR Supervision

Provides trouble output in the event that PIR circuitry fails.

Certifications and Approvals

Region	Certification	
Europe	CE	DS models only: 89/336/EEC, EN55022: 1998 +A1: 2000 +A2: 2003, EN50130-4: 1996 +A1: 1998 +A2: 2003, EN61000-4-2: 1995 +A1: 1998 +A2: 2001, EN61000-4-3: 2002 +A1: 2003, EN61000-4-4: 1995 +A1: 2000 +A2: 2001, EN61000-4-5: 1995 +A1: 2001, EN61000-4-6: 1996 +A1: 2001 +A2: 2001, EN61000-4-11: 1994 +A1: 2001, EN60950-1: 2001 +A11: 2004
Poland	CNBOP	DS794Z: 77/03
USA	UL	DS794Z: ANSR: Intrusion Detection Units (UL639) ZX794Z: ANSR: Intrusion Detection Units (UL639)
China	CCC	DS794ZE: 2007031901000035
Europe		DS794ZE complies with EN50131-1, Grade 2

Installation/Configuration Notes

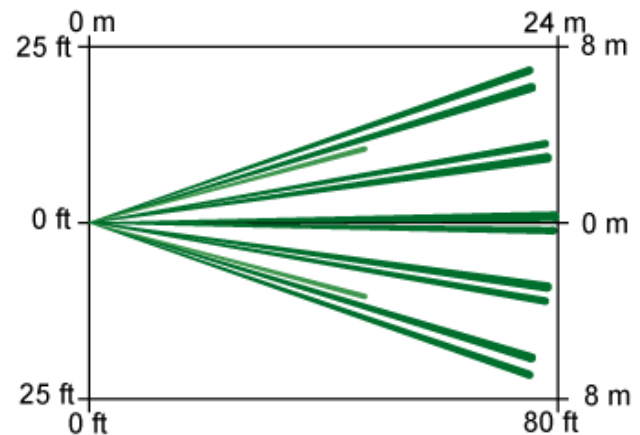

Top View

Standard Broad Coverage: 24 m x 16 m (80 ft x 50 ft)



Side View

Standard Broad Coverage: 24 m x 16 m (80 ft x 50 ft)



Top View
Standard Long Range: 61 m x 3 m (200 ft x 10 ft)



Side View
Standard Long Range: 61 m x 3 m (200 ft x 10 ft)

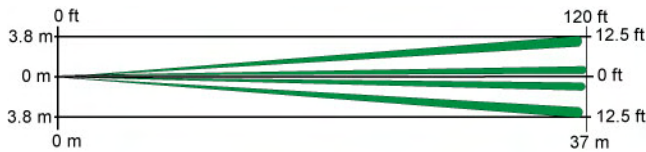

Top View
Optional Long Range 37 m x 8 m (120 ft x 26 ft)



Side View
Optional Long Range 37 m x 8 m (120 ft x 26 ft)

Standby Power

If there is no internal standby battery, connect to DC power source capable of supplying standby power if the primary power fails.

Model	Standby Power	mAh required per hour
DS794Z	No standby battery	18 mAh
DS794ZE	No standby battery	25 mAh
DS794ZE-FRA	No standby battery	18 mAh
ZX794Z	Provided by the Zonex bus	0.5 mAh

Note A minimum of four hours of standby power is required for UL Listed requirements.

Parts Included

For your convenience, the OA200 Mirror and OA80 Mirror are included with the detector.

Technical Specifications

Enclosure

Dimensions: 14 cm x 21 cm x 14 cm
 (5 in. x 7.5 in. x 5 in.)

Material: High impact ABS plastic enclosure

Environmental Considerations

Operating Temperature: -29°C to +49°C (-20°F to +120°F)
 For UL Certificated installations, 0°C to +49°C (+32°F to +120°F)

Radio Frequency Interference (RFI) Immunity: No alarm or setup on critical frequencies in the range from 26 MHz to 950 MHz at 50 V/m.

DS794ZE: Complies with Environmental Class II (EN50130-5)

Mounting

Height: 5 m (15 ft.) maximum

Location: Surface or corner

Power Requirements

Current Draw: 18 mA at 12 VDC
 25 mA at 12 VDC (DS794ZE)

Voltage (Input): 6 VDC to 15 VDC
 ZX794Z: Power comes from two-wire Zonex Bus.
 <0.5 mA nominal, 2 mA in alarm with LEDs enabled.
 Do not leave Walk Test LEDs enabled.

Outputs

Alarm: ZX794Z: Signal through POPIT data bus.
 DS794ZE-FRA: Form C Contacts rated at 3.0 W, 125 mA at 28 VDC for resistive loads protected by a 4.7 Ω resistor in the common C leg.

Tamper: Normally-closed (with cover in place). Contacts rated at 28 VDC, 125 mA maximum.

ZX794Z: Signal through POPIT data bus. Signaled as Missing.

Trouble: Solid state output, shorts to negative when activated. Maximum current load is 25 mA.

ZX794Z: Signal through POPIT data bus.

Trademarks

Sonalert® is a registered trademark of Mallory Sonalert® Products, Inc.

Ordering Information

DS794Z Long-Range PIR Intrusion Detector DS794Z
 Provides Motion Analyzer II processing, Motion Monitor, and three coverage patterns, and 61 m x 3 m (200 ft x 10 ft) long range coverage.

DS794ZE-FRA Long-Range PIR Intrusion Detector DS794ZE-FRA
 For use in France. Provides Motion Analyzer II processing, Motion Monitor, and three coverage patterns, and 61 m x 3 m (200 ft x 10 ft) long range coverage.

Accessories

OA120-2 Mirror OA120-2
 A 36.5 m (120 ft) optical array module. Shipped in packages of two.

MX794i Long Range Multiplex PIR Detector



- **Intermediate:** The recommended setting for OA200 coverage or for locations where an intruder is expected to cover only a small portion of the protected area. Tolerates normal environments on this setting.
- **High:** The setting for fast response to intruder signals. For use in quiet environments where thermal and illumination transients are not anticipated.

Internal Tamper Switch

The internal tamper switch sends a signal to the panel's Multiplex Bus for display at the keypads when the detector's cover is removed.

Features

- ▶ Interchangeable mirror modules
- ▶ Mounting bracket supplied
- ▶ Selectable sensitivity
- ▶ Built-in tamper switch

The MX794i is a PIR intrusion detector that provides a variety of coverage patterns through the use of interchangeable mirror modules. It is designed to connect to the Multiplex Bus of a control panel and optionally to an auxiliary 12 VDC power source. It is compatible with DS7400, DS7400X, or DS7400Xi Series Control Panels, with a DS7430 or DS7436 Multiplex Expansion Module, or with GV2 and G Series Control Panels with a D8125MUX Module installed.

Note The DS7400 and DS7400X require ROM version 1.07 or greater.

Functions

Interchangeable, Pointable Mirrors

The detector comes with a standard broad pattern mirror and two optional mirrors are available: a long-range pattern mirror and a barrier pattern mirror. To change the mirror, just pull it out from its resting grooves. The mirrors are adjustable from +1° to -18° vertically by sliding the mirror forward or back and ±10° horizontally by rocking the mirror side to side.

Selectable sensitivity

Selectable for Standard, Intermediate or High:

- **Standard:** Tolerates environment extremes on this setting. Not recommended for OA200 coverage.

Certifications and Approvals

Region	Certification
Europe	CE 89/336/EEC, EN55022: 1998, EN50130-4: 1995, EN60950: 2000, EN61000-3-2, EN61000-3-3, EN61000-4-2, EN61000-4-3, EN61000-4-4, EN61000-4-5, EN61000-4-6, EN61000-4-11
USA	UL ANSR: Intrusion Detection Units (UL639)
Europe	CE

Installation/Configuration Notes

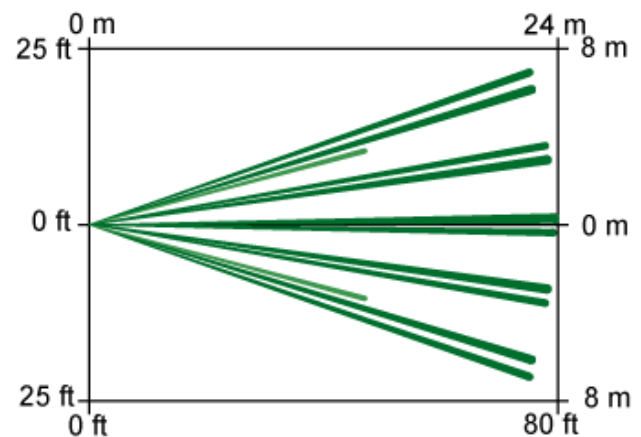

Top View

A80 Mirror Module: 24 m x 15 m (80 ft x 50 ft)



Side View

A80 Mirror Module: 24 m x 15 m (80 ft x 50 ft)



Top View
A200 Mirror Module: 61 m x 3 m (200 ft x 10 ft)



Side View
A200 Mirror Module: 61 m x 3 m (200 ft x 10 ft)

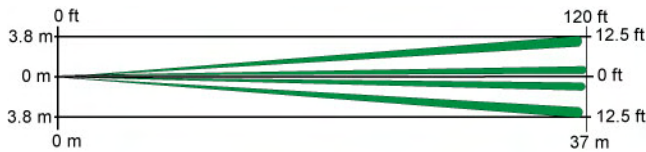

Top View
Optional A120 Mirror Module: 37 m x 8 m (120 ft x 25 ft)



Side View
Optional A120 Mirror Module: 37 m x 8 m (120 ft x 25 ft)

Coverage Information

The recommended mounting height is:

- 3.1 m (10 ft) for the A200 mirror
- 2.3 m (7.5 ft) for the A80 and A120 mirrors

Mounting Considerations

The detector may be surface or corner mounted, but use of the B334 Mounting Bracket (included) is strongly recommended. Because variations exist in the surfaces of most mounting walls, most units are not mounted at perfect angles to the floor or walls. This may cause the pattern to point away from the "ideal" direction. To ensure proper catch performance, mounting the detector on a bracket permits the flexibility needed to adjust the direction of the coverage pattern.

Misalignment of the detector when using an optional mounting bracket might reduce the range and increase dead zones.

Wiring

Do not use shielded cable. Use wire no smaller than 0.8 mm (#22 AWG) to connect the detector to the control panel.

Technical Specifications

Environmental Considerations

Temperature (Operating): -29°C to +49°C (-20°F to +120°F). For UL Listed Requirements, the temperature range is 0°C to +49°C (+32°F to +120°F).

Power Requirements

Current Draw (2-wire):

LED Off: < 350 µA draw on mux bus

In Alarm; LED On: 2 mA draw on mux bus

Current Draw (4-wire):

LED Off: < 350 µA draw on mux bus, 0 mA draw on Aux. power

In Alarm; LED On: < 350 µA draw on mux bus, 3 mA draw on Aux. power

Standby Power: There is no internal standby battery. Connect to DC power sources capable of supplying standby power if primary power fails. For each hour of standby time needed, 350 µAh are required. For UL Listed Requirements, 1400 µAh (4 hrs.) minimum is required.

Voltage (Input): 12 VDC from panel's mux bus and optionally from an auxiliary power supply.

Ordering Information

MX794i Long Range Multiplex PIR Detector **MX794i**

Provides a variety of coverage patterns through the use of interchangeable mirror modules

Accessories

OA120-2 Mirror **OA120-2**

A 36.5 m (120 ft) optical array module. Shipped in packages of two.

DS150i Series Request-to-Exit Detectors



Features

- ▶ Single or double door use
- ▶ Wall or ceiling mountable
- ▶ Internal vertical pointability
- ▶ Wrap-around coverage pattern
- ▶ Selectable relay trigger mode
- ▶ Selectable fail safe/fail secure modes

The DS150i Series consists of the DS150i Detector (light gray) and the DS151i Detector (black). They are specifically designed for Request-to-exit (REX) applications. The DS150i and DS151i detect motion in their coverage area and signal an access control system or door control device.

Functions

Test Features

Externally visible activation LED.

Certifications and Approvals

Region	Certification	
Europe	CE	89/336/EEC, EN55022:1998 +A1:2000 +A2:2003, EN50130-4:1996 +A1:1998 +A2:2003, EN61000-4-2:1995 +A1:1998 +A2:2001, EN61000-4-3:2002 +A1:2003, EN61000-4-4:1995 +A1:2000 +A2:2001, EN61000-4-5:1995 +A1:2001, EN61000-4-6:1996 +A1:2001 +A2:2001, EN61000-4-11:1994 +A1:2001, EN60950-1:2001
USA	UL	ALVY: Access Control Systems Units (UL294)

Installation/Configuration Notes

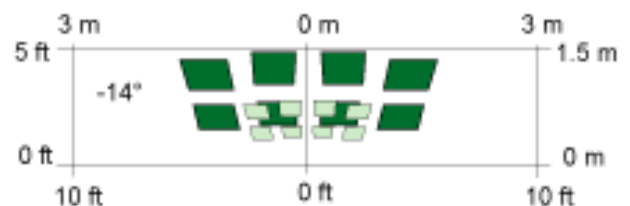
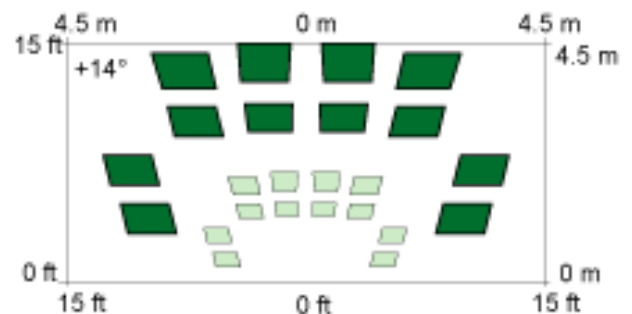
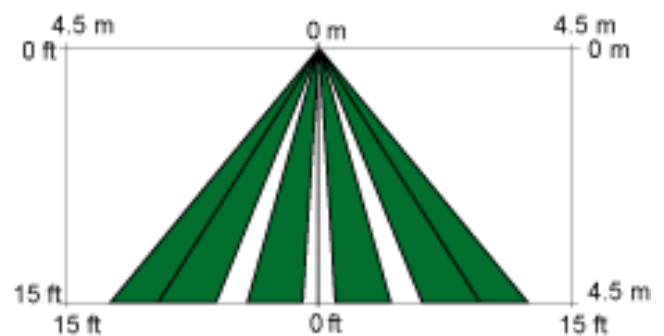

Front View and Top Views

A front view of the DS150i and DS151i coverage, as well as top views of the coverage pattern on the floor. The typical coverage measurements are 2.4 m x 3 m (8 ft x 10 ft).

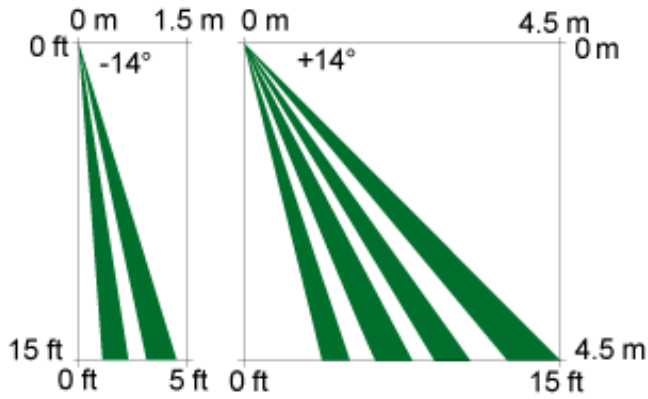
**Side View**

A side view of the DS150i and DS151i coverage pattern.

Technical Specifications**Electrical**

Current Draw:	26 mA at 12 VDC
Voltage:	12 VAC or VDC; 24 VAC or VDC

Mechanical

Alarm Output:	Two Form C relay contacts
Indicators:	One activation LED
Relay Latch Time:	Adjustable to 60 sec
Enclosure Dimensions:	3.8 cm x 15.9 cm x 3.8 cm (1.5 in. x 6.25 in. x 1.5 in.)
Enclosure Material:	High impact ABS plastic enclosure
Power Loss Default Mode:	Programmable fail-safe or fail-secure modes.
Timer Mode:	Programmable reset (accumulative) or non-reset (counting) mode.
Mounting Location:	Surface mount on wall or ceiling

Environmental

Operating Temperature:	-29°C to +49°C (-20°F to +120°F)
Radio Frequency Interference (RFI) Immunity:	No alarm or setup on critical frequencies in the range from 26 MHz to 1000 MHz at 50 V/m.

Ordering Information

DS150i Request-to-exit PIR Detector Gray enclosure. For use in request-to-exit (REX) applications. Provides 2.4 m x 3 m (8 ft x 10 ft) coverage.	DS150i
------------------------------------------------------------------------------------------------------------------------------------------------------------	---------------

DS151i Request-to-exit PIR Detector Black enclosure. For use in request-to-exit (REX) applications. Provides 2.4 m x 3 m (8 ft x 10 ft) coverage.	DS151i
-------------------------------------------------------------------------------------------------------------------------------------------------------------	---------------

Accessories

TP160 Trim Plate A light gray trim plate used when mounting the detector over a standard single-gang box.	TP160
---------------------------------------------------------------------------------------------------------------------	--------------

TP161 Trim Plate A black trim plate used when mounting the sensor over a standard single-gang box.	TP161
--------------------------------------------------------------------------------------------------------------	--------------

DS160 Series High Performance Request-to-exit Detectors



Features

- ▶ **Door monitor with sounder alert**
- ▶ **Sequential Logic Input (SLI)**
- ▶ **Internal vertical pointability**
- ▶ **Wrap-around coverage pattern with precise pattern control**
- ▶ **Up to 64 second adjustable latch time**
- ▶ **Selectable relay trigger mode**
- ▶ **Selectable fail-safe or fail-secure modes**
- ▶ **Adjustable sounder volume**
- ▶ **Activation LED**

The DS160 Series consists of the DS160 Detector (light gray) and the DS161 Detector (black) specifically designed for Request-to-exit (REX) applications. With features such as timers, door monitor with sounder alert, and pointable coverage, the DS160 and DS161 have the flexibility to meet the most stringent REX requirements. The exclusive Sequential Logic Input (SLI) provides added security that is not offered in any other REX device.

Functions

Sequential Logic Input (SLI)

The SLI terminal allows connection of a second device to require sequential detection. This eliminates the possibility that an object that is slid through the door or underneath the door will activate the detector. This input can also be used to lock the sensor if motion is present outside the premises.

Door Monitor

The sensor can monitor a door contact to allow special control of the internal relay. For example, if the door is opened within the relay time period, the sensor can be programmed to halt the timer. If the door is not opened within a specific time period, the relay can be programmed to deactivate.

Sounder Alert

An integrated sounder can be programmed to activate if the door is left open too long. The sounder volume is fully adjustable to 85 dB.

Keycard Input

The keycard input allows the sensor relay to be controlled from an external source, such as an access control system or card reader.

Certifications and Approvals

Region	Certification	
Europe	CE	89/336/EEC, EN55022:1998 +A1:2000 +A2:2003, EN50130-4:1996 +A1:1998 +A2:2003, EN61000-4-2:1995 +A1:1998 +A2:2001, EN61000-4-3:2002 +A1:2003, EN61000-4-4:1995 +A1:2000 +A2:2001, EN61000-4-5:1995 +A1:2001, EN61000-4-6:1996 +A1:2001 +A2:2001, EN61000-4-11:1994 +A1:2001, EN60950-1:2001
Poland	CNBOP	DS160
USA	UL	ALVY: Access Control Systems Units (UL294)
Europe		Complies with EN50131-1 Grade 2

Installation/Configuration Notes

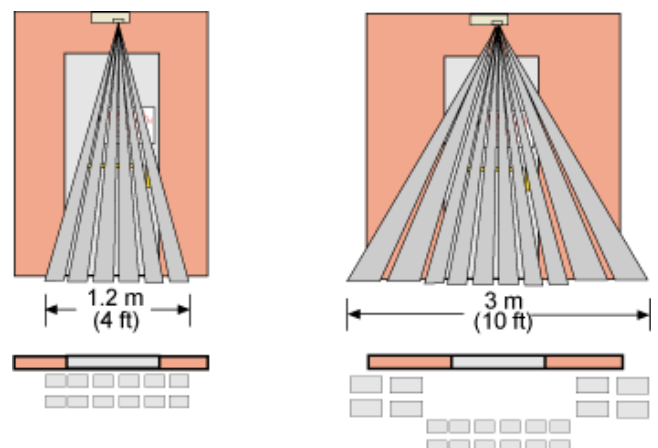

Front View

Mounted on wall above door and mounted on ceiling .75 m (2.5 ft) in front of the door.

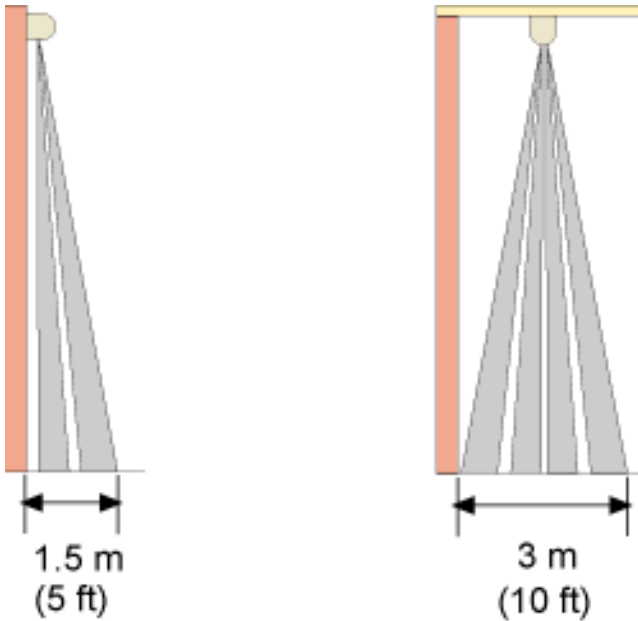
**Side View**

The higher that you mount the unit, the larger the coverage area. Do not mount the DS160/DS161 more than 4.6 m (15 ft) above the floor.

Side view of coverage pattern with the unit mounted at 4.6 m (15 ft) above the floor with the lens pointed straight down.

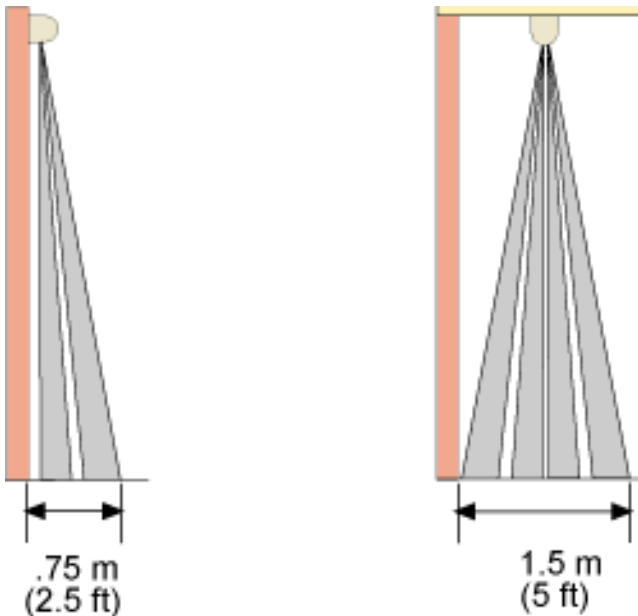
**Side View**

The higher that you mount the unit, the larger the coverage area. Do not mount the DS160/DS161 more than 4.6 m (15 ft) above the floor.

Side view of coverage pattern with the unit mounted at 4.6 m (15 ft) above the floor with the lens pointed straight down.

Coverage Information

The coverage (detection area) varies depending on the mounting height above the floor, angle of the lens, and whether the unit is mounted on a wall above the door or on the ceiling. The coverage is 2.4 m x 3 m (8 ft x 10 ft). The coverage patterns for the detector at a height of 2.3 m (7.5 ft) are shown. The coverage pattern increases or decreases with height and detector alignment.

Note When you mount the unit on the wall and the lens points straight down, some detection zones point toward the wall and do not detect movement.

The diagrams depict views of the coverage pattern with the detector mounted at 2.3 m (7.5 ft) above the floor with the lens pointed straight down. Zones that are pointed toward the wall are not shown.

Technical Specifications**Environmental**

Operating Temperature: -29°C to +49°C (-20°F to +120°F)
For UL Certificated installations, 0°C to +49°C (+32°F to +120°F)

Radio Frequency Interference (RFI) Immunity: No alarm or setup on critical frequencies in the range from 26 MHz to 1000 MHz at 50 V/m

Complies with Environmental Class II (EN50130-5)

Mechanical

Dimensions: 4.5 cm x 17.1 cm x 4.4 cm (1.80 in. x 6.75 in. x 1.75 in.)

Material: High impact ABS plastic enclosure

Modes

Power Loss Default: Programmable fail-safe or fail-secure modes.

Timer: Programmable reset accumulative or non-reset counting mode.

Electrical

Current Draw: 8 mA nominal standby current, 39 mA at 12 VDC in alarm

Voltage: 12 VAC or VDC to 30 VAC or VDC

Alarm Output: Two Form C relay contacts each rated 1 A at 30 VAC or VDC for resistive loads

Indicators: 1 activation LED

Relay Latch Time: Adjustable from 0.5 sec to 64 sec.

Ordering Information**DS160 Request-to-exit Detector** **DS160**

Light gray enclosure. For use in request-to-exit (REX) applications. Provides 2.4 m x 3 m (8 ft x 10 ft) coverage, timers, door monitor with sounder alert, and pointable coverage.

DS161 Request-to-exit Detector **DS161**

Black enclosure. For use in request-to-exit (REX) applications. Provides 2.4 m x 3 m (8 ft x 10 ft) coverage, timers, door monitor with sounder alert, and pointable coverage.

Accessories**TP160 Trim Plate** **TP160**

A light gray trim plate used when mounting the detector over a standard single-gang box.

TP161 Trim Plate **TP161**

A black trim plate used when mounting the sensor over a standard single-gang box.

DS1100i Series Glassbreak Detectors



5

Features

- ▶ **Microprocessor-based SAT**
- ▶ **Automatic environmental test circuitry**
- ▶ **Sound check**
- ▶ **Multiple enclosure designs**

The DS1100i Detector Series uses microprocessor-based sound analysis technology (SAT) to listen for the specific frequencies associated with breaking glass. The DS1101i, DS1108i, DS1102i, and DS1103i can be used to detect breakage of plate, tempered, laminated and wired glass types. A built-in environmental test feature alerts the installer to false alarm hazards in harsh environments. Several cover designs are available.

Functions

Signal Processing

Audio signals are analyzed using microprocessor-based SAT and must produce specific frequency, signature, and timing relationships to cause an alarm. The sophistication of this processing technique insures proper catch performance while eliminating false alarms.

Test Features

The magnet operated test mode provides a location verification and operational test when using the optional DS1110i glassbreak tester. The test mode also includes an environmental test that alerts the installer to possible false alarm sources caused by ambient noise. Automatic sound check feature allows the end user to verify that the detector

is powered and functioning by clapping his hands. Externally visible alarm LED indicates an alarm or test condition and can be programmed to latch if desired.

Certifications and Approvals

Region	Certification	
Europe	CE	DS1103i: 89/336/EEC, EN55022: 1998 +A1: 2000 +A2: 2003, EN50130-4: 1996 +A1: 1998 +A2: 2003, EN61000-4-2: 1995 +A1: 1998 +A2: 2001, EN61000-4-3: 2002 +A1: 2003, EN61000-4-4: 1995 +A1: 2000 +A2: 2001, EN61000-4-5: 1995 +A1: 2001, EN61000-4-6: 1996 +A1: 2001 +A2: 2001, EN61000-4-11: 1994 +A1: 2001, EN60950-1: 2001 +A11: 2004 DS1101i, DS1102i, DS1108i: 89/336/EEC, EN55022: 1998 +A1: 2000 +A2: 2003, EN50130-4: 1996 +A1: 1998 +A2: 2003, EN61000-4-2: 1995 +A1: 1998 +A2: 2001, EN61000-4-3: 2002 +A1: 2003, EN61000-4-4: 1995 +A1: 2000 +A2: 2001, EN61000-4-5: 1995 +A1: 2001, EN61000-4-6: 1996 +A1: 2001 +A2: 2001, EN61000-4-11: 1994 +A1: 2001, EN60950-1: 2001 +A11: 2004
USA	UL	DS1101i, DS1102i, DS1103i: ANSR: Intrusion Detection Units (UL639), ANSR7: Intrusion Detection Units Certified for Canada (cULus) DS1108i: ANSR: Intrusion Detection Units (UL639)
China	CCC	DS1101i-CHI and DS1102i-CHI: 2005013901000139

Installation/Configuration Notes

Note Glassbreak detectors are intended only as a component of a perimeter protection system. They should always be used in conjunction with motion sensors.

Mounting

Mount the DS1100i detector on the ceiling, or on the wall opposite or adjacent to the window. Coverage depends on room acoustics and window size.

Standard Coverage

7.6 m (25 ft) for glass sizes over 30.5 cm x 30.5 cm (12 in. x 12 in.).

Technical Specifications

Mechanical

Tamper Output: Normally-closed cover activated tamper switch with separate terminals. Contacts rated at 28 VDC, 125 mA maximum.

Environmental

Operating Temperature: -29°C to +49°C (-20°F to +120°F)
For UL Certificated installations, 0°C to +49°C (+32°F to +120°F)

Radio Frequency Interference (RFI) Immunity: No alarm or setup on critical frequencies in the range from 26 MHz to 950 MHz at 50 V/m.

Ordering Information

DS1101i Glassbreak Detector	DS1101i
Features a round enclosure.	

DS1101i-FRA Glassbreak Detector	DS1101i-FRA
Features a round enclosure. For use in France.	

DS1108i Glassbreak Detector	DS1108i
Features a round enclosure.	

DS1102i Glassbreak Detector	DS1102i
Features a square enclosure.	

DS1103i Glassbreak Detector	DS1103i
Features a rectangle flush mount enclosure.	

Accessories

DS1110i Glassbreak Tester	DS1110i
Used to test DS1101i, DS1102i, DS1103i, and DS1108i Glass Break Detectors. Powered by a 9 V alkaline battery (supplied).	

DS1109i Glassbreak Detector



5

Features

- ▶ **Microprocessor-based SAT**
- ▶ **Automatic environmental test circuitry**
- ▶ **Built-in door or window contact**

The DS1109i Detector uses microprocessor-based sound analysis technology (SAT) to listen for the specific frequencies associated with breaking glass. It can be used to detect breakage of plate, tempered, laminated and wired glass types. A built-in environmental test feature alerts the installer of false alarm hazards in harsh environments. It is specially designed to mount on door or window frames. A built-in magnetic contact allows monitoring of a door or window opening.

Functions

Signal Processing

Audio signals are analyzed using microprocessor-based SAT and must produce specific frequency, signature, and timing relationships to cause an alarm. The sophistication of this processing technique insures proper catch performance while eliminating false alarms.

Test Features

The push button operated test mode provides a location verification and operational test when using the optional DS1110i glassbreak tester. Test mode also includes an environmental test that alerts the installer to possible false alarm sources caused by ambient noise. Automatic sound check feature allows the end user to verify that the detector is powered and functioning by clapping his hands. Externally visible alarm LED indicates an alarm or test condition and can be programmed to latch if desired.

Certifications and Approvals

Region	Certification	
Europe	CE	89/336/EEC, EN55022:1998 +A1:2000 +A2:2003, EN50130-4:1996 +A1:1998 +A2:2003, EN61000-4-2:1995 +A1:1998 +A2:2001, EN61000-4-3:2002 +A1:2003, EN61000-4-4:1995 +A1:2000 +A2:2001, EN61000-4-5:1995 +A1:2001, EN61000-4-6:1996 +A1:2001 +A2:2001, EN61000-4-11:1994 +A1:2001, EN60950-1:2001 +A11:2004
USA	UL	ANSR: Intrusion Detection Units (UL639)

Installation/Configuration Notes

Note Glassbreak detectors are intended only as a component of a perimeter protection system. They should always be used in conjunction with motion sensors.

Mounting

Mount the DS1109i on the ceiling, or on the wall opposite or, adjacent to the window. Coverage depends on room acoustics and window size.

Standard Coverage

3 m (10 ft) for glass sizes over 30.5 cm x 30.5 cm (12 in. x 12 in.).

Technical Specifications

Electrical

Current: 21 mA nominal at 12 VDC

Voltage: 9 VDC to 15 VDC

Mechanical

Dimensions: 3.2 cm x 9.5 cm x 2.3 cm (1.25 in. x 3.75 in. x 0.88 in.)

Material: High impact ABS plastic enclosure

Alarm Output: Normally-closed reed relay rated at 3.5 W, 125 mA at 28 VDC for resistive loads.

Tamper Output: Normally-closed cover activated tamper switch with separate terminals. Contacts rated at 28 VDC, 125 mA maximum

Environmental

Operating Temperature: -29°C to +49°C (-20°F to +120°F)
For UL Certified installations, 0°C to +49°C (+32°F to +120°F)

Radio Frequency Interference (RFI) Immunity: No alarm or setup on critical frequencies in the range from 26 MHz to 950 MHz at 50 V/m.

Ordering Information

DS1109i Glassbreak Detector **DS1109i**
Mounts to door or window frames. Includes an internal magnetic contact.

Accessories

DS1110i Glassbreak Tester **DS1110i**
Used to test DS1101i, DS1102i, DS1103i, and DS1108i Glass Break Detectors. Powered by a 9 V alkaline battery (supplied).

ISN-SM Seismic Detectors



5

Features

- ▶ **24-hour surveillance of vault walls and doors, safes, night safes, and automatic teller machines**
- ▶ **Sensitivity settings using DIP switches**
- ▶ **SENSTEC® sensor and signal processing system based on microcontrollers**
- ▶ **Low-profile design**

The following models belong to the ISN-SM series seismic detectors:

Model	Features
ISN-SM-50	<ul style="list-style-type: none"> • 4 m operating radius on concrete • 50 m² monitoring area
ISN-SM-80	<ul style="list-style-type: none"> • 5 m operating radius on concrete • 80 m² monitoring area

Each seismic detector monitors objects and surfaces, has a low-profile design, and can be installed effortlessly, even in tight spaces. ISN-SM seismic detectors are designed to monitor safes, night safes, and automatic teller machines.

System Overview

When cutting and drilling through materials such as concrete, steel, or synthetic reinforcements, deviations from the structures' normal vibration pattern ensue. The SENSTEC sensor converts vibration deviations into electrical signals. The digital processing in the seismic detector analyzes the signals and compares them to a frequency range typical of tools used to break into safes, night safes etc. If the signals fall within this frequency range, the seismic detector transmits an alarm via a relay contact.

Functions

Detection

The seismic detector recognizes vibrations caused by explosives and tools such as diamond-tipped drills, mechanical and hydraulic rams, flame cutters, thermal lances, or water jet cutters.

The SENSTEC sensor and the digital signal processing monitor a narrow frequency range, thus offering reliable detection. The seismic detector tolerates environmental conditions such as air movement and noise.

Sensitivity settings using DIP switches

The sensitivity settings are selected using DIP switch settings. Select the appropriate sensitivity setting for the application, the material, and the object, as well as any interference present. The following settings are available:

- Steel, 2.0 m
- Steel, 2.5 m
- Concrete, 4.0 m
- User mode, with SensTool

SensTool software

SensTool software for PCs provides the following options:

- Changing factory default settings
- Monitoring detector performance
- Storing information such as integrator signals
- Selecting additional settings for detector and shock sensitivity

Fixing device

A fixing device is available as an optional hardware accessory for ISN-SM seismic detectors. When the system is armed, the fixing device monitors safes and strong rooms for attacks using thermal and mechanical tools, as well as unauthorized opening. The fixing device components consist of a detector plate, a door plate, and a standby plate.

The detector plate has a monitoring microswitch and a magnetic contact. When the system is armed, the monitoring switch in the detector plate is closed. If the detector is removed from the door plate, the monitoring switch opens and triggers an alarm.

The detector can be hung on the standby plate during working hours.

Swivel plate

A swivel plate is available as an optional hardware accessory for the ISN-SM seismic detector. A swivel plate is used for monitoring safes and strong rooms with exposed keyholes. A microswitch in the swivel plate monitors movement. Any unauthorized swivel movement immediately triggers an alarm. When the system is armed, the swivel plate fully covers the keyhole. When the system is disarmed, the swivel plate swivels so it is at a 90° angle to the keyhole.

Certifications and Approvals

Region	Certification	
Europe	CE	89/336/EEC, EN50130-4: 2002 (including A1 and A2), EN61000-6-3: 2001, EN61000-6-4: 2001
Germany	VdS	ISN-SM-50 ISN-SM-80
USA	UL	ANSR: Intrusion Detection Units (UL639)
the Netherlands	NCP	ISN-SM-50: 06229520/AA/00

CE

Installation/Configuration Notes

Installation notes

Seismic detectors can be mounted directly onto steel plates with smooth surfaces. The surface must not be painted and must be level with a maximum deviation of 0.1 mm. If these conditions cannot be met, the MXPO mounting plate must be used.

The seismic detector cannot be mounted directly onto plastered or unplastered concrete.

Parts Included

Number	Components
1	Seismic detector (ISN-SM-50 or ISN-SM-80)
1	Installation manual
1	Installation template
3	Cable ties

Technical Specifications

Electromagnetic sensitivity

Compatibility:	Better than EN 50130-4
HF interference tolerance (EN 61000-4-3):	No alarm or setup at critical frequencies within a range of 1 MHz to 1000 MHz at > 30 V/m.

Housing

Dimensions: 8.9 cm x 8.9 cm x 2.2 cm

Weight: 0.320 kg

Environmental conditions

Humidity (EN60721):	Up to 95% relative humidity, not condensing
Housing protection class (EN 60529, EN 50102):	IP435
Temperature (operating):	-40 °C to +70 °C
Temperature (storage):	-50 °C to +70 °C

Function test

For the test:	Low < 1.5 VDC High > 3.5 VDC
---------------	---------------------------------

Test duration (including test transmitter ISN-GMX-S1): ≤ 3 sec

Operating radius according to monitoring area on concrete and steel for all tools, including thermal tools

ISN-SM-50: 4 m radius = 50 m² monitoring area

ISN-SM-80: 5 m radius = 80 m² monitoring area

Outputs

Alarm relay (changeover contact): Contact closed in standby mode (opened in the event of an alarm) designed for 30 VDC, 100 mA, resistance < 20 Ohm

Alarm holding time: Approx. 2.5 sec

Tamper switch/wall tamper: Tamper contact closed in standby mode (opened in the event of tampering) designed for 30 VDC, 100 mA, resistance < 45 Ohm

Test connection: Analog integration signal

Power requirements

Power consumption at 12 VDC: Alarm: 6 mA
Standby: 3 mA

Power supply monitoring: 8 VDC to 16 VDC (12 V nominal)
Alarm: < 7 VDC

Input for remote controlled reduction of sensitivity

For reduction: Low < 1.5 VDC
High > 3.5 VDC

Reduction to: 1/8 of current setting

Trademarks

SENSTEC® is a registered trademark of Siemens Building Technologies.

Ordering Information

ISN-SM-50 Seismic Detector **ISN-SM-50**
4 m operating radius on concrete and 50 m² monitoring area.

ISN-SM-80 Seismic Detector **ISN-SM-80**
5 m operating radius on concrete and 80 m² monitoring area.

Accessories

ISN-GMX-D7 anti-drill foil **ISN-GMX-D7**
For use with seismic detectors to provide drill protection. Insert foil in the detector's cover to provide extra tamper protection.

ISN-GMA-S6 fixing device **ISN-GMA-S6**
For use with seismic detectors to monitor safes and strong rooms. Consists of a detector plate, a door plate, and a standby plate.

ISN-GMX-B0 floor socket **ISN-GMX-B0**
For floor mounting a seismic detector. Weight: 2.08 kg. A surface at least 30 cm x 30 cm and at least 80 cm deep is required.

Ordering Information

ISN-GMX-P0 mounting plate **ISN-GMX-P0**

Mounting plate for seismic detectors. Weight: 0.27 kg. Suitable for mounting seismic detectors to steel or concrete surfaces. Screw or weld the mounting plate directly onto the surface.

ISN-GMX-P3S swivel plate **ISN-GMX-P3S**

For use with ISN-SM-50 seismic detectors. Monitors safes and strong rooms with exposed keyholes.

ISN-GMX-PZ swivel plate **ISN-GMX-PZ**

For use with ISN-SM-80 seismic detectors. Monitors safes and strong rooms with exposed keyholes.

ISN-GMX-S1 test transmitter **ISN-GMX-S1**

For installation under a seismic detector. Checks the detector and the physical contact between the detector and the protected object.

ISN-GMX-W0 wall mounting kit, surface and flush mount **ISN-GMX-W0**

For surface or flush mounting a seismic detector to the wall. Weight: 1.16 kg.

ISN-GMXW-G0 watertight housing **ISN-GMXW-G0**

Protects seismic detectors from water and dust.

ISN-GMX-P3S2 spacer (2 mm) **ISN-GMX-P3S2**

Thickness: 2 mm.

ISN-GMX-P3S4 spacer (4 mm) **ISN-GMX-P3S4**

Thickness: 4 mm.

Software Options

ISN-SMS-W7 SensTool PC software **ISN-SMS-W7**

Programming software for seismic detectors.

DS415i and DS435i Single Beam Photoelectric Detectors



Features

- ▶ 150 m (500 ft) range
- ▶ Friction lock optics
- ▶ Alarm retransmission
- ▶ Alarm memory (DS435i only)
- ▶ Inhibit wiring (DS435i only)

This single-beam photoelectric detector series with their separate transmitters and receivers. The transmitter emits one invisible infrared beam to the receiver. If the beam is broken, the receiver signals an alarm.

Functions

Alarm Memory (DS435i only)

Provides indication of stored alarms for use in multiple unit applications by latching the alarm LED at the receiver. Controlled by a switched voltage from the control panel.

Alarm Retransmission

Supervised alarm circuit transmitter that allows connection of normally open or normally closed devices such as magnetic contacts or relays from other detectors. Their condition is relayed to the receiver by transmitter shutdown.

Inhibit Wiring (DS435i only)

Optional signal synchronization wire between transmitter and receiver. Prevents receiver from being activated by other sources such as another transmitter. Units must have a common ground connection.

Test Features

- Alarm LED
- Margin test switch to assist with alignment

Certifications and Approvals

Region	Certification	
Poland	CNBOP	DS435i
USA	UL	DS415i and DS435i: ANSR: Intrusion Detection Units (UL639)
Canada	ULC	DS415i-CAN: ANSRC: Intrusion Detection Units

Technical Specifications

Photobeam

DS415i Range: 150 m (500 ft)

DS435i Range: 150 m (500 ft)

Enclosure Design

Dimensions: 16.2 cm x 7.7 cm x 6.6 cm (6.375 in. x 3 in. x 2.6 in.)

Material: High impact Lexan® cover with die cast zinc base.

Environmental Considerations

Operating Temperature: -18°C to +49°C (0°F to +120°F). For UL installations the operating range is 0°C to +49°C (+32°F to +120°F), indoor use.

Mounting

Location: Surface mount

Pointability: ±90° horizontal, ±20° vertical.

Power Requirements

Input Power: 8 VDC to 14.5 VDC or 12 VAC

DS415i Transmitter Current Draw: 8 mA at 12 VDC, 68 mA RMS with battery.

DS415i Receiver Current Draw: 33 mA at 12 VDC, 95 mA RMS with battery.

DS435i Transmitter Current Draw: 8 mA at 12 VDC

DS435i Receiver Current Draw: 20 mA at 12 VDC

Alarm Output: Form C contacts rated at 3.0 W, 125 mA at 28 VDC for resistive loads.

Tamper Output: Form A contact rated 125 mA at 28 VDC.

Trademarks

Lexan® is either a trademark or registered trademark of General Electric Company in the United States and other countries.

Ordering Information**DS415i Detector**

Provides AC/DC operation and battery back-up. Includes a P333 Standby Battery. The range is 150 m (500 ft).

DS415i

DS435i High Performance Detector

Provides DC operation only, alarm memory, and inhibit wiring. The range is 150 m (500 ft).

DS435i

DS422i and DS426i Dual-Beam Photoelectric Detectors



Features

- ▶ **Dual beam detection**
- ▶ **Range up to 60 m (200 ft) outdoors, 180 m (600 ft) indoors**
- ▶ **Selectable response time**
- ▶ **Small unobtrusive design**

The DS422i and DS426i are dual-beam photoelectric detectors designed for indoor and outdoor applications. Consisting of a separate transmitter and receiver, they are designed to activate an alarm when an intruder passes within the direct line of sight between the transmitter and receiver.

The D422i has a range of 30 m (100 ft) outdoors or 90 m (300 ft) indoors. The D426i has a range of 60 m (200 ft) outdoors or 180 m (600 ft) indoors.

Certifications and Approvals

Region	Certification	
Europe	CE	
Poland	CNBOP	DS422i DS426i
USA	UL	ANSR: Intrusion Detection Units (UL639)
China	CCC	2003031901000009

Installation/Configuration Notes

Mounting Considerations

Can be surface or pole mounted.

Technical Specifications

Photobeam

DS422i Range Indoor: 90 m (300 ft), Outdoor: 30 m (100 ft)

DS426i Range Indoor: 180 m (600 ft), Outdoor: 60 m (200 ft)

Response Time: Selectable from 50 ms to 700 ms

Enclosure Design

Dimensions: 17.1 cm x 8.2 cm x 8.7 cm
(6.75 in. x 3.25 in. x 3.5 in.)

Material: Smoked Lexan®

Environmental Considerations

Temperature (Operating): -25°C to 55°C (-13°F to 130°F)

Mounting Considerations

Pointability: Adjustable ±90° horizontally, ±24° vertically

Outputs

Relay: Alarm activated Form C with dry contacts rated at 0.5 A maximum at 30 VAC/VDC

Tamper: Normally-closed with cover in place

Power Requirements

DS422i Receiver Current Draw: 31 mA

DS426i Receiver Current Draw: 31 mA

DS422i Transmitter Current Draw: 10 mA

DS426i Transmitter Current Draw: 27 mA

Voltage (Input): 12 VDC to 28 VDC, non-polarized

Trademarks

Lexan® is either a trademark or registered trademark of General Electric Company in the United States and other countries.

Ordering Information

DS422i Photoelectric Detector **DS422i**
Provides an indoor range 90 m (300 ft), and an outdoor range of 30 m (100 ft).

DS426i Photoelectric Detector **DS426i**
Provides an indoor range of 180 m (600 ft), and an outdoor range of 60 m (200 ft).

DS453Q and DS455Q Quad Beam Photoelectric Detectors



5

Features

- ▶ **Quad beam detection**
- ▶ **Four mounting options using optional mounting poles**
- ▶ **Environmental discrimination circuit**
- ▶ **Beam power control to reduce cross-talk**

The Detector Series consists of the DS453Q and DS455Q Detectors with separate transmitters and receivers each. The transmitter emits an invisible infrared beam to the receiver. If the beam is broken, the receiver signals an alarm.

The DS453Q and DS455Q use four pulsed infrared beams that are designed to activate an alarm only when all four beams are simultaneously blocked.

The DS453Q and DS455Q also feature interlocked upper and lower beams, signal voltage LED, and selectable environmental discrimination circuitry.

Functions

Environmental Discrimination Circuit

- Monitors gradual loss of signal due to dust, fog, rain, and snow. Normally closed output opens when signal loss reaches 90%. May be field configured to bypass alarm relay when activated.
- Field adjustable sensitivity, normally closed relay contacts rated 0.2 A, 30 VDC.

Test Features

Externally visible alarm LED. Internal transmitter operation LEDs. Flashing LED and voltage output at receiver for alignment purposes.

Certifications and Approvals

Region	Certification	
Europe	CE	89/336/EEC, EN50130-4: 1996 +A1: 1998 +A2: 2003, EN61000-6-3: 2001 +A11: 2004
USA	UL	ANSR: Intrusion Detection Units (UL639)
China	CCC	2003031901000085

Installation/Configuration Notes

Mounting Considerations

Mount these detectors on surfaces or poles. Pole mount to 4.1 cm to 4.5 cm (1.625 in. to 1.75 in) O. D. pole.

Technical Specifications

Photobeam

Outdoor Range DS453Q:	110 m (360 ft)
Outdoor Range DS455Q:	160 m (525 ft)
Environmental Discrimination Circuit (EDC):	Normally-closed switch for connection to normally-closed supervision circuit. Rated at 0.2 A at 30.0 VDC
Beam Interrupt Time:	50 ms to 500 ms (adjustable)

Environmental Considerations

Operating Temperature:	-25°C to 60°C (-13°F to 140°F)
Storing Temperature:	-30°C to 70°C (-22°F to 158°F)

Mounting Considerations

Internal Pointability:	180° horizontal, 20° vertical
------------------------	-------------------------------

Power Requirements

Power Supply:	10.5 VDC to 28.0 VDC
Current Draw DS453Q:	135 mA (maximum, transmitter and receiver total)
Current Draw DS455Q:	160 mA (maximum, transmitter and receiver total)
Alarm Output:	Form C relay rated at 0.2 A at 30.0 VDC
Tamper Output:	Normally-closed tamper switch rated at 0.1 A at 30.0 VDC
Beam Power Control:	Equipped

Enclosure Design

Material:	High impact Lexan® enclosure
Dimensions:	398 mm x 103 mm x 99 mm (15.67 in. x 4.06 in. x 3.90 in.)
Weight (transmitter and receiver total):	2.4 kg (5.3 lb)

Trademarks

Lexan® is either a trademark or registered trademark of General Electric Company in the United States and other countries.

Ordering Information

DS453Q Photoelectric Detector **DS453Q**
Provides an outdoor range of 110 m (360 ft).

DS455Q Photoelectric Detector **DS455Q**
Provides an outdoor range of 160 m (525 ft).

Accessories

PC1A Weather Enclosure **PC1A**
Protects detectors when mounted outside.
The enclosure's dimensions are 39.4 cm x
10.3 cm x 6 cm (15.5 in. x 4 in. x 2.4 in.).
Shipped in packages of two.

PEH-2 Heater **PEH2**
Reduces the effects of frost, intense fog, cold,
and damp conditions on photoelectric beam
detectors. Shipped in packages of four (two for
transmitter and two for receiver).

MP1 Metal Pole, 1 m (3 ft) **MP1**
Straight metal poles measuring 1 m (3 ft) for
pole mounting photoelectric detectors. Ship-
ped in packages of two.

MP2 Metal Pole, 1.2 m (4 ft) **MP2**
Straight metal poles measuring 1.2 m (4 ft) for
pole mounting photoelectric detectors. Ship-
ped in packages of two.

MP3 L-Curved Metal Pole **MP3**
Curved metal poles for mounting to vertical
surfaces for pole mounting photoelectric de-
tectors. Shipped in packages of two.

DS484Q and DS486Q Quad-Beam Photoelectric Detectors



5

Features

- ▶ **Quad beams**
- ▶ **Easy alignment (sounder, LEDs, and voltage readings)**
- ▶ **Two coverage ranges**
- ▶ **Four mounting options with optional mounting poles**
- ▶ **Environmental discrimination circuit**
- ▶ **Multiple channel operation**
- ▶ **And-Or mode selection**

The DS484Q and DS486Q Detectors have separate transmitters and receivers. The transmitter sends an invisible infrared beam to the receiver. If the beam is broken, the receiver signals an alarm. Multiple channel operation provides increased system flexibility.

Functions

Environmental Discrimination Circuitry

Monitors gradual loss of signal due to dust, fog, rain, snow, and so on. Normally-closed output opens when signal loss reaches 90%. Can be field configured to bypass alarm relay when activated.

Test Features

The transmitters have three features for use in alignment and testing.

- Voltage output (requires a voltmeter)
- Sounder for alignment
- LEDs (alignment)

Multiple Channel Operation

Configure the detectors for up to eight different channels. This allows multiple units to be used near one another without the possibility of receiver cross-talk. This is particularly useful when stacking multiple beam sets.

And-Or Mode Selection

You can configure the detectors to cause an alarm when all four beams are blocked, or when either the upper two beams or lower two beams are blocked. This configuration detects smaller objects and eliminates the possibility of someone crawling through the beam.

Certifications and Approvals

Region	Certification	
Europe	CE	89/336/EEC, EN55022: 1998, EN50130-4: 1995 +A1: 1998 +A2: 2003, EN61000-3-2: 2000, EN61000-3-3: 1995, EN61000-4-2: 1995 +A1: 1998 +A2: 2001, EN61000-4-3: 1996 +A1: 1998 +A2: 2001, EN61000-4-4: 1995 +A1: 2001, EN61000-4-5: 1995 +A1: 2001, EN61000-4-11: 1994, ENV50141: 1993
USA	UL	ANSR: Intrusion Detection Units (UL639)

Installation/Configuration Notes

Mounting Considerations

Mount these detectors on solid vibration free surfaces or poles.

Technical Specifications

Photobeam

Selectable Beams: Two groups by four channels

Maximum Outdoor Coverage DS484Q: 120 m (400 ft)

Maximum Outdoor Coverage DS486Q: 200 m (660 ft)

Response Time: Selectable response time of 35 ms to 700 ms

Beam Interrupt Time: Adjustable from 50 ms to 500 ms

Enclosure Design

Material: Polycarbonate

Dimensions: 398 mm x 103 mm x 99 mm (15.67 in. x 4.06 in. x 3.90 in.)

Receiver Weight: 1.2 kg (2.64 lb)

Transmitter Weight: 1.2 kg (2.64 lb)

Environmental Considerations

Operating Temperature: -25° C to + 55° C (-13°F to + 130° F)

IP Rating: IP 54 (protection against dust; protection against splashing water)

Mounting Considerations

Location: Surface or pole mount

Pattern Pointability: ±90° horizontal, ±10° vertical

Power Requirements

Voltage: 10.5 VDC to 28 VDC non-polarized

Receiver Current Draw: 80 mA standby, 50 mA alarm

DS484Q Transmitter Current Draw: 35 mA

DS486Q Transmitter Current Draw: 55 mA

Backup Power Requirements: 4 hours (120 mAh) minimum required for UL Certified Installations

Tamper Output: Normally-closed contacts rated at 0.1 A at 30 VDC

Alarm Output: Form C 0.2 A at 30 VDC, output period: 3 sec

EDC Output: Normally-closed 0.2 A at 30 VDC, output period: 3 sec

Tamper Output: Normally-closed 0.1 A at 30 VDC, output period: while cover is removed

Environmental Discrimination Circuit Output: Normally-closed contacts rated at 0.2 A at 30 VDC

Ordering Information

DS484Q Photoelectric Detector **DS484Q**
Provides an outdoor range of 120 m (400 ft).

DS486Q Photoelectric Detector **DS486Q**
Provides an outdoor range of 200 m (660 ft).

Accessories

MP1 Metal Pole, 1 m (3 ft) **MP1**
Straight metal poles measuring 1 m (3 ft) for pole mounting photoelectric detectors. Shipped in packages of two.

MP2 Metal Pole, 1.2 m (4 ft) **MP2**
Straight metal poles measuring 1.2 m (4 ft) for pole mounting photoelectric detectors. Shipped in packages of two.

MP3 L-Curved Metal Pole **MP3**
Curved metal poles for mounting to vertical surfaces for pole mounting photoelectric detectors. Shipped in packages of two.

PC1A Weather Enclosure **PC1A**
Protects detectors when mounted outside. The enclosure's dimensions are 39.4 cm x 10.3 cm x 6 cm (15.5 in. x 4 in. x 2.4 in.). Shipped in packages of two.

PEH-2 Heater **PEH2**
Reduces the effects of frost, intense fog, cold, and damp conditions on photoelectric beam detectors. Shipped in packages of four (two for transmitter and two for receiver).

ND 100 GLT Panic Button



Environmental class	2
Housing	
• Housing material	ABS
• Housing color	RAL 9002
• Cover color	Gray
Weight	Approx. 0.07 kg
Dimensions (D x H)	81 x 31 mm

Ordering Information

ND 100 GLT Panic Button

ND 100 GLT

For unobtrusively and manually triggering alarms at work places that are in potential danger of being held up

5

Features

- ▶ **Panic button in DC circuit technology (GLT)**
- ▶ **For connecting to an intrusion panel**
- ▶ **Tamper contact**
- ▶ **Cable can be surface- or flush-mounted**
- ▶ **Cap with cover as trigger protection (optional)**

The ND 100 GLT panic button is used for unobtrusively and manually triggering alarms at work places that are in potential danger of being held up, such as banks, jewelry shops, businesses, private households etc.

Certifications and Approvals

Region	Certification	
Europe	CE	ND 100 GLT
Germany	VdS	G 195065, C ND 100 GLT

Parts Included

Type	Qty.	Component
ND 100 GLT	1	Panic button incl. adhesive seal

Technical Specifications

Alarm contact (Changeover contact)	30 V_/300 mA
Tamper switch (Changeover contact)	30 V_/300 mA
Ambient temperature	0 °C to 50 °C
Ambient climates	DIN 40 040 R14
Protection category	IP 40

F220 Photoelectric Smoke Detectors



Features

- ▶ Two-wire or four-wire bases
- ▶ 30 ft (9 m) maximum spacing between detectors
- ▶ Optional CO-sensor, heat-sensor enhanced detection chamber
- ▶ Clean chamber without removal or disassembly
- ▶ CleanMe® signaling capability
- ▶ Sensitivity readout on detector
- ▶ Detector chamber compensates for dust build-up
- ▶ Tamper protection
- ▶ Dual-color LED

The F220 Photoelectric Smoke Detectors are UL Listed, open-area photoelectric smoke detectors. Use them with commercial fire protective signaling systems and household fire warning systems (see NFPA 72, the National Fire Alarm Code). These smoke detectors scatter light using a pulsed infrared source operating with a gated, high-speed, photodiode infrared sensor. The symmetry of the optical chamber allows 360° uniform smoke entry, but minimizes external light entry. The detectors use low current electronic circuitry, so they can connect to 12 VDC nominal or 24 VDC nominal power source circuits.

Functions

Compatible Bases

Configure the detectors into two-wire or four-wire versions by selecting the appropriate mounting base. These detectors are compatible with any of the F220-B6 bases:

- F220-B6 12/24 VDC Two-wire Mounting Base

- F220-B6R Standard 12/24 VDC Four-wire Mounting Base
- F220-B6RS 24 VDC Four-wire Mounting Base with Sounder
- F220-B6C 12/24 VDC Four-wire Mounting Base with Auxiliary Relay
- F220-B6E 12/24 VDC Four-wire Power Supervision Mounting Base
- F220-B6PM 24 VDC Four-wire Addressable Master Base
- F220-B6PS 12/24 VDC Four-wire Addressable Base

Monitoring the Detection Chamber

These detectors have several features that work together to maximize the performance of the optical chamber:

- **Compensation:** The detector monitors the chamber for the effects of dust build-up within the chamber and automatically compensates for these effects. If the chamber becomes contaminated beyond its ability to compensate, the green LED flashes every 4 sec to indicate trouble.
- **Chamber Check® Self-diagnostics:** The detector automatically indicates visually if the calibration is out of the factory-listed range. This meets NFPA guidelines for sensitivity testing, because you can visually inspect the detector and check the flash rate of the LED. If the calibration is out of range, the green LED on the detector flashes once every 4 sec. This indicates that the detector must be cleaned following the instructions provided with the detector.
- **CleanMe Mode:** Indicates if the calibration is out of the factory-listed range by sending a trouble signal to the CleanMe-compatible control panel, if so programmed.
- **Chambermaid™:** The detector has a unique cleaning mechanism. Use the valve on the back of the detector to insert the nozzle of a can of clean, dry compressed air. Clean the chamber with a short (1 to 2 sec) blast of air.

Heat and Carbon Monoxide Enhancements

The detectors are available with an optional fixed-temperature heat sensor, a carbon monoxide (CO) sensor, or a combination of heat and CO sensors. These optional sensors enhance the operation of the smoke detector by reducing false alarms.

- **Carbon Monoxide:** Without the presence of CO, a normal byproduct of combustion, the detection chamber is half as sensitive to smoke as a standard commercial photoelectric smoke chamber. This reduces false alarms. When the sensor detects CO, the detection chamber's sensitivity to smoke increases so it equals or exceeds that of a standard commercial photoelectric smoke chamber.

Note The F220-PTHC detects carbon monoxide (CO) as a component of a fire. It is not a CO detector and cannot activate an alarm in the presence of CO only.

- **Heat:** When the heat sensor detects a temperature rise, the photoelectric chamber becomes more smoke sensitive. The heat sensor initiates an alarm if the ambient temperature exceeds +135°F (+57°C).

Dual-color LED

A dual-color LED indicator flashes green every 8 sec when the detector has power and the smoke sampling circuitry is working. If CleanMe is enabled, the green LED double flashes (two flashes a half second apart) every 8 sec to indicate normal operation. The LED turns red if an alarm is sent. After the alarm condition clears, reset the detector by interrupting its power. If the chamber becomes contaminated beyond its ability to compensate, the green LED flashes every 4 sec to indicate trouble.

Test Functions

The F220 Photoelectric Smoke Detectors feature a unique magnet operation and sensitivity test function. Test the detector's operation by placing the magnet next to the detector's LED for three consecutive flashes. This causes the detector to send an alarm. Placing a magnet next to the detector's LED for at least one red flash but less than three flashes activates the detector's sensitivity mode.

Tamper Detection

When detector heads are correctly installed in any of the F220-B6 bases, the positive power line provides tamper detection. The control panel initiates a trouble signal if a detector is removed from its base. A mechanical tamper lock comes with each base to prevent unauthorized head removal.

Certifications and Approvals

Region	Certification	
Europe	CE	89/336/EEC, EN50130-4/A Sept 1998, EN61000-6-3 Oct 2001
USA	UL	UROX: Smoke - Automatic Fire Detectors (UL268 and A), UROX7: Smoke - Automatic Fire Detectors Certified for Canada (cULus)
	FM	
	CSFM	F220-P and F220-PTH: 7272-1615: 106 July 2008 F220-PTHC: 7272-1615: 107 July 2008
	NYC-MEA	117-05-E
	MSFM	2200 Sep 2008
Hong Kong	HKFSD	

Installation/Configuration Notes**Compatible Control Panels**

Addressable Systems: compatible with addressable systems controlled by D9412GV2, D7412GV2, D9412G, or D7412G Control Panels or the D9124 Fire Alarm Control Panel when used with the F220-B6PM or F220-B6PS Addressable Detector Bases.

Two-wire: Bosch Security Systems, Inc. makes no claim written, oral, or implied that the F220 Photoelectric Smoke Detectors work with any two-wire control panels except those specified in the Control Panel Compatibility chart in the Technical Service Note (P/N: 4998148185).

Four-wire: compatible with all UL Listed four-wire control panels. Refer to the control panel's installation instructions for proper end-of-line (EOL) resistor selection.

Mounting the Bases

Note Consult NFPA-72 for proper detector placement.

Depending on local regulations, the bases can be surface mounted directly on four-inch square or octagonal electrical boxes and single-gang switch boxes.

Note The volume of any electrical box used should be large enough to accommodate the number and size of conductors as specified by the National Electrical Code or any local authorities having jurisdiction (AHJ).

Loop Supervision

Loop supervision requires one D275 or F220-B6E per loop when using F220-B6R/B6C bases and is supervised by the control panel.

Wiring the Bases

Refer to the F220 Series Detectors with F220-B6/C/E/R Bases Installation Instructions (P/N: 4998138694), the F220 Series Detectors with F220-B6RS Bases Installation Instructions (P/N: F01U029847), or the F220-B6PS/M Installation Instructions (P/N: 4998149982) for detailed wiring instructions.

Technical Specifications**Environmental Considerations**

Relative Humidity: 0% to 95% non-condensing; 15% to 95% non-condensing for CO sensing model

Temperature (normal operating): +32°F to +100°F (0°C to +38°C)

Mechanical Properties

Color: White

Dimensions (diameter x H): 6.75 in. x 2.25 in. (17.1 cm x 6.4 cm)

Power Requirements

Current (alarm): 20 mA minimum at 8.5 VDC; (detector head only) 35 mA maximum at 32 VDC

Current (start-Up): 0.12 mA maximum at 32 VDC

Maximum RMS Ripple: 25% of DC input

Power-up Time: 22 seconds maximum

Voltage (standby)

F220-B6: 8.5 VDC to 32.0 VDC

F220-B6C/-B6R/-B6E: 10.0 VDC to 30.0 VDC

F220-B6RS: 16.0 VDC to 30.0 VDC

F220-B6PM:	with D299: 18.9 VDC to 28.0 VDC without D299: 9.6 VDC to 28.0 VDC
F220- B6PS:	18.9 VDC to 28.0 VDC

Trademarks

Chamber Check® is a registered trademark of Bosch Security Systems in the United States.

Chambermaid™ is a trademark of Bosch Security Systems in the United States.

CleanMe® is a registered trademark of GE Interlogix in the United States and/or other countries.

Ordering Information

F220-PTHC Photoelectric Smoke Detector with +135°F (+57°C) Heat and Carbon Monoxide Sensors	F220-PTHC
----------------------------------------------------------------------------------------------------	------------------

Photoelectric detector head with heat and CO sensor augmentation only; requires base.

F220-P Photoelectric Smoke Detector	F220-P
--------------------------------------------	---------------

Photoelectric detector head only; requires base.

F220-PTH Photoelectric Smoke Detector with +135°F (+57°C) Heat Sensor	F220-PTH
------------------------------------------------------------------------------	-----------------

Photoelectric detector head with heat sensor only; requires base.

Accessories

F220-B6 12/24 VDC Two-wire Base	F220-B6
----------------------------------------	----------------

Standard base for two-wire (12 VDC or 24 VDC system) applications.

F220-B6R Standard 12/24 VDC Four-wire Base	F220-B6R
---------------------------------------------------	-----------------

Standard base for four-wire (12 VDC or 24 VDC) detector systems.

F220-B6RS 24 VDC Four-wire Detector Base with Sounder	F220-B6RS
--------------------------------------------------------------	------------------

Four-wire detector base with sounder for use with the F220 Series Photoelectric Smoke and Heat Detectors.

F220-B6C 12/24 VDC Four-wire Base with Auxiliary Form C Relay	F220-B6C
----------------------------------------------------------------------	-----------------

Four-wire base with a normally-open (NO) alarm loop relay and a set of auxiliary contacts (Form C).

F220-B6E 12/24 VDC Four-wire Power Supervision Base with End-of-line Power Monitoring Relay	F220-B6E
----------------------------------------------------------------------------------------------------	-----------------

Four-wire base with a normally-open (NO) alarm relay and an EOL power supervision relay.

F220 Heat Detectors



5

Features

- ▶ **Two-wire or four-wire bases**
- ▶ **50 ft (15.2 m) maximum spacing between detectors**
- ▶ **Visible identification of model: F220-135 = no ring, F220-135F = gray ring, F220-190F = black ring**
- ▶ **Tamper detection**
- ▶ **Dual color LED**

The F220 Heat Detectors include:

- **F220-135:** An electronic rate-of-rise, fixed temperature heat detector that initiates an alarm when the ambient temperature exceeds +135°F (+57°C) or when the ambient temperature increases by +15°F (+8.3°C) or more in less than 1 minute
- **F220-135F:** An electronic fixed temperature heat detector that initiates an alarm when the ambient temperature reaches +135°F (+57°C).
- **F220-190F:** An electronic fixed temperature heat detector that initiates an alarm when the ambient temperature reaches +190°F (+88°C).

The detectors use low current electronic circuitry, so they can connect to 12 VDC nominal or 24 VDC nominal power source circuits. When mounted on the appropriate F220-B6 Series Mounting Base, the F220 Heat Detectors provide general property protection from fire.

Warning Heat detectors are not life safety devices.

Functions

Compatible Bases

Configure the detectors as either two-wire or four-wire depending on the mounting base selected. These detectors are compatible with any of the F220-B6 bases:

- F220-B6 12/24 VDC Two-wire Mounting Base

- F220-B6R Standard 12/24 VDC Four-wire Mounting Base
- F220-B6RS 24 VDC Four-wire Mounting Base with Sounder
- F220-B6C 12/24 VDC Four-wire Mounting Base with Auxiliary Form C Relay
- F220-B6E 12/24 VDC Four-wire Power Supervision Mounting Base
- F220-B6PM 24 VDC Four-wire Addressable Master Base
- F220-B6PS 12/24 VDC Four-wire Addressable Base

Dual-color LED

To verify the detector has power and the heat detection circuitry functions, a dual-color LED indicator flashes green every 8 sec when operating normally. It flashes once every 4 sec when a trouble condition exists. The LED latches on red if an alarm occurs, allowing the user to easily verify individual detector alarms. Clear the alarm condition by interrupting power to the detector.

Tamper Detection

When detector heads are correctly installed in any of the F220-B6 bases, the control panel initiates a trouble signal if a detector is removed from its base. A mechanical tamper lock comes with each base to inhibit unauthorized head removal.

Supervision

The control panel supervises two-wire systems. Supervision of four-wire system power is provided by an end-of-line (EOL) power supervision device such as a D275, or an F220-B6E Power Supervision Mounting Base and an EOL resistor as specified by the control panel manufacturer.

Certifications and Approvals

Region	Certification	
Europe	CE	89/336/EEC, EN50130-4/A Sept 1998, EN61000-6-3 Oct 2001
USA	UL	UQGS: Heat - Automatic Fire Detectors (UL521), UQGS7: Heat - Automatic Fire Detectors Certified for Canada (cULus)
	FM	
	CSFM	7270-1615:108 July 2008
	NYC-MEA	117-05-E
	MSFM	2200 Sep 2008
Hong Kong	HKFSD	

Installation/Configuration Notes

Compatible Control Panels

Addressable Systems: compatible with addressable systems controlled by D9412GV2, D7412GV2, D9412G, or D7412G Control Panels or the D9124 Fire Alarm Control Panel when used with the F220-B6PM or F220-B6PS Addressable Detector Bases.

Two-wire: Bosch Security Systems, Inc. makes no claim written, oral, or implied that the F220 Heat Detectors work with any two-wire control panels except those specified in the Control Panel Compatibility chart in the Technical Service Note (P/N: 4998148185).

Four-wire: compatible with all UL Listed four-wire control panels. Refer to the control panel's installation instructions for proper end-of-line (EOL) resistor selection.

Mounting the Bases

Note Consult NFPA 72 for proper detector placement.

Depending on local regulations, the bases can be surface mounted directly on four-inch square or octagonal electrical boxes and single-gang switch boxes.

Note The volume of any electrical box used should be adequate to accommodate the number and size of conductors as specified by the National Electrical Code or any local authorities having jurisdiction (AHJ).

End-of-Line Power Supervision

Loop supervision requires one D275 or F220-B6E per loop when using F220-B6R/B6C bases and is accomplished by the control panel.

Wiring the Bases

Refer to the F220 Series Detectors with F220-B6/C/E/R Bases Installation Instructions (P/N: 4998138694), the F220 Series Detectors with F220-B6RS Bases Installation Instructions (P/N: F01U029847), or the F220-B6PS/M Installation Instructions (P/N: 4998149982) for detailed wiring instructions.

Technical Specifications

Environmental Considerations

Relative Humidity:	0% to 95% non-condensing
Temperature (normal operating):	+32°F to +100°F (0°C to +38°C)

Note: The normal environment where these detectors are installed should be within the specified normal operating temperature limits.

Mechanical Properties

Color:	White
Dimensions (diameter x H):	6.75 in. x 2.25 in. (17.1 cm x 6.4 cm)

Power Requirements

Current (alarm): (detector head only)	20 mA minimum at 8.5 VDC; 35 mA maximum at 32 VDC
Current (start-up):	0.12 mA maximum at 35 VDC
Maximum RMS Ripple:	25% of DC input
Power-up Time:	22 sec maximum

Voltage (standby)

F220-B6:	8.5 VDC to 32.0 VDC
F220-B6C/-B6R/-B6E:	10.0 VDC to 30.0 VDC

F220-B6RS:	16.0 VDC to 30.0 VDC
F220-B6PM:	18.9 VDC to 28.0 VDC
F220-B6PS:	With D299: 18.9 VDC to 28.0 VDC Without D299: 9.6 VDC to 28.0 VDC

Ordering Information

F220-135 Electronic Rate-of-Rise/Fixed Temperature (+135°F [+57°C]) Heat Detector Rate-of-rise/fixed temperature heat detector head only; requires base.	F220-135
F220-135F Electronic Fixed Temperature (+135°F [+57°C]) Heat Detector Fixed temperature heat detector head only; requires base.	F220-135F
F220-190F Electronic Fixed Temperature (+190°F [+88°C]) Heat Detector Fixed temperature heat detector head only; requires base.	F220-190F

Accessories

F220-B6 12/24 VDC Two-wire Base Standard base for two-wire (12 VDC or 24 VDC system) applications.	F220-B6
F220-B6R Standard 12/24 VDC Four-wire Base Standard base for four-wire (12 VDC or 24 VDC) detector systems.	F220-B6R
F220-B6RS 24 VDC Four-wire Detector Base with Sounder Four-wire detector base with sounder for use with the F220 Series Photoelectric Smoke and Heat Detectors.	F220-B6RS
F220-B6C 12/24 VDC Four-wire Base with Auxiliary Form C Relay Four-wire base with a normally-open (NO) alarm loop relay and a set of auxiliary contacts (Form C).	F220-B6C
F220-B6E 12/24 VDC Four-wire Power Supervision Base with End-of-line Power Monitoring Relay Four-wire base with a normally-open (NO) alarm relay and an EOL power supervision relay.	F220-B6E

F220-B6 Series Conventional Detector Bases



5

Features

- ▶ **Easy installation**
- ▶ **Interchangeable detector heads**
- ▶ **UL listed when used with an F220 Series detector**

The F220-B6 Series Detector Bases work with the F220 Series Photoelectric Smoke and Heat Detectors. The F220-B6 is a 12 V or 24 V base for two-wire loops. The other bases in this series are 12 V or 24 V bases for four-wire loops.

Certifications and Approvals

Region	Certification	
USA	UL	UQGS: Heat - Automatic Fire Detectors (UL521), UQGS7: Heat - Automatic Fire Detectors Certified for Canada (CAN/ULC-S530-M91), UROX: Smoke - Automatic Fire Detectors (UL268), UROX7: Smoke - Automatic Fire Detectors Certified for Canada (ULC529)
	FM	
	CSFM	1700-1615:105 July 2008
	NYC-MEA	(117-05-E)
	MSFM	2200 Sep 2008
Hong Kong	HKFSD	

Installation/Configuration Notes

Compatibility Information

Two-wire: Bosch Security Systems, Inc. makes no claim written, oral, or implied that the F220-B6 Series Detector Bases work with any two-wire control panels except those specified in the Two-wire Detector/Control Panel Compatibility List Technical Service Note (P/N: 4998148185).

Four-wire: Compatible with all UL Listed four-wire control panels. Refer to the control panel's Installation Instructions for proper end-of-line (EOL) resistor selection.

Detectors: Compatible with the following F220 Series Detector Heads:

- F220-P Photoelectric Smoke Detector
- F220-PTH Photoelectric Smoke Detector with +135°F (+57°C) Heat Sensor
- F220-PTHC¹ Photoelectric Smoke Detector with +135°F (+57°C) Heat Sensor and Carbon Monoxide Sensor Enhancement¹
- F220-135 Electronic Rate-of-Rise, Fixed Temperature +135°F (+57°C) Heat Detector
- F220-135F Electronic Fixed Temperature +135°F (+57°C) Heat Detector
- F220-190F Electronic Fixed Temperature +190°F (+88°C) Heat Detector

¹ The F220-PTHC detects carbon monoxide (CO) as a component of a fire. It is not a CO detector and cannot activate an alarm in the presence of CO only.

Mounting Considerations

Depending on local regulations, surface mount the bases using anchors, mollies, or wing nuts; or mount the bases directly on four-inch square or octagonal electrical boxes or single-gang switch boxes.

Note The electrical box must be large enough to accommodate the number and size of conductors specified by the National Electrical Code or any local authorities having jurisdiction (AHJ).

Wiring Considerations

In a two-wire system, the maximum loop length depends on the number of F220-B6 bases on the loop, the wire size, and the control panel specifications. Refer to the control panel's installation instructions for specific wiring information.

In a four-wire system, the maximum loop length and number of bases that can be placed on a loop depend on the voltage drop on the power circuit. Use standard voltage drop calculations to ensure that the last detector on the loop has at least 10 V.

Parts Included

Quant.	Component
1	Detector base
1	Literature pack

Technical Specifications

Environmental Considerations

Relative Humidity:	Up to 95%, non-condensing
Temperature (operating):	+32°F to +100°F (0°C to +38°C)

Mechanical Properties

Color:	Off-white
Dimensions (diameter x D)	6 in. x 0.9 in. (15.2 cm x 2.3 cm)
Material:	Fire-resistant plastic

Ordering Information

F220-B6 12/24 VDC Two-wire Base	F220-B6
Standard base for two-wire (12 VDC or 24 VDC system) applications.	
F220-B6R Standard 12/24 VDC Four-wire Base	F220-B6R
Standard base for four-wire (12 VDC or 24 VDC) detector systems.	
F220-B6C 12/24 VDC Four-wire Base with Auxiliary Form C Relay	F220-B6C
Four-wire base with a normally-open (NO) alarm loop relay and a set of auxiliary contacts (Form C).	
F220-B6E 12/24 VDC Four-wire Power Supervision Base with End-of-line Power Monitoring Relay	F220-B6E
Four-wire base with a normally-open (NO) alarm relay and an EOL power supervision relay.	

F220-B6RS 24 VDC Four-wire Detector Base with Sounder



5

Features

- ▶ **Easy installation**
- ▶ **Interchangeable detector heads**
- ▶ **UL listed when used with F220 Series Detector Heads**
- ▶ **UL464 approved sounder driven by the detector head or the NAC circuit**

The F220-B6RS 24 VDC Four-wire Detector Base with Sounder meets the requirements of UL464 for a notification device and works with the F220 Series Photoelectric Smoke and Heat Detectors. Power the sounder from the control panel's NAC circuit or from auxiliary power.

Functions

Sounder Configuration

The output (sound pattern and synchronization) of the sounders on a detection loop can be configured in four different ways. Refer to the *F220 Series Detectors Installation Instructions* (P/N: 4998138694) for instructions on wiring and setting the F220-B6RS detector base for these configurations:

1. **NAC Follower (Direct Wire) Configuration:** In this configuration, the sounders on the loop follow the signal on the NAC terminals as programmed at the control panel. Refer to the control panel's installation manual for NAC configuration instructions. This configuration requires an extra pair of supervised wires for the sounder circuit.

2. **Reverse Polarity Configuration:** In this configuration (not suitable for synchronized protocols; such as, Cooper Wheelock, Gentex, or System Sensor), the sounders in a loop activate due to reversed polarity on the power line. The output pattern is not controlled by the base in this operating mode; it follows the reversing power signal on the detector head's terminals as programmed at the control panel.
3. **Local Annunciation Configuration:** In this configuration, each sounder is individually set for one of the following patterns: Temporal (Code 3), March Time, or Continuous Tone. Use a D275 Power Supervision Module in this configuration to supervise the detector loop.
4. **Interconnection Configuration:** In this configuration, up to five detectors supervise the end of the detector loop when interconnected by a common wire. All sounders within the group activate together. Set all units for the same output pattern (Temporal [Code 3], March Time, or Continuous Tone). All interconnected detectors are synchronized with and sound the pattern of the originating detector. The maximum wire length for connecting up to five units is:

Wire Size	Wire Length
18 AWG (1.2 mm)	300 ft (91 m)
16 AWG (1.5 mm)	450 ft (137 m)
14 AWG (1.8 mm)	750 ft (229 m)

- Note** To ensure interconnected units can signal an alarm, the line load after the last detector on the interconnected detector loop must not exceed 10 mA.

Certifications and Approvals

Region	Certification
USA	UL ULSZ: Audible Signal Appliances (UL464), UROX: Smoke - Automatic Fire Detectors (UL268), UROX7: Smoke - Automatic Fire Detectors Certified for Canada (ULC-S529)
	FM
	CSFM 1700-1615: 105 July 2008
	NYC-MEA (117-05-E)

Installation/Configuration Notes

Compatibility Information

Four-wire: Compatible with all UL Listed four-wire control panels. Refer to the control panel's Installation Instructions for proper end-of-line (EOL) resistor selection.

Detectors: Compatible with the following F220 Series Detector Heads:

- F220-P Photoelectric Smoke Detector
- F220-PTH Photoelectric Smoke Detector with +135°F (+57°C) Heat Sensor

- F220-PTHC¹ Photoelectric Smoke Detector with +135°F (+57°C) Heat Sensor and Carbon Monoxide Sensor Enhancement¹
- F220-135 Electronic Rate-of-Rise, Fixed Temperature +135°F (+57°C) Heat Detector
- F220-135F Electronic Fixed Temperature +135°F (+57°C) Heat Detector
- F220-190F Electronic Fixed Temperature +190°F (+88°C) Heat Detector

¹ The F220-PTHC detects carbon monoxide (CO) as a component of a fire. It is not a CO detector and cannot activate an alarm in the presence of CO only.

Mounting Considerations

Depending on local regulations, surface mount the bases using anchors, mollies, or wing nuts, or mount directly on four-inch square or octagonal electrical boxes or single-gang switch boxes.

Note The electrical box must be large enough to accommodate the number and size of conductors specified by the National Electrical Code or any local authorities having jurisdiction (AHJ).

Wiring Considerations

In a four-wire system, the maximum loop length and number of bases that can be placed on a loop depend on the voltage drop on the power circuit. Use standard voltage drop calculations to ensure that the last detector on the loop has at least 16 V when all sounders and relays are powered.

Parts Included

Quant.	Component
1	Detector base
1	Literature pack

Technical Specifications

Environmental Considerations

Relative Humidity:	0 to 95%, non-condensing; 15% to 95%, non-condensing when used with CO sensor model
Temperature (operating):	+32°F to +100°F (0°C to +38°C)

Mechanical Properties

Color:	Off-white
Dimensions (diameter x thickness)	6 in. x 0.9 in. (15.2 cm x 2.3 cm)
Material:	Fire-resistant plastic

Outputs

Relay Type:	Normally-open (NO) Form A
Relay Rating:	0.5 A at 120 VDC or 120 VAC
Sounder Output:	>85 dB at 10 ft (3 m)

Power Requirements

Voltage Range:	16.0 VDC to 30 VDC
----------------	--------------------

Alarm Current

6-wire mode (4-wire base + two sounder power wires)

Relay:	The relay draws 15 mA in alarm.
--------	---------------------------------

Steady Sounder:	24 VDC: 30 mA 30 VDC: 35 mA
-----------------	--------------------------------

4-wire mode

With Steady Sounder and Relay:	24 VDC: 45 mA 30 VDC: 50 mA
--------------------------------	--------------------------------

Standby Current (base only):	30 VDC: 10 mA maximum
------------------------------	-----------------------

Ordering Information

F220-B6RS 24 VDC Four-wire Detector Base with Sounder

Four-wire detector base with sounder for use with the F220 Series Photoelectric Smoke and Heat Detectors.

F220-B6RS

ISN-CSTB-10 Compact Contacts (9.5 mm)



Features

- ▶ Closed loop
- ▶ Sensitive non-stick rhodium reed
- ▶ Bent long leads keep solder off the glass of the reed
- ▶ Two solder points on the wire
- ▶ Thick plastic shell resists crushing

The contacts are available in brown or white. Both models have a rugged, one-piece construction that eliminates the need for extra donut adapters. The compact (stubby) design allows you to use the contact in smaller spaces, without paying for a miniature design. Use in standard or tight-fitting applications.

Certifications and Approvals

UL and CE

Region	Certification
Europe	CE 73/23/EEC and 93/68/EEC, EN50131: 1997, EN50131-6: 1997, EN60950: 2000, EN60335-1: 1994 +A1: 1996 Annex B

Installation/Configuration Notes

Compatibility Information

All contact models are compatible with control panel models that accept contact inputs.

Parts Included

Quantity Per Package	Component
10	Contacts
10	Magnets

Technical Specifications

Specifications for all Models

Gap Width:	12.7 mm (0.5 in.)
Contact Dimensions:	9.5 mm x 19 mm (0.375 in. x 0.75 in.)
Wire Lead Type:	0.8 mm (0.029 in.) 22 AWG, 7 strand- ed
Wire Lead Length:	46 cm (18 in.) standard leads
Switch Configuration Type:	Single pole single throw (SPST)
Maximum Contact Resistance:	150 $\mu\Omega$ (micro-ohm)
Minimum Breakdown Voltage:	250 VDC
Insulation Resistance:	$10^{10} \Omega$
Electrostatic Cap:	0.3 PF
Contact Capacity:	10 VAC
Maximum Conductive Current:	1.0 A
Maximum Voltage:	100 V
Operating Temperature Range:	7.2°C to -95.56°C (-45°F to -140°F)

Package Information

ATTENTION! Each package contains ten contacts and ten magnets.

Ordering Information

Brown Compact Contact Brown recessed contact with 9.5 mm (0.375 in.) diameter. Package contains ten contacts and ten magnets.	ISN-CSTB-10B
White Compact Contact White recessed contact with 9.5 mm (0.375 in.) diameter. Package contains ten contacts and ten magnets.	ISN-CSTB-10W

ISN-CSTB-10DM Contacts with Thin Magnet (9.5 mm)



Features

- ▶ Closed loop
- ▶ Ideal for tight-fitting window frames where you cannot drill a hole for the magnet
- ▶ Convex hole fits flat head screws flush
- ▶ Thin magnet

The contacts are available in brown or white. Both models include a thin magnet. Use on window frames in tight-fitting applications.

Certifications and Approvals

UL and CE

Region	Certification
Europe	CE 73/23/EEC and 93/68/EEC, EN50131: 1997, EN50131-6: 1997, EN60950: 2000, EN60335-1: 1994 +A1: 1996 Annex B

Installation/Configuration Notes

Compatibility Information

All contact models are compatible with control panel models that accept contact inputs.

Parts Included

Quantity Per Package	Component
10	Contacts
10	Magnets

Technical Specifications

Specifications for All Models

Gap Width:	12.7 mm (0.5 in.)
Contact Dimensions:	9.5 mm x 19 mm (0.375 in. x 0.75 in.)
Magnet Dimensions:	3.2 mm x 9.5 mm (0.125 in. x 0.375 in.)
Wire Lead Type:	0.8 mm (0.029 in.) 22 AWG, 7 stranded
Wire Lead Length:	46 cm (18 in.)
Switch Configuration Type:	Single pole single throw (SPST)
Maximum Contact Resistance:	150 μΩ (micro-ohm)
Minimum Breakdown Voltage:	250 VDC
Insulation Resistance:	10 ¹⁰ Ω
Electrostatic Cap:	0.3 PF
Contact Capacity:	10 VAC
Maximum Conductive Current:	1.0 A
Maximum Voltage:	100 V
Operating Temperature Range:	7.2°C to -95.56°C (-45°F to -140°F)

Package Information

ATTENTION! Each package contains ten contacts and ten magnets.

Ordering Information

Brown Contact with Thin Magnet Brown recessed contact with 9.5 mm (0.375 in.) diameter. Includes a thin magnet. Package contains ten contacts and ten magnets.	ISN-CSTB-10DMB
White Contact with Thin Magnet White recessed contact with 9.5 mm (0.375 in.) diameter. Includes a thin magnet. Package contains ten contacts and ten magnets.	ISN-CSTB-10DMW

ISN-CSTB-TC Terminal Connection Contacts (16 mm)



5

Features

- ▶ Closed loop
- ▶ Terminal connection design
- ▶ Does not require soldering or splicing
- ▶ No need to push B-Connectors (beanies) behind walls through small holes

The contacts are available in brown or white. All models have a compact, short magnet with an adhesive strip and are designed with a terminal connection for fast and easy installation. Use on window frames.

Note The photograph shows model ISN-CSTB-TCFW.

Functions

UL and CE

Certifications and Approvals

Region	Certification
Europe	CE 73/23/EEC and 93/68/EEC, EN50131: 1997, EN50131-6: 1997, EN60950: 2000, EN60335-1: 1994 +A1: 1996 Annex B

Installation/Configuration Notes

Compatibility Information

All contact models are compatible with control panel models that accept contact inputs.

Parts Included

Quantity Per Package	Component
10	Contacts
10	Magnets

Technical Specifications

Specifications for All Models

Gap Width:	16 mm (0.625 in.)
Contact Dimensions:	9.5 mm x 25 mm (0.375 in. x 1 in.)
Switch Configuration Type:	Single pole single throw (SPST)
Maximum Contact Resistance:	150 $\mu\Omega$ (micro-ohm)
Minimum Breakdown Voltage:	250 VDC
Insulation Resistance:	10 ¹⁰ Ω
Electrostatic Cap:	0.3 PF
Contact Capacity:	10 VAC
Maximum Conductive Current:	1.0 A
Maximum Voltage:	100 V
Operating Temperature Range:	7.2°C to -95.56°C (-45°F to -140°F)

Specifications for ISN-CSTB-TCB/W Models

Standard Magnet Dimensions (W x L): 14.8 mm x 9 mm (0.58 in. x 0.36 in.)

Specifications for ISN-CSTB-TCFB/W Models

Bare Thin Magnet Dimensions (W x L): 3.2 mm x 9 mm (0.125 in. x 0.36 in.)

Package Information

ATTENTION! Each package contains ten contacts and ten magnets.

Ordering Information**Brown Terminal Connection Contact** **ISN-CSTB-TCB**

Brown recessed contact with 9.5 mm (0.375 in.) diameter. Includes standard magnet. **Package contains ten contacts and ten magnets.**

White Terminal Connection Contact **ISN-CSTB-TCW**

White recessed contact with 9.5 mm (0.375 in.) diameter. Includes standard magnet. **Package contains ten contacts and ten magnets.**

Brown Terminal Connection Contact with Flat Magnet **ISN-CSTB-TCFB**

Brown recessed contact with 9.5 mm (0.375 in.) diameter. Includes a smaller flat magnet for tight-fitting applications. **Package contains ten contacts and ten magnets.**

White Terminal Connection Contact with Flat Magnet **ISN-CSTB-TCFW**

White recessed contact with 9.5 mm (0.375 in.) diameter. Includes a smaller flat magnet for tight-fitting applications. **Package contains ten contacts and ten magnets.**

ISN-CTC75 Terminal Connection Contacts (19 mm)



5

Features

- ▶ Closed loop
- ▶ Terminal connection design
- ▶ Does not require soldering or splicing
- ▶ Steel door recess type

The contacts are available in brown or white. Both models use a compact magnet and are designed with a terminal connection for fast and easy installation. Use on steel doors in standard or tight-fitting applications.

Certifications and Approvals

UL and CE

Region	Certification
Europe	CE 73/23/EEC and 93/68/EEC, EN50131: 1997, EN50131-6: 1997, EN60950: 2000, EN60335-1: 1994 +A1: 1996 Annex B

Installation/Configuration Notes

Compatibility Information

All contact models are compatible with control panel models that accept contact inputs.

Parts Included

Quantity Per Package	Component
10	Contacts
10	Magnets

Technical Specifications

Specifications for All Models

Gap Width:	25 mm (1 in.)
Contact Dimensions:	19 mm x 30 mm (0.75 in. x 1.18 in.)
Switch Configuration Type:	Single pole single throw (SPST)
Maximum Contact Resistance:	150 $\mu\Omega$ (micro-ohm)
Minimum Breakdown Voltage:	250 VDC
Insulation Resistance:	$10^{10} \Omega$
Electrostatic Cap:	0.3 PF
Contact Capacity:	10 VAC
Maximum Conductive Current:	1.0 A
Maximum Voltage:	100 V
Operating Temperature Range:	7.2°C to -95.56°C (-45°F to -140°F)

Package Information

ATTENTION! Each package contains ten contacts and ten magnets.

Ordering Information

Brown Terminal Connection Contact ISN-CTC75-B
Brown recessed contact with 19 mm (0.75 in.) diameter. **Package contains ten contacts and ten magnets.**

White Terminal Connection Contact ISN-CTC75-W
White recessed contact with 19 mm (0.75 in.) diameter. **Package contains ten contacts and ten magnets.**

ISN-CTAP-10 Contacts (9.5 mm)



Features

- ▶ Closed loop
- ▶ Includes a magnet

The contacts are available in brown or white. All models include a magnet and have a 9.5 mm (0.375 in.) diameter.

Note The photograph shows model ISN-CTAP-10W.

Certifications and Approvals

UL and CE

Region	Certification
Europe	CE 73/23/EEC and 93/68/EEC, EN50131: 1997, EN50131-6: 1997, EN60950: 2000, EN60335-1: 1994 +A1: 1996 Annex B

Installation/Configuration Notes

Compatibility Information

All contact models are compatible with control panel models that accept contact inputs.

Parts Included

Quantity Per Package	Component
10	Contacts
10	Magnets

Technical Specifications

Specifications for All Models

Gap Width:	19 mm (0.75 in.)
Contact Dimensions:	9.5 mm x 31.75 mm (0.375 in. x 1.25 in.)
Wire Lead Type:	0.8 mm (0.029 in.) 22 AWG, 7 stranded
Wire Lead Length:	46 cm (18 in.) standard leads
Switch Configuration Type:	Single pole single throw (SPST)
Maximum Contact Resistance:	150 μΩ (micro-ohm)
Minimum Breakdown Voltage:	250 VDC
Insulation Resistance:	10 ¹⁰ Ω
Electrostatic Cap:	0.3 PF
Contact Capacity:	10 VAC
Maximum Conductive Current:	1.0 A
Maximum Voltage:	100 V
Operating Temperature Range:	7.2°C to -95.56°C (-45°F to -140°F)

Specifications for Flange ISN-CTAP-FMB/W Models

Flange Dimensions (L x W):	14.2 mm x 19.1 mm (0.562 in. x 0.750 in.)
----------------------------	-------------------------------------------

Package Information

ATTENTION! Each package contains ten contacts and ten magnets.

Ordering Information

Brown Contact with Flat Magnet Brown recessed contact with 9.5 mm (0.375 in.) diameter. Includes a flat magnet. Package contains ten contacts and ten magnets.	ISN-CTAP-10FB
White Contact with Flat Magnet White recessed contact with 9.5 mm (0.375 in.) diameter. Includes a flat magnet. Package contains ten contacts and ten magnets.	ISN-CTAP-10FW
Brown Contact with Standard Magnet Brown recessed contact with 9.5 mm (0.375 in.) diameter. Includes a standard magnet. Package contains ten contacts and ten magnets.	ISN-CTAP-10B
White Contact with Standard Magnet White recessed contact with 9.5 mm (0.375 in.) diameter. Includes a standard magnet. Package contains ten contacts and ten magnets.	ISN-CTAP-10W
Brown Flange Contact with Standard Magnet Brown recessed contact with 9.5 mm (0.375 in.) diameter and flange design. Includes a standard magnet. Package contains ten contacts and ten magnets.	ISN-CTAP-FMB

Ordering Information

White Flange Contact with Standard Magnet **ISN-CTAP-FMW**

White recessed contact with 9.5 mm (0.375 in.) diameter and flange design. Includes a standard magnet. **Package contains ten contacts and ten magnets.**

ISN-CTAP-15 Contacts (6.35 mm)



Features

- ▶ Closed loop
- ▶ Long leads available

The contacts are available in brown or white.

Certifications and Approvals

UL and CE

Region	Certification
Europe	CE 73/23/EEC and 93/68/EEC, EN50131: 1997, EN50131-6: 1997, EN60950: 2000, EN60335-1: 1994 +A1: 1996 Annex B

Installation/Configuration Notes

Compatibility Information

All contact models are compatible with control panel models that accept contact inputs.

Parts Included

Quantity Per Package	Component
10	Contacts
10	Magnets

Technical Specifications

Specifications for All Models

Gap Width:	19 mm (0.75 in.)
Contact Dimensions:	6.35 mm x 25 mm (0.25 in. x 1 in.)
Wire Lead Type:	0.8 mm (0.029 in.) 22 AWG, 7 strand- ed
Wire Lead Length:	46 cm (18 in.) standard leads
Switch Configuration Type:	Single pole single throw (SPST)
Maximum Contact Resistance:	150 $\mu\Omega$ (micro-ohm)
Minimum Breakdown Voltage:	250 VDC
Insulation Resistance:	$10^{10} \Omega$
Electrostatic Cap:	0.3 PF
Contact Capacity:	10 VAC
Maximum Conductive Current:	1.0 A
Maximum Voltage:	100 V
Operating Temperature Range:	7.2°C to -95.56°C (-45°F to -140°F)

Package Information

ATTENTION! Each package contains ten contacts and ten magnets.

Ordering Information

Brown Contact with Standard Magnet **ISN-CTAP-15B**
Brown recessed contact with 6.35 mm (0.25 in.) diameter. Includes a standard magnet. **Package contains ten contacts and ten magnets.**

White Contact with Standard Magnet **ISN-CTAP-15W**
White recessed contact with 6.35 mm (0.25 in.) diameter. Includes a standard magnet. **Package contains ten contacts and ten magnets.**

ISN-CRFM-25 Oval Flange Contacts (6.35 mm)



5

Features

- ▶ **Closed loop**
- ▶ **Ideal for fitting in a track where a regular 6.5 mm (0.25 in.) contact would fall through**

The contacts are available in brown or white. All models have an oval flange design.

Certifications and Approvals

UL and CE

Region	Certification	
Europe	CE	73/23/EEC and 93/68/EEC, EN50131: 1997, EN50131-6: 1997, EN60950: 2000, EN60335-1: 1994 +A1: 1996 Annex B

Installation/Configuration Notes

Compatibility Information

All contact models are compatible with control panel models that accept contact inputs.

Parts Included

Quantity Per Package	Component
10	Contacts
10	Magnets

Technical Specifications

Specifications for All Models

Gap Width:	19 mm (0.75 in.)
Contact Dimensions:	6.35 mm x 25 mm (0.25 in. x 1 in.)
Oval Flange Dimension:	9.5 mm (0.375 in.)
Wire Lead Type:	0.8 mm (0.029 in.) 22 AWG, 7 strand-ed
Wire Lead Length:	46 cm (18 in.) standard leads
Switch Configuration Type:	Single pole single throw (SPST)
Maximum Contact Resistance:	150 $\mu\Omega$ (micro-ohm)
Minimum Breakdown Voltage:	250 VDC
Insulation Resistance:	$10^{10} \Omega$
Electrostatic Cap:	0.3 PF
Contact Capacity:	10 VAC
Maximum Conductive Current:	1.0 A
Maximum Voltage:	100 V
Operating Temperature Range:	7.2°C to -95.56°C (-45°F to -140°F)

Package Information

ATTENTION! Each package contains ten contacts and ten magnets.

Ordering Information

Brown Oval Flange Contact with Standard Magnet ISN-CRFM-25B

Brown recessed contact with 6.35 mm (0.25 in.) diameter and oval flange design. Includes a standard magnet. **Package contains ten contacts and ten magnets.**

White Oval Flange Contact with Standard Magnet ISN-CRFM-25W

White recessed contact with 6.35 mm (0.25 in.) diameter and oval flange design. Includes a standard magnet. **Package contains ten contacts and ten magnets.**

ISN-CMINI-10 Miniature Contacts (9.5 mm)



Features

- ▶ Closed loop
- ▶ Ideal for window frames, thin door frames, or security screens
- ▶ Versatile

The contacts are available in brown or white. All models have a true miniature design and are shorter than compact design contacts. Use on window frames, thin door frames, or security screens.

Certifications and Approvals

UL and CE

Region	Certification
Europe	CE 73/23/EEC and 93/68/EEC, EN50131: 1997, EN50131-6: 1997, EN60950: 2000, EN60335-1: 1994 +A1: 1996 Annex B

Installation/Configuration Notes

Compatibility Information

All contact models are compatible with control panel models that accept contact inputs.

Parts Included

Quantity Per Package	Component
10	Contacts
10	Magnets

Technical Specifications

Specifications for All Models

Gap Width:	12.7 mm to 25 mm (0.5 in. to 1 in.)
Contact Dimensions:	9.5 mm x 43 mm (0.375 in. x 1.7 in.)
Wire Lead Type:	0.8 mm (0.029 in.) 22 AWG, 7 stranded
Wire Lead Length:	46 cm (18 in.) standard leads
Switch Configuration Type:	Single pole single throw (SPST)
Maximum Contact Resistance:	150 μΩ (micro-ohm)
Minimum Breakdown Voltage:	200 VDC
Insulation Resistance:	10 ⁹ Ω
Electrostatic Cap:	1.5 PF
Contact Capacity:	3 VAC
Maximum Conductive Current:	0.5 A
Maximum Voltage:	30 V
Operating Temperature Range:	7.2°C to -95.56°C (-45°F to -140°F)

Package Information

ATTENTION! Each package contains ten contacts and ten magnets.

Ordering Information

Brown Miniature Recess Contact Brown recessed contact with 9.5 mm (0.375 in.) diameter. Package contains ten contacts and ten magnets.	ISN-CMINI-10B
White Miniature Recess Contact White recessed contact with 9.5 mm (0.375 in.) diameter. Package contains ten contacts and ten magnets.	ISN-CMINI-10W

ISN-CMINI-10D Miniature Contacts with Thin Magnet (9.5 mm)



5

Features

- ▶ Closed loop
- ▶ Ideal for tight-fitting applications
- ▶ Versatile

The contacts are available in brown or white. All models have a true miniature design and are shorter than compact design contacts. All models include a powerful, thin magnet. The magnet has a convex hole that allows flat head screws to fit flush. Use on window frames or door frames in tight-fitting applications.

Certifications and Approvals

UL and CE

Region	Certification
Europe	CE 73/23/EEC and 93/68/EEC, EN50131: 1997, EN50131-6: 1997, EN60950: 2000, EN60335-1: 1994 +A1: 1996 Annex B

Installation/Configuration Notes

Compatibility Information

All contact models are compatible with control panel models that accept contact inputs.

Parts Included

Quantity Per Package	Component
10	Contacts
10	Magnets

Technical Specifications

Specifications for All Models

Gap Width:	12.7 mm (0.5 in.)
Contact Dimensions:	9.5 mm x 15.2 mm (0.375 in. x 0.6 in.)
Magnet Dimensions:	9.5 mm x 3 mm (0.375 in. x 0.125 in.)
Wire Lead Type:	0.8 mm (0.029 in.) 22 AWG, 7 strand-ed
Wire Lead Length:	46 cm (18 in.) standard leads
Switch Configuration Type:	Single pole single throw (SPST)
Maximum Contact Resistance:	150 $\mu\Omega$ (micro-ohm)
Minimum Breakdown Voltage:	200 VDC
Insulation Resistance:	10 ⁹ Ω
Electrostatic Cap:	1.5 PF
Contact Capacity:	3 VAC
Maximum Conductive Current:	0.5 A
Maximum Voltage:	30 V
Operating Temperature Range:	7.2°C to -95.56°C (-45°F to -140°F)

Package Information

ATTENTION! Each package contains ten contacts and ten magnets.

Ordering Information

Brown Miniature Contact with Thin Magnet Brown recessed contact with 9.5 mm (0.375 in.) diameter. Includes a thin magnet. Package contains ten contacts and ten magnets.	ISN-CMINI-10DB
White Miniature Contact with Thin Magnet White recessed contact with 9.5 mm (0.375 in.) diameter. Includes a thin magnet. Package contains ten contacts and ten magnets.	ISN-CMINI-10DW

ISN-CMINI-15 Miniature Contacts (6.35 mm)



Features

- ▶ Closed loop
- ▶ Ideal for screens

The contacts are available in brown or white. Both models have a true miniature design and are shorter than compact design contacts. Use on screens.

Certifications and Approvals

UL and CE

Region	Certification
Europe	CE 73/23/EEC and 93/68/EEC, EN50131: 1997, EN50131-6: 1997, EN60950: 2000, EN60335-1: 1994 +A1: 1996 Annex B

Installation/Configuration Notes

Compatibility Information

All contact models are compatible with control panel models that accept contact inputs.

Parts Included

Quantity Per Package	Component
10	Contacts
10	Magnets

Technical Specifications

Specifications for All Models

Gap Width:	12.7 mm (0.5 in.)
Contact Dimensions:	6.35 mm x 15.2 mm (0.25 in. x 0.6 in.)
Wire Lead Type:	0.8 mm (0.029 in.) 22 AWG, 7 strand-ed, or 26 AWG
Wire Lead Length:	46 cm (18 in.)
Switch Configuration Type:	Single pole single throw (SPST)
Maximum Contact Resistance:	150 μΩ (micro-ohm)
Minimum Breakdown Voltage:	200 VDC
Insulation Resistance:	10 ⁹ Ω
Electrostatic Cap:	1.5 PF
Contact Capacity:	3 VAC
Maximum Conductive Current:	0.5 A
Maximum Voltage:	30 V
Operating Temperature Range:	7.2°C to -95.56°C (-45°F to -140°F)

Package Information

ATTENTION! Each package contains ten contacts and ten magnets.

Ordering Information

Brown Miniature Contact Brown recessed contact with 6.35 mm (0.25 in.) diameter. Package contains ten contacts and ten magnets.	ISN-CMINI-15B
White Miniature Contact White recessed contact with 6.35 mm (0.25 in.) diameter. Package contains ten contacts and ten magnets.	ISN-CMINI-15W

ISN-C22 Compact Ball Reed Contacts



5

Features

- ▶ Closed loop
- ▶ Includes spacer and screws
- ▶ Shorter length for tight-fitting areas

The contacts are available in brown or white. All models have a flange design.

Note The photograph shows model ISN-C22-W.

Certifications and Approvals

UL and CE

Region	Certification
Europe	CE 73/23/EEC and 93/68/EEC, EN50131: 1997, EN50131-6: 1997, EN60950: 2000, EN60335-1: 1994 +A1: 1996 Annex B

Installation/Configuration Notes

Compatibility Information

All contact models are compatible with control panel models that accept contact inputs.

Parts Included

Quantity Per Package	Component
10	Assemblies (contacts, spacers, and screws)

Technical Specifications

Specifications for All Models

Gap Width:	6.7 mm (0.25 in.)
Contact Dimensions:	19 mm x 25 mm x 25 mm (0.75 in. x 1 in. x 1 in.)
Flange Width:	4.5 cm (1.75 in.)
Flange Thickness:	1.5 mm (0.06 in.)
Switch Configuration Type:	Single pole single throw (SPST)
Maximum Contact Resistance:	150 $\mu\Omega$ (micro-ohm)
Minimum Breakdown Voltage:	250 VDC
Insulation Resistance:	10 ¹⁰ Ω
Electrostatic Cap:	0.3 PF
Contact Capacity:	10 VAC
Maximum Conductive Current:	1.0 A
Maximum Voltage:	100 V
Operating Temperature Range:	7.2°C to -95.56°C (-45°F to -140°F)

Specifications for ISN-C22-B/W Models

Wire Lead Type:	0.8 mm (0.029 in.) 22 AWG, 7 stranded
Wire Lead Length:	46 cm (18 in.)
Length (From Flange to End):	2 cm (0.75 in.)

Specifications for ISN-22-TB/W Models

Length (From Flange to End of Terminals): 2.8 cm (1.16 in.)

Package Information

ATTENTION! Each package contains ten assemblies with contacts, spacers, and screws.

Ordering Information

Brown Compact Ball Reed Contact Brown contact with flange design and standard 46 cm (18 in.) leads. Package contains ten assemblies with contacts, spacers, and screws.	ISN-C22-B
White Compact Ball Reed Contact White contact with flange design and standard 46 cm (18 in.) leads. Package contains ten assemblies with contacts, spacers, and screws.	ISN-C22-W
Brown Terminal Connection Compact Ball Reed Contact Brown contact with flange design and terminal connection for faster installation. Package contains ten assemblies with contacts, spacers, and screws.	ISN-C22-TB
White Terminal Connection Compact Ball Reed Contact White contact with flange design and terminal connection for faster installation. Package contains ten assemblies with contacts, spacers, and screws.	ISN-C22-TW

ISN-CPB52 Reed Plunger Contacts



Features

- ▶ Closed loop
- ▶ Ideal for replacing old mechanical contacts
- ▶ Ideal for doorjamb
- ▶ Includes spacers and screws

The contacts are available in brown or white. Use on doorjamb or to replace older contacts.

Note The photograph shows model ISN-CPB52-W (wire lead) and ISN-CPB52-TCW (terminal connection).

Certifications and Approvals

UL and CE

Region	Certification
Europe	CE 73/23/EEC and 93/68/EEC, EN50131: 1997, EN50131-6: 1997, EN60950: 2000, EN60335-1: 1994 +A1: 1996 Annex B

Installation/Configuration Notes

Compatibility Information

All contact models are compatible with control panel models that accept contact inputs.

Parts Included

Quantity Per Package	Component
10	Assemblies (contacts, spacers, and screws)

Technical Specifications

Specifications for All Models

Gap Width:	1.6 mm to 2.6 mm (0.06 in. x 0.10 in.) Push in the reed plunger to 1.6 mm (0.06 in) without activating contacts. Push in the reed plunger to 2.6 mm and the contacts activate.
Flange Dimensions:	25 mm x 45 mm (1 in. x 1.28 in.)
Switch Configuration Type:	Single pole single throw (SPST)
Maximum Contact Resistance:	150 μΩ (micro-ohm)
Minimum Breakdown Voltage:	250 VDC
Insulation Resistance:	10 ¹⁰ Ω
Electrostatic Cap:	0.3 PF
Contact Capacity:	10 VAC
Maximum Conductive Current:	1.0 A
Maximum Voltage:	100 V
Operating Temperature Range:	7.2°C to -95.56°C (-45°F to -140°F)

Specifications for ISN-CPB52-B/W Models

Contact Dimensions:	12.7 mm x 34 mm (0.5 in. x 1.34 in.)
Wire Lead Type:	0.8 mm (0.029 in.) 22 AWG, 7 strand-ed
Wire Lead Length:	46 cm (18 in.)

Specifications for ISN-CPB52-TCB/W Models

Contact Dimensions:	19 mm x 44 mm (0.75 in. x 1.73 in.)
---------------------	-------------------------------------

Package Information

ATTENTION! Each package contains ten assemblies with contacts, spacers, and screws.

Ordering Information**Brown Reed Plunger Contact****ISN-CPB52-B**

Brown recessed contact with wire lead connection design and 46 cm (18 in.) leads. **Package contains ten assemblies with contacts, spacers, and screws.**

White Reed Plunger Contact**ISN-CPB52-W**

White recessed contact with wire lead connection design and 46 cm (18 in.) leads. **Package contains ten assemblies with contacts, spacers, and screws.**

Brown Reed Plunger Terminal Connection Contact**ISN-CPB52-TCB**

Brown recessed contact with terminal connection design for faster installation. **Package contains ten assemblies with contacts, spacers, and screws.**

White Reed Plunger Terminal Connection Contact**ISN-CPB52-TCW**

White recessed contact with terminal connection design for faster installation. **Package contains ten assemblies with contacts, spacers, and screws.**

ISN-CAS Adjustable Screw Head Contacts



Features

- ▶ Closed loop
- ▶ Tamper switch
- ▶ Adjustable gap width

The contacts are available in brown or white. Both models are tamper switches and have an adjustable screw for easily adjusting gap width.

Certifications and Approvals

UL and CE

Region	Certification
Europe	CE 73/23/EEC and 93/68/EEC, EN50131: 1997, EN50131-6: 1997, EN60950: 2000, EN60335-1: 1994 +A1: 1996 Annex B

Installation/Configuration Notes

Compatibility Information

All contact models are compatible with control panel models that accept contact inputs.

Parts Included

Quantity Per Package	Component
10	Contacts

Technical Specifications

Specifications for All Models

Gap Width:	1.6 mm to 2.6 mm (0.06 in. x 0.10 in.) Push in the reed plunger up to 1.6 mm (0.06 in.) without activating contacts. Push in the reed plunger to 2.6 mm and the contacts must activate.
Contact Dimensions without Screws:	9.5 mm x 31 mm (0.375 in. x 1.25 in.)
Screw Length	6 mm (0.2 in) or 10 mm (0.4 in.)
Wire Lead Type:	0.8 mm (0.029 in.) 22 AWG, 7 strand-ed
Wire Lead Length:	46 cm (18 in.)
Switch Configuration Type:	Single pole single throw (SPST)
Maximum Contact Resistance:	150 μΩ (micro-ohm)
Minimum Breakdown Voltage:	250 VDC
Insulation Resistance:	10 ¹⁰ Ω
Electrostatic Cap:	0.3 PF
Contact Capacity:	10 VAC
Maximum Conductive Current:	1.0 A
Maximum Voltage:	100 V
Operating Temperature Range:	7.2°C to -95.56°C (-45°F to -140°F)

Package Information

ATTENTION! Each package contains ten contacts.

Ordering Information

Brown Adjustable Screw Head Contact Brown recessed contact. Package contains ten contacts.	ISN-CAS-B
White Adjustable Screw Head Contact White recessed contact. Package contains ten contacts.	ISN-CAS-W

ISN-CRB32 Roller Ball Contacts



5

Features

- ▶ Closed loop
- ▶ Includes spacer and screws
- ▶ Thin end for easy installation
- ▶ Includes deactivated rhodium reed switch

The contacts are available in brown or white. Both models have a special compressed plastic ball to resist accumulated dirt or paint. The contact design also includes a flange.

Certifications and Approvals

UL and CE

Region	Certification
Europe	CE 73/23/EEC and 93/68/EEC, EN50131: 1997, EN50131-6: 1997, EN60950: 2000, EN60335-1: 1994 +A1: 1996 Annex B

Installation/Configuration Notes

Compatibility Information

All contact models are compatible with control panel models that accept contact inputs.

Parts Included

Quantity Per Package	Component
10	Assemblies (contacts, spacers, screws, and reed switches)

Technical Specifications

Specifications for All Models

Contact Dimensions without Screws:	19 mm x 41.27 mm (0.75 in. x 1.625 in.)
Wire Lead Type:	0.8mm (0.029 in.) 22AWG, 7 strand-ed
Wire Lead Length:	46 cm (18 in.)
Switch Configuration Type:	Single pole single throw (SPST)
Maximum Contact Resistance:	150 $\mu\Omega$ (micro-ohm)
Minimum Breakdown Voltage:	250 VDC
Insulation Resistance:	$10^{10} \Omega$
Electrostatic Cap:	0.3 PF
Contact Capacity:	10 VAC
Maximum Conductive Current:	1.0 A
Maximum Voltage:	100 V
Operating Temperature Range:	7.2°C to -95.56°C (-45°F to -140°F)

Package Information

ATTENTION! Each package contains ten assemblies with contacts, spacers, screws, and reed switches.

Ordering Information

Brown Roller Ball Contact Brown recessed contact. Package contains ten assemblies with contacts, spacers, screws, and reed switches.	ISN-CRB32-B
White Roller Ball Contact White recessed contact. Package contains ten assemblies with contacts, spacers, screws, and reed switches.	ISN-CRB32-W

ISN-CSD70 and ISN-CSD80 Compact Contacts



Features

- ▶ Closed loop
- ▶ Sensitive non-stick rhodium reed
- ▶ Bent long leads keep solder off the glass of the reed
- ▶ Two solder points on the wire
- ▶ Thick plastic shell resists crushing

The contacts are available in brown or white. All models have a rugged, one-piece construction that eliminates the need for extra donut adapters. The compact (stubby) design allows you to use the contact in smaller spaces, without paying for a miniature design. Use on steel doors in standard or tight-fitting applications.

Note The photograph shows model ISN-CSD80-W.

Certifications and Approvals

UL and CE

Region	Certification
Europe	CE 73/23/EEC and 93/68/EEC, EN50131: 1997, EN50131-6: 1997, EN60950: 2000, EN60335-1: 1994 +A1: 1996 Annex B

Installation/Configuration Notes

Compatibility Information

All contact models are compatible with control panel models that accept contact inputs.

Parts Included

Quantity Per Package	Component
10	Contacts
10	Magnets

Technical Specifications

Specifications for All Models

Gap Width:	38 mm (1.5 in.)
Wire Lead Type:	0.8 mm (0.029 in.) 22 AWG, 7 strand-ed
Wire Lead Length:	46 cm (18 in.) standard leads
Switch Configuration Type:	Single pole single throw (SPST)
Operating Temperature Range:	7.2°C to -95.56°C (-45°F to -140°F)

Specifications for ISN-CSD70-B/W Models

Contact Dimensions:	19 mm x 20.3 mm (0.75 in. x 0.80 in.)
Maximum Contact Resistance:	150 μΩ (micro-ohm)
Minimum Breakdown Voltage:	250 VDC
Insulation Resistance:	10 ¹⁰ Ω
Electrostatic Cap:	0.3 PF
Contact Capacity:	10 VAC
Maximum Conductive Current:	1.0 A
Maximum Voltage:	100 V

Specifications for ISN-CSD80-B/W Models

Contact Dimensions:	25 mm x 20 mm (1 in. x 0.80 in.)
Maximum Contact Resistance:	150 μΩ (micro-ohm)
Minimum Breakdown Voltage:	250 VDC
Insulation Resistance:	10 ¹⁰ Ω
Electrostatic Cap:	0.3 PF
Contact Capacity:	10 VAC
Maximum Conductive Current:	1.0 A
Maximum Voltage:	100 V

Package Information

ATTENTION! Each package contains ten contacts and ten magnets.

Ordering Information**Brown Compact Contact with Standard Magnet (19 mm) ISN-CSD70-B**

Brown recessed contact with 19 mm (0.75 in.) diameter. Includes a standard magnet. **Package contains ten contacts and ten magnets.**

White Compact Contact with Standard Magnet (19 mm) ISN-CSD70-W

White recessed contact with 19 mm (0.75 in.) diameter. Includes a standard magnet. **Package contains ten contacts and ten magnets.**

Brown Compact Contact with Standard Magnet (25 mm) ISN-CSD80-B

Brown recessed contact with 25 mm (1 in.) diameter. Includes a standard magnet. **Package contains ten contacts and ten magnets.**

White Compact Contact with Standard Magnet (25 mm) ISN-CSD80-W

White recessed contact with 25 mm (1 in.) diameter. Includes standard magnet. **Package contains ten contacts and ten magnets.**

EMK 46 S Z Flush-Mount Magnetic Contact

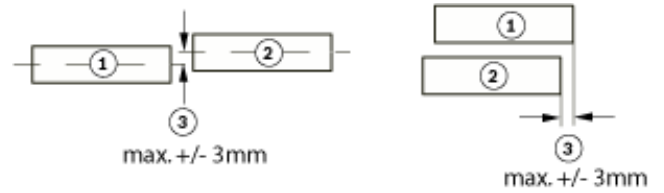

- 1 Contact
- 2 Magnet
- 3 Installation offset

Distances diagram

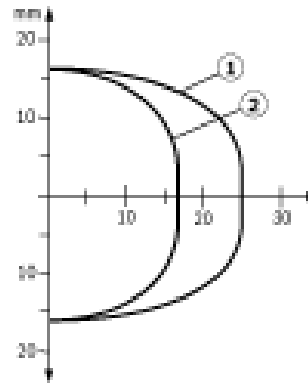

- 1 Extraction
 - 2 Proximity switch part
- Note: If the attached magnets are touching each other, there will be no tamper zone!

Features

- ▶ Conventional flush-mount magnetic contact
- ▶ VdS class C
- ▶ Tamper switch
- ▶ Head-on flush mounting
- ▶ Conventional perimeter protection

Conventional magnet contacts are used for tear-off surveillance of windows and doors.

Certifications and Approvals

Region	Certification	
Europe	CE	EMK 46 S Z
Germany	VdS	G 196041, C EMK 46 S

Installation/Configuration Notes

Installation notes

- Installation is head-on in door or window frames.
- Installation can be completed with or without a plastic sleeve. If no plastic sleeve is used, the components should be fixed in the bores.
- Installation in ferromagnetic materials is not permissible.
- The supply lines need to be measured electrically before connection.

Parts Included

Type	Qty.	Component
EMK 46 S Z	1	Built-in magnetic contact incl. flange and sleeves

Technical Specifications

Type of installation	Flush, head-on
Permissible operating voltage	Max. 40 V ₋
Contact type	1-pin (normally) open contact
Permissible contact load	6 VA Max. 100 V ₋ Max. 500 mA
Protection category	IP 67 VdS environmental class IV
Permissible ambient temperature	-25 °C to +70 °C
Housing	
• Material	ABS
• Color	White

Dimensions

- | | |
|-----------------------------|--------------------|
| • Contact | 8 x 32 mm (Ø x L) |
| • Magnet | 6 x 30 mm (Ø x L) |
| • Plastic sleeve for magnet | 8 x 31 mm (Ø x L) |
| • Connection cable | 3.2 mm, length 6 m |

EMK 46 Z Built-in magnetic contact

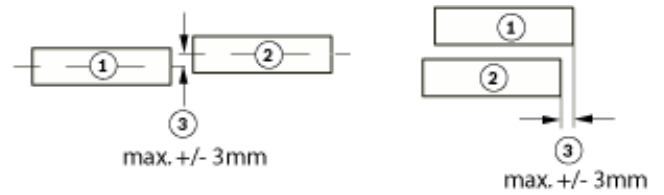

- 1 Contact
- 2 Magnet
- 3 Installation offset

Distances diagram

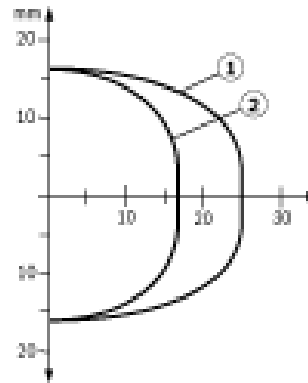

- 1 Extraction
- 2 Proximity switch part

Features

- ▶ Conventional flush-mount magnetic contact
- ▶ VdS class B
- ▶ Head-on or parallel flush mounting
- ▶ Conventional perimeter protection
- ▶ Can be used in the SPE blocking element (installed on frames/doors) according to VdS Class B

Conventional magnetic contacts are used for opening surveillance of windows and doors.

Certifications and Approvals

Region	Certification	
Europe	CE	EMK 46 Z
Germany	VdS	G 191563, B EMK 46

Installation/Configuration Notes

Installation notes

- Installation is head-on or parallel in door or window frames.
- Installation can be completed with or without a plastic sleeve. If no plastic sleeve is used, the components should be fixed in the bores.
- Installation in ferromagnetic materials is not permissible.
- The supply lines need to be measured electrically before connection.

Parts Included

Type	Qty.	Component
EMK 46 Z	1	Recessed mount magnetic contacts incl. flange and sleeves

Technical Specifications

Type of installation	Flush, head-on or parallel
Permissible operating voltage	Max. 40 V _~
Contact type	1-pin (normally) open contact
Permissible contact load	6 VA Max. 100 V Max. 500 mA
Protection category	IP 67
	VdS environmental class IV
Permissible ambient temperature	-25 °C to +70 °C
Housing	
• Material	ABS
• Color	White
Dimensions	
• Contact	6 x 30 mm (Ø x L)
• Magnet	6 x 30 mm (Ø x L)
• Plastic sleeve	8 x 31 mm (Ø x L)
• Connection cable	Ø 3.2 mm, 6 m long

MS-LZ Flush-Mount Magnetic Contact



5

Features

- ▶ Conventional flush-mount magnetic contact
- ▶ VdS class B
- ▶ Head-on or parallel flush mounting
- ▶ Conventional perimeter protection

Conventional magnetic contacts are used for opening surveillance of windows and doors.

Certifications and Approvals

Region	Certification	
Europe	CE	MS-LZ
Germany	VdS	G 191568, B MS/MSA-LZ

Installation/Configuration Notes

Installation notes

- Installation can be parallel or head-on.
- Head-on installation in ferromagnetic materials is possible with the EG1 flush-mount housing.
- The magnet should be fixed in the bore.
- For VdS applications, the MS-LZ flush-mount magnetic contact cannot be used in ferromagnetic materials.

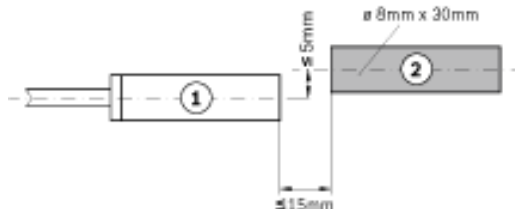

- 1 Contact
2 Magnet

Parts Included

Type	Quant.	Component
MS-LZ	1	Recessed mount magnetic contacts incl. 6 m cable

Technical Specifications

Type of installation	Flush, parallel or head-on
Contact	Normally open contact
Permissible contact load	≤ 5 Watt
Switching current	10 to 100 mA
Switching voltage max.	≤ 110 V _~
Switch tolerance	≥ 10 ⁷
Magnet	AlNiCo 500
Switch dimensions	Ø 8 mm x 30 mm
Magnet dimensions	Ø 8 mm x 30 mm
Axial installation distance	≤ 15 mm
Temperature range	-25 °C to +70 °C
Connection cable	6 m, LiYY 4 x 0.14 mm
Protection category	IP68

MS-LZS Flush-Mount Magnetic Contact



Features

- ▶ Conventional flush-mount magnetic contact
- ▶ VdS class C
- ▶ Tamper switch
- ▶ Head-on or parallel flush mounting
- ▶ Conventional perimeter protection

Conventional magnet contacts are used for opening surveillance of windows and doors.

Certifications and Approvals

Region	Certification	
Europe	CE	MS-LZS
Germany	VdS	G 191100, C MS/MSA-LZS

Installation/Configuration Notes

Installation notes

- Installation can be parallel or head-on.
- Head-on flush mounting in ferromagnetic materials is possible with the EG2 flush-mount housing.
- The magnet should be fixed in the bore.

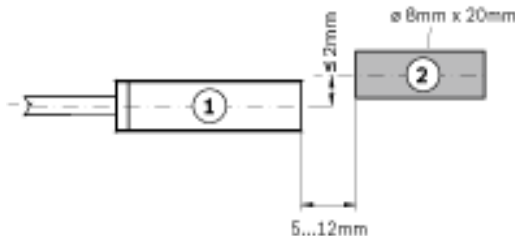

- 1 Contact
- 2 Magnet

Parts Included

Type	Quant.	Component
MS-LZS	1	Recessed mount magnetic contact incl. 6 m cable

Technical Specifications

Type of installation	Flush, parallel or head-on
Contact	Normally open contact/toggle switch
Permissible contact load	≤ 3 Watt
Switching current	10 A to 100 mA
Switching voltage max.	$\leq 30 V_{_}$
Switch tolerance	$\geq 10^7$
Magnet	AlNiCo 500
Switch dimensions	$\varnothing 8$ mm x 30 mm
Magnet dimensions	$\varnothing 8$ mm x 20 mm
Axial installation distance	5 to 12 mm
Temperature range	-25 °C to 70 °C
Connection cable	6 m, LiYY 4 x 0.14 mm
Protection category	IP68

ADM 2000 Spring-loaded mechanism



5

Technical Specifications

Spring-loaded mechanism

Material	Plastic, ABS
Pressure force (1/2/3 springs)	2.85 / 5.70 / 8.55 kp
Dimensions (H x W x D)	8 x 70 x 36 mm
Stroke of the pressure lock:	Max. 13.5 mm

Distance plate

- Material: Plastic, ABS
- Dimensions (H x W x D): 2 x 70 x 22 mm

Features

- ▶ Suitable for metal and plastic windows or doors
- ▶ Universal usage due to the distance plate
- ▶ Spring force can be adjusted (1 to 3 springs)

The ADM 2000 spring-loaded mechanism monitors the closing of doors and windows in conjunction with magnetic contacts.

Functions

If a window (or door) is partially, but not fully, closed, the spring-loaded mechanism ensures that the window is pushed open far enough so that this can be reported to an intrusion control panel by an associated magnetic contact.

Certifications and Approvals

Region	Certification	
Germany	VdS	G 194012, C ADM 2000

Installation/Configuration Notes

Installation notes

- Depending on the pressure force desired, the ADM 2000 can be equipped with 1, 2 or 3 springs.

Parts Included

Type	Qty.	Component
ADM 2000	1	Spring-loaded mechanism

ADB Spring-loaded bolts for wooden windows



Installation/Configuration Notes

Installation notes

- When installing the magnetic contact used for tear-off surveillance, it should be mounted as far as possible from the hinge.
- The distance (L) from the reed contact to the hinge must be measured.
- The travel (S) of the reed contact is to be determined with an ohmmeter before installation.
- For the calculation, it is assumed that the spring-loaded bolts are fully compressed when the door or window is tightly closed.

Positioning of the spring-loaded bolt

A = Distance from the spring-loaded bolt to the hinge

L = Distance from the reed contact to the hinge

H = Spring-loaded bolt stroke = 6 mm

S = Travel of the reed contact

$$A \text{ (mm)} = 0,9 \times \frac{L \text{ (mm)} \times H \text{ (mm)}}{S \text{ (mm)}}$$

Features

The spring-loaded bolts can be used with:

- ▶ **Wooden windows**
- ▶ **Metal windows**
- ▶ **Plastic windows**
- ▶ **Wooden doors**
- ▶ **Metal doors**
- ▶ **Plastic doors**

Spring-loaded bolts are used in conjunction with magnetic contacts primarily for monitoring closure of doors and windows.

Functions

If a window (or door) is partially, but not fully, closed, the spring-loaded bolt ensures that the window is pushed open far enough so that this can be reported to an intrusion control panel by an associated magnetic contact.

Certifications and Approvals

Region	Certification
Germany	VdS G 196040, C ADB

Parts Included

Type	Qty.	Component
ADB	1	Spring-loaded bolts with locking nut; mounting plate with fixing nut

Technical Specifications

Spring-loaded bolts

- Material: Brass, nickel-plated
- Pressure force: 35 N = 3.5 kp
- Dimensions (H x W x D): 50 x 17 x 3.5 mm

Counter plate

- Material: Brass, nickel-plated
- Dimensions (H x W x D): 12 x 37 x 2 mm

Mounting plate with fixing nut

- Material: Brass, nickel-plated
- Dimensions (H x W x D): 17 x 50 x 3.5 mm

ISN-CMICRO Ultra Miniature Contacts

5

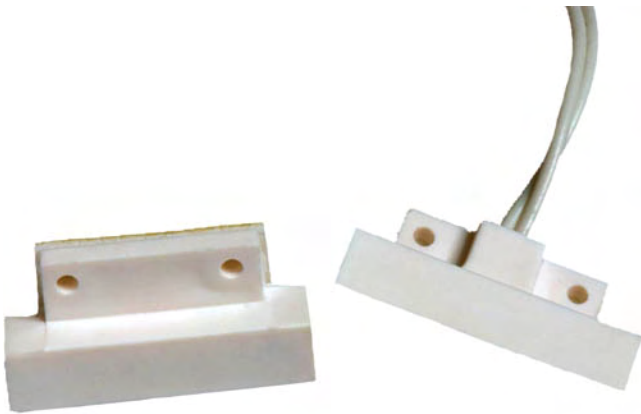

Features

- ▶ Closed loop
- ▶ Surface-mounts or installs in the track of the window
- ▶ Ideal for tight-fit windows where a large gap is unnecessary
- ▶ Perfect for windows where warranty terms prohibit drilling
- ▶ Adhesive strip

The contacts are available in brown or white. Both models have a true miniature design, an adhesive strip, and include a magnet. Use on window frames in tight-fitting applications.

Certifications and Approvals

UL and CE

Region	Certification
Europe	CE 73/23/EEC and 93/68/EEC, EN50131: 1997, EN50131-6: 1997, EN60950: 2000, EN60335-1: 1994 +A1: 1996 Annex B

Installation/Configuration Notes

Compatibility Information

All contact models are compatible with control panel models that accept contact inputs.

Parts Included

Quantity Per Package	Component
10	Assemblies (contacts and adhesive strips)
10	Magnets

Technical Specifications

Specifications for All Models

Gap Width:	9.5 mm (0.375 in.)
Contact Dimensions:	19 mm x 12.7 mm (0.25 in. x 0.5 in.)
Wire Lead Type:	0.8 mm (0.029 in.) 22 AWG, 7 stranded
Wire Lead Length:	46 cm (18 in.)
Switch Configuration Type:	Single pole single throw (SPST)
Maximum Contact Resistance:	150 $\mu\Omega$ (micro-ohm)
Minimum Breakdown Voltage:	200 VDC
Insulation Resistance:	10 ⁹ Ω
Electrostatic Cap:	1.5 PF
Contact Capacity:	3 VAC
Maximum Conductive Current:	0.5 A
Maximum Voltage:	30 V
Operating Temperature Range:	7.2°C to -95.56°C (-45°F to -140°F)

Package Information

ATTENTION! Each package contains ten assemblies with contacts, adhesive strips, and ten magnets.

Ordering Information

Brown Ultra Miniature Contact Brown surface mount contact. Package contains ten assemblies with contacts, adhesive strips, and ten magnets.	ISN-CMICRO-B
White Ultra Miniature Contact White surface mount contact. Package contains ten assemblies with contacts, adhesive strips, and ten magnets.	ISN-CMICRO-W

ISN-C50 Terminal Connection Contacts with Cover



Features

- ▶ Closed loop
- ▶ Includes cover
- ▶ Surface mount
- ▶ Terminal connection design
- ▶ Clean-looking
- ▶ Easy to install
- ▶ Includes deactivated rhodium reed switch
- ▶ Includes screws, cover, and adhesive strip

The contacts are available in brown or white. Both models have a terminal connection design for fast and easy installation and an adhesive strip. Both models include a cover to conceal the screws, giving the contact a clean, finished appearance.

Functions

UL and CE

Certifications and Approvals

Region	Certification
Europe	CE 73/23/EEC and 93/68/EEC, EN50131: 1997, EN50131-6: 1997, EN60950: 2000, EN60335-1: 1994 +A1: 1996 Annex B

Installation/Configuration Notes

Compatibility Information

All contact models are compatible with control panel models that accept contact inputs.

Parts Included

Quantity Per Package	Component
10	Assemblies (contacts, screws, covers, adhesive strips, and reed switches)
10	Magnets

Technical Specifications

Specifications for All Models

Gap Width:	19 mm (0.75 in.)
Contact Dimensions:	48.5 mm x 12.7 mm (1.9 in. x 0.5 in.)
Cover Dimensions:	9.5 mm x 40 mm (0.375 in. x 1.56 in.)
Switch Configuration Type:	Single pole single throw (SPST)
Maximum Contact Resistance:	150 $\mu\Omega$ (micro-ohm)
Minimum Breakdown Voltage:	250 VDC
Insulation Resistance:	10 ¹⁰ Ω
Electrostatic Cap:	0.3 PF
Contact Capacity:	10 VAC
Maximum Conductive Current:	1.0 A
Maximum Voltage:	100 V
Operating Temperature Range:	7.2°C to -95.56°C (-45°F to -140°F)

Package Information

ATTENTION! Each package contains ten assemblies with contacts, screws, covers, adhesive strips, reed switches, and ten magnets.

Ordering Information

Brown Terminal Connection Contact with Cover ISN-C50-B

Brown surface mount contact. **Package contains ten assemblies with contacts, screws, covers, adhesive strips, reed switches, and ten magnets.**

White Terminal Connection Contact with Cover ISN-C50-W

White surface mount contact. **Package contains ten assemblies with contacts, screws, covers, adhesive strips, reed switches, and ten magnets.**

ISN-C60 Slim Terminal Connection Contacts

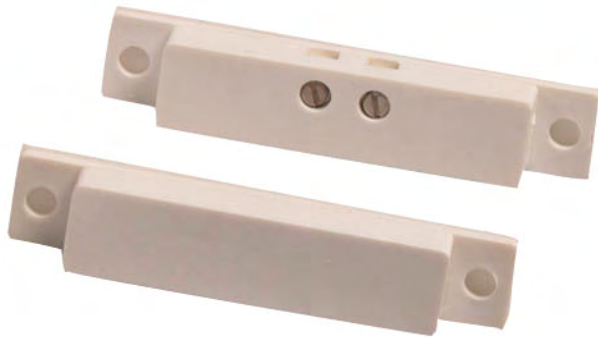

5

Features

- ▶ Closed loop
- ▶ Install with screws or with super adhesive
- ▶ Breakaway mounting holes for a tight fit
- ▶ Slim terminal connection design
- ▶ Includes deactivated rhodium reed switch
- ▶ Includes screws, super adhesive, mounting holes, and tape cover

The contacts are available in brown or white. Both models have a slim design with breakaway mounting holes for tight-fitting applications. The terminal connection eliminates the need for 15.24 cm or 25.4 cm (6 in. or 10 in.) leads.

Certifications and Approvals

UL and CE

Region	Certification
Europe	CE 73/23/EEC and 93/68/EEC, EN50131: 1997, EN50131-6: 1997, EN60950: 2000, EN60335-1: 1994 +A1: 1996 Annex B

Installation/Configuration Notes

Compatibility Information

All contact models are compatible with control panel models that accept contact inputs.

Parts Included

Quantity Per Package	Component
10	Assemblies (contacts, screws, super adhesive, mounting holes, and tape covers)
10	Magnets

Technical Specifications

Specifications for All Models

Gap Width:	19 mm (0.75 in.)
Contact Dimensions:	6.35 mm x 9.5 mm x 50.8 mm (0.25 in. x 0.375 in. x 2 in.)
Switch Configuration Type:	Single pole single throw (SPST)
Maximum Contact Resistance:	150 $\mu\Omega$ (micro-ohm)
Minimum Breakdown Voltage:	250 VDC
Insulation Resistance:	10 ¹⁰ Ω
Electrostatic Cap:	0.3 PF
Contact Capacity:	10 VAC
Maximum Conductive Current:	1.0 A
Maximum Voltage:	100 V
Operating Temperature Range:	7.2°C to -95.56°C (-45°F to -140°F)

Package Information

ATTENTION! Each package contains ten assemblies with contacts, screws, super adhesive, mounting holes, tape covers, and ten magnets.

Ordering Information

Brown Slim Terminal Connection Contact Brown surface mount contact. Package contains ten assemblies with contacts, screws, super adhesive, mounting holes, tape covers, and ten magnets.	ISN-C60-B
White Slim Terminal Connection Contact White surface mount contact. Package contains ten assemblies with contacts, screws, super adhesive, mounting holes, tape covers, and ten magnets.	ISN-C60-W

ISN-CSM35 Standard and Wide Gap Contacts

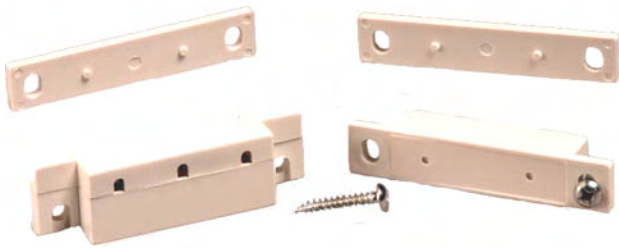

Features

- ▶ Closed loop
- ▶ Standard industry size
- ▶ Spacers, screws, and cover included

The contacts are available in brown or white.

Note The photograph shows model ISN-CSM35-W.

Certifications and Approvals

UL and CE

Region	Certification
Europe	CE 73/23/EEC and 93/68/EEC, EN50131: 1997, EN50131-6: 1997, EN60950: 2000, EN60335-1: 1994 +A1: 1996 Annex B

Installation/Configuration Notes

Compatibility Information

All contact models are compatible with control panel models that accept contact inputs.

Parts Included

Quantity Per Package	Component
10	Assemblies (contacts, spacers, screws, and covers)
10	Magnets

Technical Specifications

Specifications for All Models

Contact Dimensions:	63 mm x 18.6 mm x 13 mm (2.48 in. x 0.73 in x 0.51 in.)
Magnetic Assembly Dimensions:	63 mm x 12.2 mm x 13 mm (2.48 x 0.48 in x 0.51 in.)
Switch Configuration Type:	Single pole single throw (SPST)
Maximum Contact Resistance:	150 μΩ (micro-ohm)
Minimum Breakdown Voltage:	250 VDC
Insulation Resistance:	10 ¹⁰ Ω
Electrostatic Cap:	0.3 PF
Contact Capacity:	10 VAC
Maximum Conductive Current:	1.0 A
Maximum Voltage:	100 V
Operating Temperature Range:	7.2°C to -95.56°C (-45°F to -140°F)

Specifications for ISN-CSM35-B/W Models

Gap Width: 25 mm (1 in.)

Specifications for ISN-CSM35-WGB/W Models

Gap Width: 44.45 mm (1.75 in.)

Package Information

ATTENTION! Each package contains ten assemblies with contacts, spacers, screws, covers, and ten magnets.

Ordering Information

Brown Standard Contact Brown surface mount contact for standard applications. Package contains ten assemblies with contacts, spacers, screws, covers, and ten magnets.	ISN-CSM35-B
White Standard Contact White surface mount contact for standard applications. Package contains ten assemblies with contacts, spacers, screws, covers, and ten magnets.	ISN-CSM35-W
Brown Wide Gap Contact Brown surface mount contact for heavy steel doors and commercial wide gap applications. Package contains ten assemblies with contacts, spacers, screws, covers, and ten magnets.	ISN-CSM35-WGB
White Wide Gap Contact White surface mount contact for heavy steel doors and commercial wide gap applications. Package contains ten assemblies with contacts, spacers, screws, covers, and ten magnets.	ISN-CSM35-WGW

ISN-CSM20-WG Commercial Contacts



5

Features

- ▶ Closed loop
- ▶ Ideal for steel doors
- ▶ Wide gap deters swinging

The contacts are available in brown or white. Use for commercial or steel door applications.

Certifications and Approvals

UL and CE

Region	Certification	
Europe	CE	73/23/EEC and 93/68/EEC, EN50131: 1997, EN50131-6: 1997, EN60950: 2000, EN60335-1: 1994 +A1: 1996 Annex B

Installation/Configuration Notes

Compatibility Information

All contact models are compatible with control panel models that accept contact inputs.

Parts Included

Quantity Per Package	Component
1	Contact
1	Magnet

Technical Specifications

Specifications for All Models

Gap Width:	63.5 mm (2.5 in.)
Contact Dimensions:	16 mm x 104.8 mm x 16 mm (0.625 in. x 4.125 in. x 0.625 in.)
Wire Lead Type:	0.8 mm (0.029 in.) 22 AWG, 7 stranded
Wire Lead Length:	46 cm (18 in.)
Switch Configuration Type:	Single pole single throw (SPST)
Maximum Contact Resistance:	150 $\mu\Omega$ (micro-ohm)
Minimum Breakdown Voltage:	250 VDC
Insulation Resistance:	10 ¹⁰ Ω
Electrostatic Cap:	0.3 PF
Contact Capacity:	10 VAC
Maximum Conductive Current:	1.0 A
Maximum Voltage:	100 V
Operating Temperature Range:	7.2°C to -95.56°C (-45°F to -140°F)

Package Information

ATTENTION! Each package contains one contact and one magnet.

Ordering Information

Brown Commercial Contact Brown surface mount contact. Package contains one contact and one magnet.	ISN-CSM20-WGB
White Commercial Contact White surface mount contact. Package contains one contact and one magnet.	ISN-CSM20-WGW

ISN-CSS-40 Super Stick Contacts with Side Leads

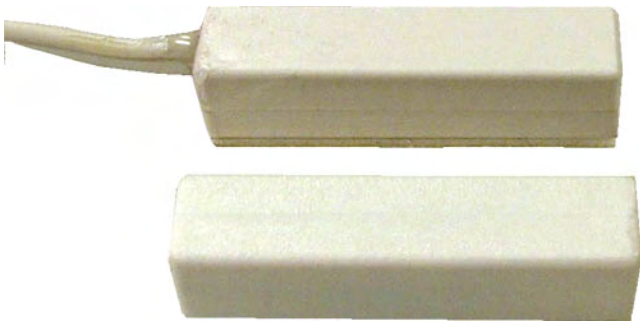

Features

- ▶ Closed loop
- ▶ Special super stick adhesive does not fall off, dry off, or freeze off
- ▶ Side leads

The contacts are available in brown or white. Both models have a strong adhesive surface. Both models have leads that come from the side of the contact.

Certifications and Approvals

UL and CE

Installation/Configuration Notes

Compatibility Information

All contact models are compatible with control panel models that accept contact inputs.

Parts Included

Quantity Per Package	Component
10	Contacts
10	Magnets

Technical Specifications

Specifications for All Models

Gap Width:	19 mm (0.75 in.)
Contact Dimensions:	7.8 mm x 35.56 mm x 7.8 mm (0.31 in. x 1.4 in. x 0.31 in.)
Wire Lead Type:	0.8 mm (0.029 in.) 22 AWG, 7 stranded
Wire Lead Length:	46 cm (18 in.)
Switch Configuration Type:	Single pole single throw (SPST)
Maximum Contact Resistance:	150 $\mu\Omega$ (micro-ohm)
Minimum Breakdown Voltage:	250 VDC
Insulation Resistance:	$10^{10} \Omega$
Electrostatic Cap:	0.3 PF
Contact Capacity:	10 VAC
Maximum Conductive Current:	1.0 A
Maximum Voltage:	100 V
Operating Temperature Range:	7.2°C to -95.56°C (-45°F to -140°F)

Package Information

ATTENTION! Each package contains ten contacts and ten magnets.

Ordering Information

Brown Super Stick Contact with Side Leads Brown surface mount contact. Includes a standard magnet. Package contains ten contacts and ten magnets.	ISN-CSS-40B
White Super Stick Contact with Side Leads White surface mount contact. Includes a standard magnet. Package contains ten contacts and ten magnets.	ISN-CSS-40W

ISN-C45 Miniature Super Stick Contacts with Side Leads

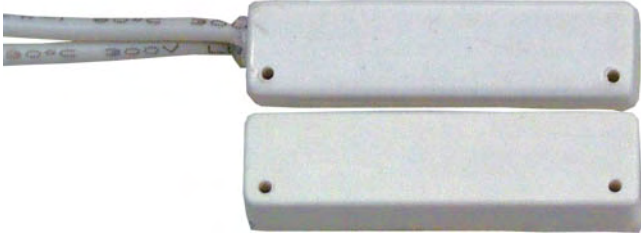

5

Features

- ▶ Closed loop
- ▶ Miniature design
- ▶ Special adhesive does not fall off, dry off, or freeze off
- ▶ Side leads

The contacts are available in brown or white. Both models have a small, slim miniature design and include special adhesive that will not fall off from dryness or extreme cold. Use for tight-fitting applications.

Certifications and Approvals

UL and CE

Region	Certification
Europe	CE 73/23/EEC and 93/68/EEC, EN50131: 1997, EN50131-6: 1997, EN60950: 2000, EN60335-1: 1994 +A1: 1996 Annex B

Installation/Configuration Notes

Compatibility Information

All contact models are compatible with control panel models that accept contact inputs.

Parts Included

Quantity Per Package	Component
10	Contacts
10	Magnets

Technical Specifications

Specifications for All Models

Gap Width:	15.24 mm (0.60 in.)
Contact Dimensions:	4.8 mm x 27 mm x 6.35 mm (0.187 in. X 1.06 in. x 0.25 in.)
Wire Lead Type:	0.8 mm (0.029 in.) 22 AWG, 7 stranded
Wire Lead Length:	46 cm (18 in.)
Switch Configuration Type:	Single pole single throw (SPST)
Maximum Contact Resistance:	150 $\mu\Omega$ (micro-ohm)
Minimum Breakdown Voltage:	200 VDC
Insulation Resistance:	10 ⁹ Ω
Electrostatic Cap:	1.5 PF
Contact Capacity:	3 VAC
Maximum Conductive Current:	0.5 A
Maximum Voltage:	30 V
Operating Temperature Range:	7.2°C to -95.56°C (-45°F to -140°F)

Package Information

ATTENTION! Each package contains ten contacts and ten magnets.

Ordering Information

Brown Miniature Super Stick Contact with Side Leads ISN-C45-B

Brown surface mount contact. Includes a standard magnet and special adhesive. **Package contains ten contacts and ten magnets.**

White Miniature Super Stick Contact with Side Leads ISN-C45-W

White surface mount contact. Includes a standard magnet and special adhesive. **Package contains ten contacts and ten magnets.**

ISN-CFM-102 Flange Mount Contacts with Side Leads

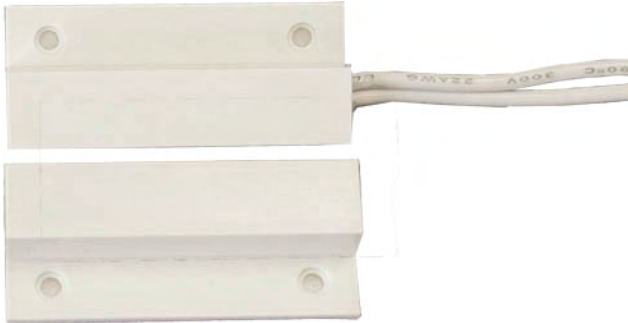

Features

- ▶ Closed loop
- ▶ Flange mount with special adhesive
- ▶ Side leads

The contacts are available in brown or white. Both models are flange mountable with special adhesive and have leads that come from the side of the contact.

Certifications and Approvals

UL and CE

Region	Certification
Europe	CE 73/23/EEC and 93/68/EEC, EN50131: 1997, EN50131-6: 1997, EN60950: 2000, EN60335-1: 1994 +A1: 1996 Annex B

Installation/Configuration Notes

Compatibility Information

All contact models are compatible with control panel models that accept contact inputs.

Parts Included

Quantity Per Package	Component
10	Contacts
10	Magnets

Technical Specifications

Specifications for All Models

Gap Width:	25 mm (1 in.)
Contact Dimensions:	7.62 mm x 33.78 mm x 13.46 mm (0.3 in x 1.33 in. x 0.53 in)
Wire Lead Lengths:	46 cm (18 in.)
Wire Lead Type:	0.8 mm (0.029 in.) 22 AWG, 7 stranded
Switch Configuration Type:	Single pole single throw (SPST)
Maximum Contact Resistance:	150 μΩ (micro-ohm)
Minimum Breakdown Voltage:	250 VDC
Insulation Resistance:	10 ¹⁰ Ω
Electrostatic Cap:	0.3 PF
Contact Capacity:	10 VAC
Maximum Conductive Current:	1.0 A
Maximum Voltage:	100 V
Operating Temperature Range:	7.2°C to -95.56°C (-45°F to -140°F)

Package Information

ATTENTION! Each package contains ten contacts and ten magnets.

Ordering Information

Brown Flange Mount Contact with Side Leads ISN-CFM-102Bds

Brown surface mount contact. Includes a standard magnet and special adhesive. **Package contains ten contacts and ten magnets.**

White Flange Mount Contact with Side Leads ISN-CFM-102Wds

White surface mount contact. Includes a standard magnet and special adhesive. **Package contains ten contacts and ten magnets.**

ISN-CFM-106 Flange Mount Contacts with Center Leads



5

Features

- ▶ Closed loop
- ▶ Flange mount with special adhesive
- ▶ Center leads
- ▶ Clean break flange removal

The contacts are available in brown or white. Both models are flange mountable with special adhesive and have leads that come from the center of the contact. Both models have a "clean break" flange removal.

Certifications and Approvals

UL and CE

Region	Certification
Europe	CE 73/23/EEC and 93/68/EEC, EN50131: 1997, EN50131-6: 1997, EN60950: 2000, EN60335-1: 1994 +A1: 1996 Annex B

Installation/Configuration Notes

Compatibility Information

All contact models are compatible with control panel models that accept contact inputs.

Parts Included

Quantity Per Package	Component
10	Contacts
10	Magnets

Technical Specifications

Specifications for All Models

Gap Width:	25 mm (1 in.)
Contact Dimensions:	7.62 mm x 33.78 mm x 13.46 mm (0.3 in. x 1.33 in. x 0.53 in.)
Wire Lead Type:	0.8 mm (0.029 in.) 22 AWG, 7 stranded
Wire Lead Length:	46 cm (18 in.)
Switch Configuration Type:	Single pole single throw (SPST)
Maximum Contact Resistance:	150 $\mu\Omega$ (micro-ohm)
Minimum Breakdown Voltage:	250 VDC
Insulation Resistance:	10 ¹⁰ Ω
Electrostatic Cap:	0.3 PF
Contact Capacity:	10 VAC
Maximum Conductive Current:	1.0 A
Maximum Voltage:	100 V
Operating Temperature Range:	7.2°C to -95.56°C (-45°F to -140°F)

Package Information

ATTENTION! Each package contains ten contacts and ten magnets.

Ordering Information

Brown Flange Mount Contact with Center Leads ISN-CFM-106B

Brown surface mount contact. Includes a standard magnet and special adhesive. **Package contains ten contacts and ten magnets.**

White Flange Mount Contact with Center Leads ISN-CFM-106W

White surface mount contact. Includes a standard magnet and special adhesive. **Package contains ten contacts and ten magnets.**

ISN-CMET-4418 Overhead Door Contact

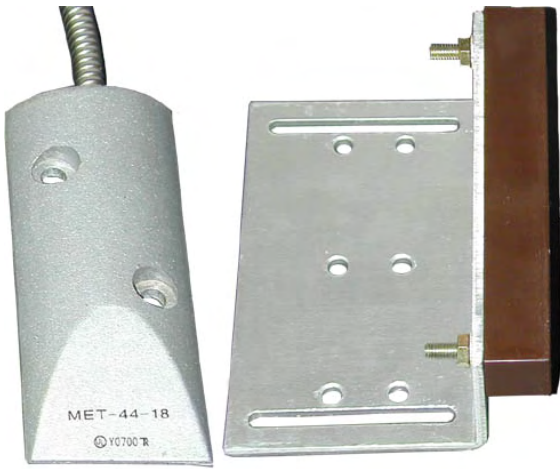

Features

- ▶ Closed loop
- ▶ Pin holds armored cable firmly in place
- ▶ Includes adjustable magnetic assembly bracket
- ▶ Ten installation options for the magnet

The contact is available in a metal finish. It uses epoxy and a special push-pin to hold the armored cable firmly in place.

Certifications and Approvals

UL and CE

Region	Certification
Europe	CE 73/23/EEC and 93/68/EEC, EN50131: 1997, EN50131-6: 1997, EN60950: 2000, EN60335-1: 1994 +A1: 1996 Annex B

Installation/Configuration Notes

Compatibility Information

All contact models are compatible with control panel models that accept contact inputs.

Parts Included

Quantity Per Package	Component
1	Assembly (contact, epoxy, push-pin, and bracket)
1	Magnet

Technical Specifications

Gap Width:	50.8 mm (2 in.)
Contact Dimensions:	107 mm x 50.8 mm x 12 mm (4 in. x 2 in. x 0.47 in.)
Cable Length:	46 cm (18 in.)
Switch Configuration Type:	Single pole single throw (SPST)
Maximum Contact Resistance:	150 μΩ (micro-ohm)
Minimum Breakdown Voltage:	250 VDC
Insulation Resistance:	10 ¹⁰ Ω
Electrostatic Cap:	0.3 PF
Contact Capacity:	10 VAC
Maximum Conductive Current:	1.0 A
Maximum Voltage:	100 V
Operating Temperature Range:	7.2°C to -95.56°C (-45°F to -140°F)

Package Information

ATTENTION! Each package contains one assembly with contact, epoxy, push-pin, bracket, and one magnet.

Ordering Information

ISN-CMET-4418 Overhead Door Contact **ISN-CMET-4418**
 Package contains one assembly with contact, epoxy, push-pin, bracket, and one magnet.

ISN-CMET-200AR Commercial Metal Contact

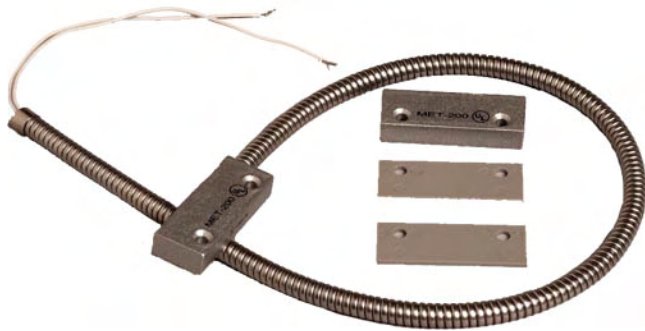

5

Features

- ▶ Closed loop
- ▶ Wide gap
- ▶ Ideal for commercial applications

The contact is available in a metal finish. Use for commercial applications that need a wide gap.

Certifications and Approvals

UL and CE

Region	Certification
Europe	CE 73/23/EEC and 93/68/EEC, EN50131: 1997, EN50131-6: 1997, EN60950: 2000, EN60335-1: 1994 +A1: 1996 Annex B

Installation/Configuration Notes

Compatibility Information

All contact models are compatible with control panel models that accept contact inputs.

Parts Included

Quantity Per Package	Component
1	Contact
1	Magnet

Technical Specifications

Gap Width:	31.75 mm (1.25 in.)
Contact Dimensions:	9.5 mm x 16 mm x 50.8 mm (0.375 in. x 0.625 in. x 2 in.)
Cable Length:	46 cm (18 in.)
Switch Configuration Type:	Single pole single throw (SPST)
Maximum Contact Resistance:	150 $\mu\Omega$ (micro-ohm)
Minimum Breakdown Voltage:	250 VDC
Insulation Resistance:	$10^{10} \Omega$
Electrostatic Cap:	0.3 PF
Contact Capacity:	10 VAC
Maximum Conductive Current:	1.0 A
Maximum Voltage:	100 V
Operating Temperature Range:	7.2°C to -95.56°C (-45°F to -140°F)

Package Information

ATTENTION! Each package contains one contact and one magnet.

Ordering Information

**ISN-CMET-200AR Commercial
Metal Contact**

ISN-CMET-200AR

Package contains one contact and one magnet.

ISN-C66 Track Mounted Overhead Door Contact

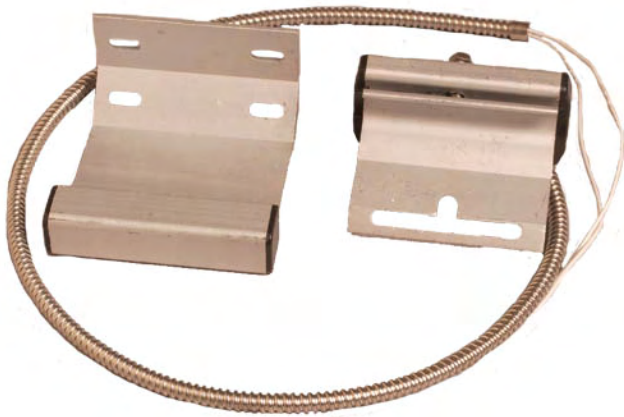

Features

- ▶ Closed loop
- ▶ Mounts on door tracks
- ▶ Sturdy and solid
- ▶ Four-way magnet bracket
- ▶ Installs better and faster than standard overhead contacts

The contact is available in a metal finish. It has a wider gap for reduced false alarms and a four-way adjustable magnet bracket. It includes an armored cable. Use for mounting on door tracks.

Certifications and Approvals

UL and CE

Region	Certification
Europe	CE 73/23/EEC and 93/68/EEC, EN50131: 1997, EN50131-6: 1997, EN60950: 2000, EN60335-1: 1994 +A1: 1996 Annex B

Installation/Configuration Notes

Compatibility Information

All contact models are compatible with control panel models that accept contact inputs.

Parts Included

Quantity Per Package	Component
1	Assembly (contact and bracket)
1	Magnet

Technical Specifications

Gap Width:	44.45 mm (1.75 in.)
Contact Assembly and Bracket Dimensions:	76.2 mm x 66 mm x 45.8 mm (3.07 in x 2.60 in. x 1.80 in.)
Cable Length:	46 cm (18 in.)
Switch Configuration Type:	Single pole single throw (SPST)
Maximum Contact Resistance:	150 μΩ (micro-ohm)
Minimum Breakdown Voltage:	250 VDC
Insulation Resistance:	10 ¹⁰ Ω
Electrostatic Cap:	0.3 PF
Contact Capacity:	10 VAC
Maximum Conductive Current:	1.0 A
Maximum Voltage:	100 V
Operating Temperature Range:	7.2°C to -95.56°C (-45°F to -140°F)

Package Information

ATTENTION! Each package contains one assembly with contact, bracket, and one magnet.

Ordering Information

ISN-C66 Track Mounted Overhead Door Contact **ISN-C66**

Package contains one assembly with contact, bracket, and one magnet.

EMK 46 AT Z Surface-Mount Magnetic Contact



5

Features

- ▶ Conventional surface-mount magnetic contact
- ▶ VdS class B
- ▶ Head-on or parallel surface mounting
- ▶ Conventional perimeter protection

Conventional magnet contacts are used for tear-off surveillance of windows and doors.

Certifications and Approvals

Region	Certification	
Europe	CE	EMK 46 AT Z
Germany	VdS	G 191563, B EMK 46

Installation/Configuration Notes

Installation notes

Installation can be head-on or parallel on the door or window frames.

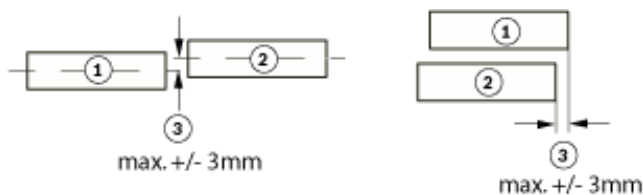

- 1 Contact
- 2 Magnet
- 3 Installation offset

Surface mounting

- When used on metal frames, the plastic bases must be used.
- The supply lines need to be measured electrically before connection.
- The contact and the magnet (6 x 30 mm) can only be inserted in the surface mounting housing in conjunction with the plastic sleeve.
- Installation on ferromagnetic materials is only permissible with the washer components supplied.
- Lateral installation offset: max +/- 3 mm.

Distances diagram

Surface mounting with magnet 6 x 30 mm

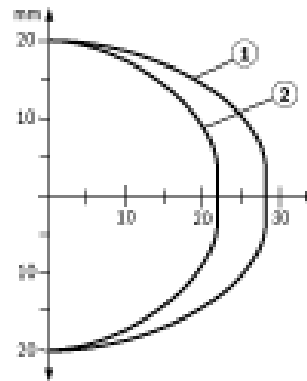

- 1 Extraction
- 2 Proximity switch part

Flush mounting

- Installation in ferromagnetic materials is not permissible.
- Installation can be completed with or without a plastic sleeve. If no plastic sleeve is used, the components should be fixed in the bores.

Distances diagram

Head-on installation with magnet 6 x 30 mm

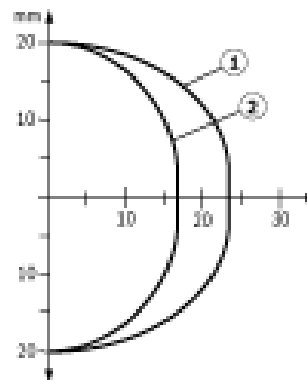

- 1 Extraction
- 2 Proximity switch part

Parts Included

Type	Qty.	Component
EMK 46 AT Z	1	Surface-mount magnetic contact incl. flange, sleeves, and surface-mounting housing with accessories

Technical Specifications

Type of installation	Surface mounting/flush mounting, parallel or head-on
Permissible operating voltage	Max. 40 V _~
Contact type	1-pin (normally) open contact
Permissible contact load	6 VA Max. 100 V _~ Max. 500 mA
Protection category	IP 67 VdS environmental class IV
Permissible ambient temperature	-25 °C to +70 °C
Housing	
• Material	ABS
• Color	White
Dimensions	
• Contact	6 x 30 mm (Ø x L)
• Magnet	6 x 30 mm (Ø x L)
• Plastic sleeve	8 x 31 mm (Ø x L)
• Connection cable	3.2 mm, length 6 m
Surface mounting housing	
• Base (L x W x D)	52 x 11 x 11.5 mm
• Cap (L x W x D)	54 x 13 x 12.5 mm
• 3 x bases	2 mm
• 1 base	6 mm

MK 48 SZ surface-mount magnetic contact



5

Features

- ▶ Conventional surface-mount magnetic contact
- ▶ VdS class C
- ▶ Tamper switch
- ▶ Parallel installation, surface mounted and flush mounted
- ▶ Conventional perimeter protection
- ▶ Can be used in the SPE blocking element (installed on frames/doors) according to VdS Class C

Conventional magnet contacts are used for tear-off surveillance of windows and doors.

Certifications and Approvals

Region	Certification	
Europe	CE	MK 48 SZ
Germany	VdS	G 191019, C MK 48 SZ

Installation/Configuration Notes

Installation notes

- Magnetic contact and magnet are mounted parallel to each other using the surface-mount or flush-mount housing.
- When inserting the contact housing, please ensure that the labeling stud on the face is pointing toward the magnet, regardless of the type of installation.
- The distance between the contact and the magnet must be between 7 mm and 16 mm; 12 mm is preferred.
- Installation in ferromagnetic materials is not permissible.
- Installation can be completed with or without a plastic sleeve. If no plastic sleeve is used, the components should be fixed in the bores.

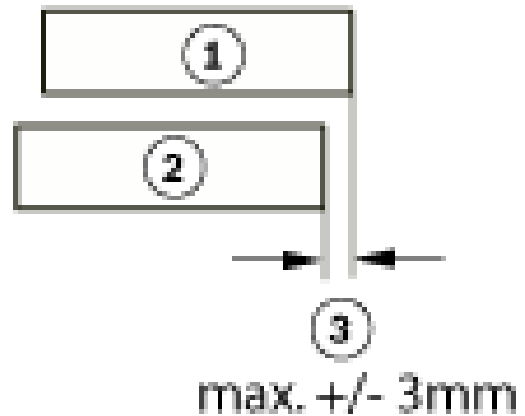

- 1 Contact
- 2 Magnet
- 3 Axial installation offset

Distances diagram

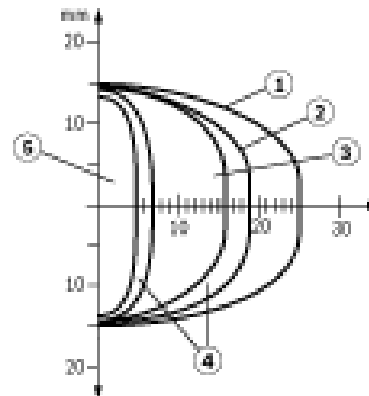

- 1 Extraction
- 2 Proximity switch part
- 3 Secure area
- 4 Tolerance
- 5 Tamper area

Parts Included

Type	Qty.	Components
MK 48 SZ	1	Surface-mount magnetic contact Magnet (8 x 8 x 40 mm) incl. 2x surface mounting housing, 2 caps with 4 bases

Technical Specifications

Type of installation	Surface-mounted/flush-mounted, parallel
Permissible operating voltage	Max. 40 V
Contact type	1-pin (normally) open contact
Permissible contact load	6 VA Max. 100 V Max. 500 mA
Protection category VdS environmental class	IP 67 IV
Permissible ambient temperature	-25 °C to +70 °C
Housing	
• Material	ABS
• Color	White
Dimensions (H x W x D)	
• Contact	8 x 8 x 40 mm
• Magnet	8 x 40 mm (Ø x L)
• Connection cable	3.2 mm, length 6 m
• Surface-mount housing cap	13 x 54 x 12.5 mm
• 2 x housing bases	11.5 x 11 x 52 mm
• 3 x bases	2 mm
• 1 x base	6 mm

MSA-LZ Surface-Mount Magnetic Contact

5

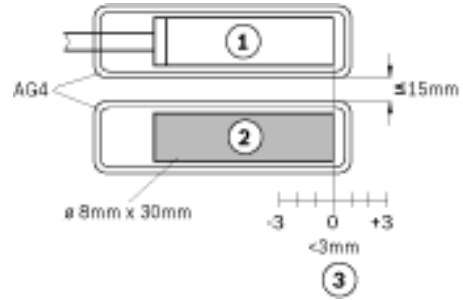
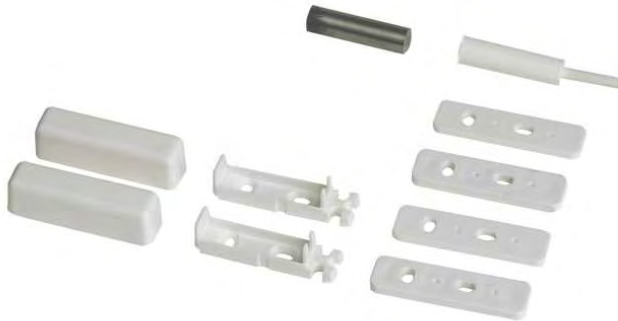

- 1 Contact
- 2 Magnet
- 3 Offset in the axial direction

Features

- ▶ Conventional surface-mount magnetic contact
- ▶ VdS class B
- ▶ Parallel or head-on surface mounting
- ▶ Conventional perimeter protection

Conventional magnetic contacts are used for opening surveillance of windows and doors.

Certifications and Approvals

Region	Certification	
Europe	CE	MSA-LZ
Germany	VdS	G 191568, B MS/MSA-LZ

Installation/Configuration Notes

Installation notes

- Installation can be parallel or head-on.
- The AG 4 surface mounting housing makes it possible to install on ferromagnetic materials.

Parts Included

Type	Quant.	Component
MSA-LZ	1	Surface-mount magnetic contact incl. 6 m cable and AG4 surface mounting housing with accessories

Technical Specifications

Type of installation	Surface mount, parallel or head-on
Contact	Normally open contact
Permissible contact load	≤ 5 Watt
Switching current	10 A to 100 mA
Switching voltage max.	≤ 110 V _~
Switch tolerance	≥ 10 ⁷
Magnet	AlNiCo 500
Switch dimensions	43 x 12 x 12 mm
Magnet dimensions	∅ 8 mm x 30 mm
Parallel installation distance	≤ 15 mm
Temperature range	-25 °C to 70 °C
Connection cable	6 m, LiYY 4 x 0.14 mm
Protection category	IP68

MSA-LZS Surface-Mount Magnetic Contact

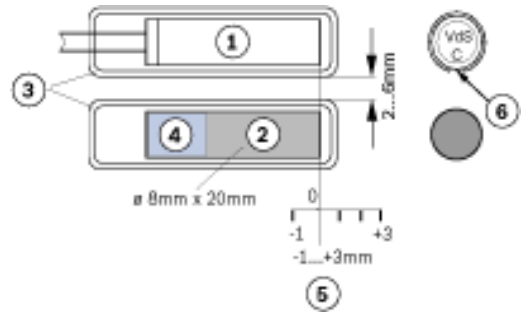

- 1 Contact
- 2 Magnet
- 3 AG4 surface mounting housing
- 4 Plastic part
- 5 Offset in the axial direction
- 6 Warning! The adjustment mark must point to the magnet.

Features

- ▶ Conventional surface-mount magnetic contact
- ▶ VdS class C
- ▶ Tamper switch
- ▶ Parallel or head-on surface mounting
- ▶ Conventional perimeter protection

Conventional magnetic contacts are used for opening surveillance of windows and doors.

Certifications and Approvals

Region	Certification	
Europe	CE	MSA-LZS
Germany	VdS	G 191100, C MS/MSA-LZS

Installation/Configuration Notes

Installation notes

- Installation can be parallel or head-on.
- The AG 4 surface mounting housing makes it possible to install on ferromagnetic materials.

Parts Included

Type	Quant.	Component
MSA-LZS	1	Surface-mount magnetic contact with magnet incl. 6 m cable and AG4 surface mounting housing with accessories

Technical Specifications

Type of installation	Surface mount, parallel or head-on
Contact	Normally open contact/toggle switch
Permitted contact load	≤ 3 Watt
Switching current	10 A to 100 mA
Switching voltage max.	≤ 30 V _~
Switch tolerance	≥ 10 ⁷
Magnet	AlNiCo 500
Switch dimension:	43 x 12 x 12 (mm)
Magnet dimension:	Ø 8 mm x 20 mm
Parallel installation distance:	2 to 6 mm
Temperature range	-25 °C to +70 °C
Connection cable	6 m, LiYY 4 x 0.14 mm
Protection type	IP68

AMK 4 Z Overhead door contact

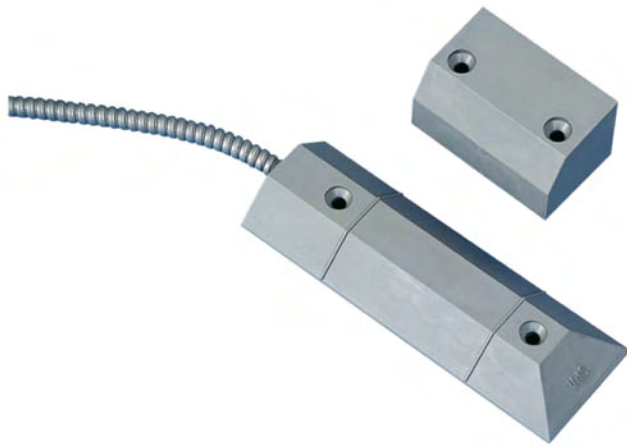

5

Features

- ▶ Shutter door contact in conventional technology
- ▶ For connection to the conventional intrusion control panel
- ▶ VdS class B
- ▶ High level of mechanical strength
- ▶ Large switch distance
- ▶ Conventional perimeter protection

Conventional shutter door contacts are used to monitor shutter, sliding and garage doors.

Certifications and Approvals

Region	Certification	
Europe	CE	AMK 4 Z
Germany	VdS	G 191565, B AMK 4

Installation/Configuration Notes

Installation notes

- For doors < 1.5 m, one shutter door contact is required. For doors > 1.5 m, use two shutter door contacts. Take note of the permissible installation tolerances.
- The shutter door contact consists of a sealed magnetic switch and a magnet in a plastic casing.
- The connection cable is protected over 1 m by a metal tube.

- The magnetic switch is installed at ground level (requires a flat surface). Vehicles with rubber tires can drive over the switch without causing problems. In spite of this, the magnetic switch must not be used as a door stopper.
- The supply lines need to be measured electrically before connection.

Distances diagram

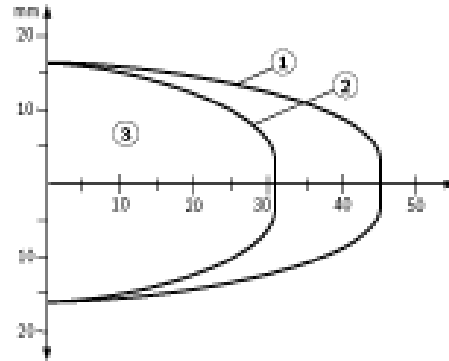

- 1 Extraction
- 2 Proximity switch part
- 3 Standby zone

Parts Included

Type	Qty.	Components
AMK 4 Z	1	Shutter door contact incl. magnet, installation material and cable

Technical Specifications

Type of installation	Surface mount
Permissible operating voltage	Max. 40 V ₋
Contact type	1-pin (normally) open contact
Maximum loop rating	6 VA Max. 100 V ₋ Max. 500 mA
Protection category	IP 67, VdS environmental class IV
Permissible ambient temperature	-25 °C to +70 °C
Housing	
• Material	Polyamide GF
• Color	Gray
Dimensions	
• Contact (H x W x L)	50 x 16.5 x 144 mm
• Magnet (H x W x D)	40 x 35 x 66 mm
• Connection cable (Ø x L)	3.2 mm x 6 m

AMK 4 S Z Shutter Door Contact



- The magnetic switch is installed at ground level (requires a flat surface). Vehicles with rubber tires can drive over the switch without causing problems. In spite of this, the magnetic switch must not be used as a door-stopper.
- The supply lines need to be measured electrically before connection.

Distances diagram

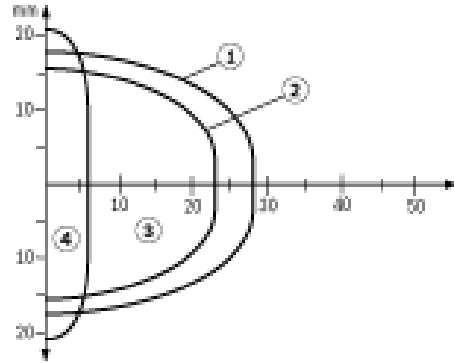

- 1 Extraction
- 2 Proximity switch part
- 3 Standby zone
- 4 Tamper zone

Features

- ▶ Shutter door contact in conventional technology
- ▶ For connection to the conventional intrusion control panel
- ▶ VdS class C
- ▶ Tamper switch
- ▶ High level of mechanical strength
- ▶ Large switch distance
- ▶ Conventional perimeter protection

Conventional shutter door contacts are used to monitor shutter, sliding and garage doors.

Certifications and Approvals

Region	Certification	
Europe	CE	AMK 4 SZ
Germany	VdS	G 191021, C AMK 4 S

Installation/Configuration Notes

Installation notes

- For doors < 1.5 m, one shutter door contact is required. For doors > 1.5 m, use two shutter door contacts. Take note of the permissible installation tolerances.
- The shutter door contact consists of a sealed magnetic switch and a magnet in a plastic casing.
- The connection cable is protected over 1 m by a metal tube.

Parts Included

Type	Qty.	Component
AMK 4 S Z	1	Shutter door contact incl. magnet and installation material and cable

Technical Specifications

Type of installation	Surface mount
Permissible operating voltage	Max. 40 V _~
Contact type	1-pin (normally) open contact
Maximum loop rating	6 VA Max. 100 V _~ Max. 500 mA
Protection category	IP 67, VdS environmental class IV
Permissible ambient temperature	-25 °C to +70 °C
Housing	<ul style="list-style-type: none"> • Material Polyamide GF • Color Gray
Dimensions	<ul style="list-style-type: none"> • Contact (H x W x L) 50 x 16.5 x 144 mm • Magnet (H x W x D) 40 x 35 x 66 mm • Connection cable (Ø x L) 3.2 mm x 6 m

ISM-BLA1-CC Blue Line Color Camera Modules



5

Features

- ▶ **Color charge-coupled device (CCD) camera with 3 lx light sensitivity**
- ▶ **NTSC or PAL video format**
- ▶ **330 lines of horizontal resolution**
- ▶ **The camera can be left on or controlled by the detector alarm**
- ▶ **Selectable (Form A or Form B) alarm relay outputs**
- ▶ **Includes video cable with BNC connector**

The ISM-BLA1-CC color camera modules attach to the Blue Line detectors. These camera modules, available in either NTSC or PAL formats, are small, easy-to-mount, and attractive. Set the camera to run continuously, or to run for either 15 sec or 90 sec when activated by the detector alarm.

The ISM-BLA1-CC-N camera module provides an NTSC video signal of 512 (H) x 492 (V) pixels with electronic shutter speeds from 1/60 sec to 1/100000 sec.

The ISM-BLA1-CC-P camera module provides a PAL video signal of 512 (H) x 582 (V) effective pixels with electronic shutter speeds from 1/50 sec to 1/100000 sec.

Certifications and Approvals

Region	Certification	
Europe	CE	-P model only: 89/336/EEC, EN55022: 1998 +A1: 2000 +A2: 2003 (ANSI C63.4: 2001), EN50130-4: 1996 +A1: 1998 +A2: 2003, EN61000-3-3: 1995 +A1: 2001, EN61000-4-2: 1995 +A1: 1998 +A2: 2001, EN61000-4-3: 2002 +A1: 2002, EN61000-4-4: 1995 +A1: 2000 +A2: 2001, EN61000-4-5: 1995 +A1: 2001, EN61000-4-6: 1996 +A1: 2001, EN61000-4-11: 1994 +A1: 2001
Belgium	INCERT	-P model only: B-509-0021/b
USA	UL	-N model only: ANSR: Intrusion Detection Units (UL639)
Czech Republic	NBU	-P model only

Installation/Configuration Notes

Camera Viewable Area

The camera's field of view is 66° horizontal and 53° vertical. The resulting viewable area depends on the installation height. An example for a 2.3 m (7.5 ft) installation height is shown below:

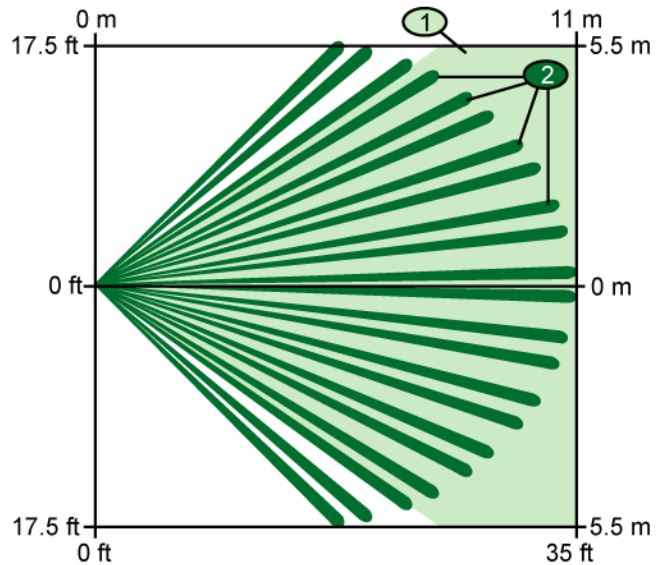

Top View

- 1 Camera's viewable area 2 PIR coverage pattern

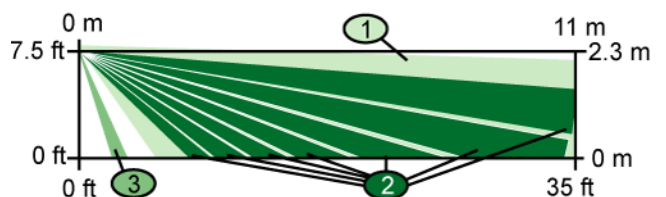

Side View

- | | | | |
|---|------------------------|---|----------------------|
| 1 | Camera's viewable area | 2 | PIR coverage pattern |
| 3 | Look-down zone | | |

Note The passive-infrared (PIR) coverage patterns and look-down zone depend on the specific detector used. Refer to the detector's datasheet.

Note A pair of masks are provided to reduce the detector's PIR coverage area since that area is larger than the camera's field of view.

Power Considerations**Power Limits**

Input power must be provided by an Approved Limited Power Source. All outputs must be connected to SELV (safety extra-low voltage) circuits only.

Standby Power

This detector has no internal standby battery. *For UL Listed product installations, 4 hr (20 mAh with camera off, 460 mAh with camera on) of standby power must be supplied by the control unit or by a UL Listed burglary power supply.*

Video Connection

A video cable with a BNC connector at one end is supplied. Connect this cable to up to 152 m (500 ft) of 75 Ω RG59/U or similar coaxial cable.

Parts Included

Quant.	Component
1	Camera module
1	Mask
1	Hardware pack
1	Literature pack

Technical Specifications**Environmental Considerations**

Complies with EN50131 Environmental Class II, Security Grade 2

Relative Humidity:	0 to 85%, non-condensing
Temperature (operating):	-10°C to +49°C (+14°F to +120°F) <i>For UL Listed product installations, 0°C to +49°C (+32°F to +120°F)</i>

Input

Alarm: 5 V normally from sensor digital alarm output, ground for 4 sec during alarm.

Mechanical Properties

Color:	White
Dimensions:	5.6 cm x 6.1 cm x 4.8 cm (2.2 in. x 2.4 in. x 1.9 in.)
Material:	High-impact ABS plastic
Radio Frequency Interference (RFI) Immunity:	No alarm or setup on critical frequencies in the range from 26 MHz to 2 GHz at field strengths less than 30 V/m.

Outputs

Relay Timer:	Selectable latch time of 15 sec or 90 sec.
Timed Relay:	Solid state, selectable supervised Form A normally-closed (NC) or unsupervised Form B normally-open (NO) contacts rated for 125 mA, 28 VDC, 3 W.
Tamper:	Normally-closed (NC) contacts (with cover on) rated at 28 VDC, 125 mA maximum. Connect to detector tamper circuit.

Power Requirements

Current (Alarm):	115 mA when camera is on
Current (Standby):	5 mA maximum at 12 VDC
Voltage (Operating):	12 VDC nominal

Video

CCD:	8.5 mm (1/3-inch) color with an electronic shutter
Field of view:	66° horizontal, 53° vertical
Lens:	3.6 mm fixed focal length lens
Resolution (horizontal):	330 lines minimum at center of picture
Scanning System:	2:1 interlaced
Sensitivity:	<3 lx
Signal:	75 Ω (NTSC or PAL)
Signal to Noise Ratio:	45 dB minimum

Ordering Information

ISM-BLA1-CC Blue Line Color Camera Module (NTSC format)
NTSC format

ISM-BLA1-CC-N

ISM-BLA1-CC Blue Line Color Camera Module (PAL format)
PAL format

ISM-BLA1-CC-P

ISM-BLA1-LM Blue Line Nightlight Module



5

Features

- ▶ **Modular construction fits all Blue Line detectors**
- ▶ **High quality, affordable, and easy to install**
- ▶ **Exterior switches control light duration (short or long) and on or off**
- ▶ **Two installer-selectable brightness levels**
- ▶ **Aesthetic design**

The Blue Line ISM-BLA1-LM Nightlight Module attaches to the Blue Line detectors. When the detector senses a presence, the module's LEDs light and provide illumination up to the equivalent of bright moonlight (0.1 cd at 30 cm [1 ft] from the detector).

Functions

Unique Interface

The Blue Line Nightlight Module mounts on top of and is wired to a Blue Line detector. This unique interface between module and detector makes installation fast, easy, and inexpensive. Once the detector is mounted and wired to the control panel, you simply add the module with no additional wiring needed.

Basic Operation

The nightlight module has a photo-sensor and four LEDs under a diffusing lens. It mounts on, draws its power from, and is controlled by any Blue Line detector. Once installed and set, if the detector senses motion and the photo-sensor does not detect light, the LEDs light.

Settings

Brightness

The brightness level can be set for low or high by positioning a jumper during module installation.

Duration

The length of time the LEDs remain lit is set with an external switch on the side of the module. Short duration is approximately 20 sec to 30 sec; while long duration is approximately 2 min to 4 min.

On-Off

Use the external On or Off switch on the side of the module to determine if the LEDs light when motion is detected.

Field Testing

The module comes with a piece of black plastic for covering the photo-sensor for field testing the module.

Certifications and Approvals

Region	Certification	
Europe	CE	89/336/EEC, EN50130-4: 1996 +A1: 1998 +A2: 2003, EN61000-4-2: 1995 +A1: 1998 +A2: 2001, EN61000-4-3: 2002 +A1: 2002 +A2: 2005, EN61000-4-4: 1995 +A1: 2000 +A2: 2001, EN61000-4-5: 1995 +A1: 2001, EN61000-4-6: 1996 +A1: 2001 +A2: 2001 +A3: 2005, EN61000-4-11:1994 +A1: 2001
Russia	GOST	GOST 12997-84, GOST R 50009-2000, GOST R 51317.3.2-99, GOST R 51317.3.3-99, GOST R MEK 60065-2002
USA	UL	ANSR: Intrusion Detection Units (UL639), ANSR7: Intrusion Detection Units Certified for Canada (cULus)
Belgium	INCERT	B-509-0009/a

Installation/Configuration Notes

Compatibility Information

The BLA1-LM Nightlight Module is compatible with the following products:

Detectors	Model	Description
	BLD1	Blue Line TriTech® Detectors
	BLD1-P	Blue Line Pet Friendly® TriTech® Detectors
	BLP1	Blue Line PIR Detector
	BLP1-P	Blue Line Pet Friendly® PIR Detector
	BLQ1	Blue Line quad PIR Detector

Mounting Considerations

The nightlight module mounts on top of a Blue Line detector by removing the detector from its mounting base, installing the module on the detector base, and reattaching the detector and the module lens. Ensure there is enough space above the detector for the nightlight module.

Wiring Considerations

The three module wires attach to the terminal block of the Blue Line detector.

Parts Included

Quant.	Component
1	Nightlight module
1	Test filter
1	Literature pack

Technical Specifications

Environmental Considerations

Complies with EN50131 Environmental Class II, Security Grade 2

Relative Humidity:	Up to 95% non-condensing <i>Up to 85% for UL installations</i>
--------------------	-------------------------------------------------------------------

Temperature (operating):	-10°C to +49°C (+14°F to +120°F) <i>For UL Listed product installations, 0°C to +49°C (+32°F to +120°F)</i>
--------------------------	--------------------------------------------------------------------------------------------------------------------

Mechanical Properties

Color:	White
--------	-------

Dimensions:	2.5 cm x 6.4 cm x 3.2 cm (1.0 in. X 2.5 in. X 1.25 in.)
-------------	------------------------------------------------------------

Material:	High-impact ABS plastic
-----------	-------------------------

Output

Light Intensity:	0.1 cd at 30 cm (1 ft)
------------------	------------------------

Power Requirements

Current Draw (LEDs lit):	Brightness level set low: 40 mA Brightness level set high: 75 mA
-----------------------------	---------------------------------------------------------------------

Standby Power:	No internal standby battery. <i>Standby power must be provided by the control unit or by a UL Listed burglary power supply.</i>
----------------	---------------------------------------------------------------------------------------------------------------------------------

Ordering Information

ISM-BLA1-LM Blue Line Nightlight Module **ISM-BLA1-LM**

Fits all Blue Line detectors

ISM-BLA1-SM Blue Line Sounder Module



5

Features

- ▶ **Modular construction fits all Blue Line detectors**
- ▶ **High quality, affordable, and easy to install**
- ▶ **Annunciator 85 dB at 3 m (10 ft)**
- ▶ **Built-in normally-closed tamper circuit**
- ▶ **Aesthetic design**

The Blue Line ISM-BLA1-SM Sounder Module mounts on top of the Blue Line Detectors, but is completely supervised and controlled by the control panel. When activated, the sounder emits a loud tone until silenced from the control panel.

Functions

Sounder Activation

A sounder module or modules activate when the control panel supplies power to the sounder loop.

Tamper Supervision

When so wired, the control panel supervises the normally-closed (NC) tamper circuit. Refer to the control panel's installation manual for specific tamper circuit wiring and termination instructions and specifications.

Certifications and Approvals

Region	Certification	
Europe	CE	89/336/EEC, EN50130-4: 1996 +A1: 1998 +A2: 2003, EN61000-4-2: 1995 +A1: 1998 +A2: 2001, EN61000-4-3: 2002 +A1: 2002, EN61000-4-4: 1995 +A1: 2000 +A2: 2001, EN61000-4-5: 1995 +A1: 2001, EN61000-4-6: 1996 +A1: 2001, EN61000-4-11:1994 +A1: 2001
USA	UL	NBSX: Household Burglar Alarm System Units (UL1023), NBSX7: Household Burglar Alarm System Units Certified for Canada (cULus)

Installation/Configuration Notes

Compatibility Information

The BLA1-SM Sounder Module is compatible with the following products:

Category	Product ID	Product Description
Control Panels:		Compatible with all 12 VDC control panels
Detectors:	BLD1	Blue Line TriTech® Detectors
	BLD1-P	Blue Line Pet Friendly® TriTech® Detectors
	BLP1	Blue Line PIR Detector
	BLP1-P	Blue Line Pet Friendly®PIR Detector
	BLQ1	Blue Line quad PIR Detector

Mounting Considerations

The sounder module mounts on top of a Blue Line detector by removing the detector from its mounting base, installing the sounder base on the detector base, and reattaching the detector and the sounder cover. Ensure there is enough space above the detector for the sounder module.

Wiring Considerations

The terminal block on the sounder module accepts wires up to 1.5 mm (16 AWG) in diameter. For specific wiring instructions and specifications, refer to the control panel's installation manual.

Parts Included

Quant.	Component
1	Sounder module
1	Literature pack

Technical Specifications**Environmental Considerations**

Complies with EN50131 Environmental Class II, Security Grade 2

Relative Humidity: Up to 95% non-condensing
Up to 85% for UL installations

Temperature (operating): -10°C to +49°C (+14°F to +120°F)
For UL Listed product installations, 0°C to +49°C (+32°F to +120°F)

Mechanical Properties

Color: White

Dimensions: 2.5 cm x 6.4 cm x 3.2 cm
(1.0 in. x 2.5 in. x 1.25 in.)

Material: High-impact ABS plastic

Outputs**Sounder**

Sound Pressure Level: 85 dB at 3 m (10 ft)

Tamper: Normally-closed (NC) contacts (with cover on) rated at 28 VDC, 125 mA maximum. Connect to detector tamper circuit.

Power Requirements

Power Draw: 40 mA maximum at 12 VDC with sounder activated

Voltage (input): 12 VDC nominal

Ordering Information

ISM-BLA1-SM Blue Line Sounder Module **ISM-BLA1-SM**
Fits all Blue Line detectors

B328 Gimbal-mount Bracket



Mounts on a single-gang box and allows rotation of a detector. Wires are hidden inside.

Ordering Information

B328 Gimbal-mount Bracket **B328**
Mounts on a single-gang box and allows rotation of a detector. Wires are hidden inside.

Swiveling B335-3 low-profile mount



Surface-mount the plastic, low-profile mount to the wall. It is suitable for use with many detector types. The vertical swivel range is $+10^{\circ}$ to -20° , while the horizontal swivel range is $\pm 25^{\circ}$.

Note Pet interference immunity can no longer be assured when using this mount.

Available in triple packs.

Certifications and Approvals

Region	Certification
Belgium	INCERT B-509-0021/b

Ordering Information

Swiveling B335-3 low-profile mount	B335-3
Swiveling, low-profile, plastic mount for wall mounting. The vertical swivel range is $+10^{\circ}$ to -20° , while the horizontal swivel range is $\pm 25^{\circ}$. Available in triple packs.	

B800 Ceiling-mount Bracket



Surface mounts detectors to the ceiling. The vertical pivot range is $+7^{\circ}$ to -16° ; the horizontal pivot range is $\pm 45^{\circ}$. Do not use for pet applications.

Ordering Information

B800 Ceiling-mount Bracket	B800
Surface mounts detectors to the ceiling. The vertical pivot range is $+7^{\circ}$ to -16° ; the horizontal pivot range is $\pm 45^{\circ}$. Do not use for pet applications.	

DS1110i Glassbreak Tester



The DS1110i Glassbreak Tester is used to test DS1101i, DS1102i, DS1103i, and DS1108i Glass Break Detectors. It is powered by a 9 V alkaline battery (supplied).

Certifications and Approvals

Region	Certification	
Europe	CE	89/336/EEC, EN55022: 1998 +A1: 2000 +A2: 2003, EN50130-4: 1996 +A1: 1998 +A2: 2003, EN61000-4-2: 1995 +A1: 1998 +A2: 2001, EN61000-4-3: 2002 +A1: 2003, EN61000-4-4: 1995 +A1: 2000 +A2: 2001, EN61000-4-5: 1995 +A1: 2001, EN61000-4-6: 1996 +A1: 2001 +A2: 2001, EN61000-4-11: 1994 +A1: 2001, EN60950-1: 2001 +A11: 2004
USA	UL	ANSR: Intrusion Detection Units (UL639)

Ordering Information

DS1110i Glassbreak Tester **DS1110i**
 Used to test DS1101i, DS1102i, DS1103i, and DS1108i Glass Break Detectors. Powered by a 9 V alkaline battery (supplied).

MP1 Metal Pole, 1 m (3 ft)



Straight metal poles measuring 1 m (3 ft) for pole mounting photoelectric detectors. Shipped in packages of two.

Ordering Information

MP1 Metal Pole, 1 m (3 ft) **MP1**
 Straight metal poles measuring 1 m (3 ft) for pole mounting photoelectric detectors. Shipped in packages of two.

MP2 Metal Pole, 1.2 m (4 ft)



Straight metal poles measuring 1.2 m (4 ft) for pole mounting photoelectric detectors. Shipped in packages of two.

Ordering Information

MP2 Metal Pole, 1.2 m (4 ft)

Straight metal poles measuring 1.2 m (4 ft) for pole mounting photoelectric detectors. Shipped in packages of two.

MP2

MP3 L-Curved Metal Pole



Curved metal poles for mounting to vertical surfaces for pole mounting photoelectric detectors. Shipped in packages of two.

Ordering Information

MP3 L-Curved Metal Pole

Curved metal poles for mounting to vertical surfaces for pole mounting photoelectric detectors. Shipped in packages of two.

MP3

OA120-2 Mirror

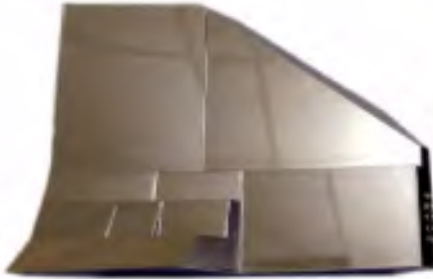

A 36.5 m (120 ft) optical array module. Shipped in packages of two.

Ordering Information

OA120-2 Mirror

A 36.5 m (120 ft) optical array module. Shipped in packages of two.

OA120-2

OLR92-3 Long-range Lens



Provides long-range coverage with a 30.5 m x 3 m (100 ft x 10 ft) pattern. Shipped in packages of three.

Ordering Information

OLR92-3 Long-range Lens

Provides long-range coverage with a 30.5 m x 3 m (100 ft x 10 ft) pattern. Shipped in packages of three.

OLR92-3

OMB77-3 Barrier Mirror



Provides barrier coverage with a 25 m x 5 m (80 ft x 16 ft) pattern. Shipped in packages of three.

Ordering Information

OMB77-3 Barrier Mirror

Provides barrier coverage with a 25 m x 5 m (80 ft x 16 ft) pattern. Shipped in packages of three.

OMB77-3

OMLR77-3 Long-range Mirror



Provides long-range coverage with a 40 m x 3 m (120 ft x 10 ft) pattern. Shipped in packages of three.

Ordering Information

OMLR77-3 Long-range Mirror

Provides long-range coverage with a 40 m x 3 m (120 ft x 10 ft) pattern. Shipped in packages of three.

OMLR77-3

OMLR93-3 Long-range Mirror



Provides long-range coverage with a 21 m x 3 m (70 ft x 10 ft) pattern. Shipped in packages of three.

Ordering Information

OMLR93-3 Long-range Mirror

Provides long-range coverage with a 21 m x 3 m (70 ft x 10 ft) pattern. Shipped in packages of three.

OMLR93-3

PC1A Weather Enclosure



Ordering Information

PC1A Weather Enclosure

Protects detectors when mounted outside. The enclosure's dimensions are 39.4 cm x 10.3 cm x 6 cm (15.5 in. x 4 in. x 2.4 in.). Shipped in packages of two.

PC1A

PEH-2 Heater

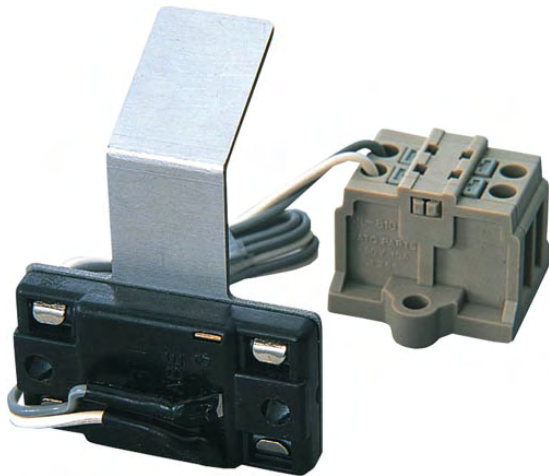

5

Features

- ▶ **Automatic temperature control maintains a constant temperature**
- ▶ **Made of durable ceramic to withstand weathering**
- ▶ **Horizontally adjustable radiator coordinates with the angle of photoelectric detector optical modules**

The PEH-2 Heater is a heating device that prevents frost accumulation on photoelectric beam detector covers, promoting stable performance.

Installation/Configuration Notes

Compatibility Information

Photoelectric Beam Detectors **DS484Q, DS486Q, DS453Q, and DS455Q**

Parts Included

Quantity	Component
2	Heaters (heating element, radiator, terminal)
4	Heater mounting screws
4	Terminal mounting screws
2	Stoppers
1	Installation Guide

Technical Specifications

Weight

Total Weight: 15 g (0.03 lb)

Environmental Considerations

Operating Temperature: -25°C to +60°C (-13°F to +140°F)

Relative Humidity (RH): Up to 95%

Surface Temperature: +55°C (131°F)

Power Requirements

Power Supply Voltage: 20 VDC to 28 VDC non-polarized

Current Draw: 350 mA maximum when power is applied 110 mA during operation (for each heater)

Backup Power Requirements: 4 hours (440 mAh) minimum required for UL Certificated Installations

Ordering Information

PEH-2 Heater

PEH2

Reduces the effects of frost, intense fog, cold, and damp conditions on photoelectric beam detectors. Shipped in packages of four (two for transmitter and two for receiver).

TP160 Trim Plate



A light gray trim plate used when mounting the detector over a standard single-gang box.

Ordering Information

TP160 Trim Plate

A light gray trim plate used when mounting the detector over a standard single-gang box.

TP160

TP161 Trim Plate



A black trim plate used when mounting the sensor over a standard single-gang box.

Ordering Information

TP161 Trim Plate

A black trim plate used when mounting the sensor over a standard single-gang box.

TP161

LSN Motion PIR/Microwave	302
LSN Seismic	322
LSN Glassbreak	325
LSN Smoke	327
LSN Magnetic Contacts	343
LSN Holdup	366
LSN Expansion Modules	367
LSN Display Panels	381
LSN Power Supplies	383

ISP-PPR1-WA16x Professional Series LSN PIR Detectors with Anti-mask



6

Features

- ▶ **16 m x 21 m (50 ft x 70 ft) standard coverage, 8 m x 10 m (25 ft x 33 ft) selectable short range coverage**
- ▶ **EN50131-2-2 Grade 3 and VdS Class C compliant**
- ▶ **Sensor data fusion technology**
- ▶ **MANTIS anti-mask**
- ▶ **Active white light suppression**
- ▶ **Dynamic temperature compensation**
- ▶ **Local Security Network(LSN) technology supports flexible structures and programming, high current, and up to 254 devices**
- ▶ **2 m to 3 m (7 ft to 10 ft) mounting height, no adjustments required**

The ISP-PPR1-WA16x Professional Series PIR LSN Detectors with Anti-mask are two-wire bus units for commercial indoor applications with the Bosch Local Security Network (LSN). Each detector sends alarm, trouble, tamper, or anti-mask signals through serial communication on the LSN bus. With LSN, there can be a short or open at any point in the loop and all devices still function. The LSN technology supports flexible structures, efficient programming, and high current levels.

MANTIS anti-mask technology makes obscuring the detector view nearly impossible for intruders. Sensor data fusion technology ensures that alarm conditions are based on precise information. The powerful combination of unique features in the Professional Series delivers superior catch performance and virtually eliminates false alarms.

The self-locking two-piece enclosure, built-in bubble level, flexible mounting height, and three optional mounting brackets simplify installation and reduce service time.

System Overview

LSN Technology

This detector is a two-wire unit for use with the Bosch Local Security Network system (LSN and LSN Improved). It communicates alarm, trouble or tamper conditions through serial communication on the LSN bus.

The detectors send the following condition signals through LSN serial communication:

- Alarm, anti-mask, tamper, or trouble
- Remote self test response

The control panel sends the following condition or status commands through LSN serial communication to the detector:

- Device reset
- Armed/disarmed status
- Alarm, anti-mask, tamper, and trouble signals*
- LED controls for alarm, anti-mask, and trouble
- Anti-mask on/off
- Field selectable coverage range
- Remote self test

**The control panel can put the signals into latch or real time mode.*

Functions

Sensor Data Fusion Technology

Sensor data fusion technology is a unique feature that uses a sophisticated software algorithm to gather signals from multiple sensors: two pyroelectric sensors, a room temperature sensor, and a white light level sensor. The microcontroller analyzes and compares the sensor data to make the most intelligent alarm decisions in the security industry.

Microwave Assist Technology

Microwave assist technology provides additional input into the sensor data fusion signal processing algorithm to improve alarm decisions when PIR signals are similar to false alarm sources.

Tri-focus Optics Technology

Tri-focus optics technology uses optics with three specific focal lengths: long-range coverage, middle-range coverage, and short-range coverage. The detector applies the three focal lengths to 86 detection zones, which combine to make 11 solid curtains of detection. Tri-focus optics technology also includes two pyroelectric sensors, which deliver twice the standard optical gain. The sensors process multiple signals to deliver precise performance virtually free of false alarms.

MANTIS Anti-mask Technology

MANTIS (**M**ulti-point **A**nti-mask with **I**ntegrated **S**pray detection) uses patented prism lenses and active infrared detection to provide industry-leading protection against all known forms of attack. MANTIS complies with the latest worldwide regulatory standards for detecting objects covering or placed in front of the detector. MANTIS is sensitive to materials regardless of texture or color, including fabric, paper, metal, plastic, tape, and spray. When MANTIS identifies a masking material, the detector sends an anti-mask signal to the control panel through serial communication on the LSN bus.

Installers can disable or enable the anti-mask feature. This task is performed at the control panel.

Active White Light Suppression

An internal light sensor measures the level of light intensity directed at the face of the detector. Sensor data fusion technology uses this information to eliminate false alarms from bright light sources.

Available Coverage

The standard coverage is 16 m x 21 m (50 ft x 70 ft). Installers can select short range coverage of 8 m x 10 m (25 ft x 33 ft) at the control panel (serial communication from control panel to detector over the LSN bus).

Dynamic Temperature Compensation

The detector automatically adjusts PIR sensitivity to identify human intruders at critical temperatures. Dynamic temperature compensation detects human body heat accurately, avoids false alarms, and delivers consistent catch performance at all operating temperatures.

Cover and Wall Tamper Switch

When an intruder removes the cover or attempts to separate the detector from the wall, a normally closed contact opens causing the detector to send a tamper message to the control panel.

Remote Walk Test LED

Users can enter a command through a keypad, a control center, or programming software to remotely enable or disable the walk test LED.

Draft, Insect, and Small Animal Immunity

The sealed optic chamber provides immunity to drafts and insects, reducing false alarms. Small animal immunity reduces false alarms caused by animals less than 4.5 kg (10 lb), such as rodents.

Remote Self Test

When the control panel sends a remote self test message to the detector, the detector tests its detection systems. If any system fails, the detector sends a self test fail message to the control panel. If all systems pass, the detector sends a self test pass message to the control panel. If the system is configured for local LED control, the alarm LED activates for four seconds following a successful test or flashes after a failed test.

Flexible Topologies

Each detector can be added to flexible LSN structures such as loops, stubs, T-tap, tee-offs, and mixed.

Short circuit isolators in each detector increase system integrity and cost savings. If a short occurs in the loop, all the devices continue to function.

Flexible Addressing and Programming Options

Installers can use rotary switches to set addresses or program-specific options on the detectors.

Using the control panel, installers can centrally program all device configurations. Additionally, all the detectors on the loop are automatically identified and shown on the control panel. The loop can be expanded and new detectors can be added without new programming.

Certifications and Approvals

Region	Certification	
Europe	CE	2004/108/EC EMC Directive; 1999/5/EC Radio Equipment and Telecommunications terminal Equipment, Annex V; EN 50130-4: 1996; ETSI EN 300 440-1, V1.3.1 (2001-09); ETSI EN 300 489-1, V1.6.1 (2005-09); EN 60950-1: 2006

The detectors are designed to comply with the following standards and approvals.

Europe	EN50131	EN50131-2-4 Grade 3
Germany	VdS Schadenverhütung GmbH	Class C
	BSI	

Installation/Configuration Notes

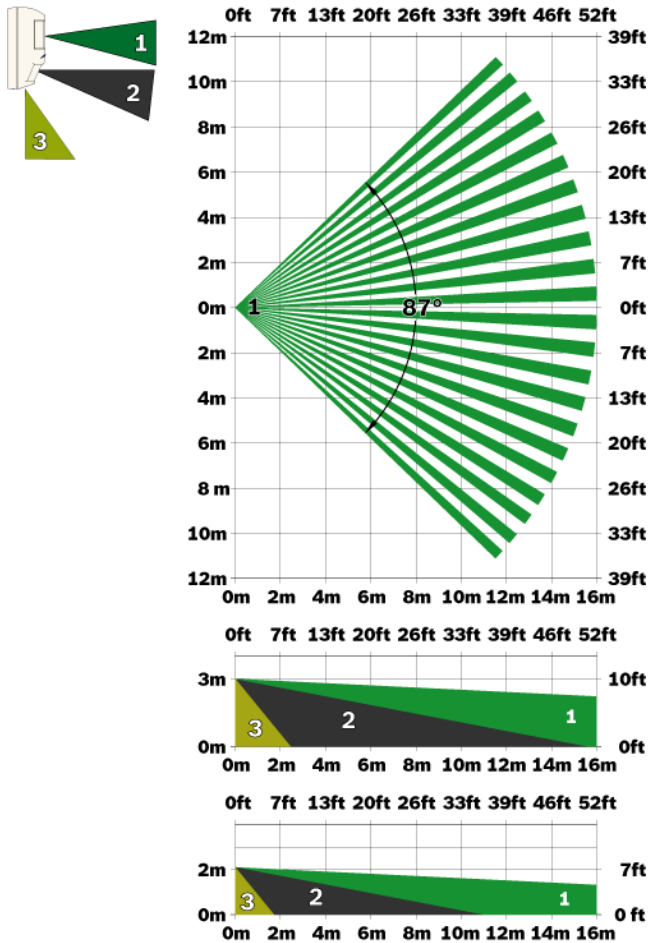

Long-range Coverage 16 m x 21 m (50 ft x 70 ft)

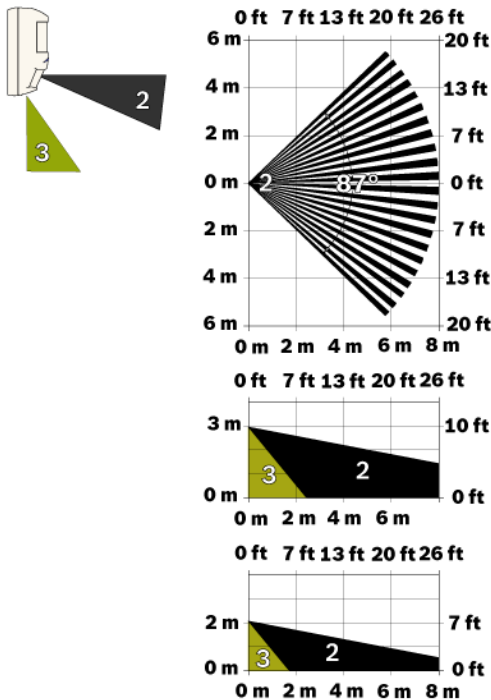

Selectable Short-range Coverage 8 m x 10 m (25 ft x 33 ft)

Mounting Considerations

The recommended mounting height is 2 m to 3 m (7 ft to 10 ft).

Use an optional B328 Gimbal-mount Bracket or B335-3 Low-profile Swivel-mount Bracket to surface-mount the detector on a flat wall or in a corner.

Use an optional B338 Universal Ceiling Bracket to mount the detector on the ceiling.

Wiring Considerations

Recommended wire size is 0.2 mm² to 1 mm² (26 AWG to 16 AWG).

Parts Included

Quantity	Component
1	Detector
2	Flat-head screws
2	Screw anchors
1	Nylon cable tie
1	Pattern Mask
1	Installation Guide

Technical Specifications

Electrical

Power Requirements

Voltage Range:	9 VDC to 28 VDC
Current Consumption:	< 5 mA
Outputs:	Serial communications over LSN bus

Mechanical

Enclosure Design

Color:	White
Dimensions:	127 mm x 69 mm x 58 mm (5 in. x 2.75 in. x 2.25 in.)
Material:	High-impact ABS plastic

Indicators

Alarm Indicator:	Blue alarm LED
------------------	----------------

Environmental

Relative Humidity:	0 to 95%, non-condensing
Temperature (Operating and Storage):	-30°C to +55°C (-20°F to +130°F) For AFNOR certificated installations, -10°C to +55°C (+14°F to +130°F) For UL Certificated installations, 0°C to +49°C (+32°F to +120°F)
Environmental Class II:	EN 50130-5
Protection Rating:	IK04 (EN 50102)

Ordering Information

ISP-PPR1-WA16G LSN PIR Detector with Anti-mask 10.525 GHz frequency.	ISP-PPR1-WA16G
--------------------------------------------------------------------------------	-----------------------

ISP-PPR1-WA16H LSN PIR Detector with Anti-mask 10.588 GHz frequency. For use in France and the United Kingdom.	ISP-PPR1-WA16H
--------------------------------------------------------------------------------------------------------------------------	-----------------------

ISP-PPR1-WA16K LSN PIR Detector with Anti-mask 9.35 GHz frequency.	ISP-PPR1-WA16K
------------------------------------------------------------------------------	-----------------------

Accessories

B328 Gimbal-mount Bracket Mounts on a single-gang box and allows rotation of a detector. Wires are hidden inside.	B328
-----------------------------------------------------------------------------------------------------------------------------	-------------

Swiveling B335-3 low-profile mount Swiveling, low-profile, plastic mount for wall mounting. The vertical swivel range is +10° to -20°, while the horizontal swivel range is ±25°. Available in triple packs.	B335-3
------------------------------------------------------------------------------------------------------------------------------------------------------------------------------------------------------------------------	---------------

ISP-PDL1-WA18x Professional Series LSN TriTech+ Detectors with Anti-mask



6

Features

- ▶ **18 m x 25 m (60 ft x 80 ft) standard coverage; 8 m x 10 m (25 ft x 33 ft) selectable short range coverage**
- ▶ **EN 50131-2-4 Grade 3 and VDS Class C compliant**
- ▶ **Sensor data fusion technology**
- ▶ **Range adaptive radar**
- ▶ **MANTIS anti-mask**
- ▶ **Active white light suppression**
- ▶ **Dynamic temperature compensation**
- ▶ **Designed for difficult environments**
- ▶ **Local Security Network(LSN) technology supports flexible structures and programming, high current, and up to 254 devices**
- ▶ **2 m to 3 m (7 ft to 10 ft) mounting height, no adjustments required**

The ISP-PDL1-WA18x Professional Series LSN TriTech+ Detectors with Anti-mask are two-wire bus units for commercial indoor applications with the Bosch Local Security Network (LSN). Each detector sends alarm, trouble, tamper, or anti-mask signals through serial communication on the LSN bus. With LSN, there can be a short or open at any point in the loop and all devices still function. The LSN technology supports flexible structures, efficient programming, and high current levels.

MANTIS anti-mask technology makes obscuring the detector view nearly impossible for intruders. Sensor data fusion technology ensures that alarm conditions are based on precise information. The powerful combination of unique features in the Professional Series delivers superior catch performance and virtually eliminates false alarms.

The self-locking two-piece enclosure, built-in bubble level, flexible mounting height, and three optional mounting brackets simplify installation and reduce service time.

System Overview

LSN Technology

This detector is a two-wire unit for use with the Bosch Local Security Network system (LSN and LSN Improved). It communicates alarm, trouble or tamper conditions through serial communication on the LSN bus.

The detectors send the following condition signals through LSN serial communication:

- Alarm, anti-mask, tamper, or trouble
- Remote self test response

The control panel sends the following condition and status commands through LSN serial communication to the detector:

- Device reset
- Armed/disarmed status
- Alarm, anti-mask, tamper, and trouble signals*
- LED controls for alarm, anti-mask, and trouble
- Anti-mask on/off
- Selectable coverage range
- Remote self test

**The control panel can put the signal into latch or real time mode.*

Functions

Sensor Data Fusion Technology

Sensor data fusion technology is a unique feature that uses a sophisticated software algorithm to gather signals from five sensors: two pyroelectric sensors, a range adaptive radar sensor, a room temperature sensor, and a white light level sensor. The microcontroller analyzes and compares the sensor data to make the most intelligent alarm decisions in the security industry.

Tri-focus Optics Technology

Tri-focus optics technology uses optics with three specific focal lengths: long-range coverage, middle-range coverage, and short-range coverage. The detector applies the three focal lengths to 86 detection zones, which combine to make 11 solid curtains of detection. Tri-focus optics technology also includes two pyroelectric sensors, which deliver twice the standard optical gain. The sensors process multiple signals to deliver precise performance virtually free of false alarms.

Range Adaptive Radar

The microwave transceiver automatically adjusts its detection thresholds based on input from the PIR sensors. Integrating the target distance information from the PIR significantly reduces false alarms from the microwave Doppler radar.

MANTIS Anti-mask Technology

MANTIS (Multi-point Anti-mask with Integrated Spray detection) uses patented prism lenses and active infrared detection to provide industry-leading protection against all known forms of attack. MANTIS complies with the latest world-wide regulatory standards for detecting objects covering or placed in front of the detector. MANTIS is sensitive to materials regardless of texture or color, including fabric, paper, metal, plastic, tape, and spray. When MANTIS identifies a masking material, the detector sends an anti-mask signal to the control panel through serial communication on the LSN bus.

Installers can disable or enable the anti-mask feature. This task is performed at the control panel.

Active White Light Suppression

An internal light sensor measures the level of light intensity directed at the face of the detector. Sensor data fusion technology uses this information to eliminate false alarms from bright light sources.

Available Coverage

The standard coverage is 18 m x 25 m (60 ft x 80 ft). Installers can select short range coverage of 8 m x 10 m (25 ft x 33 ft) at the control panel (serial communication from control panel to detector over the LSN bus).

Dynamic Temperature Compensation

The detector automatically adjusts PIR sensitivity to identify human intruders at critical temperatures. Dynamic temperature compensation detects human body heat accurately, avoids false alarms, and delivers consistent catch performance at all operating temperatures.

Cover and Wall Tamper Switch

When an intruder removes the cover or attempts to separate the detector from the wall, a normally-closed contact opens causing the detector to send a tamper message to the control panel.

Remote Walk Test LED

Users can enter a command through a keypad, a control center, or programming software to enable or disable the walk test LED.

Draft, Insect, and Small Animal Immunity

The sealed optic chamber provides immunity to drafts and insects, reducing false alarms. Small animal immunity reduces false alarms caused by animals less than 4.5 kg (10 lb), such as rodents.

Remote Self Test

When the control panel sends a remote self test message to the detector, the detector tests its detection systems. If any system fails, the detector sends a self test fail message to the control panel. If all systems pass, the detector sends a self test pass message to the control panel. If the system is configured for local LED control, the alarm LED activates for four seconds following a successful test or flashes after a failed test.

Flexible Topologies

Each detector can be added to flexible LSN structures such as loops, stubs, T-tap, tee-offs, and mixed.

Short circuit isolators in each detector increase system integrity and cost savings. If a short occurs in the loop, all the devices continue to function.

Flexible Addressing and Programming Options

Installers can use rotary switches to set addresses or program-specific options on the detectors.

Using the control panel, installers can centrally program all device configurations. Additionally, all the detectors on the loop are automatically identified and shown on the control panel. The loop can be expanded and new detectors can be added without new programming.

Certifications and Approvals

Region	Certification	
Europe	CE	2004/108/EC EMC Directive; 1999/5/EC Radio Equipment and Telecommunications terminal Equipment, Annex V; EN 50130-4; 1996; ETSI EN 300 440-1, V1.3.1 (2001-09); ETSI EN 300 489-1, V1.6.1 (2005-09); EN 60950-1: 2006
USA	FCC	WA18G only: T3XISPPDL1-WA18G Part 15 Field Disturbance Sensor

The detectors are also designed to comply with the following standards and approvals.

Europe	EN50131	EN50131-2-4 Grade 3
Belgium	INCERT	B-509-0009
France	AFNOR	NF, A2P
Germany	VdS Schadenverhütung GmbH	Class C
Italy	IMQ	

Installation/Configuration Notes

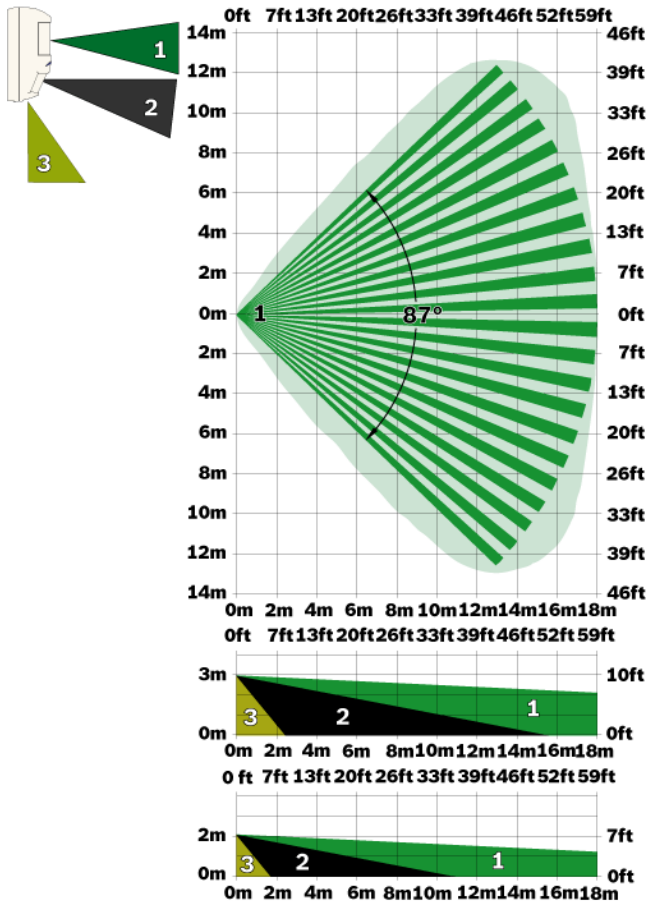

Long-range Coverage 18 m x 25 m (60 ft x 80 ft)

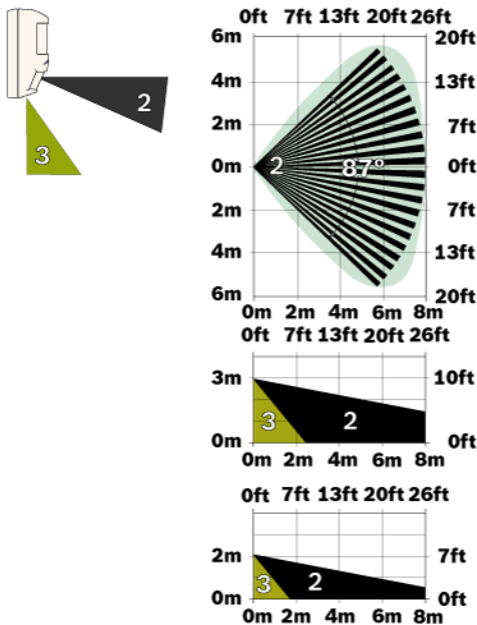

Selectable Short-range Coverage 8 m x 10 m (25 ft x 33 ft)

Mounting Considerations

The recommended mounting height is 2 m to 3 m (7 ft to 10 ft).

Use an optional B328 Gimbal-mount Bracket or B335-3 Low-profile Swivel-mount Bracket to surface-mount the detector on a flat wall or in a corner.

Use an optional B338 Universal Ceiling Bracket to mount the detector on the ceiling.

Wiring Considerations

Recommended wire size is 0.2 mm² to 1 mm² (26 AWG to 16 AWG)

Parts Included

Quantity	Component
1	Detector
2	Flat-head screws
2	Screw anchors
1	Nylon cable tie
1	Pattern Mask
1	Installation Guide

Technical Specifications

Electrical

Power Requirements

Voltage Range:	9 VDC to 28 VDC
Current Consumption:	< 5 mA
Outputs:	Serial communications over LSN bus

Mechanical

Enclosure Design

Color:	White
Dimensions:	127 mm x 69 mm x 58 mm (5 in. x 2.75 in. x 2.25 in.)
Material:	High-impact ABS plastic

Indicators

Alarm Indicator:	<ul style="list-style-type: none"> Blue LED for TriTech+ alarms Yellow LED for microwave alarms Red LED for PIR alarms
------------------	---------------------------------------------------------------------------------------------------------------------------------------------------------

Zones

Zones:	86
--------	----

Environmental

Relative Humidity:	0 to 95%, non-condensing
Temperature (Operating and Storage):	-30°C to +55°C (-20°F to +130°F) For AFNOR certificated installations, -10°C to +55°C (+14°F to +130°F) For UL Certificated installations, 0°C to +49°C (+32°F to +120°F)

Environmental Class II:	EN 50130-5
Protection Rating:	IK04 (EN 50102)

Ordering Information

ISP-PDL1-WA18G LSN TriTech+ Detector with Anti-mask 10.525 GHz frequency.	ISP-PDL1-WA18G
-------------------------------------------------------------------------------------	-----------------------

ISP-PDL1-WA18H LSN TriTech+ Detector with Anti-mask 10.588 GHz frequency. For use in France and the United Kingdom.	ISP-PDL1-WA18H
-------------------------------------------------------------------------------------------------------------------------------	-----------------------

ISP-PDL1-WA18K LSN TriTech+ Detector with Anti-mask 9.35 GHz frequency.	ISP-PDL1-WA18K
-----------------------------------------------------------------------------------	-----------------------

Accessories

B328 Gimbal-mount Bracket Mounts on a single-gang box and allows rotation of a detector. Wires are hidden inside.	B328
-----------------------------------------------------------------------------------------------------------------------------	-------------

Swiveling B335-3 low-profile mount Swiveling, low-profile, plastic mount for wall mounting. The vertical swivel range is +10° to -20°, while the horizontal swivel range is ±25°. Available in triple packs.	B335-3
------------------------------------------------------------------------------------------------------------------------------------------------------------------------------------------------------------------------	---------------

DS 935 LSN Infrared Motion Detector



6

Features

- ▶ **Wide-angle version (standard) up to 11 m**
- ▶ **Long-range version (optional) up to 21 m**
- ▶ **Remote-controlled alarm/walk test display**
- ▶ **Tamper contact**
- ▶ **Programming of the detector is carried out by configuration software in the corresponding LSN control panel.**
- ▶ **Alarm, tampering and faults are evaluated via the LSN bus**
- ▶ **2-wire connection to LSN**

The DS 935 LSN infrared motion detector is used to monitor rooms for unauthorized entry.

PIR detector 11 m wide-angle version. 21 m long-range version with long-range mirror (optional).

Functions

The detector uses the temperature of surrounding surfaces, such as floors and walls, as the standby value. High temperature fluctuations on the reference surfaces should be avoided.

Sensitivity is programmed using the LSN control panel.

Standard:

- Protection against false alarm
- Higher tolerance to environmental conditions
- Not suitable for the long-range version

High sensitivity:

- Protection against intruders
- With normal environmental conditions

- Higher response sensitivity

Note The detector is not equipped with an alarm log display. Due to the individual detector identification by the LSN control panel, this is no longer necessary.

Certifications and Approvals

Region	Certification	
Europe	CE	DS 935 LSN
Germany	VdS	G 101552, B DS 935 LSN (W) G 101553, B DS 935 LSN (V)

Installation/Configuration Notes

DS 935 LSN detectors do not mutually influence each other. The detection zones may overlap.

Fixed objects represent surfaces that reduce the detection zone.

Outside the monitoring area, ceilings and walls should be mechanically stable.

In order to ensure the intrusion security of ceilings that are not mechanically stable, detectors should monitor each other.

Moving objects within the detection zone are not permitted.

If placed above a heating radiator, a minimum distance of 1.5 m to the radiator is necessary.

Heat sources and cold air currents within the detection zone lead to faults.

Installation

Shielded installation cable must be used to connect the detector.

The detector reacts best to movement at right angles to the detection zones.

The installation bracket B338 (optional) can be used to swivel the detector around by $\pm 45^\circ$ and to tilt it by $\pm 7^\circ$ to -16° .

In interior areas, the detector can be installed 2 m to 2.6 m above floor-level on vertical, stable surfaces.

Wide-angle version

- Use of several detectors, also with overlapping detection zones
- Monitoring area 11 m x 11 m
- Vertical swivel range of the mirror: $\pm 2^\circ$ to -16°

Swiveling mirror

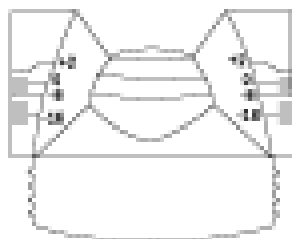

Plan view

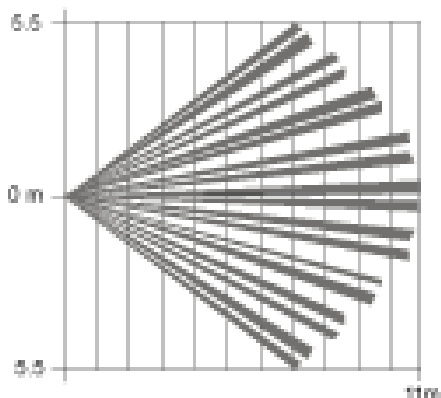

Side view

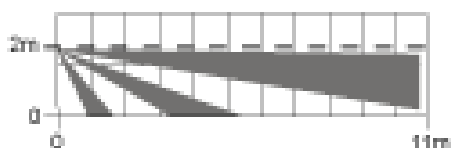

Long-range version

- Long-range version by changing the OMLR93-3 long-range mirror
- Monitoring area 3 m x 21 m
- Vertical swivel range of the mirror: +7° to -16°

Top view

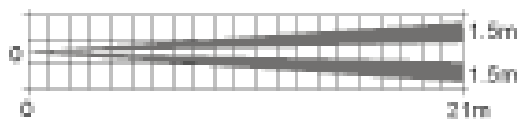

Side view



Technical Specifications

LSN operating voltage	Max. 33 V
LSN current consumption	0.8 mA
Monitoring area	
• Wide-angle mirror	11 m x 11 m
• Long-range mirror	21 m x 3 m
Installation height	2 m to 2.6 m
Rates of movement	
• Wide-angle mirror	0.2 to 3.0 m/s
• Long-range mirror	0.2 to 4.0 m/s
Sensitivity setting	Default or high sensitivity
Environmental conditions	
• Operating temperature	-20 °C to +55 °C
• Storage temperature	-20 °C to +60 °C
• Humidity (EN60721)	< 95% relative humidity, no dew point
• VdS environmental class	II
• Housing protection category (EN60529, EN50102)	IP41/IK02
Dimensions (H x W x D)	110 x 69 x 45 mm

Ordering Information

DS 935 LSN Infrared Motion Detector **4998110393**
 For monitoring rooms for unauthorized entry, 11 m wide-angle version, 21 m long-range version with long-range mirror (optional)

Accessories

OMLR93-3 long-range mirror **OMLR93-3**
 For converting to 21 m long-range version, VPE 3 units

Parts Included

Type	Qty.	Component
DS 935 LSN	1	Infrared motion detector

DS840LSN TriTech PIR/ MW Dual Motion Detector



6

Features

- ▶ **Twin-wire connection to local security network (LSN)**
- ▶ **Microwave and passive infrared (PIR) monitoring every 12 hours**
- ▶ **Pet immunity**
- ▶ **Tamper switch**
- ▶ **Temperature compensation**
- ▶ **Adjustable mirror**
- ▶ **Two installation options**

The products in the DS840LSN series are wall-mounted passive infrared (PIR) and microwave motion detectors. When both monitoring fields are activated, passive infrared and microwave technology triggers an alarm.

Functions

Monitoring security through microwave and PIR technology

- **PIR and microwave:** The detector carries out an internal self test every 12 hours to check the microwave and PIR systems. If there is a microwave or PIR system failure, the detector carries out another test. If the second test cannot be successfully completed on both systems, the light-emitting diode (LED) flashes red to indicate that the detector needs to be replaced. The detector transmits a fault signal to the control panel via the LSN bus.
- **Factory default setting:** The PIR technology ensures detection in the event of microwave technology failure.

Configuration

Configure the detector using the software in the corresponding LSN control panel.

PIR sensitivity settings

Select one of the following sensitivity settings using the software in the LSN control panel:

Standard sensitivity: Minimizes false alarms and is suitable for extreme temperatures.

Intermediate sensitivity: Suitable for instances where an intruder only moves through a small section of the protected area. Normal surroundings are tolerated on this setting. Do not use this setting in areas with pets or animals.

False alarm immunity

The detector does not recognize the following animals:

- a dog up to 45 kg
- small rodents, e.g. rats
- up to 10 cats
- flying birds

Displays

The detector has a visible external LED, which lights up in red, green, and yellow. Various color and flashing combinations are used to provide status information such as: walk test deactivated, walk test activated, power supply turned on, dual alarm, microwave alarm, PIR alarm, and no activity.

Signals

The detector transmits alarm, tampering, and fault information via the LSN bus.

Temperature compensation

The PIR sensitivity is increased or lowered depending on the ambient temperature in order to recognize human body heat and suppress false alarms.

Certifications and Approvals

Region	Certification				
Europe	CE	DS840LSN and DS840LSN-C: 89/336/EEC, EN55022: 1998 (Class B), EN50130-4: 1996, EN61000-4-2: 1995, EN61000-4-3: 1997, EN61000-4-4: 1995, EN61000-4-5: 1995, EN61000-4-6: 1996	DS840LSN-F5: 89/336/EEC, EN55022: 1998+A1: 2000+A2: 2003, EN50130-4: 1996+A1: 1998+A2: 2003, EN61000-4-2: 1995+A1: 1998+A2: 2001, EN61000-4-3: 2002+A1: 2003, EN61000-4-4: 1995+A1: 2000+A2: 2001, EN61000-4-5: 1995+A1: 2001, EN61000-4-6: 1996+A1: 2001+A2: 2001, EN61000-4-11: 1994+A1: 2001, EN60950-1: 2001+A11: 2004, EN60950-1: 2001+A11: 2004, EN 300 440-2 V1.1.1: 2001-09, EN 300 489 Parts-1 and -3 V1.2.1: 2000-08		
Germany	VdS	DS840LSN-F5			
Approvals	DS840LSN	DS840LSN-C	DS840LSN-F5		
CE	X	X	X		

Installation/Configuration Notes

Installation notes

The installation height is between 2.0 m and 2.6 m.

Note When using the B335 or B338 mount, the range can be impaired and the dead zones can be expanded.

The detector can react in its monitoring area to movements or swift changes in temperature. Position the detector away from direct sunlight, windows, ceiling fans, and busy roads.

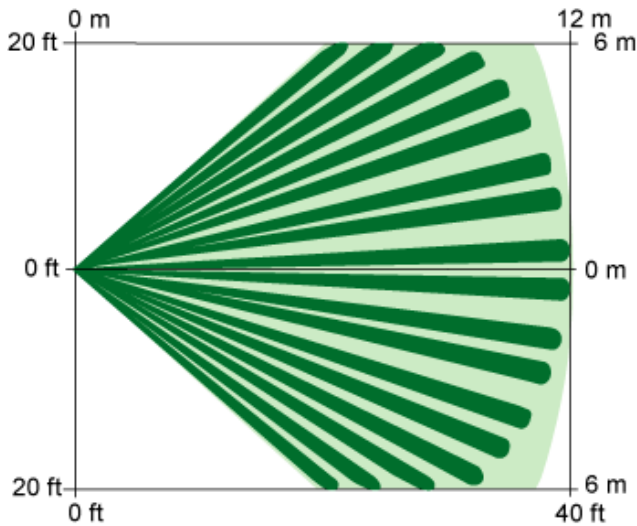

Top view
Monitoring area: 12 m x 12 m

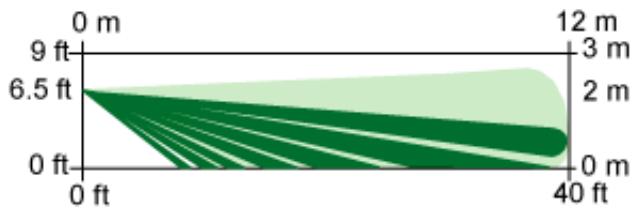

Side view
Monitoring area: 12 m x 12 m

Technical Specifications

Housing

Dimensions: 10.8 cm x 7 cm x 4.6 cm

Material: High-impact ABS plastic

Environmental conditions

Storage and operating temperature: -20 °C to +55 °C

Installation notes

Internal lens adjustment: +2° to -18° vertically

Microwave frequency

DS840LSN: 10.525 GHz

DS840LSN-C: 10.588 GHz

DS840LSN-F5: 9.35 GHz

Power requirements

LSN current consumption: 4.0 mA

LSN power supply: 33 V maximum

Standby power supply: No internal emergency battery available. Requires 4mAh per hour in standby mode.

Trademarks

TriTech® is a registered trademark of Bosch Security Systems in the USA.

Ordering Information

DS840LSN Detector (10.525 GHz) Operates at 10.525 GHz. Monitoring area of 12 m x 12 m, twin-wire connection to LSN, microwave and PIR monitoring every 12 hours, pet immunity, and tamper switch.	DS840LSN
DS840LSN-C Detector (10.588 GHz) Operates at 10.588 GHz. Monitoring area of 12 m x 12 m, twin-wire connection to LSN, microwave and PIR monitoring every 12 hours, pet immunity, and tamper switch.	DS840LSN-C
DS840LSN-F5 Detector (9.35 GHz) Operates at 9.35 GHz. Monitoring area of 12 m x 12 m, twin-wire connection to LSN, microwave and PIR monitoring every 12 hours, pet immunity, and tamper switch.	DS840LSN-F5

Accessories

Swiveling B335-3 low-profile mount Swiveling, low-profile, plastic mount for wall mounting. The vertical swivel range is +10° to -20°, while the horizontal swivel range is ±25°. Available in triple packs.	B335-3
------------------------------------------------------------------------------------------------------------------------------------------------------------------------------------------------------------------------	---------------

IR 200 LSN Infrared Motion Detector



6

Features

- ▶ **Wide-angle version (standard) up to 15 m**
- ▶ **Long-range version (optional) up to 25 m**
- ▶ **Temperature compensation**
- ▶ **Configuration of the detector is done by programming software in the corresponding LSN control panel.**
- ▶ **Alarm, tampering and faults are evaluated via the LSN bus.**
- ▶ **2-wire connection to LSN**

The IR 200 LSN infrared motion detector is used to monitor rooms for unauthorized entry.

PIR motion detector, 15 m wide-angle version. 25 m long-range version with long-range mirror (optional).

Functions

A dual, differentially-connected pyroelectric sensor is positioned at the focal point of a mirror. Depending upon the particular construction of the mirror, this results in a fine-mesh, grid-like (IR 200 LSN) monitoring area, or a comprehensive, wall-like (IR 200 LSN with IRS 162) monitoring area.

Temperature

The detector uses the temperature of surrounding surfaces, such as floors and walls, as the reference value. The detector is configured for optimum sensitivity and false alarm suppression. However, high temperature fluctuations on the reference surfaces should be avoided.

Sensitivity adjustments

The sensitivity can be set at 3 levels using the DIP switch: the sensitivity setting "high value" must not be used in rooms with wall lengths of less than 5 m.

High values – increased detection requirements

Default – living room, office

Raw environment – premises with significant disturbances

Detector displays

The detector has a walk test indicator that, when the walk test is activated, blinks for approx. 3 seconds each time the alarm is triggered.

The detector is not equipped with an alarm log display. Due to the individual detector identification by the LSN control panel, this is no longer necessary.

Certifications and Approvals

Region	Certification	
Europe	CE	IR 200 LSN
Germany	VdS	G 101531, B IR 200 LSN (W) G 101532, B IR 200 LSN (V)

Installation/Configuration Notes

IR 200 LSN detectors do not mutually influence each other. If multiple detectors are used for wall-to-wall monitoring, the detection zones can overlap.

Fixed objects represent surfaces that reduce the detection zone.

Outside the monitoring area, ceilings and walls should be mechanically stable.

In order to ensure the intrusion security of ceilings that are not mechanically stable, detectors should monitor each other.

The HIGH response sensitivity cannot be used in rooms whose sides are less than 5 m long.

Moving objects within the detection zone are not permitted.

If placed above a heating radiator, a minimum distance of 1.5 m to the radiator is necessary.

Heat sources within the detection zone cause faults.

Installation

Shielded installation cable must be used to connect the detector.

The detector reacts best to movement at right angles to the detection zones.

After initial set-up of the detector in an LSN cluster, wait at least one minute until the detector is operationally ready.

The installation bracket (optional) can be used to swivel the detector around by +/-45° and to tilt it by +10°/-15° (not VdS compliant!).

Note Do not remove the circuit board in the detector. Risk of damage!

Installation height

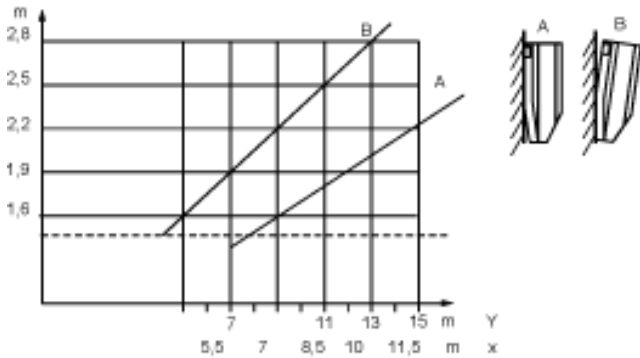

Y Range y: central long-range zone
 X Range x: lateral long-range zone

Wide-angle version

- Greatest possible monitoring density by closely-spaced chessboard-type mirror with 16 zones and a 15 m range.
- In the case of perpendicular (standard) installation, the inclination of the central long-range zone is 5.5°, the range is 15 m, and the lateral long-range zone is 12 m.
- In the case of installation with a 3° incline, the lateral long-range zone is inclined to 8.5°, the range 13 m, and the lateral long-range zone is 11 m. This means the zone configuration can be adjusted to match the spatial conditions.

Side view

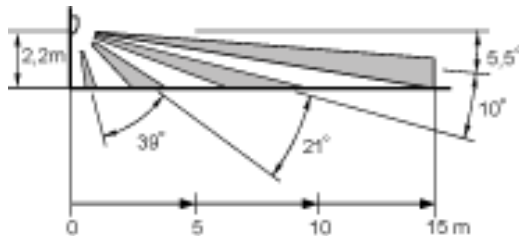

Plan view

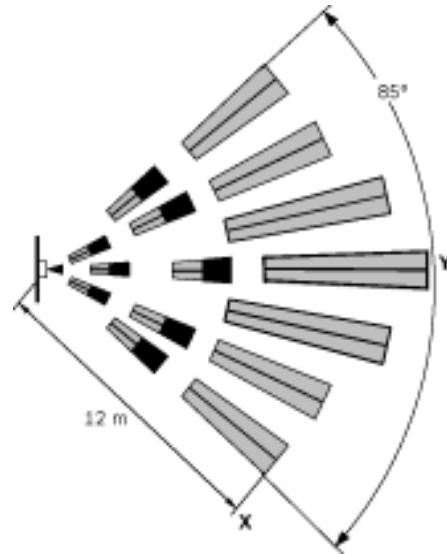

X: range of the lateral long-range zone
 Y: range of the central long-range zone

Long-range version with IRS 162 (optional)

- Long-range version by changing the IRS 162 long-range mirror (optional)
- 11 zones give a closed, long-range detection zone of up to 25 m
- Monitoring area cannot be bypassed due to overlapping operating zone distribution

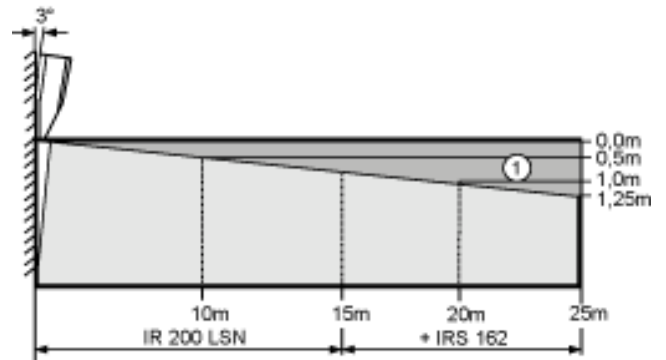

1 Non-monitored surface

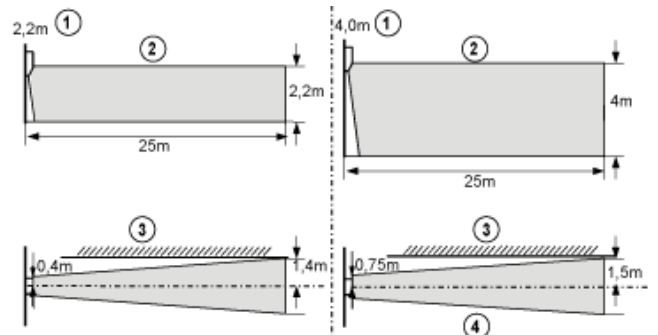

- 1 Installation height
- 2 Side view
- 3 Top view
- 4 The distance from the side to the wall depends on the range

The detector requires a stable reference for the entire detection zone. The detection zone consists of two subzones (separated by the central level). The subzones cannot be referenced to different surfaces that may consist of differing materials. The middle level of a detection zone is in the detector's longitudinal axis, which is perpendicular to the installation surface (housing floor).

Not permissible:

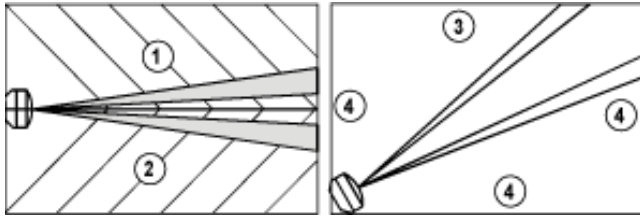

Permissible:

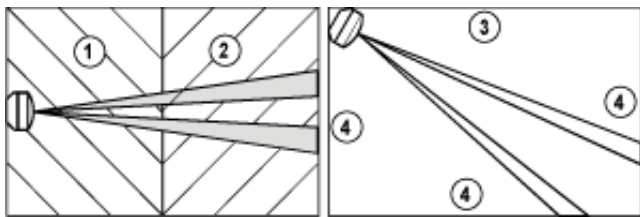

- 1 Material A
- 2 Material B
- 3 Outside wall
- 4 Inside wall

Ordering Information

IR 200 LSN Infrared Motion Detector

4998085570

For monitoring rooms for unauthorized entry, 15 m wide-angle version, 25 m long-range version with long-range mirror (optional)

6

Parts Included

Type	Qty.	Component
IR 200 LSN	1	Infrared motion detector

Technical Specifications

LSN operating voltage	Max. 33 V
LSN current consumption	Approx. 4.15 mA
Movement speeds	
• Wide-angle mirror	0.2 to 3.0 m/s
• Long-range mirror	0.2 to 4.0 m/s
Environmental conditions	
• Operating temperature	-20 °C to +55 °C
• Storage temperature	-20 °C to +60 °C
• Humidity (EN60721)	<95% relative humidity, no dew point
Dimensions (H x W x D)	135.5 x 55 x 45 mm
Housing protection category (EN60529, EN50102)	IP41/IK02
VdS environmental class	II

IR 270 T LSNi Infrared Motion Detector, Antimask



Features

- ▶ **Wide-angle version (standard) up to 18 m including look-down zone**
- ▶ **Long-range version (optional) up to 25 m**
- ▶ **Antimasking/tamper protection**
- ▶ **Temperature compensation**
- ▶ **Analysis of: alarm, masking, tampering, fault**
- ▶ **Alarm memory**
- ▶ **2-wire connection to LSN sufficient**
- ▶ **Antimasking**

The IR 270 T LSNi infrared motion detector is used to monitor rooms for unauthorized entry.

PIR motion detector 18 m wide-angle version with antimasking and look-down zone.

25 m long-range version with long-range mirror (optional).

Functions

The detector uses the temperature of surrounding surfaces, such as floors and walls, as the standby value. The detector is configured for optimum sensitivity and false alarm suppression. However, high temperature fluctuations on the reference surfaces should be avoided.

The sensitivity of the antimask message can be adjusted with the configuration software. You can use the functions to switch between the REAL-time antimask message and the latch antimask message.

REAL-time (non-saving): A cover is displayed as long as the detector is masked.

Latch (saving): The activated antimask message is stored until antimasking is reset.

If the detector is ripped from the mounting surface or the cover is removed, a sabotage alert is triggered.

Certifications and Approvals

Region	Certification	
Europe	CE	IR 270 T LSNi
Germany	VdS	G 106020, C IR 270 T LSNi (W) G 106019, C IR 270 T LSNi (V)

Installation/Configuration Notes

IR 270 T LSNi detectors do not mutually influence each other. The detection zones may overlap.

Fixed objects represent surfaces that reduce the detection zone.

Outside the monitoring area, ceilings and walls should be mechanically stable.

In order to ensure the intrusion security of ceilings that are not mechanically stable, detectors should monitor each other.

The HIGH response sensitivity cannot be used in rooms whose sides are less than 5 m long.

Moving objects within the detection zone are not permitted.

If placed above a heating radiator, a minimum distance of 1.5 m to the radiator is necessary.

Heat sources within the detection zone cause faults.

A minimum distance of 1 cm above the detector must be left free to allow its cover to be put in place.

Installation

Wall, corner and 45° installation are possible without accessories.

The IR UM20 wall installation mount and IR UM30 ceiling installation mount accessories (optional) can be used to swivel the detector by $\pm 45^\circ$ and to incline it by $+10^\circ/-15^\circ$.

Wide-angle version

The detector reacts best to movement at right angles to the detection zones.

Side view

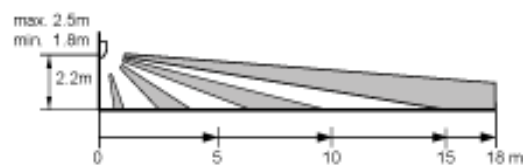

Plan view

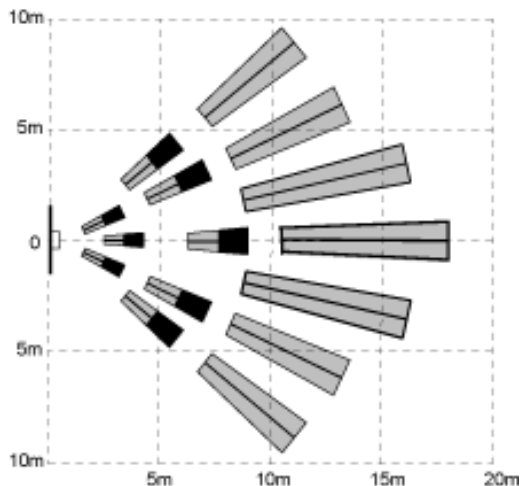

Long-range version with IRS 272 (optional)

At installation heights above 3 m, the detector should point downward at an angle of 2°.

Side view/top view

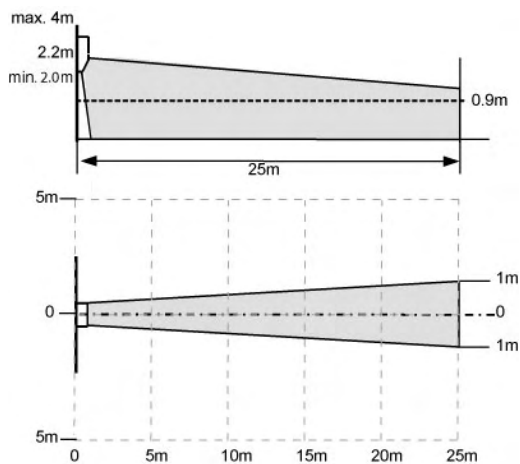

The detector requires a stable reference for the entire detection zone. The detection zone consists of two subzones (separated by the central level). The subzones cannot be referenced to different surfaces that may consist of differing materials. The middle level of a detection zone is in the detector's longitudinal axis, which is perpendicular to the installation surface (housing floor).

Not permissible:

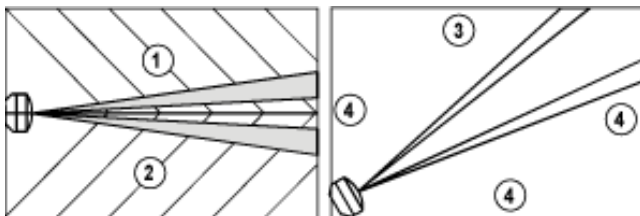

Permissible:

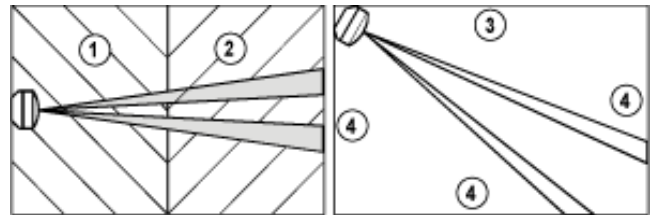

- 1 Material A
- 2 Material B
- 3 Outside wall
- 4 Inside wall

Parts Included

Type	Qty.	Component
IR 270 T LSNi	1	Infrared motion detector

Technical Specifications

IR 270 T LSNi	
LSN operating voltage	Max. 33 V DC
Current consumption	
• Maximum current	2.2 mA
Range	
• Wide-angle version	18 m
• Long-range version (with IRS 272)	25 m
Installation height	
• Wide-angle version	1.8 m to 2.5 m
• Long-range version (with IRS 272)	2.0 m to 4 m
Movement speeds	
• Wide-angle version	0.1 to 4.0 m/s
• Long-range mirror	0.1 to 4.0 m/s
Environmental conditions	
• Operating temperature	20 °C to +55 °C
• Storage temperature	-20 °C to +60 °C
• VdS tested environmental class II	-10 °C to +55 °C
• Humidity EN60721	< 95% relative, no dew point
• EMC strength up to 2 GHz	30 V/m
• VdS environmental class	II
Housing	
• Dimensions (H x W x D)	135.5 x 55 x 45 mm
• Housing protection category	IP41/IK02
• Weight	0.150 kg

Ordering Information**IR 270 T LSNi Infrared Motion Detector,
Antimask** **IR270 T LSNi**

For monitoring rooms for unauthorized entry,
18 m wide-angle version with antimasking and
look-down zone, 25 m long-range version with
long-range mirror (optional)

UP 370 T LSN Matchtec Detector, Antimask



6

Features

- ▶ Linking of passive infrared and ultrasound systems
- ▶ Range of 6–10 m
- ▶ Temperature compensation
- ▶ Alarm memory
- ▶ Programming of the detector is carried out via programming software in the corresponding LSN control panel
- ▶ Alarm, tampering and faults are evaluated via the LSN bus
- ▶ Antimasking

The UP 370 T LSN is used to monitor rooms for unauthorized entry.

The detector reveals human movement in all directions using a passive infrared system and an ultrasound system. 10 m wide-angle version with antimasking.

Functions

The UP 370 T LSN Matchtec motion detector detects human movement in all directions using a passive infrared system (PIR) and an ultrasound system (US).

A pyroelectric sensor is positioned in the focal point of a mirror. The shape of the mirror provides an almost comprehensive monitoring area.

Temperature compensation ensures that **false alarms are suppressed**. This is realized by linking the passive infrared and ultrasound systems.

The **detection zone** of the detector corresponds to a maximum area of 50 m² and is limited by walls, doors, windows etc.

Detection zone settings:

- Standard: detection area 7 m x 7 m
- Reduced: detection area 5 m x 5 m

The use of several detectors in the same room is possible. Note minimum distance between detectors!

Detector system function

In disarmed status, the ultrasound transmitter is switched off. The detector acts as a passive infrared detector (PIR) in this status. Antimasking continues to function independently. The US detection system is switched back on with the walk test.

Monitoring of detector function

A self test is always conducted when adding the power supply. The detector also conducts a periodic self test. Function errors, e.g. sensor failure, are displayed as faults by the continuously lit yellow LED.

Antimasking

The antimasking (saving/non-saving) is set using the control panel software. For masking tests that limit motion detection, an antimask message is generated and, for walk tests, the masking indicator (green LED) is activated. The antimasking range is approx. 0.2 m, depending on the masking material.

In order to ensure operational reliability, sprayed detector covers must be replaced. Cleaning is not sufficient.

The **detection sensitivity** has adjustable settings.

Certifications and Approvals

Region	Certification	
Europe	CE	UP 370 T LSN
Germany	VdS	G 101100, C UP 370 T LSN

Installation/Configuration Notes

The UP 370 T LSN has a 4-wire element and requires separate auxiliary voltage. Shielded installation cable must be used to connect the detector.

Installation

Corner and 45° installation (right/left) is possible without accessories.

An installation height of > 2.2 m is recommended for detectors with antimasking.

Point the detector at 2° downward for installations higher than 2.2 m.

For optimal performance, position the detector in a location where the intruder's anticipated path is at 45° to the detector axis.

Side view

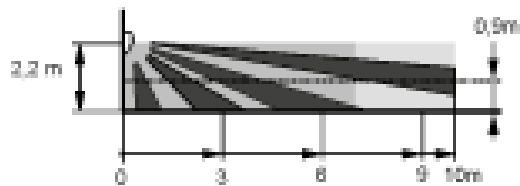

Plan view

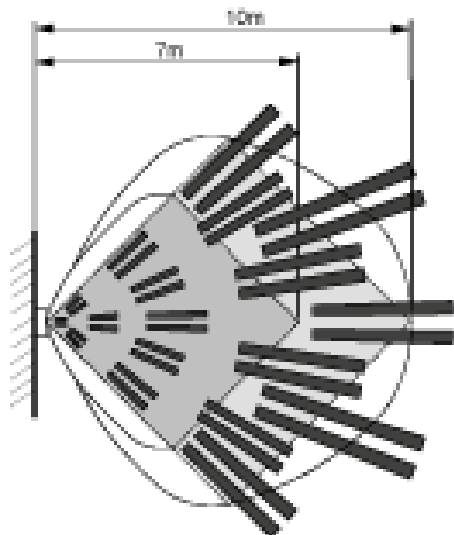

- 10 m Standard
- 7 m Reduced

Installation height

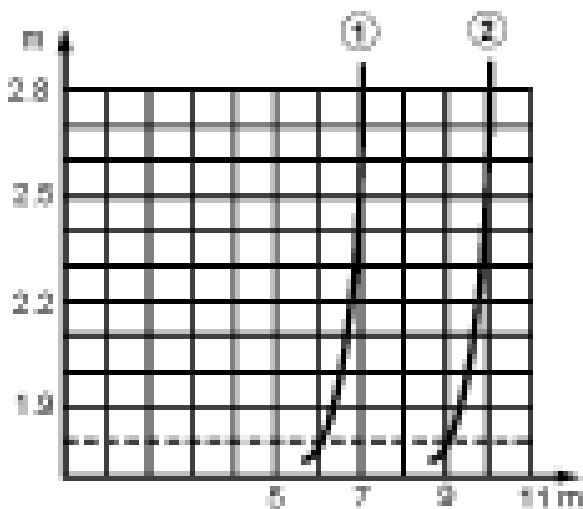

- 1 US range reduced
- 2 US range standard

Distance between detectors

Several detectors may be deployed in the same room. If more than four detectors are installed opposite each other in the same room, the distance must be > 8 m.

Parts Included

Type	Qty.	Component
UP 370 T LSN	1	Matchtec motion detector

Technical Specifications

Power supply	8.0 to 28.0 V DC (12 V nom.)
Voltage monitoring	Fault at < 6.5 to 7.9 V
Current consumption (at 12 V)	
• Standby	18 mA
• Alarm with LEDs	31 mA
Current consumption of LSN part	Approx. 1.6 mA
Detection speed	0.1 to 4 m/s
Ultrasound frequency (stable crystal)	25.6 kHz
Ultrasound ON/OFF	Selectable when disarmed
Environmental conditions	
• Operating temperature	-20 °C to +55 °C
• Storage temperature	-20 °C to +60 °C
• Humidity (EN60721)	< 95% relative humidity, no dew point
• EMC strength (all systems)	30 V/m
• VdS environmental class	II
Housing	
• Dimensions (H x W x D)	170 x 70 x 63 mm
• Housing protection category	IP41
• Weight	0.22 kg

Ordering Information

UP 370 T LSN Matchtec Detector, Antimask **4998085569**
 For monitoring rooms for unauthorized entry with passive infrared and ultrasound system, 10 m wide-angle version with antimasking

GM 570 LSN Seismic Detector



6

Features

- ▶ **Completely protected against electrical influences**
- ▶ **Programmable sensitivity and response time via LSN**
- ▶ **Remote controlled reduction of sensitivity**
- ▶ **Pre-alarm memory with visual display**
- ▶ **Integrated test system**
- ▶ **Monitoring the power supply**
- ▶ **Alarm, tampering and faults are evaluated via the LSN bus**

The GM 570 LSN seismic detector is suitable for monitoring armored cabinets, cash boxes, automatic teller machines, strong rooms, night safes, modular vaults, and vault walls for all known burglary tools such as diamond-tipped drills, hydraulic rams, oxygen lances and explosives.

Functions

The seismic detector is suitable for monitoring armored cabinets, cash boxes, automatic teller machines, night safes, armored safes, and safe vault walls for all known burglary tools such as diamond-tipped drills, hydraulic rams, oxygen lances and explosives.

The GM 570 LSN is fitted with a double housing. This design gives the detector good protection against electromagnetic influences and from deliberate or accidental damage. Mechanical vibrations caused by a burglary attempt are detected and analyzed by the seismic detector sensor, and an alarm is triggered.

Temporary reduction in sensitivity

To prevent false alarms caused by loud operational noises, e.g. use of the object intake mechanism on day/night vaults, the response sensitivity of the detector can be temporarily reduced to approx. 1/8 of the pre-set value via a control input (e.g. contact switch on the object intake mechanism).

Note When reducing sensitivity, compliance with the relevant VdS regulations within the context of the system must be checked and accepted by VdS.

GMXS1 test transmitter (optional)

The GMXS1 test transmitter is a component of the test system for the GM 570 LSN seismic detector. Installing the test transmitter allows the seismic conductivity of the mechanical mountings to be checked along with the functionality of the electronics.

Certifications and Approvals

Region	Certification	
Europe	CE	GM 570 LSN
Germany	VdS	G 101165, C GM 570 LSN

Installation/Configuration Notes

Detection zone

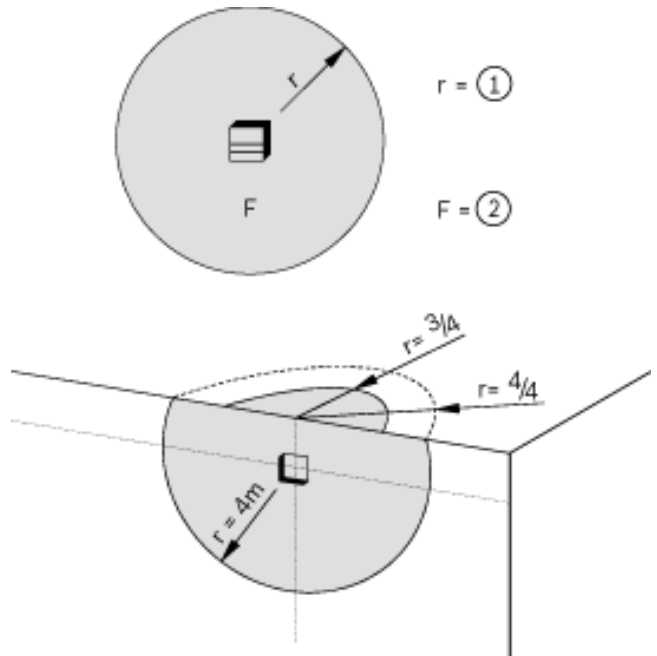

- 1 Effective range
- 2 Detection zone

The GM 570 LSN seismic detector can be operated in a room with ultrasound detectors; the detection zone is not affected by this.

The detection zone is identified as the surface of a mechanical obstruction (vault or wall of an armored cabinet) that is being monitored by a detector. The detection zone is highly dependent on the material of the object being monitored. Due to practical experience, the effective range for steel and iron-reinforced concrete is $r = 4$ m.

The detection zones for detectors on vault walls can extend along a part of the ceiling or the floor if the rebars are well connected to each other. In such cases the effective range is reduced to 3/4 of the set zone.

Joints always create attenuation between two materials for impact sound transmission.

Note It is essential that each folding door on a vault is fitted with a detector. The body of a vault must be fitted with at least one detector.

Note If the vault dimensions go beyond the detection zone of one detector, (particular attention must be paid to range reduction over body edges), additional detectors should be included in planning. When used on modular vaults, please take the panel structure into consideration when allocating detectors.

Surface monitoring

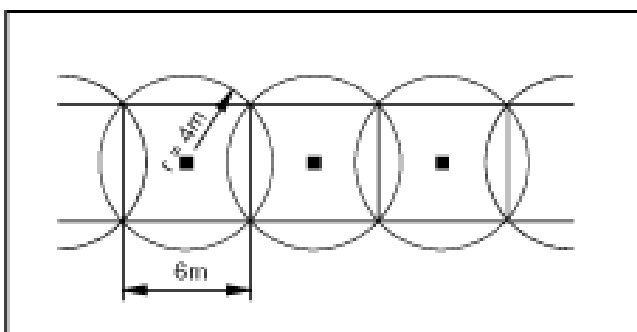
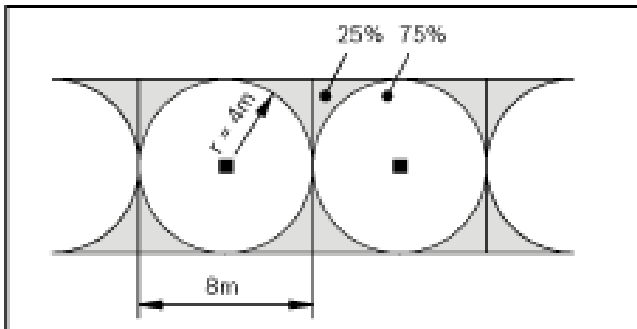

To facilitate planning for large surfaces, convert the circular detection zone into a square:

- For 75% surface monitoring, convert diameter to 8 m x 8 m square
- For 100% surface monitoring, create a 6 m x 6 m square within circle

Interim values can also be selected. Multiple detectors do not mutually influence each other.

Panel-structured strong room

Vault with detector allocation

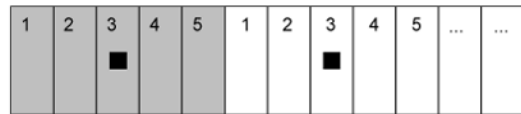

Weld wall/wall corner connection end to end

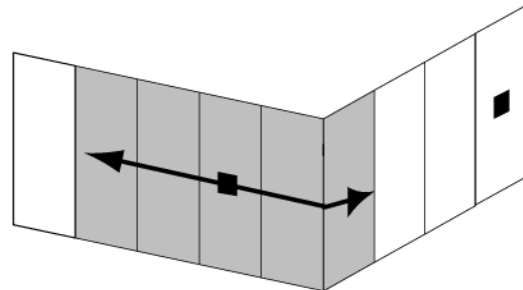

General guidelines

Guidelines apply to the following element dimensions:

Thicknesses of 100 mm to 400 mm

Widths up to 1000 mm

Lengths up to 6500 mm

When using a seismic detector on steel and concrete modular vaults, the following principles must be observed:

- One detector for a maximum of five wall panels, with the detector placed on the central panel.
- All joints between panels must also be welded to a screw connection every 40 to 50 cm with a weld seam 3 to 4 cm long.
- Corner connections for wall panels must be welded from end-to-end if the detection zone is to be used over the corners.
- For wall panels with assembled detectors set to sensitivity A, the directly adjacent floor and/or ceiling panel can be included in the detection zone, if the relevant impact position is welded end-to-end.
- With mixed structures that combine various panel thicknesses, impact positions must always be welded end-to-end.
- Avoid placing detectors directly on panels where bearings from cassette transport lifts, ventilators or other mechanical units are fixed.
- Panels with an inlet or outlet opening should always be fitted with a detector that also monitors the adjacent panels.
- Always place a detector on each individual door.
- Settings in accordance with installation manual for GM 570 LSN seismic detectors:

Application	Sensitivity	Response time
Max. 5 elements	A	Standard
Max. 3 elements	B	Standard
On doors	C or D	Delayed

Information on night safes:

Dropping cash boxes into night safes results in brief, acute seismic signals. There are several ways of reducing these.

- Joint between inlet channel and night safe

- Acoustic insulation between inlet channel and night safe
- Coating the opening cover and the inside of the safe with sound-absorbing material
- Using plastic cash boxes

Parts Included

Type	Qty.	Component
GM 570 LSN	1	Seismic detector

Technical Specifications

LSN operating voltage	Max. 33 V _~
LSN current consumption	2.43 mA
Measurement output, terminal 9	Analog integration signal
• Standby level	Approx. 0.7 V
• Integration start	2.5 V
• Max. interference level	3.2 V
• Alarm threshold (no load)	4.0 V
Sensitivity reduction input, terminal 10	
• For reduction	LOW ≤ 1.5 V/HIGH ≥ 3.5 V
• Reduction	up to 1/8 of the current setting (SW programmable, depending on control panel)
Sensitivity adjustable in	6 fixed levels + 1 freely programmable object (SW programmable, depending on control panel)
Effective range (concrete and steel)	R=4 m (with default setting)
Detection zone (concrete and steel)	50 m ²
Operating temperature	-20 °C to +70 °C
Humidity: DIN class F	< 95%
Housing protection category (EN60529, EN50102)	IP 43
VdS environmental class	III
EMC strength 0.01 to 2 GHz (IEC801-3)	30 V/m
Housing	
• Material	Metal
• Color	Light gray
Weight	Approx. 0.4 kg
Dimensions (H x W x D)	40 x 90 x 90 mm
GMXBO floor socket (optional)	
Dimensions (H x W x D)	
• GMXBO floor socket	150 x 150 x 50 mm
• Floor socket with flange	220 x 150 x 50 mm
Maximum load	1000 kg
Protection category	IP 50

Ordering Information

GM 570 LSN Seismic Detector

4998085573

For monitoring vault doors, modular vaults and vault walls

GBS 2036 LSN Passive Glass Break Detector



Features

- ▶ Glass break detector in LSN technology
- ▶ For connecting to an LSN intrusion control panel
- ▶ Alarm transmission via LSN bus
- ▶ Can be used for LSN perimeter protection

The passive glass break detector in LSN technology monitors level glass surfaces within a max. radius of 2 m.

Functions

Passive glass break detectors are stuck directly onto glass plates in windows and doors.

The mechanical vibrations that occur when the glass is damaged are measured and analyzed.

Scratches on the glass plate made by a glass cutter are not recognized as glass break.

The analysis is carried out via the LSN intrusion control panel.

Certifications and Approvals

Region	Certification	
Europe	CE	GBS 2036 LSN
Germany	VdS	G 101502, B GBS 2036 LSN

Installation/Configuration Notes

Functional tests can be conducted using a detector testing device. Alarm triggering is displayed at the control panel and also directly indicated on the detector.

Installation notes

The GBS 2036 LSN is stuck to level glass plates in rooms.

If several glass break sensors are grouped together in a detector zone, each detector zone must be limited to 20 glass break sensors.

The glass break sensor should preferably be installed horizontally, at a minimum distance of 5 mm from the window frame, and at least 20 mm from the long side.

The side of the glass to which the detector is attached may not have other material attached to it (e.g. anti-splinter foil, transparencies etc.) and may not be painted.

The plates to be monitored must not be damaged (e.g. splintered) and must be firmly fixed in frames. Plates that can be easily removed from the outside should be additionally monitored against removal.

Plates of glass in premises in which air containing chlorine or other aggressive substances are present (e.g. swimming pools) are unsuitable for installation.

Installation of a glass break detector on a plate

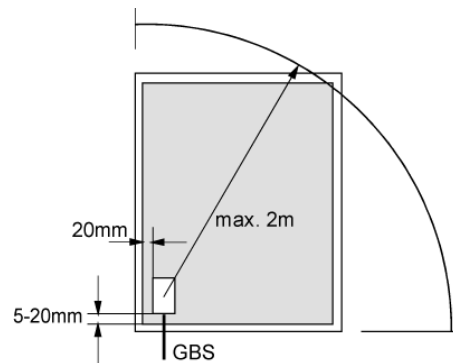

Installation distance from frames: 20 mm

Installation of multiple glass break detectors on one plate

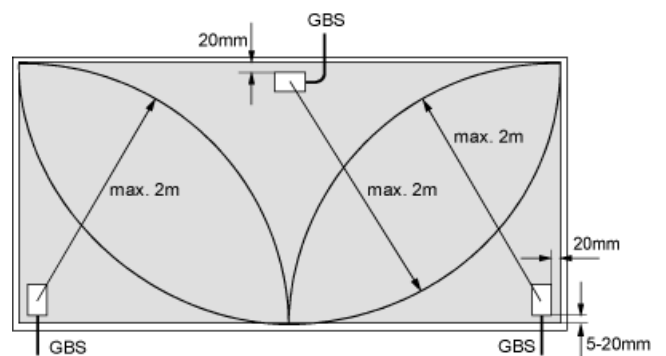

Installation distance from frames: 20 mm

The detector cannot be used for the following types of plates:

- Pyrostop glass (fire-retardant)
- Structured glass
- Plates made of plastic material
- Glass bricks

- Laminated glass
- Armored (wire insert) glass

Parts Included

Type	Qty.	Component
GBS 2036 LSN	1	Passive glass break detector

Technical Specifications

LSN operating voltage	15 V to 33 V
Current consumption	0.56 mA
Protection category	IP 67
VdS environmental class	III
Permissible ambient temperature	-25 °C to +70 °C

Housing

- Material: S-B
- Color: White

Dimensions

- Device (H x W x D): 37 x 19 x 12 mm
- Connection cable: Ø 3.2 mm, length 4 m

Ordering Information

GBS 2036 LSN Passive Glass Break Detector **4998014173**

For monitoring level glass surfaces within a max. radius of 2 m

MAGIC.SENS Automatic LSN Fire Detectors



Features

- ▶ **Detector properties adapted to cater for room usage**
- ▶ **Active adjustment of the threshold (drift compensation)**
- ▶ **Self-monitoring sensor technology with fault indication on the fire panel in the event of sensor failure or heavy soiling**
- ▶ **Preservation of LSN loop functions in the event of wire interruption or short-circuit of a detector through integrated isolators**
- ▶ **Robust and durable**

MAGIC.SENS Fire Detectors set new standards in fire detection technology through a combination of optical, thermal and chemical (gas) sensors and intelligent evaluation electronics. Their most impressive feature is their ability to prevent false alarms, as well as speed and accuracy of detection.

System Overview

Operating mode	Detector type				
	OTC	OC	OT	O	T
Combined	x	x	x	-	-
Optical	x	x	x	x	-
Thermo-max.	x	-	x	-	x
Thermal differential	x	-	x	-	x
Chemical	x	x	-	-	-

Functions

Sensor technology and signal processing

The individual sensors can be configured via the LSN network manually or using a timer.

All sensor signals are analyzed continually by the internal evaluation electronics and are linked with each other. The link between the sensors means that the combined detectors can also be used where light smoke, steam or dust must be expected during the course of normal operation.

Only if the signal combination corresponds to that for the programming of the selected usage site field code will the alarm be triggered automatically. This results in a higher level of security against false alarms.

In addition, the time curve for fire and malfunction detection sensor signals is also analyzed, resulting in increased reliability of detection for each individual sensor.

Optical sensor (smoke sensor)

The optical sensor uses the scattered-light method.

An LED transmits light to the measuring chamber, where it is absorbed by the labyrinth structure. In the event of a fire, smoke enters the measuring chamber and the smoke particles scatter the light from the LED. The amount of light hitting the photo diode is converted into a proportional electrical signal.

Thermal sensor (temperature sensor)

A thermistor in a resistance network is used as a thermal sensor, from which an analog-digital converter measures the temperature-dependent voltage at regular intervals.

Depending on the specified detector class, the temperature sensor triggers the alarm status when the maximum temperature of 54 °C or 69 °C is exceeded (thermal maximum), or if the temperature rises by a defined amount within a specified time (thermal differential).

Chemical sensor (CO gas sensor)

The main function of the gas sensor is to detect carbon monoxide (CO) generated as a result of a fire, but it will also detect hydrogen (H) and nitrous monoxide (NO). The sensor signal value is proportional to the concentration of gas. The gas sensor delivers additional information to effectively suppress deceptive values.

Depending on the service life of the gas sensor, the OTC 410 and the OC 410 detectors switch off the C sensors after five years of operation. The detectors will continue to function as an OT or O detector. The detector should then be exchanged immediately in order to be able to keep using the higher reliability of detection of the OTC or OC detector.

Special features	Detector type				
	OTC 410	OC 410	OT 400 E	O 400 E	T 400 E
Drift compensation, optical part	x	x	x	x	-
Drift compensation, gas sensor	x	x	-	-	-
Contamination detection	x	x	x	x	-
Sensor shutoff/operational mode switching	x	-	x	-	-
Current analog values readable	x	x	x*	x*	x*
Operating hours readable	x	x	x*	*x	x*
Contamination level readable	x	x	x*	x*	-
Serial number readable	x	x	x*	x*	x*

* Does not apply to KKW types

LSN features

Operating data display

With the exception of KKW type detectors, the following values can be read out for all detectors using the WinPara program (Version 4.53 or later):

- Serial number
- Contamination level (with O-part)
- Operating hours
- Current analog values.

Analog values are:

- Optical system values: current measured value of the scattered light sensor; the measuring range is linear and covers from 170 (new) to 700 (dirty).
- Contamination: the contamination value shows how much the current contamination value has increased relative to the original condition.
- CO value: display of the current measured value (max. 550).

Self-monitoring of sensor technology

The sensor technology is constantly self-monitored using the following fire panel display:

- Fault indication in the event of sensor failure (life-zero monitoring)
- Continuous display of contamination level during service
- Fault indication if heavy contamination is detected (in place of false alarms)

Manual or time-controlled switch-off of individual sensors is required for adjustment to extreme interference factors.

In the event of an alarm, individual detector identification is transmitted to the fire panel.

Further performance characteristics

The detectors have a dust-repellent labyrinth and cap construction.

The detector alarm indication takes the form of a red flashing LED that is easily visible 360°.

It is possible to activate a remote external detector alarm display.

The stable and robust detector base no longer has to be directed due to the centralized position of the individual display.

The integrated strain relief for interfloor cables prevents the removal of cables from the terminal after installation. The terminals for cable cross-sections up to 2.5 mm² are very easily accessible.

The detector bases have a mechanical removal lock (can be activated/deactivated).

Certifications and Approvals

Region	Certification	
Europe	CE	OTC 410 LSN
		OC 410 LSN
		OT 400 E LSN
		OT 400 LSN KKW
		O 400 E LSN
		O 400 LSN KKW
		T 400 E LSN
T 400 LSN KKW		
Germany	VdS	G 201081 OTC 410 LSN
		G 201080 OC 410 LSN
	PTB	G 202045 OT 400 E
		G 299092 OT 400 LSN KKW
		G 202044 O 400 E LSN
		G 202043 T 400 E LSN
		01 ATEX 2163 X OTC/OC 310/410, OT/O/T 300/400, DKM/SKM 120, DM/SM 210, MPA
Poland	CNBOP	2105/2006 O 400 E
		2083/2006 OT 400 E
		2104/2006 T 400 E
Turkey	TSE	14.10.01/TSE-6990 Detectors
Czech Republic	TZÚS	080-001244 O 400 E LSN, O 300
		080-001247 T 400 E LSN, T 300
		080-001250 OT 400 E LSN, OT 300
		080-001253 OC 410 LSN, OC 310
		080-001256 OTC 410 LSN
Hungary	TMT	TMT-89/2/2004 O 400E, T 400E, OT 400 E, OC 410, OTC 410
Russia	GOST	POCC DE.C313.B06297
		POCC DE.C313B06298

Installation/Configuration Notes

- Up to 127 detectors can be connected per loop or stub.
- Maximum cable length **1000 m**, for J-Y(St) Y n x 2 x 0.6/0.8
- Can be connected to the following LSN fire panels:
 - BZ 500 LSN

- UEZ 2000 LSN Universal Fire Panel
- UGM 2020 Universal Security System
- Plus other fire panels and their receiver modules with identical connection conditions.
- Country-specific standards and guidelines must be observed during the planning phase.

Installation/configuration notes in accordance with VdS/VDE/DIBt

- The OTC, OC and OT types are planned in accordance with the guidelines for optical detectors if operated as optical detectors or combined detectors (see DIN VDE 0833 Part 2 and VDS 2095).
- If occasional disconnection of the optical unit (scattered light sensor) is required, planning must be based on the guidelines for heat detectors (see DIN VDE 0833 Part 2 and VDS 2095):
- When planning fire barriers according to DIBt, note that the T 400 LSN must be configured in line with class A1R.

Parts Included

Detector type	Qty.	Components
OTC 410	1	Multisensor Detector Optical/Thermal/Chemical
OC 410	1	Multisensor Detector Optical/Chemical
OT 400 E	1	Multisensor Detector Optical/Thermal
O 400 E	1	Optical Smoke Detector
T 400 E	1	Heat Detector (Thermal Differential/Thermal Maximum)
OT 400 KKW	1	Multisensor Detector Optical/Thermal*
O 400 KKW	1	Optical Smoke Detector*
T 400 KKW	1	Heat Detector (Thermal Differential/Thermal Maximum)*

*For use in areas with increased radioactive radiation

Technical Specifications

Electrical

Operating voltage	15 VDC . . . 33 V DC
Current consumption	< 0.7 mA
Alarm output	Per data word by two-wire signal line
Indicator output	Open collector connects 0 V over 1.5 kΩ, max. 15 mA

Mechanics

Individual display	LED red
Dimensions	
• Without base	Ø 99.5 x 52 mm
• With base	Ø 120 x 63.5 mm
Housing	
• Material	Plastic, ABS (Novodur)
• Color	White, similar to RAL 9010, matt finish
Weight	Without / with packaging
• OTC 410 / OC 410	Approx. 80 g / approx. 125 g
• OT 400 / O 400 / T 400	Approx. 75 g / approx. 115 g

Environmental conditions

Protection class as per EN 60529	IP 30, IP 32 with damp room seal
Permissible operating temperature	
• OTC 410	-10 °C . . . +50 °C
• OC 410	-10 °C . . . +50 °C
• OT 400	-20 °C . . . +50 °C
• O 400	-20 °C . . . +65 °C
• T 400	-20 °C . . . +50 °C
Permissible relative humidity	95% (non-condensing)
Permissible air speed	20 m/s

Planning

Monitoring area	
• OTC 410, OC 410, OT 400, O 400	Max. 120 m ² (Heed local guidelines!)
• T 400	Max. 40 m ² (Heed local guidelines!)
Maximum installation height	16 m (Heed local guidelines!)
• OTC 410, OC 410, OT 400, O 400	16 m (Heed local guidelines!)
• T 400	7.5 m (Heed local guidelines!)

Special features

Response sensitivity	
• Optical part	< 0.15 dB/m, in line with EN 54 T7
• Thermal maximum part	> 54 °C / >69 °C
• Thermal differential part	A1R / A2R / BR, as per prEN 54-5 (programmable)
• Gas sensor	In ppm range
Color code	
• OTC 410	Yellow loop
• OC 410	Blue loop
• OT 400	Black loop
• O 400	No marking
• T 400	Red loop

Ordering Information

Accessories

MS 400 Detector Base for surface-mounted and flush-mounted cable feed	MS 400
MSF 400 Detector Base with Damp Room Seal for surface-mounted and flush-mounted cable feed	MSF 400
MSC 420 Additional Base with Damp Room Seal for surface-mounted cable feed	MSC 420
MS 420 LSN Detector Base with Spring for use in Great Britain	MS 420
MPA External Detector Alarm Display according to DIN 14623	MPA

Ordering Information

FAA-420-RI Remote Indicator	FAA-420-RI
Mounting Bracket for Fire Detectors on False Floor Stilts	FMX-DET-MB
MK 400 Detector Console Console for DIBt compliant mounting of detectors above doors etc., including detector base	MK 400
MH 400 Detector Heating Element	MH 400
SK 400 Protective Basket	SK 400
SSK 400 Protective Dust Cover (packing unit = 10 units)	SSK 400
TP4 400 Support Plate for Detector Identification (packing unit = 50 units)	TP4 400
TP8 400 Support Plate for Detector Identification (packing unit = 50 units)	TP8 400

MAGIC.SENS Detector Base Sounders



Features

- ▶ Volume up to 100 dB(A)
- ▶ Electronic tone generator integrated into the signaling device
- ▶ 11 different tone variants can be selected (incl. DIN tone)
- ▶ Great reliability and long service life
- ▶ For surface-mounted and flush-mounted cable feed
- ▶ The LSN types maintain LSN loop functions in the event of wire interruption or short-circuit thanks to two integrated isolators

Detector Base Sounders are used when the acoustic signaling of an alarm is required directly at the site of the fire.

System Overview

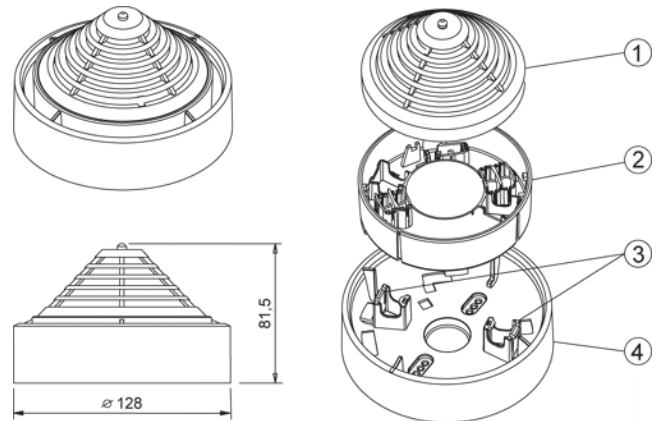

Pos. Description

- | | |
|---|-----------------|
| 1 | Detector module |
| 2 | Sounder unit |
| 3 | Snap-fit hooks |
| 4 | Mounting base |

Functions

The electronic tone generator integrated into the signaling device can produce 11 different tones (including DIN tones conforming to DIN 33404 and EN 457).

The tone variants include different wailing tones, various signals for fire alarms, and other special modulations. Depending on the tone type, volume set, and operating voltage, the sound pressure level varies between 87 dB(A) and 100 dB(A).

The programming of the tone type and volume setting is performed:

- for the MSS 300 via integrated DIP switch and potentiometer (continuously)
- for the MSS 400/401 via the LSN.

Certifications and Approvals

Region	Certification	
Europe	CE	MSS 300 WS
		MSS 300 ws - EC
		MSS 400 LSN
		MSS 401 LSN
Germany	VdS	G 204067 MSS 300
		G 204068 MSS 400 / 401
Russia	GOST	POCC DE.C313B06298

Installation/Configuration Notes

- MAGIC.SENS Detector Base Sounders are intended only for interior areas.

- The current consumption depends on the tone type selected and is maximum 20 mA.

MSS 300 ws Detector Base Sounder White

- Control from the C point of the deployed MAGIC.SENS fire detector
- When the detector is reset in the event of an alarm, the sounder is not reset.

MSS 300 ws EC Detector Base Sounder White

- Control of fire panel via an interface (not via the C point of the deployed MAGIC.SENS fire detector)
- For connection to the LSN, an NSB 100 LSN control interface is required.
- The sounder continues to sound for approx. 90 s after being switched off after occurrence of an alarm.

MSS 400 LSN Detector Base Sounder White

- The Detector Base Sounder as well as the deployed detector are each independent LSN elements.
- The current consumption from the LSN is max. 20 mA.

MSS 401 LSN Detector Base Sounder White

- The Detector Base Sounder as well as the deployed detector are each independent LSN elements.
- The current consumption from the LSN is only max. 1.025 mA, as the sounder has a separate power supply.
- Requires a separate power supply.

Tone type table

No.	Signal type (sound type)	Frequency / modulation	Acoustic sound level at 24 V
1*	Increasing/ decreasing tone (DIN tone)	1200/500 Hz at 1 Hz	96 dB(A)
2	Increasing/ decreasing tone British alarm tone (BS 5839)	800-970 Hz at 1 Hz	100 dB(A)
3	Increasing / decreasing tone Australian alarm tone (AS 2220)	2400-2850 Hz at 7 Hz	95 dB(A)
4	Variable tone Dutch alarm tone	500-1200 Hz 3.5 s on/ 0.5 s off	97 dB(A)
5	Continuous tone, British alarm tone (BS 5839)	970 Hz	97 dB(A)
6	Variable tone, French alarm tone	554 Hz/100 ms 440 Hz/400 ms	97 dB(A)
7	Continuous tone, Swedish alarm tone	660 Hz	97 dB(A)
8	Variable tone	580/1000 Hz each 500 ms on / off	91 dB(A)
9	Pulse tone	580 Hz each 250 ms on / off	87 dB(A)
10	USA temporal 3 tone ISO 8201	610 Hz	99 dB(A)
11	USA temporal 3 tone ISO 8201	2850 Hz	94 dB(A)

* Delivery state: tone complying with DIN 33404 or EN 457

Technical Specifications

Electrical

Operating voltage	
• MSS 300	9 V DC... 28 V DC
• MSS 400 LSN	15 V DC... 30 V DC
• MSS 401 LSN	15 V DC... 30V DC
Current consumption from external source	
• MSS 300 LSN	1 mA / max. 20 mA
• MSS 401 LSN	2 mA / max. 20 mA
Current consumption from LSN	
• MSS 400 LSN	2 mA / max. 20 mA
• MSS 401 LSN	Max. 1.025 mA

Mechanics

Connections (inputs/outputs)	0.28 mm ² ... 2.5 mm ²
Dimensions (W x H)	128 x 40.5 mm
Weight	
• Without packaging	Approx. 220 g
• With packaging	Approx. 260 g
Housing	
• Material	Plastic, ABS (Novodur)
• Color	White, similar to RAL 9010

Environmental conditions

Protection category as per EN 60529 (with detector)	IP 30
Permissible operating temperature	-10 °C... +55 °C
Permissible storage temperature	-25 °C... +85 °C

Special features

Sound pressure level at a distance of 1 m	Max. 100 dB (A)
Frequency range	440 Hz up to 2.85 kHz

Ordering Information

MSS 300 ws Detector Base Sounder White Control via C-point of the detector	MSS 300
MSS 300 ws-EC Detector Base Sounder White Control through fire panel via interface	MSS300-WH-EC
MSS 400 LSN Detector Base Sounder White For direct connection to the LSN	MSS 400 LSN
MSS 401 LSN Detector Base Sounder White For direct connection to the LSN with direct separate power supply	MSS 401

MAGIC.SENS Detector Base Sounders



	MSS 300	MSS300-WH-EC	MSS 400 LSN	MSS 401
GLT/LSN	GLT	GLT	LSN	LSN
Control	by the C point of the fire detector	by the fire panel via an interface	by the LSN	by the LSN
Operating voltage	9 V DC . . . 28 V DC	9 V DC . . . 28 V DC	15 V DC . . . 30 V DC	15 V DC . . . 30 V DC
Current consumption	external power supply	external power supply	LSN	LSN (max. 1.025 mA) and external power supply
- Standby	1 mA	1 mA	2 mA	2 mA (AUX)
- Alarm	max. 20 mA	max. 20 mA	max. 20 mA	max. 20 mA (AUX)
Protection category	IP 30	IP 30	IP 30	IP 30
Permissible operating temperature	-10 °C . . . +55 °C	-10 °C . . . +55 °C	-10 °C . . . +55 °C	-10 °C . . . +55 °C

FAP-520 Automatic Fire Detectors LSN improved version



The detectors and trim rings in the "transparent with color inserts" version are supplied complete with reversible printed color ring sets, offering a choice of 16 colors for individual color matching.



6

Features

- ▶ **Modern, ultra-flat design**
- ▶ **Smooth, easily-cleaned detector surface**
- ▶ **Innovative fastening mechanism**
- ▶ **High reliability**
- ▶ **Maintains LSN loop functions in the event of wire interruption or short-circuit thanks to two integrated isolators**
- ▶ **Extended system parameters of improved LSN technology**

The FAP-520 Automatic Fire Detectors combine the advantages of the improved LSN technology with the aesthetic benefits of flush-mounted installation and the option to choose the color. The detectors are specially designed for connection to the Modular Fire Panel FPA-5000 with the significantly extended LSN system parameters.

The FAP-520 is available as a scattered light smoke detector or as a multi-sensor detector with an additional gas sensor. The respective versions of the detectors are available in white or transparent with color toning inserts.

Functions

The smooth, flush-installation surface means the FAP-520 Fire Detectors can be installed in areas with high aesthetic requirements. In addition, the detectors are suitable for areas with heightened dust exposure.

Sensor technology and signal processing

All detectors in the FAP-520 Series are equipped with two optical sensors and a pollution sensor. The FAP-OC-520 multisensor detector contains a gas sensor as an additional detection channel.

The individual sensors can be programmed with RPS or WinPara software via the LSN network. All sensor signals are constantly analyzed by the internal signal evaluation electronics and are linked with each other through algorithms.

By linking the optical sensors and the gas sensor, the OC detector can also be used in places where the work carried out gives rise to small amounts of smoke, steam or dust. The alarm will only be triggered automatically if the signal combination corresponds with the characteristic diagram of the installation location that was selected during configuring. Consequently, a very high reliability against false alarms is obtained.

When 50% of the alarm threshold is reached, a pre alarm is signaled (displayed in the event database of the fire panel).

Optical sensor (smoke sensor)

The optical sensor (1) operates according to the scattered light method.

The LEDs (3) transmit light at a defined angle into the scattered light area (7).

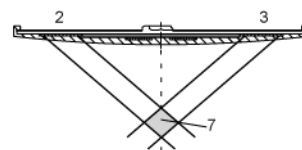

In case of fire, the light is scattered by the smoke particles and strikes the photo diodes (2), which transform the quantity of light into a proportional electrical signal.

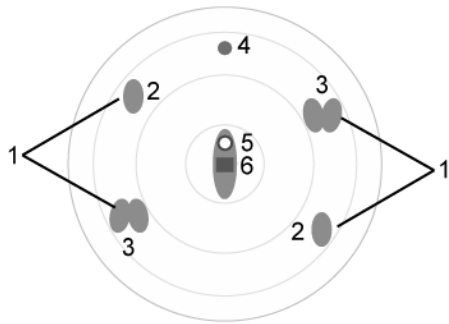

Interference effects from daylight and commercial lighting sources are filtered out with an optical daylight filter and by the use of electronic filtering and phase-locked rectification (ambient light stability: glare test DIN EN 54-7).

The various light-emitting and photo diodes of the sensor are individually controlled by the detector electronics. Consequently, signal combinations are produced that are independent of each other and ideally suitable for the detection of smoke, which makes it possible to differentiate between smoke and interference agents (insects, objects). In addition, the time characteristics and the correlation of the optical sensor signals for the fire or interference detection are evaluated.

Moreover, plausibility checking of the various signals makes it possible to detect errors in the analysis electronics and the LEDs.

Chemical sensor (CO gas sensor)

The gas sensor (4) detects mainly the carbon monoxide (CO) that is produced by a fire, but it also detects hydrogen (H) and nitrogen monoxide (NO).

The basic measuring principle is CO oxidation on an electrode and the measurable current that arises from this. The sensor signal value is proportional to the concentration of gas.

The gas sensor delivers additional information to effectively suppress deceptive values.

The CO sensor is monitored by measuring the internal capacity. If the capacity lies outside the permitted range, an error message is output on the fire panel. In this case, the detector continues to operate purely as a scattered light smoke detector.

Depending on the service life of the gas sensor, the FAP-OC 520 Fire Detector switches off the C sensors after five years of operation. The detector will continue to function as an O detector. The detector should then be exchanged immediately in order to be able to keep using the higher reliability of detection of the OC detector.

Pollution sensor

The contamination level on the detector surface is continually measured by the pollution sensor (6); the result is evaluated and indicated in three stages on the fire panel.

Contamination of the detector surface leads to active adaptation of the threshold (drift compensation) and to a fault indication in the case of heavy contamination.

Improved LSN features

The 520 Series Fire Detectors offer all the features of the improved LSN technology:

- Flexible network structures, including "T-tapping" without additional elements
- Up to 254 LSN improved elements per loop or stub line
- Automatic or manual detector addressing selectable via rotary switch, in each case with or without auto-detection
- Power supply for connected elements via LSN bus up to 300 mA
- Unscreened fire detection cable can be used
- Cable length up to 1000 m
- Downwards compatibility to existing LSN systems and control panels.

In addition, the FAP-520 Fire Detectors offer all the established benefits of LSN technology. The following data can be read out for each configured detector:

- Serial number
- Contamination level of the optical section,
- Operating hours
- Current analog values.

In the event of an alarm, individual detector identification is transmitted to the fire panel.

The sensor is self-monitoring. The following errors are indicated on the fire panel:

- Failure of the evaluation electronics or one of the LEDs on the optical sensor
- Heavy contamination (instead of false alarm)
- Failure of the CO sensor (in the case of FAP-OC 520).

Further performance characteristics

Various operating states are indicated on the detector by means of a clearly visible two-color LED. In the event of an alarm, the LED flashes red.

The control of an external detector alarm display is possible.

Preservation of the LSN loop function is guaranteed in the event of wire interruption or short circuit by means of integrated isolators.

The innovative detector locking, which operates on the ballpoint-pen principle, provides fast and simple insertion and replacement of the detector. We recommend the specially developed FAA-500-RTL exchanger device, especially in the case of high installation heights.

To allow convenient detector testing, the FAA-500-TTL test adapter with magnet and additional service accessories is available. The magnet triggers a reed contact, which sets the detector in test mode.

Certifications and Approvals

Complies with

- EN54-7:2000/A1:2002/A2:2006
- EN54-17:2005

Region	Certification	
Europe	CE	FAP-520 / FAA-500-R
	CPD	0786-CPD-20201 FAP-O 520 / 520-P 0786-CPD-20202 FAP-OC 520 / 520-P
Germany	VdS	G 205125 FAP-O 520/520-P G 205119 FAP-OC 520/520-P
Poland	CNBOP	2565/2007 FAP-O 520, FAP-O 520-P 2566/2007 FAP-OC 520, FAP-OC 520-P
Hungary	TMT	TMT-20/2006 FAP-O 520, FAP-O 520-P TMT-21/2006 FAP-OC 520, FAP-OC 520-P
Russia	GOST	POCC DE.C313B06300

Installation/Configuration Notes

- Can be connected to the Modular Fire Panel FPA-5000 with the improved LSN system parameters
- in "Classic Mode" can be connected to the LSN fire panels BZ 500 LSN, UEZ 2000 LSN, UGM 2020 and to other panels or their receiver modules with identical connection conditions, although with the previous LSN system parameters
- The detectors and detector bases can be used together with the „Rotaris“ lamp by Philips.
- The detectors must be installed exclusively in the FAA-500 LSN Bases provided. In addition, the detector base must be installed in an FAA-500-BB Ceiling Mount Back Box or in an FAA-500-SB Surface Mount Back Box.

Note For flush ceiling mounting with FAA-500-BB: The false ceiling may have a maximum thickness of 32 mm. Above the false ceiling, a free height of at least 110 mm is required.

- The detectors are not intended for outdoor use.
- A hemispherical space with a radius of 50 cm must remain free below the detectors.

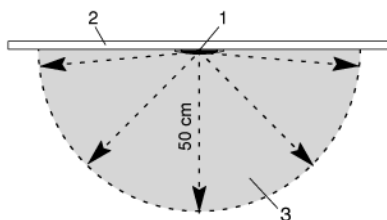

- 1 Detector
- 2 Ceiling
- 3 Hemispherical space below the detector

- Care must be taken to ensure that neither people, large animals, plants, swinging doors nor any objects intrude into this area and that no parts of the detector surface become covered.
- The detectors may only be installed in a position which is out of arm's reach. We therefore recommend a minimum installation height of 2.70 m.
- The detectors may not be installed in rooms in which data is transmitted by means of high-intensity infrared light (e.g. in rooms with IR systems for interpreters).
- The detectors must be mounted so that they are not exposed to any direct sunlight.

- A minimum distance of 50 cm from lamps must be maintained. The detectors may not be mounted in a cone of light from lamps.
- The bases are equipped as standard with a spring which is suitable for installation of the detector in false ceilings. When the detector is installed in concrete or wooden ceilings, these need to be replaced by the stronger springs FAA-500-SPRING with red markings.
- Maximum permitted air speed: 20 m/s
- Country-specific standards and guidelines must be observed during the planning phase.

Installation/configuration notes in accordance with VdS/VDE

- In accordance with VDE, only 127 detectors may be connected to the loop, while only 32 automatic or 10 manual detectors may be connected in the stub.
- The FAP-OC 520, like the FAP-O 520, is planned according to the guidelines for optical detectors (see DIN VDE 0833 Part 2 and VDS 2095).

Parts Included

Detector type	Qty.	Components
FAP-O 520	1	Optical Smoke Detector, White
FAP-O 520-P	1	Optical Smoke Detector, Transparent with Color Inserts
FAP-OC 520	1	Multisensor Detector Optical/Chemical, White
FAP-OC 520-P	1	Multisensor Detector Optical/Chemical, Transparent with Color Inserts

Technical Specifications

Electrical

Operating voltage	15 V DC . . 33 V DC
Current consumption	< 3.26 mA
Alarm output	Per data word by two-wire signal line
Indicator output	Open collector connects 0 V over 1.5 kΩ through, max. 15 mA

Mechanics

Dimensions

• Detector	Ø 113 x 55 mm
• Detector with Trim Ring	Ø 150 x 55 mm
• Detector with Trim Ring, Base and Ceiling Mount Back Box	Ø 150 x 110 mm

Housing material	Polycarbonate
------------------	---------------

Color

• Detector housing	Signal white, RAL 9003
• Detector front plate FAP-O 520/ FAP-OC 520	signal white matt
• Detector front plate FAP-O 520-P/ FAP-OC 520-P	transparent/silver-gray

Weight	Without / with packaging
--------	--------------------------

• FAP-OC 520(-P)	180 g / 370 g
• FAP-O 520(-P)	170 g / 360 g
• Trim Ring	30 g / 60 g

Environmental conditions

Permissible operating temperature

• FAP-O 520 (-P)	-20 °C ... +65 °C
• FAP-OC 520 (-P)	-10 °C ... +50 °C

Permissible relative humidity 95% (non-condensing)

Permissible air speed 20 m/s

Protection class as per EN 60529

• FAP-O 520 (-P)	IP 53
• FAP-OC 520 (-P)	IP 33

Planning

Monitoring area	Max. 120 m ² (Heed local guidelines!)
Maximum installation height	16 m (Heed local guidelines!)
Minimum installation height	Out of arm's reach Minimum installation height recommended by BOSCH: 2.70 m
Minimum distance to lamps	0.5 m
For flush ceiling mounting with FAA-500-BB	
• Thickness of the false ceiling	Max. 32 mm
• Required bored hole	Ø 130 mm (-1 mm ... +5 mm)
• Installation depth	110 mm Note: Above the false ceiling, a free height of at least 110 mm is required.

Further characteristics

Detection principle

• FAP-O 520(-P)	Scattered light measurement
• FAP-OC 520(-P)	Combination of scattered light measurement and combustion gas measurement

Response sensitivity

• FAP-O 520(-P)	< 0.18 dB/m (EN 54-7)
• FAP-OC 520(-P)	Optical section: < 0.36 dB/m (EN 54-7) Gas sensor section: in ppm range

Individual display Two-color LED, red (alarm), green (test mode)

Ordering Information

FAP-O 520 Optical Smoke Detector, White	FAP-O 520
FAP-O 520-P Optical Smoke Detector, Transparent with Color Inserts	FAP-O 520-P
FAP-OC 520 Multisensor Detector Optical/Chemical, White	FAP-OC 520
FAP-OC 520-P Multisensor Detector Optical/Chemical, Transparent with Color Inserts	FAP-OC 520-P

Ordering Information

Accessories

FAA-500-TR-W Trim Ring, White for 500 and 520 Series Fire Detectors	FAA-500-TR-W
FAA-500-TR-P Trim Ring, Transparent with Color Inserts for 500 and 520 Series Fire Detectors	FAA-500-TR-P
FAA-500 LSN Base for installation of the FAP-520 Fire Detector	FAA-500
FAA-500-R LSN Base with Relay Only used in conjunction with the 5000 Series Modular Fire Panel.	FAA-500-R
FAA-500-GB LSN Base for GB	FAA-500-GB
FAA-500-R-GB LSN Base with Relay for GB Only used in conjunction with the 5000 Series Modular Fire Panel.	FAA-500-R-GB
FAA-500-BB Ceiling Mount Back Box for ceiling flush installation in false ceilings when mounting 500 and 520 Series Bases and Fire Detectors	FAA-500-BB
FAA-500-CB Built-in Housing for Concrete Ceilings	FAA-500-CB
FAA-500-SB Surface Mount Back Box	FAA-500-SB
FAA-500-SB-H Surface Mount Back Box with Damp Room Seal	FAA-500-SB-H
FAA-500-SPRING for Concrete/Wooden Ceilings (DU = 10 units)	FAA-500-SPRING

FAP-520 Automatic Fire Detectors LSN improved version



FAP-O 520



FAP-O 520-P



FAP-OC 520



FAP-OC 520-P

	FAP-O 520	FAP-O 520-P	FAP-OC 520	FAP-OC 520-P
Detector type	optical	optical	optical/chemical	optical/chemical
Operating voltage	15 V DC . . . 33 V DC	15 V DC . . . 33 V DC	15 V DC . . . 33 V DC	15 V DC . . . 33 V DC
Current consumption	< 3.26 mA	< 3.26 mA	< 3.26 mA	< 3.26 mA
Protection category	IP 53	IP 53	IP 33	IP 33
Permissible operating temperature	-20 °C . . . +65 °C	-20 °C . . . +65 °C	-10 °C . . . +50 °C	-10 °C . . . +50 °C
Monitoring area	max. 120 m ²	max. 120 m ²	max. 120 m ²	max. 120 m ²
Maximum installation height	16 m	16 m	16 m	16 m
Color	white	transparent with color inserts	white	transparent with color inserts

FAP-420/FAH-420 Automatic Fire Detectors LSN improved version



Features

- ▶ **Combination of optical, thermal and chemical sensors with intelligent evaluation electronics.**
- ▶ **Detector properties adapted to cater for room usage**
- ▶ **Drift compensation in optical and gas measurement section**
- ▶ **Maintains LSN loop functions in the event of wire interruption or short-circuit thanks to two integrated isolators**
- ▶ **Extended system parameters of improved LSN technology**

The 420 Series Automatic Fire Detectors combine the advantages of the improved LSN technology with the performance characteristics of the proven MAGIC.SENS Fire Detectors, which are distinguished by superb accuracy as well as detection speed and precision. These have been specially designed for connection to the Modular Fire Panel FPA-5000 with the significantly improved LSN system parameters. Integrated turning switches ensure easy addressing of detectors, either automatically or manually, as well as with or without autodetection.

System Overview

Operating mode	Detector type			
	FAP-OTC 420	FAP-OT 420	FAP-O 420(KKW)	FAH-T 420(KKW)
Combined	x	x	-	-
Optical	x	x	x	-
Thermo-max.	x	x	-	x
Thermal differential	x	x	-	x
Chemical (+ optical)	x	-	-	-

Functions

Sensor technology and signal processing

The individual sensors can be configured via the LSN network manually or using a timer.

All sensor signals are analyzed continually by the internal evaluation electronics and are linked with each other via an inbuilt microprocessor. The link between the sensors means that the combined detectors can also be used where light smoke, steam or dust must be expected during the course of normal operation.

Only if the signal combination corresponds to that for the programming of the selected usage site field code will the alarm be triggered automatically. This results in a higher level of security against false alarms.

In addition, the time curve for fire and malfunction detection sensor signals is also analyzed, resulting in increased reliability of detection for each individual sensor.

In the case of the optical and chemical sensor, the response threshold (drift compensation) is actively adjusted. Manual or time-controlled switch-off of individual sensors is required for adjustment to extreme interference factors.

Optical sensor (smoke sensor)

The optical sensor uses the scattered-light method.

An LED transmits light to the measuring chamber, where it is absorbed by the labyrinth structure. In the event of a fire, smoke enters the measuring chamber and the smoke particles scatter the light from the LED. The amount of light hitting the photo diode is converted into a proportional electrical signal.

Thermal sensor (temperature sensor)

A thermistor in a resistance network is used as a thermal sensor, from which an analog-digital converter measures the temperature-dependent voltage at regular intervals.

Depending on the specified detector class, the temperature sensor triggers the alarm status when the maximum temperature of 54 °C or 69 °C is exceeded (thermal maximum), or if the temperature rises by a defined amount within a specified time (thermal differential).

Chemical sensor (CO gas sensor)

The main function of the gas sensor is to detect carbon monoxide (CO) generated as a result of a fire, but it will also detect hydrogen (H) and nitrous monoxide (NO). The sensor signal value is proportional to the concentration of gas. The gas sensor delivers additional information to effectively suppress deceptive values.

Depending on the service life of the gas sensor, the FAP-OTC 420 detector switches off the C sensors after five years of operation. The detector will continue to function as an OT detector. The detector should then be exchanged immediately in order to be able to keep using the higher reliability of detection of the OTC detector.

Improved LSN features

The 420 Series Fire Detectors offer all the features of the improved LSN technology:

- Flexible network structures, including "T-tapping" without additional elements
- Up to 254 LSN improved elements per loop or stub line
- Automatic or manual detector addressing selectable via rotary switch, in each case with or without auto-detection
- Power supply for connected elements via LSN bus up to 300 mA
- Unscreened fire detection cable can be used
- Cable length up to 1000 m
- Downwards compatibility to existing LSN systems and central units

LSN features

Operating data display

In addition, the FAP/FAH-420 detectors offer all the established benefits of LSN technology. RPS or WinPara software can be used to change the detection characteristics of the respective room utilization. In addition, each configured detector, with the exception of the KKW types, can provide the following data:

- Serial number,
- Contamination level of the optical section,
- Operating hours,
- Current analog values.

Analog values are:

- Optical system values: current measured value of the scattered light sensor; the measuring range is linear and covers from 170 (new) to 700 (dirty).
- Contamination: the contamination value shows how much the current contamination value has increased relative to the original condition.
- CO value: display of the current measured value (max. 550).

Self-monitoring of sensor technology

The sensor is self-monitoring. The following errors are indicated on the fire panel:

- Fault indication in the event of the failure of the detector electronics
- Continuous display of contamination level during service
- Fault indication if heavy contamination is detected (in place of false alarms)

In the event of wire interruption or short-circuit, integrated dividing elements maintain the functional security of the LSN loop.

In the event of an alarm, individual detector identification is transmitted to the fire panel.

Further performance characteristics

The detectors have a dust-repellent labyrinth and cap construction.

The detector alarm indication takes the form of a red flashing LED that is easily visible 360°.

It is possible to activate a remote external detector alarm display.

The stable and robust detector base no longer has to be directed due to the centralized position of the individual display.

The integrated strain relief for interfloor cables prevents the removal of cables from the terminal after installation. The terminals for cable cross-sections up to 2.5 mm² are very easily accessible.

The detector bases have a mechanical removal lock (can be activated/deactivated).

Certifications and Approvals

The detectors comply with:

Region	Certification		
Europe	CE	FAP/FAH-420 / FAA-MSR420 / FAA-MS-R-SP	
		FAP- / FAH-420 KKW	
	CPD	0786-CPD-20129	FAH-T 420
		0786-CPD-20128	FAH-T 420 KKW
		0786-CPD-20117	FAP-O 420
		0786-CPD-20125	FAP-O 420 KKW
		0786-CPD-20118	FAP-OT 420
0786-CPD-20119	FAP-OT 420		
0786-CPD-20120	FAP-OTC 420		
0786-CPD-20121	FAP-OTC 420		
Germany	VdS	G 205080	FAP-OTC 420
		G 205081	FAP-OT 420
		G 205082	FAP-O 420
		G 205083	FAH-T 420
		G 205088	FAP-O 420 KKW
		G 205089	FAH-T 420 KKW
Turkey	TSE	14.10.01/TSE-6990 Detectors	

Region	Certification		
Hungary	TMT	TMT-19/2006 FAP-OT 420, FAP-OT 420 KKW, FAP-OTC 420	
		TMT-17/2006 FAP-O 420, FAP-O 420 KKW	
		TMT-18/2006 FAH-T 420, FAH-T 420 KKW	
Russia	GOST	POCC DE.C313B06300	
Detector type	EN54-5:2000/ A1:2002	EN54-7:2000/ A1:2002/ A2:2006	EN54-17:2005
FAP-OTC 420	∅	∅	∅
FAP-OT 420	∅	∅	∅
FAP-O 420		∅	∅
FAH-T 420	∅		∅
FAP-O 420 KKW		∅	∅
FAH-T 420 KKW	∅		∅

Installation/Configuration Notes

- For connection to the Modular Fire Panel FPA-5000 with the improved LSN system parameters
- in "Classic Mode" can be connected to the LSN fire panels BZ 500 LSN, UEZ 2000 LSN, UGM 2020 and to other panels or their receiver modules with identical connection conditions, although with the previous LSN system parameters
- During planning works, it is essential to adhere to national standards and guidelines.

Installation/configuration notes in accordance with VdS/VDE

- The FAP-OTC 420, and FAP-OT 420 types are planned in accordance with the guidelines for optical detectors if operated as optical detectors or as combined optical/thermal detectors (see DIN VDE 0833 Part 2 and VDS 2095)
- If occasional disconnection of the optical unit (scattered light sensor) is required, planning must be based on the guidelines for heat detectors (see DIN VDE 0833 Part 2 and VDS 2095)
- When planning fire barriers according to DIBt, note that the FAH-T 420 (KKW) must be configured in accordance with class A1R.

Parts Included

Detector type	Qty.	Components
FAP-OTC 420	1	Multisensor Detector Optical/Thermal/Chemical
FAP-OT 420	1	Multisensor Detector Optical/Thermal
FAP-O 420	1	Optical Smoke Detector
FAH-T 420	1	Heat Detector (Thermal Differential/Thermal Maximum)
FAP-O 420 KKW	1	Optical Smoke Detector *
FAH-T 420 KKW	1	Heat Detector (Thermal Differential/Thermal Maximum) *

* For use in areas with increased radioactive radiation

Technical Specifications

Electrical

Operating voltage	15 VDC . . . 33 VDC
Current consumption	< 0.51 mA
Alarm output	Per data word by two-wire signal line
Indicator output	Open collector connects 0 V over 1.5 kΩ through, max. 15 mA

Mechanics

Dimensions	
• Without base	∅ 99.5 x 52 mm
• With base	∅ 120 x 63.5 mm
Housing	
• Material	Plastic, ABS (Novodur)
• Color	White, similar to RAL 9010, matt finish
Weight	
• FAP-OTC 420	Approx. 80 g / approx. 125 g
• FAP-OT 420, FAP-O 420 (KKW) and FAH-T 420 (KKW)	Approx. 75 g / approx. 115 g

Environmental conditions

Permissible operating temperature	
• FAP-OTC 420	-10 °C . . . +50 °C
• FAP-OT 420	-20 °C . . . +50 °C
• FAP-O 420 (KKW)	-20 °C . . . +65 °C
• FAH-T 420 (KKW)	-20 °C . . . +50 °C
Permissible relative humidity	95% (non-condensing)
Permissible air speed	20 m/s.
Protection class as per EN 60529	IP 40, IP 43 detector base with damp room seal

Planning

Monitoring area

- FAP-OTC 420, FAP-OT 420, FAP-O 420 (KKW) Max. 120 m² (Heed local guidelines!)

- FAH-T 420 (KKW) Max. 40 m² (Heed local guidelines!)

Maximum installation height

- FAP-OTC 420, FAP-OT 420, FAP-O 420 (KKW) Max. 16 m (Heed local guidelines!)

- FAH-T 420 (KKW) Max. 7.5 m (Heed local guidelines!)

Further characteristics

Response sensitivity

- Optical part In accordance with EN 54 T7 (programmable)
- Thermal maximum part > 54 °C / >69 °C
- Thermal differential part A1R / A2R / BR, in line with prEN 54-5 (programmable)
- Gas sensor In ppm range

Individual display

LED red

Color code

- FAP-OTC 420 Yellow loop
- FAP-OT 420 Black loop
- FAP-O 420 (KKW) No marking
- FAH-T 420 (KKW) Red loop

Ordering Information

FAP-OTC 420 Multisensor Detector Optical/Thermal/Chemical FAP-OTC 420

FAP-OT 420 Multisensor Detector Optical/Thermal FAP-OT 420

FAP-O 420 Optical Smoke Detector FAP-O 420

FAH-T 420 Heat Detector FAH-T 420
thermal differential/thermal maximum

FAP-OT 420 KKW multisensor detector optical/thermal FAP-OT420-KKW

FAP-O 420 KKW Optical Smoke Detector FAP-O420-KKW
for use in areas with increased radioactive radiation

FAH-T 420 KKW Heat Detector FAH-T420-KKW
thermal differential/thermal maximum, for use in areas with increased radioactive radiation

Accessories

MS 400 Detector Base MS 400
for surface-mounted and flush-mounted cable feed

MSF 400 Detector Base with Damp Room Seal MSF 400
for surface-mounted and flush-mounted cable feed

MSC 420 Additional Base with Damp Room Seal MSC 420
for surface-mounted cable feed

Ordering Information

FAA-MSR 420 Detector Base with Relay FAA-MSR 420

FAA-MS 420-R-SP Detector Base with Relay and Spring FAA-MS 420-R-SP
for use in Great Britain

MS 420 LSN Detector Base with Spring MS 420
for use in Great Britain

SSK 400 Protective Dust Cover SSK 400
(packing unit = 10 units)

TP4 400 Support Plate for Detector Identification TP4 400
(packing unit = 50 units)

TP8 400 Support Plate for Detector Identification TP8 400
(packing unit = 50 units)

SK 400 Protective Basket SK 400

MH 400 Detector Heating Element MH 400

MK 400 Detector Console MK 400
Console for DIBt compliant mounting of detectors above doors etc., including detector base

Mounting Bracket for Fire Detectors on False Floor Stilts FMX-DET-MB

MPA External Detector Alarm Display according to DIN 14623 MPA

FAA-420-RI Remote Indicator FAA-420-RI

EMK 36 LSN Built-in Magnetic Contact



- 1 Contact
- 2 Magnet

Distances diagram

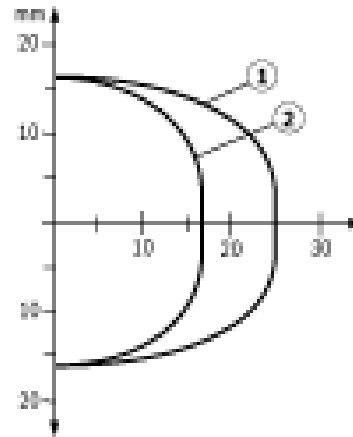

- 1 Extraction
- 2 Proximity switch part

Connecting LSN contacts

- Each LSN contact is a physical LSN element (1 out of 127 possible per loop).
- The length of LSN contact connection cables must be included when planning the total line length of the LSN loop, as LSN technology is incorporated in these detectors.
- Passive coupling elements for joining the connection cables to the installation cable must be placed as close as possible to the LSN contacts. The 1 m connection cable with 2 m LSN cable length is included in the calculation of the LSN cable length (LSN is carried into the contacts and back out again).
- Connector boxes (optional) are classified as installation material.

Testing LSN contacts

- Reed switch and microswitch functions can be checked before installation by a high-Ohm multimeter or continuity checker (for diode paths).
- The resistance values are approximate values; a large change in resistance is significant here.

Features

- ▶ LSN flush-mount magnetic contact
- ▶ VdS class B
- ▶ Head-on mounting
- ▶ LSN perimeter protection

Magnetic contacts are used for tear-off surveillance of doors and windows.

Certifications and Approvals

Region	Certification	
Europe	CE	EMK 36 LSN
Germany	VdS	G 101505, B EMK 36 LSN

Installation/Configuration Notes

Installation notes

- Installation of the EMK 36 LSN is head-on.
- Installation can be completed with or without a plastic sleeve. If no plastic sleeve is used, the components should be fixed in the bores.
- Installation in ferromagnetic materials is not permissible for either the contact or the magnets.
- The contacts are generally installed in the door or window frames with the magnet in the window or in the door. If the door or window is opened less than 1 cm, the magnetic contact should not be able to detect this. An opening of more than 3 cm must be detected.

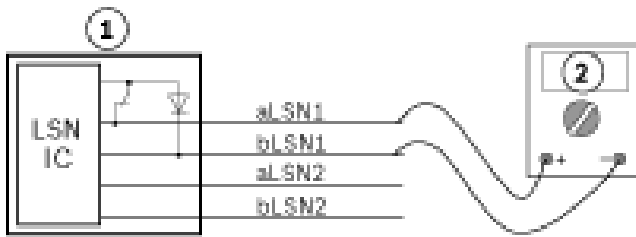

- 1 Detector
 2 High-Ohm multimeter
 Contact open: approx. 3 MOhm
 Contact closed: approx. 1 megaohm

Note Only the intrusion contact can be checked in this way. The tamper switch of the Class C magnetic contact can be checked by the LSN control panel or with the LSN testing device (software version 3.x onward).

6

Parts Included

Type	Qty.	Component
EMK 36 LSN	1	Built-in magnetic contact incl. flange and sleeves

Technical Specifications

Type of installation	Flush, head-on
LSN operating voltage	15 V to 33 V
Current consumption	0.4 mA
VdS environmental class	III
Protection category	IP 67
Permissible ambient temperature	-25 °C to +70 °C
Housing	
• Material	ABS
• Color	White
Dimensions	
• Contact	8 x 35 mm (Ø x L)
• Magnet	6 x 30 mm (Ø x L)
• Plastic sleeve	8 x 31 mm (Ø x L)
• Connection cable	Ø 3.2 mm, length 4 m
Wire colors	aLSN1: white bLSN1: brown aLSN2: white bLSN2: yellow

EMK 36 AT LSN Surface-Mount Magnetic Contact

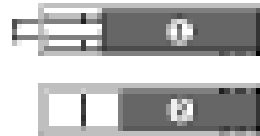

- 1 Contact
- 2 Magnet

Distances diagram (parallel mounting)

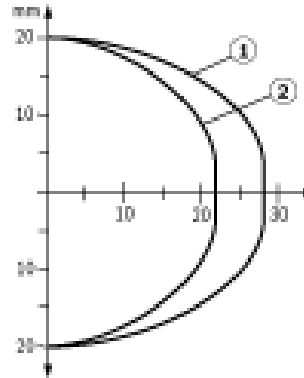

- 1 Extraction
- 2 Proximity switch part

Connecting LSN contacts

- Every LSN contact is a physical LSN element (1 out of 127 possible per loop).
- The length of LSN contact connection cables must be included when planning the total line length of the LSN loop, as LSN technology is incorporated in these detectors.
- Passive coupling elements for joining the connection cables to the installation cable must be placed as close as possible to the LSN contacts. The 1 m connection cable with 2 m LSN cable length is included in the calculation of the LSN cable length (LSN is carried into the contacts and back out again).
- Connector boxes (optional) are classified as installation material.

Testing LSN contacts

- Reed switch and microswitch functions can be checked before installation by a high-Ohm multimeter or continuity checker (for diode paths).
- The resistance values are approximate values; a large change in resistance is significant here.

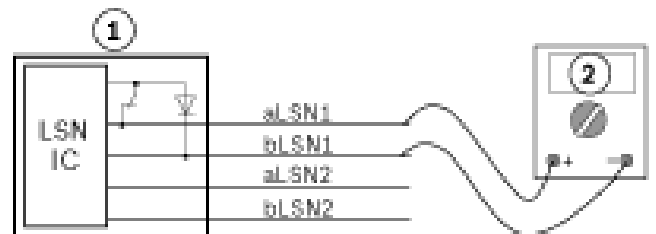

- 1 Detector
- 2 High-Ohm multimeter
Contact open: approx. 3 MOhm
Contact closed: approx. 1 megaohm

Note Only the intrusion contact can be checked in this way. The tamper switch of the Class C

Features

- ▶ LSN surface-mount magnetic contact
- ▶ VdS class B
- ▶ Parallel mounting
- ▶ LSN perimeter protection

Magnetic contacts are used for tear-off surveillance of doors and windows.

Certifications and Approvals

Region	Certification	
Europe	CE	EMK 36 AT LSN
Germany	VdS	G 101504, B EMK 36 AT LSN

Installation/Configuration Notes

Installation notes

- EMK 36 AT LSN installation is parallel.
- For installation on ferromagnetic materials, the distance plates must be used.
- The contacts are generally installed in the door or window frames with the magnet in the window or the door. If the door or window is opened less than 1 cm, the magnetic contact should not be able to detect this. An opening of more than 3 cm must be detected.

magnetic contact can be checked by the LSN control panel or with the LSN testing device (software version 3.x onward).

Parts Included

Type	Qty.	Component
EMK 36 AT LSN	1	Surface-mount magnetic contact incl. flange, sleeves, and surface-mounting housing with accessories

Technical Specifications

Type of installation	Surface mount, parallel
LSN operating voltage	15 V to 33 V
Current consumption	0.4 mA
VdS environmental class	III
Protection category	IP 67
Permissible Ambient temperature	-25 °C to +70 °C
Housing	
• Material	ABS
• Color	White
Dimensions	
• Contact	8 x 35 mm (Ø x L)
• Magnet	6 x 30 mm (Ø x L)
• Plastic sleeve	8 x 31 mm (Ø x L)
• Surface mounting housing	54 x 13 x 12.5 mm
• Connection cable	Ø 3.2 mm, length 4 m
Wire colors	aLSN1: white bLSN1: brown aLSN2: white bLSN2: yellow

EMK 36 S LSN Built-In Magnetic Contact

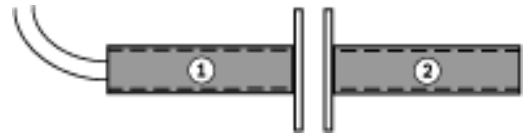

- 1 Contact
- 2 Magnet

Distances diagram

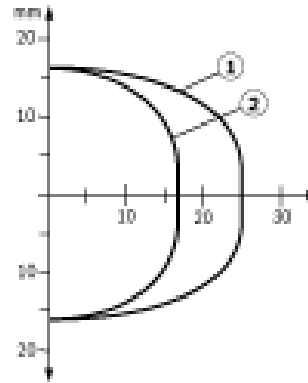

- 1 Extraction
 - 2 Proximity switch part
- Note: If the attached magnets are touching each other, there will be no tamper zone!

Connecting LSN contacts

- Each LSN contact is a physical LSN element (1 out of 127 possible per loop).
- The length of LSN contact connection cables must be included when planning the total line length of the LSN loop, as LSN technology is incorporated in these detectors.
- Passive coupling elements for joining the connection cables to the installation cable must be placed as close as possible to the LSN contacts. The 1 m connection cable with 2 m LSN cable length is included in the calculation of the LSN cable length (LSN is carried into the contacts and back out again).
- Connector boxes (optional) are classified as installation material.

Testing LSN contacts

- Reed switch and microswitch functions can be checked before installation by a high-Ohm multimeter or continuity checker (for diode paths).
- The resistance values are approximate values; a large change in resistance is significant here.

Features

- ▶ LSN flush-mount magnetic contact
- ▶ VdS class C
- ▶ Tamper switch
- ▶ Head-on mounting
- ▶ LSN perimeter protection

Magnetic contacts are used for tear-off surveillance of doors and windows.

Certifications and Approvals

Region	Certification	
Europe	CE	EMK 36 S LSN
Germany	VdS	G 101007, C EMK 36 S LSN

Installation/Configuration Notes

Installation notes

- Installation of the EMK 36 S LSN is head-on.
- Installation can be completed with or without a plastic sleeve. If no plastic sleeve is used, the components should be fixed in the bores.
- Installation in ferromagnetic materials is not permissible for either the contact or the magnets.
- The contacts are generally installed in the door or window frames with the magnet in the window or in the door. If the door or window is opened less than 1 cm, the magnetic contact should not be able to detect this. An opening of more than 3 cm must be detected.

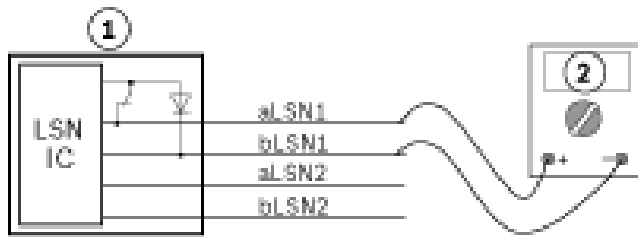

- 1 Detector
 2 High-Ohm multimeter
 Contact open: approx. 3 MOhm
 Contact closed: approx. 1 megaohm

Note Only the intrusion contact can be checked in this way. The tamper switch of the Class C magnetic contact can be checked by the LSN control panel or with the LSN testing device (software version 3.x onward).

6

Parts Included

Type	Qty.	Component
EMK 36 S LSN	1	Built-in magnetic contact incl. flange and sleeves

Technical Specifications

Type of installation	Flush/head-on
LSN operating voltage	15 V to 33 V
Current consumption	0.4 mA
VdS environmental class	III
Protection category	IP 67
Permissible ambient temperature	-25 °C to +70 °C
Housing	
• Material	ABS
• Color	White
Dimensions	
• Contact	8 x 35 mm (Ø x L)
• Magnet	6 x 30 mm (Ø x L)
• Plastic sleeve	8 x 31 mm (Ø x L)
• Connection cable	Ø 3.2 mm, length 4 m
Wire colors	aLSN1: green bLSN1: brown aLSN2: green bLSN2: yellow

MK 36 S LSN Surface-Mount Magnetic Contact

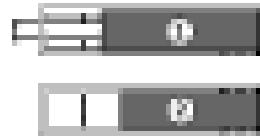

- 1 Contact
- 2 Magnet

Distances diagram

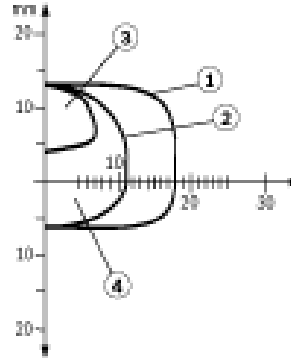

- 1 Extraction
- 2 Proximity switch part
- 3 Tamper area
- 4 Secure area

Features

- ▶ LSN surface-mount magnetic contact
- ▶ VdS class C
- ▶ Tamper switch
- ▶ Parallel mounting
- ▶ LSN perimeter protection

Magnetic contacts are used for tear-off surveillance of doors and windows.

Certifications and Approvals

Region	Certification	
Europe	CE	MK 36 S LSN
Germany	VdS	G 101008, C MK 36 S LSN

Installation/Configuration Notes

Installation notes

- The MK 36 S LSN must be mounted in parallel to the magnet.
- The contacts are generally installed in the door or window frames with the magnet in the window or the door. If the door or window is opened less than 1 cm, the magnetic contact should not be able to detect this. An opening of more than 3 cm must be detected.
- For installation on ferromagnetic materials, the distance plates must be used.

Connecting LSN contacts

- Each LSN contact is a physical LSN element (1 out of 127 possible per loop).
- The length of LSN contact connection cables must be included when planning the total line length of the LSN loop, as LSN technology is incorporated in these detectors.
- Passive coupling elements for joining the connection cables to the installation cable must be placed as close as possible to the LSN contacts. The 1 m connection cable with 2 m LSN cable length is included in the calculation of the LSN cable length (LSN is carried into the contacts and back out again).
- Connector boxes (optional) are classified as installation material.

Testing LSN contacts

- Reed switch and microswitch functions can be checked before installation by a high-Ohm multimeter or continuity checker (for diode paths).
- The resistance values are approximate values; a large change in resistance is significant here.

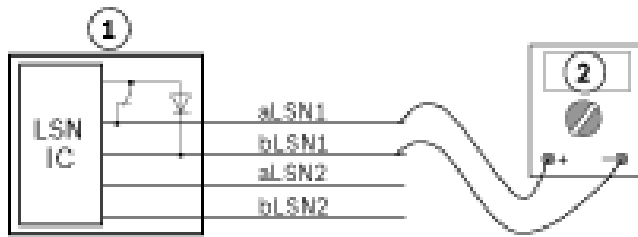

- 1 Detector
 2 High-Ohm multimeter
 Contact open: approx. 3 MOhm
 Contact closed: approx. 1 megaohm

Note Only the intrusion contact can be checked in this way. The tamper switch of the Class C magnetic contact can be checked by the LSN control panel or with the LSN testing device (software version 3.x onward).

6

Parts Included

Type	Qty.	Component
MK 36 S LSN	1	Surface-mount magnetic contact incl. flange, sleeves, and surface-mounting housing with accessories

Technical Specifications

Type of installation	Surface mount/parallel
LSN operating voltage	15 V to 33 V
Current consumption	0.4 mA
VdS environmental class	III
Protection category	IP 67
Permissible ambient temperature	-25 °C to +70 °C
Housing	
• Material	ABS
• Color	White
Dimensions	
• Contact	8 x 35 mm (Ø x L)
• Magnet in plastic sleeve	8 x 20 mm (Ø x L)
• Connection cable	Ø 3.2 mm, length 4 m
• Surface mounting housing	54 x 13 x 12.5 mm
Wire colors	aLSN1: orange bLSN1: brown aLSN2: orange bLSN2: yellow

MSE-LSN B Built-In Magnetic Contact



Features

- ▶ LSN flush-mount magnetic contact
- ▶ VdS class B
- ▶ Head-on or parallel flush mounting
- ▶ LSN perimeter protection

Magnetic contacts are used for tear-off surveillance of doors and windows.

Certifications and Approvals

Region	Certification	
Europe	CE	MSE/MSA-LSN B/C
Germany	VdS	G 104502, B MSE/MSA-LSN B

Installation/Configuration Notes

Installation notes

- Head-on or parallel flush mounting.
- The magnet should be fixed in the bore.
- Head-on installation in ferromagnetic materials is possible with the EG1 flush-mount housing.

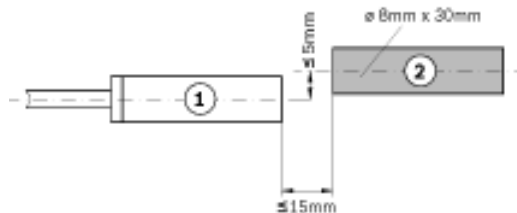

- 1 Contact
- 2 Magnet

Connecting LSN contacts

- Each LSN contact is a physical LSN element (1 out of 127 possible per loop).

- The length of LSN contact connection cables must be included when planning the total line length of the LSN loop, as LSN technology is incorporated in these detectors.
- Passive coupling elements for joining the connection cables to the installation cable must be placed as close as possible to the LSN contacts. The 1 m connection cable with 2 m LSN cable length is included in the calculation of the LSN cable length (LSN is carried into the contacts and back out again).
- Connector boxes (optional) are classified as installation material.

Testing LSN contacts

- Reed switch and microswitch functions can be checked before installation by a high-Ohm multimeter or continuity checker (for diode paths).
- The resistance values are approximate values; a large change in resistance is significant here.

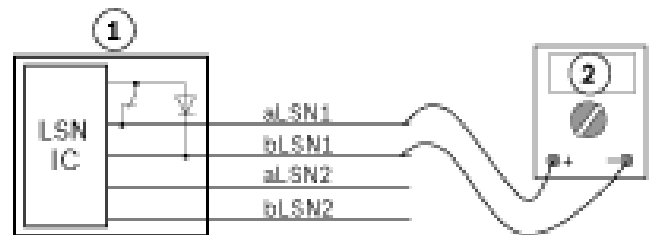

- 1 Detector
- 2 High-Ohm multimeter
Contact open: approx. 3 megaohm
Contact closed: approx. 1 megaohm

Note Only the intrusion contact can be checked in this way. The tamper switch of the Class C magnetic contact can be checked by the LSN control panel or with the LSN testing device (software version 3.x onward).

Parts Included

Type	Qty.	Component
MSE-LSN B	1	Built-in magnetic contact incl. 4 m cable

Technical Specifications

Type of installation	Flush, head-on or parallel
Operating voltage	Max. 33 V _~
Reed contacts	Normally open contact
Switch tolerance	≥ 10 ⁷
Magnet	AlNiCo 500
Switch dimension:	∅ 8 mm x 30 mm
Magnet dimension:	∅ 8 mm x 30 mm
Axial installation distance:	≤ 15 mm
Installation distance with EG1	2 to 6 mm
Temperature range	-25 °C to 70 °C
Connection cable:	4 m, LiY(St) Y 4 x 0.14 mm with screen, exterior ∅ 3.2 mm

Protection category	IP68
Wire colors	aLSN: 2 x white b1LSN: brown b2LSN: yellow

MSA-LSN B Surface-Mount Magnetic Contact

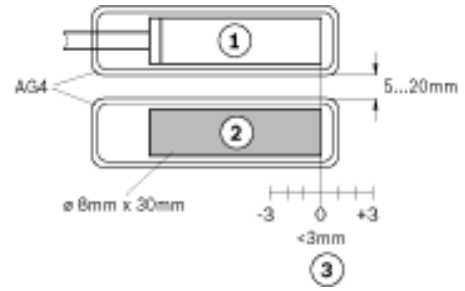

- 1 Contact
- 2 Magnet
- 3 Offset in the axial direction

Connecting LSN contacts

- Each LSN contact is a physical LSN element (1 out of 127 possible per loop).
- The length of LSN contact connection cables must be included when planning the total line length of the LSN loop, as LSN technology is incorporated in these detectors.
- Passive coupling elements for joining the connection cables to the installation cable must be placed as close as possible to the LSN contacts. The 1 m connection cable with 2 m LSN cable length is included in the calculation of the LSN cable length (LSN is carried into the contacts and back out again).
- Connector boxes (optional) are classified as installation material.

Testing LSN contacts

- Reed switch and microswitch functions can be checked before installation by a high-Ohm multimeter or continuity checker (for diode paths).
- The resistance values are approximate values; a large change in resistance is significant here.

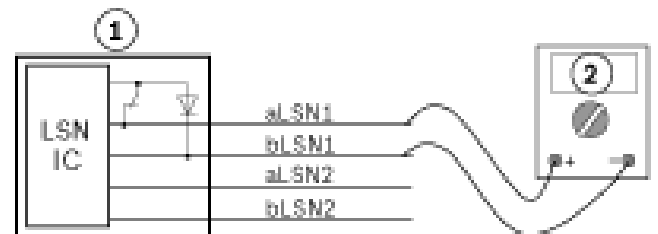

- 1 Detector
- 2 High-Ohm multimeter
Contact open: approx. 3 megaohm
Contact closed: approx. 1 megaohm

Note Only the intrusion contact can be checked in this way. The tamper switch of the Class C magnetic contact can be checked by the LSN control panel or with the LSN testing device (software version 3.x onward).

Features

- ▶ LSN surface-mount magnetic contact
- ▶ VdS class B
- ▶ Parallel or head-on surface mounting
- ▶ LSN perimeter protection

Magnetic contacts are used for tear-off surveillance of doors and windows.

Certifications and Approvals

Region	Certification	
Europe	CE	MSE/MSA-LSN B/C
Germany	VdS	G 104502, B MSE/MSA-LSN B

Installation/Configuration Notes

Installation notes

- Parallel or head-on surface mounting
- Head-on installation in ferromagnetic materials is possible with the EG1 installation housing.

Parts Included

Type	Qty.	Component
MSA-LSN B	1	Surface-mount magnetic contact incl. 4 m cable and 2 x AG4 surface mounting housing with accessories

Technical Specifications

Type of installation	Surface mount, parallel or head-on
Operating voltage	Max. 33 V _~
Reed contacts	Normally open contact
Switch tolerance	≥ 10 ⁷
Magnet	AlNiCo 500
Switch dimension:	Ø 8 mm x 30 mm
Magnet dimension:	Ø 8 mm x 30 mm
Installation distance	5 to 20 mm
AG4 surface mounting housing (H x W x D)	12 x 11.8 x 42.8 mm
Temperature range	-25 °C to 70 °C
Connection cable:	4 m, LiY(St) Y 4 x 0.14 mm with screen, exterior Ø 3.2 mm
Protection category	IP68
Wire colors	aLSN: 2 x white b1LSN: brown b2LSN: yellow

MSE-LSN C Built-In Magnetic Contact



Features

- ▶ LSN flush-mount magnetic contact
- ▶ VdS class C
- ▶ Tamper switch
- ▶ Head-on or parallel flush mounting
- ▶ LSN perimeter protection

Magnetic contacts are used for tear-off surveillance of doors and windows.

Certifications and Approvals

Region	Certification	
Europe	CE	MSE/MSA-LSN B/C
Germany	VdS	G 104006, C MSE/MSA-LSN C

Installation/Configuration Notes

Installation notes

- Head-on or parallel flush mounting.
- The magnet should be fixed in the bore.
- Head-on installation in ferromagnetic materials is possible with the EG 2 mounting kit.

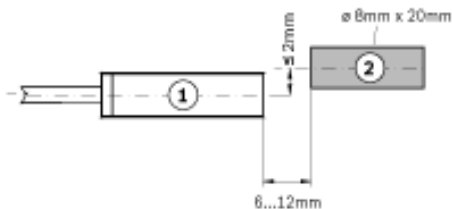

- 1 Contact
- 2 Magnet

Connecting LSN contacts

- Each LSN contact is a physical LSN element (1 out of 127 possible per loop).

- The length of LSN contact connection cables must be included when planning the total line length of the LSN loop, as LSN technology is incorporated in these detectors.
- Passive coupling elements for joining the connection cables to the installation cable must be placed as close as possible to the LSN contacts. The 1 m connection cable with 2 m LSN cable length is included in the calculation of the LSN cable length (LSN is carried into the contacts and back out again).
- Connector boxes (optional) are classified as installation material.

Testing LSN contacts

- Reed switch and microswitch functions can be checked before installation by a high-Ohm multimeter or continuity checker (for diode paths).
- The resistance values are approximate values; a large change in resistance is significant here.

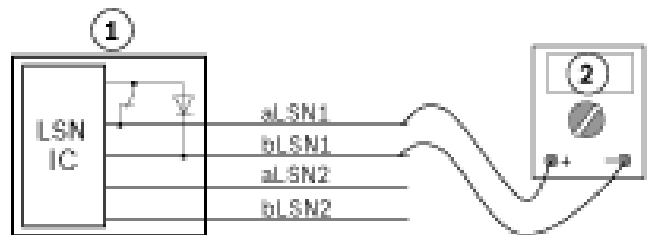

- 1 Detector
- 2 High-Ohm multimeter
Contact open: approx. 3 megaohm
Contact closed: approx. 1 megaohm

Note Only the intrusion contact can be checked in this way. The tamper switch of the Class C magnetic contact can be checked by the LSN control panel or with the LSN testing device (software version 3.x onward).

Parts Included

Type	Qty.	Component
MSE-LSN C	1	Built-in magnetic contact Incl. 4 m cable

Technical Specifications

Type of installation	Flush, head-on or parallel
Operating voltage	Max. 33 V _~
Reed contacts	2 x normally open contact
Switch tolerance	≥ 10 ⁷
Magnet	AlNiCo 500
Switch dimension:	Ø 8 mm x 30 mm
Magnet dimension:	Ø 8 mm x 20 mm
Axial installation distance:	6 to 12 mm
Temperature range	-25 °C to 70 °C
Connection cable:	4 m, LiY(St) Y 4 x 0.14 mm with screen, exterior Ø 3.2 mm

Protection category	IP68
Wire colors	aLSN: 2 x green b1LSN: brown b2LSN: yellow

MSA-LSN C Surface-Mount Magnetic Contact

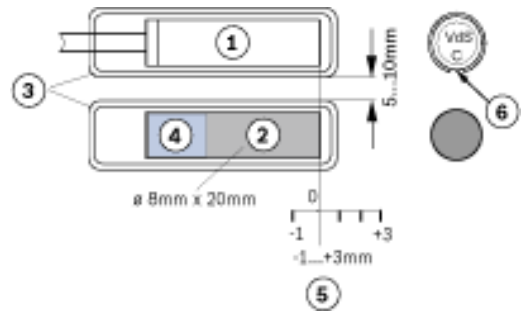

- 1 Contact
- 2 Magnet
- 3 AG4 surface mounting housing
- 4 Plastic part
- 5 Magnet offset in the axial direction
- 6 Warning! The adjustment mark must point to the magnet.

Features

- ▶ LSN surface-mount magnetic contact
- ▶ VdS class C
- ▶ Tamper switch
- ▶ Parallel or head-on surface mounting
- ▶ LSN perimeter protection

Magnetic contacts are used for tear-off surveillance of doors and windows.

Certifications and Approvals

Region	Certification	
Europe	CE	MSE/MSA-LSN B/C
Germany	VdS	G 104006, C MSE/MSA-LSN C
Coun-try	Certification	MSA-LSN C
DE	VdS	G 104006, C

Installation/Configuration Notes

Installation notes

- Head-on or parallel surface mounting.
- The surface mounting version is implemented via the AG4 surface mounting housing and enables installation on ferromagnetic materials.

Connecting LSN contacts

- Each LSN contact is a physical LSN element (1 out of 127 possible per loop).
- The length of LSN contact connection cables must be included when planning the total line length of the LSN loop, as LSN technology is incorporated in these detectors.
- Passive coupling elements for joining the connection cables to the installation cable must be placed as close as possible to the LSN contacts. The 1 m connection cable with 2 m LSN cable length is included in the calculation of the LSN cable length (LSN is carried into the contacts and back out again).
- Connector boxes (optional) are classified as installation material.

Testing LSN contacts

- Reed switch and microswitch functions can be checked before installation by a high-Ohm multimeter or continuity checker (for diode paths).
- The resistance values are approximate values; a large change in resistance is significant here.

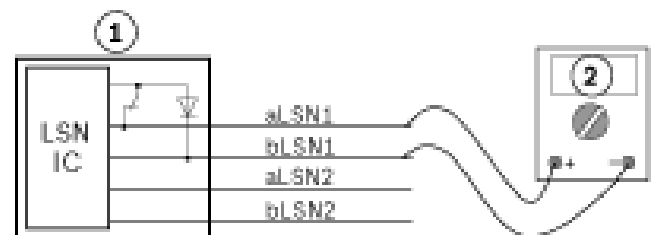

- 1 Detector
- 2 High-Ohm multimeter
Contact open: approx. 3 megaohm
Contact closed: approx. 1 megaohm

Note Only the intrusion contact can be checked in this way. The tamper switch of the Class C magnetic contact can be checked by the LSN control panel or with the LSN testing device (software version 3.x onward).

Parts Included

Type	Qty.	Component
MSA-LSN C	1	Surface-mount magnetic contact incl. 4 m cable and 2xAG4 surface mounting housing with accessories

Technical Specifications

Type of installation	Surface mount, parallel or head-on
Operating voltage	Max. 33 V _~
Reed contacts	2 x normally open contact
Switch tolerance	$\geq 10^7$
Magnet	AlNiCo 500
Switch dimension:	Ø 8 mm x 30 mm
Magnet dimension:	Ø 8 mm x 20 mm + 10 mm spacer
Axial installation distance:	5 to 10 mm
AG4 surface mounting housing (H x W x D)	11 x 11.8 x 42.8 mm
Temperature range	-25 °C to 70 °C
Connection cable:	4 m, LiY(St) Y 4 x 0.14 mm ² with screen, exterior Ø 3.2 mm
Protection category	IP68
Wire colors	aLSN: 2 x green b1LSN: brown b2LSN: yellow

AMK 4 LSN Shutter Door Contact

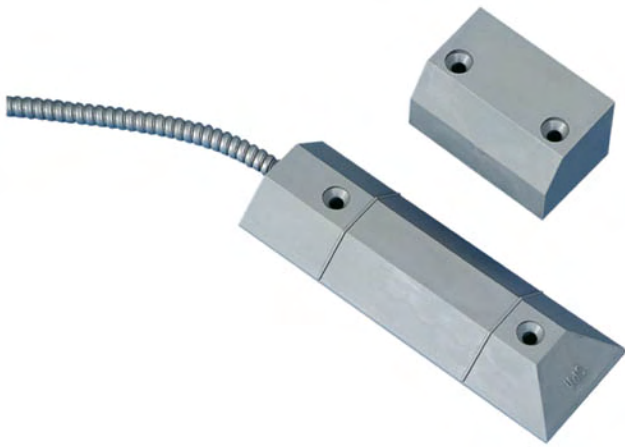

Features

- ▶ Shutter door contact in LSN technology
- ▶ For connecting to the LSN intrusion control panel
- ▶ VdS class B
- ▶ High level of mechanical strength
- ▶ Large switch distance
- ▶ LSN perimeter protection

LSN shutter door contacts are used to monitor rolling, sliding and garage doors.

Certifications and Approvals

Region	Certification	
Europe	CE	AMK 4 LSN
Germany	VdS	G 101503, B AMK 4 LSN

Installation/Configuration Notes

Installation notes

- For doors < 1.5 m, one shutter door contact is required. For doors > 1.5 m, use two shutter door contacts. Take note of the permissible installation tolerances.
- The shutter door contact consists of a sealed magnetic switch and a magnet in a plastic casing.
- The connection cable is protected over 1 m by a metal tube.
- The magnetic switch is installed at ground level (requires a flat surface). Vehicles with rubber tires can drive over the switch without causing problems.
- The magnetic switch must not be used as a door-stopper.

Distances diagram

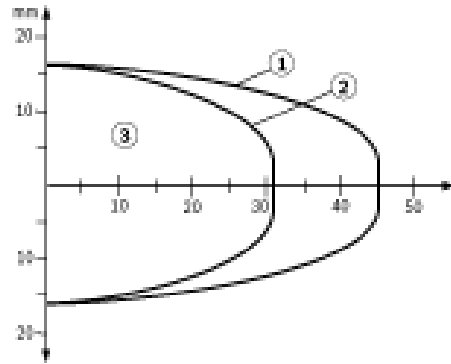

- 1 Extraction
- 2 Proximity switch part
- 3 Standby zone

Connecting LSN contacts

- Each LSN contact is a physical LSN element (1 out of 127 possible per loop).
- The length of LSN contact connection cables must be included when planning the total line length of the LSN loop, as LSN technology is incorporated in these detectors.
- Passive coupling elements for joining the connection cables to the installation cable must be placed as close as possible to the LSN contacts. The 1 m connection cable with 2 m LSN cable length is included in the calculation of the LSN cable length (LSN is carried into the contacts and back out again).
- Connector boxes (optional) are classified as installation material.

Testing LSN contacts

- Reed switch and microswitch functions can be checked before installation by a high-Ohm multimeter or continuity checker (for diode paths).
- The resistance values are approximate values; a large change in resistance is significant here.

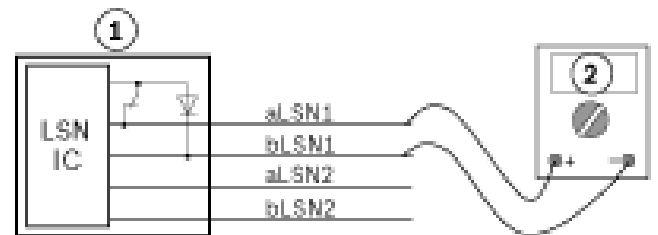

- 1 Detector
- 2 High-Ohm multimeter
Contact open: approx. 3 MOhm
Contact closed: approx. 1 megaohm

Note

Only the intrusion contact can be checked in this way. The tamper switch of the Class C magnetic contact can be checked by the LSN control panel or with the LSN testing device (software version 3.x onward).

Parts Included

Type	Qty.	Component
AMK 4 LSN	1	Shutter door contact with magnet and installation material, including metal tube

Technical Specifications

Type of installation	Surface mount
LSN operating voltage	15 V to 33 V
Current consumption	0.4 mA
VdS environmental class	III
Protection category	IP 67
Permissible ambient temperature	-25 °C to +70 °C
Housing	
• Material	Polyamide
• Color	Gray
Dimensions	
• Contact (H x W x L)	50 x 16.5 x 144 mm
• Magnet (H x W x D)	40 x 35 x 66 mm
• Connection cable	Ø 3.2 mm, length 4 m
• Metal tubing	Ø 6 x 9 mm, length 1 m
Wire colors	aLSN1: white bLSN1: brown aLSN2: white bLSN2: yellow

AMK 4 S LSN Shutter Door Contact



- The magnetic switch must not be used as a door-stopper.

Distances diagram

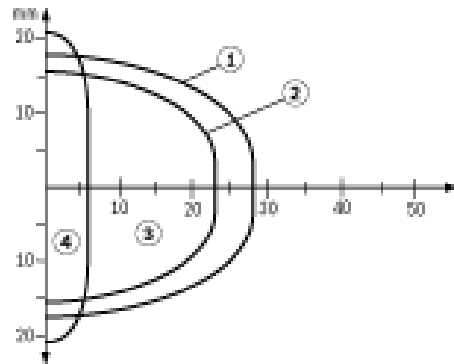

- 1 Extraction
- 2 Proximity switch part
- 3 Standby zone
- 4 Tamper zone

Connecting LSN contacts

- Each LSN contact is a physical LSN element (1 out of 127 possible per loop).
- The length of LSN contact connection cables must be included when planning the total line length of the LSN loop, as LSN technology is incorporated in these detectors.
- Passive coupling elements for joining the connection cables to the installation cable must be placed as close as possible to the LSN contacts. The 1 m connection cable with 2 m LSN cable length is included in the calculation of the LSN cable length (LSN is carried into the contacts and back out again).
- Connector boxes (optional) are classified as installation material.

Testing LSN contacts

- Reed switch and microswitch functions can be checked before installation by a high-Ohm multimeter or continuity checker (for diode paths).
- The resistance values are approximate values; a large change in resistance is significant here.

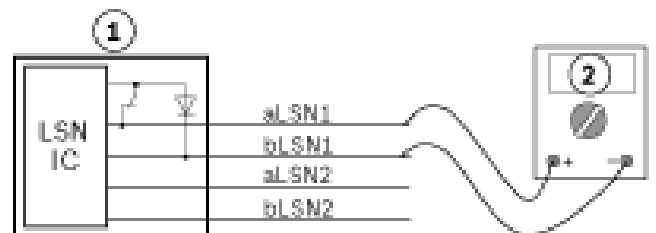

- 1 Detector
- 2 High-Ohm multimeter
Contact open: approx. 3 MOhm
Contact closed: approx. 1 megaohm

Note Only the intrusion contact can be checked in this way. The tamper switch of the Class C magnetic contact can be checked by the LSN control panel or with the LSN testing device (software version 3.x onward).

Features

- ▶ Shutter door contact in LSN technology
- ▶ For connecting to the LSN intrusion control panel
- ▶ VdS class C
- ▶ Tamper switch
- ▶ High level of mechanical strength
- ▶ Large switch distance
- ▶ LSN perimeter protection

LSN shutter door contacts are used to monitor rolling, sliding and garage doors.

Certifications and Approvals

Region	Certification	
Europe	CE	AMK 4 S LSN
Germany	VdS	G 101006, C AMK 4 S LSN

Installation/Configuration Notes

Installation notes

- For doors < 1.5 m, one shutter door contact is required. For doors > 1.5 m, use two shutter door contacts. Take note of the permissible installation tolerances.
- The shutter door contact consists of a sealed magnetic switch and a magnet in a plastic casing.
- The connection cable is protected over 1 m by a metal tube.
- The magnetic switch is installed at ground level (requires a flat surface). Vehicles with rubber tires can drive over the switch without causing problems.

Parts Included

Type	Qty.	Component
AMK 4 S LSN	1	Shutter door contact with magnet and installation material, including metal tube

Technical Specifications

Type of installation	Surface mount
LSN operating voltage	15 V to 33 V
Current consumption	0.4 mA
VdS environmental class	III
Protection category	IP 67
Permissible ambient temperature	-25 °C to +70 °C
Housing	
Material	Polyamide
Color	Gray
Dimensions	
• Contact (H x W x L)	50 x 16.5 x 144 mm
• Magnet (H x W x D)	40 x 35 x 66 mm
• Connection cable	Ø 3.2 mm, length 4 m
• Metal tubing	Ø 6 x 9 mm, length 1 m
Wire colors	aLSN1: green bLSN1: brown aLSN2: green bLSN2: yellow

SKA 100 LSN Bolt Contact



Features

- ▶ Bolt contact in LSN technology
- ▶ For connecting to an LSN intrusion control panel
- ▶ VdS class C
- ▶ LSN perimeter protection

Bolt contacts are used for monitoring the closure of doors.

Certifications and Approvals

Region	Certification	
Europe	CE	SKA 100 LSN
Germany	VdS	G 101009, C SKA 100 LSN

Installation/Configuration Notes

Installation notes

- Installation is carried out in the door bolt with the bolt contact being activated by the tongue of the lock. It should be kept in mind that only the second turn of the key in the lock actually activates the contact. To make any necessary adjustments, the bolt contact's operating spring lever can be bent.
- When installing in fire protection doors, please ensure that no mechanical changes, except for the fastener bores, are carried out on the door frames.

Connecting LSN contacts

- Each LSN contact is a physical LSN element (1 out of 127 possible per loop).
- The length of LSN contact connection cables must be included when planning the total line length of the LSN loop, as LSN technology is incorporated in these detectors.

- Passive coupling elements for joining the connection cables to the installation cable must be placed as close as possible to the LSN contacts. The 1 m connection cable with 2 m LSN cable length is included in the calculation of the LSN cable length (LSN is carried into the contacts and back out again).
- Connector boxes (optional) are classified as installation material.

Testing LSN contacts

- Reed switch and microswitch functions can be checked before installation by a high-Ohm multimeter or continuity checker (for diode paths).
- The resistance values are approximate values; a large change in resistance is significant here.

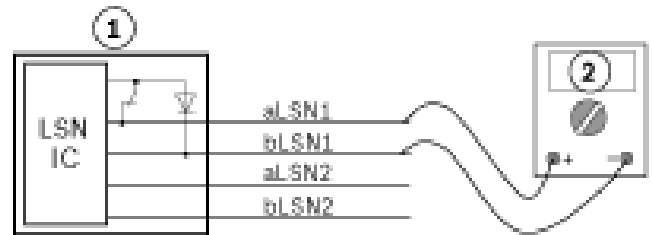

- 1 Detector
 2 High-Ohm multimeter
 Contact open: approx. 3 megaohm
 Contact closed: approx. 1 megaohm

Note Only the intrusion contact can be checked in this way. The tamper switch of the Class C magnetic contact can be checked by the LSN control panel or with the LSN testing device (software version 3.x onward).

Parts Included

Type	Qty.	Component
SKA 100 LSN	1	Bolt contact for perimeter doors, with cable

Technical Specifications

Type of installation	Flush
LSN operating voltage	15 V to 33 V
Current consumption	0.4 mA
VdS environmental class	III
Protection category	IP 67
Permissible ambient temperature	-25 °C to +70 °C
Housing	
• Material	Steel plate
• Color	Gray

Dimensions (H x W x D)

- Without operating lever 37 x 9 x 19 mm
 - With operating lever 74 x 10 x 19 mm
 - Connection cable Ø 3.2 mm, length 4 m
-

Wire colors
aLSN1: green
bLSN1: brown
aLSN2: green
bLSN2: yellow

Ordering Information

SKA 100 LSN Bolt Contact **4998014066**
For monitoring perimeter door closure

SKI 100 LSN Bolt Contact



Features

- ▶ Bolt contact in LSN technology
- ▶ For connecting to an LSN intrusion control panel
- ▶ VdS class C
- ▶ LSN perimeter protection

Bolt contacts are used for monitoring the closure of doors.

Certifications and Approvals

Region	Certification	
Europe	CE	SKI 100 LSN
Germany	VdS	G 101010, C SKI 100 LSN

Installation/Configuration Notes

Installation notes

- Installation is carried out in the door bolt with the bolt contact being activated by the tongue of the lock. It should be kept in mind that only the second turn of the key in the lock actually activates the contact. To make any necessary adjustments, the bolt contact's operating spring lever can be bent.
- When installing in fire protection doors, please ensure that no mechanical changes, except for the fastener bores, are carried out on the door frames.

Connecting LSN contacts

- Each LSN contact is a physical LSN element (1 out of 127 possible per loop).
- The length of LSN contact connection cables must be included when planning the total line length of the LSN loop, as LSN technology is incorporated in these detectors.

- Passive coupling elements for joining the connection cables to the installation cable must be placed as close as possible to the LSN contacts. The 1 m connection cable with 2 m LSN cable length is included in the calculation of the LSN cable length (LSN is carried into the contacts and back out again).
- Connector boxes (optional) are classified as installation material.

Testing LSN contacts

- Reed switch and microswitch functions can be checked before installation by a high-Ohm multimeter or continuity checker (for diode paths).
- The resistance values are approximate values; a large change in resistance is significant here.

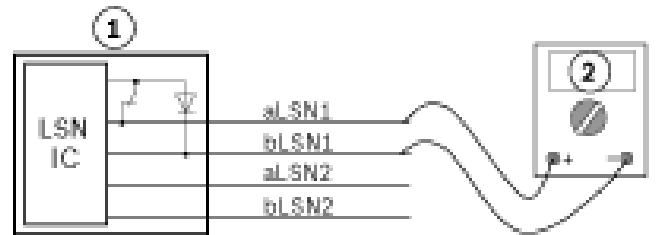

- 1 Detector
- 2 High-Ohm multimeter
Contact open: approx. 3 megaohm
Contact closed: approx. 1 megaohm

Note Only the intrusion contact can be checked in this way. The tamper switch of the Class C magnetic contact can be checked by the LSN control panel or with the LSN testing device (software version 3.x onward).

Parts Included

Type	Qty.	Component
SKI 100 LSN	1	Bolt contact for interior doors, without cable

Technical Specifications

Type of installation	Flush
LSN operating voltage	15 V to 33 V
Current consumption	0.4 mA
VdS environmental class	II
Protection category	IP 54
Permissible ambient temperature	-25 °C to +55 °C
Housing	
• Material	Steel plate
• Color	Gray
Dimensions (H x W x D)	
• Without operating lever	37 x 10 x 19 mm
• With operating lever	74 x 10 x 19 mm
• Connection cable	None

ND 200 LSN Panic Button



6

Features

- ▶ Panic button in LSN technology
- ▶ For connecting to an LSN intrusion control panel
- ▶ Alarm and tampering transmission via LSN bus
- ▶ Tamper contact
- ▶ Cable can be surface- or flush-mounted
- ▶ Cap with cover as trigger protection (optional)

The ND 200 LSN panic button is used for unobtrusively and manually triggering alarms at work places that are in potential danger of being held up, such as banks, jewelry shops, businesses, private households etc.

Certifications and Approvals

Region	Certification	
Europe	CE	ND 200 LSN
Germany	VdS	G 101037, C ND 200 LSN

Parts Included

Type	Qty.	Component
ND 200 LSN	1	Panic button incl. adhesive seal

Technical Specifications

Operating voltage (LSN part)	+12 V to 30 V
Current consumption (line voltage)	Approx. 0.5 mA
Ambient temperature	-0 °C to +50 °C
Ambient climates	DIN 40040 R14
Protection category	IP 40

Housing	
• Material	ABS
• Color	RAL 9002 (housing) Gray (cover)
Weight	Approx. 70 g
Dimensions (D x H)	81 x 31 mm
Environmental class	2

Ordering Information

ND 200 LSN Panic Button **4998117564**

For unobtrusively and manually triggering alarms at work places that are in potential danger of being held up

Accessories

Cap with cover **3902115343**

For additional protective cover to prevent false alarms

IPB-IF100 LSN 16 Zone Expander Module



Features

- ▶ **16 inputs to connect primary lines**
- ▶ **8 control outputs (open drain), each 50 mA**
- ▶ **Cover tamper contact for tamper surveillance**
- ▶ **Monitoring of the external power supply**

The IPB-IF100 LSN is used to connect up to 16 zone inputs with closed-circuit protection to an LSN control panel.

Functions

The IPB-IF100 LSN is used to connect line technology equipment components to the LSN bus.

Up to 16 primary lines (terminal resistance 12.1 kilohm) and 8 control outputs (Open Drain) can be connected.

The IPB-IF100 LSN communicates with the LSN control panel on the basis of the LSN protocol.

The expander module is configured via the control panel using programming software (PC).

The connections use spring terminal technology and partly flat band cable in addition.

Certifications and Approvals

Region	Certification	
Europe	CE	IPB-IF100 LSN
Germany	VdS	G 105022, C IPB-IF100 LSN

Installation/Configuration Notes

Control panels must be installed in accordance with the standards of series DIN VDE 0800 (VdS Classes A, B and C).

When installing, extending, modifying and operating control panels in VdS Classes B and C, DIN VDE 0833 must be applied.

In the case of control panels that need to fulfill the requirements of VdS Schadenverhütung, the guideline VdS 2311 must also be applied.

The primary line cable lengths are not in the cable lengths for LSN. A line resistance of up to 100 Ohm per primary line is permitted.

Parts Included

Type	Qty.	Component
IPB-IF100 LSN	1	16 zone expander module

Technical Specifications

Operating voltage (ext. supply)

- | | |
|-----------------|---------------------------|
| • Power supply | +9 V to +15 VDC |
| • Rated voltage | +12 V |
| • LSN part | 15 V to 36 V (nom.: 33 V) |

Current consumption

- | | |
|-------------------------------------------------|---------------|
| • Current consumption when idling (ext. supply) | Approx. 26 mA |
| • In addition per alarm line (standby) | 0.75 mA |
| • LSN part | 3 mA |

Control outputs (open drain)

- | | |
|--------------------------------------|--------|
| • Max. switching voltage | 12 VDC |
| • Max. permissible switching current | 50 mA |

Number of inputs

Terminal resistance

Housing

- | | |
|--------------------------|---------------------|
| • Dimensions (H x W x D) | 200 x 150 x 42 mm |
| • Color | Light gray RAL 7035 |
| • Material | Steel plate |
| • Weight | 960 g |

Protection category

Environmental class

Permissible ambient temperature

Ordering Information

IPB-IF100 LSN 16 Zone Expander Module **F01U512129**

For monitored connection of conventional detectors (16 primary lines) and for controlling (8 control outputs) on the local security network LSN

NAK 100 LSN Branch Interface

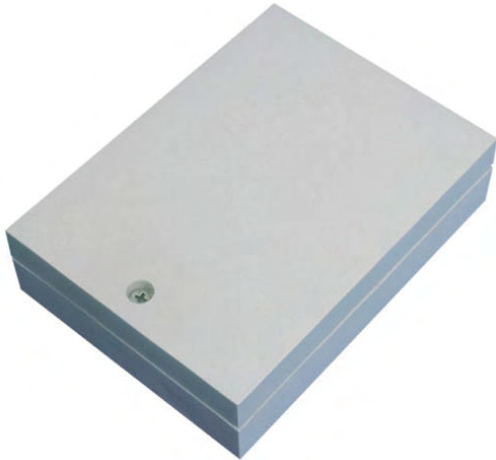

Features

- ▶ Additional stubs with other LSN elements can be switched at the loops.
- ▶ Up to 32 elements can be connected in one stub
- ▶ Tamper contact (sabotage alert)
- ▶ Surface installation

The NAK 100 LSN branch interface connects a branch stub with bus elements to the LSN.

Functions

The module housing has a tamper contact that, if triggered, sends a unique message and is evaluated as a sabotage alert. An integrated buzzer can be used to signal status changes (e.g. for tests).

In the event of wire interruptions or short-circuits, all LSN elements in the LSN loop continue to be monitored. In this case, the system automatically creates two stub lines that continue to monitor from both sides up to the location of the fault.

Certifications and Approvals

Region	Certification	
Europe	CE	NAK 100 LSN
Germany	VdS	G 195059, C NAK 100 LSN

Installation/Configuration Notes

Coupler power supply

The LSN part of all LSN elements (couplers and detectors) is supplied with power via the control panel's 2-wire LSN line.

All LSN couplers are designed to loop through the power supply (+V, -V) of subsequent couplers.

The maximum cable length of the separate power supply (+V, -V) depends on the power intake of the couplers to be supplied and their peripherals, if not powered by an external source.

The applicable voltage range must be taken into account to ensure the correct operation of the LSN coupler.

Cable lengths

Cable length per primary line (PL) or control lines

- Maximum length unshielded cable - 10 m
- Maximum length shielded cable - 500 m

Connection

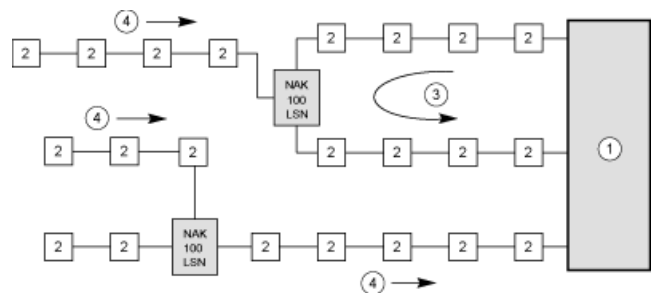

- 1 Control panel
- 2 LSN element
- 3 Loop
- 4 Stub

Up to 32 LSN elements can be connected in a stub line; VdS does not permit the combining of manual and automatic detectors.

According to VdS, a maximum of 10 manual detectors are permitted in a stub line.

A second wire pair can be looped through to provide a separate power supply to subsequent LSN couplers.

Parts Included

Type	Qty.	Component
NAK 100 LSN	1	Branch interface

Technical Specifications

Operating voltage	+10 VDC to +33 VDC
Current consumption	2.5 mA
Connection	Branch for loop or stub lines
Line voltage	+20 mV
Protection category as per EN 60529	IP 30

EN 54 T2 environmental class	I
Ambient climate	DIN 40040 R14
Permissible ambient temperature	0 °C to +50 °C
Housing	
• Material	Plastic, ABS Terluran
• Color	Light gray, RAL 9002
• Dimensions (H x W x D)	135 x 100 x 35.7 mm
Weight	Approx. 140 g

Ordering Information

NAK 100 LSN Branch Interface

NAK 100-AP

For connecting a branch stub with other LSN bus elements to a loop or stub of the local security network LSN

NNK 110 LSN Emergency Call Coupler

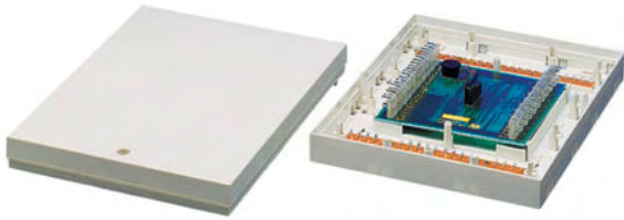

Features

- ▶ 4 primary lines
- ▶ 1 non-monitored line
- ▶ 3 free control outputs
- ▶ Integrated buzzer
- ▶ Tamper contact (sabotage alert)
- ▶ Surface installation

The NNK 110 LSN emergency call coupler is used to connect GLT emergency call units to the LSN.

Functions

Four programmable primary lines that are programmable as hold-up, intrusion, tamper, closure monitoring or other types of detection (can also be used as control input).

A non-monitored line for monitoring closure to obtain forced system actuation when arming monitoring areas can be connected.

Three control outputs are available whose function depends on the detectors attached. Control outputs that are not needed can be freely programmed with the panel functions.

The external power supply is monitored.

Max. four KR 100 LSN relay modules for LSN expanders (option) can be installed.

In the event of wire interruptions or short-circuits, all LSN elements in the LSN loop continue to be monitored. In this case, the system automatically creates two stub lines that continue to monitor from both sides up to the location of the fault.

The module housing has a tamper contact that, if triggered, sends a unique message and is evaluated as a sabotage alert. An integrated buzzer can be used to signal status changes (e.g. for tests).

Certifications and Approvals

Region	Certification	
Europe	CE	NNK 100 LSN
Germany	VdS	G 102069, C NNK 110 LSN

Installation/Configuration Notes

Power supply

A second twin wire lead, referred to as +V/-V, is required to supply power to the remaining expansion module functions and any connected conventional emergency call detectors. The length of the twin wire +V/-V depends on the current consumption of the LSN expanders being supplied and their peripherals, insofar as these do not have independent supplies.

The applicable voltage range must be taken into account and the required power supply must be determined to ensure correct function of the LSN expanders. Voltage range: 9 V to 30 V.

There is an electrically isolated output, $V_0=12$ V, to supply 12 V consuming units (note max. output current).

As the terminal voltage can be 28 V or 12 V, the voltage drop up to the LSN expander can be a maximum of 6 V or 3 V, depending on the type of LSN expander. If current consumption is high, LSN expanders and peripherals can be supplied via a separate line with a larger diameter, if necessary.

Note Current consumption L in at varying supply power and output current L out

+V	L in where L out = 0 mA	L in where L out = 100 mA
9 V	7 mA	240 mA
12 V	7 mA	160 mA
30 V	13 mA	70 mA

In order to keep the total current requirement of the NNK 110 LSN low, the input voltage must be as high as possible. For this reason, it is essential to take account of the voltage drop on the line.

Cable lengths

Cable length per primary line (PL) or control lines

- Maximum length unshielded cable – 10 m
- Maximum length shielded cable – 500 m

Connecting conventional detectors

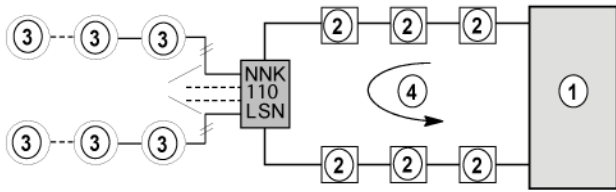

- 1 Control panel
- 2 LSN element
- 3 1-4 DC primary lines
- 4 Loop

Detection and control via two wires

In local security networks, detection and control functions are performed via the LSN line. This means additional primary lines in the control panel are not required for control procedures.

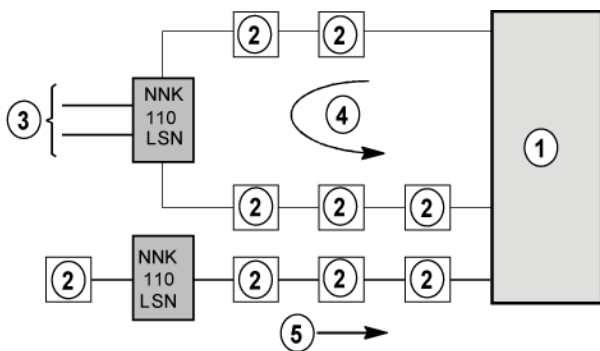

- 1 Control panel
- 2 LSN element
- 3 Control
- 4 Loop
- 5 Stub

Optional KR 100 LSN relay module for LSN expanders

The KR 100 LSN relay module for LSN expanders is intended for use in the NNK 110 LSN and NVK 100 LSN.

The KR 100 LSN is installed if the high power requirement of the connected control elements results in these becoming impossible to actuate directly by the LSN expanders, or in order to enable zero-potential switching.

Up to four KR 100 LSNs can be installed per NNK 110 LSN or NVK 100 LSN. One solder distributor is supplied per two KR 100 LSNs.

Parts Included

Type	Qty.	Component
NNK 110 LSN	1	Emergency call coupler

Technical Specifications

Operating voltage	
• LSN part	+12 V to +33 V
• Other expansion module functions	+9 V to +30 V
Current consumption	2.2 mA for LSN part and 7 mA for the other expansion module functions
Control output 1 (terminal 14)	Open collector, 0 V when active
• Switching voltage	Max. 30 V
• Switching current	Max. 20 mA
Control output 2 (terminal 13)	Open collector, 0 V when active
• Switching voltage	Max. 30 V
• Switching current	Max. 20 mA
Control output 2 (terminal 12)	Open collector, 0 V when inactive
• Switching voltage	Max. 30 V
• Switching current	Max. 10 mA
Control output 3 (connection 15, 16)	Open collector, 12 V when active
• Switching voltage	< 1.5 V
• Switching current	Max. 100 mA
Output voltage	+ 12.65 V
Output current	Max. 100 mA (The total of all V ₀ outputs and control output)
Connection options	4 DC primary lines
1 - 4 primary lines (PL)	
• Terminal resistance	RE = 12k1 Ohm 1%
• Alarm criteria	± 40% of terminal resistance
• Line resistance	Max. 100 Ohm
• Response time	< 200 ms
Closure monitoring	Max. 100 Ohm
Ambient temperature	-5 °C to +45 °C
Housing base/cover	Plastic
Color	RAL 9002 grayish white
Weight	Approx. 400 g
Dimensions (H x W x D)	215 x 160 x 35.5 mm
Protection category	IP 30
Environmental class	II (VdS 2110)
KR 100 optional	
Reel	
• Response voltage	> 7 V
• Fall-off voltage	< 1 V
• Reel voltage	Max. 14.3 V
Contacts	
Principle	2 change-over contacts zero potential
• Starting current	Max. 5 A
• Permanent current	Max. 2 A
• Switch-off current	Max. 1 A
• Switching voltage	Max. 60 V
• Switching performance	Max. 30 W

Current consumption per relay

- At 12 V 20 mA
 - At 28 V 10 mA
-

Ambient temperature 0 °C to +55 °C

Protection category IP 40

Ordering Information**NNK 110 LSN Emergency Call Coupler 4998114146**

For monitored connection of conventional detectors (4 primary lines), to controls (3 control outputs) and a non-monitored line for closure monitoring on the local security network LSN

NVK 100 LSN Coupler

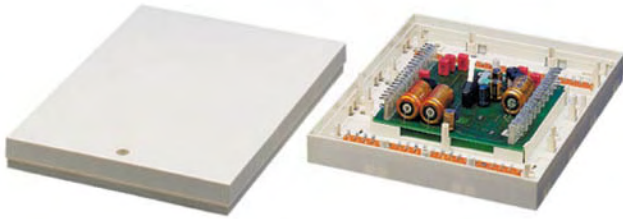

6

Features

- ▶ 6 primary lines
- ▶ 4 control outputs
- ▶ Integrated buzzer
- ▶ Tamper contact (sabotage alert)
- ▶ Surface installation

The NVK 100 LSN coupler is used to connect conventional arming devices to the LSN.

Functions

Four primary lines that are programmable as hold-up/intrusion/tamper/closure or other types of detection.

Two primary lines for connecting arming devices, block locks and log. switching equipment.

In normal operation, an integrated buzzer serves as arming confirmation.

Max. four KR 100 LSN relay modules for LSN expanders (option) can be installed.

In the event of wire interruptions or short-circuits, all LSN elements in the LSN loop continue to be monitored. In this case, the system automatically creates two stub lines that continue to monitor from both sides up to the location of the fault.

The module housing has a tamper contact that, if triggered, sends a unique message and is evaluated as a sabotage alert. An integrated buzzer can be used to signal status changes (e.g. for tests).

Certifications and Approvals

Region	Certification	
Europe	CE	NVK 100 LSN
Germany	VdS	G 195058, C NVK 100 LSN

Installation/Configuration Notes

All sensor technology in the arming device area can be connected to the NVK 100 LSN, for example:

- Conventional emergency call detector
- Arming device
- Coded arming device
- Closure and release monitoring
- Intrusion surveillance

A second pair of wires for additional power supply is necessary for the NVK 100 LSN.

Primary lines

Primary lines PL1 to PL4 can be programmed for hold-up, intrusion, tampering, closure monitoring or other types of detection (can also be used as control input).

Primary line PL5 is used to connect the arming device to the armed/unarmed/fault statuses or to connect block locks.

Primary lines PL5 and PL6 connect logical arming devices or lockout timers for rejected/set/fault modes or lockout time set/lockout time expired/fault modes.

Control outputs

Activation of block-type lock magnet:

Arming in conjunction with the PL5 detector zone for block-type locks is only carried out if the magnet is engaged while the block-type lock area is in armed mode.

Activation of block-type lock lamp "BLL" (LED1):

The BLL block-type lock lamp lights up when the detector or block-type lock area is in arming readiness mode.

Activation of block-type lock lamp "BLA" (LED2):

The BLA block-type lock lamp lights up when the detection area is disarmed.

The open collector output (C point) is freely configurable.

Connecting closure detectors

For the local security network, closure detectors (block-type lock, code keypad) and other block-type-lock-connected equipment are connected via the NVK 100 LSN coupler.

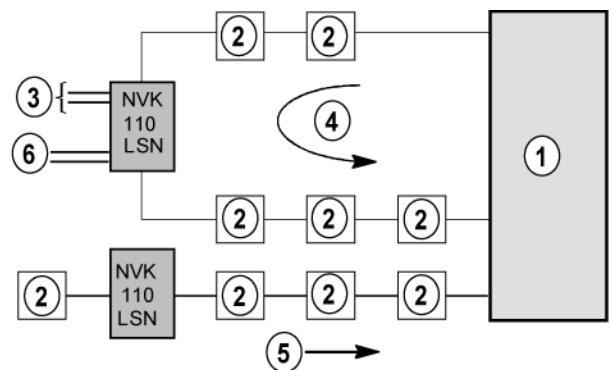

- 1 Control panel
- 2 LSN element
- 3 Primary lines 1 to 4
- 4 Loop
- 5 Stub
- 6 Coded arming device, block-type lock

Installation

When installing the KR 100 LSN, the factory-installed solder distributors must be removed. A maximum of four KR 100 LSNs can be installed per NVK 100 LSN. One solder distributor is supplied per two KR 100 LSNs.

Coupler power supply

The LSN part of all LSN elements (couplers and detectors) is supplied with power via the control panel's 2-wire LSN line.

All LSN couplers are designed to loop through the power supply (+V, -V) of subsequent couplers.

The maximum cable length of the separate power supply (+V, -V) depends on the power intake of the couplers to be supplied and their peripherals, if not powered by an external source.

Cable lengths

Cable length per primary line (PL) or control lines

- Maximum length unshielded cable – 10 m
- Maximum length shielded cable – 500 m

The primary cables, control cables and contact cables from the NVK 100 may not exceed a total of 500 m per network processing implementer (NVU).

Optional KR 100 LSN relay module for LSN expanders

The KR 100 LSN relay module for LSN expanders is intended for use in the NNK 110 LSN and NVK 100 LSN.

The KR 100 LSN is installed if the high power requirement means the connected control elements cannot be controlled directly from the LSN couplers, or in order to enable zero-potential switching.

Up to four KR 100 LSNs can be installed per NNK 110 LSN or NVK 100 LSN. One solder distributor is supplied per two KR 100 LSNs.

Parts Included

Type	Qty.	Component
NVK 100 LSN	1	Coupler

Technical Specifications

Operating voltage		
• LSN part		+10 V to +33 V
• Other expansion module functions		+8 V to +30 V
Current consumption		
LSN part		3.5 mA
Other expansion module functions		
• Idle:		Max. 50 mA at +8 V Max. 40 mA at +12 V Max. 30 mA at +30 V
• Full load:		Max. 315 mA at +8 V Max. 230 mA at +12 V Max. 105 mA at +30 V

Connection options		DC primary lines
• Primary lines 1 to 4		as hold-up, intrusion, tamper, or closure zone
• Primary line 5		Block-type lock/or coded arming device
• Primary line 6		as hold-up, intrusion, tamper, or closure zone or for coded arming device
End-of-line resistors		
• Primary lines 1 to 4		R = 12.1 kilohm 1%
• Primary line 5		R = 12.1 kilohm 1% (armed) R = 12.1 kilohm // 3.92 kilohm (disarmed)
• Primary line 6 (Hold-up, intrusion, tamper, not with NZ 300)		R = 12.1 kilohm +1%
• Primary line 6 (Log. switching equipment)		R = 12.1 kilohm +1% Invalid coded arming device 12K1 II 3K92 +1% Valid coded arming device
Monitoring tolerance at PL 1 to 4 (PL 6 if necessary)		40% of end-of-line resistor (EOL)
Response time PL 1 to 6		< 200 ms
Control outputs		
• Max. current		20 mA
• Max. voltage		8 V
• Max. line resistance		2 x 10 Ohm
• Short-circuit stability		2 s
Block-type lock magnet		
• Max. current		60 mA
• Max. voltage		12 V
• Max. line resistance		2 x 5 Ohm
• Short-circuit stability		2 s
Ambient climate		DIN 40040 R14
Permitted ambient temperature		0 °C to +55 °C
Housing		
• Base		Plastic
• Cover		Plastic
• Color		RAL 9002 grayish white
Weight		Approx. 450 g
Dimensions (H x W x D)		215 x 160 x 35.5 mm
Protection type		IP 30
Environmental class		II (VdS 2110)
KR 100 optional		
Reel		
• Response voltage		> 7 V
• Fall-off voltage		< 1 V
• Reel voltage		Max. 14.3 V
Contacts		

Principle	2 change-over contacts Potential-free
• Starting current	Max. 5 A
• Permanent current	Max. 2 A
• Switch-off current	Max. 1 A
• Switching voltage	Max. 60 V
• Switching performance	Max. 30 W
Current consumption per relay	
• At 12 V	20 mA
• At 28 V	10 mA
Ambient temperature	0 °C to +55 °C
Protection type	IP 40

6

Ordering Information**NVK 100 LSN Coupler****4998117565**

For connecting conventional arming equipment and detectors to the Local Security Network LSN

IC 400 LSN Universal Expander



Features

- ▶ **Connecting conventional motion detectors**
- ▶ **2 primary lines (alarm and tamper)**
- ▶ **2 control outputs (programmable walk test and alarm memory)**
- ▶ **Detector power supply**
- ▶ **Tamper contact (sabotage alert)**
- ▶ **Surface mounting**

The IC 400 LSN universal expander connects conventional motion detectors to the local security network (LSN)

Functions

The following detector connections to the IC 400 LSN are available:

Expansion module inputs

- 1 freely programmable alarm input
- 1 tamper input
- ETO fault, input for the electronic fault detector output (ETO = Electronic Trouble Output) for some detectors, permanently occupied

Expansion module outputs

- Detector power supply
- Walk test (Out 1) and alarm memory (Out 2) (programmable via the control panel software)

LSN

In the event of wire interruptions or short-circuits, all LSN elements in the LSN loop continue to be monitored. In this case, the system automatically creates two stub lines that continue to monitor from both sides up to the location of the fault.

The module housing has a tamper contact that, if triggered, sends a unique message and is evaluated as a sabotage alert.

Certifications and Approvals

Region	Certification	
Europe	CE	IC 400 LSN
Germany	VdS	G 101162, C IC 400 LSN

Installation/Configuration Notes

Expansion module power supply

The LSN part of all LSN elements (expansion modules and detectors) is supplied with power via the control panel's 2-wire LSN line.

All LSN expansion modules are designed to loop through the power supply (+V, -V) of subsequent expansion modules.

The maximum cable length of the separate power supply (+V, -V) depends on the current consumption of the expansion modules to be supplied and their peripherals, if not powered by an external source.

The applicable voltage range must be taken into account to ensure correct operation of the LSN expansion modules.

Cable lengths

Cable length per primary line (PL) or control lines

- Maximum length unshielded cable – 10 m
- Maximum length shielded cable – 500 m

Alarm input

The alarm input is equipped with a window comparator. Terminating this input with an 8.4 kilohm to 14.2 kilohm (typ. 12 kilohm) resistor does not trigger an alarm. In all other cases, an alarm is triggered. $I_{max} = 0.5 \text{ mA}$

Tamper input

The tamper input is equipped with a window comparator. Terminating this input with an 8.4 kilohm to 14.2 kilohm (typ. 12 kilohm) resistor does not trigger the sabotage alert message. In all other cases, a sabotage alert is triggered. $I_{max} = 0.5 \text{ mA}$

ETOin

Input for the electronic trouble output (ETO) for some detectors.

Fault

Low: 0.0 to 0.8 V =, $I_{max} = 0.12 \text{ mA}$

No fault

High: 2.5 to 5.5 V =, $I_{max} = 0.12 \text{ mA}$

The unswitched input is terminated by an internal pull-up resistor.

Outputs

Control outputs

Low:	0 to 0.5 V	I _{max} = 0.1 mA	Active
High:	7 to 9 V	I _{max} = 0.1 mA	Standby

Note The MAGS-S active glass break detector, the EKOM 11 contact-less transmitter and the UP 370 T Matchtec detector are not suitable for connection to the IC 400 LSN.

Parts Included

Type	Qty.	Component
IC 400 LSN	1	Universal expander

Technical Specifications

Operating voltage

- LSN part +12 V to +33 V
- Separate power supply 10.8 V to 30 V

Current consumption

- LSN part 3.84 mA
- By separate power supply Max. 20 mA

Inputs/outputs

- Inputs 2 differential detector zones (1 x alarm, 1 x tamper)
- Terminating resistance 12 kilohm
- Anti-masking/fault 1 input active when 0 V
- Tamper contact Switched internally in series with tamper input
- Outputs Walk test and alarm memory

Power supply output for connected detectors

- I 20 mA
- V 9.6 V ± 0.36_V

Housing

- Material ABS
- Color White, RAL 9002
- ambient temperature -10 °C to +55 °C
- Dimensions (H x W x D) 85 x 85 x 28 mm

Protection category IP 40

Environmental class II

Ordering Information

IC 400 LSN Universal Expander 4998110382

For connecting conventional motion detectors to the local security network LSN

KD 55/1 LSN 2 Zone Expander Modules



Features

- ▶ **2 primary lines for connecting contact detectors, magnetic contacts or bolt contacts**
- ▶ **The analysis of a message can be programmed in the control panel**
- ▶ **Existing monitoring function of all LSN elements in the event of line interruption**
- ▶ **The circuit board is equipped with a tamper contact**

The KD 55/1 LSN 2 zone expander module integrates manual conventional sensor technology (e.g. conventional magnet contacts) into the local security network (LSN).

Functions

The connection is 2-wire. The address assignment may be freely chosen. Tamper, hold-up, closure or intrusion messages and alarms are transmitted and analyzed. The power supply supplies the address unit via the two wires.

A second wire pair can be looped through to provide a separate power supply for any subsequent address units.

Should wire interruptions or short-circuits occur, all LSN elements continue to be monitored. In this case, the system automatically creates two stub lines that continue to monitor from both sides up to the location of the fault.

The address unit has a tamper contact. If the tamper contact is triggered, it sends a signal that is transmitted and evaluated as a unique message.

Certifications and Approvals

Region	Certification
Europe	CE KD 55/1 LSN
Germany	VdS G 101038, C KD 55/1 LSN

Installation/Configuration Notes

Connecting conventional detectors

KD 55/1 LSN 2 zone expander module with 2 DC primary lines. Up to 20 conventional detectors can be connected per primary line. In this case, the reports are transmitted from the conventional detector to the LSN coupler in analog mode. This means existing equipment can be extended with ease.

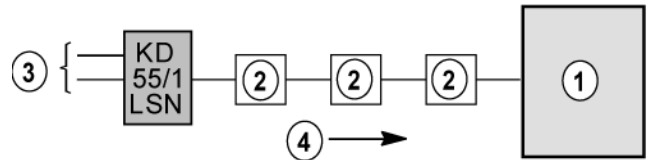

- 1 Control panel
- 2 LSN element
- 3 1-2 DC primary line
- 4 Stub

Cable lengths

Cable length per primary line (PL)

- Maximum length unshielded cable - 10 m
- Maximum length shielded cable - 500 m

The primary lines, control lines, and contact lines for all expansion modules may not exceed 500 m per network processing implementer (NVU) in total. The total length of 500 m refers to the sum of shielded and unshielded cable.

The specified length relates to interference-free LSN data transmission. In practice, interference factors that can lead to alarm or tampering in the primary line need to be taken into account. Depending on the environmental influences, experience values must be applied when determining length.

Installation

The circuit board can be installed in a 55 flush-mounted junction box and 55 surface-mounted junction box (flush-mounted junction box in accordance with DIN 49073).

Parts Included

Type	Qty.	Component
KD 55/1 LSN sur-face-mounted	1	KD 55/1 LSN 2 zone expander module, sur-face-mounted, Housing for surface mounting incl. mount, circuit board and cover
KD 55/1 LSN flush-mounted	1	KD 55/1 LSN 2 zone expander module, flush-mounted, incl. mount, circuit board and cover

Technical Specifications

Operating voltage	+10 V to +33 V
-------------------	----------------

Current consumption (line supplied)	Approx. 0.6 mA
----------------------------------------	----------------

Ambient temperature	0 °C to +50 °C
---------------------	----------------

Housing

- | | |
|-----------------------------------------|------------|
| • Material | ABS |
| • Color | RAL 9002 |
| • Weight | 60 g |
| • Dimensions, surface-mounting (Ø x D) | 76 x 38 mm |
| • Dimensions, recessed mounting (Ø x D) | 76 x 25 mm |

Primary lines	2
---------------	---

Protection type	IP 40
-----------------	-------

Environmental class	II (VdS 2110)
---------------------	---------------

Ordering Information

KD 55/1 LSN 2 Zone Expander Module, Surface-Mounted **4998117579**

For monitored connection of conventional detectors (2 primary lines) on the local security network LSN, surface-mounted

KD 55/1 LSN 2 Zone Expander Module, Flush-Mounted **4998117576**

For monitored connection of conventional detectors (2 primary lines) on the local security network LSN, flush-mounted

BAT 100 LSN Display Panel



Features

- ▶ Upgradeable with up to three ATG 100 LSN kits
- ▶ 32, 64 or 96 red or yellow display LEDs
- ▶ Monitored data communication control panel - display panel
- ▶ Maintenance of function on the LSN loop via two integrated isolators in the event of wire interruptions or short-circuits

The BAT 100 LSN display panel is a universally usable remote parallel display with up to 96 LEDs (e.g. for a maximum of 96 detector zones).

System Overview

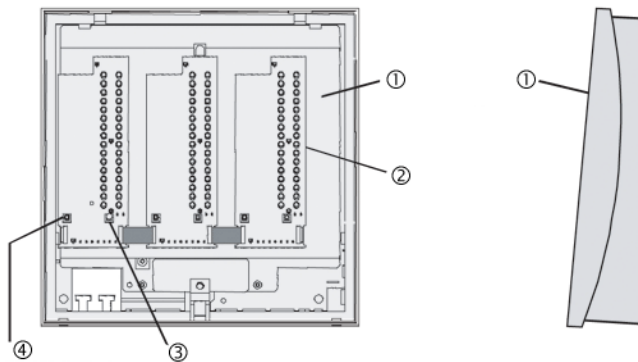

Item	Description
	BAT 100 LSN, display without hood
1	Lower part of housing
2	ATG with 32 LEDs
3	Keys for "LED test" or "buzzer off"
4	Tamper contact

Functions

The BAT 100 LSN display panel handles the display of faults and/or alarms for detectors or detector zones.

Up to three ATG 100 LSN kits can be installed in the BAT 100 LSN housing. An ATG 100 LSN includes 32 red LEDs for alarm indications or 32 yellow LEDs for fault indications. Mixed equipment (red and yellow LEDs) of the display panel with different ATG 100 LSNs is possible. LED displays can be labeled using a printer.

The panel has a buzzer and a reset button for the buzzer. If there is no alarm, the reset button for the LED test can be used.

The ATG 100 LSN kits have integrated isolators for maintaining the function of the elements on the LSN loop in the event of wire interruptions or short-circuits.

Certifications and Approvals

Region	Certification
Europe	CE BAT 100 LSN
	BS ATE / ATG / ATB 100 LSN
	CPD 0786-CPD-20596 ATG100_ATB 100
Germany	VdS G 298030 BAT 100 LSN
	G 297040 ATG 100
Hungary	TMT TMT-89/12/2004.pdf BAT 100
Russia	GOST POCC DE.C313B06298

Installation/Configuration Notes

- BAT 100 LSN Display Panels can be incorporated at any point on LSN loops or LSN stubs.
- If a BAT 100 LSN is installed in addition to a BE 500 Remote Operating Panel, the BAT 100 LSN should be positioned directly adjacent to the BE 500.

Planning example

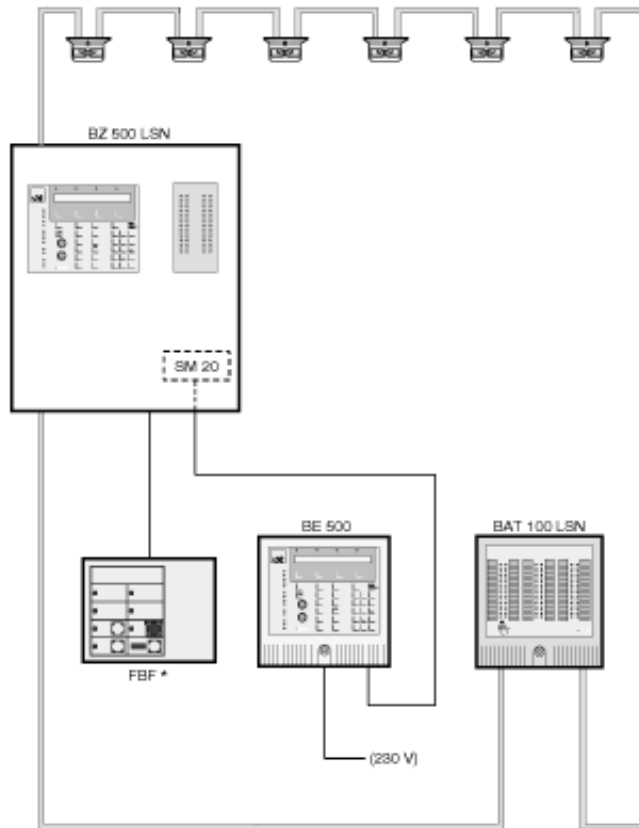

* Fire department control panel (in Germany only)

Environmental conditions

Permissible operating temperature	-5 °C to +50 °C
Permissible storage temperature	-20 °C to +60 °C

Special features

LED flash frequency	0.8 Hz
LED colors	Red, yellow

Ordering Information

BAT 100 LSN Display Panel	BAT 100
Kit for display panel with 32 red LEDs	

Accessories

ATG 100 LSN red LED Kit, Red	ATG 100 LSN red
Kit for display panel with 32 red LEDs	
ATG 100 LSN ye LED Kit, Yellow	ATG 100 LSN ye
Kit for display panel with 32 yellow LEDs	
ATG100-16red-16ye LED Kit, Red/Yellow	ATG100-16red-16ye
Kit for display panel with 16 red and 16 yellow LEDs	
Labeling Strips	BAT100-LABELS
PU = 10 units	
ATB 100LSN for Incorporation into Location Map Panels	ATB 100 LSN

Parts Included

Qty.	Component
1	BAT 100 LSN display panel

Technical Specifications

Electrics

ATG 100 LSN module

Operating voltage	
• LSN part	+12 VDC to +30 VDC
• Other functions	+8 VDC to +30 VDC
Current consumption of LSN part	3 mA
Power intake of other functions	All 32 LEDs on: max. 160 mA All 32 LEDs off: max. 6 mA

Mechanics

BAT 100 LSN housing

Dimensions (H x W x D)	270 x 270 x 75 mm
Material	Plastic, ABS Terluran
Color	Light gray, RAL 9002
Weight	Approx. 1 kg

NEV 300 LSN power supply

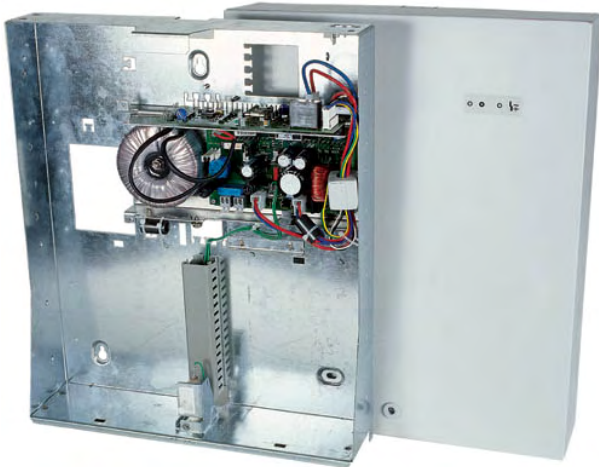

Features

- ▶ Can be connected to all LSN control panels (centralized or decentralized)
- ▶ A maximum of two 12 V/17 Ah batteries can be used
- ▶ Monitoring of mains and battery voltage
- ▶ Tamper protection (tamper contact)
- ▶ 3 freely programmable open collector outputs
- ▶ Slot for optional voltage converter (to 28 V)

The NEV 300 LSN is an additional power supply for LSN control panels.

System Overview

This additional power supply for LSN control panels is connected to the LSN local security network in an LSN loop or in max. 2 LSN stubs.

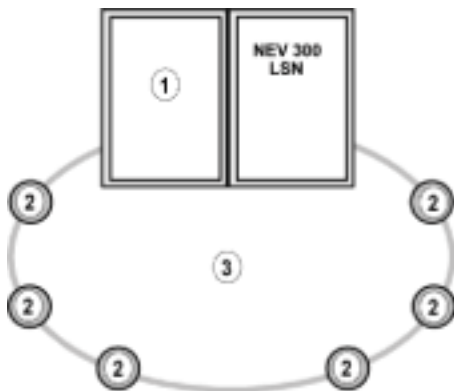

- 1 LSN control panel
- 2 LSN element
- 3 Connection in an LSN loop or in up to 2 LSN stubs

Functions

Control assembly:

- 230 V mains supply
- Power failure protection, transformer connection, rectifier
- Battery charge control and monitoring
- Battery check
- Voltage surge protection
- Fault recognition and display

Connector board

- LSN lines with power supply connection
- Battery connection
- External user connection
- Slot for 28 V voltage converter
- Fuses for voltage outputs
- 3 open collector outputs (C points), 2 relay modules can be plugged in if needed

The power supply is a separate LSN element and is programmed from the control panel with the corresponding program. Message types such as tampering with tamper contacts and power supply or battery faults are transmitted to the control panel via LSN.

The battery charge voltage is set at the factory. The controller and the internal temperature sensor ensure temperature-adjusted battery charging. A remote PTK tracker can be used if needed. Should readjustment be necessary, this is carried out via a potentiometer on the control assembly.

The battery monitor identifies when voltage falls below discharge level, interruption and short-circuit of the battery cable. The test cycle can be set to 1 min. or 15 mins. The battery load test lasts for 2 seconds and is switched off if the regulator is inoperative (power failure).

Device display

The display visible from the outside contains the operating indicator (green LED) that is lit when the battery and/or 230 V is connected, and the power supply failure indicator (yellow LED) that is lit when a battery and/or mains fault occurs.

Certifications and Approvals

Region	Certification	
Europe	CE	NEV 300 LSN
Germany	VdS	G 103030, C NEV 300 LSN

Installation/Configuration Notes

- The energy balance is determined according to VDE 0833 and created using the "uezpro" planning and current calculation program. The limits are calculated automatically. Any external peripheral devices connected must be included in the calculation.
- Current consumption at 12 V; 1.2 A per connection point

- The LSN a/b line current, max. 100 mA, is supplied by the control panel.
- The NEV 300 LSN can be operated directly next to the control panel (centralized) or remotely (decentralized).
- Installation cable for LSN technology: J-Y(St)Y
- Shielding (drain wire) must be routed to the ground connectors for each LSN line. There must be no connection between the housing potential and the LSN cable shielding.

28 V voltage converter (optional)

The basic voltage of the power supply is 12 V. If the voltage drop is too high due to cable length, a 28 V voltage converter (optional) can be plugged into the connector board. 28 V for 2 x +V/0 V and 1 x user output as needed. Power intake for the three outputs totals 500 mA.

TRN panel relay module (optional)

Panel module with 2 relays for zero potential outputs, one switching contact per relay. Up to 2 units can be plugged into the connector board.

Parts Included

Type	Qty.	Component
NEV 300 LSN	1	Housing, control assembly, connector board, and cable set without batteries, panic button incl. adhesive seal

Technical Specifications

Power supply

- Protection class I (DIN VDE 0106 Part 1)
- Mains voltage 230 V (+10% to -15%)
- Mains frequency 50 Hz

LSN technology

- Operating voltage +15 V to +31 V
- Current consumption Max. 3.85 mA

Control unit

- Battery charge voltage From 0 °C to 50 °C according to the battery charge discharge characteristics (factory setting: 13.8 V at 20 °C)
- Battery charge Bk/20 at 34 Ah = 1.7 A
- Battery capacity 12 V/2 x 17 Ah
- Output voltage Corresponds to battery charge voltage
- Output current (battery charge current + user current) Max. 4.0 A

Current available on connector board

- +V/0 V and external users Max. 2.3 A
- With bridging time of 60 hrs < 600 mA
- With bridging time of 30 hrs < 1.2 A
- Current available at 28 V from connector board (+V/0 V and ext. users) 500 mA in total

Voltage control protection

- Protection for control > 16 V
- Voltage surge protection > 5.5 A

Monitoring

- Network fault < 130 V
- Battery fault (discharge battery) ≤ 10.5 V
- Total battery discharge protector (TES) < 10 V

Switch outputs (C points)

- Principle Open collector (short-circuit resistant)
- Max. voltage 10 V to 30 V
- Maximum current 300 mA

28 V voltage converter (optional)

Load current Max. 500 mA in total

Electromagnetic compatibility (EMC)

- Interference immunity DIN EN 50130-4
- Interference emissions DIN EN 50081-1

Environmental conditions

- Ambient temperature (in operation) -5 °C to +45 °C
- Storage and transport temperature -25 °C to +70 °C
- Environmental class II (VdS 2110)

Housing protection category IP 30

Humidity +40 °C, 93% rel. humidity

Housing

- Dimensions (H x W x D) 460 x 380 x 97 mm
- Color Light gray/RAL 7035

Weight (without batteries/with batteries) 2 kg/15 kg

Ordering Information

NEV 300 LSN power supply **4998111983**

For additional power supply to LSN control panels, housing incl. 12 V/4.0 A power supply unit, a maximum of two 12 V/17 Ah batteries can be used

Accessories

TRN panel relay module **ICP-TRN**

With 2 relays, one switching contact per relay for zero potential outputs

ERWE 10 voltage converter **ERWE 10**

For connecting NBK 100 LSN, NTK 100 LSN, NSB 100 LSN, MSS 401, ERT 100, FK 100 LSN, can be plugged into the NEV 300 LSN connector board

Conettix - Information Transport Solutions

7

Conettix - Receiver/Gateway	386
Conettix - Receiver/Gateway Accessories	399
Conettix GSM	407
Conettix IP	409
Conettix - AT2000/ATE	417

Conettix D6600 Communications Receiver/Gateway



Features

- ▶ **32 lines for public switched telephone network (PSTN) communications**
- ▶ **Up to 3200 accounts for local-area network (LAN) or wide-area network (WAN) communications**
- ▶ **Telephone line terminator cards for isolation and transient suppression**
- ▶ **Front panel access to CPU card and hot-swappable line cards**
- ▶ **Supports one Conettix D6690 SAFECOM Line Card for long-range radio system capability**
- ▶ **Two-way audio**
- ▶ **Caller ID, ANI, and DNIS**
- ▶ **NIST AES Certification for Network Communications**
- ▶ **Supports 128-bit AES Rijndael encryption**

The Conettix D6600 Communications Receiver/Gateway with Conettix IP hardware components works in the following configurations:

- Telephone line communications over the public switched telephone network (PSTN).
 - Internet or intranet communications over a LAN or WAN using standard user datagram protocol and internet protocol (UDP/IP).
 - Simultaneous PSTN and LAN or WAN communications.
- The network environment reduces signal-reporting time and provides instant notification when a site experiences communication problems. A D6600 with Conettix IP hardware is compatible with most manufacturer's fire and security system control panels. With Bosch Security Systems' control panels, high speed remote programming over the network is also possible.

System Overview

PSTN Communications Configuration

This configuration uses existing telephone lines. A control panel's signal transmits over a PSTN analog telephone line to the D6600. The D6600 translates the signal to a common data format and sends the signal through Ethernet LAN, WAN, or RS-232 to a central station automation system.

Internet or Intranet Communications Configuration

This configuration requires Conettix IP hardware components, uses existing Internet or intranet structures, and avoids additional telephone service costs.

This configuration permits the Conettix D6200 Programming/Administration Software to connect to the D6600 remotely. A control panel's signal transmits over the LAN or WAN to the D6600. The D6600 translates the signal to a common data format and sends the signal through Ethernet LAN, WAN, or RS-232 to a central station automation system. The central automation system sends information to operator workstations.

Conettix D6200 Programming/Administration Software

Conettix D6200 Programming/Administration Software is a PC-based application that allows users to view, change, upload, and download D6600 programming parameters through a network connection or RS-232 serial port. Through the Conettix D6200 Programming/Administration Software users can edit CPU and line card parameters; view the status of all accounts in the databases; add, edit, and delete accounts; and configure network operations.

Note

Conettix D6200 Programming/Administration Software works with the following operating systems and associated service packs:
Microsoft® Windows® 98, Windows 98 Second Edition, Windows Me, Windows NT®, Windows 2000, and Windows XP.

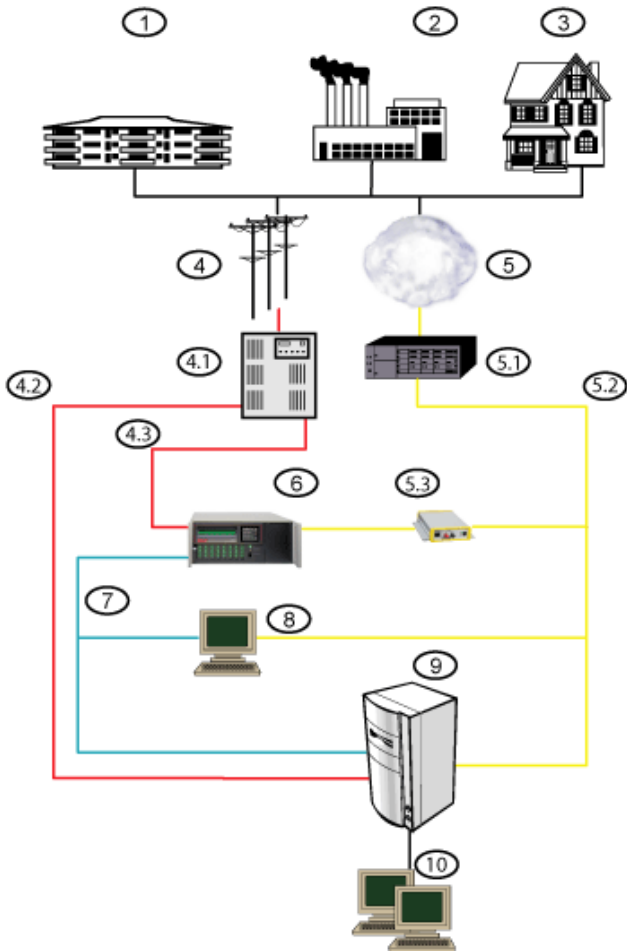

1. Access Control
2. Commercial Monitoring
3. Residential Monitoring
4. PSTN
 - 4.1 Private Branch Exchange (PBX)
 - 4.2 Two-way Audio
 - 4.3 Analog Telephone Lines
5. LAN/WAN
 - 5.1 Firewall, Router, and Hub
 - 5.2 LAN
 - 5.3 Conettix D6680 Ethernet Network Adapter
6. Conettix D6600 Communications Receiver/Gateway
7. RS-232
8. Conettix D6200 Programming/Administration Software
9. Automation System
10. Central Station Operators

Functions

Communication Formats

- | | |
|---------------------|-----------------------|
| • Acron Superfast | • ROBOFON |
| • Ademco Slow | • Scantronics Scancom |
| • Ademco Express | • SERIEE FSK/DTMF |
| • Ademco High Speed | • Sescoa Super Speed |
| • Ademco Contact ID | • SIA 8/20/300 |

- | | |
|-----------------------------------------|--------------------------|
| • CFSK BELL/V.21 | • SIA ADT |
| • FBI Superfast | • SIA V.21 |
| • Franklin/Sescoa | • Silent Knight Fast |
| • ITI | • Silent Knight FSK |
| • Radionics BFSK | • Standard Pulse Formats |
| • Radionics Hex | • Sur-Gard DTMF |
| • Radionics Modem II | • Telim |
| • Radionics Modem IIe/IIIa ² | • Veritech FSK |
| • RB2000 | • VONK |

PSTN Communications

Function	Benefit
Dialed number identification service (DNIS) adjusts line card settings according to the telephone number dialed by the control panel.	Handles more field dialers with fewer line cards and allows you to create virtual lines.
Caller identification (Caller ID) alarm processing stores corresponding handshake formats. The processing automatically recalls the format when the same caller identification is processed.	Shortens the amount of time that calls are connected to the receiver. Decreases money spent on fixed hardware or monthly phone bills.
Uses the Conettix D6641 Telephone Line Card.	Digital signal processing technology in the cards allows the D6600 to recognize more communication formats and accurately decode information.

Additional PSTN Communications Advantages

- Automatic number identification (ANI) system identifies incoming telephone numbers.
- Each line card has four telephone lines.
- Receives signals on up to 32 telephone lines simultaneously.
- Independent, configurable communication format settings for each telephone line.
- Visual front panel light emitting diode (LED) indicators for on-line and line-fault status conditions.

Supports SAFECOM

The Conettix D6690 SAFECOM Line Card adds long-range radio system capability to the D6600. This card replaces the original PC receiver (SC9001) by condensing the required functions onto a line card within the D6600.

Two-way Audio

- Able to transfer calls to another line or extension.
- Activated by account numbers and by events.

LAN or WAN Gateway Communications

- Requires Conettix IP hardware components.
- Two-way communications with a control panel.
- Supervised network automation computer links.
- Supports up to 3200 network accounts.
- Ethernet configuration available.
- Supports 128-bit AES Rijndael encryption.

Supervision and Programming with Network Communications

The protected premises sends supervision messages to the D6600 at a programmed rate. Users can program the supervision rate to be 5 seconds to 1275 seconds. The D6600 acknowledges the supervision message, providing end-to-end security. If authentication and encryption algorithms detect potentially damaging activity, they alert the central station operator.

The data network's communication link is continuously supervised. Even when monitoring thousands of control panels, the system consumes only a small amount of bandwidth.

Front Panel Access

The D6600 enclosure design provides convenient access to the CPU card or the hot-swappable telephone line cards. A hot-swappable card can be removed and replaced without affecting system performance.

Flash Technology

Using the Conettix D6200 Programming/Administration Software, flash technology in the D6600 allows for software upgrades without additional hardware or firmware changes.

Certifications and Approvals

Region	Certification	
Europe	CE	1999/5/EC, EN55022: 1998, EN50130-4: 1996, EN60950: 2000, EN61000-3-2, EN61000-3-3, EN61000-4-2: 1995, EN61000-4-3: 1995, EN61000-4-4: 1995, EN61000-4-5: 1995, EN61000-4-6: 1995, EN61000-4-11: 1994, TBR21: 1998
USA	UL	AMCX: Central Station Alarm Units (UL1610, UL1635), AMCX7: Central Station Alarm Units Certified for Canada (cULus), APAW: Police Station Alarm Units (UL365, UL464), APAW7: Police Station Alarm Units Certified for Canada (cULus), APOU: Proprietary Alarm Units (UL1076), APOU7: Proprietary Alarm Units Certified for Canada (cULus), UOJZ: Control Units, System (UL864, 9th edition)
	FM	
	CSFM	7165-1615: 143, 7300-1615: 168, and 7300-1615: 179 July 2008
	FCC	ESVUSA-25328-AL-N
Canada	ULC	DAYRC: Central Station Fire Alarm System Units
	IC	1249A-8925A
Hong Kong	HKFSD	
Brazil	ANATEL	0841-03-2045

Australia	Austel	Approved
USA	ANSI	National Institute of Standards and Technology's Advanced Encryption Standard Certification (Certificate Number 82)
	NIST	National Institute of Standards and Technology AES Certification

Installation/Configuration Notes

The D6600 and Monitoring Centers

The D6600 has extended edges so that installers can mount it easily into a rack cabinet. Mount up to eight D6600 units into a standard 48.3 cm (19 in.) rack cabinet to conserve floor space. Each D6600 connects 32 telephone lines. Eight D6600 units can connect a total of 256 telephone lines, process 600,000 digital accounts, and process 28,800 supervised Internet or intranet accounts.

Note Rack cabinets are sold separately by a variety of manufacturers.

Incorporating Conettix IP Function into the D6600

With the correct Conettix IP hardware components, the D6600 can supervise the network communications link. The Conettix IP hardware components include:

- Conettix D6201 Series IP Security Keys
- Conettix D6672 COM 1 Expansion Kit
- Conettix D6680 Ethernet Network Adapter

Network Communications and Control Panels

For network communications, it is necessary to use one of following modules with the appropriate control panel: Conettix C900V2 Dialer Capture Ethernet Module or Conettix DX4020 Ethernet Network Interface Module. Review the control panel specifications for the recommended network interface or dialer capture modules.

Parts Included

Quantity	Component
1	Conettix D6600 Communications Receiver/Gateway
1	Conettix D6610 CPU Card
1	Conettix D6615 CPU Terminator Card
1	Conettix D6641 Telephone Line Card (Expanded Memory)
1	Conettix D6645 Telephone Line Terminator Card
1	Conettix D6200CD CD-ROM Includes the Conettix D6200 Programming/Administration Software
1	P6601 Battery Cable
1	P6602 Input and Output Cable

Technical Specifications

Electrical

Power Requirements

AC Nominal Operating Range:	120 V or 230 V
AC Maximum Operating Range:	100 VAC to 120 VAC, 220 VAC to 230 VAC, 50 Hz or 60 Hz, 2.5 A maximum
Standby Power:	Uninterruptible power supply (UPS) containing a sealed lead-acid battery, 12 V, 7 Ah to 18 Ah

Current Requirements

One Line Card Installed:	Battery: 800 mA UPS AC Standby: 350 mA
For Each Additional Line Card or Terminal Card Pair:	Battery: 210 mA UPS AC Standby: 35 mA
One Network Communications Card Installed:	Battery: 10 mA UPS AC Standby: 10 mA

Mechanical

Automation Outputs

Automation Outputs:	SIA mode 6500 mode
---------------------	-----------------------

Enclosure

Rack Mount Dimensions (4U):	18 cm x 48.3 cm x 49.5 cm (7.0 in. x 19.0 in. x 19.5 in.)
Standalone Dimensions:	18 cm x 45 cm x 49.5 cm (7.0 in. x 17.75 in. x 19.5 in.)
Weight:	8.7 kg (19 lb)

Telephone

Telephone:	RJ11C modular jacks, with 26 AWG or larger wire diameter
------------	----------------------------------------------------------

Ringer Equivalence Number (REN)

REN:	0.4 B
Industry Canada (IC) REN:	0.2

Display

Screen Dimensions:	1.8 cm x 15.2 cm (0.7 in. x 6.0 in.) dot matrix LCD, 5 x 7 dots per character. Shows two separate lines, 40 characters per line.
Indicators:	LED display section indicates receiver status and power.

Inputs and Outputs

For Automation Computer Connection:	One RS-232 interface port COM3
For External Serial Printer, PC, Modem, or Network Connection:	One RS-232 interface port COM4
For Parallel Printer Connection:	One parallel printer port
Number of Programmable Inputs:	Two (wire harness included)
Number of Programmable Outputs:	Two (wire harness included)

Optional Input

For Optional Network Communications Expansion:	One RS-232 interface port COM1
------------------------------------------------	--------------------------------

Environmental

Temperature (Operating):	0°C to 50°C (+32°F to +122°F)
--------------------------	----------------------------------

Trademarks

Microsoft®, Windows®, and Windows NT® are registered trademarks of Microsoft Corporation in the United States and/or other countries.

Ordering Information

Conettix D6600 Communications Receiver/Gateway	D6600
Supports communications through PSTN, LAN/WAN, or both. Supports 32 telephone lines and 3200 network accounts. Supports two-way audio, Caller ID, ANI, and DNIS.	

Accessories

3200 Account Conettix IP Security Key (LPT)	D6201
Designed for parallel ports. Allows each Conettix Communications Receiver/Gateway to support a maximum of 3200 IP accounts.	

3200 Account Conettix IP Security Key (USB)	D6201-USB
Designed for USB ports. Allows each Conettix Communications Receiver/Gateway to support a maximum of 3200 IP accounts.	

500 Account Conettix IP Security Key (USB)	D6201-500-USB
Designed for USB ports. Allows each Conettix Communications Receiver/Gateway to support 500 IP accounts.	

Conettix D6610 CPU Line Card	D6610
Provides programmable FLASH memory for firmware upgrades. Includes a 20,000-event history buffer and a computer micro-processor.	

Conettix D6615 CPU Terminator Card	D6615
Provides a shielded interface between the Conettix D6610 CPU Line Card and external connections to automation database computers and printers.	

Conettix D6641 Telephone Line Card	D6641
Provides DSP technology. Answers and decodes signals from up to four telephone lines.	

Conettix D6645 Telephone Line Terminator Card	D6645
Provides isolation and transient suppression to the Conettix D6641 Telephone Line Card.	

Conettix D6672 Com 1 Expansion Kit	D6672
Creates a third serial port on the Conettix D6600 Communications Receiver/Gateway. Provides a DB9 male connector and transient protection.	

Conettix D6680 Ethernet Network Adapter	D6680-E120
------------------------------------------------	-------------------

P6601 Battery Cable	P6601
Connects a 12 VDC power source to the Conettix D6600 Communications Receiver/Gateway.	

P6602 Input and Output Cable	P6602
Connects to the receiver and provides use of the input and output lines.	

P6603 Acknowledgement Button	P6603
Spare acknowledgement button.	

Ordering Information

Software Options

Conettix D6200CD CD-ROM

Provides software for programming, operating, simulating, and demonstrations. Includes PDF documentation files for hardware and software relating to the Conettix Communications Receiver/Gateway.

D6200CD

Conettix D6100 Communications Receiver/Gateway



Features

- ▶ Two lines for public switched telephone network (PSTN) communications
- ▶ Two-way audio
- ▶ Connects to an automation system, programming software, and a printer
- ▶ Two programmable inputs and outputs
- ▶ Menu-driven keypad programming
- ▶ Large 2 x 40 character liquid crystal display (LCD)

The Conettix D6100 Communications Receiver/Gateway provides alarm communications over two PSTN lines. The D6100 has a compact, economical design that is well-suited for applications such as small central stations, gated communities, security offices, or university campuses. The D6100 uses the same firmware and supports the same major communication formats as the Conettix D6600 Communications Receiver/Gateway.

System Overview

PSTN Communications Configuration

This configuration uses existing telephone lines. A control panel's signal transmits over a PSTN analog telephone line to the D6100. The D6100 translates the signal to a common data format and sends the signal through RS-232 to a central station automation system.

Conettix D6200 Programming/Administration Software

Conettix D6200 Programming/Administration Software is a PC-based application that allows users to view, change, upload, and download D6100 programming parameters through an RS-232 serial port. With the Conettix D6200 Programming/Administration Software, users can edit programming parameters and view the status of the receiver.

Note Conettix D6200 Programming/Administration Software works with the following operating systems and associated service packs:
Microsoft® Windows® 98, Windows 98 Second

Edition, Windows Me, Windows NT®, Windows 2000, and Windows XP.

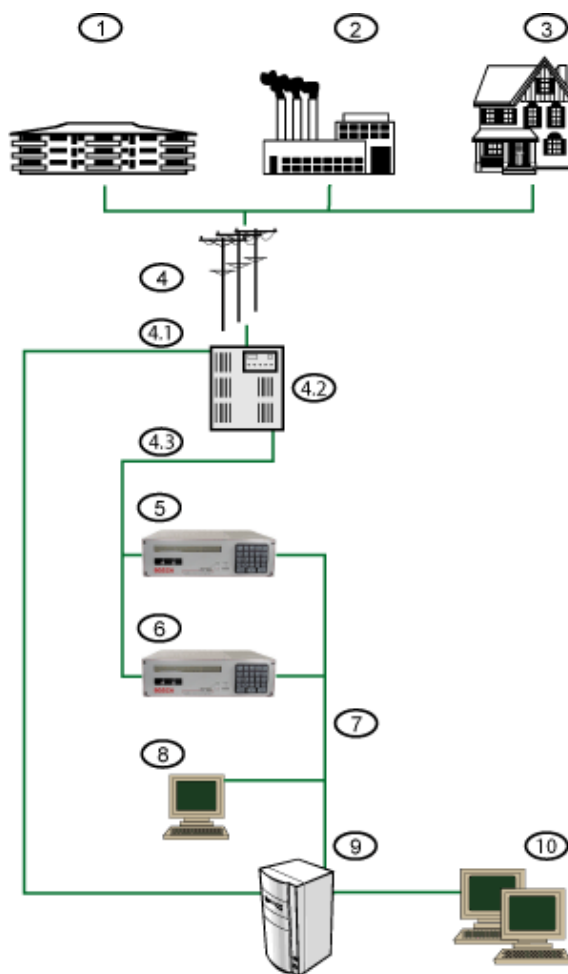

1. Access Control
2. Commercial Monitoring
3. Residential Monitoring
4. PSTN
 - 4.1 Two-way Audio
 - 4.2 Private Branch Exchange (PBX)
 - 4.3 Analog Telephone Lines
5. Conettix D6100 Communications Receiver/Gateway 1
6. Conettix D6100 Communications Receiver/Gateway N
7. RS-232
8. Conettix D6200 Programming/Administration Software
9. Automation System
10. Central Station Operators

Functions

Communication Formats

- | | |
|---------------------|-----------------------|
| • Acron Superfast | • ROBOFON |
| • Ademco Slow | • Scantronics Scancom |
| • Ademco Express | • SERIEE FSK/DTMF |
| • Ademco High Speed | • SESCOA Super Speed |
| • Ademco Contact ID | • SIA 8/20/300 |

- | | |
|-----------------------------------------|--------------------------|
| • CFSK BELL/V.21 | • SIA ADT |
| • FBI Superfast | • SIA V.21 |
| • Franklin/Sescoa | • Silent Knight Fast |
| • ITI | • Silent Knight FSK |
| • Radionics BFSK | • Standard Pulse Formats |
| • Radionics Hex | • Sur-Gard DTMF |
| • Radionics Modem II | • Telim |
| • Radionics Modem IIe/IIIa ² | • Veritech FSK |

PSTN Communications

Function	Benefit
Caller identification (Caller ID) alarm processing stores corresponding handshake formats. The processing automatically recalls the format when the same caller identification is processed.	Shortens the amount of time that calls are connected to the receiver. Decreases money spent on fixed hardware or monthly phone bills.

Additional PSTN Communication Advantages

- Receives signals on two telephone lines simultaneously.
- Independent, configurable communication format settings for each telephone line.
- Visual front panel light emitting diode (LED) indicators for on-line and line-fault status conditions.

Two-way Audio

- Able to transfer calls to another line or extension
- Activated by account numbers and by events

Flash Technology

Using the Conettix D6200 Programming/Administration Software, flash technology in the D6100 allows for software upgrades without additional hardware or firmware changes.

Certifications and Approvals

Region	Certification
Europe	CE 1999/5/EC, EN55022 (Class B): 1994 +A1: 1995 +A2: 1997, EN50130-4: 1995 +A1: 1998 +A2: 2003, EN60950-1: 2001, EN61000-3-2: 2000, EN61000-3-3: 1995 +A1: 2001, ETSI TS 103 021
USA	FCC ESVAL04BD6100
Canada	IC 1249A-D6100
Australia	Austel Approved

Installation/Configuration Notes

The D6100 and Monitoring Centers

The D6100 has extended edges so that installers can mount it easily into a standard 48.3 cm (19 in.) rack cabinet. Rack cabinets conserve floor space.

Note Rack cabinets are sold separately by a variety of manufacturers.

The D6100 connects directly to automation computers. Users can use the automation system or the D6100 keypad to acknowledge events. There is up to a 1000 event history buffer.

Parts Included

Quantity	Component
1	Conettix D6100 Communications Receiver/Gateway
1	P6602 Input and Output Cable
1	Conettix D6200CD CD-ROM
1	External Battery Connection

Technical Specifications

Automation Outputs

Automation Outputs: SIA mode
6500 mode

Enclosure

Rack Mount Dimensions (2U): 9.0 cm. x 37.5 cm x 25.5 cm
(3.5 in. x 19 in. x 10 in.)

Standalone Dimensions: 9.0 cm. x 30.5 cm. x 25.5 cm
(3.5 in. x 12 in. x 10 in.)

Weight : 3 kg (7 lb)

Environmental Considerations

Temperature (Operating): 0°C to 50°C
(+32°F to +122°F)

Power Requirements

AC Nominal Operating Range: 18 VAC ±15% with 50 VA transformer

Standby Power: Uninterruptible power supply (UPS) containing a sealed lead-acid battery, 12 V, 7 Ah to 18 Ah

Current Requirements

Battery Current: 330 mA

UPS AC Standby Current: 180 mA

Telephone

Telephone: RJ11C modular jacks, with 26 AWG or larger wire diameter

Ringer Equivalence Number (REN)

REN: 0.4 B

Industry Canada (IC) REN: 0.2

Display

Screen Dimensions: 1.8 cm x 15.2 cm (0.7 in. x 6.0 in.) dot matrix LCD, 5 x 7 dots per character. Shows two separate lines, 40 characters per line.

Indicators: LED display section indicates receiver status and power.

Inputs and Outputs

For Automation Computer Connection: One RS-232 interface port COM3

For External Serial Printer, PC, Modem, or Network Connection: One RS-232 interface port COM4

For Parallel Printer Connection: One parallel printer port

Number of Programmable Inputs: Two (wire harness included)

Number of Programmable Outputs: Two (wire harness included)

Trademarks

Microsoft®, Windows®, and Windows NT® are registered trademarks of Microsoft Corporation in the United States and/or other countries.

Countries: D6100-01 Kit

Bahamas	• One 120 VAC transformer
Bermuda	• Blade-style plug
Canada	• One Conettix D6100 Communications Receiver/Gateway
Costa Rica	
Colombia	
Dominican Republic	
Guatemala	
Haiti	
Honduras	
Mexico	
Panama	
Puerto Rico	
Taiwan	
USA	

Countries: D6100-02 Kit

Albania	• One 230 VAC transformer
Angola	• Round pin-style plug
Austria	• One Conettix D6100 Communications Receiver/Gateway
Belgium	
Brazil	
Bulgaria	
Chile	
Croatia	
Germany	
Greece	
Greenland	
Guinea	
Denmark	
Finland	
France	

Countries: D6100-02 Kit (Continued)

Hungary	• One 230 VAC transformer
Iceland	• Round pin-style plug
India	• One Conettix D6100 Communications Receiver/Gateway
Indonesia	
Iran	
Iraq	
Israel	
Italy	
Kuwait	
Luxembourg	
Malaysia	
Mongolia	
Netherlands	

Countries: D6100-02 Kit (Continued)

Norway	• One 230 VAC transformer
Pakistan	• Round pin-style plug
Poland	• One Conettix D6100 Communications Receiver/Gateway
Portugal	
Romania	
Russian Federation	
Singapore	
Spain	
South Korea	
Sweden	
Switzerland	
Thailand	

Countries: D6100-03 Kit

China	• 120 VAC transformer
Republic of the Philippines	• Blade-style plug transformer
Saudi Arabia	• One Conettix D6100 Communications Receiver/Gateway

Countries: D6100-04 Kit

Argentina	• 240 VAC transformer
Australia	• Inverted V-style plug
New Zealand	• One Conettix D6100 Communications Receiver/Gateway

Countries: D6100-05 Kit

Cyprus	• 240 VAC transformer
Falkland Islands	• Rectangle-style plug
Gambia	• One Conettix D6100 Communications Receiver/Gateway
Grenada	
Kenya	
Ireland	
United Kingdom	
Uganda	

Ordering Information
Conettix D6100 Kit (230 VAC)**D6100-02**

Includes one D6100, one transformer 230 VAC, and one round pin-style plug. For use in Albania, Angola, Chile, Greece, Greenland, Guinea, Iceland, Luxembourg, Russian Federation, South Korea, Thailand, United Arab Emirates, Yugoslavia, Austria, Austria, Belgium, Bulgaria, Croatia, Denmark, Finland, France, Germany, Hungary, India, Indonesia, Iran, Iraq, Israel, Italy, Mongolia, Netherlands, Norway, Pakistan, Poland, Portugal, Romania, Spain, Sweden, Switzerland, Kuwait, and Malaysia.

Conettix D6100 Kit (220 VAC)**D6100-03**

Includes one D6100, one transformer 220 VAC, and one blade-style plug. For use in China, Republic of the Phillipines, and Saudi Arabia.

Conettix D6100 Kit (240 VAC)**D6100-05**

Includes one D6100, one transformer 240 VAC, and one rectangle-style plug. For use in Gambia, Ireland, United Kingdom, Cyprus, Falkland Islands, Grenada, Kenya, and Uganda.

Accessories
P6602 Input and Output Cable**P6602**

Connects to the receiver and provides use of the input and output lines.

Conettix D6100 Rack Mount Kit**D6100RMK**

Standard rack mount kit measuring 48.3 cm (19 in.).

Software Options
Conettix D6200CD CD-ROM**D6200CD**

Provides software for programming, operating, simulating, and demonstrations. Includes PDF documentation files for hardware and software relating to the Conettix Communications Receiver/Gateway.

Conettix D6100i Communications Receiver/Gateway



Features

- ▶ **Up to 3200 accounts for local-area network (LAN) or wide-area network (WAN) communications**
- ▶ **Two lines for public switched telephone network (PSTN) communications**
- ▶ **Supports Caller ID**
- ▶ **NIST AES Certification for Network Communications**
- ▶ **Supports 128-bit AES Rijndael encryption**
- ▶ **Supports two-way audio**
- ▶ **Connects to an automation system, programming software, and a printer**
- ▶ **Two programmable inputs and outputs**
- ▶ **Menu-driven keypad programming**
- ▶ **Large 2 x 40 character liquid crystal display (LCD)**

The Conettix D6100i Communications Receiver/Gateway provides alarm communications over:

- Telephone line communications over the public switched telephone network (PSTN).
- Internet or intranet communications over a LAN or WAN using standard user datagram protocol and internet protocol (UDP/IP).
- Simultaneous PSTN and LAN or WAN communications.

The D6100i has a compact, economical design that is well-suited for applications such as small central stations, gated communities, security offices, or university campuses. The D6100i uses the same firmware and supports the same major communication formats as the Conettix D6600 Communications Receiver/Gateway.

System Overview

PSTN Communications Configuration

This configuration uses existing telephone lines. A control panel's signal transmits over a PSTN analog telephone line to the D6100i. The receiver translates the signal to a common data format and sends the signal through Ethernet LAN, WAN, or RS-232 to a central station automation system.

Internet or Intranet Communications Configuration

This configuration requires Conettix IP hardware components, uses existing Internet or intranet structures, and avoids additional telephone service costs. This configuration permits the Conettix D6200 Programming/Administration Software to connect to the D6100i remotely. A control panel's signal transmits over the LAN or WAN to the D6100i. The D6100i translates the signal to a common data format and sends the signal through Ethernet LAN, WAN, or RS-232 to a central station automation system. The central automation system sends information to operator work stations.

Conettix D6200 Programming/Administration Software

Conettix D6200 Programming/Administration Software is a PC-based application that allows users to view, change, upload, and download D6100i programming parameters through Ethernet LAN, WAN, or RS-232 serial port. With the Conettix D6200 Programming/Administration Software, users can edit programming parameters and view the status of the receiver.

Note

Conettix D6200 Programming/Administration Software works with the following operating systems and associated service packs: Microsoft Windows 98, Windows 98 Second Edition, Windows Me, Windows NT, Windows 2000, and Windows XP.

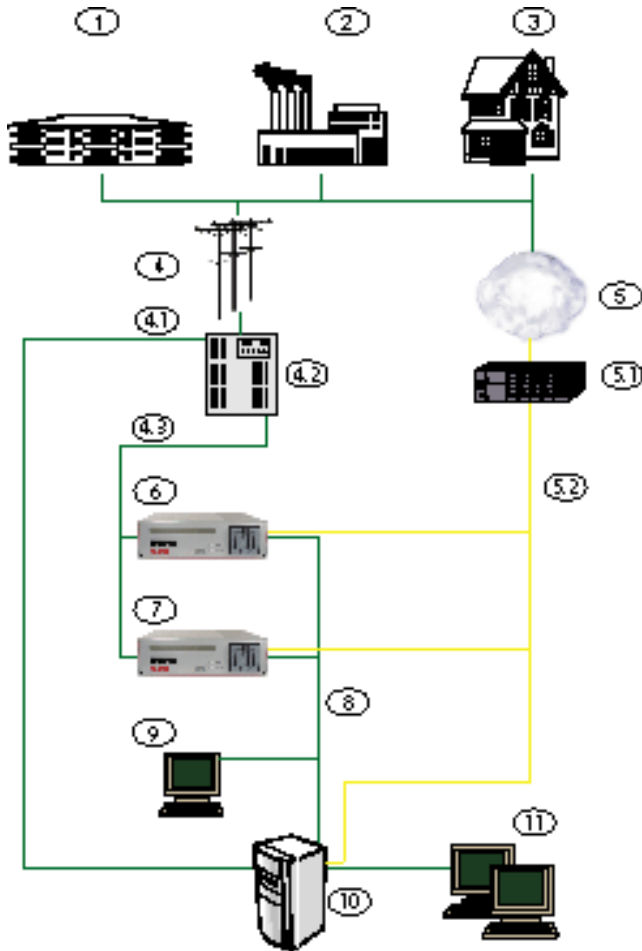

1. Access Control
2. Commercial Monitoring
3. Residential Monitoring
4. PSTN
 - 4.1 Two-way Audio
 - 4.2 Private Branch Exchange (PBX)
 - 4.3 Analog Telephone Lines
5. LAN/WAN
 - 5.1 Firewall, Router, and Hub
 - 5.2 LAN
6. Conettix D6100i Communications Receiver/Gateway 1
7. Conettix D6100i Communications Receiver/Gateway N
8. RS-232
9. Conettix D6200 Programming/Administration Software
10. Automation System
11. Central Station Operators

Functions

Communication Formats

- | | |
|---------------------|-----------------------|
| • Acron Superfast | • ROBOFON |
| • Ademco Slow | • Scantronics Scancom |
| • Ademco Express | • SERIEE FSK/DTMF |
| • Ademco High Speed | • Sescoa Super Speed |
| • Ademco Contact ID | • SIA 8/20/300 |

- | | |
|-----------------------------------------|--------------------------|
| • CFSK BELL/V.21 | • SIA ADT |
| • FBI Superfast | • SIA V.21 |
| • Franklin/Sescoa | • Silent Knight Fast |
| • ITI | • Silent Knight FSK |
| • Radionics BFSK | • Standard Pulse Formats |
| • Radionics Hex | • Sur-Gard DTMF |
| • Radionics Modem II | • Telim |
| • Radionics Modem IIe/IIIa ² | • Veritech FSK |

PSTN Communications

- Receives signals on two telephone lines simultaneously.
- Independent, configurable communication format settings for each telephone line.
- Visual front panel light emitting diode (LED) indicators for on-line and line-fault status conditions.

Two-way Audio

- Able to transfer calls to another line or extension
- Activated by account numbers and by events

Flash Technology

Using the Conettix D6200 Programming/Administration Software, flash technology in the D6100i allows for software upgrades without additional hardware or firmware changes.

LAN or WAN Gateway Communications

- Requires Conettix IP hardware components.
- Two-way communications with a control panel.
- Supervised network automation computer links.
- Supports up to 3200 network accounts.
- Ethernet configuration available.
- Supports 128-bit AES Rijndael encryption.

Supervision and Programming with Network Communications

The protected premises sends supervision messages to the D6100i at a programmed rate. Users can program the supervision rate to be 5 seconds to 1275 seconds. The D6100i acknowledges the supervision message, providing end-to-end security. If authentication and encryption algorithms detect potentially damaging activity, they alert the central station operator. The data network's communication link is continuously supervised. Even when monitoring thousands of control panels, the system consumes only a small amount of bandwidth.

Certifications and Approvals

Region	Certification
USA	UL NOA under File BP6198 - AMCX: Central Station Alarm Units (UL1610 and UL1635); AMCX7: Central Station Alarm Units Certified for Canada (cULus)

Installation/Configuration Notes

The D6100i and Monitoring Centers

The D6100i has extended edges so that installers can mount it easily into a standard 48.3 cm (19 in.) rack cabinet. Rack cabinets conserve floor space.

Note Rack cabinets are sold separately by a variety of manufacturers.

The D6100i connects directly to automation computers. Users can use the automation system or the D6100i keypad to acknowledge events. There is up to a 2000 event history buffer.

Network Communications and Control Panels

For network communications, it is necessary to use one of following modules with the appropriate control panel: Conettix C900V2 Dialer Capture Ethernet Module or Conettix DX4020 Ethernet Network Interface Module.

Review the control panel specifications for the recommended network interface or dialer capture modules.

The D6100i can supervise up to 10 network accounts without a D6201 Security Key. To use the full account capacity, a D6201 Security Key is required.

Parts Included

Quantity	Component
1	Conettix D6100i Communications Receiver/Gateway
1	P6602 Input and Output Cable
1	Conettix D6200CD CD-ROM
1	External Battery Connection
1	Country Specific AC Transformer (refer to Ordering Information for details)

Technical Specifications

Automation Outputs

Automation Outputs: SIA mode
6500 mode

Enclosure

Rack Mount Dimensions (2U): 9.0 cm. x 37.5 cm x 25.5 cm
(3.5 in. x 19 in. x 10 in.)

Standalone Dimensions: 9.0 cm. x 30.5 cm. x 25.5 cm
(3.5 in. x 12 in. x 10 in.)

Weight: 3 kg (7 lb)

Environmental Considerations

Temperature (Operating): 0°C to 50°C
(+32°F to +122°F)

Power Requirements

AC Nominal Operating Range: 18 VAC ±15% with 50VA transformer

Standby Power: Uninterruptible power supply (UPS) containing a sealed lead-acid battery, 12 V, 7 Ah to 18 Ah

Current Requirements

Battery Current: 330 mA

UPS AC Standby Current: 180 mA

Telephone

Telephone: RJ11C modular jacks, with 26 AWG or larger wire diameter

Ringer Equivalence Number (REN)

REN: 0.4 B

Industry Canada (IC) REN: 0.2

Display

Screen Dimensions: 1.8 cm x 15.2 cm (0.7 in. x 6.0 in.) dot matrix LCD, 5 x 7 dots per character. Shows two separate lines, 40 characters per line.

Indicators: LED display section indicates receiver status and power.

Inputs and Outputs

For Automation Computer Connection: One RS-232 interface port COM3 or Ethernet for IP

For External Serial Printer, PC, Modem: One RS-232 interface port COM4

For Parallel Printer Connection: One parallel printer port

Number of Programmable Inputs: Two (wire harness included)

Number of Programmable Outputs: Two (wire harness included)

Ethernet: RJ45 modular jack for Ethernet 10Base-T or 100Base-TX (Auto-Sensing)

Trademarks

Trademark names are used throughout this document. In most cases, these designations are claimed as trademarks or registered trademarks in one or more countries by their respective owners. Rather than placing a trademark symbol in every occurrence of a trademark name, Bosch Security Systems, Inc. uses the names only in an editorial fashion and to the benefit of the trademark owner with no intention of infringing on the trademark.

Ordering Information**Conettix D6100i Kit (230 VAC)****D6100i-02**

Provides alarm communications over two PSTN lines or via a network. Supports two-way audio. Includes one D6100i, one transformer 230 VAC, and one round pin-style plug. For use in Albania, Angola, Chile, Greece, Greenland, Guinea, Iceland, Luxembourg, Russian Federation, South Korea, Thailand, United Arab Emirates, Yugoslavia, Austria, Austria, Belgium, Bulgaria, Croatia, Denmark, Finland, France, Germany, Hungary, India, Indonesia, Iran, Iraq, Israel, Italy, Mongolia, Netherlands, Norway, Pakistan, Poland, Portugal, Romania, Spain, Sweden, Switzerland, Kuwait, and Malaysia.

Conettix D6100i Kit (220 VAC)**D6100i-03**

Provides alarm communications over two PSTN lines or via a network. Supports two-way audio. Includes one D6100i, one transformer 220 VAC, and one blade-style plug. For use in China, Republic of the Phillipines, and Saudi Arabia.

Conettix D6100i Kit (240 VAC)**D6100i-04**

Provides alarm communications over two PSTN lines or via a network. Supports two-way audio. Includes one D6100i, one transformer 240 VAC, and one inverted V-style plug. For use in Australia, Argentina, and New Zealand.

Conettix D6100i Kit (240 VAC)**D6100i-05**

Provides alarm communications over two PSTN lines or via a network. Supports two-way audio. Includes one D6100i, one transformer 240 VAC, and one rectangle-style plug. For use in Gambia, Ireland, United Kingdom, Cyprus, Falkland Islands, Grenada, Kenya, and Uganda.

Accessories**P6602 Input and Output Cable****P6602**

Connects to the receiver and provides use of the input and output lines.

Conettix D6100 Rack Mount Kit**D6100RMK**

Standard rack mount kit measuring 48.3 cm (19 in.).

3200 Account Conettix IP Security Key (LPT)**D6201**

Designed for parallel ports. Allows each Conettix Communications Receiver/Gateway to support a maximum of 3200 IP accounts.

3200 Account Conettix IP Security Key (USB)**D6201-USB**

Designed for USB ports. Allows each Conettix Communications Receiver/Gateway to support a maximum of 3200 IP accounts.

500 Account Conettix IP Security Key (USB)**D6201-500-USB**

Designed for USB ports. Allows each Conettix Communications Receiver/Gateway to support 500 IP accounts.

Ordering Information**Software Options****Conettix D6200CD CD-ROM****D6200CD**

Provides software for programming, operating, simulating, and demonstrations. Includes PDF documentation files for hardware and software relating to the Conettix Communications Receiver/Gateway.

D6600 CD ROM

CD ROM that contains:

- D6200 Programming Software, a programming application designed to work over a network or serial connection
- D6202 Automation Simulator Software
- D6600 Operating Software
- D6600 Receiver Manuals
- D6600 Conettix System Demonstration Software: use with up to 10 accounts

The CD includes documentation for the following products:

D6200 Programming Software, D6600 Communications Receiver/Gateway, D6672 Com 1 Expansion Kit, D6680 Network Adapter, D6641 Telephone Line Card, D6201 Series Conettix Security Keys, D6690 SafeCom System, and DX4020 Network Interface Module.

Ordering Information

D6600 CD ROM

Provides software for programming, operating, simulating, and demonstrations.

D6600CD

Conettix D6200CD CD-ROM

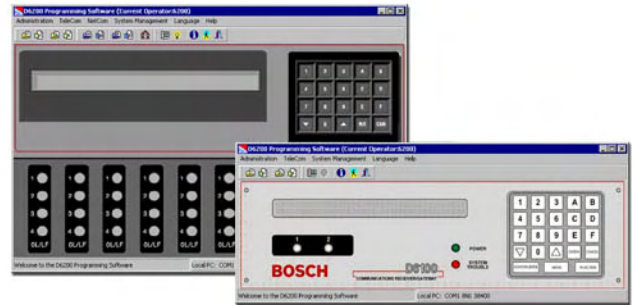

CD-ROM that contains:

- Conettix D6200 Programming/Administration Software, a programming application designed to work over a network or serial connection
- D6202 Automation Simulator Software
- Operating Software for Conettix D6100i Communications Receiver/Gateway and Conettix D6600 Communications Receiver/Gateway
- Conettix D6600 IP System Demonstration Software: use with up to 10 accounts

The CD also includes relevant documentation for hardware and software relating to the Conettix D6100i Communications Receiver/Gateway and Conettix D6600 Communications Receiver/Gateway.

Ordering Information

Conettix D6200CD CD-ROM

Provides software for programming, operating, simulating, and demonstrations. Includes PDF documentation files for hardware and software relating to the Conettix Communications Receiver/Gateway.

D6200CD

Conettix D6641 Telephone Line Card

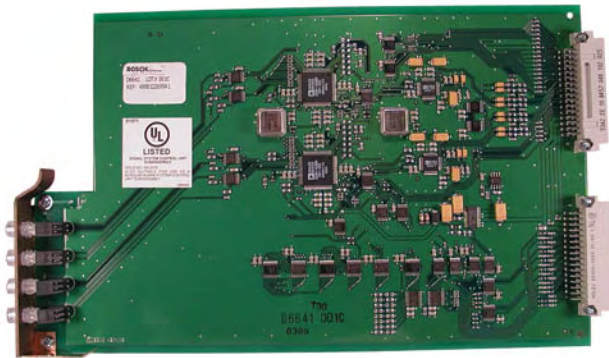

7

Line card with digital signal processor (DSP) technology. Answers and decodes signals from up to four telephone lines simultaneously. The Conettix D6600 Communications Receiver/Gateway will accept up to eight telephone line cards to create a total of 32 telephone lines. Needs one Conettix D6645 Telephone Line Terminator Card.

Certifications and Approvals

Region	Certification	
Europe	CE	1999/5/EC, EN55022: 1998, EN50130-4: 1996, EN60950: 2000, EN61000-3-2, EN61000-3-3, EN61000-4-2: 1995, EN61000-4-3: 1995, EN61000-4-4: 1995, EN61000-4-5: 1995, EN61000-4-6: 1995, EN61000-4-11: 1994, TBR21: 1998
USA	UL	AMCX: Central Station Alarm Units (UL1610, UL1635), APAW: Police Station Alarm Units (UL365, UL464)
	CSFM	7300-1615: 168 and 7300-1615: 179 July 2008

Ordering Information

Conettix D6641 Telephone Line Card **D6641**

Provides DSP technology. Answers and decodes signals from up to four telephone lines.

Conettix D6645 Telephone Line Terminator Card



Modular design plug-in circuit board. Provides isolation and transient suppression to the Conettix D6641 Telephone Line Card. Provides four modular RJ11 jacks for telephone line connections.

Certifications and Approvals

Region	Certification	
Europe	CE	1999/5/EC, EN55022: 1998, EN50130-4: 1996, EN60950: 2000, EN61000-3-2, EN61000-3-3, EN61000-4-2: 1995, EN61000-4-3: 1995, EN61000-4-4: 1995, EN61000-4-5: 1995, EN61000-4-6: 1995, EN61000-4-11: 1994, TBR21: 1998
USA	UL	AMCX: Central Station Alarm Units (UL1610, UL1635), APAW: Police Station Alarm Units (UL365, UL464)
	FM	
	CSFM	7300-1615: 168 and 7300-1615: 179 July 2008

Ordering Information

Conettix D6645 Telephone Line Terminator Card **D6645**

Provides isolation and transient suppression to the Conettix D6641 Telephone Line Card.

Conettix D6672 Com 1 Expansion Kit



Creates a third serial port on the Conettix D6600 Communications Receiver/Gateway. Provides a DB9 male connector and transient protection.

Certifications and Approvals

Region	Certification	
Europe	CE	1999/5/EC, EN55022: 1998, EN50130-4: 1996, EN60950: 2000, EN61000-3-2, EN61000-3-3, EN61000-4-2: 1995, EN61000-4-3: 1995, EN61000-4-4: 1995, EN61000-4-5: 1995, EN61000-4-6: 1995, EN61000-4-11: 1994, TBR21: 1998
USA	CSFM	7300-1615: 179 July 2008

Ordering Information

Conettix D6672 Com 1 Expansion Kit **D6672**
 Creates a third serial port on the Conettix D6600 Communications Receiver/Gateway. Provides a DB9 male connector and transient protection.

Conettix D6680 Ethernet Network Adapter



7

Features

- ▶ **Two channel adapter**
- ▶ **Network interface**
- ▶ **Serial interface**

The Conettix D6680 Ethernet Network Adapter is a two-channel network adapter. The D6680 connects the Conettix D6600 Communications Receiver/Gateway RS-232 Data Port to an Ethernet LAN/WAN. One adapter is required for each D6600 serial port with a direct connection to a data network (LAN/WAN).

Certifications and Approvals

Install the Conettix D6600 Communications Receiver/Gateway in accordance with NFPA 70, NFPA 72 and the local Authority Having Jurisdiction (AHJ). The Conettix D6680 Ethernet Network Adapter is suitable for Central Station Protective Signaling when it is installed and used in compliance with NFPA 72 and ANSI/NFPA 70. Installation limits for Digital Alarm Communicator Receivers (DACR) are under the jurisdiction of the user's local authority.

For UL Listed Fire Installations, equipment between Ethernet Interface Modules and the D6680 is required to be UL Listed Information Technology Equipment.

Region	Certification	
USA	UL	AMCX: Central Station Alarm Units (UL1610, UL1635), UOXX: Control Unit Accessories, System (UL864, 9th edition)
		FM
	CSFM	7300-1615: 179 July 2008

Installation/Configuration Notes

Compatibility Information

Receivers: Conettix D6600 Communications Receiver/Gateway

Location and Enclosures

The D6680 must be installed in the same room as the D6600 and within 15.2 m (50 ft) of the D6600. Required for UL Central Station Protective Signaling, the D6680 must be mounted in a separate enclosure such as the AE1 (gray) or the AE2 (red).

Parts Included

Quantity	Component
1	Serial cable

Technical Specifications

Electrical

Power Requirements:	9 VDC to 30 VDC, or 9 VAC to 25 VAC External adapter included.
Power Consumption:	3 W
AC Current Required:	UPS Standby Current: 35 mA
Power Input:	AC nominal operating range 120 VAC or 240 VAC AC maximum operating range 100 VAC to 240 VAC ~ 50 Hz /60 Hz 0.2 A maximum
Standby Power:	An Uninterrupted Power Supply is required for use with the D6680, when used for UL FIRE Protective Signaling Systems. A 60 hour minimum UPS standby power supply is required for UL Certification.

Mechanical

Unit Dimensions:	16.5 cm x 11.3 cm x 36 mm (6.5 in. x 4.46 in. x 1.39 in.)
Enclosure Dimensions:	31.8 cm x 36.8 cm x 76 mm (12.5 in. x 14.5 in. x 3 in.) The enclosure is manufactured from 1.0 mm (20 Gauge), cold-rolled steel. A keyed lock is included.
Weight:	0.48 kg (1.1 lb)
Protocols Supported:	ARP, UDP, TCP, Telnet, ICMP, SNMP, DHCP, TFTP, HTTP, BootP and ECHO
Serial Connectors:	DB25: RS-232/RS-322/RS-485 serial port with DCE configuration DB9: RS232 serial port with DTE configuration
Network Connectors:	10BASE-T or 10BASE-FL LAN/WAN: RJ-45 Modular Jack (Ethernet)
Ethernet Cable:	Category 3 or better unshielded twisted pair. Maximum length 100 m (328 ft).
RS-232 Cable:	Maximum length 15 m (50 ft).

Data Rates:	Serial speed ranging from 300 bps to 115.2 kbps.
Serial Line Formats:	Characters: 7 or 8 data bits Stop bits: 1 or 2 Parity: Odd, even, none
Modem Controls:	RTS, CTS, DSR, DCD, DTR
Flow Control:	XON/XOFF CTS/RTS
Management:	HTTP (internal web server) SNMP (read only) Serial login Telnet login
System Software :	Flash ROM standard. Downloads from a TCP/IP host (TFTP) or over serial port.
Diagnostic LEDs:	Network Transmit, Network Receive, Good Link, Collisions, Channel 1 Status, Channel 2 Status, and Diagnostic
Compatibility:	Ethernet: v2.0/IEEE 802.3 Conettix D6600 Communications Receiver/Gateway

Environmental

Operating Temperature:	+5°C to +49°C (+41°F to +122°F)
Storage Temperature:	+40°C to +66°C (-40°F to +151°F)

Ordering Information

Conettix D6680 Ethernet Network Adapter **D6680-E120**
 Ethernet 120/240 VAC adapter for use with the Conettix D6600 Communications Receiver/Gateway.

Conettix D6610 CPU Line Card

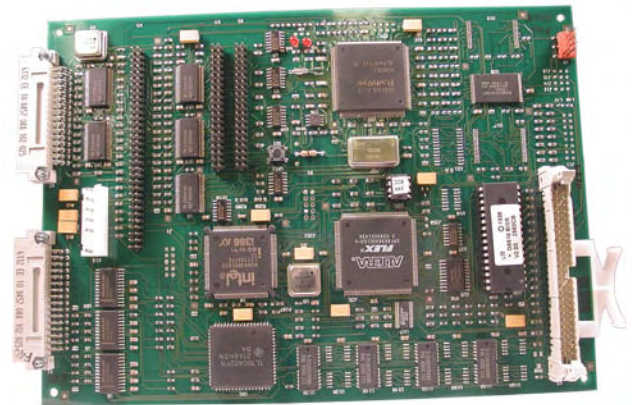

Modular design plug-in circuit board. Offers programmable FLASH memory for easy firmware upgrades. Includes a 20,000-event history buffer and a computer micro-processor. Performs Internet and intranet alarm monitoring and operates as a 32 telephone line digital receiver.

Certifications and Approvals

Region	Certification	
Europe	CE	1999/5/EC, EN55022: 1998, EN50130-4: 1996, EN60950: 2000, EN61000-3-2, EN61000-3-3, EN61000-4-2: 1995, EN61000-4-3: 1995, EN61000-4-4: 1995, EN61000-4-5: 1995, EN61000-4-6: 1995, EN61000-4-11: 1994, TBR21: 1998
USA	UL	AMCX: Central Station Alarm Units (UL1610, UL1635), APAW: Police Station Alarm Units (UL365, UL464)
	FM CSFM	7300-1615: 168 and 7300-1615: 179 July 2008

Ordering Information

Conettix D6610 CPU Line Card **D6610**
 Provides programmable FLASH memory for firmware upgrades. Includes a 20,000-event history buffer and a computer micro-processor.

Conettix D6615 CPU Terminator Card

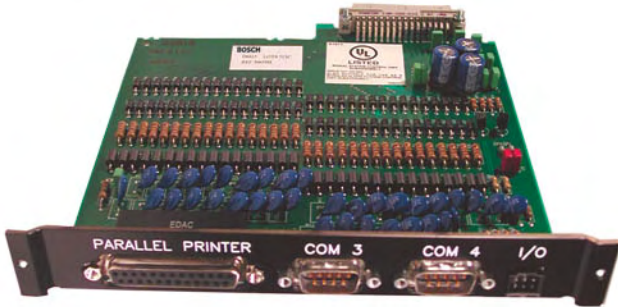

P6601 Battery Cable

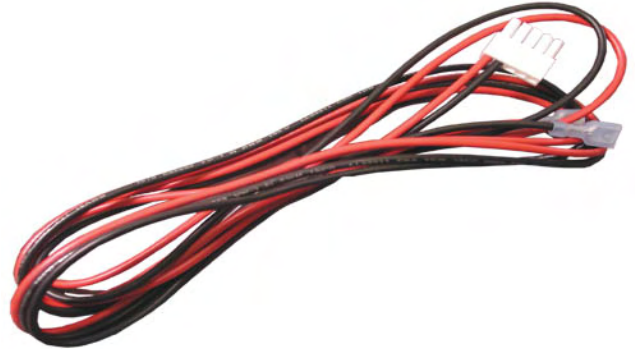

7

Modular design plug-in circuit board. Provides a shielded interface between the Conettix D6610 CPU Line Card and external connections to automation database computers and printers. Includes:

- Two serial ports
- One parallel port
- Two programmable inputs
- Two programmable outputs

Certifications and Approvals

Region	Certification	
Europe	CE	1999/5/EC, EN55022: 1998, EN50130-4: 1996, EN60950: 2000, EN61000-3-2, EN61000-3-3, EN61000-4-2: 1995, EN61000-4-3: 1995, EN61000-4-4: 1995, EN61000-4-5: 1995, EN61000-4-6: 1995, EN61000-4-11: 1994, TBR21: 1998
USA	UL	AMCX: Central Station Alarm Units (UL1610, UL1635), APAW: Police Station Alarm Units (UL365, UL464)
	FM	
	CSFM	7300-1615: 168 and 7300-1615: 179 July 2008

Ordering Information

Conettix D6615 CPU Terminator Card **D6615**
 Provides a shielded interface between the Conettix D6610 CPU Line Card and external connections to automation database computers and printers.

Connects a 12 VDC power source to the Conettix D6600 Communications Receiver/Gateway.

Ordering Information

P6601 Battery Cable **P6601**
 Connects a 12 VDC power source to the Conettix D6600 Communications Receiver/Gateway.

P6602 Input and Output Cable



Ordering Information

P6602 Input and Output Cable

Connects to the receiver and provides use of the input and output lines.

P6602

P6603 Acknowledgement Button



Ordering Information

P6603 Acknowledgement Button

Spare acknowledgement button.

P6603

Conettix D6100 Rack Mount Kit

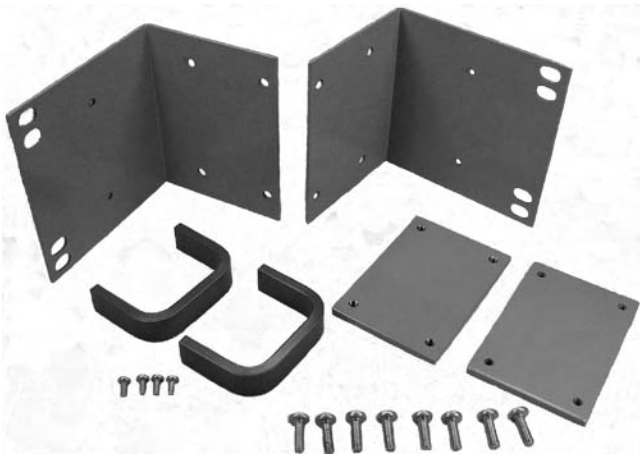

7

Ordering Information

Conettix D6100 Rack Mount Kit

Standard rack mount kit measuring 48.3 cm
(19 in.).

D6100RMK

ITS-300GSM Communicator

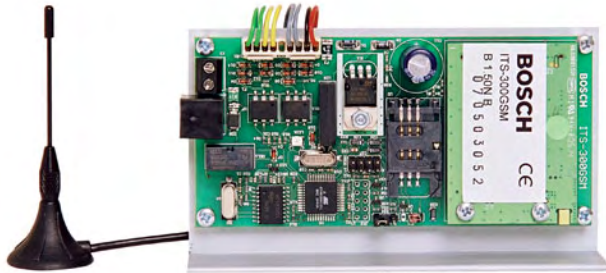

Features

- ▶ **Monitoring of the telephone line statically and dynamically**
- ▶ **Backup path transmission via the GSM network in the event of a fault in the telephone line**
- ▶ **Calls from house phone via the GSM network are possible**
- ▶ **Transmission of own events via the GSM network**
- ▶ **Local programming and remote programming**

The ITS-300GSM is used to automatically transmit control panel reports via the analog telephone network with backup transmission via the GSM network.

It is compatible with control panels from various manufacturers with integrated communicator for the analog telephone network.

System Overview

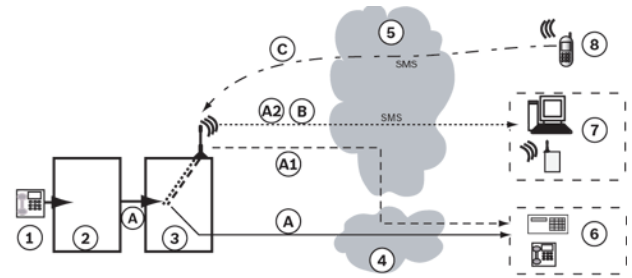

- (1) House phone
- (2) Control panel
- (3) ITS-300GSM
- (4) Analog telephone network
- (5) GSM mobile network
- (6) Telephone network receiver
- (7) SMS receiver
- (8) Cell phone
- (A) Outgoing calls and reports
- (A1) Transparent transmission
- (A2) SMS transmission
- (B) ITS-300GSM messages
- (C) Remote programming

Functions

Outgoing calls and reports are transmitted via the analog telephone network as standard. The ITS-300GSM monitors the telephone line statically and dynamically and switches to GSM transmission under certain conditions.

Static monitoring

The voltage of the telephone line is checked regularly. If the voltage is too low, the ITS-300GSM switches to GSM transmission and activates the fault relay. This allows the control panel to transmit the fault message via the GSM network, if necessary.

Dynamic monitoring

Dynamic monitoring is activated during report transmission. The switch to GSM transmission occurs if manipulation of the telephone line is detected or after three unsuccessful redial attempts from the control panel. After successful transmission, the ITS-300GSM reverts to the telephone line.

Backup path transmission

Backup path transmission via the GSM network is carried out either transparently or as an SMS message. In the event of transparent transmission, sent tones are transmitted transparently in the voice channel to the phone number dialed by the control panel. For SMS transmission, the contact ID report is sent to an SMS receiver in the form of an SMS message.

Calls from house phone

If the analog telephone network fails, calls from the house phone can be allowed or disallowed via the GSM network in accordance with the programming.

Transmission of own events

If necessary, the device can transmit test calls and fault/restoration of telephone line as an SMS message.

Programming

Programming is carried out with a cell phone via entries on the SIM card. In transparent transmission, no programming is necessary for standard applications. Remote programming is possible with a cell phone via SMS messages.

Display

The device has an LED display for device status, GSM field strength and active GSM transmission.

Voltage range	10 to 14 V DC
Dimensions	12.5 x 7 cm

Ordering Information**ITS-300GSM Communicator**

For backup transmission from a control panel's telephone dialer over the GSM network, if telephone line transmission is not working. Transmits reports and voice. Compatible with control panels from different manufacturers.

ITS-300GSM**Certifications and Approvals**

Region	Certification	
Europe	CE	
Country	Approval	ITS-300GSM Communicator

Installation/Configuration Notes

There must be sufficient GSM field strength at the antenna location. The ITS-300GSM supports SIM cards with a deactivated or default PIN.

	Transparent transmission	SMS transmission
SIM card required	Voice card	Data card (SMS)
Formats supported	Audio, transmission formats of the control panel (contact ID or DTMF-based formats recommended)	Contact ID
Alarm receiver	Standard receiver for telephone network (e.g. D6600)	Special SMS receiver

Parts Included

Type	Number	Component
ITS-300GSM	1	ITS-300GSM module with mounting frame, antenna, pre-assembled cable

Technical Specifications

Telephone line fault output	Normally closed
Telephone line fault limit value	3.5 V
Telephone network connection	RJ-11 socket or screw terminal
Supported GSM networks	800/900/1800 MHz
Power supply	Connection to control panel battery
Power intake	Standby: 30 mA; GSM transmission 350 mA

Conettix D6680 Ethernet Network Adapter



Features

- ▶ **Two channel adapter**
- ▶ **Network interface**
- ▶ **Serial interface**

The Conettix D6680 Ethernet Network Adapter is a two-channel network adapter. The D6680 connects the Conettix D6600 Communications Receiver/Gateway RS-232 Data Port to an Ethernet LAN/WAN. One adapter is required for each D6600 serial port with a direct connection to a data network (LAN/WAN).

Certifications and Approvals

Install the Conettix D6600 Communications Receiver/Gateway in accordance with NFPA 70, NFPA 72 and the local Authority Having Jurisdiction (AHJ). The Conettix D6680 Ethernet Network Adapter is suitable for Central Station Protective Signaling when it is installed and used in compliance with NFPA 72 and ANSI/NFPA 70. Installation limits for Digital Alarm Communicator Receivers (DACR) are under the jurisdiction of the user's local authority.

For UL Listed Fire Installations, equipment between Ethernet Interface Modules and the D6680 is required to be UL Listed Information Technology Equipment.

Region	Certification	
USA	UL	AMCX: Central Station Alarm Units (UL1610, UL1635), UOXX: Control Unit Accessories, System (UL864, 9th edition)
	FM	
	CSFM	7300-1615: 179 July 2008

Installation/Configuration Notes

Compatibility Information

Receivers: Conettix D6600 Communications Receiver/Gateway

Location and Enclosures

The D6680 must be installed in the same room as the D6600 and within 15.2 m (50 ft) of the D6600. Required for UL Central Station Protective Signaling, the D6680 must be mounted in a separate enclosure such as the AE1 (gray) or the AE2 (red).

Parts Included

Quantity	Component
1	Serial cable

Technical Specifications

Electrical

Power Requirements:	9 VDC to 30 VDC, or 9 VAC to 25 VAC External adapter included.
Power Consumption:	3 W
AC Current Required:	UPS Standby Current: 35 mA
Power Input:	AC nominal operating range 120 VAC or 240 VAC AC maximum operating range 100 VAC to 240 VAC ~ 50 Hz /60 Hz 0.2 A maximum
Standby Power:	An Uninterrupted Power Supply is required for use with the D6680, when used for UL FIRE Protective Signaling Systems. A 60 hour minimum UPS standby power supply is required for UL Certification.

Mechanical

Unit Dimensions:	16.5 cm x 11.3 cm x 36 mm (6.5 in. x 4.46 in. x 1.39 in.)
Enclosure Dimensions:	31.8 cm x 36.8 cm x 76 mm (12.5 in. x 14.5 in. x 3 in.) The enclosure is manufactured from 1.0 mm (20 Gauge), cold-rolled steel. A keyed lock is included.
Weight:	0.48 kg (1.1 lb)
Protocols Supported:	ARP, UDP, TCP, Telnet, ICMP, SNMP, DHCP, TFTP, HTTP, BootP and ECHO
Serial Connectors:	DB25: RS-232/RS-322/RS-485 serial port with DCE configuration DB9: RS232 serial port with DTE configuration
Network Connectors:	10BASE-T or 10BASE-FL LAN/WAN: RJ-45 Modular Jack (Ethernet)
Ethernet Cable:	Category 3 or better unshielded twisted pair. Maximum length 100 m (328 ft).
RS-232 Cable:	Maximum length 15 m (50 ft).

Data Rates:	Serial speed ranging from 300 bps to 115.2 kbps.
Serial Line Formats:	Characters: 7 or 8 data bits Stop bits: 1 or 2 Parity: Odd, even, none
Modem Controls:	RTS, CTS, DSR, DCD, DTR
Flow Control:	XON/XOFF CTS/RTS
Management:	HTTP (internal web server) SNMP (read only) Serial login Telnet login
System Software :	Flash ROM standard. Downloads from a TCP/IP host (TFTP) or over serial port.
Diagnostic LEDs:	Network Transmit, Network Receive, Good Link, Collisions, Channel 1 Status, Channel 2 Status, and Diagnostic
Compatibility:	Ethernet: v2.0/IEEE 802.3 Conettix D6600 Communications Receiver/Gateway

Environmental

Operating Temperature:	+5°C to +49°C (+41°F to +122°F)
Storage Temperature:	+40°C to +66°C (-40°F to +151°F)

Ordering Information

Conettix D6680 Ethernet Network Adapter **D6680-E120**
Ethernet 120/240 VAC adapter for use with the Conettix D6600 Communications Receiver/Gateway.

Conettix D6201 Series IP Security Keys



Features

- ▶ **3200 IP account USB or LPT keys available for larger capacity installations**
- ▶ **500 IP account USB key available for smaller projects and installations**

The Conettix D6201 Series IP Security Keys expand the IP account capability of each Conettix D6600 Communications Receiver/Gateway connected to the Conettix D6200 Programming/Administration Software.

Conettix D6200 Programming/Administration Software allows users to view, change, upload and download programming parameters for a Conettix D6600 Communications Receiver/Gateway. The software includes 10 default IP accounts.

The D6201-500-USB Security Key allows each D6600 to support up to 500 IP accounts.

For larger capacity installations, dealers can purchase or upgrade to the D6201 or D6201-USB Security Keys, which expand the D6600 account capacity to a maximum of 3200 IP accounts for each receiver.

Installation/Configuration Notes

D6200 Programming Software Requirements

Version	Reason
1.05 or higher	Required for USB security key operation.
1.24 or higher	Required to use one security key for each site. For older software versions, one security key is necessary for each computer running D6200 Programming Software.

Conettix D6200 Programming/Administration Software can be downloaded from the Bosch Security Systems website or ordered on a CD-ROM at no charge. Refer to Ordering Information.

Ordering Information

3200 Account Conettix IP Security Key (LPT)	D6201
Designed for parallel ports. Allows each Conettix Communications Receiver/Gateway to support a maximum of 3200 IP accounts.	
3200 Account Conettix IP Security Key (USB)	D6201-USB
Designed for USB ports. Allows each Conettix Communications Receiver/Gateway to support a maximum of 3200 IP accounts.	
500 Account Conettix IP Security Key (USB)	D6201-500-USB
Designed for USB ports. Allows each Conettix Communications Receiver/Gateway to support 500 IP accounts.	

Software Options

Conettix D6200CD CD-ROM	D6200CD
Provides software for programming, operating, simulating, and demonstrations. Includes PDF documentation files for hardware and software relating to the Conettix Communications Receiver/Gateway.	

Conettix C900V2 Dialer Capture Ethernet Module

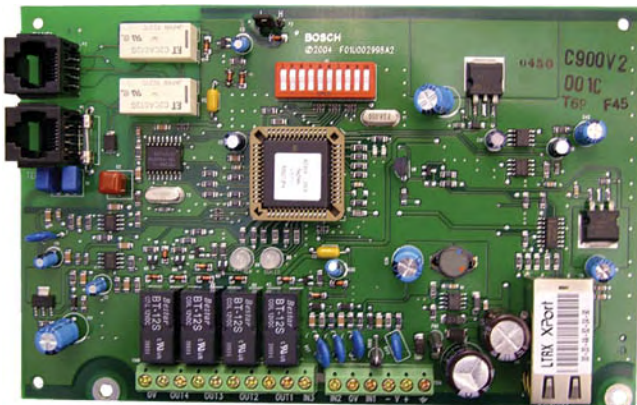

7

Features

- ▶ Captures alarm and event data from dialer-based control panels using CONTACT ID, SIA, Modem II, Modem IIe, Modem IIIa², Pulse, and other formats
- ▶ Performs full data transmissions without changing the data
- ▶ 12 VDC to 24 VDC voltage range
- ▶ Re-routes signals using UDP/IP-based data networks
- ▶ Convenient connection (RJ-45 Jack) to Ethernet networks
- ▶ Integrated 10/100 Network Interface Module (NIM)
- ▶ Provides acknowledgement from the receiver to the control panel
- ▶ Supports 128-bit AES Rijndael encryption

The Conettix C900V2 Dialer Capture Ethernet Module works with most control panels using a standard digital dialer format and provides end-to-end security. The module links the digital dialer to the Public Switched Telephone Network (PSTN), the digital dialer's telephone interface, and an Ethernet network. With the Ethernet link, the C900V2 can:

- Communicate with the control panel dialer
- Decode and deliver signals to a Conettix D6600 Communications Receiver/Gateway
- Relay a confirmation message back to the control panel dialer

Whether a control panel dials through a telephone line or through the C900V2, the data remains the same. The C900V2 empowers digital dialer control panels to work over an IP network such as a Local Area Network (LAN), a Wide Area Network (WAN), or the Internet.

System Overview

When the dialer has a message to report, the C900V2 simulates dial tone and line voltages, causing the dialer to behave as though it is connected to a monitoring center digital receiver through the PSTN. The C900V2 decodes and converts the transmitted dialer message to data for transport over any UDP/IP network.

After the Conettix D6600 Communications Receiver/Gateway receives a message or event, it sends an acknowledgement message to the C900V2. The C900V2 returns an appropriate response to the dialer, maintaining end-to-end acknowledgment.

The C900V2 operates in Intercept Mode, connecting the dialer to the network under normal circumstances. If the C900V2 loses contact with the Conettix D6600 Communications Receiver/Gateway, the unit goes into Fallback Mode, connecting the dialer to the PSTN telephone line.

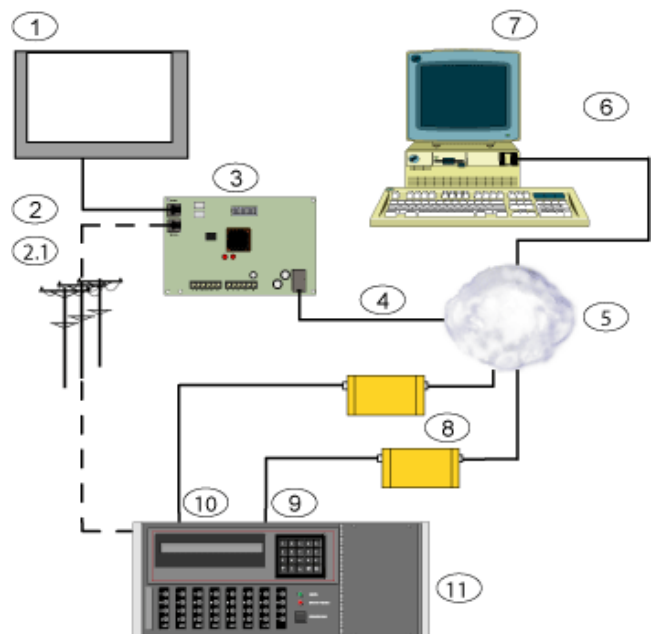

1. Control Panel
2. Dialer Connection
 - 2.1 Dialer Output to RJ-31x Jack and PSTN
3. Conettix C900V2 Dialer Capture Ethernet Module
4. Ethernet or LAN Connection
5. LAN, WAN, or the Internet
6. Connection To Ethernet Network Interface Card (NIC)
7. Host PC with Conettix D6200 Programming/Administration Software
8. Conettix D6680 Ethernet Network Adapter
9. Com 1 (Optional)
10. Com 4
11. Conettix D6600 Communications Receiver/Gateway

Functions

Communication Formats

- ADT-SIA
- BFSK (2300Hz ACK Tone or 1400Hz ACK Tone)
- DTMF (Contact ID, High Speed and 4/2 Express)
- FBI Superfast DTMF (1400 Hz ACK Tone or 2300 Hz ACK Tone)
- Pulse 3/1, 3/1 Checksum, 4/2 (1400 Hz ACK Tone or 2300 Hz ACK Tone)
- Radionics Modem II, Radionics Modem IIe , and Modem IIIa²
- Series FSK and DTMF
- SIA V.21, 110/300 baud
- SIA Bell 103, 110/300 baud
- Robofon
- Telim

Inputs

Input	Description
1	Used as an end-of-line (EOL) supervised loop. Detects open, short, and normal states. Terminate this input with a 10 kΩ EOL resistor.
2	Used for intercept inhibit to force the C900V2 into Fallback mode for at least two minutes.
3	Used for intercept override, allowing users to switch between intercept and fallback modes.

Outputs

Output	Description
1	Provides local annunciation if the power to the C900V2 is lost or the CPU fails.
2	Provides local annunciation if the connection to the monitoring center is lost.
3	Provides local annunciation whenever the C900V2 is in intercept mode.
4	Controllable from the monitoring center and the Conetrix D6200 Programming/Administration Software (default is open).

Intercept and Fallback Modes

- **Intercept Mode:** The C900V2 connects the dialer to the network. Intercept mode remains on as long as the C900V2 remains in continuous contact with the Conetrix D6600 Communications Receiver/Gateway.
- **Fallback Mode:** The C900V2 connects the dialer to the telephone line, removing itself from the telephone circuit. Fallback mode occurs if the C900V2 loses contact with the Conetrix D6600 Communications Receiver/Gateway, loses power, or stops operating correctly.

LED Indicators

The C900V2 has two dual-colored LEDs that indicate the module's status (the SYSTEM LED and the DIALER LED).

Modular Jacks

The C900V2 module has three modular jacks.

- **Panel Jack:** Connects to a dialer through a modular telephone cord (D162).
- **TELCO Jack:** Connects to a PSTN line through a modular telephone cord (D162).
- **Ethernet Jack:** Connects to the Ethernet data network through an Ethernet cable. For 10BASE-T, the cable must be Category 3 or better. For 100BASE-T, the cable must be Category 5 or better.

Polling and Supervision

Conetrix C900V2 polling helps the Conetrix D6600 Communications Receiver/Gateway to perform supervision.

Web Programming Tool

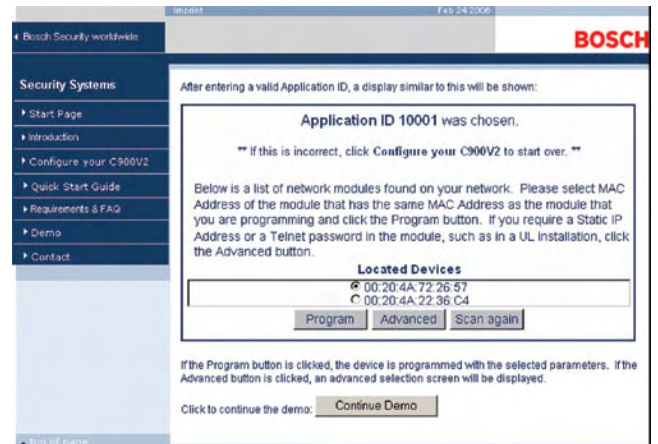

The web programming tool makes the C900V2 configuration process simple and convenient, similar to browsing a web site. After obtaining an Application ID, installers can go to www.c900v2.com from a computer with internet access and configure the C900V2 for the preferred central station.

Certifications and Approvals

Region	Certification	
Europe	CE	1999/5/EC, EN55022: 1998, EN50130-4: 1996+A1: 1998+A2: 2003, EN60950-1: 2001, EN61000-3-2, EN61000-3-3, EN61000-4-2: 1995+A1: 1998, EN61000-4-3: 1995+A1: 1998, EN61000-4-4: 1995, EN61000-4-5: 1995, EN61000-4-6: 1996, EN61000-4-11: 1994, TBR21: 1998
Belgium	INCERT	B-509-0040/a
USA	UL	AMCX: Central Station Alarm Units (UL1610, UL1635), AMCX7: Central Station Alarm Units Certified for Canada (cULus), APAW: Police Station Alarm Units (UL365, UL464), APAW7: Police Station Alarm Units Certified for Canada (cULus), APOU: Proprietary Alarm Units (UL1076), APOU7: Proprietary Alarm Units Certified for Canada (cULus), NBSX: Household Burglar Alarm System Units (UL1023), NBSX7: Household Burglar Alarm System Units Certified for Canada (cULus), UTOU: Control Units and Accessories - Household System Type (UL985), UTOU7: Control Units and Accessories - Household System Type Certified for Canada (cULus) UL864, 9th edition
	FM	
	CSFM	7300-1615: 180 and 7167-1615: 223 July 2008

Australia	A-Tick
Canada	IC
USA	FCC Part 15 Radiated/Conducted Emissions

Note FM approval applies when the C900V2 is used with the Conettix D6600 Communications Receiver/Gateway.

Installation/Configuration Notes

Compatibility Information

Numerous UL Listed Fire Alarm Control Panels (FACPs) have proven compatible with the C900V2. For a complete list, refer to the *Network Dialer Capture Module C900V2 Compatibility List* (F01U010036).

Technical Specifications

Connectors

Control Panel:	RJ-45 Modular Jack
Telco:	RJ-45 Modular Jack
LAN/WAN:	RJ-45 Modular Jack
Ethernet Cable:	Unshielded twisted pair 100 m (328 ft) For 10BASE-T, use Category 3 or better. For 100BASE-T, use Category 5 or better.

Environmental Considerations

Temperature (Operating): 0°C to +49°C (+32°F to +120°F)

Indicators

Module Status LEDs: 2 dual-colored

Module

Dimensions:	17.8 cm x 11.4 cm (7 in. x 4.5 in.)
Interface:	IEEE 802.3

Power Requirements

Current (Maximum):	280 mA
Voltage Range:	12 VDC to 24 VDC nominal
Alarm Outputs:	Normally-open (NO) dry contacts

Protocols

Output To LAN or WAN: UDP/IP packets

Ordering Information

Conettix C900V2 Dialer Capture Ethernet Module C900V2

Compatible with control panels using a standard digital dialer format. Provides end-to-end security. Allows digital dialer control panels to work over an IP network (such as LAN, WAN, or the Internet).

Accessories

AE1 Standard Enclosure (Gray) AE1

Standard gray enclosure with keyed lock. Measures 35.6 cm x 31.8 cm x 7.6 cm (14 in. x 12.5 in. x 3 in.).

Conettix DX4020 Ethernet Network Interface Module

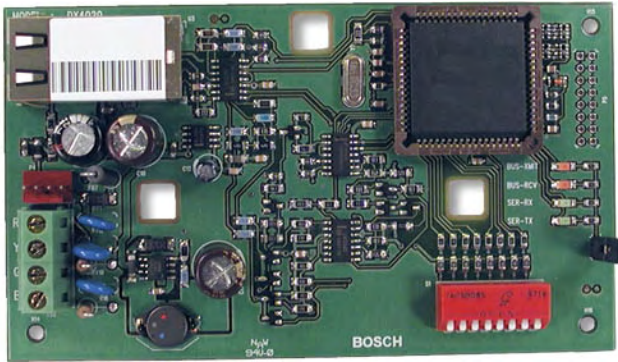

Features

- ▶ Built-in IP-based alarm transport, programming, and control
- ▶ 10BASE-T or 100BASE-T network connection
- ▶ Full-duplex and half-duplex support
- ▶ Three-hole mounting pattern
- ▶ Support for dynamic or static IP addresses
- ▶ DIP switches for option bus or SDI bus address programming
- ▶ Light emitting diodes (LEDs) provide control panel status
- ▶ Supports 128-bit AES Rijndael encryption

The Conettix DX4020 Ethernet Network Interface Module creates two-way communications over Ethernet networks for compatible control panels. Typical uses include:

- Reporting to the Conettix D6600 Communications Receiver/Gateway
- Remote administration with Remote Programming Software (RPS) or RPS-Lite
- Connecting to a PC for programming with PC9000 Software or Building Integration System (BIS) Security Engine

System Overview

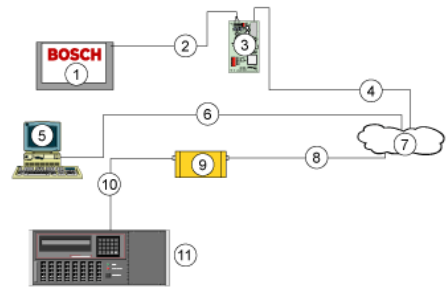

1. Compatible Control Panel
2. Compatible Control Panel Option Bus or SDI Bus Connection
3. Conettix DX4020 Ethernet Network Interface Module
4. Ethernet Network Connection to DX4020
5. Host PC running Conettix D6200 Programming/Administration Software
6. Ethernet Network Connection to Host PC Ethernet Network Interface Card (NIC)
7. Ethernet Network, Local Area Network (LAN), Metropolitan Area Network (MAN), Wide Area Network (WAN), or Internet
8. Ethernet Network Connection to Conettix D6680 Ethernet Network Adapter
9. Conettix D6680 Ethernet Network Adapter
10. Conettix D6680 Ethernet Network Adapter Connection to Conettix D6600 Communications Receiver/Gateway COM4 Port
11. Conettix D6600 Communications Receiver/Gateway

The system overview diagram shows a system using a compatible control panel, Conettix DX4020 Ethernet Network Interface Module, Conettix D6600 Communications Receiver/Gateway, and a Conettix D6680 Ethernet Network Adapter.

Functions

LEDs

Red LEDs	Function
BUS-RCV	Data bus receives data from control panel
BUS-XMIT	Data bus transmits data to control panel
Green LEDs	Function
SER-RX	RS-232 receives data from serial device
SER-TX	RS-232 transmits data to serial device

Four LEDs provide information about the transmission and receipt of data. There are also two network diagnostic LEDs that provide information about the network connection. Refer to the DX4020 Installation Guide (P/N 49522) for details about the network diagnostic LED functions.

DIP Switches

Use the DIP switches to easily assign a bus address to the DX4020.

Programmable IP Address

Use ARP and Telnet commands from any PC to program the DX4020 IP address. The IP address can be dynamic using DHCP or the IP address can be static.

Certifications and Approvals

Region	Certification	
Europe	CE	89/336/EEC, EN55022: 1997 +A2: 2002, EN50130-4: 1995 +A1: 1998 +A2: 2003, EN60950: 2000, EN61000-3-2: 2001, EN61000-3-3A1: 2001, EN61000-4-2: 1995 +A1: 1998 +A2: 2001, EN61000-4-3: 1996 +A1: 1998 +A2: 2000, EN61000-4-4: 1995 +A1: 2001 +A2: 2001, EN61000-4-5: 1995 +A1: 2001, EN61000-4-6: 1996 +A1: 2000, EN61000-4-11: 1994 +A1: 2001
USA	UL	AMCX: Central Station Alarm Units (UL1610, UL1635), AMCX7: Central Station Alarm Units Certified for Canada (cULus), APAW: Police Station Alarm Units (UL365, UL464), APAW7: Police Station Alarm Units Certified for Canada (cULus), APOU: Proprietary Alarm Units (UL1076), APOU7: Proprietary Alarm Units Certified for Canada (cULus), NBSX7: Household Burglar Alarm System Units Certified for Canada (cULus), UTOU7: Control Units and Accessories - Household System Type Certified for Canada (cULus) UL864, 9th edition
		FM
		CSFM
	NYC-MEA	12-92-E, Vol. XIII and 12-92-E, Vol. 15
France	AFNOR	NF, A2P Type 2 (122000076-05)
Note		FM Approval applies when the DX4020 is used with the Conettix D6600 Communications Receiver/Gateway.

Installation/Configuration Notes

Compatibility information

Applications

RPS:	Supported on all compatible control panels.
PC9000:	Supported on the following control panels: D9412G, D7412G, D7212G, D9112, D7412, and D7212.
Building Integration System (BIS) Security Engine:	Supported on the following SDI bus control panels (version 6.3 and higher): D9412GV2, D7412GV2, D7212GV2, D9412G, D7412G, and D7212G.
CMS 7000:	Supported on DS7400Xi-CHI Control Panels (option bus) set at Mode 18 (version 4.10 or higher).

SDI Bus Control Panels (version 6.0 or higher)

- D9412GV2, D7412GV2, and D7212GV2
- D9412G, D7412G, and D7212G
- D9412, D7412, and D7212
- D9112

Option Bus Control Panels

- DS7400Xi (version 4.10 or higher)
- CC7420-A
- DS7220 and DS7240 (version 2.10 or higher)
- FPD-7024

Connection Considerations

The DX4020 uses a standard Category 3 or Category 5 cable with an RJ-45 plug to connect to the network, a two-wire connection from the control panel bus, and two wires that connect to the control panel or a power supply for DC power. For 10BASE-T, use Category 3 or better. For 100BASE-T, use Category 5 or better.

Mounting Considerations

The DX4020 mounts to the standard three-hole patterns in supported control panel enclosures. With the D137 mounting bracket, the DX4020 mounts to other enclosures.

Parts Included

Quant.	Component
1	Ethernet network interface module
1	Cable assembly, quick connect
1	Hardware pack
1	Literature - Installation Guide

Technical Specifications

Environmental Considerations

Dimensions:	7.6 cm x 12.7 cm (3 in. x 5 in.)
Operating Temperature:	0°C to +50°C (+32°F to +122°F)
Relative Humidity:	5% to 85% at 30°C (86°F) non-condensing

Power Requirements

Current:	10Base-T: 110 mA maximum 100Base-T: 135 mA maximum
Voltage (Operating):	12 VDC nominal

Ordering Information

Conettix DX4020 Ethernet Network Interface Module	DX4020
Creates two-way communications over Ethernet networks for compatible control panels.	

Accessories

AE1 Standard Enclosure (Gray)	AE1
Standard gray enclosure with keyed lock. Measures 35.6 cm x 31.8 cm x 7.6 cm (14 in. x 12.5 in. x 3 in.).	

AT 2000 Analog Transmission System



Features

- ▶ 7 parallel inputs, 2 outputs (12 in/12 out optional)
- ▶ Programmable with PC software (WPAT)
- ▶ Tone and pulse dialing methods
- ▶ Tamper and blockade release

The AT 2000 Analog and AFS auto dialers and communicators handle the analog transmission of danger alarms, technical alarms/statuses via telecommunication networks.

Functions

Network access	Transmission procedure	Transmission protocol	Receiver
Analog network	Analog 10 bits/sec.	Telim	Analog monitoring station
	BOSCH 300 bits/sec.		Analog monitoring station
	Data transmission to TAP/UCP server	Euromessage message (tone dialing)	Euromessage receiver

In the event of tampering or damage to the relaying telephone line, the AT 2000 can send a message (tamper release).

The absolute operating procedure on the telephone line is enabled by the blockade release.

Monitoring of the auto dialer and the telephone network occurs through a routine call.

The AT 2000 has a tamper contact.

Power monitoring: network, battery, undervoltage

The event storage for up to 31 events can be read out using a PC.

AT 2000 AFS

- In addition, the AT 2000 AFS can handle the remote-control of outputs with the BOSCH transmission procedure.
- The four outputs (relays) can be controlled depending on the message line status (locally) and via remote control by reception and transmission equipment using the Bosch procedure.

Certifications and Approvals

Region	Certification	
Europe	CE	AT 2000 Analog/AFS
Germany	VdS	G 196808 AT 2000 Analog

Installation/Configuration Notes

Telephone line

- The AT 2000 Analog enables connection to main and auxiliary lines and is connected to the telephone line via a TAE junction box.

Fire detection technology

- Interface according to VDE 0833 part 2 can be provided optionally.

Parts Included

Type	Qty.	Component
AT 2000 Analog incl. housing and power supply	1	Analog alarm transceiver with housing and power supply
AT 2000 Analog incl. housing	1	Analog alarm transceiver with housing (without power supply)
AT 2000 Analog Installation module	1	Analog alarm transceiver Installation module (without housing and power supply)
AT 2000 AFS Installation module	1	Analog/remote-controlled alarm transceiver Installation module (without housing and power supply)

Technical Specifications

Housing versions and installation modules

Operating voltage	10.5 V to 14.5 V
Current consumption	
<ul style="list-style-type: none"> • Standby current • Transmission mode • Additional current per activated relay 	Approx. 60 mA Approx. 85 mA Approx. 12 mA
Trigger resistance	5.62 kilohm ±1%
Activation time	> 200 ms

Housing versions and installation modules

Load on switch contacts

- Max. output 30 W/60 VA (Ohm resistive load)
- Max. voltage 50 V

Ambient temperature -0 °C to +50 °C

Environmental class II (VdS 2110)

Protection category IP 30

Housing

Dimensions (H x W x D) 366 x 258 x 79 mm

Color Light gray

Weight without/with Power supply 3.2 kg/3.7 kg

Power supply

- Protection class I
- Mains voltage 230 V (-15% to ±10%)
- Mains frequency 50 Hz (±10%)
- Mains current consumption 85 mA
- Battery capacity 12 V/6.5 Ah
- Backup time Max. 72 hours

Ordering Information**AT mounting kit in UEZ 2000/BZ 500 3902130725**

For installation of an AT 2000 installation module in UEZ 2000 LSN or BZ 500 LSN

7

Ordering Information**AT 2000 Analog incl. case and power supply unit 4998063529**

For analog transmission of alarm and fault messages via the telecommunication networks

AT 2000 Analog, incl. case 4998063528

Without power supply unit, for analog transmission of alarm and fault messages via telecommunication networks

AT 2000 Analog, installation module 3002130733

For installation in control panel housing, for analog transmission of alarm and fault messages via telecommunication networks

AT 2000 AFS, installation module 3002130734

For installation in control panel housing, for analog transmission of alarm and fault messages via telecommunication networks, remote-controlled

Accessories**Extension fire AT 2000 3902130697**

For provision of the interface between AT 2000 and smoke detector control panel in accordance with VDE 0833 Part 2

Extension 12 in AT 2000 ITS-AT12IN

For extending the AT 2000 with 12 additional inputs (input lines)

12 in/out AT 2000 extension ITS-AT12IO

For extending the AT 2000 with 12 additional inputs (input lines) and 12 outputs (relay contacts)

AT 2000 power supply unit 3902130741

For integrated power supply

AT 2000 case 3902130740

Incl. mounting kit for all AT 2000 devices

AT 2000 ISDN Transmission System



The AT 2000 ISDN can be activated via the serial S1 interface (optional) or the parallel S1 interface with 7 input line inputs.

The outputs (relay) can be controlled depending on the message line status (locally) and via remote control according to VdS 2465 by reception and transmission equipment.

In the event of tampering or damage to the relaying ISDN line, the AT 2000 can send a message (tamper release).

The absolute operating procedure on the telephone line is enabled by the blockade release.

Monitoring of the auto dialer and the telephone network occurs through a routine call.

The AT 2000 has a tamper contact.

Audio and visual display.

Power monitoring: network, battery, undervoltage

The event storage for up to 512 events can be read out using a PC.

Features

- ▶ 7 parallel inputs, 2 outputs (12 in/12 out optional)
- ▶ Programmable with PC software (WPAT)
- ▶ Supports ISDN PTP and PMP
- ▶ Transmission via ISDN B and D-channel
- ▶ Monitoring of layer 1 (ISDN constant monitoring)
- ▶ Tamper and blockade release (ISDN)

The AT 2000 ISDN auto dialer and communicator handles the transmission of danger alarms, technical alarms/statuses via the ISDN telephone network.

Functions

Network access	Transmission procedure	Transmission protocol	receiver
ISDN network (B-channel)	X.75 with 64 kBit/sec	VdS 2465	ISDN monitoring station
	Analog 10 baud	Telim	Analog monitoring station
	Data transmission to TAP/UCP server	Euromessage message SMS plain text	Euromessage receiver, cell phone (D1/D2)
ISDN network (D-channel)	X.31 with transfer to X.25	VdS 2465	X.25/X.31 monitoring station

The signaling occurs on the B-channel (X.75 connection) and D-channel (X.31 connection).

The AT 2000 ISDN permits connection to multi-device and equipment connections (PMP/PTP) and is connected in front of telecommunications equipment and using a Telekom junction box to the telephone line.

Certifications and Approvals

Region	Certification	
Europe	CE	AT 2000 ISDN
Germany	VdS	G 198802 AT 2000 ISDN

Installation/Configuration Notes

ISDN connection

- The AT 2000 ISDN is suitable for connection to basic access – with the international protocol DSS1.
- Primary multiplex connection S2M is not possible.
- The AT 2000 ISDN communicator for danger alarms must be connected to the S₀ bus as the first device. With this connection, it is possible for the AT 2000 ISDN to send a message even in the event of tampering or damage to the bus wiring.

ISDN PTP

- The "constant monitoring" layer 1 feature is present by default for system access.
- The max. cable length from network termination NT via the UAE 8/8 box to the TK system or to the end unit is 1000 m.

ISDN PMP

- The "constant monitoring" layer 1 feature is also required with a multi-system connection.
- The max. cable length between network termination and TK system or end unit is 150 m.

ISDN X.31 transmission

- Datex-P ISDN ACCESS 100 (X.31) "Access 100" service packet for VdS 2465 (D-channel) enables the configuration of a virtual dedicated line for tamper-proof transmission. Additional D-channel services can be used with this application after the AT 2000.
- ACCESS ≥ 100 must be applied per MSN.

Fire detection technology

- Interface according to VDE 0833 part 2 can be provided **optionally**.

Parts Included

Type	Qty.	Component
AT 2000 ISDN incl. housing and power supply	1	ISDN alarm transceiver with housing and power supply
AT 2000 ISDN incl. housing	1	ISDN alarm transceiver with housing (without power supply)
AT 2000 ISDN Installation module	1	ISDN alarm transceiver Installation module (without housing and power supply)

Technical Specifications**Housing versions and installation module**

Operating voltage	10.5 V to 29.0 V
Current consumption	
• Standby current	Approx. 84 mA
• Transmission mode	Approx. 86 mA
• Additional current per activated relay	Approx. 12 mA
Trigger resistance	5.62 kilohm \pm 1%
Activation time	> 200 ms
Load on switch contacts	
• Max. output	30 W/60 VA (Ohm resistive load)
• Max. voltage	50 V
Ambient temperature	-0 °C to +50 °C
Environmental class	II
Protection category	IP 40
Housing	
• Dimensions (H x W x D)	366 x 258 x 79 mm
• Color	Light gray
• Weight without/with power supply	3.2 kg/3.7 kg
Power supply	
• Protection class	I
• Mains voltage	230 V (-15% to \pm 10%)
• Mains frequency	50 Hz (\pm 10%)
• Mains current consumption	85 mA
• Battery capacity	12 V/6.5 Ah
• Backup time	Max. 72 hours

Ordering Information

AT 2000 ISDN, incl. case and power supply unit	4998063532
For transmission of alarm and fault messages via the ISDN telephone network	
AT 2000 ISDN, incl. case	FMA-AT2000-ISDN
Without power supply, for transmission of alarm and fault messages via the ISDN telephone network	
AT 2000 ISDN, installation module	3002130732
For installation in control panel housing, for transmission of alarm and fault messages via the ISDN telephone network	
Accessories	
Extension fire AT 2000	3902130697
For provision of the interface between AT 2000 and smoke detector control panel in accordance with VDE 0833 Part 2	
12 in/out AT 2000 extension	ITS-AT12IO
For extending the AT 2000 with 12 additional inputs (input lines) and 12 outputs (relay contacts)	
Extension 12 in AT 2000	ITS-AT12IN
For extending the AT 2000 with 12 additional inputs (input lines)	
AT 2000 power supply unit	3902130741
For integrated power supply	
UAE 8/8 junction box, surface mounted	2799181572
Necessary if transmission devices need to be connected in front of existing end units	
AT 2000 case	3902130740
Incl. mounting kit for all AT 2000 devices	
AT mounting kit in UEZ 2000/BZ 500	3902130725
For installation of an AT 2000 installation module in UEZ 2000 LSN or BZ 500 LSN	

AT 2000 TSN ISDN Transmission System

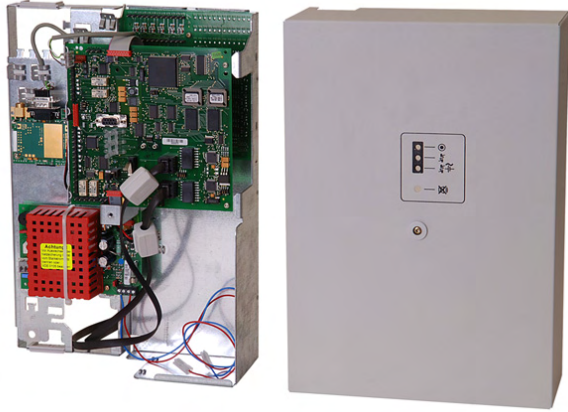

Features

- ▶ 7 parallel inputs, 4 outputs (12 in/12 out optional)
- ▶ Programmable with PC software (WPAT2000)
- ▶ Supports ISDN PTP and PMP
- ▶ Transmission via ISDN B and D-channel or GSM network
- ▶ Monitoring of layer 1 (ISDN and GSM network access)
- ▶ Tamper and blockade release (ISDN)

The AT 2000 TSN ISDN auto dialer handles the transmission of alarm and fault messages via the ISDN network with backup path signaling via the GSM network.

Functions

Network access	Transmission procedure	Transmission protocol	Receiver
ISDN network (B-channel)	X.75 with 64 kBit/sec	VdS 2465	ISDN monitoring station
	Analog 10 baud	Telim	Analog monitoring station
	Data transmission to TAP/UCP server	Euromessage message, SMS plain text	Euromessage receiver, cell phone (D1/D2)
ISDN network (D-channel)	X.31 with transfer to X.25	VdS 2465	X.25-/X.31 monitoring station
GSM network	SMS service	VdS 2465	GSM monitoring station (SMS)
	SMS service	SMS plain text	Cell phone
	V.110 (data channel)	VdS 2465	GSM monitoring station (V.110) ISDN monitoring station (V.110)

Alarm or fault messages are transmitted via the ISDN network on the B or D-channel, or via the GSM module.

On failure of the primary transmission line, alarm messages can be relayed via the backup path to an appropriately equipped monitoring station.

The AT 2000 TSN ISDN permits connection to multi-device and equipment connections (PMP/PTP) and is connected in front of telecommunications equipment and using a Telekom junction box to the telephone line.

In the event of tampering or damage to the relaying ISDN line, the AT 2000 can send a message (tamper release).

The absolute operating procedure on the telephone line is enabled by the blockade release.

Monitoring of the auto dialer and the telephone network occurs through a routine call.

The AT 2000 has a tamper contact.

Audio and visual display.

Power monitoring: network, battery, undervoltage

The event storage for up to 512 events can be read out using a PC.

Certifications and Approvals

Region	Certification	
Europe	CE	AT 2000 TSN ISDN
Germany	VdS	G 199813 AT 2000 TSN ISDN

Installation/Configuration Notes

ISDN connection

- The direct connection is to the ISDN S₀, with the ISDN-DSS1 protocol.

- Operation using the primary multiplex connection S2M is not possible.
- The AT 2000 TSN ISDN communicator for danger alarms must be connected to the S₀ bus as the first device. With this connection, it is possible for the AT 2000 TSN ISDN to send a message even in the event of tampering or damage to the bus wiring.

ISDN PTP

- The "constant monitoring" layer 1 feature is present by default for system access.
- The max. cable length from network termination NT via the UAE 8/8 box to the TK system or to the end unit is 1000 m.

ISDN PMP

- The "constant monitoring" layer 1 feature is also required with a multi-system connection.
- The max. cable length between network termination and TK system or end unit is 150 m.

GSM transmission

- The GSM network can also be used alone for a message transmission (without ISDN).
- For application according to VdS, only backup path transmission from D1 to D1 or D2 to D2 is permissible.

Antenna planning

- The antenna selection depends on the measured field strength. The antenna and the cable must be selected so that the measured attenuation on the AT 2000 does not exceed -87 dB.
- If the antenna is placed near an automatic fire or intrusion detector, the distance of the antenna to the detector must be at least 1 m.
- We generally recommend the use of a radiator (rod antenna for exterior and interior areas). If the reception level implemented with a radiator is insufficient, beam antennas (planar or exterior antennas for exterior and interior areas) should be used.
- With the installation of antennas outdoors, the relevant DIN VDE provisions, especially DIN VDE 0845 part 1 and VdS 2311 appendix F (protection against lightning) must be adhered to! The ground connection isolator and the lightning protection set (optional) are designed for this.
- Make measurements precisely where the antenna will be mounted. The measurement results must remain stable for a period of 10 minutes.

Antenna	Gain	Cable attenuation	Comments
Magnet foot antenna	0 dBi (Entire system)		2.6 m fixed cable with FME connector, female
Rod antenna	3.5 dBi (Value without cable)	0.3 dB/m	With 20 m fixed cable, with FME connector, female
Planar antenna	8 dBi	According to cable type	Type of connection N-connector
Exterior antenna	10 dBi	According to cable type	Connection type: 7/16 connector

Antenna cable

Cable type	Cable attenuation	Cable Ø	Comments
Standard cable	0.3 dB/m	Approx. 5 mm	Low loss cable
Aircom Plus	0.15 dB/m	10.8 mm	SOHA

- If necessary, the pre-configured cables must be shortened in order to avoid unnecessary attenuation.
- The Aircom Plus cable must be used if the low-attenuation standard cable achieves no level better than -87 dBm.
- Applications must strictly adhere to the bending radius of at least 55 mm.

Product ID

4.998.066.838	Aircom Plus cable (SOHA)
4.998.066.839	Expansion module connector for the Aircom Plus cable (SOHA)

Fire detection technology

- Interface according to VDE 0833 part 2 can be provided optionally.

Parts Included

Type	Qty.	Component
AT 2000 TSN ISDN	1	AT 2000 installation module with housing, power supply unit and GSM module

Technical Specifications

Housing version

Current consumption	
• Standby current	Approx. 125 mA
• ISDN transmission	Approx. 127 mA
• GSM transmission	Approx. 255 mA
• Additional current per activated relay	Approx. 12 mA
Terminal resistance of the primary line	10 kilohm ± 1%
Activation time	> 200 ms
Load on switch contacts	
• Max. output	30 W/60 VA (Ohm resistive load)
• Max. voltage	50 V
ambient temperature	-0 °C to +50 °C
Environmental class	II
Protection category	IP 40
Housing	
• Dimensions (H x W x D)	366 x 258 x 103 mm
• Color	Light gray
• Weight without/with battery	4.0/8.0 kg

Housing version

Power supply

- Protection class I
- Mains voltage 230 V (-15% to ±10%)
- Mains frequency 50 Hz (±10%)
- Mains current consumption 200 mA
- Battery (order separately) 12 V/1 x 10 Ah
- Backup time Max. 72 hrs.

Radio module

GSM network 900/1800 MHz

Ordering Information

FME connector, male 4998097868
For antenna cable

7/16 connector, male 4998097869
For antenna cable

N-connector, male 4998131687
For antenna cable

Lightning protection set 4998151211
For the AT with connection to an exterior antenna, lightning/voltage surge conductor for coaxial antenna systems of mobile radio systems (e.g. GSM or UMTS)

Ordering Information**AT 2000 TSN ISDN Transmission System ITS-AT2000TSN**

With housing, power supply unit, AT 2000 ISDN installation module and GSM module, for transmission of alarm and fault messages via the ISDN network and backup path signaling via the GSM network

Accessories**Extension fire AT 2000 3902130697**

For provision of the interface between AT 2000 and smoke detector control panel in accordance with VDE 0833 Part 2

Extension 12 in AT 2000 ITS-AT12IN

For extending the AT 2000 with 12 additional inputs (input lines)

12 in/out AT 2000 extension ITS-AT12IO

For extending the AT 2000 with 12 additional inputs (input lines) and 12 outputs (relay contacts)

UAE 8/8 junction box, surface mounted 2799181572

Necessary if transmission devices need to be connected in front of existing end units

Magnetic foot antenna with 2.6 m cable 4998131134

With FME connector, female, and coaxial cable pre-configured

Rod antenna with 20 m cable 4998131136

With FME connector, female, incl. mounting bracket for exterior and interior areas

Planar antenna 4998131137

With N-connector for exterior and interior areas, the connection cable can be ordered separately.

Antenna cable 20 m, pre-configured for planar antenna 4998131383

with N-plug and FME connector, female

Exterior antenna 4998059755

With 7/16 connector, the connection cable can be ordered separately

Antenna cable 20 m, pre-configured for exterior antenna 4998131688

with 7/16 plug and FME connector, female

Antenna cable 100 m, (low loss) 4998101363

LE = per roll 100 m, low-loss antenna cable

FME connector, female 4998097867

For antenna cable

AT 2000 IP ISDN Transmission System



7

Features

- ▶ **7 parallel inputs, 4 outputs (12 in/12 out optional)**
- ▶ **Programmable with PC software (WPAT)**
- ▶ **Transmission via IP networks and ISDN network**
- ▶ **Monitored virtual dedicated line and demand-driven connections via the IP network**
- ▶ **Supports ISDN PTP and PMP**
- ▶ **Monitoring of layer1 (ISDN constant monitoring)**
- ▶ **Tamper and blockade release (ISDN)**

The AT 2000 IP ISDN auto dialer and communicator handles the transmission of alarm or fault messages via IP networks. If the IP transmission path fails, the messages can be sent to a redundant central receiver via the ISDN network.

Functions

Network access	Transmission procedure	Transmission protocol	Receiver
Ethernet	UDP/IP	VdS 2465	Ethernet monitoring station
ISDN network (B-channel)	X.75 with 64 kBit/sec	VdS 2465	ISDN monitoring station
	Analog 10 baud	Telim	Analog monitoring station
	Data transmission to TAP/UCP server	Euromessage message, SMS plain text	Euromessage receiver, cell phone (D1/D2)
ISDN network (D-channel)	X.31 with transfer to X.25 network	VdS 2465	X.25-/X.31 monitoring station

Alarm messages and fault messages are transmitted via the IP network or via the ISDN network on the B or D-channel.

For message transmission via IP networks, a permanent virtual circuit (with polling) or a demand-driven connection (without polling) can be programmed.

The AT 2000 IP ISDN permits connection to multi-device and equipment connections (PMP/PTP) and is connected in front of telecommunications equipment and using a Telekom junction box to the telephone line.

In the event of tampering or damage to the relaying ISDN line, the AT 2000 can send a message (tamper release).

The absolute operating procedure on the telephone line is enabled by the blockade release.

Monitoring of the auto dialer and the telephone network occurs through a routine call.

The AT 2000 has a tamper contact.

Audio and visual display.

Power monitoring: network, battery, undervoltage

The event storage for up to 512 events can be read out using a PC.

Certifications and Approvals

Region	Certification	
Europe	CE	AT 2000 IP ISDN
Germany	VdS	G 104802 AT 2000 IP ISDN

Installation/Configuration Notes

IP permanent virtual circuit (VdS 2465 prot. (IP) with polling)

- The AT 2000 IP ISDN permits active monitoring of the connection to an IP receiver. Two IP centers with polling can be programmed (primary and backup receiver). In the event of a primary receiver fault, the device switches to the backup receiver.

- Connection monitoring is carried out via adjustable, cyclic polling between the AT 2000 IP ISDN and the IP receiver. In this way, faults in the transmission path are recognized and displayed on both sides. With a polling rate < 20 s there is constant line monitoring (quasi-dedicated line), which fulfills all VdS requirements for class C systems. Report transmission occurs if required.

IP demand-driven connection (VdS 2465 prot. (IP) without polling)

- The AT 2000 IP ISDN permits further IP centers to be programmed without polling. Transmission occurs if required. The test call can test the connection to the receiver (e.g. < 25 h).

IP receiver

- The ATE IP ISDN is available as a receiver.

IP connection (Ethernet)

- For the Ethernet connection of the AT 2000 IP ISDN, a category 5 cable or an 8-wire shielded network cable is required. It is connected to a network connection (shielded).

ISDN connection

- The direct connection is to the ISDN S₀ basic access with the ISDN-DSS1 protocol.
- Primary multiplex connection S2M is not possible.
- The AT 2000 IP ISDN communicator for danger alarms must be connected to the S₀ bus as the first device. With this connection it is possible for the AT 2000 IP ISDN to send a message even in the event of tampering or damage to the bus wiring.

ISDN PTP

- The "constant monitoring" layer 1 feature is present by default for system access.
- The max. cable length from network termination NT via the UAE 8/8 box to the TK system or to the end unit is 1000 m.

ISDN PMP

- The "constant monitoring" layer 1 feature is also required with a multi-system connection.
- The max. cable length between network termination and TK system or end unit is 150 m.

Fire detection technology

- Interface according to VDE 0833 part 2 can be provided **optionally**.

Parts Included

Type	Qty.	Component
AT 2000 IP ISDN Housing version	1	AT 2000 IP ISDN installation module with housing and power supply
AT 2000 IP ISDN Installation module	1	AT 2000 IP ISDN installation module for installation in control panel housing e.g. NZ 300 LSN

Technical Specifications

Housing version and installation module

Current consumption	
• Standby current	Approx. 216 mA
• Ethernet transmission	Approx. 216 mA
• ISDN transmission	Approx. 218 mA
• Additional current per activated relay	Approx. 12 mA
Terminal resistance of the primary line	10 kilohm ± 1%
Activation time	> 200 ms
Load on switch contacts	
• Max. output	30 W/60 VA (ohm resistive load)
• Max. voltage	50 V
Ambient temperature	-0 °C to +50 °C
Environmental class	II
Protection category	IP 40
Housing	
• Dimensions (H x W x D)	366 x 258 x 188 mm
• Color	Light gray
• Weight	10.0 kg
Power supply	
• Protection class	I
• Mains voltage	230 V (-15% to +10%)
• Mains frequency	50 Hz (±10%)
• Mains current consumption	200 mA
• Batteries (ordered separately)	12 V/2 x 10 Ah
• Backup time	Max. 72 hrs.
Ethernet module ATXPort	
Transmission	10/100 Mbit/sec

Ordering Information

AT 2000 IP ISDN, housing version With housing, power supply and AT 2000 IP ISDN installation module, for transmitting alarm or fault messages via the IP or ISDN network	4998116432
AT 2000 IP ISDN, installation module For installation in control panel housing, e.g. NZ 300 LSN, for transmitting alarm or fault messages via the IP or ISDN network	ITS-AT2000IP-P
Accessories	
Extension fire AT 2000 For provision of the interface between AT 2000 and smoke detector control panel in accordance with VDE 0833 Part 2	3902130697
Extension 12 in AT 2000 For extending the AT 2000 with 12 additional inputs (input lines)	ITS-AT12IN
12 in/out AT 2000 extension For extending the AT 2000 with 12 additional inputs (input lines) and 12 outputs (relay contacts)	ITS-AT12IO

Ordering Information

UAE 8/8 junction box, surface mounted	2799181572
Necessary if transmission devices need to be connected in front of existing end units	

Mounting kit AT 2000 (IP) in NZ 300 LSN	ITS-ATNZ300
For installing an AT 2000 installation module (and IP module) in NZ 300 LSN	

ATE TSN ISDN Alarm Receiver

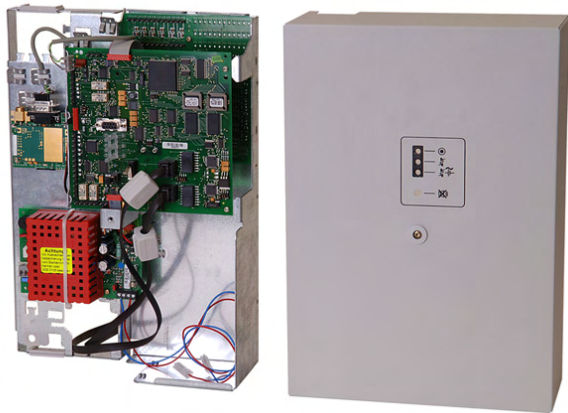

Features

- ▶ Receipt via ISDN B-channel or GSM network
- ▶ Receive protocol: VdS2465 (X.75, SMS, V.110)
- ▶ Installation variant for UGM 2020-EAPS6

The ATE TSN ISDN is an alarm receiver with alarm reception via the ISDN network and GSM radio network.

Functions

The ATE TSN ISDN is a pre-processing unit for receiving stations, which receives alarm messages via the ISDN and GSM network (SMS or V.110).

It handles the connection of the AT 2000 ISDN and AT 2000 TSN ISDN alarm communicators.

Alarm messages (VdS protocols) are received via the ISDN network on the B-channel or via the GSM module.

Programming of the ATE TSN ISDN is done using AT commands.

Certifications and Approvals

Region	Certification	
Europe	CE	ATE TSN ISDN
Germany	VdS	G 104808 ATE ISDN / TSN / IP

Installation/Configuration Notes

ISDN connection

- The ATE TSN ISDN can only be connected with an "exclusive" multi-system connection (PMP).
- The "constant monitoring" layer 1 feature is also required with a multi-system connection.
- The max. cable length between network termination and TK system or end unit is 150 m.

Antenna planning

- The antenna selection depends on the measured field strength. The antenna and the cable must be selected so that the measured attenuation on the AT 2000 does not exceed -87 dB.
- If the antenna is placed near an automatic fire or intrusion detector, the distance of the antenna to the detector must be at least 1 m.
- We generally recommend the use of a radiator (rod antenna for exterior and interior areas). If the reception level implemented with a radiator is insufficient, beam antennas (planar or exterior antennas for exterior and interior areas) should be used.
- With the installation of antennas outdoors, the relevant DIN VDE provisions, especially DIN VDE 0845 part 1 and VdS 2311 appendix F (protection against lightning) must be adhered to! The ground connection isolator set and the lightning protection set (optional) are designed for this.
- Make measurements precisely where the antenna will be mounted. The measurement results must remain stable for a period of 10 minutes.

Antenna	Gain	Cable attenuation	Comments
Magnet foot antenna	0 dBi (Entire system)		2.6 m fixed cable with FME connector, female
Rod antenna	3.5 dBi (Value without cable)	0.3 dB/m	With 20 m fixed cable, with FME connector, female
Planar antenna	8 dBi	According to cable type	Connection type N-connector
Exterior antenna	10 dBi	According to cable type	Connection type: 7/16 connector

Antenna cable

	Cable attenuation	Cable Ø	Comments
Standard cable	0.3 dB/m	Approx. 5 mm	Low loss cable
Aircom Plus (available separately)	0.15 dB/m	10.8 mm	SOHA

- If necessary, the pre-configured cables must be shortened in order to avoid unnecessary attenuation.
- The Aircom Plus cable must be used if the low-attenuation standard cable achieves no level better than -87 dBm.
- Applications must strictly adhere to the bending radius of at least 55 mm.

Product ID

4.998.066.838	Aircom Plus cable (SOHA)
4.998.066.839	Expansion module connector for the Aircom Plus cable (SOHA)

ATE installation module

- The ATE TSN ISDN installation module handles installation in the UGM 2020 EAPS6 alarm receipt central station. It serves to connect the alarm communicators AT 2000 ISDN and AT 2000 ISDN.
- For the installation of each installation module in a UGM, an SGK is required.
- Up to four ATE installation modules can be mounted on the ATE mounting kit in the UGM 2020, whereby max. 2 x ATE TSN ISDN or ATE IP ISDN or 4 x ATE ISDN are possible.

Parts Included

Type	Qty.	Component
ATE TSN ISDN Housing version	1	ATE installation module with housing and power supply unit incl. GSM module and RUBIN interface cable
ATE TSN ISDN (installation module) in UGM	1	ATE installation module incl. GSM module, EV-ATE cable, and SGK-ATE connection cable

Technical Specifications**Housing version and installation module**

Current consumption	
• Standby current	Approx. 120 mA
• Transmission mode	Approx. 280 mA
Ambient temperature	-0 °C to +50 °C
Environmental class	II
Protection category	IP 30
Housing	
• Dimensions (H x W x D)	366 x 258 x 188 mm
• Color	Light gray
• Weight	10.0 kg
Power supply	
• Protection class	I
• Mains voltage	230 V (-15% to ±10%)
• Mains frequency	50 Hz (±10%)
• Mains current consumption	200 mA
• Battery (order separately)	12 V/1 x 10 Ah
• Backup time	Max. 72 hours at 330 mA
Radio module	
GSM network	900/1800 MHz

Ordering Information**ATE TSN ISDN (installation module) in UGM 4998097821**

For installation in the UGM 2020-EAPS5/6 alarm receipt central station, for receiving alarm and fault messages via the ISDN and GSM network

Accessories**Mounting kit ATE in UGM 4998098656**

Up to four ATE installation modules can be mounted on the ATE mounting kit in the UGM 2020, whereby max. 2 x ATE TSN ISDN or ATE IP ISDN or 4 x ATE ISDN are possible.

Rod antenna with 20 m cable 4998131136

With FME connector, female, incl. mounting bracket for exterior and interior areas

Planar antenna 4998131137

With N-connector for exterior and interior areas, the connection cable can be ordered separately.

Magnetic foot antenna with 2.6 m cable 4998131134

With FME connector, female, and coaxial cable pre-configured

Antenna cable 20 m, pre-configured for planar antenna 4998131383

with N-plug and FME connector, female

Exterior antenna 4998059755

With 7/16 connector, the connection cable can be ordered separately

Antenna cable 20 m, pre-configured for exterior antenna 4998131688

with 7/16 plug and FME connector, female

Antenna cable 100 m, (low loss) 4998101363

LE = per roll 100 m, low-loss antenna cable

FME connector, female 4998097867

For antenna cable

FME connector, male 4998097868

For antenna cable

7/16 connector, male 4998097869

For antenna cable

N-connector, male 4998131687

For antenna cable

Lightning protection set 4998151211

For the AT with connection to an exterior antenna, lightning/voltage surge conductor for coaxial antenna systems of mobile radio systems (e.g. GSM or UMTS)

Wireless Local Security Network (wLSN)

8

wLSN Peripherie	430
wLSN Accessories	458

wLSN Hub



Features

- ▶ Provides control of the wLSN system through an integrated base station transceiver module
- ▶ Provides two-way communication with compatible control panels through a four-wire Option Bus interface
- ▶ Detects RF interference (intentional and unintentional) and reacts to implement countermeasures
- ▶ Manages a non-volatile database of status and configuration information for all sensor nodes in the network
- ▶ Supervised for cover and wall tamper conditions

The wLSN Hub acts as the link between the wireless Local SecurityNetwork (wLSN) devices and the control panel. The wLSN is a two-way communications system. The wLSN Hub communicates with the compatible control panels through a four-wire Option Bus interface and acts as the network master for the wLSN system. As the network master, the wLSN Hub provides network timing and synchronization, monitors sensor nodes and network status, and sends configuration data as required to the sensor nodes.

Certifications and Approvals

Region	Certification	
Europe	CE	1999/5/EC, IEC60950-1: 2001, EN60950-1:2001 +A11:2004, EN50130-4: 1996 +A1: 1998 +A2: 2003, EN61000-4-2: 1995 +A1: 1998 +A2: 2001, EN61000-4-3: 2002 +A1: 2003 +A2: 2005, EN61000-4-4: 1995 +A1: 2001 +A2: 2001, EN61000-4-5: 1995 +A1: 2001, EN61000-4-6: 1996 +A1: 2001 +A2: 2001 +A3: 2005, EN61000-4-11: 1994 +A1: 2001, EN55022/ANSI C63.4: 2003, ETSI EN 300 220-1 V1.3.1: 2000-09, ETSI EN 301 489-1 V1.4.1: 2002-08, ETSI EN 301 489-3 V1.4.1: 2002-08
Belgium	INCERT	B-509-0054
Listings and Approvals:	CE	
Complies with:		EN50131-1 Grade 2, Environmental class II

Installation/Configuration Notes

Compatibility Information

All wireless Local SecurityNetwork (wLSN) devices including the wLSN Hub are compatible with the Easy Series Control Panel.

Mounting Considerations

Mount the Hub on an interior wall or ceiling where it is protected from weather elements such as rain or snow, in a location that appears suitable for RF performance, and where it can be conveniently wired to the control panel.

Note Installation on metal surfaces can affect the RF propagation pattern of the radio transceiver.

The RF transceiver has a range of approximately 1000 m (3000 ft) in open air.

Parts Included

Quantity	Component
1	Hub
1	Hardware pack
1	Literature pack (language specific)

Technical Specifications

Environmental Considerations

Environment:	Indoor, dry
EN50131-1:	Environmental Class II
Relative Humidity:	Up to 95%, non-condensing
Temperature (operating):	-10°C to +55°C (+14°F to +131°F)

Mechanical Properties

Color:	Off-white
Dimensions (H x W x D):	8.1 cm x 10.0 cm x 3.1 cm (3.2 in. x 4.0 in. X 1.2 in.)

Power Requirements

Voltage (supply):	12 VDC nominal from control panel, 7.5 VDC to 15 VDC acceptable range
-------------------	--------------------------------------------------------------------------

Transmission and Reception Characteristics

Frequency:	European Security Band 868 MHz to 869 MHz
Range (open field):	1000 m (3000 ft)

Ordering Information

wLSN Hub (Czech) Serves as the link between the wireless Local SecurityNetwork (wLSN) devices and the control panel	ISW-BHB1-WXCS
wLSN Hub (German) Serves as the link between the wireless Local SecurityNetwork (wLSN) devices and the control panel	ISW-BHB1-WXDE
wLSN Hub (Danish) Serves as the link between the wireless Local SecurityNetwork (wLSN) devices and the control panel	ISW-BHB1-WXDA
wLSN Hub (English) Serves as the link between the wireless Local SecurityNetwork (wLSN) devices and the control panel	ISW-BHB1-WXEN
wLSN Hub (Spanish) Serves as the link between the wireless Local SecurityNetwork (wLSN) devices and the control panel	ISW-BHB1-WXES
wLSN Hub (Finnish) Serves as the link between the wireless Local SecurityNetwork (wLSN) devices and the control panel	ISW-BHB1-WXFI
wLSN Hub (French) Serves as the link between the wireless Local SecurityNetwork (wLSN) devices and the control panel	ISW-BHB1-WXFR
wLSN Hub (Greek) Serves as the link between the wireless Local SecurityNetwork (wLSN) devices and the control panel	ISW-BHB1-WXEL
wLSN Hub (Hungarian) Serves as the link between the wireless Local SecurityNetwork (wLSN) devices and the control panel	ISW-BHB1-WXHU
wLSN Hub (Italian) Serves as the link between the wireless Local SecurityNetwork (wLSN) devices and the control panel	ISW-BHB1-WXIT
wLSN Hub (Dutch) Serves as the link between the wireless Local SecurityNetwork (wLSN) devices and the control panel	ISW-BHB1-WXNL

Ordering Information

wLSN Hub (Norwegian) Serves as the link between the wireless Local SecurityNetwork (wLSN) devices and the control panel	ISW-BHB1-WXNO
wLSN Hub (Polish) Serves as the link between the wireless Local SecurityNetwork (wLSN) devices and the control panel	ISW-BHB1-WXPL
wLSN Hub (Portuguese) Serves as the link between the wireless Local SecurityNetwork (wLSN) devices and the control panel	ISW-BHB1-WXPT
wLSN Hub (Russian) Serves as the link between the wireless Local SecurityNetwork (wLSN) devices and the control panel	ISW-BHB1-WXRU
wLSN Hub (Swedish) Serves as the link between the wireless Local SecurityNetwork (wLSN) devices and the control panel	ISW-BHB1-WXSV
wLSN Hub (Turkish) Serves as the link between the wireless Local SecurityNetwork (wLSN) devices and the control panel	ISW-BHB1-WXTR

wLSN Relay Module



Features

- ▶ **Wiring terminals for one Form C relay rated 2 A at 30 VDC (resistive load)**
- ▶ **Wiring terminals for supervised sensor loop input with adjustable supervision interval**
- ▶ **Wiring terminals for connection of optional alternate power source (6 VDC to 14 VDC)**
- ▶ **Externally-visible LED indicates RF signal strength**
- ▶ **Determine suitability of chosen installation location with RF Signal Strength (RFSS) mode**
- ▶ **Supervised for low-battery, cover-tamper, and wall-tamper conditions**
- ▶ **Operates for up to 5 years on readily-obtainable AA batteries**

The wLSN Relay Module allows the control panel to switch outputs wirelessly by turning on or off a Form C relay. The wireless Local SecurityNetwork (wLSN) protocol allows multiple output devices, including the wLSN Relay Module, to be synchronized so that they all operate together using the same cadence.

The wLSN Relay Module also accepts a supervised sensor loop input from an external device.

Functions

Alternate Power Supply

An optional alternate external 6 VDC to 14 VDC power supply can be connected to the relay. The alternate power supply is used as a supplemental supply to power the relay.

Warning Do not operate the wLSN Relay Module without batteries.

RF Signal Strength Mode

Removing the device cover and pressing the tamper switch four times within 10 seconds of battery installation activates the RF signal strength mode. The LED lights steady for 5 sec and then begins to flash. A slow flash (approximately 1 sec on, 1 sec off) indicates insufficient signal reception. A quickly flashing LED (approximately five times as fast as the slow flash) indicates the device is receiving sufficient signal from the wLSN Hub.

Certifications and Approvals

Region	Certification	
Europe	CE	1999/5/EC, IEC60950-1: 2001, EN60950-1:2001 +A11:2004, EN50130-4: 1996+A1: 1998+A2:2003, EN61000-4-2: 1995 +A1: 1998 +A2: 2001, EN61000-4-3: 2002 +A1: 2003 +A2: 2005, EN61000-4-4: 1995 +A1: 2001 +A2: 2001, EN61000-4-5: 1995 +A1: 2001, EN61000-4-6: 1996 +A1: 2001 +A2: 2001 +A3: 2005, EN61000-4-11: 1994 +A1: 2001, EN55022/ANSI C63.4: 2003, ETSI EN 300 220-1 V1.3.1: 2000-09, ETSI EN 301 489-1 V1.4.1: 2002-08, ETSI EN 301 489-3 V1.4.1: 2002-08
Belgium	INCERT	B-509-0054
Listings and Approvals:	CE	
Complies with:		EN50131-1 Grade 2, Environmental class II

Installation/Configuration Notes

Compatibility Information

The wireless Local SecurityNetwork (wLSN) including the wLSN Relay Module is compatible with the Easy Series Control Panel.

Mounting Considerations

Mount the relay module on interior walls or ceilings where it is protected from weather elements such as rain or snow.

Note Installation on metal surfaces can affect the RF propagation pattern of the radio transceiver.

The RF transceiver has a range of approximately 1000 m (3000 ft) in open air. However, in normal operation, the actual RF range depends on building construction.

Parts Included

Quant.	Component
1	Relay module
4	AA batteries (P/N: 16556)
1	Hardware pack
1	Literature pack

Technical Specifications

Environmental Considerations

Environment:	Indoor, dry
EN50131-1:	Environmental Class II
Relative Humidity:	Up to 95%, non-condensing
Temperature (operating):	-10°C to +55°C (+14°F to +131°F)

Mechanical Properties

Color:	Off-white
Dimensions (H x W x D):	12.6 cm x 7.5 cm x 4.5 cm (5.0 in. x 3.0 in. x 1.8 in.)

Inputs

Type: One supervised sensor loop

Outputs

Relay: One Form C relay rated for 2 A at 30 VDC (resistive load)

Power Requirements

Battery Power

Battery Life:	Up to 5 years under normal operating conditions.
Battery Requirements:	Four AA Alkaline batteries
Recommended Replacements:	Duracell® MN1500 or PC1500, Eveready® E91, Panasonic® AM-3PIX/B

External Power Supply (optional)

Voltage (supply): 6 VDC to 14 VDC

Transmission and Reception Characteristics

Frequency:	European Security Band 868 MHz to 869 MHz
Range (open field):	1000 m (3000 ft)

Trademarks

Duracell® is a registered trademark of the Gillette Company, USA, in the United States and/or other countries.

Eveready® is a registered trademark of Eveready Battery Company, Inc.

Panasonic® is a registered trademark of a Matsushita Electric Industrial Co., Ltd.

Ordering Information

wLSN Relay Module

Allows the control panel to switch outputs wirelessly

ISW-BRL1-WX

wLSN Siren (Indoor)



Features

- ▶ Siren with an output level of 85 dBA at 3 m (10 ft)
- ▶ Wiring terminals for connection of optional alternate power source (6 VDC to 14 VDC)
- ▶ Externally-visible LED indicates test status and RF signal strength
- ▶ Determine suitability of chosen installation location with RF Signal Strength (RFSS) mode
- ▶ Supervised for low-battery, cover-tamper, and wall-tamper conditions
- ▶ Operates for up to 5 years on readily-obtainable AA batteries

The wLSN Siren (Indoor) is a wireless sounding device. The wireless Local SecurityNetwork (wLSN) protocol synchronizes multiple output devices in the same system so that they all sound together using the same cadence.

Functions

Alternate Power Supply

An optional alternate external 6 VDC to 14 VDC power supply can be connected to the siren. The alternate power supply is used as a supplemental supply to power the siren.

Warning Do not operate the wLSN Siren without batteries.

RF Signal Strength Mode

Removing the device cover and pressing the tamper switch four times within 10 seconds of battery installation activates the RF signal strength mode. The LED lights steady for 5 sec and then begins to flash. A slow flash (approximately 1 sec on, 1 sec off) indicates insufficient signal reception. A quickly flashing LED (approximately five times as fast as the slow flash) indicates the device is receiving sufficient signal from the wLSN Hub.

Use an an Alerting Device

The wLSN Siren produces an output level of 85 dB at 3 m (10 ft); thereby meeting the requirements of most certifying agencies for use as an alerting device. Verify that it meets the requirements of the local authority having jurisdiction (AHJ).

Certifications and Approvals

Region	Certification
Europe	CE 1999/5/EC, IEC60950-1: 2001, EN60950-1:2001 +A1:2004, EN50130-4: 1996 +A1: 1998 +A2: 2003, EN61000-4-2: 1995 +A1: 1998 +A2: 2001, EN61000-4-3: 2002 +A1: 2003 +A2: 2005, EN61000-4-4: 1995 +A1: 2001 +A2: 2001, EN61000-4-5: 1995 +A1: 2001, EN61000-4-6: 1996 +A1: 2001 +A2: 2001 +A3: 2005, EN61000-4-11: 1994 +A1: 2001, EN55022/ANSI C63.4: 2003, ETSI EN 300 220-1 V1.3.1: 2000-09, ETSI EN 301 489-1 V1.4.1: 2002-08, ETSI EN 301 489-3 V1.4.1: 2002-08
Belgium	INCERT B-509-0058

Listings and Approvals: **CE**

Complies with: EN50131-1 Grade 2, Environmental class II

Installation/Configuration Notes

Compatibility Information

The wireless Local SecurityNetwork (wLSN) including the wLSN Siren (Indoor) is compatible with the Easy Series Control Panel.

Mounting Considerations

Note The wall tamper cannot be used in corner mount installations.

Mount the siren on interior walls or ceilings where it is protected from weather elements such as rain or snow.

Note Installation on metal surfaces can affect the RF propagation pattern of the radio transceiver.

The RF transceiver has a range of approximately 1000 m (3000 ft) in open air. However, in normal operation, the actual RF range depends on building construction.

Parts Included

Quant.	Component
1	Siren
4	AA batteries (P/N: 16556)
1	Hardware pack
1	Literature pack

Technical Specifications

Environmental Considerations

Environment:	Indoor, dry
EN50131-1	Environmental Class II
Relative Humidity:	Up to 95%, non-condensing
Temperature (operating):	-10°C to +55°C (+14°F to +131°F)

Mechanical Properties

Color:	Off-white
Dimensions (H x W x D):	12.6 cm x 7.5 cm x 4.5 cm (5.0 in. x 3.0 in. x 1.8 in.)

Outputs

Sound::	85 dBA at 3 m (10 ft)
---------	-----------------------

Power Requirements

Battery Power

Battery Life:	Up to 5 years under normal operating conditions.
Battery Requirements:	Four AA Alkaline batteries
Recommended Replacements:	Duracell® MN1500 or PC1500, Eveready® E91, Panasonic® AM-3PIX/B

External Power Supply (optional)

Voltage (supply):	6 VDC to 14 VDC
-------------------	-----------------

Transmission and Reception Characteristics

Frequency:	European Security Band 868 MHz to 869 MHz
Range (open field):	1000 m (3000 ft)

Trademarks

Duracell® is a registered trademark of the Gillette Company, USA, in the United States and/or other countries.

Eveready® is a registered trademark of Eveready Battery Company, Inc.

Panasonic® is a registered trademark of a Matsushita Electric Industrial Co., Ltd.

Ordering Information

wLSN Siren (Indoor)
Wireless sounding device

ISW-BSR1-WX

wLSN Door-Window Contact



8

Features

- ▶ **Internal reed switches**
- ▶ **Supervised point input for an external dry-contact device that reports as a separate zone**
- ▶ **Determine suitability of chosen installation location with RF Signal Strength (RFSS) mode**
- ▶ **Supervised for low-battery, cover-tamper, and wall-tamper conditions**
- ▶ **Operates for up to 5 years on readily-obtainable AA batteries**

The wLSN Door-Window Contact provides magnetic reed contacts for monitoring doors and windows. The internal reed contacts (one on each side) are activated by an external magnet assembly which can be placed on either side. It also has built-in wall and cover tampers and a supervised point input for monitoring external devices.

Functions

RF Signal Strength Mode

Removing the device cover and pressing the tamper switch four times within 10 seconds of battery installation activates the RF signal strength mode. The LED lights steady for 5 sec and then begins to flash. A slow flash (approximately 1 sec on, 1 sec off) indicates insufficient signal reception. A quickly flashing LED (approximately five times as fast as the slow flash) indicates the device is receiving sufficient signal from the wLSN Hub.

Reed Contacts

There is a reed contact on either side of the device, so the magnet assembly can be mounted within 12.7 mm (0.5 in.) of the device on either side. When the distance between the magnet and the internal reed switch of the wLSN Door-Window Contact exceeds 12.7 mm (0.5 in.), an alarm signal is sent to the Hub and from there to the control panel.

Use as a Universal Point Transceiver

For use as a universal point transceiver, an external sensor loop is connected to the terminal block of the wLSN Door-Window Contact. An alarm signal from the sensor loop initiates an RF signal from the wLSN Door-Window Contact to the Hub. This signal is reported to the control panel as a separate address.

Certifications and Approvals

Region	Certification	
Europe	CE	1999/5/EC, IEC60950-1: 2001, EN60950-1:2001 +A1:2004, EN50130-4: 1996 +A1: 1998 +A2: 2003, EN61000-4-2: 1995 +A1: 1998 +A2: 2001, EN61000-4-3: 2002 +A1: 2003 +A2: 2005, EN61000-4-4: 1995 +A1: 2001 +A2: 2001, EN61000-4-5: 1995 +A1: 2001, EN61000-4-6: 1996 +A1: 2001 +A2: 2001 +A3: 2005, EN61000-4-11: 1994 +A1: 2001, EN55022/ANSI C63.4: 2003, ETSI EN 300 220-1 V1.3.1: 2000-09, ETSI EN 301 489-1 V1.4.1: 2002-08, ETSI EN 301 489-3 V1.4.1: 2002-08
Belgium	INCERT	B-509-0057

Listings and Approvals: **CE**

Complies with: EN50131-1 Grade 2, Environmental class II

Installation/Configuration Notes

Compatibility Information

The wireless Local SecurityNetwork (wLSN) including the wLSN Door-Window Contact is compatible with the Easy Series Control Panel.

Mounting Considerations

Mount the point transceiver on an interior door or window frame and the magnet assembly on the interior of the moving portion of the door or window where they are protected from weather elements such as rain or snow.

Note Installation on metal surfaces can affect the RF propagation pattern of the radio transceiver.

The RF transceiver has an RF range of approximately 1000 m (3000 ft) in open air.

Parts Included

Quant.	Component
1	Point transceiver
1	Magnet assembly
2	AA batteries (P/N: 16556)
1	Unit shim
1	Magnet shim
1	Hardware pack
1	Literature pack

Technical Specifications

Environmental Considerations

Environment:	Indoor, dry
EN50131-1:	Environmental Class II
Relative Humidity:	Up to 95%, non-condensing
Temperature (operating):	-10°C to +55°C (+14°F to +131°F)

Mechanical Properties

Color:	Off-white
--------	-----------

Dimensions (H x W x D)

Magnet Assembly:	6.7 cm x 2.1 cm x 1.8 cm (2.6 in. x 0.8 in. x 0.7 in.)
Point Transceiver and Reed Switch:	13.5 cm x 3.5 cm x 2.5 cm (5.3 in. x 1.4 in. x 1.0 in.)

Power Requirements

Battery Power

Battery Life:	Up to 5 years under normal operating conditions.
Battery Requirements:	Two AA Alkaline batteries
Recommended Replacements:	Duracell® MN1500 or PC1500, Eveready® E91, Panasonic® AM-3PIX/B
Voltage (supply):	2.3 VDC to 3.0 VDC

Transmission and Reception Characteristics

Frequency:	European Security Band 868 MHz to 869 MHz
Range (open field):	1000 m (3000 ft)

Trademarks

Duracell® is a registered trademark of the Gillette Company, USA, in the United States and/or other countries.

Eveready® is a registered trademark of Eveready Battery Company, Inc.

Panasonic® is a registered trademark of a Matsushita Electric Industrial Co., Ltd.

Ordering Information

wLSN Door-Window Contact

Provides magnetic reed contacts for monitoring doors and windows

ISW-BMC1-S135X

wLSN Smoke Detector for Europe



8

Features

- ▶ **Photoelectric beam obscuration smoke detector with a sensitivity of 0.14 ± 0.04 dB/m.**
- ▶ **Externally-visible LED indicates smoke detector status**
- ▶ **Supervised for low-battery and detector head removal conditions**

The wLSN Smoke Detector is a non-latching wireless detector that transmits alarm signals to the wLSN Hub using the wireless Local SecurityNetwork (wLSN) protocol.

Functions

Alarm Mode

When the detector goes into alarm mode, the detector's built-in sounder turns on steady and an RF signal indicating the alarm condition is sent to the wLSN Hub. The Hub signals the control panel identifying the specific detector in alarm. Alarm conditions are non-latching so if the alarm condition goes away – smoke dissipates – the detector returns to normal.

The photoelectric smoke detector acquires ambient obscuration data every 8 seconds. The red LED blinks every time a sample is taken. If any one sample is above the calibrated alarm threshold, two more samples are taken at 4-second intervals. If all three samples are above the calibrated alarm threshold, the detector goes into alarm mode.

Status Indicator

The LED and sounder indicate the status of the detector but not of the RF signaling circuitry. Refer to the *wLSN Reference Guide* (P/N: F01U009440) for details.

Test-Silence Button Operation

A Test-Silence Button allows performance of sounder and sensitivity tests and silencing of alarm sounder and trouble chirp. Refer to the *wLSN Reference Guide* (P/N: F01U009440) for details.

Certifications and Approvals

Region	Certification	
Europe	CE	1999/5/EC Radio Equipment and Telecommunications Terminal Equipment (annex V); IEC 60950-1: 2001; EN 60950-1:2001 +A11:2004; EN 50130-4: 1996 +A1: 1998 +A2: 2003; ETSI EN 300 220-1 V1.3.1:2000-09; ETSI EN 301 489-1 V1.4.1: 2002-08; ETSI EN 301 489-3 V1.4.1: 2002-08; EN 14604:2005; EN 55022/ANSI C63.4:2003; EN 61000-4-2:1995 +A1:1998 +A2:2001; EN 61000-4-3:2002 +A1:2003 +A2:2005; EN 61000-4-4:1995 +A1: 2001 +A2:2001; EN 61000-4-5:1995 +A1:2001; EN 61000-4-6:1996 +A1:2001 +A2:2001 +A3:2005; EN 61000-4-11:1994 +A1:2001 Sep 2008
Belgium	BOSEC	TCC2-H623

Installation/Configuration Notes

Compatibility Information

The wireless Local SecurityNetwork (wLSN) including the wLSN Smoke Detector is compatible with the Easy Series Control Panel.

Mounting Considerations

Mount smoke detectors on interior ceilings preferably at or near the center of the ceiling. Where mounting in the center of the ceiling is not practical, mount on the ceiling no closer than 10 cm (4 in.) to walls or corners or on an inside wall between 10 cm (4 in.) and 15 cm (6 in.) from the ceiling near the middle of the wall.

Note Do not mount smoke detectors on drop ceiling tiles. Mount to a metal runner. Since installation on metal surfaces can affect the RF propagation pattern of the radio transceiver, verify the suitability of the installation site using the wLSN Installation Tool before detector installation.

The RF transceiver has a range of approximately 1000 m (3000 ft) in open air. However, in normal operation, the actual RF range depends on building construction.

Parts Included

Quant.	Component
1	Smoke detector
2	Lithium batteries (P/N: 36092)
1	Dust cover
1	Hardware pack
1	Literature pack

Technical Specifications**Environmental Considerations**

Environment:	Indoor, dry; IP30
Relative Humidity:	Up to 90%, non-condensing
Temperature (operating):	+4°C to +38°C (+40°F to +100°F)

Mechanical Properties

Color:	Off-white
Dimensions (diameter x D):	14.2 cm x 6.1 cm (5.6 in. x 2.4 in.)

Outputs

Low Battery Chirp Rate:	1 chirp every 45 ± 2 sec
Sounder:	85 dBA at 3 m (10 ft) continuous

Power Requirements

Batteries:	Two 3-volt lithium (CR123A)
Battery Life:	Up to 5 years under normal operating conditions
Recommended Replacements:	SANYO CR123A, Panasonic CR123A, Duracell 123, VARTA CR123A

Transmission and Reception Characteristics

Frequency:	European Security Band 868 MHz to 869 MHz
Range (open field):	1000 m (3000 ft)

Trademarks

Trademark names are used throughout this document. In most cases, these designations are claimed as trademarks or registered trademarks in one or more countries by their respective owners. Rather than placing a trademark symbol in every occurrence of a trademark name, Bosch Security Systems, Inc. uses the names only in an editorial fashion and to the benefit of the trademark owner with no intention of infringing the trademark.

Duracell is a registered trademark of the Gillette Company, USA, in the United States and/or other countries.

Panasonic is a registered trademark of a Matsushita Electric Industrial Co., Ltd.

SANYO is a registered trademark of SANYO North America Corporation.

VARTA refers to VARTA Consumer Batteries GmbH & Co., a member of the Spectrum Brands family.

Ordering Information

wLSN Smoke Detector for Europe	ISW-BSM1-SX
Non-latching wireless detector for transmitting alarm signals to the wLSN Hub	

wLSN Glassbreak Detector



Features

- ▶ **DIP switches for selecting one of four glassbreak sensitivity settings**
- ▶ **Dual acoustic technology**
- ▶ **Externally-visible LEDs indicate alarm and event status; internal LED indicates RF signal strength**
- ▶ **Determine suitability of chosen installation location with RF Signal Strength (RFSS) mode**
- ▶ **Supervised for low-battery, cover-tamper, and wall-tamper conditions**
- ▶ **Operates for up to 2 years on readily-obtainable AA batteries**

The wLSN Glassbreak Detector is a wireless sensor device that detects breaking glass. It is equipped with two tamper switches and four glassbreak sensitivity settings.

Functions

Dual Acoustic Technology

When an object hits a pane of glass, the glass absorbs the blow and emits a low frequency sound pressure wave, called the flex wave. When the force of the blow is too great, glass shatters and emits a high frequency audio signal. A bell ringing or a vase breaking produces a similar audio signal, but does not produce a flex wave. The wLSN Glassbreak Detector detects the flex wave first and the audio signal second, reducing false alarms from items that only emit high frequency audio signals.

Glassbreak Sensitivity

Use the convenient DIP switches to select a sensitivity setting. There are two attack mode selections with multiple sensitivity settings.

RF Signal Strength Mode

Removing the device cover and pressing the tamper switch four times within 10 seconds of battery installation activates the RF signal strength mode. The LED lights steady for 5 sec and then begins to flash. A slow flash (approximately 1 sec on, 1 sec off) indicates insufficient signal reception. A quickly flashing LED (approximately five times as fast as the slow flash) indicates the device is receiving sufficient signal from the wLSN Hub.

Tamper Switches and Low Battery Indication

The wLSN Glassbreak Detector has a cover tamper switch and an optional wall tamper switch. When either tamper switch activates or when the battery power is low, the detector transmits tamper or low battery information to the wLSN Hub.

Test Mode

Activate the test mode locally using the test pads. When the detector is in test mode, use a Bosch 13-332 Sound Sensor Tester to verify that the detector detects flex wave and audio signals correctly.

Certifications and Approvals

Region	Certification
Europe	CE 1999/5/EC, IEC60950-1: 2001, EN60950-1:2001 +A11:2004, EN50130-4: 1996 +A1: 1998 +A2: 2003, EN61000-4-2: 1995 +A1: 1998 +A2: 2001, EN61000-4-3: 2002 +A1: 2003 +A2: 2005, EN61000-4-4: 1995 +A1: 2001 +A2: 2001, EN61000-4-5: 1995 +A1: 2001, EN61000-4-6: 1996 +A1: 2001 +A2: 2001 +A3: 2005, EN61000-4-11: 1994 +A1: 2001, EN55022/ANSI C63.4: 2003, ETSI EN 300 220-1 V1.3.1: 2000-09, ETSI EN 301 489-1 V1.4.1: 2002-08, ETSI EN 301 489-3 V1.4.1: 2002-08

Listings and Approvals: **CE**

Installation/Configuration Notes

Note Glassbreak detectors are intended only as a component of a perimeter protection system. They should always be used in conjunction with motion sensors.

Compatibility Information

The wireless Local SecurityNetwork (wLSN) including the wLSN Glassbreak Detector is compatible with the Easy Series Control Panel.

Acoustic Capabilities

The wLSN Glassbreak Detector can be used with the following glass types:

Glass Type	Glass Thickness
Plate	2.4 mm to 9.5 mm (0.09 in. to 0.38 in.)
Tempered	3.2 mm to 9.5 mm (0.13 in. to 0.38 in.)
Laminated*	3.2 mm to 14.3 mm (0.13 in. to 0.56 in.)
Wired	6.4 mm (0.25 in.)

* Protected only if both panes of unit are broken

Mounting Considerations

Mount the detector on interior walls or ceilings where it is protected from weather elements such as rain or snow. For the best performance, mount the detector within clear view of the glass (there is no minimum range) and within 7.6 m (25 ft) of the glass.

Note If the window is covered with heavy drapes, curtains, shades, blinds, and so on, mount the detector on the window frame.

Do not mount the detector:

- In a corner
- In rooms with loud equipment such as air compressors, bells, and power tools.
- On the same wall as the glass.
- On freestanding posts or pillars.

Note Installation on metal surfaces can affect the RF propagation pattern of the radio transceiver.

The RF transceiver has a range of approximately 1000 m (3000 ft) in open air. However, in normal operation, the actual RF range depends on building construction.

Parts Included

Quant.	Component
1	Glassbreak detector
2	AA batteries (P/N: 16556)
1	Hardware pack
1	Literature pack

Technical Specifications

Environmental Considerations

Environment:	Indoor, dry
Relative Humidity:	Up to 95%, non-condensing
Temperature (operating):	-10°C to +55°C (+14°F to +131°F)

Mechanical Properties

Color:	Off-white
Dimensions (H x W x D):	11.6 cm x 4.5 cm x 2.8 cm (4.6 in. x 4.2 in. x 1.25 in.)

Power Requirements

Battery Power

Battery Life:	Up to 2 years under normal operating conditions
Battery Requirements:	Two AA Alkaline batteries
Recommended Replacements:	Duracell® MN1500 or PC1500, Eveready® E91, Panasonic® AM-3PIX/B

Transmission and Reception Characteristics

Frequency:	European Security Band 868 MHz to 869 MHz
Range (open field):	1000 m (3000 ft)

Trademarks

Duracell® is a registered trademark of the Gillette Company, USA, in the United States and/or other countries.

Eveready® is a registered trademark of Eveready Battery Company, Inc.

Panasonic® is a registered trademark of a Matsushita Electric Industrial Co., Ltd.

Ordering Information

wLSN Glassbreak Detector

Wireless sensor device for detecting breaking glass

ISW-BGB1-SAX

wLSN Inertia Sensor



Features

- ▶ **Holding clip allows sensor pivoting in any direction enabling detector mounting in any orientation**
- ▶ **Minor and Gross Attack settings**
- ▶ **Option of using an internal reed switch with an external magnet assembly**
- ▶ **Externally-visible LED indicates operational sensitivity setting testing and RF signal strength**
- ▶ **Determine suitability of chosen installation location with RF Signal Strength (RFSS) mode**
- ▶ **Supervised for low-battery, cover-tamper, and wall-tamper conditions**
- ▶ **Operates for up to 5 years on readily-obtainable AA batteries**

The wLSN Inertia Detector is used for monitoring doors and windows. In addition to an inertia sensor, it has internal reed switches (one on each side) that can be used with an external magnet assembly.

Functions

Gross or Minor Attack Movement Settings

There are two settings (gross attack or minor attack) each of which has sensitivity adjustments.

If the minor attack setting is enabled, you can program for four or eight repetitive taps. Use the minor attack setting for sensitive areas.

If minor attack is disabled, the inertia sensor only reacts to major attack movement. The gross attack movement has four sensitivity settings.

RF Signal Strength Mode

Removing the device cover and pressing the tamper switch four times within 10 seconds of battery installation activates the RF signal strength mode. The LED lights steady for 5 sec and then begins to flash. A slow flash (approximately 1 sec on, 1 sec off) indicates insufficient signal reception. A quickly flashing LED (approximately five times as fast as the slow flash) indicates the device is receiving sufficient signal from the wLSN Hub.

Certifications and Approvals

Region	Certification	
Europe	CE	1999/5/EC, IEC60950-1: 2001, EN60950-1:2001 +A11:2004, EN50130-4: 1996+A1: 1998+A2:2003, EN61000-4-2: 1995 +A1: 1998 +A2: 2001, EN61000-4-3: 2002 +A1: 2003 +A2: 2005, EN61000-4-4: 1995 +A1: 2001 +A2: 2001, EN61000-4-5: 1995 +A1: 2001, EN61000-4-6: 1996 +A1: 2001 +A2: 2001 +A3: 2005, EN61000-4-11: 1994 +A1: 2001, EN55022/ANSI C63.4: 2003, ETSI EN 300 220-1 V1.3.1: 2000-09, ETSI EN 301 489-1 V1.4.1: 2002-08, ETSI EN 301 489-3 V1.4.1: 2002-08
Belgium	INCERT	B-509-0056
Listings and Approvals:	CE	
Complies with:		EN50131-1 Grade 2, Environmental class II

Installation/Configuration Notes

Compatibility Information

The wireless Local SecurityNetwork (wLSN) including the wLSN Inertia Detector is compatible with the Easy Series Control Panel.

Mounting Considerations

Mount the inertia detector on interior surfaces where it is protected from weather elements such as rain or snow. Orientation of the inertia sensor is critical to the proper operation of the inertia detection function.

When used, the magnet must be no farther away than 12 mm (0.5 in.) from the body of the inertia sensor for normal operation. The mounting base has markings for magnet alignment.

Note Installation on metal surfaces can affect the RF propagation pattern of the radio transceiver.

The RF transceiver has a range of approximately 1000 m (3000 ft) in open air. However, in normal operation, the actual RF range depends on building construction.

Parts Included

Quant.	Component
1	Inertia detector
1	Magnet assembly
2	AA batteries (P/N: 16556)
1	Unit shim
1	Magnet shims
1	Hardware pack
1	Literature pack

Technical Specifications

Environmental Considerations

Environment:	Indoor, dry
EN50131-1:	Environmental Class II
Relative Humidity:	Up to 95%, non-condensing
Temperature (operating):	-10°C to +55°C (+14°F to +131°F)

Mechanical Properties

Color:	Off-white
--------	-----------

Dimensions (H x W x D)

Transmitter:	13.5 cm x 3.5 cm x 2.5 cm (5.3 in. x 1.4 in. x 1.0 in.)
Magnet Assembly:	6.7 cm x 2.1 cm x 1.8 cm (2.6 in. x 0.8 in. x 0.7 in.)

Power Requirements

Battery Power

Battery Life:	Up to 5 years under normal operating conditions.
Battery Requirements:	Two AA Alkaline batteries
Recommended Replacements:	Duracell® MN1500 or PC1500, Eveready® E91, Panasonic® AM-3PIX/B
Voltage (supply):	2.3 VDC to 3.0 VDC

Transmission and Reception Characteristics

Frequency:	European Security Band 868 MHz to 869 MHz
Range (open field):	1000 m (3000 ft)

Trademarks

Duracell® is a registered trademark of the Gillette Company, USA, in the United States and/or other countries.

Eveready® is a registered trademark of Eveready Battery Company, Inc.

Panasonic® is a registered trademark of a Matsushita Electric Industrial Co., Ltd.

Ordering Information

wLSN Inertia Sensor

Provides an inertia sensor for monitoring doors and windows

ISW-BIN1-S135X

wLSN Dual Motion Detectors



8

Features

- ▶ **First Step processing (FSP), flexible mounting height, supervised microwave, and temperature compensation with no adjustment necessary**
- ▶ **Draft, insect, and pet and animal immunity**
- ▶ **Eight detection layers including look down zones**
- ▶ **Externally-visible LED indicates test status and RF signal strength**
- ▶ **Determine suitability of chosen installation location with RF Signal Strength (RFSS) mode**
- ▶ **Supervised for low-battery, cover-tamper, and wall-tamper conditions**
- ▶ **Operates up to 3.5 years on readily-obtainable AA batteries**

The wLSN Dual Motion Detectors are small, unobtrusive detectors that are simple to install and do not require field adjustments. They have a dense zone pattern with 79 zones in eight layers. Passive infrared and microwave processing provides excellent catch performance with freedom from false alarms. They are available with a choice of microwave frequency:

9.350 GHz	ISW-BDL1-W11PKX
10.525 GHz	ISW-BDL1-W11PGX
10.588 GHz	ISW-BDL1-W11PHX

Functions

Signal Processing

The detectors use passive infrared and microwave technologies to provide an alarm condition when both fields of protection are simultaneously activated. Alarm signals must meet the signaling requirements of both technologies to activate an alarm. Microwave range is factory set, but can be adjusted.

First Step Processing

First Step Processing (FSP) allows for instant response to human targets without sacrificing false alarm immunity to other sources. By adjusting its sensitivity based on signal amplitude, polarity, slope, and timing, FSP eliminates the need for the installer to select the sensitivity levels for the application.

Microwave Signal

Adaptive processing adjusts to background disturbances. This helps to reduce false alarms while maintaining catch performance.

Supervised Microwave

Patented fully-supervised microwave circuitry provides single technology (PIR) coverage in the event the microwave subsystem fails.

Pet and Animal Immunity

The detector is able to distinguish between signals caused by humans and signals caused by one or two animals with a combined total weight of 45 kg (99 lb). This provides immunity to false alarms while maintaining proper catch performance of human targets.

Draft and Insect Immunity

The sealed optical chamber provides immunity to drafts and insects.

Temperature Compensation

Automatically monitors the ambient temperature and adjusts the signal processing to maintain proper catch performance in critical temperature ranges.

RF Signal Strength Mode

Removing the device cover and pressing the tamper switch four times within 10 seconds of battery installation activates the RF signal strength mode. The LED lights steady for 5 sec and then begins to flash. A slow flash (approximately 1 sec on, 1 sec off) indicates insufficient signal reception. A quickly flashing LED (approximately five times as fast as the slow flash) indicates the device is receiving sufficient signal from the wLSN Hub.

Certifications and Approvals

Region	Certification	
Europe	CE	G and H models only: 1999/5/EC, IEC60950-1: 2001, EN60950-1:2001 +A11:2004, EN50130-4: 1996 +A1: 1998 +A2: 2003, EN61000-4-2: 1995 +A1: 1998 +A2: 2001, EN61000-4-3: 2002 +A1: 2003 +A2: 2005, EN61000-4-4: 1995 +A1: 2001 +A2: 2001, EN61000-4-5: 1995 +A1: 2001, EN61000-4-6: 1996 +A1: 2001 +A2: 2001 +A3: 2005, EN61000-4-11: 1994 +A1: 2001, EN55022/ANSIC63.4: 2003, ETSI EN 300 220-1 V1.3.1: 2000-09, EN 300 440-1 V1.3.1
Belgium	INCERT	G and H models only: B-509-0059 Complies with EN50131-1 Grade 2, Environmental class II

Installation/Configuration Notes

Compatibility Information

The wireless Local Security Network (wLSN) including the wLSN Dual Motion Detectors is compatible with the Easy Series Control Panel.

Coverage Patterns

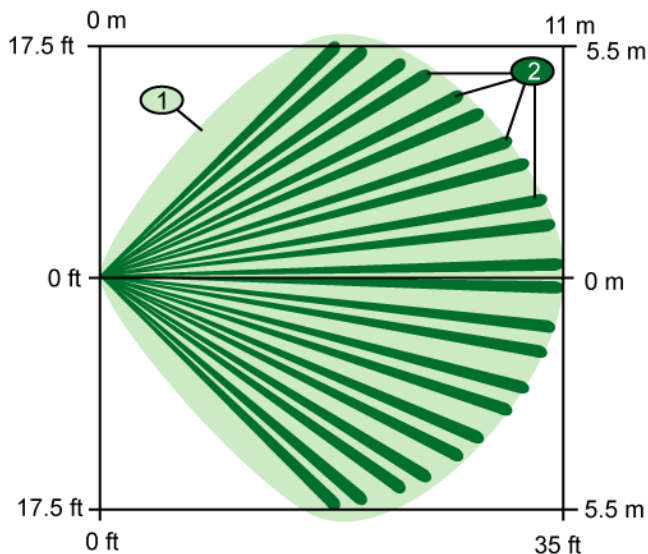

Top View Broad: 11 m x 11 m (35 ft x 35 ft)

- 1 Microwave coverage area
- 2 PIR coverage pattern

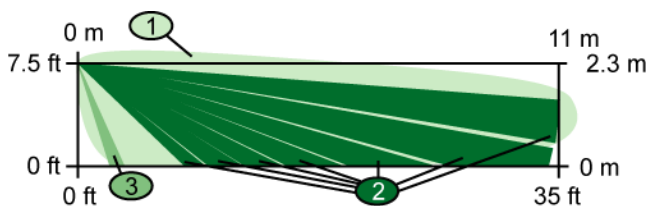

Side View Broad: 11 m x 11 m (35 ft x 35 ft)

- 1 Microwave coverage area
- 2 PIR coverage pattern
- 3 Look-down zone

Mounting Considerations

Note Installation on metal surfaces can affect the RF propagation pattern of the radio transceiver.

- Mount the detector so it is aimed where an intruder will most likely cross through the coverage pattern.
- Mount the detector on interior walls where it is protected from weather elements such as rain or snow.
- Mount the detector at any height between 2.3 m and 2.7 m (7.5 ft and 9 ft). The detector can be mounted:
 - On a flat wall (surface mount),
 - On a flat wall with the optional B335 Swivel-mount Bracket,
 - In the junction of two perpendicular walls (corner mount), or
 - On the ceiling with the optional B338 Ceiling-mount Bracket.

Note The wall tamper cannot be used in corner mount installations or with optional mounting brackets.

Note The use of optional mounting brackets can reduce the detector's range and increase the dead zone areas.

- The RF transceiver has a range of approximately 1000 m (3000 ft) in open air. However, in normal operation, the actual RF range depends on building construction and other factors.

Parts Included

Quant.	Component
1	Dual motion detector
6	AA batteries (P/N: 16556)
1	Hardware pack
1	Literature pack

Technical Specifications

Environmental Considerations

Environment:	Indoor, dry
EN50131-1:	Environmental Class II
Relative Humidity:	Up to 95%, non-condensing
Temperature (operating):	-10°C to +55°C (+14°F to +131°F)

Mechanical Properties

Color:	Off-white
Dimensions (H x W x D):	13.3 cm x 6.7 cm x 5.5 cm (5.2 in. x 2.6 in. x 2.2 in.)

Microwave Characteristics

Frequency: ISW-BDL1-W11PGX: 10.525 GHz
 ISW-BDL1-W11PHX: 10.588 GHz
 ISW-BDL1-W11PKX: 9.350 GHz

Range: 11 m (35 ft)

Power Requirements**Battery Power**

Battery Life: Up to 3.5 years under normal operating conditions.

Battery Requirements: Six AA Alkaline batteries

Recommended Replacements: Duracell® MN1500 or PC1500, Eveready® E91, Panasonic® AM-3PIX/B

Transmission and Reception Characteristics

Frequency: European Security Band
 868 MHz to 869 MHz

Range (open field): 1000 m (3000 ft)

Trademarks

Duracell® is a registered trademark of the Gillette Company, USA, in the United States and/or other countries.

Eveready® is a registered trademark of Eveready Battery Company, Inc.

Panasonic® is a registered trademark of a Matsushita Electric Industrial Co., Ltd.

Ordering Information

wLSN Dual Motion Detector (10.525 GHz) **ISW-BDL1-W11PGX**
 Wireless (868 MHz) motion detector uses passive infrared and microwave (10.525 GHz) for detection

wLSN Dual Motion Detector (10.588 GHz) **ISW-BDL1-W11PHX**
 Wireless (868 MHz) motion detector uses passive infrared and microwave (10.588 GHz) for detection

wLSN Dual Motion Detector (9.350 GHz) **ISW-BDL1-W11PKX**
 Wireless (868 MHz) motion detector uses passive infrared and microwave (9.350 GHz) for detection

Accessories

Swiveling B335-3 low-profile mount **B335-3**
 Swiveling, low-profile, plastic mount for wall mounting. The vertical swivel range is +10° to -20°, while the horizontal swivel range is ±25°. Available in triple packs.

wLSN PIR Motion Detector



Features

- ▶ **First Step processing (FSP), flexible mounting options, and temperature compensation**
- ▶ **Draft, insect, and pet and animal immunity**
- ▶ **Eight detection layers including look down zones**
- ▶ **Externally-visible LED indicates test status and RF signal strength**
- ▶ **Determine suitability of chosen installation location with RF Signal Strength (RFSS) mode**
- ▶ **Supervised for low-battery, cover-tamper, and wall-tamper conditions**
- ▶ **Operates up to 5 years on readily-obtainable AA batteries**

The wLSN PIR Motion Detector has a dense zone pattern with 79 zones in eight layers to provide superior catch performance. Ease of installation and flexible mounting options provide state-of-the-art detection every time.

Functions

First Step Processing

First Step Processing (FSP) allows virtually instant response to human targets without sacrificing false alarm immunity to other sources. By adjusting its sensitivity based upon signal amplitude, polarity, slope and timing, FSP eliminates the need for the installer to select the sensitivity level for the application.

Pet and Animal Immunity

The detector is able to distinguish between signals caused by humans and signals caused by one or two animals with a combined total weight of 14 kg (31 lb). This provides immunity to false alarms while maintaining proper catch performance of human targets.

Draft and Insect Immunity

The sealed optical chamber provides immunity to drafts and insects.

Temperature Compensation

Automatically monitors the ambient temperature and adjusts the signal processing to maintain proper catch performance in critical temperature ranges.

RF Signal Strength Mode

Removing the device cover and pressing the tamper switch four times within 10 seconds of battery installation activates the RF signal strength mode. The LED lights steady for 5 sec and then begins to flash. A slow flash (approximately 1 sec on, 1 sec off) indicates insufficient signal reception. A quickly flashing LED (approximately five times as fast as the slow flash) indicates the device is receiving sufficient signal from the wLSN Hub.

Certifications and Approvals

Region	Certification
Europe	CE 1999/5/EC, IEC60950-1: 2001, EN60950-1:2001 +A11:2004, EN50130-4: 1996 +A1: 1998 +A2: 2003, EN61000-4-2: 1995 +A1: 1998 +A2: 2001, EN61000-4-3: 2002 +A1: 2003 +A2: 2005, EN61000-4-4: 1995 +A1: 2001 +A2: 2001, EN61000-4-5: 1995 +A1: 2001, EN61000-4-6: 1996 +A1: 2001 +A2: 2001 +A3: 2005, EN61000-4-11: 1994 +A1: 2001, EN55022/ANSI C63.4: 2003, ETSI EN 300 220-1 V1.3.1: 2000-09, ETSI EN 301 489-1 V1.4.1: 2002-08, ETSI EN 301 489-3 V1.4.1: 2002-08
Belgium	INCERT B-509-0055
Listings and Approvals:	CE
Complies with:	EN50131-1 Grade 2, Environmental class II

Installation/Configuration Notes

Compatibility Information

The wireless Local Security Network (wLSN) including the wLSN PIR Motion Detector is compatible with the Easy Series Control Panel.

Coverage Patterns

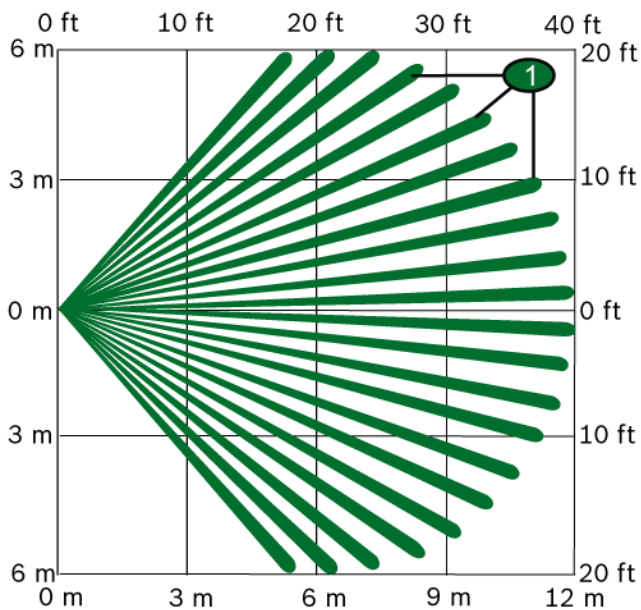

Top View Broad: 11 m x 11 m (35 ft x 35 ft)

1 PIR coverage pattern

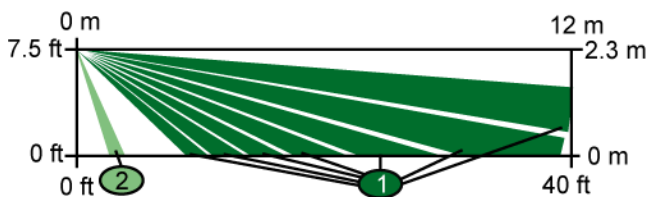

Side View Broad: 11 m x 11 m (35 ft x 35 ft)

1 PIR coverage pattern 2 Look-down zone

Mounting Considerations

Note Installation on metal surfaces can affect the RF propagation pattern of the radio transceiver.

- Mount the detector so it is aimed where an intruder will most likely cross through the coverage pattern.
- Mount the detector on interior walls where it is protected from weather elements such as rain or snow.
- Mount the detector at any height between 2.3 m and 2.7 m (7.5 ft and 9 ft). The detector can be mounted:
 - On a flat wall (surface mount),
 - On a wall with the optional B335 Swivel-mount Bracket,
 - In the junction of two perpendicular walls (corner mount), or
 - On the ceiling with the optional B338 Ceiling-mount Bracket.

Note The wall tamper cannot be used in corner mount installations or with optional mounting brackets.

Note The use of optional mounting brackets can reduce the detector's range and increase the dead zone areas.

- The RF transceiver has a range of approximately 1000 m (3000 ft) in open air. However, in normal operation, the actual RF range depends on building construction and other factors.

Parts Included

Quant.	Component
1	PIR detector
4	AA batteries (P/N: 16556)
1	Hardware pack
1	Literature pack

Technical Specifications

Environmental Considerations

Environment:	Indoor, dry
EN50131-1:	Environmental Class II
Relative Humidity:	Up to 95%, non-condensing
Temperature (operating):	-10°C to +55°C (+14°F to +131°F)

Mechanical Properties

Color:	Off-white
Dimensions (H x W x D):	12.2 cm x 6.2 cm x 5.2 cm (4.8 in. x 2.4 in. x 2.1 in.)

Power Requirements

Battery Power

Battery Life:	Up to 5 years under normal operating conditions.
Battery Requirements:	Four AA Alkaline batteries
Recommended Replacements:	Duracell® MN1500 or PC1500, Eveready® E91, Panasonic® AM-3PIX/B

Transmission and Reception Characteristics

Frequency:	European Security Band 868 MHz to 869 MHz
Range (open field):	1000 m (3000 ft)

Trademarks

Duracell® is a registered trademark of the Gillette Company, USA, in the United States and/or other countries.

Eveready® is a registered trademark of Eveready Battery Company, Inc.

Panasonic® is a registered trademark of a Matsushita Electric Industrial Co., Ltd.

Ordering Information**wLSN PIR Motion Detector**

Supports 79 zones in eight layers to provide superior catch performance

ISW-BPR1-W13PX

Accessories**Swiveling B335-3 low-profile mount**

Swiveling, low-profile, plastic mount for wall mounting. The vertical swivel range is +10° to -20°, while the horizontal swivel range is ±25°. Available in triple packs.

B335-3

wLSN Key Fob



Features

- ▶ **Small ergonomic design with protected, recessed buttons**
- ▶ **Energy saving power-down mode until a button is pressed**
- ▶ **Two programmable buttons can be used for lights, garage doors, or duress**
- ▶ **Two LEDs (one red, one green) for status; another (high-intensity blue) LED for use as a flashlight**
- ▶ **Supervised for low-battery condition**
- ▶ **Personalize the Key Fob with a choice of gasket color**
- ▶ **Operates for up to 5 years on readily-obtainable lithium button-cell batteries**

The wLSN Key Fob allows remote arming and disarming of a secure area. This key fob has two additional buttons that can be programmed to allow the user to control lights or garage doors and to provide a duress signal. Two status LEDs (one red, one green) indicate status and a high-intensity blue LED operates as a directional close-contact flashlight.

Certifications and Approvals

Region	Certification	
Europe	CE	1999/5/EC, IEC60950-1: 2001, EN60950-1:2001 +A11:2004, EN50130-4: 1996 +A1: 1998 +A2: 2003, EN61000-4-2: 1995 +A1: 1998 +A2: 2001, EN61000-4-3: 2002 +A1: 2003 +A2: 2005, EN61000-4-4: 1995 +A1: 2001 +A2: 2001, EN61000-4-5: 1995 +A1: 2001, EN61000-4-6: 1996 +A1: 2001 +A2: 2001 +A3: 2005, EN61000-4-11: 1994 +A1: 2001, EN55022/ANSI C63.4: 2003, ETSI EN 300 220-1 V1.3.1: 2000-09, ETSI EN 301 489-1 V1.4.1: 2002-08, ETSI EN 301 489-3 V1.4.1: 2002-08
Belgium	INCERT	B-509-0053
Listings and Approvals:	CE	
Complies with:		EN50131-1 Grade 2, Environmental class II

Installation/Configuration Notes

Compatibility Information

The wireless Local SecurityNetwork (wLSN) including the wLSN Key Fob is compatible with the Easy Series Control Panel.

Parts Included

Quant.	Component
1	Key fob assembled with red gasket
4	Rubber gaskets (black, green, orange, yellow)
2	Lithium batteries (P/N: 34522)
1	Literature pack

Technical Specifications

Environmental Considerations

Environment:	Intended to be connected to key rings, water resistant
EN50131-1:	Environmental Class II
Relative Humidity:	Up to 95%, non-condensing
Temperature (operating):	-10°C to +55°C (+14°F to +131°F)

Mechanical Properties

Color:	Charcoal-gray
Dimensions (H x W x D):	7.4 cm x 3.3 cm x 1.5 cm (2.9 in. x 1.3 in. x 0.58 in.)

Power Requirements**Battery Power**

Battery Life:	Up to 5 years under normal operating conditions.
Battery Requirements:	Two lithium button-cell batteries
Recommended Replacements:	Duracell® DL2032, Eveready® ECR2032, Maxell™ CR2032, Panasonic® CR2032, Rayovac® KECR2032, SANYO® CR2032, Toshiba CR2032, VARTA CR2032
Voltage (supply):	2.3 VDC to 3.0 VDC

Transmission and Reception Characteristics

Frequency:	European Security Band 868 MHz to 869 MHz
Range (open field):	1000 m (3000 ft)

Trademarks

Duracell® is a registered trademark of the Gillette Company, USA, in the United States and/or other countries.

Eveready® is a registered trademark of Eveready Battery Company, Inc.

Maxell™ is a trademark of Maxell Corporation of America (MCA), Inc., a wholly owned subsidiary of Hitachi Maxell, Ltd. (Hitachi Maxell), based in Osaka, Japan.

Panasonic® is a registered trademark of a Matsushita Electric Industrial Co., Ltd.

Rayovac® and VARTA are marks of Spectrum Brands, its subsidiaries, and/or its affiliates.

SANYO® is a registered trademark of SANYO North America Corporation.

Toshiba refers to Toshiba America, Inc. (TAI), a subsidiary of Toshiba Corporation based in Tokyo, Japan.

VARTA refers to VARTA Consumer Batteries GmbH & Co., a member of the Spectrum Brands family.

Ordering Information**wLSN Key Fob**

Allows remote arming and disarming of a secure area

ISW-BKF1-H5X

wLSN Mini Door-Window Contact



8

Features

- ▶ **Small size for less conspicuous installation**
- ▶ **Determine suitability of chosen installation location with RF Signal Strength (RFSS) mode**
- ▶ **Supervised for low-battery, cover-tamper, and wall-tamper conditions**
- ▶ **Operates for up to 3 years on a readily-obtainable lithium battery**

The wLSN Mini Door-Window Contact is approximately 60% the size of the standard contact for monitoring doors and windows. It contains an internal reed contact activated by the external magnet assembly. It also has a built-in wall and cover tamper.

Functions

RF Signal Strength Mode

Removing the device cover and pressing the tamper switch four times within 10 seconds of battery installation activates the RFSS mode. The LED lights steady for 5 sec and then begins to flash. A slow flash (approximately 1 sec on, 1 sec off) indicates insufficient signal reception. A quickly flashing LED (approximately five times as fast as the slow flash) indicates the device is receiving sufficient signal from the wLSN Hub.

Certifications and Approvals

Region	Certification	
Europe	CE	1999/5/EC, IEC60950-1: 2001, EN60950-1:2001 +A11:2004, EN50130-4: 1996 +A1: 1998 +A2: 2003, EN61000-4-2: 1995 +A1: 1998 +A2: 2001, EN61000-4-3: 2002 +A1: 2003 +A2: 2005, EN61000-4-4: 1995 +A1: 2001 +A2: 2001, EN61000-4-5: 1995 +A1: 2001, EN61000-4-6: 1996 +A1: 2001 +A2: 2001 +A3: 2005, EN61000-4-11: 1994 +A1: 2001, EN55022/ANSI C63.4: 2003, ETSI EN 300 220-1 V1.3.1: 2000-09, ETSI EN 301 489-1 V1.4.1: 2002-08, ETSI EN 301 489-3 V1.4.1: 2002-08
Belgium	INCERT	B-509-0057
Listings and Approvals:	CE	
Complies with:		EN50131-1 Grade 2, Environmental class II

Installation/Configuration Notes

Compatibility Information

The wireless Local Security Network (wLSN) including the wLSN Mini Door-Window Contact is compatible with the Easy Series Control Panel.

Mounting Considerations

Mount the contact assembly on an interior door or window frame and the magnet assembly on the interior of the moving portion of the door or window where they are protected from weather elements such as rain or snow.

Note Installation on metal surfaces can affect the RF propagation pattern of the radio transceiver.

The RF transceiver has an RF range of approximately 1000 m (3000 ft) in open air.

Parts Included

Quant.	Component
1	Contact assembly with RF transceiver
1	Magnet assembly
1	3 V CR2 lithium battery (P/N: 33039)
1	Unit shim
2	Magnet bottom shims
1	Hardware pack
1	Literature pack

Technical Specifications

Environmental Considerations

Environment:	Indoor, dry
EN50131-1:	Environmental Class II
Relative Humidity:	Up to 95%, non-condensing
Temperature (operating):	-10°C to +55°C (+14°F to +131°F)

Mechanical Properties

Color:	Off-white
--------	-----------

Dimensions (H x W x D)

Contact Assembly:	82 mm x 22 mm x 20 mm (3.2 in. x 0.9 in. x 0.8 in.)
Magnet Assembly:	24.5 mm x 19 mm x 13 mm (1 in. x 0.7 in. x 0.5 in.)

Power Requirements

Battery Power

Battery Life:	Up to 3 years under normal operating conditions.
Battery Requirements:	One CR2 lithium battery
Recommended Replacements:	Duracell® CR2, Panasonic® CR2, SANYO® CR2
Voltage (supply):	2.3 VDC to 3.0 VDC

Transmission and Reception Characteristics

Frequency:	European Security Band 868 MHz to 869 MHz
Range (open field):	1000 m (3000 ft)

Trademarks

Duracell® is a registered trademark of the Gillette Company, USA, in the United States and/or other countries.

Panasonic® is a registered trademark of a Matsushita Electric Industrial Co., Ltd.

SANYO® is a registered trademark of SANYO North America Corporation.

Ordering Information

wLSN Mini Door-Window Contact	ISW-BMC1-M82X
60% the size of the standard contact for monitoring doors and windows	

wLSN Recessed Door-Window Contact



8

Features

- ▶ **Internal reed switch**
- ▶ **Designed for recessed installation into doors and door frames or windows and window frames**
- ▶ **Determine suitability of chosen installation location with RF Signal Strength (RFSS) mode**
- ▶ **Supervised for low-battery and cover-tamper conditions**
- ▶ **Operates for up to 3 years on a readily-obtainable lithium battery**

The wLSN Recessed Door-Window Contact provides a magnetic reed contact for monitoring doors and windows. It contains an internal reed contact activated by the external magnet assembly. It also has a built-in cover tamper.

Functions

RF Signal Strength Mode

Removing the device cover and pressing the tamper switch four times within 10 seconds of battery installation activates the RFSS mode. The LED lights steady for 5 sec and then begins to flash. A slow flash (approximately 1 sec on, 1 sec off) indicates insufficient signal reception. A quickly flashing LED (approximately five times as fast as the slow flash) indicates the device is receiving sufficient signal from the wLSN Hub.

Certifications and Approvals

Region	Certification	
Europe	CE	1999/5/EC, IEC60950-1: 2001, EN60950-1:2001 +A11:2004, EN50130-4: 1996 +A1: 1998 +A2: 2003, EN61000-4-2: 1995 +A1: 1998 +A2: 2001, EN61000-4-3: 2002 +A1: 2003 +A2: 2005, EN61000-4-4: 1995 +A1: 2001 +A2: 2001, EN61000-4-5: 1995 +A1: 2001, EN61000-4-6: 1996 +A1: 2001 +A2: 2001 +A3: 2005, EN61000-4-11: 1994 +A1: 2001, EN55022/ANSI C63.4: 2003, ETSI EN 300 220-1 V1.3.1: 2000-09, ETSI EN 301 489-1 V1.4.1: 2002-08, ETSI EN 301 489-3 V1.4.1: 2002-08
Belgium	INCERT	B-509-0057
Listings and Approvals:	CE	
Complies with:		EN50131-1 Grade 2, Environmental class II

Installation/Configuration Notes

Compatibility Information

The wireless Local Security Network (wLSN) including the wLSN Recessed Door-Window Contact is compatible with the Easy Series Control Panel.

Mounting Considerations

Mount the contact assembly into an interior door or window frame and the magnet assembly into the interior of the moving portion of the door or window where they are protected from weather elements such as rain or snow.

Note Installation on metal surfaces can affect the RF propagation pattern of the radio transceiver.

The RF transceiver has an RF range of approximately 1000 m (3000 ft) in open air.

Parts Included

Quant.	Component
1	Contact assembly with RF transceiver
1	Magnet assembly
1	3 V CR2 lithium battery (P/N: 33039)
1	Hardware pack
1	Literature pack

Technical Specifications

Environmental Considerations

Environment:	Indoor, dry
EN5013-1:	Environmental Class II
Relative Humidity:	Up to 95%, non-condensing
Temperature (operating):	-10°C to +55°C (+14°F to +131°F)

Mechanical Properties

Color:	Off-white
--------	-----------

Dimensions (H x W x D)

Contact Assembly:	105 mm deep x 19 mm diameter (4.125 in. deep x 0.75 in. diameter)
Magnet Assembly:	1.3 mm deep x 19 mm diameter (0.5 in. deep x 0.75 in. diameter)

Power Requirements

Battery Power

Battery Life:	Up to 3 years under normal operating conditions.
Battery Requirements:	One CR2 lithium battery
Recommended Replacements:	Duracell® CR2, Panasonic® CR2, SANYO® CR2
Voltage (supply):	2.3 VDC to 3.0 VDC

Transmission and Reception Characteristics

Frequency:	European Security Band 868 MHz to 869 MHz
Range (open field):	1000 m (3000 ft)

Trademarks

Duracell® is a registered trademark of the Gillette Company, USA, in the United States and/or other countries.

Panasonic® is a registered trademark of a Matsushita Electric Industrial Co., Ltd.

SANYO® is a registered trademark of SANYO North America Corporation.

Ordering Information

wLSN Recessed Door-Window Contact **ISW-BMC1-R135X**

Designed for recessed installation into doors and door frames or windows and window frames

wLSN Water Sensor/ Low-temperature Sensor



8

Features

- ▶ Detects a water puddle with a minimum 77 mm (3 in.) diameter and 2.5 mm (0.1 in.) depth
- ▶ Sends a signal to the wLSN Hub in approximately 5 seconds from when the probe is submerged in water
- ▶ If enabled, sends a signal to the wLSN Hub when the device temperature drops below +7°C (+45°F)
- ▶ Provides a Detector Status LED (green)
- ▶ Uses RF Signal Strength (RFSS) mode to determine suitability of chosen installation location
- ▶ Provides supervision for low-battery, cover-tamper, and wall-tamper conditions
- ▶ Operates for up to 3.5 years on readily-obtainable AA batteries

The wLSN Water Sensor/Low-temperature Sensor detects water spilled or leaking onto a solid surface. Use it in security systems for monitoring hot water heaters, clothes washers, basement water (sump pump failures) and refrigerator water leaks. It can also be used to monitor temperature to warn of potential water pipe freezing.

Note The water sensor is not intended to monitor water levels in storage tanks or liquids other than water, nor is it intended to be permanently submerged in water and detect the absence of water.

Functions

RF Signal Strength (RFSS) Mode

The RFSS mode provides the ability to evaluate RF signal strength between the wLSN Hub and devices before, during, and after installation. Device LEDs flash to indicate the level of signal quality and, if used, the wLSN Installation Tool indicates signal strength.

Water Probe

As provided, the water probe has 2 m (6 ft) long leads which connect to the transceiver module through a two position, plug-in style terminal block within the transceiver module enclosure. Lead length can be shortened to meet the needs of a particular installation.

Low-temperature Sensor

Monitors the air temperature at the transceiver module housing (not at the water probe) and sends a signal to the wLSN Hub when the temperature falls below +7°C (+45°F) for more than 30 seconds.

Certifications and Approvals

Region	Certification
Europe	CE 2004/108/EC; 2006/95/EC; EN 60950-1:2001 +A11:2004; EN 50130-4:1996 +A1:1998 +A2:2003; EN 55022:1998 +A2:2003; ANSI C63.4:2003; EN 301-489 V1.4.1 (2002-08); EN300 220-1 V1.3.1 (2000-09)

Installation/Configuration Notes

Compatibility Information

The wLSN Water Sensor is compatible with the Easy Series Control Panel, release 3.1 or later, and the wLSN Hub, release 3.0 or later.

Note Compatibility with Easy Series Control Panel version 2.5 requires the installer to change the point type to "24-Hour" (from "Perimeter").

Mounting Considerations

Mount the water sensors on interior walls or other hard surfaces where they are protected from weather elements such as rain or snow. Mount the water probe where a risk of puddling is anticipated.

Note Installation on metal surfaces or installation where large metallic objects are between the transceiver and the wLSN Hub can affect the RF propagation pattern of the radio transceiver.

The RF transceiver has an RF range of approximately 1000 m (3000 ft) in open air. In normal operation, the actual RF range depends on building construction and other factors.

Parts Included

Quant.	Component
1	Transceiver module (batteries included)
1	Water probe
1	Hardware pack
1	Literature

Technical Specifications

Environmental Considerations

Environment:	Indoor, dry
EN50131-1:	Environmental Class II
Relative Humidity:	Up to 95%, non-condensing
Temperature (operating):	-10°C to +55°C (+14°F to +131°F)

Mechanical Properties

Color:	Off-white
--------	-----------

Dimensions (H x W x D)

Transceiver Module:	13.5 cm x 3.5 cm x 2.5 cm (5.3 in. x 1.4 in. x 1.0 in.)
Water Probe:	2.3 cm x 5.1 cm x 0.6 cm with 2 m leads (0.9 in. x 2.0 in. x 0.25 in.) with 6 ft leads

Power Requirements

Battery Power

Battery Life:	Up to 3.5 years under normal operating conditions.
Battery Requirements:	Two AA Alkaline batteries
Recommended Replacements:	Duracell MN1500 or PC1500, Eveready E91, Panasonic AM-3PIX/B
Voltage (supply):	2.3 VDC to 3.0 VDC

Transmission and Reception Characteristics

Frequency:	European Security Band 868 MHz to 869 MHz
Range (open field):	1000 m (3000 ft)

Trademarks

Trademark names are used throughout this document. In most cases, these designations are claimed as trademarks or registered trademarks in one or more countries by their respective owners. Rather than placing a trademark symbol in every occurrence of a trademark name, Bosch Security Systems, Inc. uses the names only in an editorial fashion and to the benefit of the trademark owner with no intention of infringing the trademark.

Duracell is a registered trademark of the Gillette Company, USA, in the United States and/or other countries.

Eveready is a registered trademark of Eveready Battery Company, Inc.

Panasonic is a registered trademark of a Matsushita Electric Industrial Co., Ltd.

Ordering Information

wLSN Water Sensor/Low-temperature Sensor	ISW-BWL1-SX
Detects water spilled or leaking onto a solid surface and monitors temperature to warn of potential water pipe freezing	

wLSN Installation Tool



Features

- ▶ **Powered by rechargeable batteries**
- ▶ **Docking stations provide power source (6 VDC to 14 VDC) for battery recharging**
- ▶ **Externally-visible LED indicates charging status**
- ▶ **Battery saving mode**
- ▶ **Displays low-battery status**
- ▶ **Ensures reliable RF communications at chosen device locations prior to permanently mounting a device**

The wLSN Installation Tool is an alphanumeric liquid crystal display (LCD) keypad that works with the wLSN Hub to assist the installer in evaluating the suitability of a particular site for the installation of wireless devices and for verifying the acceptability of specific locations for the placement of wireless devices. The installation tool has a two-line, 16-character text display and a sounder. The installation tool also has a green LED for indicating battery charging status. The installation tool comes with a plug-in transformer and two docking stations: one for wall mounting; the other is a desktop cradle.

Functions

Diagnostic Modes

Use the wLSN Installation Tool as a pre-installation tool for determining the suitability of a particular site for wireless applications or to validate individual device RF performance prior to permanent mounting. In other words, the wLSN Installation Tool provides assurance that a device installed at the chosen location can communicate reliably with the wLSN Hub.

The wLSN Installation Tool has three user-selectable modes:

1. **Go/No Go:** indicates whether or not the tool is receiving a signal from the wLSN Hub of sufficient strength to ensure reception by a wireless device located at that site
2. **Packet Success Rate:** indicates signal strength by the number of bars shown and the number of packets received by the tool (three packets are sent from the wLSN Hub every four seconds). The best location for placing a device is the one showing the highest number of bars and packets received.
3. **Signal-to-Noise Ratio:** provides separate readings for received signal strength, ambient noise level, and signal-to-noise ratio. The higher the signal-to-noise-ratio; the better the location.

Fixed Operation

When placed into a docking station, the wLSN Installation Tool is powered from the docking station through a cable and wall transformer. While the tool is in the docking station, the batteries are automatically recharged. The green status LED on the tool indicates the charging status of the batteries whenever the tool is in the docking station:

- Continuously on indicates fully-charged batteries
- Slow flashing indicates batteries are being recharged
- Off indicates the installation tool is not connected to the recharging circuit

Mobile Operation

When removed from the docking station, the tool automatically switches to mobile operating mode wherein it is powered by its batteries and goes into a sleep mode after a preset duration of inactivity. The tool automatically wakes up from sleep mode whenever a button is pressed.

Certifications and Approvals

Region	Certification	
Europe	CE	1999/5/EC, IEC60950-1: 2001, EN60950-1:2001 +A1:2004, EN50130-4: 1996 +A1: 1998 +A2: 2003, EN61000-4-2: 1995 +A1: 1998 +A2: 2001, EN61000-4-3: 2002 +A1: 2003 +A2: 2005, EN61000-4-4: 1995 +A1: 2001 +A2: 2001, EN61000-4-5: 1995 +A1: 2001, EN61000-4-6: 1996 +A1: 2001 +A2: 2001 +A3: 2005, EN61000-4-11: 1994 +A1: 2001, EN55022/ANSI C63.4: 2003, ETSI EN 300 220-1 V1.3.1: 2000-09, ETSI EN 301 489-1 V1.4.1: 2002-08, ETSI EN 301 489-3 V1.4.1: 2002-08

Listings and Approvals: **CE**

Complies with: EN50131-1 Grade 2, Environmental class II

Installation/Configuration Notes

Compatibility Information

The wLSN Installation Tool requires the wLSN Hub to operate and provide installation information.

Mounting Considerations

The required region-specific transformers have 1.8 m (6 ft) cords. Position the docking units near a wall outlet in order to plug in the transformer.

Note Refer to the *wLSN Installation Tool Installation Instructions* (P/N: F01U008748) for instructions on connecting the transformers to the docking stations.

Mount the wall-mount docking station to an interior wall and/or place the desktop docking station on a flat surface. The docking stations must be protected from weather elements such as rain or snow and from accidental exposure to spills or leaks.

Parts Included

Quant.	Component
1	Installation tool
1	Transformer (region specific) ¹
2	Docking stations (wall and desktop)
3	AAA (NiMH) batteries (P/N: 16556)
1	Hardware pack
1	Literature pack

¹Each installation tool is supplied with a region-specific transformer designed to be wired to either of the docking stations and to plug into the local electrical outlet. Refer to the following for transformer illustrations:

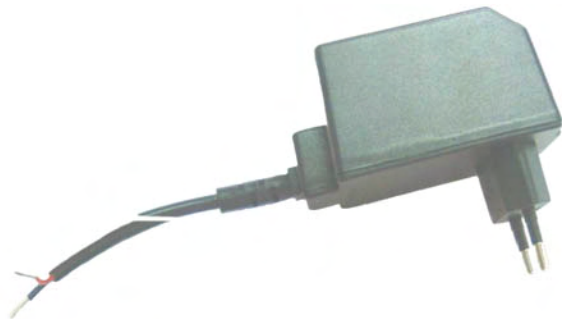

European transformer (A) supplied with ISW-BIT1-HAX



United Kingdom transformer (B) supplied with ISW-BIT1-HBX

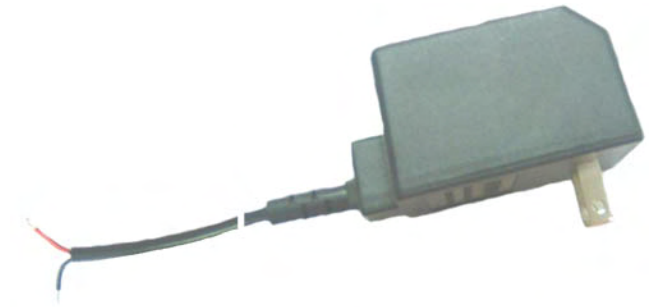

United States transformer (C) supplied with ISW-BIT1-HCX

Technical Specifications

Environmental Considerations

Environment:	Indoor, dry
EN50131-1:	Environmental Class II
Relative Humidity:	Up to 95%, non-condensing
Temperature (operating):	-10°C to +55°C (+14°F to +131°F)

Mechanical Properties

Color:	Off-white
Dimensions (H x W x D):	12.6 cm x 7.5 cm x 4.5 cm (5.0 in. x 3.0 in. x 1.8 in.)

Power Requirements

Battery Power

Battery Life:	Up to 50 hr of continuous use on a single charge.
Battery Requirements:	Three AAA nickel-metal hydride (NiMH) rechargeable batteries
Recommended Replacements:	SANYO® HR-AAAU
Recharge Time:	Requires 7 hr to recharge fully depleted batteries

External Power Supply (Docking Module)

Voltage (supply):	6 VDC to 14 VDC
-------------------	-----------------

Reception Characteristics

Frequency:	European Security Band 868 MHz to 869 MHz
------------	----------------------------------------------

Transformers

All Transformer Models

Current (output):	0.33 A
Power:	8 W
Voltage (output):	with load: 9.0 VDC ± 5%

ISW-BIT1-HAX (United Kingdom Transformer)

Frequency:	50 Hz
Voltage (input):	230 VAC to 240 VAC
Voltage (output):	without load: 15.0 VDC ± 5%

ISW-BIT1-HBX (European Transformer)

Frequency:	50 Hz
Voltage (input):	230 VAC to 240 VAC
Voltage (output):	without load: 16.5 VDC \pm 5%

ISW-BIT1-HCX (United States Transformer)

Frequency:	60 Hz
Voltage (input):	120 VAC
Voltage (output):	without load: 13.5 VDC \pm 5%

Trademarks

SANYO® is a registered trademark of SANYO North America Corporation.

Ordering Information**wLSN Installation Tool (EU)**

Assists the installer in evaluating suitability and location of wireless devices at a site

ISW-BIT1-HAX**wLSN Installation Tool (UK)**

Assists the installer in evaluating suitability and location of wireless devices at a site

ISW-BIT1-HBX

DSRF Premises Wireless

9

Bosch DSRF Receivers	462
Bosch DSRF Transmitters	468

RF3212 Series RF Receivers



Features

- ▶ **Receives low battery, tamper, and sensor status reports**
- ▶ **LED indicates receiver status**
- ▶ **Cover tamper with optional wall tamper**
- ▶ **Diversity antennas**

The RF3212 Series RF Receivers include the following models:

Model	RF Transmission
RF3212	304.00 MHz
RF3212E	433.42 MHz

Each model allows Bosch I/P bus control panels to receive RF signals from wireless devices. The wireless devices save time for busy installers and homeowners and the receivers are a valuable option for system users who want additional security without disruptive installations. Tamper, jam detection, and sensor missing status reports confirm that the system is working properly.

Certifications and Approvals

Region	Certification
Europe	CE
	RF312E: 1999/5/EC, EN60950: 1993 +A1 +A2 +A3 +A4, EN300220-1: 1997, EN300683: 1997
	RF3212E: 1999/5/EC, EN60950 1992 (2nd edition) +A1 (1993) +A2 (1993) +A3 (1995) +A4 (1997), EN55022-1 Class B (1999), EN55024 (1998), EN50130-4 (1995) +A1 (1998) +A2 (2003), EN61000-4-2 (1995), EN61000-4-3 (1997), EN61000-4-4 (1995), EN61000-4-5 (1995), EN61000-4-6 (1997), EN61000-4-8 (1994), EN61000-4-11 (1994), EN301489-3 (2000), ETS300683 (1997), EN300222-1 (1997-99), EN300220-3 (1997-99)

Installation/Configuration Notes

Mounting Considerations

- Mount the receiver in a central location in respect to all wireless sensors.
- Mount the receiver on a vertical surface with at least 25 cm (10in.) clearance for the antennas.
- Do not mount the receiver in areas with significant metal or electrical wiring such as furnace rooms and utility rooms. If this is unavoidable, mount the receiver with the antennas extending above any metal surface.
- Avoid exposing the receiver to moisture.
- Reception distances improve with higher mounting locations and without metal objects near the receiver antennas.
- Building materials can reduce the overall range.

Compatibility Information

Receiver	Control Panels
RF3212 and RF3212E	Solution Ultima CC488

Technical Specifications

Environmental Considerations

Temperature (Operating): -20°C to +65°C (-4°F to +150°F)

Mechanical Properties

Dimensions: 10.8 cm x 15.2 cm x 3.1 cm
(0.25 in. x 6 in. x 1.2 in.)

Power Requirements

Current Draw: 30 mA nominal
Voltage (Input): 12 VDC

Reception Characteristics**RF3212**

Frequency:	304.00 MHz
Range (open air):	91 m (300 ft) nominal Up to 274 m (900 ft) if jam is off

RF3212E

Frequency:	433.42 MHz
Range (open air):	305 m (1000 ft)

Ordering Information**RF3212E RF Receiver (433.42 MHz)**

433.42 MHz version of the RF3212 RF Receiver.

RF3212E

RF3222E RF Receiver (433.42 MHz)



Features

- ▶ **Compatible with the DS7400XiV4 panels**
- ▶ **Receives low battery, tamper, and sensor status reports**
- ▶ **LED indicates receiver status**
- ▶ **Cover and wall tamper**
- ▶ **System allows two receivers for larger area coverage**
- ▶ **2-hour or 12-hour transmitter and detector supervision**

The RF3222E RF Receiver allows the multiplex bus of the DS7400XiV4 Control Panels to receive RF signals from up to 112 wireless devices. The RF3222E supports up to eight keypads and 112 keyfobs or input sensors.

Tamper, jam detection, and sensor missing status reports provide reassurance that the system works correctly.

The RF3222E receives at 433.42 MHz.

Certifications and Approvals

Region	Certification
Europe	CE
	1999/5/EC, EN60950: 1993 +A1 +A2 +A3 +A4, EN300220-1: 1997, EN300683: 1997
	1999/5/EC, EN60950 1992 (2nd edition) +A1 (1993) +A2 (1993) +A3 (1995) +A4 (1997), EN55022-1 Class B (1999), EN55024 (1998), EN50130-4 (1995) +A1 (1998) +A2 (2003), EN61000-4-2 (1995), EN61000-4-3 (1997), EN61000-4-4 (1995), EN61000-4-5 (1995), EN61000-4-6 (1997), EN61000-4-8 (1994), EN61000-4-11 (1994), EN301489-3 (2000), ETS300683 (1997), EN300222-1 (1997-99), EN300220-3 (1997-99)

Installation/Configuration Notes

Compatible Products

The following products are compatible with the RF3222E Receiver:

Category	Product ID	Product Description
Detectors	RF280ETHS	Wireless smoke detector
	RF835E	Wireless TriTech® detector
	RF940E	Wireless PIR detector
	RF1100E	Wireless glass-break detector
	RF3401E	Wireless point transmitter
Keypads and fobs	RF3332E	Two-button key fob
	RF3334E	Four-button key fob

Wiring Considerations

Note A DS7430 or DS7436 Multiplex Module is needed to connect the RF3222E Receiver to a DS7400XiV4 Control Panel.

The wire length between the receiver and the control panel should not exceed 300 m. Use solid wire with a minimum diameter of 0.8 mm or stranded wire with a minimum diameter of 1.0 mm. Shielded cable is not recommended.

Note Do not use twisted pair wire.

Parts Included

Quant.	Component
1	RF3222E Receiver
2	433.42 MHz antennas
1	Hardware pack
1	Literature pack

Technical Specifications

Environmental Considerations

Temperature (operating): 0°C to +66°C

Mechanical Properties

Dimensions including antennas: 25.6 cm x 15.2 cm x 3 cm

Power Requirements

Current: 30 mA, nominal

Voltage: 12 V, nominal

Trademarks

TriTech® is a registered trademark of Bosch Security Systems in the United States.

Ordering Information

RF3222E RF Receiver (433.42 MHz) RF3222E

Receives RF signals from up to 112 wireless devices; operates at 433.42 MHz

RF3227E RF Receiver (433.42 MHz)



Features

- ▶ **Receives low battery, tamper, and sensor status reports**
- ▶ **LED indicates receiver status**
- ▶ **Cover, wall, and antenna tamper**
- ▶ **System allows two receivers for larger area coverage**
- ▶ **Supervisory interval programmable through the control panel**
- ▶ **4-hour smoke detector supervision**

The RF3227E RF Receiver allows the option bus of compatible control panels to receive RF signals from up to 96 wireless devices. The RF3227E supports up to eight keypads and 96 key fobs or input sensors.

Tamper, jam detection, and sensor missing status reports provide reassurance that the system works correctly.

The RF3227E receives at 433.42 MHz.

Certifications and Approvals

Region	Certification
Europe	CE 1999/5/EC, 2006/95/EC, 2004/108/EC; EN 55022:2006 + A1:2007, Class B; EN 50130-4 w/A1:1998 + A2:2003; EN61000-3-2:2006; EN61000-3-3:1995; EN 60950-1:2001; TBR21:1998

Installation/Configuration Notes

Compatibility Information

The following products are compatible with the RF3227E Receiver:

Category	Product ID	Product Description
Control	CC7240-A	Solution 40 Control Panel
Panels	DS7000 Series	DS7240V2 Control Panel and DS7220V2 Control Panel
Detectors	RF280ETHS	Wireless smoke detector
	RF835E	Wireless TriTech® detector
	RF940E	Wireless PIR detector
	RF1100E	Wireless glass-break detector
	RF3401E	Wireless point transmitter
Keypads and fobs	RF3405E	Wireless inertia transmitter
	RF3332E	Two-button key fob
Keypads and fobs	RF3334E	Four-button key fob
	RF3501E	One-button panic key fob
	RF3501LE	One-button panic key fob
	RF3503E	Two-button transmitter

Mounting Considerations

Whenever possible, mount the receiver in a central location in regard to all wireless sensors. The receiver should be mounted vertically with at least 25 cm (9.8 in.) clearance above it for the antennas. Avoid mounting the receiver in areas with moisture and significant metal or electric wiring, such as furnace rooms and utility rooms. If this is unavoidable, mount the receiver with the antennas extending above any metal surface.

Wiring

The wire length between the receiver and the control panel must not exceed 300 m (984 ft). Use solid wire with a minimum diameter of 0.8 mm or stranded wire with a minimum diameter of 1.0 mm. Adding additional devices to the bus may reduce the maximum wire length.

Note Do not use twisted pair wire or shielded cable.

Parts Included

Quant.	Component
1	RF3227E Receiver
1	433.42 MHz antenna
1	Hardware pack
1	Literature pack

Technical Specifications

Environmental Considerations

Temperature (Operating): 0°C to +65°C

Mechanical Properties

Dimensions including antenna: 25.6 cm x 15.2 cm x 3.0 cm

Power Requirements

Current Draw:	30 mA nominal
Voltage (Input):	12 VDC

Reception Characteristics

Frequency:	433.42 MHz
Range:	305 m

Trademarks

TriTech® is a registered trademark of Bosch Security Systems in the United States.

Ordering Information

RF3227E RF Receiver (433.42 MHz) **RF3227E**
Receives RF signals from up to 96 wireless devices

RF280THS Series Wireless Photoelectric Smoke Detectors



Features

- ▶ **57°C (135°F) heat sensor**
- ▶ **Internal 85 dB sounder**
- ▶ **Superior dust immunity**
- ▶ **Exclusive Chamber Check® self diagnostics**
- ▶ **Factory programmed transmitter ID for quick and simple transmitter enrollment**
- ▶ **Field replaceable smoke chamber**

The RF280THS Series Wireless Photoelectric Smoke Detectors include the following models:

Model	RF Transmission
RF280THS	304.00 MHz
RF280ETHS	433.42 MHz

Each model is an open-area wireless smoke detector designed for fire protective signaling and household fire warning systems. The light emitting diode (LED) indicates alarm, readiness, and testing. The patented chamber design provides superior immunity to false alarms caused by dust. The detectors have an integral 57°C (135°F) heat sensor designed for use with household fire warning systems.

Functions

Chamber Check Self Diagnostics

The Chamber Check Self Diagnostics automatic sensitivity test feature indicates when the detector is outside the factory calibrated specifications. The installer can easily determine which detectors require attention, reducing service costs. The detector alerts users when the detector is dirty, reducing false alarms. A unique chamber check signal is provided.

Patented Chamber Design

The detector chamber walls and lenses optimize internal light scattering and dust hiding capabilities. This provides for industry leading dust immunity without sacrificing detection. You can easily remove the detection chamber for cleaning.

Sounder

The sounder activates on detector alarm. It is 85 dB at 3 m (10 ft). The detector and sounder automatically reset when the chamber clears.

Supervision Features

An internal base tamper is included. The base tamper sends a supervisory signal every 65 minutes. The signal includes the detector sensitivity, battery, and tamper status.

Test Features

The LED automatically flashes to indicate a calibration trouble condition. A steady LED indicates an alarm condition during testing. Verify sensitivity with a push button test.

Certifications and Approvals

Region	Certification
Europe	CE
	RF280ETHS only: 1999/5/EC, EN60950 1992 (2nd edition) +A1 (1993) +A2 (1993) +A3 (1995) +A4 (1997), EN55022-1 Class B (1999), EN55024 (1998), EN50130-4 (1995), +A1 (1998) +A2 (2003), EN61000-4-2 (1995), EN61000-4-3 (1997), EN61000-4-4 (1995), EN61000-4-5 (1995), EN61000-4-6 (1997), EN61000-4-8 (1994), EN61000-4-11 (1994), EN301489-3 (2000), ETS300683 (1997), EN300220-1 (1997-99), EN300220-3 (1997-99)
	RF280ETHS only: 1999/5/EC, EN60950 (1993) +A1/A2/A3/A4, ETS 300683 (1997), EN 300220-1 (1997)
	RF280ETHS only: 73/23/EEC, EN60950 (1993) +A1/A2/A3/A4

Region	Certification	
USA	UL	RF280THS only: UROX: Smoke - Automatic Fire Detectors (UL268 and A)
	CSFM	RF280THS only: 7272-1615: 214 July 2008
	FCC	RF280THS only: ESV-0407-4
Canada	IC	RF280THS only: 12491021131

Installation/Configuration Notes

Compatibility Information

Detectors	Receivers	Control Panels
RF280THS	RF3212	Solution Ultima 844, 862, and 880, CC488
	RF3222	DS7400XiV4
	RF3224	DS7240, DS7220, D6412, and D4412
RF280ETHS	RF3212E	Solution Ultima 844, 862, and 880, CC488
	RF3213E	VR-8
	RF3222E	DS7400XiV4 (firmware version 4.03 or higher)
	RF3227E	DS7240 and DS7220, CC7240-A
	RF3228E	Marise
	RF3249E	DA (Abacus)

Battery Recommendations

The following battery types are recommended for correct operation of your detector: Duracell® DL123A, Eveready® CR123A, or Panasonic® CR123A.

Technical Specifications

Mechanical Properties

Dimensions:	5 cm x 12.7 cm (2 in. x 5.1 in.)
Material:	High impact, fire retardant ABS plastic enclosure and separate twist-lock mounting plate

Environmental Considerations

Integral Heat Sensor:	+57°C (+135°F)
Radio Frequency Interference (RFI) Immunity	No alarm or setup on critical frequencies in the range of 26 MHz to 950 MHz at signal strengths less than 50 V/m.
Relative Humidity:	0% to 95% (non-condensing)
Temperature (operating):	0°C to +38°C (+32°F to +100°F)

Outputs

Alarm:	85 dB at 3 m (10 ft)
--------	----------------------

Power Requirements

Batteries:	Two 3 VDC lithium batteries
Battery Life:	5 or more years under normal operating conditions with recommended battery types

Transmission Characteristics

Frequency Band

RF280THS: 304.00 MHz

RF280ETHS: 433.42 MHz

Trademarks

Chamber Check® is a registered trademark of Bosch Security Systems in the United States.

Duracell® is a registered trademark of the Gillette Company, USA, in the United States and/or other countries.

Eveready® is a registered trademark of Eveready Battery Company, Inc.

Panasonic® is a registered trademark of Matsushita Electric Industrial Co., Ltd.

Ordering Information

RF280ETHS Wireless Smoke Detector (433.42 MHz)

RF280ETHS

An open-area wireless smoke detector designed for fire protective signaling and household fire warning systems; operates at 433.42 MHz

RF835 Series Wireless TriTech Detectors



Features

- ▶ **Wireless transmission**
- ▶ **Battery powered**
- ▶ **Artificial intelligence**
- ▶ **Flexible mounting height**
- ▶ **Motion Analyzer II PIR signal processing**
- ▶ **Microwave and PIR supervision**
- ▶ **Pet, draft, and insect immunity**
- ▶ **Eight detection layers including look down zones**
- ▶ **Temperature compensation**

The RF835 Series Wireless TriTech® PIR/Microwave Detectors includes the following models:

Model	Microwave	RF Transmission
RF835	10.525 GHz	304.00 MHz
RF835E	10.525 GHz	433.42 MHz
RF835E-C	10.588 GHz	433.42 MHz

Each model uses artificial intelligence to detect motion and provide immunity to false alarms caused by pets or animals. An integral RF transmitter reports low battery and tamper status, and sends a supervisory signal to the control panel.

Functions

Signal Processing

Uses passive infrared and microwave technologies to provide an alarm condition when both fields of protection are simultaneously activated. Alarm signals must meet the signaling requirements of both technologies to activate an alarm. Microwave range is factory set, but can be adjusted if desired.

PIR Signal Processing

Motion Analyzer II uses multiple thresholds and timing windows to analyze timing, amplitude, duration, and polarity of signals to make an alarm decision. The detectors tolerate extreme levels of heat and light from heaters and air conditioners, hot and cold drafts, sunlight, lightning, and moving headlights. There are three sensitivity settings.

Microwave Signal Processing

Adaptive processing adjusts to background disturbances. This helps to reduce false alarms while maintaining catch performance.

Test Features

Externally visible, tri-color alarm LED indicates each technology independently.

Supervised Microwave

Patented fully supervised microwave circuitry provides single technology coverage in the event the microwave subsystem fails.

Pet Immunity

The detector is able to distinguish between signals caused by humans and signals caused by pets such as a dog up to 45 kg (100 lb) or two dogs at 27 kg (60 lb) or up to ten cats. This provides immunity to false alarms while maintaining proper catch performance of human targets.

Draft and Insect Immunity

The sealed optical chamber provides immunity to drafts and insects.

Temperature Compensation

The sensor adjusts its sensitivity to maintain consistent catch performance at critical temperatures.

Certifications and Approvals

Region	Certification
Europe	CE RF835E and RF835E-C models only: 89/336/EEC, EN50082: 1997, EN50504: 1995, EN55022: 1998 (CISPR 22: 1997 Class B), EN50130-4: 1995, EN61000-3-2: 1995 (-3-3: 1994), EN61000-4-2: 1995 (-4-3: 1996, -4-4: 1995, -4-5: 1995, -4-6: 1996, -4-11: 1994), EN 300 220-3: 2000, EN 300 440-2: 2000, EN 301 489-3 RF835E and RF835E-C models only: 73/23/EEC, IEC 60950: 2000

Region	Certification	
USA	UL	RF835 only: ANSR: Intrusion Detection Units (UL639)
Canada	IC	RF835 only: 12491021658
China	CCC	RF835-CHI: 2004031901000037 DS835E: 20040319001000037-1
Brazil	ANATEL	RF835E only: 0255-06-1855
Australia	RF835 complies with Australian EMC	
Europe	RF835E and RF835E-C comply with EN50131-1, Grade 2	
USA	RF835 complies with Federal Communications Commission (FCC)	

Installation/Configuration Notes

Compatibility Information

The RF835 Series products are compatible with the following combinations of receivers and control panels:

RF835

Receivers	Control Panels
RF3212	Solution Ultima 844, 862, and 880 control panels, CC488 control panels
RF3213	VR-8 control panels
RF3222	DS7400Xiv4 control panels
RF3224	DS7240, DS7220, D6412, D4412

RF835E and RF835E-C

Receivers	Control Panels
RF3212E	Solution Ultima 844, 862, and 880 control panels, CC488 control panels
RF3213E	VR-8 control panels
RF3222E	DS7400Xiv4 control panels
RF3227E	DS7240, CC7240-A Solution 40 control panel
RF3228E	Marise control panels
RF3249E	DA (Abacus) control panels

Mounting Considerations

- Mounting height for the detector is between 2 m (6.5 ft) and 2.4 m (8.0 ft).
- The wall tamper cannot be used in corner mount installations or when using the optional swivel bracket.
- The integral RF transmitter transmits 150 m (500 ft) in open air. However, in normal operation, it is recommended that the detector is within 30 m (100 ft) of the receiver.

Note Actual acceptable transmitter range should be verified for each installation.

Battery Recommendations

The following battery types are recommended for correct operation of your detector: Duracell® MN1500 or PC1500, Energizer® E91, or Panasonic® AM-3.

Coverage

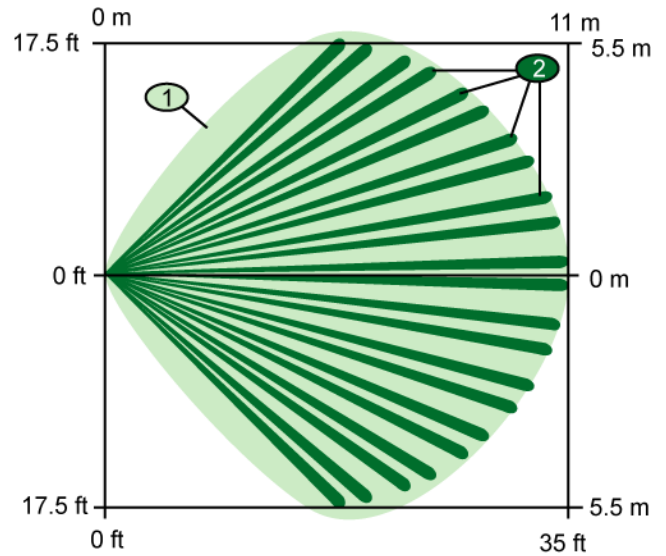

Top View Broad: 11 m x 11 m (35 ft x 35 ft)

- 1 Microwave coverage area 2 PIR coverage pattern

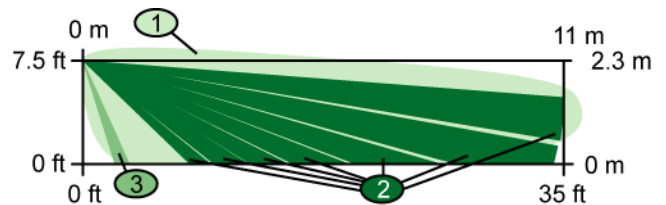

Side View Broad: 11 m x 11 m (35 ft x 35 ft)

- 1 Microwave coverage area 2 PIR coverage pattern
3 Look-down zone

Technical Specifications

Environmental Considerations

Relative Humidity:	0% to 95% (non-condensing)
Temperature (operating):	0°C to +49°C (+32°F to +120°F)

RF835E and RF835E-C:

Complies with EN50131 Environmental Class II, Security Grade 2

Mechanical Properties

Dimensions:	12.7 cm x 7.2 cm x 6.2 cm (5 in. x 2.8 in. x 2.5 in.)
Internal Coverage Pointability	Vertical : -4° to -10° Horizontal: ±10°
Sensitivity Selection	Field selectable for standard or intermediate sensitivity.

Power Requirements

Batteries:	Four 1.5 V AA alkaline batteries
Battery Life:	2 to 3 years under normal operating conditions with recommended battery types
Current Draw:	0.1 mA with LED disabled

Transmission Characteristics**RF835**

Microwave:	10.525 GHz
RF Transmission:	304.00 MHz

RF835E

Microwave:	10.525 GHz
RF Transmission:	433.42 MHz

RF835E-C

Microwave:	10.588 GHz
RF Transmission	433.42 MHz

Trademarks

Eveready® is a registered trademark of Eveready Battery Company, Inc.

Duracell® is a registered trademark of the Gillette Company, USA, in the United States and/or other countries.

Panasonic® is a registered trademark of Matsushita Electric Industrial Co., Ltd.

TriTech® is a registered trademark of Bosch Security Systems in the United States and other countries.

Ordering Information

RF835E Wireless TriTech Detector (10.525 GHz/433.42 MHz)	RF835E
-----------------------------------------------------------------	---------------

Uses artificial intelligence to detect motion and provide immunity to false alarms caused by pets or animals

RF835E-C Wireless TriTech Detector (10.588 GHz/433.42 MHz)	RF835E-C
-------------------------------------------------------------------	-----------------

Uses artificial intelligence to detect motion and provide immunity to false alarms caused by pets or animals

Accessories

Swiveling B335-3 low-profile mount	B335-3
-------------------------------------------	---------------

Swiveling, low-profile, plastic mount for wall mounting. The vertical swivel range is +10° to -20°, while the horizontal swivel range is ±25°. Available in triple packs.

RF940E Wireless PIR Detector



The RF940E is a high performance PIR motion sensor that uses advanced signal processing to provide outstanding catch performance and unsurpassed false alarm immunity. The RF940E's pet immunity tolerates pets and animals such as a dog up to 13 kg, two cats, or numerous rodents. The detector contains an integral RF transmitter capable of transmitting up to 300 m in open air. The transmitter sends a battery report with each transmission and transmits a supervisory signal to the control panel every thirteen minutes.

Note Actual acceptable transmitter range should be verified for each installation.

Certifications and Approvals

Region	Certification
Europe	CE 1999/5/EC, EN60950 1992 (2nd edition) +A1 (1993) +A2 (1993) +A3 (1995) +A4 (1997), EN55022-1 Class B (1999), EN55024 (1998), EN50130-4 (1995) +A1 (1998) +A2 (2003), EN61000-4-2 (1995), EN61000-4-3 (1997), EN61000-4-4 (1995), EN61000-4-5 (1995), EN61000-4-6 (1997), EN61000-4-8 (1994), EN61000-4-11 (1994), EN301489-3 (2000), ETS300683 (1997), EN300222-1 (1997-99), EN300220-3 (1997-99) 1999/5/EC, EN60950: 1993 +A1 +A2 +A3 +A4, EN300220-1: 1997, EN300683: 1997
China	CCC 2008031901000108
Brazil	ANATEL 0254-06-1855
Europe	Complies with EN50131-1, Grade 2

Installation/Configuration Notes

Compatibility Information

The RF940E detector is compatible with the following combinations of receivers and control panels:

Receivers	Control Panels
RF3212E	Solution Ultima 844, 862, and 880 control panels, CC488 control panels
RF3213E	VR-8 control panels
RF3222E	DS7400Xiv4 control panels
RF3227E	DS7240, CC7240-A Solution 40 control panel
RF3228E	Marise control panels
RF3249E	DA (Abacus) control panels

Mounting Considerations

Surface or corner mount (with or without the optional bracket) at a height between 2.3 m and 2.7 m high.

- The maximum wireless range of the detector, in open air, is approximately 300 m. In normal household or commercial applications, keep the detector within 100 m of the assigned control panel receiver.
- Temporarily mount the detector using double-sided tape, and test it for both detector coverage and RF range from the desired location before mounting it permanently.
- Mount the detector where an intruder will most likely cross through the coverage pattern.
- Do not mount in areas with large metallic surfaces such as heating ducts or electrical wiring which may inhibit the sensor's RF signals from reaching the control panel receiver.
- Do not mount the detector outdoors or where direct sunlight can reach it.
- In pet immune applications, do not mount where pets can climb because the upper areas are not immune to pets.

Note Optional mounting brackets can reduce the range and increase dead zone areas. Do not use brackets in pet immune applications.

Battery Recommendations

The following battery types are recommended for correct operation of your detector: Duracell® DL123A, Energizer® EL123AP, or Panasonic® CR123A.

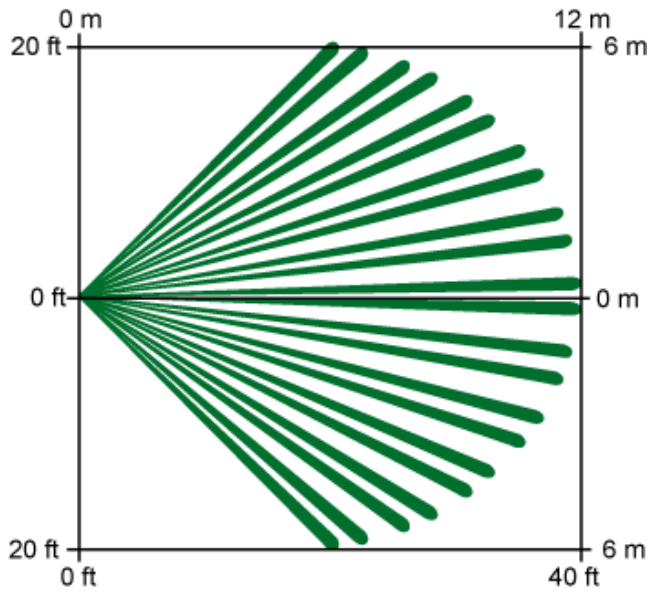
Coverage**Top View Broad: 12 m x 12 m****Side View Broad: 12 m x 12 m****Ordering Information****RF940E Wireless PIR Detector****RF940E**

A high performance PIR motion sensor that uses advanced signal processing to provide outstanding catch performance

Accessories**Swiveling B335-3 low-profile mount****B335-3**

Swiveling, low-profile, plastic mount for wall mounting. The vertical swivel range is +10° to -20°, while the horizontal swivel range is ±25°. Available in triple packs.

Technical Specifications**Environmental Considerations**

Complies with EN50131 Environmental Class II, Security Grade 2

Relative Humidity: Up to 95%, non-condensing

Temperature (operating): 0°C to +49°C

Mechanical Properties

Dimensions: 7.6 cm x 5.7 cm x 3.8 cm

Power Requirements

Batteries: Two 3 VDC Lithium batteries.

Battery Life: Approximately 5 years under normal operating conditions with the recommended battery types.

Transmission Characteristics

Frequency: 433.42 MHz

Maximum RF Power: less than 10 mW

RF1100E Glassbreak Transmitter

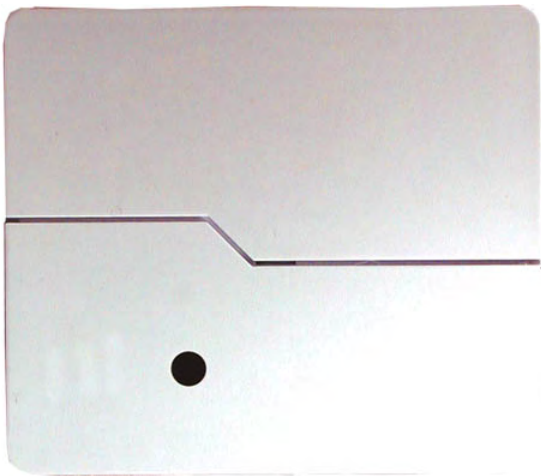

Features

- ▶ **DIP switches for selecting glassbreak sensitivity**
- ▶ **Four glassbreak sensitivity settings**
- ▶ **Two light emitting diode (LED) indicators**
- ▶ **Two tamper switches**
- ▶ **Test mode**
- ▶ **Dual acoustic technology**

The RF1100E Glassbreak Transmitter is a wireless transmitter that detects breaking glass. It is equipped with two tamper switches and four glassbreak sensitivity settings. When there is no alarm activity, the RF1100E transmits a signal every 15 min, providing system supervision and battery status information. The RF1100E is compatible with the RF3212E, RF3222E, and RF3227E Receivers.

Functions

LED Indicators

The RF1100E Glassbreak Transmitter has two LED indicators. For test purposes, the Event LED turns on when the RF1100E detects sound. The Alarm LED turns on when the RF1100E detects breaking glass. During normal operation, you can disable the LEDs to conserve battery life.

Glassbreak Sensitivity

- Use the convenient DIP switches to select a sensitivity setting. There are four sensitivity settings: maximum, medium, low, lowest.
- Use the Event LED to help you select an appropriate sensitivity setting. When the LED flashes, the noise in the area is loud enough to initiate a glassbreak response from the transmitter.

- The RF1100E Glassbreak Transmitter has an LED ENABLE switch that activates or deactivates the LEDs. When the LED ENABLE switch is set to ON, a plastic orange tab protrudes from the side of the RF1100E Glassbreak Transmitter. The tab visually reminds you that the LEDs are active.

Test Mode

Activate the test mode locally using the RF1100E test pads or remotely using a Bosch 13-332 Sound Sensor Tester. When the RF1100E is in test mode, use the 13-332 Sound Sensor Tester to verify that the RF1100E detects flex wave and audio signals properly.

Dual Acoustic Technology

When an object hits a pane of glass, the glass absorbs the blow and emits a low frequency sound pressure wave, called the flex wave. When the force of the blow is too great, glass shatters and emits a high frequency audio signal. A bell ringing or a vase breaking produces a similar audio signal, but does not produce a flex wave. The RF1100E Glassbreak Transmitter detects the flex wave first and the audio signal second, reducing false alarms from items that only emit high frequency audio signals.

Tamper Switches

The RF1100E Glassbreak Transmitter has a cover tamper switch and an optional wall tamper switch. When either switch activates, the RF1100E transmits tamper information.

Low Battery Indication

The Event LED and the Alarm LED flash simultaneously when the RF1100E battery is low. Set the LED ENABLE switch to ON to activate the LEDs.

Certifications and Approvals

Region	Certification	
Europe	CE	1999/5/EC, EN55022: 1998 (Class B), EN60825, EN60950, EN50130-4: 1995 +A1: 1998, EN61000-4-2: 1995, EN61000-4-3: 1996, EN300220-1: 2000, EN300220-3: 2000, EN301489-1: 2002, EN301489-3: 2002
Australia	ACMA	Australian Communications and Media Authority

Installation/Configuration Notes

- Note** Glassbreak detectors are intended only as a component of a perimeter protection system. They should always be used in conjunction with motion sensors.

Acoustic Capabilities

The RF1100E Glassbreak Transmitter can be used with the following glass types:

Glass Type	Glass Thickness
Plate	0.24 cm to 0.95 cm
Tempered	0.32 cm to 0.95 cm
Laminated	0.32 cm to 1.4 cm Protected only if both panes of unit are broken
Wired	0.64

Sensitivity Settings

Sensitivity Setting	Range
Maximum	7.6 m
Medium	4.6 m
Low	3 m
Lowest	1.5 m

Compatibility Information

Receivers	Control Panels
RF3212E	Solution Ultima 844, 862, and 880, CC488
RF3213E	VR-8
RF3222E	DS7400XIV4
RF3227E	DS7240, DS7220, D6412, and D4412
RF3228E	Marise
RF3249E	DA (Abacus)

Recommended Products

- Bosch 13-332 Sound Sensor Tester
- Duracell® MN1500 or PC1500, Eveready® E91, or Panasonic® AM-3PIXB batteries

Mounting Considerations

For the best performance, mount the RF1100E:

- On flat surfaces, such as ceilings or walls.
- Within clear view of the glass (there is no minimum range).
- Within 7.6 m of the glass.

Note If the window is covered with heavy drapes, curtains, shades, blinds, and so on, mount the RF1100E on the window frame.

Do not mount the RF1100E:

- In a corner or in rooms with loud equipment such as air compressors, bells, and power tools.
- On the same wall as the glass.
- On freestanding posts or pillars.

The maximum RF range of the RF1100E in an open field is approximately 300 m. In normal residential or commercial applications, mount the RF1100E within 100 m of its assigned receiver.

Technical Specifications

Electrical

Battery Life:	Minimum of 2 years under normal operating conditions. Test with the recommended battery types.
Batteries:	Two AA, 3 V alkaline batteries

Mechanical

Dimensions	12.2 cm x 10.5 cm x 3.3 cm
Frequency:	433.42 MHz

Environmental

Temperature (operating):	0°C to +50°C
--------------------------	--------------

Trademarks

Duracell® is a registered trademark of The Gillette Company.

Eveready® is a registered trademark of Eveready Battery Company, Inc.

Panasonic® is a registered trademark of Matsushita Electric Industrial Co., Ltd.

Ordering Information

RF1100E Glassbreak Transmitter	RF1100E
Equipped with two tamper switches and four glassbreak sensitivity settings	

RF3332 Series Key Fobs



Features

- ▶ **Uniquely coded arm and disarm buttons (RF3332 and RF3332E)**
- ▶ **Panic alarm**
- ▶ **LED indicator**

The RF3332 Series Key Fobs includes the following key fob models:

Model	Frequency	Function
RF3332	304.00 MHz	Arm and /disarm Panic alarm
RF3332E	433.42 MHz	Arm and disarm Panic alarm

All models are wireless and have two buttons. The RF3332 and RF3332E can arm and disarm the security system or send a panic alarm.

Functions

Panic Alarm

Each model can send a panic code to your monitoring company if your security system is programmed to do so. Press both buttons on the RF3332 or RF3332E models simultaneously for two seconds to send a panic alarm.

LED Indicator

The LED flashes to indicate a signal was sent to your security system.

Certifications and Approvals

Region	Certification	
Europe	CE	RF3332E: 1999/5/EC, EN60950 1992 (2nd edition) +A1 (1993) +A2 (1993) +A3 (1995) +A4 (1997), EN55022-1 Class B (1999), EN55024 (1998), EN50130-4 (1995) +A1 (1998) +A2 (2003), EN61000-4-2 (1995), EN61000-4-3 (1997), EN61000-4-4 (1995), EN61000-4-5 (1995), EN61000-4-6 (1997), EN61000-4-8 (1994), EN61000-4-11 (1994), EN301489-3 (2000), ETS300683 (1997), EN300222-1 (1997-99), EN300220-3 (1997-99) RF3332E: 1999/5/EC, EN60950: 1993 +A1 +A2 +A3 +A4, EN300220-1: 1997, EN300683: 1997
USA	FCC	RF3332: ESV-0407-2
Canada	IC	RF3332: 12491021155
Brazil	ANATEL	RF3332E: 1360-05-1855

Installation/Configuration Notes

Compatibility Information

Model	Receivers	Control Panels
RF3332	RF3212	Solution Ultima 844, 862, and 880, CC488
	RF3213	VR-8
	RF3222	DS7400XIV4
	RF3224	DS7240, DS7220, D6412, and D4412
RF3332E	RF3212E	Solution Ultima 844, 862, and 880, CC488
	RF3213E	VR-8
	RF3222E	DS7400XIV4
	RF3227E	DS7240, DS7220, D6412, and D4412
	RF3228E	Marise
	RF3249E	DA (Abacus)

Recommended Batteries

The following battery types are recommended for correct operation of your key fob: Duracell® DL2025, Eveready® CR2025, or Panasonic® CR2025.

Technical Specifications

Environmental Considerations

Relative Humidity:	0% to 95% (non-condensing)
Temperature (operating)::	-29°C to +65°C (-20°F to +150°F) <i>For UL listed requirements, the temperature range is 0°C to +49°C (+32°F to +120°F)</i>

Mechanical Properties

Dimensions: 3.8 cm x 6.3 cm x 1.3 cm (1.5 in. x 2.5 in. x 0.5 in.)

Power Requirements

Batteries: Two 3 VDC lithium batteries

Battery Life: Approximately 5 years under normal operating conditions with recommended battery types

Transmission Characteristics

Maximum RF Power: Less than 10 mW

Frequency

RF3332E: 433.42 MHz

RF3332: 304.00 MHz

Trademarks

Duracell® is a registered trademark of the Gillette Company, USA, in the United States and/or other countries.

Eveready® is a registered trademark of Eveready Battery Company, Inc.

Panasonic® is a registered trademark of Matsushita Electric Industrial Co., Ltd.

Ordering Information

RF3332E Two-Button Wireless Key Fob (433.42 MHz) **RF3332E**

Use to arm or disarm a security system

RF3334 Series Key Fobs



Features

- ▶ Uniquely coded arm and disarm buttons
- ▶ Panic alarm
- ▶ LED indicator
- ▶ Programmable option buttons

The RF3334 Series Key Fobs includes the RF3334 and the RF3334E. The RF3334 transmits at a frequency of 304.00 MHz while the RF3334E transmits at 433.42 MHz. Both models are wireless and have four buttons. Each model allows you to arm and disarm the security system or send a panic alarm. Programmed with a unique code, each model works exclusively with your compatible security system. Two option buttons are user-defined to perform additional functions.

Functions

Panic Alarm

The RF3334 Series can send a panic code to your monitoring company if your security system is programmed to do so. Press both the lock and unlock buttons simultaneously for two seconds to send a panic alarm.

LED Indicator

The LED flashes to indicate a signal was sent to your security system.

Programmable Option Buttons

The RF3334 Series can be programmed to control additional devices in your protected area. Two option buttons are available. Possible programming choices include turning on lights or opening the garage door.

Certifications and Approvals

Region	Certification	
Europe	CE	RF3334E: 1999/5/EC, EN60950 1992 (2nd edition) +A1 (1993) +A2 (1993) +A3 (1995) +A4 (1997), EN55022-1 Class B (1999), EN55024 (1998), EN50130-4 (1995) +A1 (1998) +A2 (2003), EN61000-4-2 (1995), EN61000-4-3 (1997), EN61000-4-4 (1995), EN61000-4-5 (1995), EN61000-4-6 (1997), EN61000-4-8 (1994), EN61000-4-11 (1994), EN301489-3 (2000), ETS300683 (1997), EN300222-1 (1997-99), EN300220-3 (1997-99)
USA	FCC	RF3334: ESV-0407-2
Canada	IC	RF3334: 12491021155
Brazil	ANATEL	RF3334E: 1361-05-1855

Installation/Configuration Notes

Compatibility Information

Model	Receivers	Control Panels
RF3334	RF3212	Solution Ultima 844, 862, and 880, CC488
	RF3213	VR-8
	RF3222	DS7400XIV4
	RF3224	DS7240, DS7220, D6412, and D4412
RF3334E	RF3212E	Solution Ultima 844, 862, and 880, CC488
	RF3213E	VR-8
	RF3222E	DS7400XIV4
	RF3227E	DS7240, DS7220, D6412, and D4412
	RF3228E	Marise
	RF3249E	DA (Abacus)

Recommended Batteries

The following battery types are recommended for correct operation of your key fob: Duracell® DL2025, Eveready® CR2025, or Panasonic® CR2025.

Technical Specifications

Environmental Considerations

Relative Humidity:	0% to 95% (non-condensing)
Temperature (operating):	-29°C to +65°C (-20°F to +150°F) <i>For UL listed requirements, the temperature range is 0°C to +49°C (+32°F to +120°F)</i>

Mechanical Properties

Dimensions:	3.8 cm x 6.3 cm x 1.3 cm (1.5 in. x 2.5 in. x 0.5 in.)
-------------	--------------------------------------------------------

Power Requirements

Batteries:	Two 3 VDC lithium batteries
Battery Life:	5 to 6 years under normal operating conditions with recommended battery types

Transmission Characteristics**Frequency**

RF3334:	304.00 MHz
RF3334E:	433.42 MHz

Trademarks

Duracell® is a registered trademark of the Gillette Company, USA, in the United States and/or other countries.

Eveready® is a registered trademark of Eveready Battery Company, Inc.

Panasonic® is a registered trademark of Matsushita Electric Industrial Co., Ltd.

Ordering Information

RF3334E Four-Button Wireless Key Fob RF3334E

(433.42 MHz)

Wireless, four-button key fob

RF3401 Series RF Point Transmitters



Features

- ▶ **Supervised sensor loop**
- ▶ **Internal reed switch**
- ▶ **Supervisory signal at regular intervals**
- ▶ **Complete status sent with every transmission**
- ▶ **Cover tamper**

The RF3401 Series Point Transmitters includes the following models:

Model	Supervision Signal	Frequency
RF3401	65 minutes	304.00 MHz
RF3401E	15 minutes	433.42 MHz

Each transmitter model is magnetic and dry contact wireless, and appropriate for monitoring doors, windows or other dry contact devices. The models each have a cover tamper switch and RF supervision. They also have the capability to accept a supervised dry contact input from an external device.

If there is no other activity, a low power level signal is transmitted to the receiver to provide supervision. Each transmission sends battery status information to the panel.

Certifications and Approvals

Region	Certification	
Europe	CE	RF3401E: 1999/5/EC, EN60950 1992 (2nd edition) +A1 (1993) +A2 (1993) +A3 (1995) +A4 (1997), EN55022-1 Class B (1999), EN55024 (1998), EN50130-4 (1995) +A1 (1998) +A2 (2003), EN61000-4-2 (1995), EN61000-4-3 (1997), EN61000-4-4 (1995), EN61000-4-5 (1995), EN61000-4-6 (1997), EN61000-4-8 (1994), EN61000-4-11 (1994), EN301489-3 (2000), ETS300683 (1997), EN300222-1 (1997-99), EN300220-3 (1997-99)
		RF3401E: 1999/5/EC, EN60950: 1993 +A1 +A2 +A3 +A4, EN300220-1: 1997, EN300683: 1997
USA	UL	RF3401: AMQV: Connectors and Switches (UL634)
	FCC	RF3401: ESV-0407-1
Canada	IC	RF3401: 12491021017
China	CCC	RF3401E and RF3401-CHI: 2005031901000075
Brazil	ANATEL	RF3401E: 1220-05-1855

Installation/Configuration Notes

For convenience, a quick install mounting base plate is included.

Compatibility Information

The RF3401 Series RF point Transmitters are compatible with the following combinations of receivers and control panels:

Detector	Receivers	Control Panels
RF3401	RF3212	Solution Ultima 844, 862, and 880 control panels, CC488 control panels
	RF3213	VR-8 control panel
	RF3222	DS7400XIV4 control panels
	RF3224	DS7240, DS7220, D6412, D4412
RF3401E	RF3212E	Solution Ultima 844, 862, and 880 control panels, CC488 control panels
	RF3213E	VR-8 control panel
	RF3222E	DS7400XIV4 control panels
	RF3227E	DS7240, CC7240-A Solution 40 control panel
	RF3228E	Marise control panels
	RF3249E	DA (Abacus) control panels

Technical Specifications

Environmental Considerations

Relative Humidity:	0% to 95% (non-condensing)
Temperature (operating):	-29°C to +65°C (-20°F to +150°F) <i>For UL listed requirements, the temperature range is 0°C to +49°C (+32°F to +120°F)</i>

Mechanical Properties

Dimensions:	8.26 cm x 3.56 cm x 1.91 cm (3.25 in. x 1.4 in. x 0.75 in.)
-------------	----------------------------------------------------------------

Power Requirements

Batteries:	3 VDC lithium battery
Battery Life:	5+ years under normal operating conditions with recommended battery types
Recommended Battery Types:	Duracell® DS123A, Energizer® EL123AP, or Panasonic® CR123A

Trademarks

Duracell 0174 is a registered trademark of the Gillette Company, USA, in the United States and/or other countries.

Energizer® is a registered trademark of Eveready Battery Company, Inc.

Panasonic® is either a registered trademark of a Matsushita Electric Industrial Co., Ltd.

9

Ordering Information

RF3401E Point Transmitter (433.42 MHz) **RF3401E**
433.42 MHz version of the RF4301 Point Transmitter.

RF3405E Wireless (RF) Inertia Transmitter

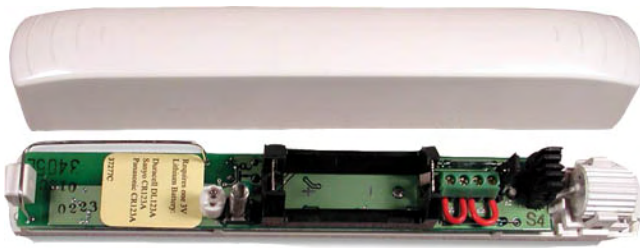

Features

- ▶ **Internal magnetic reed switch**
- ▶ **Supervised external loop**
- ▶ **Gross or minor attack movement settings**
- ▶ **Test mode**

The RF3405E is a wireless transmitter with an inertia sensor, reed switch, and supervised external contact input. It is used for monitoring doors, windows, or other dry contact devices.

System Overview

The RF3405E has an inertia sensor with programmable sensitivity settings. You can set the transmitter to monitor the inertia sensor or external loop. Internal reed switches can also accept a dual EOL resistor supervised dry contact input from an external device. You can enable or disable the reed switch. A cover and wall tamper switch is provided. All transmissions from the RF3405E send battery status information.

Functions

Supervised External Loop

Supervision is provided by transmitting a signal to the receiver every 13 minutes if there is no other activity.

Gross or Minor Attack Movement Settings

Program the minor attack settings to react after four or eight repetitive pulses. If gross attack is enabled, the inertia sensor only reacts to major attack movement. The gross attack movement has four sensitivity settings.

Test Mode

Once the detector is mounted, you can place it in test mode. Separate test modes verify the gross attack or minor attack movement settings. During the testing time, the LED flashes twice each time a magnetic contact changes state or the external contact changes state.

Certifications and Approvals

Region	Certification	
Europe	CE	1999/5/EC, EN60950: 2000, EN61000-4-2: 1998, EN61000-4-3: 2000, EN300220-1: 1997
Brazil	ANATEL	1164-06-1855

Installation/Configuration Notes

Mounting Considerations

- The maximum range of the inertia transmitter, in open air, is approximately 300 m (984 ft). Keep this transmitter within 100 m (328 ft) of the receiver to which it is assigned.
- Mounting the inertia transmitter on metal surfaces might reduce its RF range. Mounting it on iron or steel surfaces might affect the operation of the internal magnetic contact.
- Mount the inertia transmitter on the door or window frame and mount the magnet assembly on the moving portion.

Compatibility Information

Receiver	Control Panels
RF3227E	D7240, D7220, D6412, and D4412

Recommended Batteries

The following battery types are recommended for correct operation of your transmitter: Duracell® DL123A, Energizer® EL123AP, Panasonic® CR123A.

Technical Specifications

Environmental Considerations

Relative Humidity	0% to 95% non-condensing
Temperature (operating):	-20C to +60C (-4°F to +151°F)

Mechanical Properties

Dimensions

Transmitter:	2.7 cm x 2.4 cm x 16.9 cm (1.1 in. x 0.9 in. x 6.7 in.)
Magnet:	1.9 cm x 1.3 cm x 16.9 cm (0.75 in. x 0.5 in. x 2.4 in.)

Supervisory Internal	13 min nominal
----------------------	----------------

Power Requirements

Battery:	One 3 VDC lithium battery
Battery Life	A minimum of 3 years under normal operating conditions with recommended battery types (2 years if using the inertia sensor).

Transmission Characteristics

Frequency:	433.42 MHz
Maximum RF Power	Less than 10 mW

Trademarks

Duracell® is a registered trademark of the Gillette Company, USA, in the United States and/or other countries.

Energizer® is a registered trademark of Eveready Battery Company, Inc.

Panasonic® is a registered trademark of Matsushita Electric Industrial Co., Ltd.

Ordering Information

RF3405E Wireless (RF) Inertia Transmitter **RF3405E**
Monitors doors and windows via an inertia sensor

RF3501LE Panic Transmitter (433.42 MHz)



Features

- ▶ **Unique user code**
- ▶ **Fluorescent case with built-in clip**
- ▶ **Large, single, red button with LED**
- ▶ **Necklace included**

The RF3501LE Panic Transmitter has a fluorescent case that makes it easy to see in the dark. The large red single button makes it easy for users to send a panic or medical alarm to a monitoring central station or emergency service center. The light emitting diode (LED) above the button clearly shows that the transmitter is working correctly. The transmitter case has a clip, allowing users to attach the transmitter to a pocket. Users can also wear the transmitter as a pendant on the included necklace.

Functions

Unique User Code

Each transmitter has a unique code that monitoring central stations can correlate with specific users, allowing the monitoring personnel to identify the person sending the alarm.

Transmission LED

The user presses the red button and a red LED lights up for one second, showing that the alarm is sent.

Certifications and Approvals

Region	Certification
Europe	CE 1999/5/EC, EN60950 1992 (2nd edition) +A1 (1993) +A2 (1993) +A3 (1995) +A4 (1997), EN55022-1 Class B (1999), EN55024 (1998), EN50130-4 (1995) +A1 (1998) +A2 (2003), EN61000-4-2 (1995), EN61000-4-3 (1997), EN61000-4-4 (1995), EN61000-4-5 (1995), EN61000-4-6 (1997), EN61000-4-8 (1994), EN61000-4-11 (1994), EN301489-3 (2000), ETS300683 (1997), EN300222-1 (1997-99), EN300220-3 (1997-99)

Installation/Configuration Notes

Compatibility Information

Control Panels DS7220, DS7240, DS7240 CSC

Receivers RF3227E

Recommended Batteries

The following battery types are recommended for correct operation of the transmitter: Duracell® DL2025, Eveready® CR2025, or Panasonic® CR2025.

Parts Included

Quantity	Component
1	Transmitter with built-in pocket clip
1	Necklace
2	Lithium batteries

Technical Specifications

Environmental Considerations

Relative Humidity: 0% to 95% (non-condensing)

Temperature (operating): -10°C to +55°C

Mechanical Properties

Dimensions: 70 mm x 50 mm x 20 mm

Color: Fluorescent

LED: Red

Power Requirements

Batteries: Two 3 VDC lithium batteries

Battery Life: 5 to 6 years under normal operating conditions with recommended battery types

Transmission Characteristics

Frequency Band 433.42 MHz

Trademarks

Duracell® is a registered trademark of the Gillette Company, USA, in the United States and/or other countries.

Eveready® is a registered trademark of Eveready Battery Company, Inc.

Panasonic® is a registered trademark of Matsushita Electric Industrial Co., Ltd.

Ordering Information

RF3501LE Panic Transmitter (433.42 MHz) RF3501LE

Single-button, wireless, panic transmitter with LED and fluorescent case. Can be worn on a necklace or clip.

RF3503E Panic-Medical Fob



Features

- ▶ Each transmitter has a unique code
- ▶ Optional belt or pocket clip
- ▶ Up to 100 m range (open air)
- ▶ Up to 5 year battery life

The RF3503E Panic-Medical Fob is a wireless, two-button transmitter that sends a medical or panic alarm signal to the monitoring system. Each RF3503E is programmed with a unique code that allows the monitoring system to recognize individual transmitters.

Certifications and Approvals

Region	Certification
Europe	CE 1999/5/EC, EN55022: 1998 (Class B), EN60950, EN50130-4: 1995 +A1: 1998, EN61000-4-2: 1995, EN61000-4-3: 1996, EN300220-1: 2000, EN300220-3: 2000, EN301489-1: 2002, EN301489-3: 2002

Installation/Configuration Notes

Compatibility Information

Receivers	Control Panels
RF3212E	Solution Ultima 844, 862, and 880, CC488
RF3213E	VR-8
RF3222E	DS7400XIV4
RF3227E	DS7240V2, DS7220V2, D6412, and D4412

Receivers

RF3228E

RF3249E

Control Panels

Marise

DA (Abacus)

Recommended Batteries

The following batteries are recommended for use with the RF3503E Transmitter: Duracell® DLCR2, Eveready® EL1CR2, or SANYO® CR2.

Battery Life

Battery life is approximately 5 yr under normal use. Use only the specified replacement batteries for the longest battery life.

Range

Although the transmitter's range can be up to 100 m in open air, typical building materials can greatly reduce the range of your unit. Try out your transmitter at various locations in the monitored area to test the range.

Parts Included

Quant.	Component
1	RF3503E Transmitter
1	Belt or pocket clip
1	Lithium battery (P/N: 33039)

Technical Specifications

Environmental Considerations

Relative Humidity: 0% to 95% non-condensing

Temperature (operating): -20°C to +65°C

Mechanical Properties

Dimensions: 10.5 cm x 4.0 cm x 2.1 cm

Weight: 85 g

Power Requirements

Voltage (battery): 3 VDC

Trademarks

Duracell® is a registered trademark of the Gillette Company, USA, in the United States and other countries.

Eveready® is a registered trademark of Eveready Battery Company, Inc, USA, in the United States and other countries.

SANYO® is either a registered trademark or a trademark of SANYO Electric Co., Ltd.

Ordering Information

RF3503E Panic-Medical Fob	RF3503E
Sends a medical or panic alarm signal to the monitoring system	

Signaling Devices

10

BES External Signaling Device, Audio/Visual

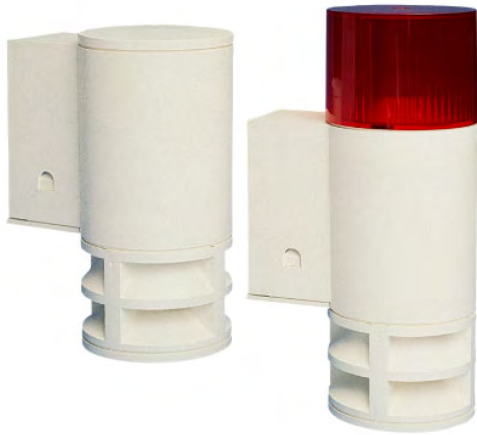

Features

- ▶ Activation and control of the sound generator and the strobe light are monitored
- ▶ Tone variants (can be coded via bridges) for:
 - Hold-up/intrusion alarm
 - Emergency signal (fire alarm)
- ▶ Alarm time can be set
- ▶ Tamper contact
- ▶ Wall mounting
- ▶ Mast and corner mounting (optional)
- ▶ Tear-off contact (optional)

Bosch external signaling devices are signaling devices with an integrated sound generator for acoustic alarm and/or a red strobe light for visual alarm.

Functions

BES external signaling devices are primarily intended for monitoring the connection to intrusion systems.

Due to the different tone variants of the acoustics, BES can also be used in fire alarm systems.

The lift-off protection leads to a delay in dismantling and sets off the acoustic signaling device.

Certifications and Approvals

Region	Certification	
Europe	CE	BES
Germany	VdS	G 197024, C BES A/O G 197023, C BES A

Installation/Configuration Notes

The danger signal zone is split into warning and emergency signals.

DIN 33404, Parts 1 and 3 must be observed when planning for the fire alarm.

The special configuration of the emergency signal allows the level of audibility to be set at only 10 dB above the background level. In contrast, the level of warning signals must be 15 dB higher.

The number of acoustic alarms can be determined from this requirement.

Planning example:

Sound level	-110 dB
Audibility	-10 dB
Background level	-70 dB
Attenuation =	-30 dB

Sound pressure reduction diagram

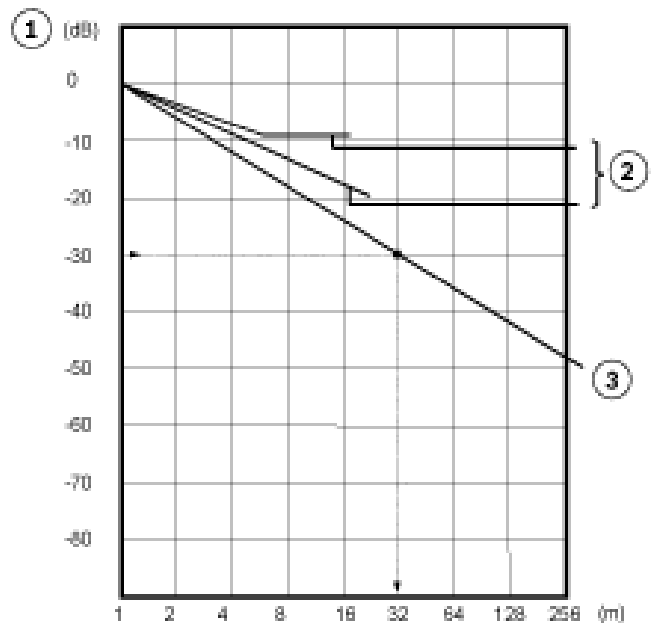

- 1 Sound pressure reduction
- 2 Reduction in sound pressure with reflection dependent upon room size and echo time
- 3 Sound pressure reduction without reflection

The diagram (see above) indicates a distance of 32 m for this attenuation (-30 dB).

It is therefore recommended that an acoustic alarm be installed approximately every 60 m.

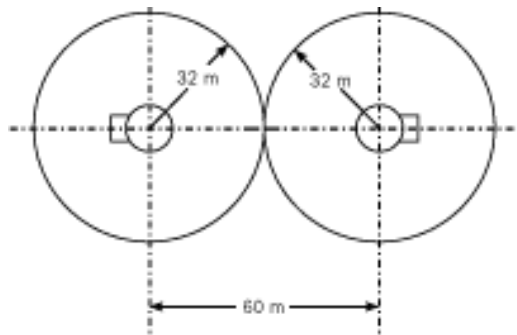
Ordering Information

BES External Signaling Device, Audio/ Visual **3002102450**

For acoustic alarm signaling or with a red strobe light for visual alarm signaling

BES external signaling device, audio **3002102452**

For acoustic alarm signaling

Parts Included

Type	Qty.	Component
BES audio/visual	1	External signaling device with optical display
BES audio	1	External signaling device

Technical Specifications

Sound level	Min. 100 dB(A) at 1 m distance
Tone variants	
<ul style="list-style-type: none"> Hold-up/intrusion alarm 	Tone complies with VdS regulation 2300
<ul style="list-style-type: none"> Emergency signal (fire alarm) 	Tone complies with EN54 Part 3
<ul style="list-style-type: none"> Continuous tone 	Basic tone 1: 500 Hz \pm 5% Basic tone 2: 1200 Hz \pm 5%
Alarm time can be set	
<ul style="list-style-type: none"> Unlimited time via control panel 	180 s
<ul style="list-style-type: none"> Max. time via signaling device 	270 s
Operating voltage	
<ul style="list-style-type: none"> Flash lamp 	10.5 V to 29 V/300 mA
<ul style="list-style-type: none"> Control of acoustics 	12 V ₋ (10.5 V to 14.5 V) or 24 V ₋ (21 V to 29 V)
Voltage range	
<ul style="list-style-type: none"> 12 V₋ (pole reversal) 	10.5 V ₋ /240 mA 14.5 V ₋ /330 mA
<ul style="list-style-type: none"> 24 V₋ (current gain) 	21 V/380 mA (29 V/500 mA)
Ambient temperature	-25 °C to +65 °C
Protection category as per	
<ul style="list-style-type: none"> DIN 40050 	IP 33
<ul style="list-style-type: none"> DIN 40040 	HUF
Housing	
Material	UV-resistant PVC
Housing color	Pure white, RAL 9010
Color of flash lamp cover	Red, RAL 3001
Weight	
<ul style="list-style-type: none"> BES audio/visual 	Approx. 1.2 kg
<ul style="list-style-type: none"> BES audio 	Approx. 1 kg
Dimensions (H x W x D)	300.5 x 110 x 165 mm

BL 200 Strobes



Features

- ▶ **Compact, robust and maintenance-free**
- ▶ **Reliable, bright light, and long-lived with Xenon flash tubes**
- ▶ **For operating voltage 12 V DC and 24 V DC**
- ▶ **Can be used in adverse environmental conditions**
- ▶ **Suitable for surface and flush-mounted cable feed**

The BL 200 Strobes are universally-applicable signaling devices for optical alarm and designed for connection to fire panels.

System Overview

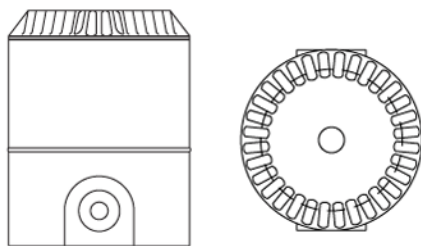

Functions

The strobe lamps are located in the upper section of the transparent signaling device. When activated via the fire panel, this emits flashes of light in accordance with the color of the signaling device. The blink frequency is once a second.

The electronic circuit is cast and the connections are reverse polarity protected.

Certifications and Approvals

Region	Certification	
Europe	CE	BL 200
Germany	VdS	G 207104 BL 200
Poland	CNBOP	0148/2008 BL 200
Russia	GOST	POCC DE.C313B06300

Installation/Configuration Notes

- The Strobes are suitable for mounting in interior and protected exterior areas.
- The upper section of the signaling device is connected to the base by a bayonet lock.
- The strobe lens has screw threads and is also secured against removal by a security screw.
- Can be connected to the following fire panels:
 - BZ 1060
 - BZ 500 LSN
 - UEZ 1000 LSN
 - UEZ 2000 LSN
 - UGM 2020.

Parts Included

Quant.	Component
1	Signaling device upper section in red, white, yellow or green transparent
1	Mounting base, red, for surface and flush-mounted cable feed

Technical Specifications

Electrical

Operating voltage	12 VDC / 24 V DC
Current consumption	<ul style="list-style-type: none"> • 12 V DC 150 mA • 24 V DC 175 mA
Starting current	< 1 A

Mechanics

Housing	
• Material	Plastic PC (polycarbonate)
• Color of signaling device upper section	Red White Yellow Green
• Color of mounting base	Red, RAL 3001
Dimensions	Ø 93 mm x 112.5 mm
Weight	300 g

Environmental conditions

Protection class as per EN 60529	IP 65
Permissible operating temperature	-20 °C ... +55 °C

Special features

Flash strength

• 12 V DC	0.7 J
• 24 V DC	1.3 J
Flash frequency	1Hz (± 10%)
Minimum service life	5 million flashes
Maximum service life	50 million flashes

Ordering Information

BL 200 Red, 12 V/24 V Signaling device upper part red transparent, base red, for surface-mounted and flush- mounted cable feed	BL200-S-red
BL 200 White, 12 V/24 V Signaling device upper part white transparent, base red, for surface-mounted and flush- mounted cable feed	BL200-S-white
BL 200 Yellow, 12 V/24 V Signaling device upper part yellow transpar- ent, base red, for surface-mounted and flush- mounted cable feed	BL200-S-yellow
BL 200 Green, 12 V/24 V Signaling device upper part green transparent, base red, for surface-mounted and flush- mounted cable feed	BL-200-S-green

A			
ADB Spring-loaded bolts for wooden windows	265	D126 Standby Battery (12 V, 7 Ah)	106
ADM 2000 Spring-loaded mechanism	264	D203 Enclosure	99
AE1 Standard Enclosure (Gray)	98	D6600 CD ROM	399
AE20 Universal Plastic Enclosure	99	Door Access Control Module (DACM)	91
AE3 Large Enclosure (Gray)	98	DS 935 LSN Infrared Motion Detector	310
AMK 4 LSN Shutter Door Contact	359	DS1100i Series Glassbreak Detectors	216
AMK 4 S Z Shutter Door Contact	285	DS1109i Glassbreak Detector	218
AMK 4 Z Overhead door contact	284	DS1110i Glassbreak Tester	293
AMK 4 S LSN Shutter Door Contact	361	DS150i Series Request-to-exit Detectors	211
AT 2000 Analog Transmission System	417	DS160 Series High Performance Request-to-exit Detectors	213
AT 2000 IP ISDN Transmission System	424	DS304 PIR Detector with Replaceable Mirrors	162
AT 2000 ISDN Transmission System	419	DS306E PIR Detector	151
AT 2000 TSN ISDN Transmission System	421	DS308EA Quad PIR Detector with Anti-mask	153
ATE TSN ISDN Alarm Receiver	427	DS415i and DS435i Single Beam Photoelectric Detectors	223
B		DS422i and DS426i Dual-Beam Photoelectric Detectors	225
B328 Gimbal-mount Bracket	291	DS453Q and DS455Q Quad Beam Photoelectric Detectors	226
B800 Ceiling-mount Bracket	292	DS484Q and DS486Q Quad-Beam Photoelectric Detectors	228
BAT 100 LSN Display Panel	381	DS7080iP32 Eight-zone Control Panels	35
Battery 12 V / 10 Ah	100	DS720i Long Range TriTech PIR Detector (10.525 GHz)	202
Battery 12 V / 17 Ah	101	DS7220V2 Control Panel	38
Battery 12 V / 24 Ah	102	DS7240V2 Control Panel	42
Battery 12 V / 65 Ah	103	DS7400Xi Series Addressable Control Panels	46
BE 300 LSN remote operating unit	66	DS7420i Dual Phonenumber/Bell Supervision Module	89
BES External Signaling Device, Audio/Visual	490	DS7430 Multiplex Expansion Module	70
BL 200 Strobes	492	DS7432 Series Eight-input Remote Modules	71
C		DS7433 Series Eight-input Modules	73
CC408 Solution 880 Control Panel	20	DS7436 Multiplex Expansion Module	74
CC488 Solution Ultima 880 Control Panel	22	DS7445i Series LED Keypads	57
CC808 Direct Link Cable	110	DS7445V2 Series LED Keypads	55
CC880 Solution 16 Control Panel	24	DS7446KP Series LCD Keypads	49
Conettix D6100i Communications Receiver/Gateway	395	DS7447E Series LCD Keypads	53
Conettix C900V2 Dialer Capture Ethernet Module	84,412	DS7447V2 Series LCD Keypads	51
Conettix D6100 Communications Receiver/Gateway	391	DS7457i Series Single Zone Input Modules	75
Conettix D6100 Rack Mount Kit	406	DS7457iE Single Zone Input Module	77
Conettix D6200CD CD-ROM	399	DS7460i Dual-zone Input Module	78
Conettix D6201 Series IP Security Keys	411	DS7465i Input-Output Module	80
Conettix D6600 Communications Receiver/Gateway	386	DS778 Long Range PIR Detector	205
Conettix D6610 CPU Line Card	403	DS794Z and ZX794Z Series Long Range PIR Detectors	207
Conettix D6615 CPU Terminator Card	404	DS825 and DS840 Series TriTech PIR Detectors	177
Conettix D6641 Telephone Line Card	400	DS840LSN TriTech PIR/MW Dual Motion Detector	312
Conettix D6645 Telephone Line Terminator Card	400	DS860 Series TriTech PIR/Microwave Detector	180
Conettix D6672 Com 1 Expansion Kit	401	DS936 Low Profile Panoramic PIR Detector	186
Conettix D6680 Ethernet Network Adapter	402,409	DS9360 Panoramic TriTech Detector	194
Conettix DX4020 Ethernet Network Interface Module	82,415	DS937 Panoramic Detector	188
CP500ALW Area Addressable LCD Codepad	29	DS9370 Series Panoramic TriTech Detector	196
CP500AW Area Addressable LED Codepad	30	DS9371 Panoramic TriTech Detector	198
CP500PW Partitionable LED Codepad	31	DS938Z and ZX938Z Series Panoramic PIR Detectors	190
CP508W LED Codepad	32	DS939 Panoramic Detector	192
CP516LW LCD Codepad	33	DX2010 Series Input Expander	68
CP516W LED Codepad	34	DX3010 Series Octo-output Expander	69
D		DX4010i RS-232 Serial Interface Module	87
D1222 Battery (12 V, 2.2 Ah)	104	E	
D1250 Battery (12 V, 5 Ah)	105	Easy Series Voice Modules	16
		Easy Series Intrusion Control Panel	2
		EMK 36 AT LSN Surface-Mount Magnetic Contact	345

EMK 36 LSN Built-in Magnetic Contact	343	ISN-CMINI-10 Miniature Contacts (9.5 mm)	249
EMK 36 S LSN Built-In Magnetic Contact	347	ISN-CMINI-10D Miniature Contacts with Thin Magnet (9.5 mm)	250
EMK 46 AT Z Surface-Mount Magnetic Contact	278	ISN-CMINI-15 Miniature Contacts (6.35 mm)	251
EMK 46 S Z Flush-Mount Magnetic Contact	259	ISN-CPB52 Reed Plunger Contacts	253
EMK 46 Z Built-in magnetic contact	261	ISN-CRB32 Roller Ball Contacts	256
F			
F220 Heat Detectors	234	ISN-CRFM-25 Oval Flange Contacts (6.35 mm)	248
F220 Photoelectric Smoke Detectors	231	ISN-CSD70 and ISN-CSD80 Compact Contacts	257
F220-B6 Series Conventional Detector Bases	236	ISN-CSM20-WG Commercial Contacts	270
F220-B6RS 24 VDC Four-wire Detector Base with Sounder	238	ISN-CSM35 Standard and Wide Gap Contacts	269
FAP-420/FAH-420 Automatic Fire Detectors LSN improved version	339	ISN-CSS-40 Super Stick Contacts with Side Leads	271
FAP-520 Automatic Fire Detectors LSN improved version	334	ISN-CSTB-10 Compact Contacts (9.5 mm)	240
G			
GBS 2036 LSN Passive Glass Break Detector	325	ISN-CSTB-10DM Contacts with Thin Magnet (9.5 mm)	241
GM 570 LSN Seismic Detector	322	ISN-CSTB-TC Terminal Connection Contacts (16 mm)	242
I			
IC 400 LSN Universal Expander	377	ISN-CTAP-10 Contacts (9.5 mm)	245
ICP-EZM2-EU Intrusion Control Panel	10	ISN-CTAP-15 Contacts (6.35 mm)	247
ICP-EZM2-LC Intrusion Control Panel	11	ISN-CTC75 Terminal Connection Contacts (19 mm)	244
ICP-EZM2-UK Intrusion Control Panel	10	ISN-SM Seismic Detectors	220
ICP-EZPK Programming Key	15,110	ISP-PDL1-WA18x Professional Series LSN TriTech+ Detectors with Anti-mask	306
ICP-EZPS Wire-in Power Supply	15,107	ISP-PPR1-WA16x Professional Series LSN PIR Detectors with Anti-mask	302
ICP-EZPS-FRA AFNOR Power Supply	14,107	ITS-300GSM Communicator	12,407
IPB-IF100 LSN 16 Zone Expander Module	367	IUI-CABLE/DACM Cable	94
IR 200 LSN Infrared Motion Detector	314	IUI-CARD/DACM Proximity Cards	93
IR 270 T LSNi Infrared Motion Detector, Antimask	317	IUI-CNTRL/DACM Controller	95
ISC-PDL1-W18x Professional Series TriTech Detectors	164	IUI-DTU/DACM Data Transfer Unit (DTU)	95
ISC-PDL1-WA18x Professional Series TriTech+ Detectors with Anti-mask	168	IUI-EZ1 Oval Control Center	9
ISC-PPR1-W16 Professional Series PIR Detector	136	IUI-EZT-5 Easy Series Token Package	111
ISC-PPR1-WA16x Professional Series PIR Detectors with Anti-mask	139	IUI-FOB/DACM Proximity Key Fobs	94
ISM-BLA1-CC Blue Line Color Camera Modules	286	IUI-READER/DACM Proximity Reader	96
ISM-BLA1-LM Blue Line Nightlight Module	288	IUI-READKP/DACM Proximity Reader with Keypad	96
ISM-BLA1-SM Blue Line Sounder Module	290	IUI-SWCD/DACM PC Software	97
ISM-BLD1 Blue Line TriTech Detectors	172	K	
ISM-BLD1-P Blue Line Pet Friendly TriTech Detectors	174	KD 55/1 LSN 2 Zone Expander Modules	379
ISM-BLP1 Blue Line PIR Detector	142	M	
ISM-BLP1-P Blue Line Pet-Friendly PIR Detector	145	MAGIC.SENS Automatic LSN Fire Detectors	327
ISM-BLQ1 Blue Line Quad PIR Detector	148	MAGIC.SENS Detector Base Sounders	331
ISN-C22 Compact Ball Reed Contacts	252	MK 48 SZ surface-mount magnetic contact	280
ISN-C45 Miniature Super Stick Contacts with Side Leads	272	MK 36 S LSN Surface-Mount Magnetic Contact	349
ISN-C50 Terminal Connection Contacts with Cover	267	MP1 Metal Pole, 1 m (3 ft)	293
ISN-C60 Slim Terminal Connection Contacts	268	MP2 Metal Pole, 1.2 m (4 ft)	294
ISN-C66 Track Mounted Overhead Door Contact	277	MP3 L-Curved Metal Pole	294
ISN-CAS Adjustable Screw Head Contacts	255	MSA-LSN B Surface-Mount Magnetic Contact	353
ISN-CFM-102 Flange Mount Contacts with Side Leads	273	MSA-LSN C Surface-Mount Magnetic Contact	357
ISN-CFM-106 Flange Mount Contacts with Center Leads	274	MSA-LZ Surface-Mount Magnetic Contact	282
ISN-CMET-200AR Commercial Metal Contact	276	MSA-LZS Surface-Mount Magnetic Contact	283
ISN-CMET-4418 Overhead Door Contact	275	MSE-LSN B Built-In Magnetic Contact	351
ISN-CMICRO Ultra Miniature Contacts	266	MSE-LSN C Built-In Magnetic Contact	355
		MS-LZ Flush-Mount Magnetic Contact	262
		MS-LZS Flush-Mount Magnetic Contact	263
		MX775i Multiplex PIR Intrusion Detector	156
		MX794i Long Range Multiplex PIR Detector	209
		MX934i Multiplex PIR Intrusion Detector	159
		MX938i Multiplex Intrusion Detector	200

N		V	
NAK 100 LSN Branch Interface	369	VR8 Desktop Alarm System	27
ND 100 GLT Panic Button	230	W	
ND 200 LSN Panic Button	366	WDSRP Remote Programming	116
NEV 300 LSN power supply	108,383	Software for Windows	456
NNK 110 LSN Emergency Call Coupler	371	wLSN Water Sensor/Low-temperature Sensor	436
NVK 100 LSN Coupler	374	wLSN Door-Window Contact	444
NZ 300 LSN Hold-up and Intrusion Control Panel	63	wLSN Dual Motion Detectors	440
O		wLSN Glassbreak Detector	430
OA120-2 Mirror	295	wLSN Hub	442
OD850 Series Outdoor TriTech Detectors	183	wLSN Inertia Sensor	458
OLR92-3 Long-range Lens	295	wLSN Installation Tool	450
OMB77-3 Barrier Mirror	296	wLSN Key Fob	452
OMLR77-3 Long-range Mirror	296	wLSN Mini Door-Window Contact	447
OMLR93-3 Long-range Mirror	297	wLSN PIR Motion Detector	454
P		wLSN Recessed Door-Window Contact	432
P6601 Battery Cable	404	wLSN Relay Module	434
P6602 Input and Output Cable	405	wLSN Siren (Indoor)	438
P6603 Acknowledgement Button	405	wLSN Smoke Detector for Europe	
PC1A Weather Enclosure	297		
PEH-2 Heater	298		
R			
Remote Programming Software International	114		
RF1100E Glassbreak Transmitter	475		
RF280THS Series Wireless Photoelectric			
Smoke Detectors	468		
RF3212 Series RF Receivers	462		
RF3222E RF Receiver (433.42 MHz)	464		
RF3227E RF Receiver (433.42 MHz)	466		
RF3332 Series Key Fobs	477		
RF3334 Series Key Fobs	479		
RF3401 Series RF Point Transmitters	481		
RF3405E Wireless (RF) Inertia Transmitter	483		
RF3501LE Panic Transmitter (433.42 MHz)	485		
RF3503E Panic-Medical Fob	487		
RF835 Series Wireless TriTech Detectors	470		
RF940E Wireless PIR Detector	473		
S			
SE 100 GLT SmartKey Arming Device	122		
SE 120 LSNi SmartKey Arming Device	126		
SE 220 LSNi SmartKey Arming Device	128		
SE 320 LSNi SmartKey Arming Device	131		
SE 50 GLT SmartKey Blocking Unit	120		
SE 60 LSNi SmartKey Blocking Unit	124		
SKA 100 LSN Bolt Contact	363		
SKI 100 LSN Bolt Contact	365		
Swiveling B335-3 low-profile mount	292		
T			
TP160 Trim Plate	299		
TP161 Trim Plate	299		
U			
UEZ 2000/1 LSN, UEZ 2000 LSN, Intrusion Control			
Centers	59		
UP 370 T LSN Matchtec Detector, Antimask	320		

Tradition of quality and innovation

For over 100 years, the Bosch name has stood for quality and reliability. Bosch Security Systems proudly offers a wide range of fire, intrusion, social alarm, CCTV, management and communication systems and components to help you find the solution for any application. We are the global supplier of choice for innovative technology backed by the highest level of service and support. When you need solutions you can rely on, choose Bosch.

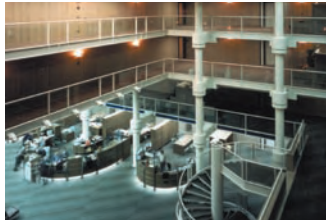

Bosch Security Systems

For more information please visit
www.boschsecurity.com
or send an e-mail to
emea.securitysystems@bosch.com

© Bosch Security Systems, 2008
Modifications reserved
Printed in Germany

Free Manuals Download Website

<http://myh66.com>

<http://usermanuals.us>

<http://www.somanuals.com>

<http://www.4manuals.cc>

<http://www.manual-lib.com>

<http://www.404manual.com>

<http://www.luxmanual.com>

<http://aubethermostatmanual.com>

Golf course search by state

<http://golfingnear.com>

Email search by domain

<http://emailbydomain.com>

Auto manuals search

<http://auto.somanuals.com>

TV manuals search

<http://tv.somanuals.com>