

GB

BENASSI S.p.A.

INSTRUCTIONS AND MAINTENANCE MANUAL MC 2300 "REVERSO"



24/04/1999

INTRODUCTION

Thank you for selecting a BENASSI SPA machine.

This manual contains all the information and necessary data for the preservation and proper use of the machine.

The better you know your agricultural machine, the safer will be your work; therefore we suggest you to read carefully and understand this **"INSTRUCTIONS AND MAINTENANCE"** manual before starting to work.

You will find important use notice relating to the use of the machine, which will help you to fully exploit its technical characteristics. You will also find useful information concerning carefulness and maintenance, important for your safety, guide to use and lasting preservation of your machine's value.

BENASSI SPA, in line with a policy of continuous technical improvement, reserves the right to change mechanical parts, finishing and accessories. Data concerning dimensions, weights and performances are intended with DIN rules allowances.

Pictures, descriptions and technical features are without obligation.

SERVICE AND WARRANTY

BENASSI SPA put at the customers' disposal its technical service to solve any problems concerning use and maintenance of the machines and points out that they all have 12 months (a year) warranty after purchase as far as defective material is concerned. In cases of difficulty please contact your retailer.

Please use **BENASSI SPA** products, original spare-parts and accessories; **BENASSI SPA** disclaims all responsibility for any alteration or improper application.

BENASSI SPA shall not be liable for the application to its machines of accessories made by third persons, without previous authorisation.

TABLE OF CONTENTS IN THIS MANUAL:

- | | |
|--|---|
| 1) Machine specifications | 11) Tools mounting and machine reversibility |
| 2) Technical features of the engines mounted on the different versions | 12) Machine starting |
| 3) Characteristics and drives captions | 13) Start of the work |
| 4) Dimensions and overall dimensions | 14) End of the work |
| 5) Packing and transport | 15) Use of the machine-Milling unit reversibility |
| 6) Accessories | 16) Maintenance and machine lubrication |
| 7) Symbols and decalcomania's | 17) Garaging |
| 8) Machine identification | 18) Troubleshooting |
| 9) Use of the machine | 19) Rules for a correct use of the machine |
| 10) Control description | 20) Accident-prevention rules |
| | 21) CE Declaration of the machine |

1 – TECHNICAL FEATURES OF THE MACHINE

ENGINE	4 strokes – 5 HP / 5,5 HP.
CLUTCH	Cone lined in oil bath.
GEARBOX	with gears in oil bath – 1 fwd. speed +1 rev. with wheel disengaging.
P.T.O	power mower version: 980 R.p.m. with sense of rotation Left. engine driven cultivator version: 640 R.p.m. with sense of rotation Right.
HANDLEBAR	adjustable in height and sideways – assembled on vibration dampers, 180° reversible.
WHEELS	tractor gummed 3.50.6 - 13.500.6 or iron.
TRACK	from cm. 38,5 with wheels 3.50.6 at cm. 43 with wheels 13.500.6.
TOOLS	power mower version: cutterbar cm 92 with eccentric motion, brush, snow turbine. engine driven cultivator version: cutter cm 40-50, plough, lister.
SPEED AT PEAK RPM	power mower version: km/hr 2,3 engine driven cultivator version: km/hr 1,5

2 TECHNICAL DATA OF THE ENGINES MOUNTED ON THE DIFFERENT VERSIONS

TECHNICAL FEATURES	MC 2300 D	MC 2300 H	MC 2300 HS	MC 2300	MC 2300 B
Engine	YANMAR L 48 AE DI	HONDA GX 160	HONDA GC 160	ACME A 200 B	BRIGGS & STRATTON
Weight Cultivator version	Kg. 81	Kg. 70	Kg. 66,5	Kg. 72	Kg. 75
Weight Lawn mower version	Kg. 85	Kg. 74	Kg. 70,5	Kg. 76	Kg. 79
Cycle	diesel	Otto (OHV)	Otto	Otto	Otto
kW - (HP)	3,48 (4,7)	4 - (5,5)	3,7 - (5)	4 (5,5)	3,7 (5,00)
Displacement	211 cc.	168 cc.	160 cc.	220	206
RPM	3.600	3.600	3.600	3.600	3.600
Consumption/HR	Kg./h 0,90	Kg./h 1.20	Kg./h. 1,15	Kg./h 1,82	Kg./h 1,60

ENGINES WHICH EQUIPS THE MACHINES HAVE ALL THE FOLLOWING CHARACTERISTICS:

- Starting with autowinding rope.
- Dry air-filter.
- Oil quantity in the engine 0,6 l.
- Working with standard car petrol 90/100 octanes ron. Diesel fuel MC 2300 D.
- Cone clutch in oil bath with lined hub for all versions.

3- CHARACTERISTICS AND DRIVES CAPTIONS

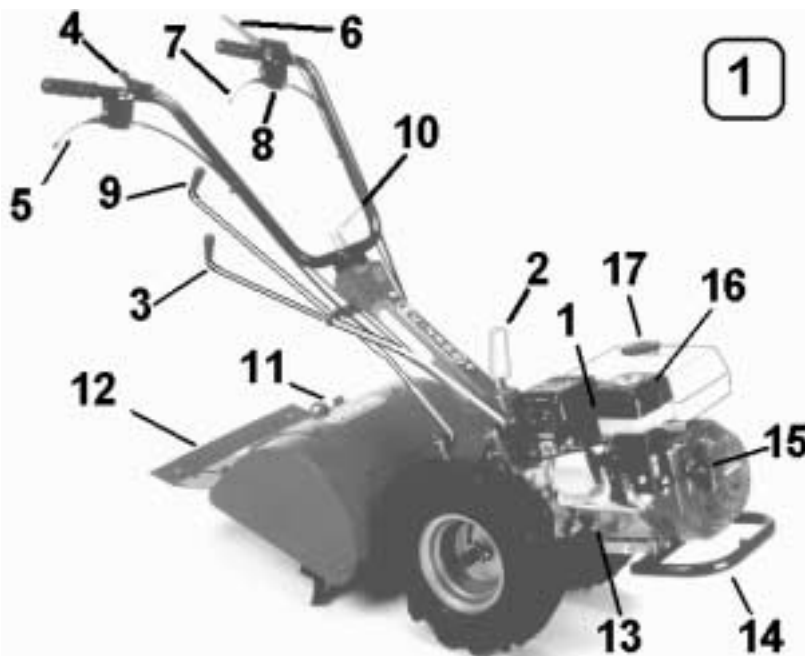

1. Spark plug
2. Locking lever for handlebar mount rotation
3. Gear lever
4. Accelerator hand lever
5. Wheel release lever
6. Engine stop lever
7. Clutch lever
8. Locking pushbutton
9. Power take-off engagement lever (cutter)
10. Locking lever for handlebar height adjustment
11. Adjustable spur
12. Adjustable hood panel for milling cutter

The machine is an engine driven cultivator. By changing tools or by turning the handlebars you can obtain different configurations for different uses as well.

With handlebars on the opposite side of the engine (Engine driven cultivator version, Picture 2) you can mount back tools (such as cutter, ploughs, listers etc.). This main version of the machine is used for soil working. With handlebars turned on the engine (Power mower version, Picture 2a) you can mount front tools (central cutterbar, lawn mower, snow turbine, brush, leveller, etc.).

4 – DIMENSIONS AND OVERALL DIMENSIONS

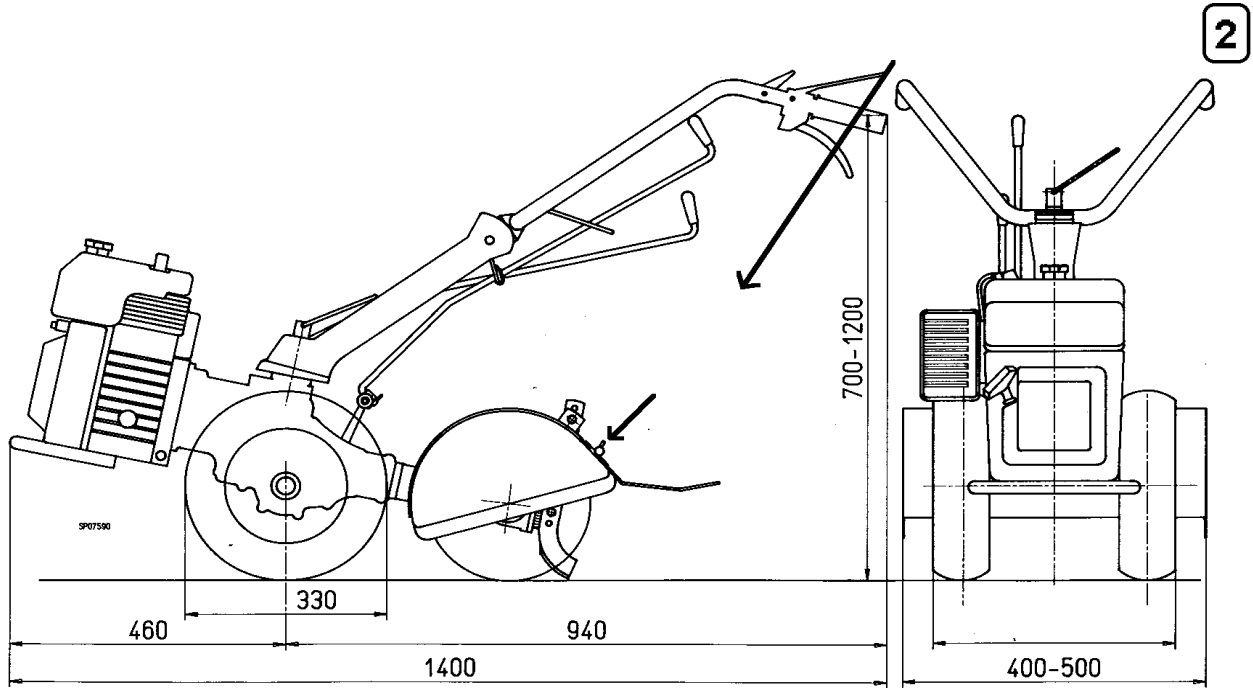

Engine driven cultivator version

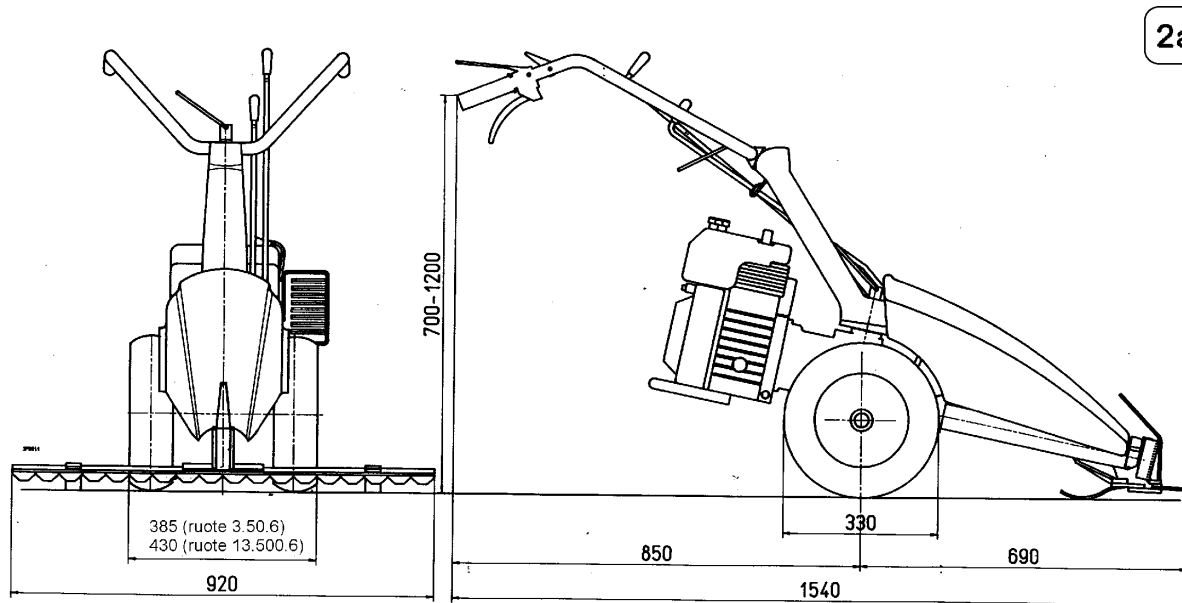

Power mower version

5 – PACKING AND TRANSPORT

The machine is normally delivered packed, without accessories, in carton boxes having the following dimensions and overall dimensions:

Machine packing : - WIDTH: 47 cm.- LENGTH cm: 71 - HEIGHT cm. 58











Mowing unit packing : - WIDTH: 38 cm.- LENGTH cm: 40 - HEIGHT cm. 50

Accessories are normally delivered separately from the machine; with or without packing.

To take the machine out of the packing and prepare it for work, proceed in the following way:

- a) Open and take the machine out of the packing, with a second person's help; mount the wheels and lock them with the suitable pin.
- b) Unscrew the hand lever (Ref. 10 Picture 1) and mount the handlebars at the desired height.
- c) Fill the engine with oil SAE 20-40 up to the mark on the oil dipstick, about 0,6 l. (SAE 20 for low temperatures, SAE 40 for warm climates).
- d) Assemble the accessories (see Picture 3 accessories).

6 -ACCESSORIES

	Mowing unit CM . 38-48 Cod. 94761600		Wheels torque 3.50.6 Cod. 97063300
			Wheels torque 13.500.6 Cod. 97063400
	Cutting unit cm. 92 with special cutterbar and spare blade Cod. 94564600		Plough Cod. 91062500
	Snow turbine cm.50 single-stage Cod. 97561200		Lister with arm Cod. 91063500
	Single-blade lawn mower cm.52 Cod. 96660600		Front-end leveller Cod. 97561100
	Weight for mowing bar (only for version with YANMAR engine) Cod. 98061400		Kit for wheels torque 3.50.8 Cod. 97063500

Picture 3

ALSO AVAILABLE:

- Transfer wheel unit cod. 97063000.
- Iron wheel torque Ø 370 x 100 cod. 97063100.
- Iron wheel torque Ø 370 x 50 cod. 97063200.
- Front ballast Kg. 10 cod. 98061200.
- Coupler head cod. 91063400.
- Wheel spacer torque cod. 94961800.

7 -SYMBOLS and DECALCOMANIA'S

On the machine, equipment and this manual there are symbols, writings and directions accompanied by this sign: it suggests the presence of a potential danger. Pay attention when you see it, read carefully and keep to what it says.



Do not remove or make the decalcomania's present on the machine unreadable. It is obligatory to clean them when dirty and immediately change them if detached or damaged.

8 -MACHINE IDENTIFICATION

The machine identifies itself with the type and part number of the gearbox. The part number of the engine is stamped (when it exists) by the producer on the plate of the engine itself or on the engine case. Identification data of the machine are carried forward on a plate placed on the machine. Report the label's data of the machine on the label's facsimile in order to have them always close at hand when necessary.

9 -USE OF THE MACHINE

The machine illustrated in this manual has been made only to be used in agriculture and mostly for the ground milling. Any use out of this agricultural one is considered an improper one. The producer disclaims all responsibility for damages or injuries resulting from the improper use of the machine. The respect of the working conditions, maintenance and repairs established by BENASSI SPA, according to the rules, are also part of the machine use. The machine can be used, subjected to maintenance and repaired only by someone who has previously read this manual and has been informed about its eventual dangers. Any alterations made on the machine excludes responsibility by side of the BENASSI SPA for the resulting damages.

10 – DRIVES DESCRIPTION

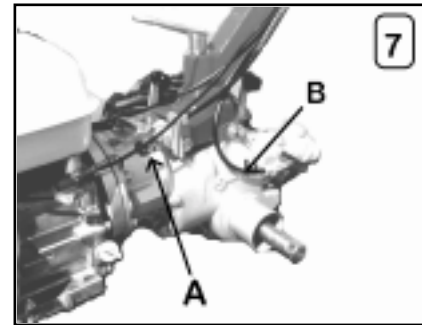
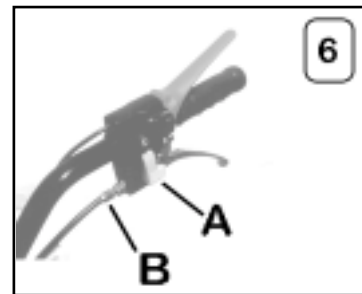
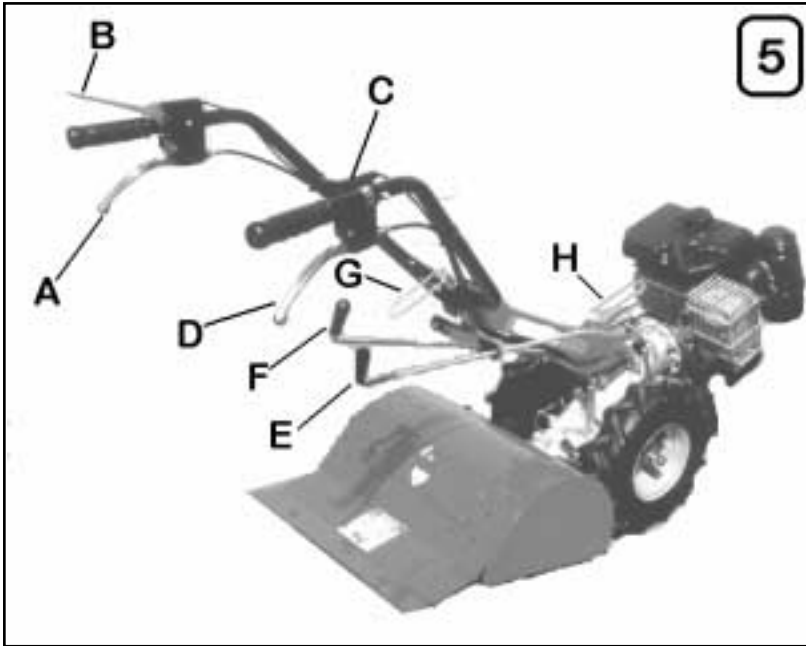

- A) **CLUTCH CONTROL LEVER** is used to disengage the engine from the transmission, it must be operated every time you operate levers and before stopping the machine. The lever is connected to the ENGINE-STOP (Ref. "B" - Picture 5); To ignite the machine engage and lock the clutch together with the lowered engine-stop, with the pushbutton outside the lever (Ref. "A" Picture 6). If the lever is not locked, the engine will not start since it is earthed. To unlock the clutch lever it is sufficient to pull lightly the lever upwards and the locking will be automatically released.
 - B) **ENGINE STOP LEVER** the main function of this safety device is to stop immediately the engine in the moment that one takes away his hands from the handlebars and to lock the clutch lever in engaged position (disengagement of the engine from the driveline organs) in order to prevent sudden starting of the machine during the ignition phase of the engine. If the clutch lever is not locked with the button inside the engine-stop in engaged position, the engine, being connected to earth, will not start. The engine-stop is also used to switch off the engine at the end of the work.
 - C) **ACCELERATOR HAND-LEVER** permits to increase or decrease the engine R.P.M. (power). By pushing it downwards clockwise you increase R.P.M.; by pushing it upwards counterclockwise you decrease them.
 - D) **WHEEL DISENGAGE LEVER** is used to disengage the wheels from transmission. This lever helps to move the machine when switched off.
 - E) **REVERSE LEVER** is used to reverse the machine motion; by pulling the lever in the cultivator version towards the driving place, the machine goes forwards, by pushing it forward the machine goes backwards. The speed in the cultivator version is slower than in the lawn mower version. A safety device does not allow to engage the reverse gear when the milling cutter is in motion. See Ref. "A" Picture 8. Before engaging the reverse gear disengage the milling cutter.
 - F) **P.T.O LEVER** is used to engage the power take-off to the different tools. By pushing the lever forward, in the lawn mower version, you disengage the power take-off, by pulling it towards the driving place you engage it. In the cultivator version, by pushing forward you engage the power take-off and by pulling the lever towards the driving place you disengage it.
 - G) **HAND LEVER FOR HANDLEBAR LOCKING** is used to adjust the handlebars in the most comfortable position to work. Once you have obtained the desired position, you have to tighten the hand lever.
 - H) **HAND LEVER FOR STEERING COLUMN LOCKING** is used to regulate sideways the handle and to 180° reverse the handle itself. By unscrewing the hand lever you release the steering column, which can pivot; once you have obtained the desired position tighten strongly. To 180° reverse the steering column take off the reverse levers and P.T.O and put them on again. The hand lever is pawl operated (see hand lever for handlebar locking).
- **FILLING AND VENT OIL CAP** (Ref. "A" - Picture 7).
 - **DISCHARGE GEARBOX OIL CAP.** (Ref. "A" Picture 14)
 - **LEVEL OIL SCREW** (Ref. "B" Picture 7)

11- TOOLS MOUNTING AND MACHINE REVERSIBILITY

- It is very easy to mount or to change tools to the machine. Tools are all quickcoupling type and don't need screws or fastening spanners for the locking.
- Tools are coupled in the machine body (male and female) and locked with a pin. The pin must be locked with the lever (Ref. "B" Picture 8) in order to avoid its disengagement.
- Assure that the tool part (male) to couple in the machine body is always well lubricated.
- To turn the handlebar steering column from the Cultivator version (back tools) to the Power mower version (front tools) proceed in the following way:
 - 1) Take off the speed selector levers PTO completely, unscrew the hand lever steering column (Ref. "H" Picture 5), turn 180° the steering column **counterclockwise**, tighten thoroughly the hand lever and insert the levers again, not forgetting to lock them with its cotter pins, making them pass through the two holes with fairlead on the left of the handle support.
 - 2) Take off the safety locking rod for reverse gear, (Ref. "A" Picture 8), slipping off the two special cotter pins, (Ref. "C" Picture 8).
- To pass from the Power mower version to the Cultivator version proceed in the same way, turning **clockwise** the steering column. Put the safety locking rod for reverse gear again, (Ref. "A" Picture 8).

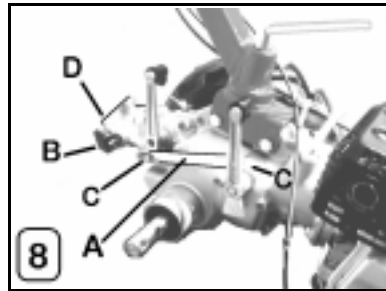

ATTENTION:

When you turn the steering column you have to turn the wheels as well: the Right to the Left, the Left to the Right. Picture 9 shows the correct position (see groove)

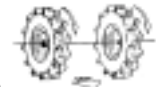

Picture 9

12 MACHINE STARTING

	<p>BEFORE USING THE MACHINE MAKE SURE YOU LEARN HOW TO STOP IT; IN CASE OF BREAKDOWN OR NECESSITY TAKE IMMEDIATELY THE LEFT HAND AWAY FROM THE HANDLE (ENGINE STOP).</p>
--	--

Before starting the machine always control :

- the oil levels in the engine with the proper oil dipstick and in the gear box by means of the suitable screw (make this only when the machine is new and every 50 hours) ;
- that in the air-filter (if in oil bath) oil reaches the reference notch;
- that tyres have the right pressure (Atm. 1,3) and are correctly oriented (see Picture 9) ;
- that all screws and nuts are well fastened;
- that all levers are in neutral position;
- that the clutch lever has some freeplay;
- that there is fuel in the tank, the refuelling must be done with a funnel complete of filter in order to avoid the introduction of impurity;
- **Before starting the machine make sure there are not walls or obstacles behind you.**

To start the machine proceed in the following way:

- 1) Engage the clutch, (Ref. "A" Picture 5), lower the ENGINE STOP lever, (Ref. "B" Picture 5) and lock both with the rectangular pushbutton inside the left handle, (Ref. "A" Picture 6) (ENGINE STOP device).
 - 2) Close the air to the carburettor (starter), open the fuel cock, position the accelerator hand lever, (Ref. "C" Picture 5), at ½ gas and pull vigorously the rope of the ignition, (Ref."15" picture 1). When the engine is running release the starter.
 - 3) Warm up the engine for some minutes before starting to work.
- When the engine is new, make some running in period.**

13 – START OF THE WORK

Accurately inspect the work area, removing foreign objects (iron wires, stones, sticks, glasses etc.), since they could cause dangerous and sudden reactions of the machine.

Engage the clutch, the ENGINE STOP pushbutton will release itself, then put into gear and power take-off, giving little clutch-touches if it does not immediately engage.

Accelerate opportunely the engine and release the clutch to start working.



ATTENTION If the power take-off is engaged, you cannot engage the reverse gear. In this case disengage the power take-off and then engage the reverse gear. It is impossible to insert the milling cutter when the reverse gear is engaged.

14 – END OF THE WORK

Once you have ended your work, to stop the engine close the fuel cock and push the STOP ENGINE button or release the ENGINE STOP lever. (Ref. "B" Picture 5).

15 USE OF THE MACHINE – MILLING UNIT REVERSIBILITY

The principal uses of the machine are:
 Cultivator version (See Picture 2);
 Power mower version (See Picture 2a).



IMPORTANT :
Before doing the operations described below, switch off the engine.

The milling unit (Picture 11) can be mounted so that the mowing rotation corresponds to the advancing wheel rotation or contrary to it. See the dart indication on the mowing unit side.

To change the rotation take out the hood panel for milling cutter unscrewing the two bolts (Ref. "A" Picture 10) and the bolt (Ref. B Picture 10).

Slip the milling transmission unit off by pulling the lever (Ref. B Picture 8), remove the spur (Ref. A Picture 11), taking off the bolt (Ref. A Picture 11) and mount it again upside-down. Then mount the hood panel for milling cutter again on the transmission unit upside-down making all the inverse process.

The milling cutter hood panel can enable, through two adjustable sides (Ref. "B" and "C" Picture 11) two working width, cm. 40 and 50.

In the narrower version, the milling blades of the external cutters have to be screwed and turned inwards (Ref. "D" Picture 11).

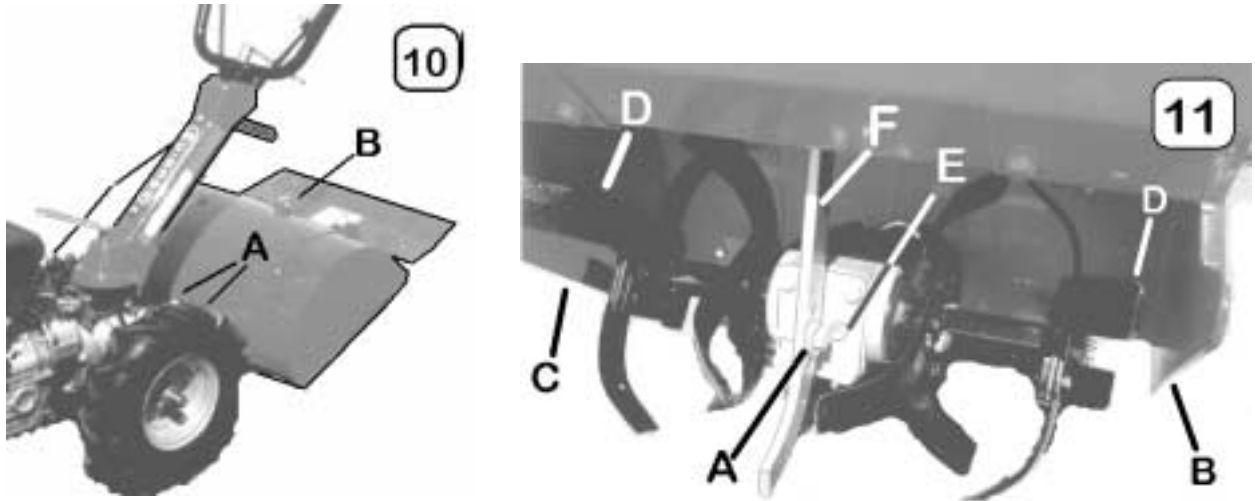

16 MAINTENANCE AND LUBRICATION

A good maintenance and a perfect lubrication are both necessary operations to keep your machine perfectly efficient. The machine is normally delivered packed and without engine oil, as it is indicated on the note applied to the engine.

ENGINE

Please follow the specific "ENGINE USE AND MAINTENANCE" booklet provided with the machine for instructions, use and maintenance of the engine.

It is a good rule to control the oil level every 5 hours of work and to change it every 50 hours. Use oil **SAE 40** in summer and **SAE 20** in winter. The first oil change must be done after 10 hours of work.

Control that the air-filter is clean, if the filter is in oil bath control the level every 8-10 hours of work or even more frequently if you are working in dusty grounds. Use engine oil to restore the oil level; before refilling the oil tank, wash it carefully.

GEAR BOX

Control the oil level every 50 hours of work by taking out the cap on the gear box case (the machine must be in the horizontal position).

If necessary, add oil **SAE 80-90**. It is suggested to change oil at least once a year. To empty the oil in the gear box, unscrew the cap of the inferior part of the box (Ref. "A" Picture 14), take out the oil cap (Ref. "A" picture 7) to allow the oil flowing out more easily. Put the inferior cap again and fill with oil through the cap (Ref. "A" Picture 7) up to the screw level (Ref. "B" Picture 7).

MILLING CUTTER

Before starting to work, control that all screws are well fastened, especially those of the mill hoes.

Control the oil level of the milling cutter transmission unit every 100 hours of work, by taking out the cap on the lid (Ref. "E" Picture 11). Oil must fill almost completely the gearbox case. Use **SAE 80-90** oil.

CUTTERBAR

- Before starting to work, control that all screws are tight fastened.
- Every 4 hours of work lubricate the inside of the blade head.
- Every 10 hours of work lubricate the eccentric ferrule - (Ref. "A" Picture 12).
- Every 20 hours of work lubricate the linkage between the cutterbar and the machine.
- Periodically it is needed to control bladeholders (Ref. "B" Picture 12) so that the blade has not too much freeplay or is fastened too tight. If the cutting of the grass after the adjustments is not satisfying, the blade needs to be grinded or changed.



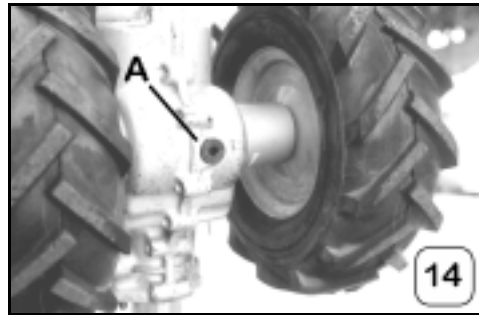

17 - GARAGING

Before garaging the machine:

- Wash it carefully with Diesel fuel, change the engine oil, gear box and milling unit .
- Empty the fuel tank and wash or change the air-filter.
- Oil and lubricate every joints and mechanism.
- Change or repair eventual damaged parts.
- Park the machine in a dry room, putting its wheels on wooden boards or, even better, lifted from the ground.

18 - TROUBLESHOOTING

Eventual troubles which can be solved by the operator (worker) :

ENGINE :

The engine doesn't start; control that:

- Fuel in the tank reaches half of the tank itself .
- The fuel cock is open.
- The starter must be engaged if the engine is cold.
- Fuel arrives to the carburettor.
- The vent cap on the tank is not clogged.
- The carburettor castings are open; other wise clean them with compressed air.
- The ignition spark works: to test this, unscrew the spark plug, reconnect it to the electric cable, lean the metallic part of the spark plug to mass (working cylinder) and turn the engine pulley as for the starting . If the ignition spark does not spark among the electrodes, control the joints of the electric cable. Other wise change the spark plug with another one . If even this attempt fails, the breakdown has to be attributed to the lighting set (points, capacitor, coils etc.). In this case we suggest to apply to the nearest service relating the engine mounted on the machine.

GEARS DO NOT ENGAGE :

- Regulate the clutch by unscrewing the register screw (Ref. "B" Picture 6) till you obtain a good clutch disengagement.
- Pay attention: do not eliminate totally the freeplay.
- The clutch wire must not be completely engaged.

19 – RULES FOR A CORRECT USE OF THE MACHINE

- Make a good running in period to the engine and the machine (for at least 10 hours do not get over 70 % of the engine capacity).
- Always use the clutch before operating any levers.
- Do not leave the clutch disengaged for a long time.
- Never force the speed selector levers and PTO, if they do not engage leave gradually the clutch.
- Keep the steering column joint and the handlebar cleaned and oiled.
- Never force the engine; when smoke comes out from the exhausting pipe, it means that the engine is under stress.
- Do not work for long periods of time at full speed, in particular during warm periods.
- Periodically control the tyre pressure (Atm. 1,3)
- During the mounting of the different tools do not damage the dowels (Ref. "D" Picture 8) and the splines, control that screws and the fastening spine of the tools are well locked, especially screws of the mill hoes and the fastening screws of the cutterbar.
- Do not leave the machine under the rain.

20 – ACCIDENT-PREVENTION RULES

ATTENTION, IT IS DANGEROUS:



- To leave the engine running in closed rooms; exhaust gases are highly toxic.
- To refuel with the engine running or overheated.
- To accelerate going to reverse; the engine must be at minimum speed.
- To make tests, to clean and to repair tools (milling cutter, cutterbar, lawn mower etc.) with the engine running.
- To touch the just switched off engine (some parts may burn).
- To move with the cutterbar without protection.
- To execute the operations of transport, maintenance, repair and lubrication with the engine not switched off and without all the protections mounted.
- On means of transport the machine must be well fastened with proper locking.
- The cutter protections must be adjusted according to the depth of the work , so that the part of the tool which cuts the ground remains uncovered; never make hoeing operations without the back hood panel on the machine.
- Keep always efficient the safety disposals (above all the automatic engine stop) and the protections of the rotating elements.
- Before starting to work make sure there are not persons or obstacles in the machine range of action inferior to 5 meters.
- Wear proper shoes and clothes, do not wear large or fluttering clothes (scarf or foulard).
- Never work in sloping grounds without having assured the machine stability. Attention! Do not work in grounds with a more than 50 % slope.
- Keep the fuel in proper tanks.

- The refuelling must be done in airy places, with the engine switched off and cold. During this operation do not smoke, if the fuel comes out (especially petrol) dry the wet parts and if possible blow away with compressed air, move the machine in a dry place before starting it.
- To move the machine from a work ground to another one or during the reverse manoeuvres, before starting the work again always disengage the power take-off to stop the moving organs.
- The waste disposal of lubricators and batteries must be done in conformity with the rules in force in the country where the machine is used.
- Before leaving the machine, disengage the power take-off, stop the engine and take away the plug spark cap.
- **Read carefully the Use and Maintenance booklet provided with the machine.**
- The use of the machine is forbidden to persons under 16.
- The operator is responsible for the damages, since he is the driver of the machine.
- Dry the petrol leakage.
- Refill the tank with the engine switched off. The refuelling and/or the fuel pouring off must always be done outside, far from fire or heat sources. **Do not smoke** during this operation.
- Before starting to use the engine driven cultivator, it is necessary to learn how to rapidly switch the engine off, to familiarise with the drives and to learn how to properly use the machine. Do not make the engine run where outlets with carbonic oxide could accumulate.
- **We disclaim all responsibility for incidents caused by non-observance of these rules.**

ATTENTION: during the continuative use of the machine the use of hearing protection devices is recommended.



21 CE DECLARATION OF THE MACHINE

CE Declaration of conformity according to CEE Directives CEE 89/392 and following modifications.

CE Declaration of conformity according to CEE directives 89/392 and following modifications.

BENASSI 40010 San Matteo della Decima BO Italy Via Lampedusa n° 1

We declare under our sole responsibility that the machine is in conformity with the essential safety and health protection requirements according to CEE 89/392 Directive and its following modifications.

TYPE **ENGINE DRIVEN CULTIVATOR** MODEL **MC 2300**

For the conformity test according to the Directives mentioned above, the following regulations have been consulted: PREN 709/94 of 16/06/94.

MANAGING DIRECTOR

Tassinari Lello

S. Matteo della Decima li 26/11/98

RESULT AND TESTS

TYPE **ENGINE DRIVEN CULTIVATOR**

MODEL **MC 2300 "REVERSO"**

Sound pressure at the operator's ear : LAeq = 93 dB (A)

Test conditions: height 1,6 Mt handlebar centre

Handlebar vibration with ISO.5349 assessment value 19,6 m/sec²

BENASSI[®] S.p.A

VIA LAMPEDUSA 1

40010 S. MATTEO DELLA DECIMA (BO) - ITALY

TEL. 0039/051/82.05.34 TELEFAX 0039/051/682.61.64

Retailer stamp

Free Manuals Download Website

<http://myh66.com>

<http://usermanuals.us>

<http://www.somanuals.com>

<http://www.4manuals.cc>

<http://www.manual-lib.com>

<http://www.404manual.com>

<http://www.luxmanual.com>

<http://aubethermostatmanual.com>

Golf course search by state

<http://golfingnear.com>

Email search by domain

<http://emailbydomain.com>

Auto manuals search

<http://auto.somanuals.com>

TV manuals search

<http://tv.somanuals.com>