

brother®

USER'S GUIDE

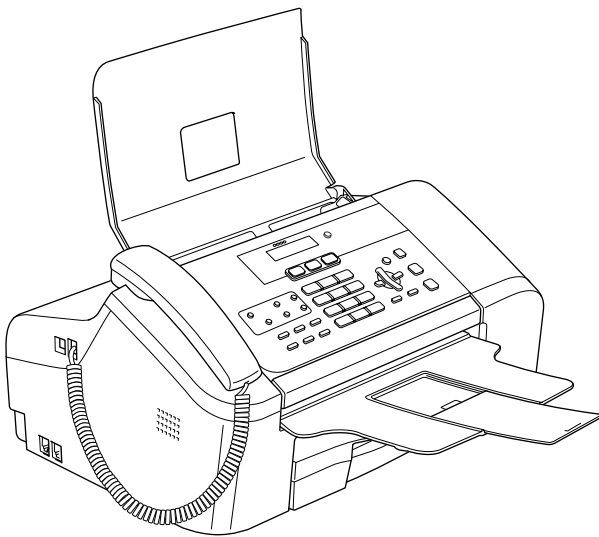

MFC-3360C
FAX-1860C
FAX-1960C

Version A

If you need to call Customer Service

Please complete the following information for future reference:

**Model Number: MFC-3360C, FAX-1860C
and FAX-1960C (USA only)
(Circle your model number)**

Serial Number: ¹ _____

Date of Purchase: _____

Place of Purchase: _____

¹ The serial number is on the back of the unit. Retain this User's Guide with your sales receipt as a permanent record of your purchase, in the event of theft, fire or warranty service.

Register your product on-line at

<http://www.brother.com/registration/>

By registering your product with Brother, you will be recorded as the original owner of the product. Your registration with Brother:

- may serve as confirmation of the purchase date of your product should you lose your receipt;
- may support an insurance claim by you in the event of product loss covered by insurance; and,
- will help us notify you of enhancements to your product and special offers.

The most convenient and efficient way to register your new product is on-line at <http://www.brother.com/registration/>

© 2006 Brother Industries, Ltd.

Brother numbers

IMPORTANT

For technical help, you must call the country where you bought the machine. Calls must be made **from within** that country.

Register your product

By registering your product with Brother International Corporation, you will be recorded as the original owner of the product. Your registration with Brother:

- may serve as confirmation of the purchase date of your product should you lose your receipt;
- may support an insurance claim by you in the event of product loss covered by insurance; and,
- will help us notify you of enhancements to your product and special offers.

Please complete and fax the Brother Warranty Registration And Test Sheet or, for your convenience and most efficient way to register your new product, register on-line at

<http://www.brother.com/registration/>

FAQs (frequently asked questions)

The Brother Solutions Center is our one-stop resource for all your Fax Machine/Multi-Function Center needs. You can download the latest software documents and utilities, read FAQs and troubleshooting tips, and learn how to get the most from your Brother product.

<http://solutions.brother.com>



Note

- You can check here for Brother driver updates.
- To keep your machine performance up to date, check here for the latest firmware upgrade (for Windows® only).

For Customer Service

In USA: 1-800-284-4329 (voice)
1-901-379-1215 (fax)
1-800-284-3238 (TTY service for the hearing-impaired)

In Canada: 1-877-BROTHER (voice)
(514) 685-4898 (fax)

Service Center Locator (USA only)

For the location of a Brother authorized service center, call 1-800-284-4357.

Service Center Locations (Canada only)

For the location of a Brother authorized service center, call 1-877-BROTHER.

Brother fax back system (USA only)

Brother has installed an easy-to-use fax back system, so you can get instant answers to common technical questions and product information for all Brother products. This system is available 24 hours a day, 7 days a week. You can use the system to receive faxed instructions and an Index of fax back subjects.

In USA only: 1-800-521-2846

Ordering accessories and supplies

For best quality results use only genuine Brother accessories, which are available at most Brother retailers. If you cannot find the accessory you need and you have a Visa, MasterCard, Discover, or American Express credit card, you can order accessories directly from Brother. (In the USA, you can visit us online for a complete selection of the Brother accessories and supplies that are available for purchase.)

In USA: 1-888-879-3232 (voice)
1-800-947-1445 (fax)

<http://www.brothermall.com>

In Canada: 1-877-BROTHER (voice)

Description	Item
Ink Cartridge Standard <black>	LC51BK (Prints approx. 500 pages)
Ink Cartridge <yellow>	LC51Y (Prints approx. 400 pages)
Ink Cartridge <cyan> (blue)	LC51C (Prints approx. 400 pages)
Ink Cartridge <magenta> (red)	LC51M (Prints approx. 400 pages)
Premium Glossy Photo Paper (Letter size / 20 sheets) (4"X6" size / 20 sheets)	BP61GLL ¹ BP61GLP ¹
Matte Inkjet Paper (Letter size / 25 sheets)	BP60ML (USA only)
Inkjet Plain Paper (Letter size / 250 sheets)	BP60PL (USA only)
Telephone Line Cord	LG3077001 (USA only)
Telephone Handset	LF380004 (USA only)
Handset Curled Cord	LG3768004 (USA only)
Cordless Handset (FAX-1960 only)	BCL-D10 (USA only)
Battery (FAX-1960 only)	BCL-BT10 (USA only)
User's Guide	LP5674001 (English for USA and Canada) LP3293002 (French For Canada)

¹ Available in the USA and from November 2006 in Canada.

Notice - Disclaimer of Warranties (USA and Canada)

BROTHER'S LICENSOR(S), AND THEIR DIRECTORS, OFFICERS, EMPLOYEES OR AGENTS (COLLECTIVELY BROTHER'S LICENSOR) MAKE NO WARRANTIES, EXPRESS OR IMPLIED, INCLUDING WITHOUT LIMITATION THE IMPLIED WARRANTIES OF MERCHANTABILITY AND FITNESS FOR A PARTICULAR PURPOSE, REGARDING THE SOFTWARE. BROTHER'S LICENSOR(S) DOES NOT WARRANT, GUARANTEE OR MAKE ANY REPRESENTATIONS REGARDING THE USE OR THE RESULTS OF THE USE OF THE SOFTWARE IN TERMS OF ITS CORRECTNESS, ACCURACY, RELIABILITY, CURRENTNESS OR OTHERWISE. THE ENTIRE RISK AS TO THE RESULTS AND PERFORMANCE OF THE SOFTWARE IS ASSUMED BY YOU. THE EXCLUSION OF IMPLIED WARRANTIES IS NOT PERMITTED BY SOME STATES IN THE USA AND SOME PROVINCES IN CANADA. THE ABOVE EXCLUSION MAY NOT APPLY TO YOU.

IN NO EVENT WILL BROTHER'S LICENSOR(S) BE LIABLE TO YOU FOR ANY CONSEQUENTIAL, INCIDENTAL OR INDIRECT DAMAGES (INCLUDING DAMAGES FOR LOSS OF BUSINESS PROFITS, BUSINESS INTERRUPTION, LOSS OF BUSINESS INFORMATION, AND THE LIKE) ARISING OUT OF THE USE OR INABILITY TO USE THE SOFTWARE EVEN IF BROTHER'S LICENSOR HAS BEEN ADVISED OF THE POSSIBILITY OF SUCH DAMAGES. BECAUSE SOME STATES IN THE USA AND SOME PROVINCES IN CANADA DO NOT ALLOW THE EXCLUSION OR LIMITATION OF LIABILITY FOR CONSEQUENTIAL OR INCIDENTAL DAMAGES, THE ABOVE LIMITATIONS MAY NOT APPLY TO YOU. IN ANY EVENT BROTHER'S LICENSOR'S LIABILITY TO YOU FOR ACTUAL DAMAGES FROM ANY CAUSE WHATSOEVER, AND REGARDLESS OF THE FORM OF THE ACTION (WHETHER IN CONTRACT, TORT (INCLUDING NEGLIGENCE), PRODUCT LIABILITY OR OTHERWISE), WILL BE LIMITED TO \$50.

Compilation and Publication Notice

Under the supervision of Brother Industries Ltd., this manual has been compiled and published, covering the latest product descriptions and specifications.

The contents of this manual and the specifications of this product are subject to change without notice.

Brother reserves the right to make changes without notice in the specifications and materials contained herein and shall not be responsible for any damages (including consequential) caused by reliance on the materials presented, including but not limited to typographical and other errors relating to the publication.

Brother® One Year Limited Warranty and Replacement Service (USA only)

Who is covered:

- This limited warranty (“warranty”) is given only to the original end-use/retail purchaser (referred to in this warranty as “Original Purchaser”) of the accompanying product, consumables and accessories (collectively referred to in this warranty as “this Product”).
- If you purchased a product from someone other than an authorized Brother reseller in the United States or if the product was used (including but not limited to floor models or refurbished product), prior to your purchase you are not the Original Purchaser and the product that you purchased is not covered by this warranty.

What is covered:

- This Product includes a Machine and Consumable and Accessory Items. Consumable and Accessory Items include but are not limited to print heads, toner, drums, ink cartridges, print cartridges, refill ribbons, therma PLUS paper, thermal paper, and the cordless handset battery.
- Except as otherwise provided herein, Brother warrants that the Machine and the accompanying Consumable and Accessory Items will be free from defects in materials and workmanship, when used under normal conditions.
- This warranty applies only to products purchased and used in the United States. For products purchased in, but used outside, the United States, this warranty covers only warranty service within the United States (and does not include shipping outside the United States).

What is the length of the Warranty Periods:

- Machines: one year from the original purchase date.
- Accompanying Consumable and Accessory Items: 90 days from the original purchase date or the rated life of consumable, whichever comes first.

What is NOT covered:

This warranty does not cover:

- 1 Physical damage to this Product;
- 2 Damage caused by improper installation, improper or abnormal use, misuse, neglect or accident (including but not limited to transporting this Product without the proper preparation and/or packaging);

- 3 Damage caused by another device or software used with this Product (including but not limited to damage resulting from use of non Brother®-brand parts and Consumable and Accessory Items);
- 4 Consumable and Accessory Items that expired in accordance with a rated life; and,
- 5 Problems arising from other than defects in materials or workmanship.
- 6 Normal Periodic Maintenance Items, such as Paper Feeding Kit, Fuser and Laser Units.

This limited warranty is VOID if this Product has been altered or modified in any way (including but not limited to attempted warranty repair without authorization from Brother and/or alteration/removal of the serial number).

What to do if you think your Product is eligible for warranty service:

Report your issue to either our Customer Service Hotline at 1-800-284-4329 for Fax, MFC and DCP and 1-800-276-7746 for Printers, or to a Brother Authorized Service Center **within the applicable warranty period.** Supply Brother or the Brother Authorized Service Center with a copy of your dated bill of sale showing that this Product was purchased within the U.S. For the name of local Brother Authorized Service Center(s), call 1-800-521-2846.

What Brother will ask you to do:

After contacting Brother or a Brother Authorized Service Center, you may be required to deliver (by hand if you prefer) or send the Product properly packaged, freight prepaid, to the Authorized Service Center together with a photocopy of your bill of sale.

You are responsible for the cost of shipping, packing product, and insurance (if you desire). You are also responsible for loss or damage to this Product in shipping.

What Brother will do:

If the problem reported concerning your Machine and/or accompanying Consumable and Accessory Items is covered by this warranty and if you first reported the problem to Brother or an Authorized Service Center within the applicable warranty period, Brother or its Authorized Service Center will repair or replace the Machine and/or accompanying Consumable and Accessory Items at no charge to you for parts or labor. The decision as to whether to repair or replace the Machine and/or accompanying Consumable and Accessory Items is made by Brother in its sole

Brother® One Year Limited Warranty and Replacement Service (USA only)

discretion. Brother reserves the right to supply a refurbished or remanufactured replacement Machine and/or accompanying Consumable and Accessory Items and use refurbished parts provided such replacement products conform to the manufacturer's specifications for new product/parts. The repaired or replacement Machine and/or accompanying Consumable and Accessory Items will be returned to you freight prepaid or made available for you to pick up at a conveniently located Authorized Service Center.

If the Machine and/or accompanying Consumable and Accessory Items are not covered by this warranty (either stage), you will be charged for shipping the Machine and/or accompanying Consumable and Accessory Items back to you and charged for any service and/or replacement parts/products at Brother's then current published rates.

The foregoing are your sole (i.e., only) and exclusive remedies under this warranty.

What happens when Brother elects to replace your Machine:

When a replacement Machine is authorized by Brother, and you have delivered the Machine to an Authorized Service Center, the Authorized Service Center will provide you with a replacement Machine after receiving one from Brother. If you are dealing directly with Brother, Brother will send to you a replacement Machine with the understanding that you will, after receipt of the replacement Machine, supply the required proof of purchase information, together with the Machine that Brother agreed to replace. You are then expected to pack the Machine that Brother agreed to replace in the package from the replacement Machine and return it to Brother using the pre-paid freight bill supplied by Brother in accordance with the instructions provided by Brother. Since you will be in possession of two machines, Brother will require that you provide a valid major credit card number. Brother will issue a hold against the credit card account number that you provide until Brother receives your original Product and determines that your original Product is entitled to warranty coverage. Your credit card will be charged up to the cost of a new Product only if: (i) you do not return your original Product to Brother within five (5) business days; (ii) the problems with your original Product are not covered by the limited warranty; (iii) the proper packaging instructions are not followed and has caused damage to the product; or (iv) the warranty period on your original Product has expired or

has not been sufficiently validated with a copy of the proof of purchase (bill of sale). The replacement Machine you receive (even if refurbished or remanufactured) will be covered by the balance of the limited warranty period remaining on the original Product, plus an additional thirty (30) days. You will keep the replacement Machine that is sent to you and your original Machine shall become the property of Brother. **Retain your original Accessory Items and a copy of the return freight bill, signed by the courier.**

Limitations:

Brother is not responsible for damage to or loss of any equipment, media, programs or data related to the use of this Product. Except for that repair or replacement as described above, Brother shall not be liable for any direct, indirect, incidental or consequential damages or specific relief. Because some states do not allow the exclusion or limitation of consequential or incidental damages, the above limitation may not apply to you.

THIS WARRANTY IS GIVEN IN LIEU OF ALL OTHER WARRANTIES, WRITTEN OR ORAL, WHETHER EXPRESSED BY AFFIRMATION, PROMISE, DESCRIPTION, DRAWING, MODEL OR SAMPLE. ANY AND ALL WARRANTIES OTHER THAN THIS ONE, WHETHER EXPRESS OR IMPLIED, INCLUDING IMPLIED WARRANTIES OF MERCHANTABILITY AND FITNESS FOR A PARTICULAR PURPOSE, ARE HEREBY DISCLAIMED.

- This Limited Warranty is the only warranty that Brother is giving for this Product. It is *the final expression and the exclusive and only statement* of Brother's obligations to you. It replaces all other agreements and understandings that you may have with Brother or its representatives.
- This warranty gives you certain rights and you may also have other rights that may vary from state to state.
- This Limited Warranty (and Brother's obligation to you) may not be changed in any way unless you and Brother sign the same piece of paper in which we (1) refer to this Product and your bill of sale date, (2) describe the change to this warranty and (3) agree to make that change.

Important:

We recommend that you keep all original packing materials, in the event that you ship this Product.

BROTHER MULTIFUNCTION CENTER/FACSIMILE MACHINE LIMITED WARRANTY (Canada only)

Pursuant to this limited warranty of 1 year from the date of purchase for labour and parts, Brother International Corporation (Canada) Ltd. ("Brother"), or its Authorized Service Centers, will repair this MFC/Facsimile machine free of charge if defective in material or workmanship. This Limited Warranty does not include cleaning, consumables (including, without limitation, print cartridges, print head, toner and drum) or damage caused by accident, neglect, misuse or improper installation or operation, any damage caused from service, maintenance, modifications, or tampering by anyone other than a Brother Authorized Service Representative, or from the use of supplies or consumable items that are non-Brother products. Operation of the MFC/Facsimile machine in excess of the specifications or with the Serial Number or Rating Label removed shall be deemed abuse and all repairs thereafter shall be the sole liability of the end-user/purchaser. In order to obtain warranty service, the MFC/Facsimile machine must be delivered or shipped freight prepaid by the end user/purchaser to a "Brother" Authorized Service Center, together with your Proof of Purchase in the form of a Sales Receipt.

For laser products: Failure to remove the Toner Cartridge (and Toner Drum Unit on applicable models) during shipping will cause severe damage to the MFC/Facsimile and will VOID the Warranty. (Refer to your User's Guide for proper packaging.)

For ink-jet products: Do not remove the ink cartridges during shipping. Damage to your print head resulting from packing without the ink cartridges will VOID your warranty. (Refer to your User's Guide for proper packaging.)

BROTHER DISCLAIMS ALL OTHER WARRANTIES EXPRESSED OR IMPLIED INCLUDING, WITHOUT LIMITATION, ANY IMPLIED WARRANTIES OF MERCHANTABILITY OR FITNESS FOR A PARTICULAR PURPOSE, EXCEPT TO THE EXTENT THAT ANY WARRANTIES IMPLIED BY LAW CANNOT BE VALIDLY WAIVED.

No oral or written information, advice or representation provided by Brother, its Authorized Service Centers, Distributors, Dealers, Agents or employees, shall create another warranty or modify this warranty. This warranty states Brother's entire liability and your exclusive remedy against Brother for any failure of the MFC/Facsimile machine to operate properly.

Neither Brother nor anyone else involved in the development, production, or delivery of this MFC/Facsimile machine shall be liable for any indirect, incidental, special, consequential, exemplary, or punitive damages, including lost profits, arising from the use of or inability to use the product, even if advised by the end user/purchaser of the possibility of such damages. Since some Provinces do not allow the above limitation of liability, such limitation may not apply to you.

This Limited Warranty gives you specific legal rights and you may also have other rights which vary from Province to Province.

Warranty Service is available at Brother Authorized Service Centers throughout Canada. For Technical Support or for the name and location of your nearest Authorized Service Center call 1-877-BROTHER.

Internet support: support@brother.ca or browse

Brother's Web Site: www.brother.com

Brother International Corporation (Canada) Ltd.

1 Rue Hôtel de Ville

Dollard-Des-Ormeaux, QC H9B 3H6

At your side.
brother®

Table of Contents

Section I General

1	General Information	2
	Using the documentation	2
	Symbols and conventions used in the documentation	2
	Accessing the Software User's Guide (MFC-3360C only).....	2
	Viewing Documentation	2
	Accessing Brother Support (For Windows®)	4
	Control panel overview	5
2	Loading documents and paper	8
	Loading documents	8
	Using the ADF	8
	Scannable area	9
	Acceptable paper and other media	9
	Recommended media	10
	Handling and using media	10
	Choosing the right media.....	11
	Loading paper and other media	13
	Loading envelopes and post cards	15
	Removing small printouts from the machine	16
	Printable Area.....	17
3	General setup	18
	On/Off key.....	18
	Turning the machine off.....	18
	Turning the machine on	18
	On/Off setting	18
	Mode Timer.....	19
	Paper settings	19
	Paper Type	19
	Paper Size	20
	Volume Settings.....	20
	Ring Volume	20
	Beeper Volume	20
	Speaker Volume	20
	Handset Volume (MFC-3360C and FAX-1860C)	21
	Choosing the Handset Volume (For Volume Amplify) (MFC-3360C and FAX-1860C).....	21
	Setting Volume Amplify	22
	Automatic Daylight Savings Time	22
	LCD display	22
	LCD Contrast.....	22

4	Security features	23
	TX Lock (MFC-3360C and FAX-1860C).....	23
	Setting and changing the TX Lock password	23
	Turning TX Lock on/off	24
	Memory Security (FAX-1960C only).....	24
	Setting and changing the Memory Security password	25
	Turning Memory Security on/off	25

Section II Fax

5	Sending a fax	28
	Entering Fax mode	28
	Faxing from the ADF	28
	Color fax transmission	28
	Canceling a fax in progress	28
	Broadcasting (Black & White only)	28
	Canceling a Broadcast in progress.....	29
	Additional sending operations.....	29
	Sending faxes using multiple settings	29
	Contrast	30
	Changing Fax Resolution	30
	Dual access (Black & White only).....	31
	Real time transmission	31
	Overseas Mode	31
	Delayed Faxing (Black & White only)	32
	Delayed Batch Transmission (Black & White only)	32
	Checking and canceling waiting jobs.....	32
	Sending a fax manually	33
	Sending a fax at the end of a conversation (MFC-3360C and FAX-1860C only).....	33
	Out of Memory message	33

6	Receiving a Fax	34
	Receive modes.....	34
	Choosing the Receive Mode	34
	Using receive modes	36
	Fax only	36
	Fax/Tel.....	36
	Manual.....	36
	Message Center (MC:Msg Ctr) (FAX-1960C only).....	36
	External TAD	36
	Receive mode settings	37
	Ring Delay	37
	F/T Ring Time (Fax/Tel mode only).....	37
	Easy Receive.....	37
	Additional receiving operations.....	38
	Printing a reduced incoming fax	38
	Receiving a fax at the end of a conversation (MFC-3360C and FAX-1860C only).....	38
	Printing a fax from the memory	39

7 Telephone Services and External devices 40

Voice Operations	40
Making a telephone call	40
Answering calls with the Speaker Phone (FAX-1960C)	40
Hold	40
Tone or pulse (Canada only)	41
Fax/Tel mode when the power key is on	41
Fax/Tel mode when the power key is off	41
Telephone services.....	42
Distinctive Ring.....	42
Caller ID	44
Connecting an external TAD (telephone answering device).....	45
Connections.....	46
Recording an outgoing message (OGM) on an external TAD	46
Special line considerations	47
Multi-line connections (PBX)	48
External and extension phones	48
Connecting an external or extension telephone	48
Using external and extension telephones.....	49
Using a non-Brother cordless external telephone (MFC-3360C and FAX-1860C).....	49
Using remote codes.....	49

8 Dialing and storing numbers 50

How to Dial	50
Manual dialing	50
One-Touch Dialing.....	50
Speed-Dialing	50
Search	51
Fax Redial	51
Storing numbers	51
Storing a pause	51
Storing One-Touch Dial numbers	52
Storing Speed-Dial numbers	52
Changing One-Touch and Speed-Dial numbers	53
Setting up Groups for broadcasting.....	53
Dialing access codes and credit card numbers	54

9	Message Center (FAX-1960C only)	55
	Message Center Mode	55
	Setting up the Message Center	55
	Outgoing message (OGM)	55
	Fax/Tel OGM (Announcement)	56
	Activating Message Center memory.....	56
	Managing your messages	56
	Message Indicator	56
	Playing voice messages	56
	Printing fax messages	57
	Erasing incoming messages.....	57
	Additional Message Center operations.....	58
	Setting maximum time for incoming messages	58
	Setting toll saver	58
	ICM Recording Monitor.....	58
10	Remote fax options	59
	Fax Forwarding.....	59
	Paging	59
	Fax Storage	60
	Changing Remote Fax Options	60
	Turning off Remote Fax Options	60
	Remote Retrieval.....	61
	Setting a Remote Access Code.....	61
	Using your Remote Access Code.....	61
	Retrieving fax messages	62
	Changing your Fax Forwarding number	62
	Remote fax commands.....	63
11	Printing Reports	65
	Fax reports.....	65
	Transmission Verification Report.....	65
	Fax Journal (activity report).....	65
	Reports	66
	How to print a report.....	66
12	Polling	67
	Polling receive	67
	Setup for polling receive	67
	Sequential polling	67
	Polled transmit (Black & White only).....	68
	Setup for polled transmit.....	68

Section III Copy

13	Making copies	70
	How to copy	70
	Entering Copy mode	70
	Making a single copy	70
	Making multiple copies	70
	Stop copying	70
	Copy keys	70
	Changing copy quality	71
	Enlarging or reducing the image copied	71
	Copy options.....	72
	Making N in 1 copies	73
	Sorting copies using the ADF (Black & White only).....	74
	Adjusting Brightness, Contrast and Color.....	74
	Paper options	75

Section IV Software

14	Software features (MFC-3360C only)	78
	How to read the HTML User's Guide.....	78

Section V Appendixes

A	Safety and Legal	80
	Choosing a location	80
	To use the machine safely.....	81
	Important safety instructions.....	84
	Standard telephone and FCC Notices (These notices are in effect on models sold and used in the United States only)	86
	Federal Communications Commission (FCC) Declaration of Conformity (USA only)	87
	Industry Canada Compliance Statement (Canada only)	88
	Legal limitations for copying	89
	Trademarks	89

B Troubleshooting and Routine Maintenance 90

Troubleshooting	90
If you are having difficulty with your machine	90
Error messages	95
Transferring your faxes or Fax Journal report	98
Document jam	98
Printer jam or paper jam	99
Dial Tone	101
Phone line interference	101
Routine maintenance	102
Replacing the ink cartridges	102
Cleaning the outside of the machine	104
Cleaning the scanner	105
Cleaning the machine printer platen	105
Cleaning the paper pick-up roller	106
Cleaning the print head	106
Checking the print quality	107
Checking the print alignment	108
Checking the ink volume	108
Machine Information	109
Checking the serial number	109
Packing and shipping the machine	109

C Menu and Features 111

On-screen programming	111
Menu table	111
Memory storage	111
Menu keys	112
Menu Table	113
Entering Text	120

D	Specifications	121
	General	121
	Print media.....	123
	Fax.....	124
	Message Center (FAX-1960C only).....	125
	Digital Cordless Handset (FAX-1960C only)	125
	Battery	125
	Copy	126
	Scanner (MFC-3360C only).....	126
	Printer	127
	Interface.....	128
	Computer requirements.....	128
	Consumable items	129
E	Glossary	130
F	Index	134



General

General Information	2
Loading documents and paper	8
General setup	18
Security features	23

Using the documentation

Thank you for buying a Brother machine! Reading the documentation will help you make the most of your machine.

Symbols and conventions used in the documentation

The following symbols and conventions are used throughout the documentation.

Bold Bold typeface identifies specific keys on the machine's control panel.

Italics Italicized typeface emphasizes an important point or refers you to a related topic.

`Courier New` Text in the Courier New font identifies messages on the LCD of the machine.



Warnings tell you what to do to prevent possible personal injury.



Electrical Hazard icons alert you to possible electrical shock.



Cautions specify procedures you must follow or avoid to prevent possible damage to the machine or other objects.



Notes tell you how you should respond to a situation that may arise or give tips about how the operation works with other features.



Improper Setup icons alert you to devices and operations that are not compatible with the machine.

Accessing the Software User's Guide (MFC-3360C only)

This User's Guide does not contain all the information about the machine such as how to use Printer, Scanner and PC Fax. When you are ready to learn detailed information about these operations, read the Software User's Guide that is on the CD-ROM.

Viewing Documentation

Viewing Documentation (For Windows®)

To view the documentation, from the **Start** menu, point to **Brother, MFC-XXXX** (where XXXX is your model name) from the programs group, and then select **User's Guide**.

If you have not installed the software, you can find the documentation by following the instructions below:

- 1 Turn on your PC. Insert the Brother CD-ROM into your CD-ROM drive.
- 2 If the model name screen appears, click your model name.

- 3 If the language screen appears, click your language. The CD-ROM main menu will appear.

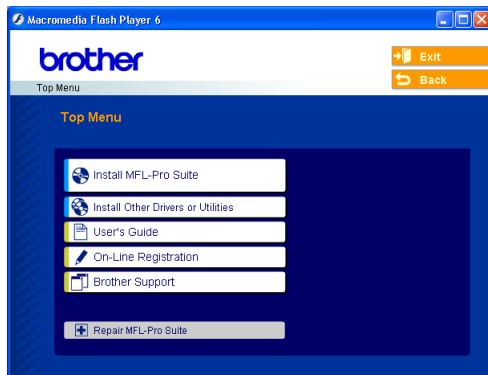

Note

If this window does not appear, use Windows® Explorer to run the setup.exe program from the root directory of the Brother CD-ROM.

- 4 Click **User's Guide** to view the Software User's Guide in HTML format.

How to find Scanning instructions

There are several ways you can scan documents. You can find the instructions as follows:

Software User's Guide

- **Scanning**
(For Windows® 98/98SE/Me/2000 Professional and Windows® XP)
- **ControlCenter3**
(For Windows® 98/98SE/Me/2000 Professional and Windows® XP)

PaperPort® SE with OCR User's Guide

- The complete ScanSoft® PaperPort® SE with OCR User's Guide can be viewed from the Help selection in the ScanSoft® PaperPort® SE with OCR application.

Viewing Documentation (For Macintosh®)

- 1 Turn on your Macintosh®. Insert the Brother CD-ROM into your CD-ROM drive. The following window will appear.

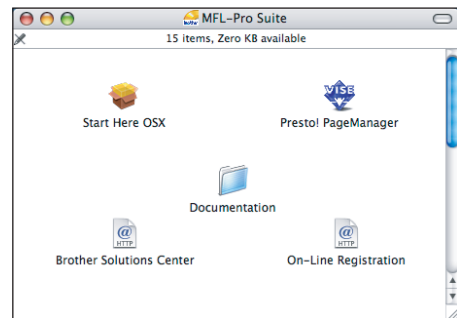

- 2 Double-click the **Documentation** icon.
- 3 Double-click your language folder.
- 4 Double-click the Top Page file to view the Software User's Guide in HTML format.

- **Software User's Guide:**
Software User's Guide in HTML format

How to find Scanning instructions

There are several ways you can scan documents. You can find the instructions as follows:

Software User's Guide

- **Scanning**
(For Mac OS® X 10.2.4 or greater)
- **ControlCenter2**
(For Mac OS® X 10.2.4 or greater)

Presto!® PageManager® User's Guide

- The complete Presto!® PageManager® User's Guide can be viewed from the Help selection in the Presto!® PageManager® application.

Accessing Brother Support (For Windows®)

You can find all the contacts you will need, such as Web support (Brother Solutions Center), Customer Service and Brother Authorized Service Centers on page i and on the Brother CD-ROM.

- Click **Brother Support** on the main menu. The following screen will appear:

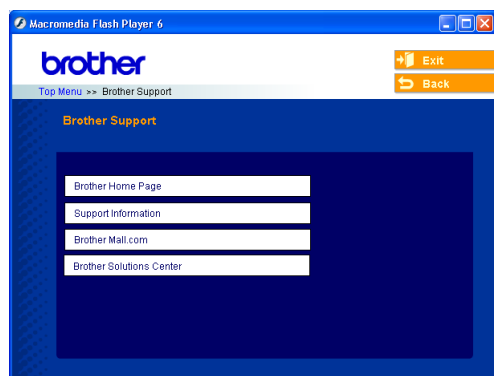

- To access our web site (www.brother.com), click **Brother Home Page**.
- To view all Brother Numbers, including Customer Service numbers for the USA and Canada, click **Support Information**.
- To access the USA Brother online shopping mall (www.brothermall.com) for additional product and services information, click **Brother Mall.com**.
- For the latest news and product support information (<http://solutions.brother.com>), click **Brother Solutions Center**.
- To return to the main page, click **Back** or If you have finished, click **Exit**.

Control panel overview

MFC-3360C

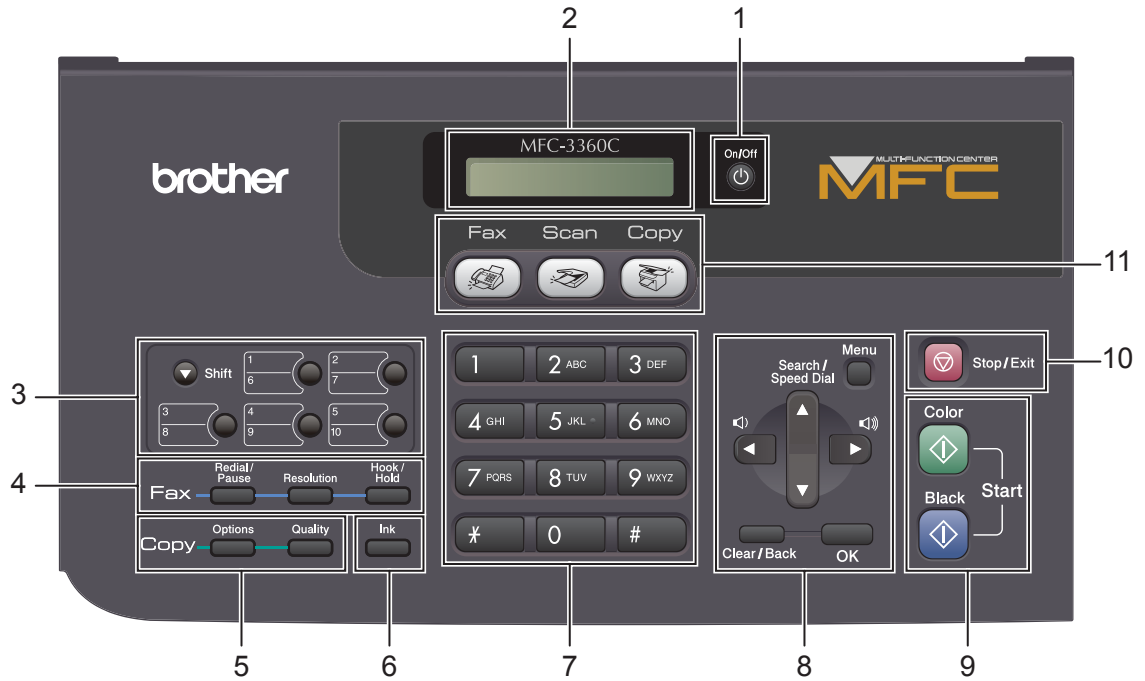

FAX-1860C

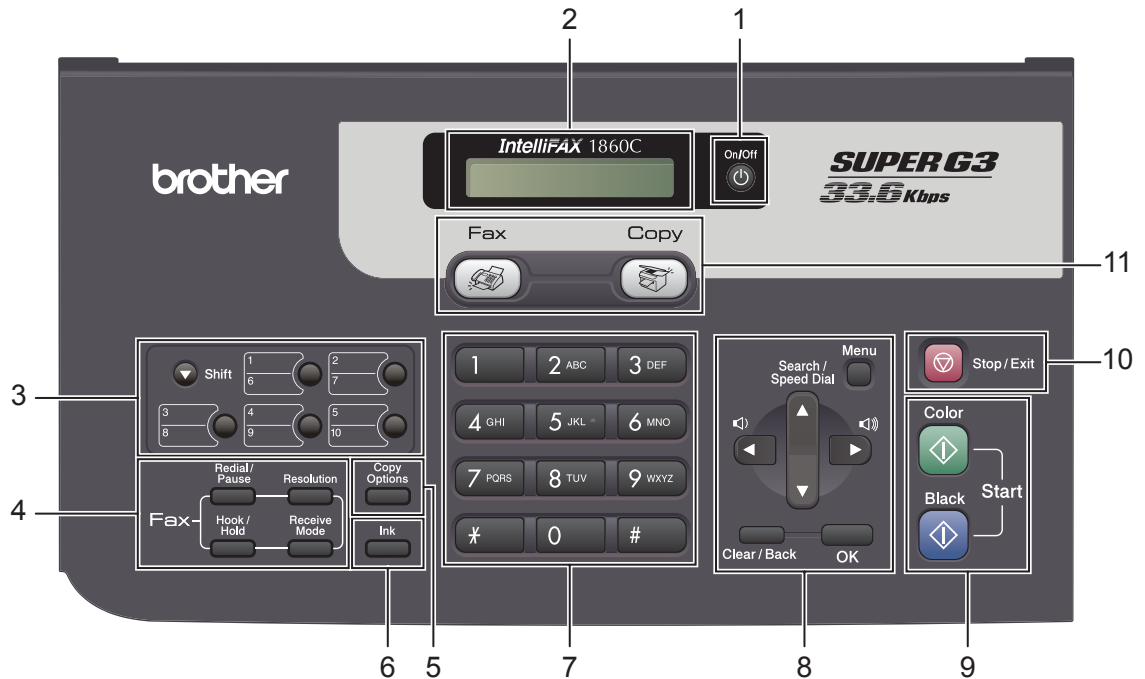

FAX-1960C

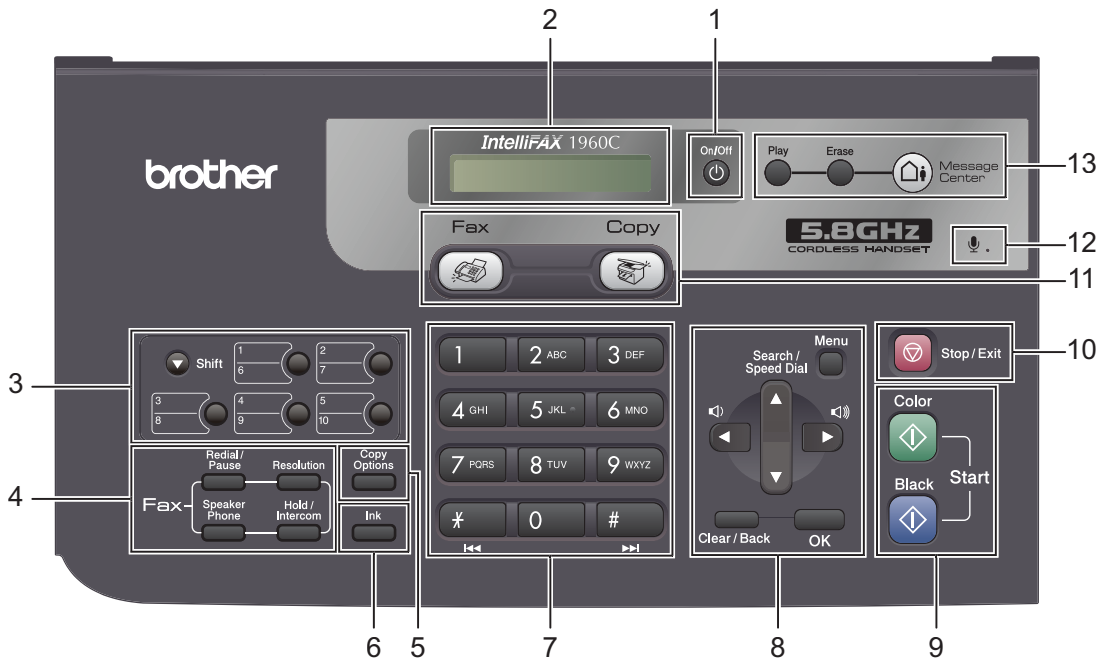
**1 On/Off**

You can turn the machine on or off.

2 LCD (liquid crystal display)

Displays messages on the screen to help you set up and use your machine.

3 One-Touch keys

Instantly accesses your stored Quick-Dial numbers.

- **Shift**

When held down, lets you access One-Touch numbers **6** to **10**.

4 Fax keys

- **Redial/Pause**

Redials the last number called. It also inserts a pause when programming quick-dial numbers.

- **Resolution**

Lets you temporarily change the resolution when sending a fax.

- **Hook/Hold**

(MFC-3360C and FAX-1860C only)

Press before dialing if you want to make sure a fax machine will answer, and then press **Black Start** or **Color Start**.

Also, lets you place telephone calls on hold.

- **Hold/Intercom** (FAX-1960C only)

Lets you place telephone calls on hold.

Also, press this key to speak on the intercom or to transfer an incoming call to the cordless handset.

- **Speaker Phone** (FAX-1960C only)

Lets you speak to another party without lifting the handset.

- **Receive Mode** (FAX-1860C only)

Press to select how your fax machine will handle incoming calls. (See *Choosing the Receive Mode* on page 34.)

5 Copy keys

- **Quality** (MFC-3360C only)

Lets you temporarily change copy quality setting.

- **Options** (MFC-3360C only)

Lets you temporarily change multiple copy settings.

- **Copy Options**

(FAX-1860C and FAX-1960C)

Lets you temporarily change multiple copy settings.

6 Ink

Lets you clean the print head, check the print quality, and check the available ink volume.

7 Dial Pad

Use these keys to dial telephone and fax numbers and as a keyboard for entering information into the machine.

(Canada only) The # key lets you temporarily switch the dialing mode during a telephone call from Pulse to Tone.

8 Menu keys:

- **Menu**

Lets you access the Menu to program your settings in the machine.

- **▲ Search/Speed Dial**

Lets you look up and dial numbers that are stored in the memory.

- **Volume keys**



In Fax mode, you can press these keys to adjust the ring volume.

- **◀**

Press to scroll backward to a menu selection.

- **▲ or ▼**

Press to scroll through the menus and options.

- **Clear/Back**

Press to cancel the current setting.

- **OK**

Lets you store your settings in the machine.

9 Start keys:

-  **Color**

Lets you start sending faxes or making copies in full color. For MFC-3360C, also lets you start a scanning operation (in color or black & white, depending on the scanning setting in the ControlCenter software).

-  **Black Color**

Lets you start sending faxes or making copies in black & white. For MFC-3360C, also lets you start a scanning operation (in color or black, depending on the scanning setting in the ControlCenter software).

10  Stop/Exit

Stops an operation or exits from a menu.

11 Mode keys:

-  **Fax**

Lets you access Fax mode.

-  **Scan (MFC-3360C only)**

Lets you access Scan mode.

-  **Copy**

Lets you access Copy mode.

12  Microphone (FAX-1960C only)

Used by the Speaker Phone feature and to record messages.

13 Message Center keys (FAX-1960C only)

-  **MC On/Off**

Turns the Message Center on or off. Will also flash if you have new messages.

- **Erase**

Deletes voice and fax messages.

- **Play**

Plays voice messages stored in the memory.

2

Loading documents and paper

Loading documents

You can send a fax, make copies, and scan (MFC-3360C only) from the ADF (automatic document feeder).

Using the ADF

The ADF can hold up to 20 pages and feeds each sheet individually. Use standard 20 lb (80 g/m²) paper and always fan the pages before putting them in the ADF.

Recommended environment

Temperature:	68 to 86° F (20 to 30° C)
Humidity:	50% to 70%
Paper:	20 lb LTR (80 g/m ² A4)

Document Sizes Supported

Length:	5 to 14 in. (127 to 355.6 mm)
Width:	3.5 to 8.5 in. (89 to 215.9 mm)
Weight:	17 to 24 lb (64 to 90 g/m ²)

How to load documents

! CAUTION

DO NOT pull on the document while it is feeding.

DO NOT use paper that is curled, wrinkled, folded, ripped, stapled, paper clipped, pasted or taped.

DO NOT use cardboard, newspaper or fabric.

- Make sure documents written with ink are completely dry.

- 1 Open the document support (1) and the document tray (2) and then pull out the extension (3).

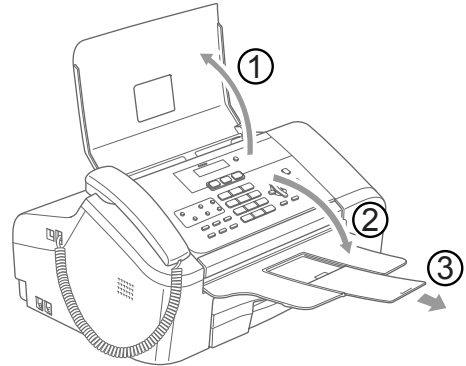

- 2 Fan the pages well. Make sure you put the documents **face down, top edge first** in the ADF until you feel them touch the feed roller.

- 3 Adjust the paper guides (1) to fit the width of your documents.

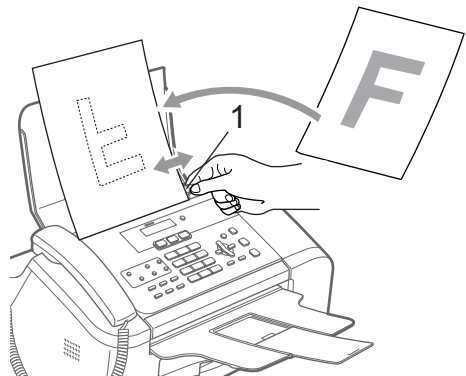

Scannable area

The scannable area depends on the settings in the application you are using. The figures below show the areas you cannot scan on paper.

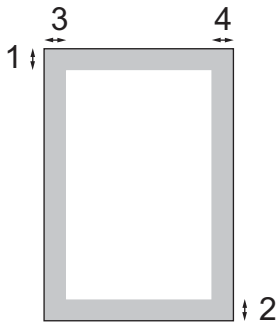

Usage	Document Size	Top (1)	Left (3)
		Bottom (2)	Right (4)
Fax	Letter	0.12 in. (3 mm)	0.16 in. (4 mm)
	A4	0.12 in. (3 mm)	0.04 in. (1 mm)
Copy	Letter	0.12 in. (3 mm)	0.12 in. (3 mm)
	A4	0.12 in. (3 mm)	0.12 in. (3 mm)
Scan (MFC-3360C only)	Letter	0.12 in. (3 mm)	0.12 in. (3 mm)
	A4	0.12 in. (3 mm)	0 in. (0 mm)

Acceptable paper and other media

The print quality can be affected by the type of paper you are using in the machine.

To get the best print quality for the settings you have chosen, always set the Paper Type to match the type of paper you load.

You can use plain paper, inkjet paper (coated paper), glossy paper, transparencies and envelopes.

We recommend testing various paper types before buying large quantities.

For best results, use Brother paper.

- When you print on inkjet paper (coated paper), transparencies and glossy paper, be sure to choose the proper media in the 'Basic' tab of the printer driver or in the Paper Type setting of the menu. (See *Paper Type* on page 19.)
- When you print on Brother photo paper, load the instruction sheet included with the photo paper in the paper tray first, and then put the photo paper on top of the instruction sheet.
- When you use transparencies or glossy paper, remove each sheet at once to prevent smudging or paper jams.
- Avoid touching the printed surface of the paper immediately after printing; the surface may not be completely dry and may stain your fingers.

Recommended media

To get the best print quality, we suggest using Brother paper. (See table below.)

We recommend using '3M Transparency Film' when you print on transparencies.

Brother paper

Paper Type	Item
Letter Plain	BP60PL (USA only)
Letter Glossy Photo	BP61GLL ¹
Letter Inkjet (Matte)	BP60ML (USA only)
4" × 6" in. Glossy Photo	BP61GLP ¹

¹ Available in the USA and from November 2006 in Canada.

Handling and using media

- Store paper in its original packaging, and keep it sealed. Keep the paper flat and away from moisture, direct sunlight and heat.
- The coated side of glossy paper is shiny. Avoid touching the shiny (coated) side. Load glossy paper with the shiny side facing down.
- Avoid touching either side of transparencies because they absorb water and perspiration easily, and this may cause decreased output quality. Transparencies designed for laser printers and copiers may stain your next document. Use only transparencies recommended for inkjet printing.

Improper Setup

DO NOT use the following kinds of paper:

- Damaged, curled, wrinkled, or irregularly shaped paper

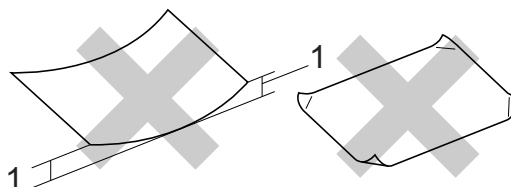

1 0.08 in. (2 mm) or longer

- Extremely shiny or highly textured paper
- Paper already printed on by a printer
- Paper that cannot be arranged uniformly when stacked
- Paper made with a short grain

Paper capacity of the output paper tray

Up to 50 sheets of 20 lb Letter or 80 g/m² A4 paper.

- Transparencies or glossy paper must be picked up from the output paper tray one page at a time to avoid smudging.

Choosing the right media

Paper type and size for each operation

Paper Type	Paper Size		Usage		
			Fax	Copy	Printer
Cut Sheet	Letter	8 1/2 × 11 in. (216 × 279 mm)	Yes	Yes	Yes
	A4	8.3 × 11.7 in. (210 × 297 mm)	Yes	Yes	Yes
	Legal	8 1/2 × 14 in. (216 × 356 mm)	Yes	Yes	Yes
	Executive	7 1/4 × 10 1/2 in. (184 × 267 mm)	–	–	Yes
	JIS B5	7.2 × 10.1 in. (182 × 257 mm)	–	–	Yes
	A5	5.8 × 8.3 in. (148 × 210 mm)	–	Yes	Yes
	A6	4.1 × 5.8 in. (105 × 148 mm)	–	–	Yes
Cards	Photo	4 × 6 in. (10 × 15 cm)	–	Yes	Yes
	Photo 2L	5 × 7 in. (13 × 18 cm)	–	–	Yes
	Index Card	5 × 8 in. (127 × 203 mm)	–	–	Yes
	Post Card 1	3.9 × 5.8 in. (100 × 148 mm)	–	–	Yes
	Post Card 2 (Double)	5.8 × 7.9 in. (148 × 200 mm)	–	–	Yes
Envelopes	C5 Envelope	6.4 × 9 in. (162 × 229 mm)	–	–	Yes
	DL Envelope	4.3 × 8.7 in. (110 × 220 mm)	–	–	Yes
	COM-10	4 1/8 × 9 1/2 in. (105 × 241 mm)	–	–	Yes
	Monarch	3 7/8 × 7 1/2 in. (98 × 191 mm)	–	–	Yes
	JE4 Envelope	4.1 × 9.3 in. (105 × 235 mm)	–	–	Yes
Transparencies	Letter	8 1/2 × 11 in. (216 × 279 mm)	–	Yes	Yes
	A4	8.3 × 11.7 in. (210 × 297 mm)	–	Yes	Yes

Paper weight, thickness and capacity

Paper Type		Weight	Thickness	No. of sheets
Cut Sheet	Plain Paper	17 to 32 lb (64 to 120 g/m ²)	0.003 to 0.006 in. (0.08 to 0.15 mm)	100 ¹
	Inkjet Paper	17 to 53 lb (64 to 200 g/m ²)	0.003 to 0.01 in. (0.08 to 0.25 mm)	20
	Glossy Paper	Up to 58 lb (Up to 220 g/m ²)	Up to 0.01 in. (Up to 0.25 mm)	20
Cards	Photo 4" × 6"	Up to 64 lb (Up to 240 g/m ²)	Up to 0.01 in. (Up to 0.28 mm)	20
	Index Card	Up to 32 lb (Up to 120 g/m ²)	Up to 0.006 in. (Up to 0.15 mm)	30
	Post Card	Up to 53 lb (Up to 200 g/m ²)	Up to 0.01 in. (Up to 0.23 mm)	30
Envelopes		20 to 25 lb (75 to 95 g/m ²)	Up to 0.02 in. (Up to 0.52 mm)	10
Transparencies		–	–	10

¹ Up to 50 sheets for Legal size paper 20 lb (80 g/m²).
Up to 100 sheets of 20 lb (80 g/m²) paper.

Loading paper and other media

- 1 If the paper support flap (1) is open close it. Open the output paper tray cover (2). Pull the paper tray completely out of the machine.

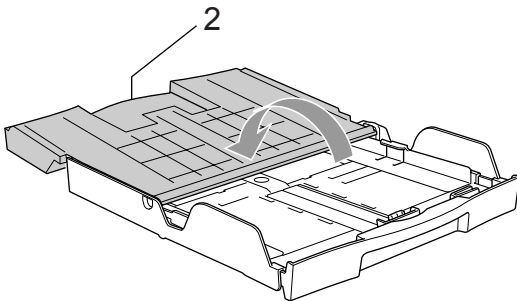
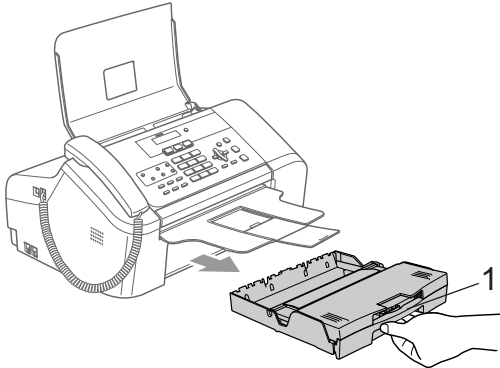

- 2 If you are using Letter, A4 or Legal size paper, press and hold the universal guide release button (1) as you slide out the front of the paper tray to match the paper size you are using.

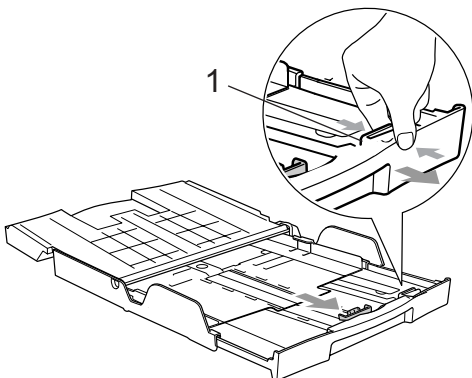

- 3 Press and slide the paper side guides (1) and paper length guide (2) to fit the paper size.

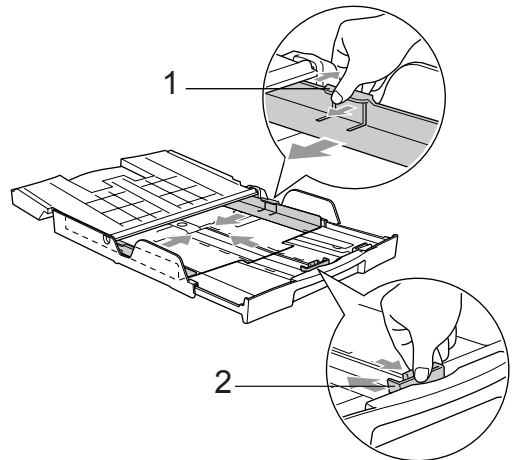

- 4 Fan the stack of paper well to avoid paper jams and misfeeds.

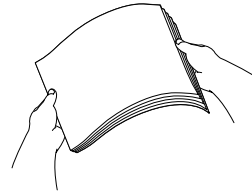

Note

Always make sure that the paper is not curled.

- 5 Gently put the paper into the paper tray print side down and top edge first. Check that the paper is flat in the tray.

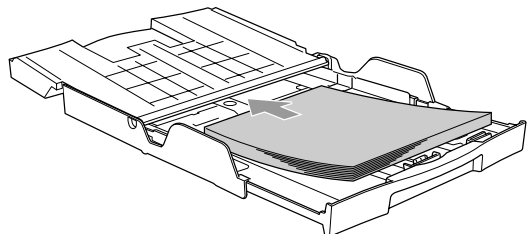

- 6 Gently adjust the paper side guides with both hands and the paper length guide to fit the paper. Make sure that the paper side guides and paper length guide touch the edges of the paper.

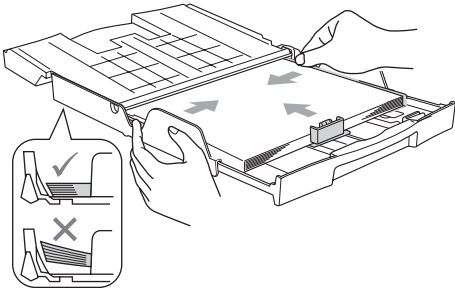

 **Note**

Be careful that you do not push the paper in too far; it may lift at the back of the tray and cause feed problems.

- 7 Close the output paper tray cover (1) and slide it forward.

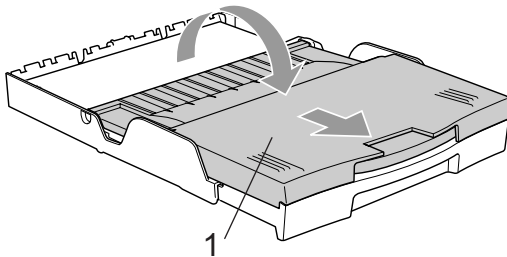

 **Note**

If you are using Legal size paper, the paper tray cover does not slide all the way to the end of the paper tray.

- 8 Slowly push the paper tray completely into the machine.

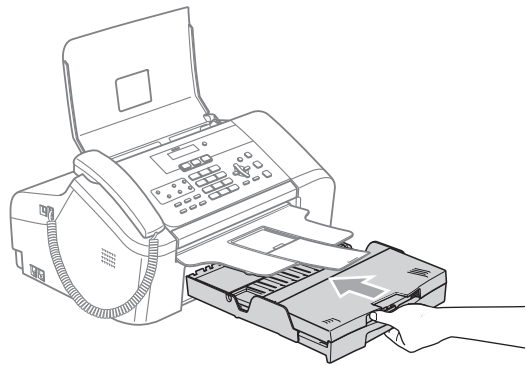

- 9 While holding the paper tray in place, pull out the paper support (1) until it clicks and unfold the paper support flap (2).

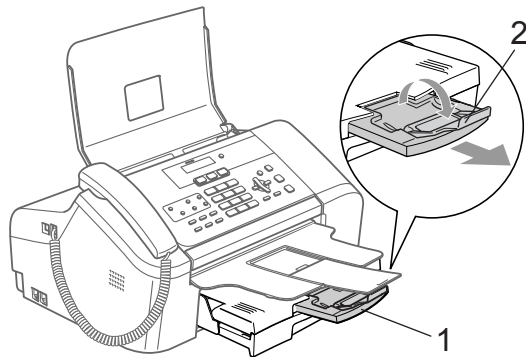

 **Note**

Do not use the paper support flap for Legal paper.

Loading envelopes and post cards

About envelopes

- Use envelopes that weigh from 20 to 25 lb (75 to 95 g/m²).
- Some envelopes need margin settings to be set in the application. Make sure you do a test print first.

! CAUTION

Do not use any of the following types of envelopes, as they will cause paper feed problems:

- If they are of a baggy construction.
- That are embossed (have raised writing on them).
- That have clasps or staples.
- That are pre-printed on the inside.

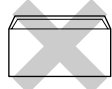
Glue	Double flap
	

Occasionally you may experience paper feed problems caused by the thickness, size and flap shape of the envelopes you are using.

How to load envelopes and post cards

- 1 Before loading, press the corners and sides of the envelopes or post cards to make them as flat as possible.



Note

If the envelopes or post cards are 'double-feeding,' put one envelope in the paper tray at a time.

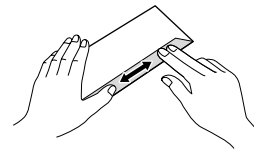
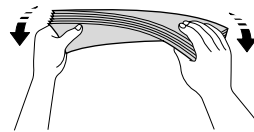
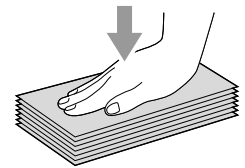

- 2 Put the envelopes or post cards into the paper tray with the address side down and the leading edge in first as shown in the illustration. Slide the paper side guides (1) and paper length guide (2) to fit the size of the envelopes or post cards.

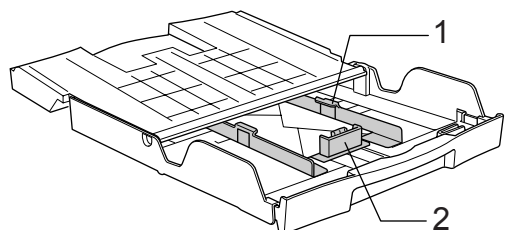

If you have problems when printing on envelopes, try the following suggestions:

- 1 Open the envelope flap.
- 2 Make sure the open flap is either to the side of the envelope or to the back edge of the envelope when printing.
- 3 Adjust the size and margin in your application.

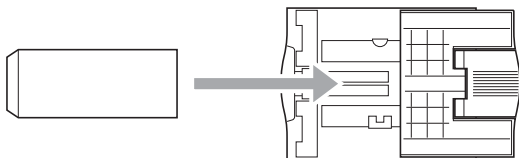
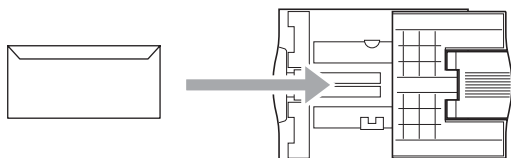

Removing small printouts from the machine

When the machine ejects small paper onto the output paper tray, you may not be able to reach it. Make sure printing has finished, and then pull the tray completely out of the machine.

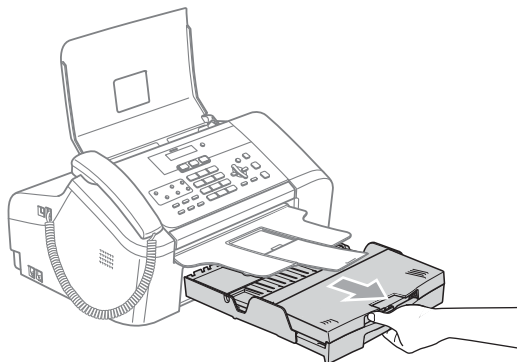

Printable Area

The printable area depends on the settings in the application you are using. The figures below show the unprintable areas on cut sheet paper and envelopes. The machine can only print in the shaded areas when the Borderless print feature is available and turned on.

Cut Sheet Paper

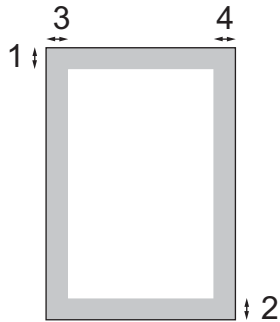

Envelopes

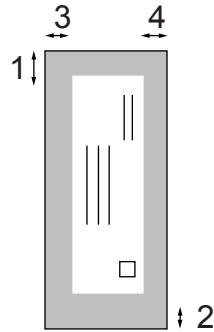

	Top (1)	Bottom (2)	Left (3)	Right (4)
Cut Sheet	0.12 in. (3 mm)	0.12 in. (3 mm)	0.12 in. (3 mm)	0.12 in. (3 mm)
Envelopes	0.47 in. (12 mm)	0.95 in. (24 mm)	0.12 in. (3 mm)	0.12 in. (3 mm)



Note

The Borderless feature is not available for envelopes.

3

General setup

On/Off key

When the machine is idle, you can turn it on and off by pressing the **On/Off** key.



Note

If you have connected an external telephone or TAD, it is always available.

Turning the machine off

- 1 Press and hold down the **On/Off** key until the LCD shows *Shutting Down*. The LCD light goes off.

Turning the machine on

- 1 Press the **On/Off** key.

On/Off setting

You can customize the machine's **On/Off** key. The default setting is *Fax Receive:Off*. Your machine will not work when it is switched off, but it will clean the print head periodically. If you turn this setting to *Fax Receive:On*, you can receive faxes or calls even when the machine is switched off. (See *On/Off key* on this page.)

- 1 Press **Menu**, **1**, **6**.
- 2 Press **▲** or **▼** to choose *Fax Receive:On* or *Fax Receive:Off*. Press **OK**.
- 3 Press **Stop/Exit**.

MFC-3360C and FAX-1860C

On/Off setting	Receive mode	Available operations
Fax Receive: Off (factory setting)	—	No machine operations will be available.
Fax Receive: On ^{1 2}	Fax Only External TAD Fax/Tel	Fax Receive Easy Receive Delayed Fax ³ Fax Forward ³ Paging ³ Fax Storage ³ Remote Retrieval ³
	Manual	Easy Receive Delayed Fax ³

- 1 You cannot receive a fax with **Black Start** or **Color Start**.
- 2 You can receive telephone calls by lifting the handset.
- 3 Set before you switch off the machine.

FAX-1960C

On/Off setting	Receive mode	Available operations
Fax Receive: Off (factory setting)	—	No machine operations will be available.
Fax Receive: On ^{1 2}	Fax Only Manual ³	Fax Receive Easy Receive Delayed Fax ⁵ Fax Forward ⁵ Paging ⁵ Fax Storage ⁵ Remote Retrieval ⁵
	MC	Fax Receive Recording Incoming Messages Easy Receive Delayed Fax ⁵ Fax Forward ⁵ Paging ⁵ Fax Storage ⁵ Remote Retrieval ⁵
	Manual Fax/Tel ⁴	Easy Receive Delayed Fax ⁵

- ¹ You cannot receive a fax with **Black Start** or **Color Start**.
- ² You can receive telephone calls by using the cordless handset.
- ³ When an external TAD is connected and Easy Receive is turned on.
- ⁴ You cannot receive a fax automatically even if you have set the receive mode to Fax/Tel.
- ⁵ Set before you switch off the machine.

Mode Timer

The machine has mode keys on the control panel: **Fax**, **Scan** (MFC-3360C only), and **Copy**. You can change the amount of time the machine takes after the last Scan or Copy operation before it returns to Fax mode. If you choose **Off**, the machine stays in the mode you used last.



- 1** Press **Menu**, **1**, **1**.
- 2** Press **▲** or **▼** to choose **0 Sec**, **30 Secs**, **1 Min**, **2 Mins**, **5 Mins** or **Off**. Press **OK**.
- 3** Press **Stop/Exit**.

Paper settings

Paper Type

To get the best print quality, set the machine for the type of paper you are using.

- 1** Press **Menu**, **1**, **2**.
- 2** Press **▲** or **▼** to choose **Plain Paper**, **Inkjet Paper**, **Brother Photo**, **Other Photo** or **Transparency**. Press **OK**.
- 3** Press **Stop/Exit**.



Note

The machine ejects paper with printed surfaces face up onto the paper tray in the front of the machine. When you use transparencies or glossy paper, remove each sheet at once to prevent smudging or paper jams.

Paper Size



You can use five sizes of paper for printing copies: Letter, Legal, A4, A5 and 4" × 6" in. (10 × 15 cm) and three sizes for printing faxes: Letter, Legal and A4. When you change the size of paper you load in the machine, you will need to change the paper size setting at the same time so your machine can fit an incoming fax on the page.

- 1 Press **Menu**, **1**, **3**.
- 2 Press **▲** or **▼** to choose *Letter*, *Legal*, *A4*, *A5* or *4"×6"*. Press **OK**.
- 3 Press **Stop/Exit**.

Volume Settings

Ring Volume

You can choose a range of ring volume levels, from *High* to *Off*.

While in Fax mode , press  or  to adjust the volume level. The LCD shows the current setting, and each key press will change the volume to the next level. The machine will keep the new setting until you change it.

You can also change the volume through the menu, by following the instructions below:

Setting the Ring Volume from the menu

- 1 Press **Menu**, **1**, **4**, **1**.
- 2 Press **▲** or **▼** to choose *Low*, *Med*, *High* or *Off*. Press **OK**.
- 3 Press **Stop/Exit**.

Beeper Volume

When the beeper is on, the machine will beep when you press a key, make a mistake or after you send or receive a fax.

You can choose a range of volume levels, from *High* to *Off*.

- 1 Press **Menu**, **1**, **4**, **2**.
- 2 Press **▲** or **▼** to choose *Low*, *Med*, *High* or *Off*. Press **OK**.
- 3 Press **Stop/Exit**.



Speaker Volume

You can choose a range of speaker volume levels, from *High* to *Off*.

- 1 Press **Menu**, **1**, **4**, **3**.
- 2 Press **▲** or **▼** to choose *Low*, *Med*, *High* or *Off*. Press **OK**.
- 3 Press **Stop/Exit**.



(MFC-3360C and FAX-1860C)

You can also adjust the speaker volume by pressing **Hook/Hold**.









- 1 Press **Hook/Hold**.
- 2 Press  or . This setting will stay until you change it again.
- 3 Press **Hook/Hold**.

(FAX-1960C)



You can also adjust the speaker volume by pressing **Speaker Phone**.

- 1 Press **Speaker Phone**.
- 2 Press  or . This setting will stay until you change it again.
- 3 Press **Speaker Phone**.





 **Note**

- You can also adjust the speaker volume while you are listening to your OGM (Outgoing Message) and ICMs (Incoming Messages) by pressing   or  .
- If you turn Incoming Recording Monitor to OFF (**Menu, 2, 7, 3**) the Speaker for screening calls will be disabled and you won't hear callers leaving messages. The volume for other operations can still be controlled using   or  .

Handset Volume (MFC-3360C and FAX-1860C)

- 1 Press **Menu, 1, 4, 4**.
- 2 Press  or  to choose **Low** or **High**. Press **OK**.
- 3 Press **Stop/Exit**.





 **Note**

- You can adjust the handset volume any time you are talking on the telephone. There are two handset volume levels, **Low** and **High**. The default setting is **Low**.
- Press   or   to adjust the volume level. The LCD shows the setting you are choosing. The new setting will remain until you change it again.





Choosing the Handset Volume (For Volume Amplify) (MFC-3360C and FAX-1860C)

Before you begin to use the machine, you must decide if you need to set the handset volume to **Vol Amplify:On** for a user who is hearing-impaired. The **AMPLIFY** volume level complies with FCC standards.





Vol Amplify:Off

This default setting is appropriate if *none* of the users are hearing-impaired. During a conversation, users can press   or   on the control panel to adjust the volume to **Low** or **High**. When the handset is replaced, the handset volume will remain until you change it again.





Vol Amplify:On - Temporary

This setting is appropriate if *some* of the users are hearing-impaired. During a conversation, users can press   or   on the control panel to adjust the volume to **Low**, **High** or **Volume Amplify**. When the handset is replaced, the handset volume returns to the default setting of **Low**.

Vol Amplify:On - Permanent

Choose **Vol Amplify:On—Permanent** if *all* of the users are hearing-impaired. During a conversation, users can press   or   on the control panel to adjust the volume to **Low**, **High** or **Volume Amplify**. When the handset is replaced, the handset volume returns to the default setting of **Volume Amplify**.

 **Note**

When you press   or   on the control panel to adjust the volume, the LCD shows the setting you are choosing. Each key press changes the volume to the next setting.

 **WARNING**

It is important that you do **NOT** choose **Permanent** unless **ALL** the users are **hearing-impaired**. Otherwise, the default setting of **Volume Amplify** may damage the hearing of some users.

Setting Volume Amplify

Please carefully read *Choosing the Handset Volume (For Volume Amplify) (MFC-3360C and FAX-1860C)* on page 21.

- 1 Press **Menu**, **1**, **4**, **5**.
- 2 Do one of the following.
 - If *none* of the users are hearing-impaired, press ▲ or ▼ to select *Off*, and then press **OK** and go to step 4.
 - If *some* or all of the users are hearing-impaired, press ▲ or ▼ to select *On*, and then press **OK**.
- 3 Do one of the following.
 - If *all* the users are hearing-impaired, press ▲ or ▼ to select *Permanent*, and then press **OK**.
 - If *only* some of the users are hearing-impaired, select *Temporary*, and then press **OK**.
- 4 Press **Stop/Exit**.

Automatic Daylight Savings Time

You can set the machine to change automatically for daylight savings time. It will reset itself forward one hour in the Spring and backward one hour in the Fall. Make sure you have set the correct date and time in the *Date/Time* setting.

- 1 Press **Menu**, **1**, **5**.
- 2 Press ▲ or ▼ to select *On* or *Off*. Press **OK**.
- 3 Press **Stop/Exit**.

LCD display

LCD Contrast

You can adjust the LCD contrast for a sharper and more vivid display. If you are having difficulty reading the LCD, try changing the contrast setting.

- 1 Press **Menu**, **1**, **7**.
- 2 Press ▲ or ▼ to choose *Light* or *Dark*. Press **OK**.
- 3 Press **Stop/Exit**.

TX Lock (MFC-3360C and FAX-1860C)

TX Lock lets you prevent unauthorized access to the machine.

You will not be able to continue to schedule Delayed Faxes or Polling jobs. However, any pre-scheduled Delayed Faxes will be sent even if you turn on TX Lock, so they will not be lost.

While TX Lock is On, the following operations are available:

- Receiving faxes
- Receiving calls
- Fax Forwarding
(If Fax Forwarding was already On)
- Remote retrieval
(If Fax Storage was already On)

While TX Lock is On, the following operations are NOT available:

- Sending faxes
- Copying
- PC printing
- Scanning (MFC-3360C)



Note

If you forget the TX Lock password, please call Brother Customer Service. (See *Brother numbers* on page i.)

Setting and changing the TX Lock password

Setting the password



Note

If you have already set the password, you will not need to set it again.

- 1 Press **Menu**, **2**, **0**, **1**.
- 2 Enter a 4-digit number for the password. Press **OK**.
- 3 When the LCD shows *Verify:*, reenter the password. Press **OK**.
- 4 Press **Stop/Exit**.

Changing the TX Lock password

- 1 Press **Menu**, **2**, **0**, **1**.
- 2 Press **▲** or **▼** to choose *Set Password*. Press **OK**.
- 3 Enter a 4-digit number for the current password. Press **OK**.
- 4 Enter a 4-digit number for the new password. Press **OK**.
- 5 When the LCD shows *Verify:* reenter the password. Press **OK**.
- 6 Press **Stop/Exit**.

Turning TX Lock on/off

Turning TX Lock on

- 1 Press **Menu**, **2**, **0**, **1**.
- 2 Press **▲** or **▼** to choose **Set TX Lock**. Press **OK**.
- 3 Enter the registered 4-digit password. Press **OK**.
The machine goes offline and the LCD shows **TX Lock Mode**.

Turning TX Lock off

- 1 Press **Menu**.
- 2 Enter the registered 4-digit password. Press **OK**.
TX lock is automatically turned off.



Note

If you enter the wrong password, the LCD shows **Wrong Password** and stays offline. The machine will stay in TX Lock mode until the registered password is entered.

Memory Security (FAX-1960C only)

Memory Security lets you prevent unauthorized access to the machine. You will not be able to continue to schedule Delayed Faxes or Polling jobs. However, any pre-scheduled Delayed Faxes will be sent even if you turned on Memory Security, so they will not be lost.

While memory security is **On**, only the following operations are available.

- Receiving faxes into memory (limited by memory capacity)
- Fax Forwarding (if Fax forwarding was already **On**)
- Remote Retrieval (if Fax storage was already **On**)
- Cordless handset
 - Making a call
 - Receiving a call
 - Viewing Caller ID

While Memory Security is on, the following operations are NOT available:

- Printing and received faxes
- Sending faxes
- PC printing
- Cordless handset
 - Intercom
 - Transfer a call
 - Register cordless handset

*You will not be able to schedule delayed faxes or polling jobs when memory security is **On**. However, any previously scheduled faxes will still be sent when memory security is **On**.*



Note

- To print the faxes in memory, turn off Memory Security.
- If you forget the Memory Security password, please call Brother Customer Service.

Setting and changing the Memory Security password



Note

If you have already set the password, you will not need to set it again.

Setting a password for the first time

- 1 Press **Menu**, **2**, **0**, **1**.
- 2 Enter a 4-digit number for the password. Press **OK**.
- 3 When the LCD shows *Verify:*, re-enter the password. Press **OK**.
- 4 Press **Stop/Exit**.

Changing your Memory Security password

- 1 Press **Menu**, **2**, **0**, **1**.
- 2 Press **▲** or **▼** to choose *Set Password*. Press **OK**.
- 3 Enter a 4-digit number for the current password. Press **OK**.
- 4 Enter a 4-digit number for a new password. Press **OK**.
- 5 When the LCD shows *Verify:*, re-enter the password. Press **OK**.
- 6 Press **Stop/Exit**.

Turning Memory Security on/off

If you enter the wrong password when following the instructions below, the LCD will show *Wrong Password*. Re-enter the correct password.

Turning Memory Security on

- 1 Press **Menu**, **2**, **0**, **1**.
- 2 Press **▲** or **▼** to choose *Set Security*. Press **OK**.
- 3 Enter a 4-digit number for the current password. Press **OK**.
- 4 The machine goes offline and the LCD shows *Secure Mode*.



Note

If there is a power failure, the data will stay in memory for approximately 24 hours.

Turning Memory Security off

- 1 Press **Menu**.
- 2 Enter the registered 4-digit password. Press **OK**.
Memory Security is automatically turned off.



Note

If you enter the wrong password, the LCD shows *Wrong Password* and stays offline. The machine will stay in Memory Security mode until the registered password is entered.



Fax

Sending a fax	28
Receiving a Fax	34
Telephone Services and External devices	40
Dialing and storing numbers	50
Message Center (FAX-1960C only)	55
Remote fax options	59
Printing Reports	65
Polling	67

5

Sending a fax

Entering Fax mode

To enter fax mode, press  (Fax), and the key will glow green.

Faxing from the ADF

- 1 Make sure you are in Fax mode .
- 2 Put the document face down in the ADF.
- 3 Dial the fax number.
- 4 Press **Black Start** or **Color Start**.
The machine starts scanning the document.

Note

- To cancel, press **Stop/Exit**.
- If the memory is full, the fax will be sent in real time.

Color fax transmission

Your machine can send a color fax to machines that support this feature.

However, color faxes cannot be stored in the memory. When you send a color fax, the machine will send it in real time (even if `Real Time TX` is set to `Off`).

Canceling a fax in progress

If you want to cancel a fax while the machine is scanning, dialing or sending, press **Stop/Exit**.

Broadcasting (Black & White only)

Broadcasting is when the same fax message is automatically sent to more than one fax number. You can include Groups, One-Touch, Speed-Dial numbers, and up to 50 manually dialed numbers in the same broadcast.

After the broadcast is finished, a Broadcast Report will be printed.

- 1 Make sure you are in Fax mode .
- 2 Load your document.
- 3 Enter a number. Press **OK**.
You can use either a One-Touch, a Speed-Dial, a Group, or a manually entered number.
- 4 Repeat 3 until you have entered all the fax numbers you wish to broadcast to.
- 5 Press **Black Start**.

Note

- If you did not use up any of the numbers for Groups, you can 'broadcast' faxes to as many as 160 different numbers.
- The available memory will vary depending on the types of jobs in the memory and the number of locations used for broadcasting. If you broadcast to the maximum numbers available, you will not be able to use dual access.
- If the memory is full, press **Stop/Exit** to stop the job. If more than one page has been scanned, press **Black Start** to send the portion that is in the memory.

Canceling a Broadcast in progress

- 1 Press **Menu**, **2**, **6**.
The LCD will show the fax number being dialed.
- 2 Press **OK**.
The LCD will show the job number:
- 3 Press **1** to clear.
The LCD will then show the Broadcast job number and 1.Clear 2.Exit.
- 4 To cancel the Broadcast, press **1**.
- 5 Press **Stop/Exit**.

Additional sending operations

Sending faxes using multiple settings

When you send a fax you can choose any combination of these settings: resolution, contrast, overseas mode and real time transmission.

- 1 Make sure you are in Fax mode .
- 2 Load your document.
- 3 Choose a setting you want to change. Press **OK**.
- 4 Do one of the following:

 - Press **1** to change another setting.
 - Press **2** when you have finished choosing your settings.
- 5 Send the fax as usual.

Contrast

If your document is very light or very dark, you may want to change the contrast.

Use **Light** when sending a light document.

Use **Dark** when sending a dark document.

- 1 Make sure you are in Fax mode .
- 2 Load your document.
- 3 Press **Menu, 2, 2, 1**.
- 4 Press **▲** or **▼** to choose **Auto, Light** or **Dark**. Press **OK**.



Note

Even if you choose **Light** or **Dark**, the machine will send the fax using the **Auto** setting in any of the following conditions:

- When you send a color fax.
- When you choose **Photo** as the Fax Resolution.

Changing Fax Resolution

The quality of a fax can be improved by changing the fax resolution. Resolution can be changed for the next fax *or* for all faxes.

To change the fax resolution for the next fax

- 1 Make sure you are in Fax mode .
- 2 Load your document.
- 3 Press **Resolution** and then **▲** or **▼** to choose the resolution. Press **OK**.

To change the default fax resolution

- 1 Make sure you are in Fax mode .
- 2 Press **Menu, 2, 2, 2**.
- 3 Press **▲** or **▼** to choose the resolution you want. Press **OK**.



Note

You can choose four different resolution settings for black & white faxes and two for color.

Black & White

Standard	Suitable for most typed documents.
Fine	Good for small print and transmits a little slower than Standard resolution.
S.Fine	Good for small print or artwork and transmits slower than Fine resolution.
Photo	Use when the document has varying shades of gray or is a photograph. This has the slowest transmission.

Color

Standard	Suitable for most typed documents.
Fine	Use when the document is a photograph. The transmission time is slower than Standard resolution.

If you choose **S.Fine** or **Photo** and then use the **Color** key to send a fax, the machine will send the fax using the **Fine** setting.

Dual access (Black & White only)

You can dial a number and start scanning the fax into memory—even when the machine is sending from memory, receiving faxes or printing PC data. The LCD shows the new job number and available memory.

The number of pages you can scan into the memory will vary depending on the data that is printed on them.



Note

If the **Out of Memory** message appears while scanning documents, press **Stop/Exit** to cancel or **Black Start** to send the scanned pages.

Real time transmission

When you are sending a fax, the machine will scan the documents into the memory before sending. Then, as soon as the phone line is free, the machine will start dialing and sending.

If the memory is full or you are sending a color fax, the machine will send the document in real time (even if **Real Time TX** is set to **Off**).

Sometimes, you may want to send an important document immediately, without waiting for memory transmission. You can set **Real Time TX** to **On** for all documents or **Next Fax Only** for the next fax only.

Sending in real time for all faxes

- 1 Make sure you are in Fax mode .
- 2 Press **Menu, 2, 2, 5**.

5.Real Time TX

Realtime TX:On
- 3 Press **▲** or **▼** to choose **Realtime TX:On** (or **Realtime TX:Off**). Press **OK**.

Sending in real time for the next fax only

- 1 Make sure you are in Fax mode .
- 2 Load your document.
- 3 Press **Menu, 2, 2, 5**.
- 4 Press **▲** or **▼** to choose **Next Fax Only**. Press **OK**.
- 5 Press **▲** or **▼** to choose **Next Fax:On** (or **Next Fax:Off**). Press **OK**.

Overseas Mode

If you are having difficulty sending a fax overseas due to possible interference on the phone line, we recommend that you turn on the Overseas mode. After you send a fax using this feature, the feature will turn itself off.

- 1 Make sure you are in Fax mode .
- 2 Load your document.
- 3 Press **Menu, 2, 2, 7**.
- 4 Press **▲** or **▼** to choose **On** (or **Off**). Press **OK**.

Delayed Faxing (Black & White only)

During the day you can store up to 50 faxes in the memory to be sent within 24-hours. These faxes will be sent at the time of day you enter in step 4.

1 Make sure you are in Fax mode .

2 Load your document.

3 Press **Menu, 2, 2, 3**.

3.Delayed Fax

4 Do one of the following:

- Press **OK** to accept the displayed time.
- Enter the time you want the fax to be sent (in 24-hour format).

(For example, enter 19:45 for 7:45 PM.)

Press **OK**.

1.Doc 2.Memory

5 Do one of the following:

- Press **1** to leave the document in the ADF.
- Press **2** to scan the document into the memory.



Note

The number of pages you can scan into the memory depends on the amount of data that is printed on each page.

Delayed Batch Transmission (Black & White only)

Before sending the delayed faxes, your machine will help you economize by sorting all the faxes in the memory by destination and scheduled time. All delayed faxes that are scheduled to be sent at the same time to the same fax number will be sent as one fax to save transmission time.

1 Make sure you are in Fax mode .

2 Press **Menu, 2, 2, 4**.

3 Press **▲** or **▼** to choose **On** (or **Off**). Press **OK**.

4 Press **Stop/Exit**.

Checking and canceling waiting jobs

You can check which jobs are still waiting in the memory to be sent and cancel a job. (If there are no jobs, the LCD shows **No Jobs Waiting**.)

1 Press **Menu, 2, 6**. Any waiting jobs appear on the LCD.

2 Press **▲** or **▼** to scroll through the jobs and choose the job you want to cancel. Press **OK**.

3 Do one of the following:

- Press **1** to cancel the selected job.
- Press **2** to exit without canceling.

4 When you have finished, press **Stop/Exit**.

Sending a fax manually

Manual transmission lets you hear the dialing, ringing and fax-receiving tones while sending a fax.

- 1 Make sure you are in Fax mode .
- 2 Load your document.
- 3 To listen for a dial tone do one of the following:
 - (MFC-3360C and FAX-1860C)
Press **Hook/Hold** or pick up the handset.
 - (FAX-1960C)
Press **Speaker Phone** on the machine.
- 4 Dial using the machine's dial pad.
- 5 When you hear the fax tone, press **Black Start** or **Color Start**.
- 6 If you picked up machine's handset replace it.

Sending a fax at the end of a conversation (MFC-3360C and FAX-1860C only)

At the end of a conversation you can send a fax to the other party before you both hang up.

- 1 Ask the other party to wait for fax tones (beeps) and then to press the Start or Send key before hanging up.
- 2 Make sure you are in Fax mode .
- 3 Load your document.
- 4 Press **Black Start** and **Color Start**.
- 5 If you picked up the handset replace it.

Out of Memory message

If you get an **Out of Memory** message while scanning the first page of a fax, press **Stop/Exit** to cancel the fax.

If you get an **Out of Memory** message while scanning a subsequent page, you will have the option to press **Black Start** to send the pages scanned so far, or to press **Stop/Exit** to cancel the operation.



Note

If you get an **Out of Memory** message while faxing and you do not want to delete your stored faxes to clear the memory, you can send the fax in real time. (See *Real time transmission* on page 31.)

6

Receiving a Fax

Receive modes

You must choose the receive mode depending on the external devices and telephone subscriber services you have on your lines. The diagrams will help you choose the correct mode. (For details about the receive mode, see *Using receive modes* on page 36.)

Choosing the Receive Mode

To set up Distinctive Ring see page 42.

MFC-3360C and FAX-1860C

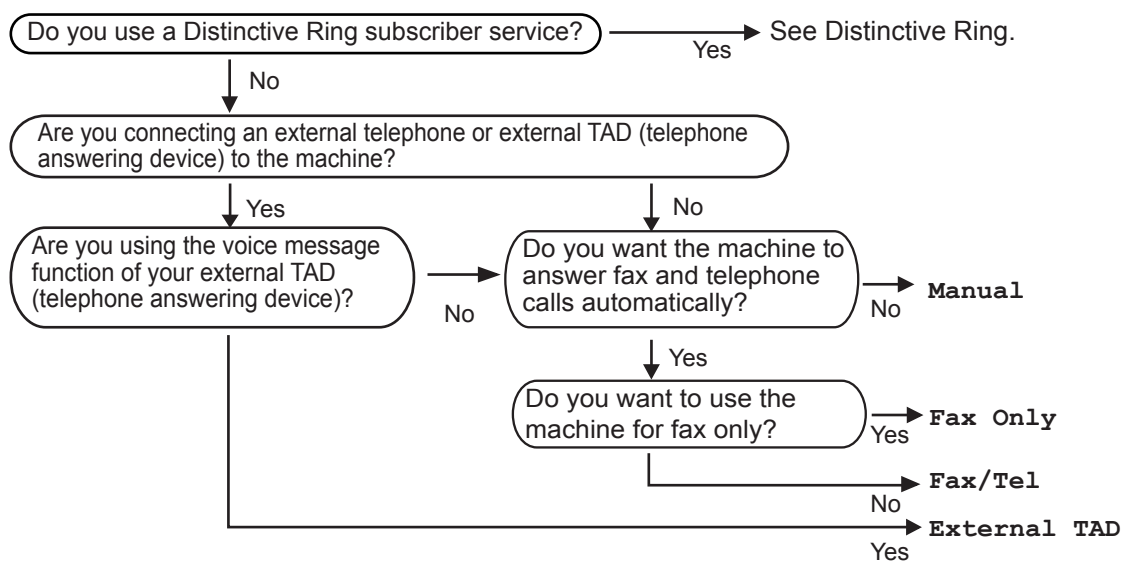

To set up the Message Center see page 55.

To set up Distinctive Ring see page 42.

FAX-1960C

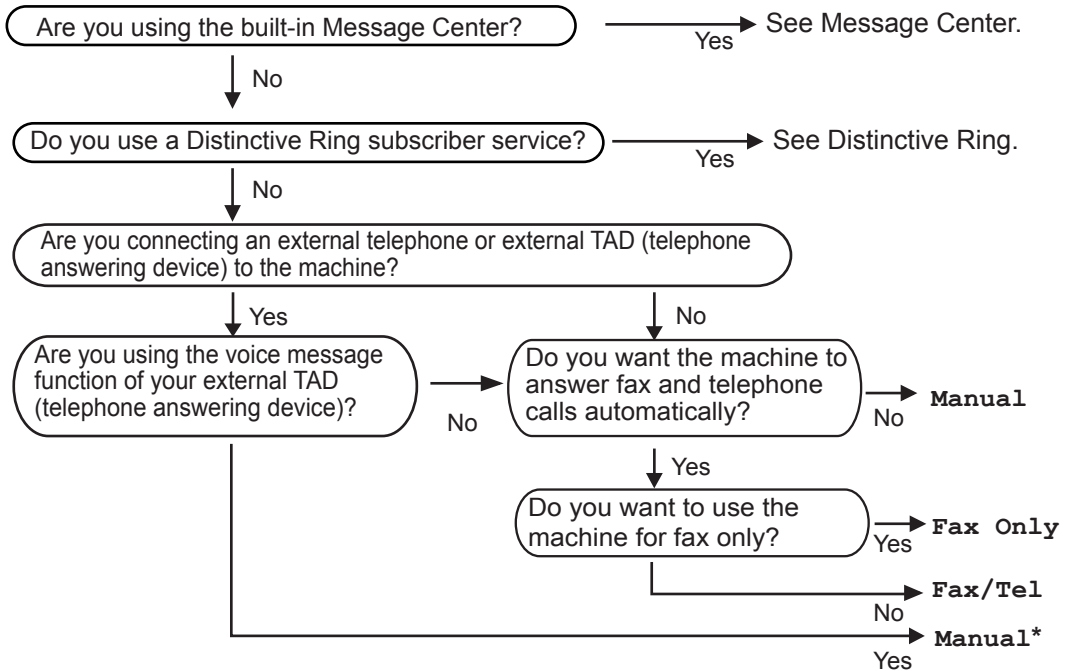

* We recommend you set **Easy Receive** to On.

To choose or change your Receive Mode

(MFC-3360C and FAX-1960C)

- 1 Press **Menu 0, 1**.
- 2 Press **▲** or **▼** to choose **Fax Only**, **Fax/Tel**, **External TAD** (MFC-3360C only) or **Manual**. Press **OK**.
- 3 Press **Stop/Exit**.

The LCD will display the current receive mode.



1 Current receive mode

Fax: Fax Only

(FAX-1860C only)

- 1 Press **Receive Mode**.
- 2 Continue to press **Receive Mode** until your new selection appears. Press **OK**.

After 2 seconds the screen returns to the date and time display, along with your new Receive Mode setting.

Using receive modes

Some receive modes answer automatically (Fax Only and Fax/Tel). You may want to change the ring delay before using these modes. (See *Ring Delay* on page 37.)

Fax only

Fax only mode will automatically answer every call. If the call is a fax your machine will receive it.

Fax/Tel

Fax/Tel mode helps you automatically manage incoming calls, by recognizing whether they are fax or voice calls and handling them in one of the following ways:

- Faxes will be automatically received.
- Voice calls will start the F/T ring to tell you to pick up the line. The F/T ring is a fast pseudo/double ring made by your machine.

Also see *F/T Ring Time (Fax/Tel mode only)* and *Ring Delay* on page 37.

Manual

Manual mode turns off all automatic answering functions unless you are using the Distinctive Ring feature or you are using an external TAD with the FAX-1960C.

To receive a fax in manual mode press **Black Start** or **Color Start** when you hear fax tones (short repeating beeps). You can also use the Easy Receive feature to receive faxes by lifting a handset on the same line as the machine.

Also see *Easy Receive* on page 37.

Message Center (MC:Msg Ctr) (FAX-1960C only)

Message Center (MC:Msg Ctr) helps you automatically manage incoming calls, by recognizing whether they are fax or voice calls and handling them in one of the following ways:

- Faxes will be automatically received.
- Voice callers can record a message.

To set up the Message Center mode see page 55.



If Message Center Mode is On, it will override your receive mode setting. The screen shows MC.



If Message Center Mode is Off, the receive mode returns to your original setting. (See *Message Center Mode* on page 55.)

External TAD

External TAD mode lets an external answering device manage your incoming calls. Incoming calls will be handled in one of the following ways:

- Faxes will be automatically received.
- Voice callers can record a message on the external TAD.

For more information see *Connecting an external TAD (telephone answering device)* on page 45.

Receive mode settings

Ring Delay

The Ring Delay sets the number of times the machine rings before it answers in *Fax Only*, *Fax/Tel* or *MC:Msg Ctr* (FAX-1960C only) mode. If you have external or extension phones on the same line as the machine or subscribe to the telephone company's Distinctive Ring service, choose the maximum number of rings. (See *Using external and extension telephones* on page 49 and *Easy Receive* on page 37.)

If toll saver is on, then the ring delay setting has no effect. (See *Setting toll saver* on page 58.)

- 1 Press **Menu**, **2**, **1**, **1**.
- 2 Press **▲** or **▼** to choose *Ring Delay*. Press **OK**.
- 3 Press **▲** or **▼** to choose how many times the line rings before the machine answers (00-04). Press **OK**.
If you choose 00, the line will not ring at all.
- 4 Press **Stop/Exit**.

F/T Ring Time (Fax/Tel mode only)

If you set the Receive Mode to *Fax/Tel*, you need to decide how long the machine will signal you with its special pseudo/double-ring when you have a voice call. If it's a fax call, the machine receives the fax.

This pseudo/double-ring happens after the initial ringing from the phone company. Only the machine rings and no other phones on the same line will ring with the special pseudo/double-ring. However, you can still answer the call on the same line as the machine. (See *Using external and extension telephones* on page 49.)

- 1 Press **Menu**, **2**, **1**, **2**.
- 2 Press **▲** or **▼** to choose how long the machine will ring to alert you that you have a voice call (20, 30, 40 or 70 seconds). Press **OK**.
- 3 Press **Stop/Exit**.



Note

Even if the caller hangs up during the pseudo/double-ringing, the machine will continue to ring for the set time.

Easy Receive

If Easy Receive is on:

The machine receives fax calls automatically, even if you lift the machine's handset. Press **Speaker Phone** or the handset of an extension or external phone.

When you see *Receiving* on the LCD or when you hear 'chirps' through the handset of an extension phone connected to another telephone wall jack, just replace the handset and your machine will do the rest.

If Easy Receive is Semi:

The machine will only receive a fax call if you answered it using the machine's handset, Speaker Phone or cordless handset.

If you are not at your machine, press **✖ 5 1** on the extension phone. (See *Using external and extension telephones* on page 49.)

If Easy Receive is Off:

If you are at the machine and answer a call first by lifting a handset, then press **Black Start** or **Color Start**.

If you are not at your machine, press **✖ 5 1** on the extension phone. (See *Using external and extension telephones* on page 49.)

**Note**

- If this feature is set to **On**, but your machine does not connect a fax call when you lift an extension or external phone handset, press the fax receive code **✖ 5 1**.
- If you send faxes from a computer on the same phone line and the machine intercepts them, set Easy Receive to **Off**.
- (FAX-1960C) If you typically carry the cordless handset away from the machine, we recommend that you turn on Easy Receive. If Easy Receive is turned off and you answer a fax call you will have to go to the machine and press **Black Start** or **Color Start**.



- 1 Press **Menu, 2, 1, 3**.
- 2 Press **▲** or **▼** to choose **On, Semi** or **Off**. Press **OK**.
- 3 Press **Stop/Exit**.

Additional receiving operations

Printing a reduced incoming fax

If you choose **On**, the machine automatically reduces each page of an incoming fax to fit on one page of A4, Letter or Legal size paper.

The machine calculates the reduction ratio by using the page size of the fax and your Paper Size setting (**Menu, 1, 3**).

- 1 Make sure you are in Fax mode .
- 2 Press **Menu, 2, 1, 5**.

- 3 Press **▲** or **▼** to select **On** or **Off**. Press **OK**.
- 4 Press **Stop/Exit**.

Receiving a fax at the end of a conversation (MFC-3360C and FAX-1860C only)

At the end of a conversation you can ask the other party to send you a fax before you both hang up.

- 1 Ask the other party to place the document in their machine and to press the Start or Send key.
- 2 When you hear the CNG tones (slowly repeating beeps), press **Black Start** or **Color Start**.
- 3 Replace the handset.

Printing a fax from the memory

If you are using the Paging or Fax Storage feature (**Menu, 2, 5, 1**), you can still print a fax from the memory when you are at your machine.

- 1 Press **Menu, 2, 5, 3**.

5.Remote Fax Opt

3.Print Fax

- 2 Press **Black Start**.

Voice Operations



Voice calls can be made either with the handset, cordless handset (FAX-1960C), the speaker phone (FAX-1960C), or an extension or external telephone. You can dial manually or use Quick-Dial numbers.



Note

If you have the FAX-1960C, please see the Digital Cordless Handset User's Guide.

Making a telephone call

- 1 To make a telephone call do one of the following:
 - (MFC-3360C and FAX-1860C)
Pick up the handset.
 - (FAX-1960C)
Pick up the cordless handset and press  (**Talk**) or press **Speaker Phone** on the machine.
- 2 When you hear the dial tone, enter a number using the dial pad, One Touch, Speed-Dial or Search.
- 3 (Speaker phone for FAX-1960C)
Speak clearly toward the microphone .
- 4 To hang up, do one of the following:
 - (MFC-3360C and FAX-1860C)
Replace the handset.
 - (FAX-1960C)
Press  (**Off**) on the cordless handset or press **Speaker Phone** on the machine.

Answering calls with the Speaker Phone (FAX-1960C)

When the machine rings, instead of lifting the handset, press **Speaker Phone** on the machine. Speak clearly toward the microphone . To end the call, press **Speaker Phone**.



Note

If you have a bad connection, your caller might hear your voice echoed during the call. If you experience the problem, pick up the handset and try the call again.

Hold

MFC-3360C and FAX-1860C

- 1 Press **Hook/Hold** to put a call on Hold. You can replace the handset without disconnecting the call.
- 2 Pick up the machine's handset to release the call from Hold.



Note

You can pick up an extension phone and continue speaking without releasing the call from Hold on the machine.

FAX-1960C

- 1 If you answered by pressing **Speaker Phone** on the machine, press **Hold/Intercom** on the machine to put a call on Hold.
- 2 Press **Speaker Phone** to release the call from Hold.



Note

You can pick up an extension phone and continue speaking without releasing the call from Hold on the machine.

Tone or pulse (Canada only)

If you have a Pulse dialing service, but need to send Tone signals (for example, for telephone banking), follow the instructions below:

- 1 Do one of the following:
 - (MFC-3360C and FAX-1860C)
Pick up the handset.
 - (FAX-1960C)
Pick up the cordless handset and press  (Talk) or press **Speaker Phone** on the machine.
- 2 Press # on the machine's control panel. Any digits dialed after this will send tone signals.
When you hang up, the machine will return to the Pulse dialing service.

Fax/Tel mode when the power key is on

When the machine is in Fax/Tel mode, it will use the F/T Ring Time (pseudo/double-ringing) to alert you to pick up a voice call.

Do one of the following:

- (MFC-3360C and FAX-1860C)
If you are at the machine you can lift the handset to answer.
- (FAX-1960C)
You can press  (Talk) on the cordless handset or press **Speaker Phone** on the machine.
- If you are at an extension phone, you'll need to lift the handset during the F/T Ring Time and then press # 5 1 between the pseudo/double rings. If no one is on the line, or if someone wants to send you a fax, send the call back to the machine by pressing ✕ 5 1.

Fax/Tel mode when the power key is off

You can change the default setting of the **On/Off** key to `Fax Receive:On` so that you can receive faxes when the power key is off. (See *On/Off setting* on page 18.)

Fax/Tel mode will work in the following ways.

- When the machine is in Fax/Tel mode and pseudo/double-rings to tell you to pick up a voice call, you can only answer by picking up the machine's handset or cordless handset and pressing  (Talk).
- If you answer before the machine pseudo/double-rings, you can also pick up the call at an external or extension phone.

Telephone services

Your machine supports the Caller ID and Distinctive Ring subscriber telephone services that some telephone companies offer.

Features like Voice Mail, Call Waiting, Call Waiting/Caller ID, Ring Master, answering services, alarm systems or other custom features on one phone line may affect the way your machine works. If you have Voice Mail on your phone line, please read the following carefully.

Distinctive Ring

Brother uses the term 'Distinctive Ring' but different telephone companies have other names for this service such as SmartRing, RingMaster, Teen-Ring, Indent-a-Call or Indent-a-Ring.

What does your telephone company's 'Distinctive Ring' do?

Your telephone company's Distinctive Ring service allows you to have more than one number on the same phone line. **If you need more than one phone number, it is cheaper than paying for an extra line.** Each phone number has its own distinctive ring pattern, so you will know which phone number is ringing. This is one way you can have a separate phone number for your machine.



Note

Please call your telephone company for availability and rates.

What does Brother's 'Distinctive Ring' do?

The Brother machine has a Distinctive Ring feature that allows you to use your machine to take full advantage of the telephone company's Distinctive Ring service. The new phone number on your line can just receive faxes.



Note

You must pay for your telephone company's Distinctive Ring service before you program the machine to work with it.

Do you have Voice Mail?

If you have Voice Mail on the phone line that you will install your new machine on, *there is a strong possibility that Voice Mail and the machine will conflict with each other while receiving incoming calls.* **However, the Distinctive Ring feature allows you to use more than one number on your line, so both Voice Mail and the machine can work together without any problems.** If each one has a separate phone number, neither will interfere with the other's operations.

If you decide to get the Distinctive Ring service from the telephone company, you will need to follow the directions on next page to 'register' the new Distinctive Ring pattern they give you. This is so your machine can recognize its incoming calls.







Note

You can change or cancel the Distinctive Ring pattern at any time. You can switch it off temporarily, and turn it back on later. When you get a new fax number, make sure you reset this feature.

Before you choose the ring pattern to register

You can only register one Distinctive Ring pattern with the machine. Some ring patterns cannot be registered. The ring patterns below are supported by your Brother machine. Register the one your telephone company gives you.

Ring Pattern	Rings	
1	long-long	
2	short-long-short	
3	short-short-long	
4	very long (normal pattern)	



Note



If the ring pattern you received is not on this chart, **please call your telephone company and ask for one that is shown.**

- The machine will only answer calls to its registered number.
- The first two rings are silent on the machine. This is because the fax must 'listen' to the ring pattern (to compare it to the pattern that was 'registered'). (Other telephones on the same line will ring.)
- If you program the machine properly, it will recognize the registered ring pattern of the 'fax number' within 2 ring patterns and then answer with a fax tone. When the 'voice number' is called, the machine will not answer.

Registering the Distinctive Ring pattern

Very Important!

After you have set the Distinctive Ring feature to on, the receive mode is set to **Manual** automatically. You cannot change the receive mode to another mode while the Distinctive Ring is set to on.

- 1 Press **Menu, 2, 0, 3.**

- 2 Press **▲** or **▼** to choose **Set.**
Press **OK.**
- 3 Press **▲** or **▼** to choose the stored ring pattern you want to use.
Press **OK.**
(You hear each pattern as you scroll through the four patterns. Make sure you choose the pattern that the telephone company gave you.)
- 4 Press **Stop/Exit.**
Distinctive Ring is now set to on.

Turning off Distinctive Ring

- 1 Press **Menu, 2, 0, 3.**
- 2 Press **▲** or **▼** to choose **Off.**
Press **OK.**
- 3 Press **Stop/Exit.**



Note

If you turn off Distinctive Ring, the machine will stay in **Manual** receive mode. You will need to set the Receive Mode again. (See *Choosing the Receive Mode* on page 34.)

Caller ID

The Caller ID feature lets you use the Caller ID subscriber service offered by many local telephone companies. Call your telephone company for details. This service shows the telephone number, or name if it is available, of your caller as the line rings.

After a few rings, the LCD shows the telephone number of your caller (and name, if available). Once you answer a call, the Caller ID information disappears from the LCD, but the call information stays stored in the Caller ID memory.

- You can see the first 16 characters of the number (or name).
- The `Out of Area` message means the call originated outside your Caller ID service area.
- The `Private Call` message means the caller has intentionally blocked transmission of information.

You can print a list of the Caller ID information received by your machine. (See *Printing Caller ID List* on page 44.)



Note

Caller ID service varies with different carriers. Call your local telephone company to find out about the kind of service available in your area.

Viewing Caller ID List

If Caller ID is set to On, your machine stores information for the last thirty calls in the Caller ID list. You can view or print this list. When the thirty-first call comes in to the machine, it replaces information about the first call.

- 1 Press **Menu, 2, 0, 4**.
- 2 Press **▲** or **▼** to choose `Display#`. Press **OK**.
The Caller ID list will appear on the display. If no ID is stored, the beeper will sound and `No Caller ID` will appear on the display.
- 3 Press **▲** or **▼** to scroll through the Caller ID memory to choose the Caller ID you want to view, and then press **OK**.
The LCD shows the caller's number or name and the date and time of the call.
- 4 Do one of the following:
 - To return to the Caller ID listing, press **◀**.
 - To finish viewing, press **Stop/Exit**.

Printing Caller ID List

- 1 Press **Menu, 2, 0, 4**.
- 2 Press **▲** or **▼** to choose `Print Report`. Press **OK**.
If no ID is stored, the beeper will sound and `No Caller ID` will appear on the LCD.
- 3 Press **Black Start** or **Color Start**.
- 4 After printing has finished, press **Stop/Exit**.

Connecting an external TAD (telephone answering device)

You may choose to connect an external answering device. However, when you have an **external** TAD on the same telephone line as the machine, the TAD answers all calls and the machine 'listens' for fax calling (CNG) tones. If it hears them, the machine takes over the call and receives the fax. If it does not hear CNG tones, the machine lets the TAD continue playing your outgoing message so your caller can leave you a voice message.

The TAD must answer within four rings (the recommended setting is two rings). The machine cannot hear CNG tones until the TAD has answered the call, and with four rings there are only 8 to 10 seconds of CNG tones left for the fax 'handshake'. Make sure you carefully follow the instructions in this guide for recording your outgoing message. We do not recommend using the toll saver feature on your external answering machine if it exceeds five rings.

Note

- If you do not receive all your faxes, reduce the Ring Delay setting on your external TAD.
- If You Subscribe to your Telephone company's Distinctive Ring Service:
You may connect an external TAD to a separate wall jack only if you subscribe to your telephone company's Distinctive Ring service, have registered the distinctive ring pattern on your machine, and use that number as a fax number. The recommended setting is at least four rings on the external TAD when you have the telephone company's Distinctive Ring Service. You cannot use the Toll Saver setting.

- If You Do Not Subscribe to Distinctive Ring Service:

You must plug your TAD into the EXT. jack of your machine. If your TAD is plugged into a wall jack, both your machine and the TAD will try to control the phone line. (See the illustration below.)

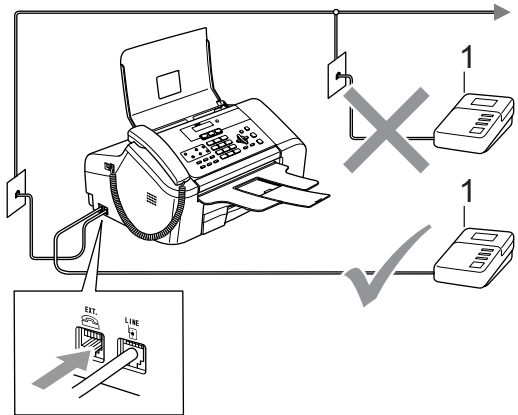

1 TAD

When the TAD answers a call, the LCD shows Ext. Tel in Use (for MFC-3360C and FAX-1860C) and Telephone (FAX-1960C).

Connections

The external TAD must be plugged into the jack labeled EXT. Your machine cannot work properly if you plug the TAD into a wall jack (unless you are using Distinctive Ring).

- 1 Plug the telephone line cord from the telephone wall jack into the jack labeled LINE.
- 2 Plug the telephone line cord from the external TAD into the jack labeled EXT. (Make sure this cord is connected to the TAD at the TAD's telephone line jack, and not its handset jack.)
- 3 Set your external TAD to four rings or less. (The machine's Ring Delay setting does not apply.)
- 4 Record the outgoing message on your external TAD.
- 5 Set the TAD to answer calls.
- 6 Do one of the following:
 - (MFC-3360C and FAX-1860C)
Set the Receive Mode to `External TAD`. (See *Choosing the Receive Mode* on page 34.)
 - (FAX-1960C)
Set the receive mode to `Manual` with Easy Receive turned on.

Recording an outgoing message (OGM) on an external TAD

Timing is important in recording this message. The message sets up the ways to handle both manual and automatic fax reception.

- 1 Record 5 seconds of silence at the beginning of your message. (This allows your machine time to listen for the fax CNG tones of automatic transmissions before they stop.)
- 2 Limit your speaking to 20 seconds.
- 3 End your 20-second message by giving your Fax Receive Code for people sending manual faxes. For example: 'After the beep, leave a message or send a fax by pressing * 5 1 and Start.'



Note

We recommend beginning your OGM with an initial 5-second silence because the machine cannot hear fax tones over a resonant or loud voice. You may try omitting this pause, but if your machine has trouble receiving, then you must re-record the OGM to include it.

Special line considerations

Roll over phone lines

A roll over phone system is a group of two or more separate telephone lines that pass incoming calls to each other if they are busy. The calls are usually passed down or 'rolled over' to the next available phone line in a preset order.

Your machine can work in a roll over system as long as it is the last number in the sequence, so the call cannot roll away. Do not put the machine on any of the other numbers; when the other lines are busy and a second fax call is received, the fax call will be sent to a line that does not have a fax machine. **Your machine will work best on a dedicated line.**

Two-line phone system

A two-line phone system is nothing more than two separate phone numbers on the same wall outlet. The two phone numbers can be on separate jacks (RJ11) or mixed into one jack (RJ14). Your machine must be plugged into an RJ11 jack. RJ11 and RJ14 jacks may be equal in size and appearance and both may contain four wires (black, red, green, yellow). To test the type of jack, plug in a two-line phone and see if it can access both lines. If it can, you must separate the line for your machine. (See *Easy Receive* on page 37.)

Converting telephone wall outlets

There are three ways to convert to an RJ11 jack. The first two ways may require help from the telephone company. You can change the wall outlets from one RJ14 jack to two RJ11 jacks. Or you can have an RJ11 wall outlet installed and slave or jump one of the phone numbers to it.

The third way is the easiest: Buy a triplex adapter. You can plug a triplex adapter into an RJ14 outlet. It separates the wires into two separate RJ11 jacks (Line 1, Line 2) and a third RJ14 jack (Lines 1 and 2). If your machine is on Line 1, plug the machine into L1 of the triplex adapter. If your machine is on Line 2, plug it into L2 of the triple adapter.

Triplex Adapter

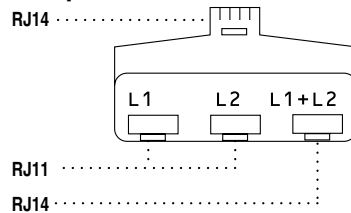

Installing machine, external two-line TAD and two-line telephone

When you are installing an external two-line telephone answering device (TAD) and a two-line telephone, your machine must be isolated on one line at both the wall jack and at the TAD. The most common connection is to put the machine on Line 2, which is explained in the following steps. The back of the two-line TAD must have two telephone jacks: one labeled L1 or L1/L2, and the other labeled L2. You will need at least three telephone line cords, the one that came with your machine and two for your external two-line TAD. You will need a fourth line cord if you add a two-line telephone.

- 1 Put the two-line TAD and the two-line telephone next to your machine.
- 2 Plug one end of the telephone line cord for your machine into the L2 jack of the triplex adapter. Plug the other end into the LINE jack on the back of the machine.
- 3 Plug one end of the first telephone line cord for your TAD into the L1 jack of the triplex adapter. Plug the other end into the L1 or L1/L2 jack of the two-line TAD.

- 4 Plug one end of the second telephone line cord for your TAD into the L2 jack of the two-line TAD. Plug the other end into the EXT. jack on the left side of the machine.

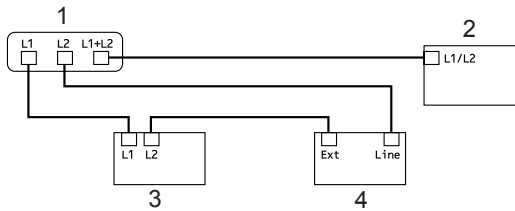

- 1 Triplex Adapter
- 2 Two Line Phone
- 3 External Two Line TAD
- 4 Machine

You can keep two-line telephones on other wall outlets as always. There are two ways to add a two-line telephone to the machine's wall outlet. You can plug the telephone line cord from the two-line telephone into the L1+L2 jack of the triplex adapter. Or you can plug the two-line telephone into the TEL jack of the two-line TAD.

Multi-line connections (PBX)

We suggest you ask the company who installed your PBX to connect your machine. If you have a multi line system we suggest you ask the installer to connect the unit to the last line on the system. This prevents the machine being activated each time the system receives telephone calls. If all incoming calls will be answered by a switchboard operator we recommend that you set the Receive Mode to *Manual*.

We cannot guarantee that your machine will operate properly under all circumstances when connected to a PBX. Any difficulties with sending or receiving faxes should be reported first to the company who handles your PBX.

External and extension phones

Connecting an external or extension telephone

You can connect a separate telephone (or telephone answering device) directly to your machine as shown in the diagram below.

Connect the telephone line cord to the jack labeled EXT.

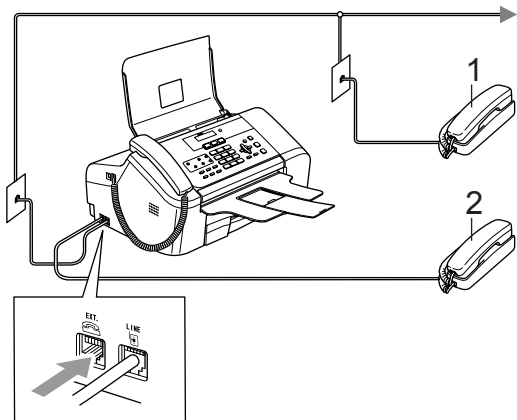

- 1 Extension telephone
- 2 External telephone

When you are using an external phone, the LCD shows *Ext. Tel in Use* (MFC-3360C and FAX-1860C) and *Telephone* (FAX-1960C).

Using external and extension telephones

If you answer a fax call on an extension or an external telephone connected to the EXT. jack of the machine, you can make your machine take the call by using the Fax Receive Code. When you press the Fax Receive Code **✖ 5 1**, the machine starts to receive the fax.

If the machine answers a voice call and pseudo/double-rings for you to take over, use the Telephone Answer Code **# 5 1** to take the call at an extension phone. (See *F/T Ring Time (Fax/Tel mode only)* on page 37.)

If you answer a call and no one is on the line:

You should assume that you're receiving a manual fax.

Press **✖ 5 1** and wait for the chirp or until the LCD shows *Receiving*, and then hang up.



Note

You can also use the Easy Receive feature to make your machine automatically take the call. (See *Easy Receive* on page 37.)

Using a non-Brother cordless external telephone (MFC-3360C and FAX-1860C)

If your non-Brother cordless telephone is connected to the EXT. jack of the machine and you typically carry the cordless handset elsewhere, it is easier to answer calls during the Ring Delay.

If you let the machine answer first, you will have to go to the machine so you can press **Hook/Hold** or **Speaker Phone** to send the call to the cordless handset.

Using remote codes

Fax receive code

If you answer a fax call on an extension or external telephone, you can tell your machine to receive it by dialing the fax receive code **✖ 5 1**. Wait for the chirping sounds then replace the handset. (See *Easy Receive* on page 37.) Your caller will have to press **Start** to send the fax.

Telephone answer code

If you receive a voice call and the machine is in F/T mode, it will start to sound the pseudo/double-ring after the initial ring delay. If you pick up the call on an extension phone you can turn the pseudo/double-ring off by pressing **# 5 1** (make sure you press this *between* the rings).

Changing the remote codes

The preset Fax Receive Code is **✖ 5 1**. The preset Telephone Answer Code is **# 5 1**. If you want to, you can replace them with your own codes.

- 1 Press **Menu, 2, 1, 4**.

1.Setup Receive

4.Remote Codes

- 2 Press **▲** or **▼** to choose **On**. Press **OK**.
- 3 Enter the new Fax Receive Code. Press **OK**.
- 4 Enter the new Telephone Answer Code. Press **OK**.
- 5 Press **Stop/Exit**.



Note

- If you are always disconnected when accessing your external TAD remotely, try changing the Fax Receive Code and Telephone Answer Code to another three-digit code (such as **###** and **999**).
- Remote Codes might not work with some telephone systems.

8

Dialing and storing numbers

How to Dial

Manual dialing

Press all of the digits of the fax number.



One-Touch Dialing

Press the One-Touch key that stores the number you want to call.

To dial One-Touch numbers **6 to 10**, hold down **Shift** as you press the One-Touch key.

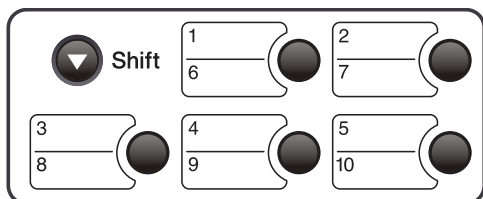

Speed-Dialing

- 1 Press **Search/Speed Dial**, the # (pound) key, and then the two digit Speed-Dial number.

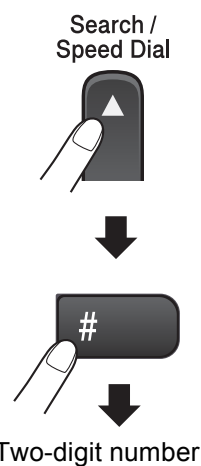

Note

If the LCD shows *Not Registered* when you enter a One-Touch number or a Speed-Dial number, a number has not been stored at this location.

Search

You can search for names you have stored in the One-Touch and Speed-Dial memories.

Press **Search/Speed Dial** and the menu keys to search numerically or use the dial pad and then the menu keys to search alphabetically.

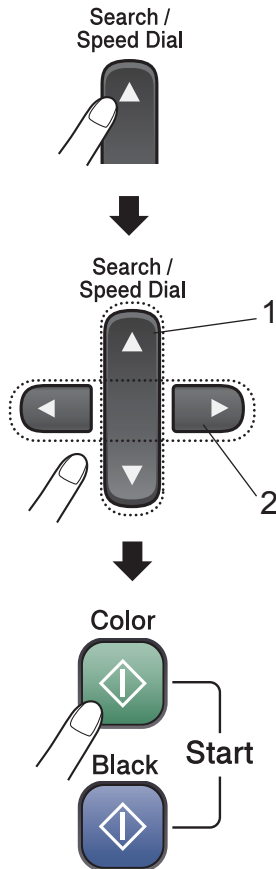

- 1 To search numerically.
- 2 To search alphabetically, you can use the dial pad to enter the first letter of the name you are looking for.

Fax Redial

If you are sending a fax manually and the line is busy, press **Redial/Pause**, and then press **Black Start** or **Color Start** to try again. If you want to make a second call to the last number dialed, you can save time by pressing **Redial/Pause** and **Black Start** or **Color Start**.

Redial/Pause only works if you dialed from the control panel.

If you are sending a fax automatically and the line is busy, the machine will automatically redial one time after five minutes.

Storing numbers

You can set up your machine to do the following types of easy dialing: One-Touch, Speed-Dial and Groups for broadcasting faxes. When you dial a Quick-Dial number, the LCD shows the name, if you stored it, or the number.



Note

If you lose electrical power, the Quick-Dial numbers that are in the memory will not be lost.

Storing a pause

Press **Redial/Pause** to put a 3.5-second pause between numbers. If you are dialing access codes and credit card numbers or overseas, you can press **Redial/Pause** as many times as needed to increase the length of the pause.

Storing One-Touch Dial numbers

Your machine has 5 One-Touch keys where you can store 10 fax or phone numbers for automatic dialing. To access numbers **6** to **10**, hold down **Shift** as you press the One-Touch key.

- 1 Press **Menu**, **2**, **3**, **1**.
- 2 Press the One-Touch key where you want to store a number.
- 3 Enter the number (up to 20 digits). Press **OK**.
- 4 Do one of the following:
 - Enter the name using the dial pad (up to 16 characters). (To help you enter letters, see *Entering Text* on page 120.) Press **OK**.
 - To store the number without a name, press **OK**.
- 5 Do one of the following:
 - To store another One-Touch number, go to step 2.
 - To finish storing One-Touch numbers, press **Stop/Exit**.

Storing Speed-Dial numbers

You can store up to 100 two-digit Speed-Dial locations with a name. When you dial you will only have to press a few keys (For example: **Search/Speed Dial #**, the two-digit number, and **Black Start** or **Color Start**).

- 1 Press **Menu**, **2**, **3**, **2**.
- 2 Use the dial pad to enter a 2-digit Speed-Dial location number (00-99). Press **OK**.
- 3 Enter the fax or telephone number (up to 20 digits). Press **OK**.
- 4 Do one of the following:
 - Enter the name (up to 16 characters) using the dial pad.
Press **OK**. (To help you enter letters, see *Entering Text* on page 120.)
 - To store the number without a name, press **OK**.
- 5 Do one of the following:
 - To store another Speed-Dial number, go to step 2.
 - To finish the setting, press **Stop/Exit**.

Changing One-Touch and Speed-Dial numbers

If you try to store a One-Touch or Speed-Dial number where a number has already been stored, the LCD will show the name or number that has been stored there, and will ask you to do one of the following:

- Press **1** to change the stored number.

#05:MIKE

1.Change 2.Exit

- Press **2** to exit without making a change.

If you chose **1**, you will be able to change the stored number and name, or enter a new one. Follow the instructions below:

1 Enter a new number. Press **OK**.

2 Enter a new name. Press **OK**.

- To change a character, use ◀ or ▶ to position the cursor under the character you want to change, then press **Clear/Back**. Re-enter the character.

Setting up Groups for broadcasting

If you regularly want to send the same fax message to many fax numbers you can set up a Group. Groups are stored on a One-Touch key or a Speed-Dial number. Each group uses up a One-Touch key or a Speed-Dial location. You can then send the fax message to all the numbers stored in a Group just by pressing a One-Touch key or entering a Speed-Dial number, and then pressing **Black Start**.

Before you can add numbers to a Group, you need to store them as One-Touch or Speed-Dial numbers. You can have up to six small Groups, or you can assign up to 99 numbers to one large Group.

1 Press **Menu**, **2**, **3**, **3**.

3.Setup Groups

2 Choose an empty location where you want to store the Group in one of the following ways:

- Press a One-Touch key.
- Press **Search/Speed Dial** and enter a two-digit location. Press **OK**.

3 Use the dial pad to enter a Group number (1 to 6). Press **OK**.

Setup Group:G01

4 To add One-Touch or Speed-Dial numbers to the Group follow the instructions below:

- For One-Touch number 6 press One-Touch key **6**.
- For Speed-Dial location 09, press **Search/Speed Dial**, and then press **0 9** on the dial pad.

The LCD will display your chosen One-Touch numbers with a ✱, and Speed-Dial numbers with a # as shown in the illustration.

G01:✱06 #09

- 5 Press **OK** when you have finished adding numbers.
- 6 Use the dial pad to enter a name for the Group.
Press **OK**.
- 7 Press **Stop/Exit**.



Note

You can easily print a list of all your Quick-Dial numbers. Numbers that are part of a group will be marked in the GROUP column. (See *How to print a report* on page 66.)

Dialing access codes and credit card numbers

You can combine more than one Quick-Dial number when you dial. This feature may be useful if you need to dial an access code for a cheaper rate long distance carrier.

For example, you might have stored '555' on Speed-Dial #03 and '7000' on Speed-Dial #02. You can use them both to dial '555-7000' if you press the following keys:

Search/Speed Dial, #03, Search/Speed Dial, #02, and Black Start or Color Start.

Numbers can be added manually by entering them on the dial pad:

Search/Speed Dial, #03, 7, 0, 0, 1 (on the dial pad), and **Black Start or Color Start.**

This would dial '555-7001'. You can also add a pause by pressing the **Redial/Pause** key.

Message Center Mode

The Message Center feature will store up to 99 incoming messages. Messages are stored in the order in which they are received.

Voice messages can be up to 3 minutes in length and can also be picked up remotely. (See *Setting a Remote Access Code* on page 61.) The number of messages you can store will depend on how much memory is being used by other features (for example, delayed and stored faxes).

In the event of a power failure your machine will retain messages that are in the memory for approximately 24 hours.

Setting up the Message Center

Recording the Message Center outgoing message (Msg Ctr OGM) is the first step you need to follow before you can use the Message Center.

To enter Message Center mode, follow the steps below:

- 1 Record your Message Center OGM.
- 2 Press  to activate the Message Center.

Outgoing message (OGM)

Recording your OGM

You can record the following two different types of OGMs:

Msg Ctr	This message will be played when a call is received. The caller will be able to leave a voice or fax message.
F/T	This message is played when a call is received and your machine is set to Fax/Tel mode. The caller will <i>not</i> be able to leave a message. See page 56.

Your OGM must be less than 20 seconds long.

- 1 Press **Menu**, **2**, **7**, **1**.
The LCD prompts you to choose an OGM.
- 2 Press **▲** or **▼** to choose **Msg Ctr OGM** or **F/T OGM**.
Press **OK**.
- 3 Press **▲** or **▼** to choose **Record OGM**.
Press **OK**.



Note

If callers tell you they cannot leave a message on your machine, make sure you have chosen **Msg Ctr OGM** (not **F/T OGM**).

- 4 Record your message as follows:
 - Speak clearly toward the integrated microphone  to record your message. Press **Stop/Exit** when you are finished.

The Message Center will play your OGM back to you.

- 5 Press **Stop/Exit**.

Listening to your OGM

- 1 Press **Menu**, **2**, **7**, **1**.
- 2 Press **▲** or **▼** to choose **Msg Ctr OGM** or **F/T OGM**. Press **OK**.
- 3 Press **▲** or **▼** to choose **Play OGM**. Press **OK**.
- 4 Press **Stop/Exit**.

Erasing your OGM



- 1 Press **Menu**, **2**, **7**, **1**.
- 2 Press **▲** or **▼** to choose **Msg Ctr OGM** or **F/T OGM**. Press **OK**.
- 3 Press **▲** or **▼** to choose **Erase OGM**. Press **OK**.
- 4 Do one of the following:
 - Press **1** to erase the OGM.
 - Press **2** to exit without erasing.
- 5 Press **Stop/Exit**.

Fax/Tel OGM (Announcement)

If your machine is set to Fax/Tel receive mode, this message will be played by your Brother machine to a caller. Unlike the **Msg Ctr OGM**, the caller *will not* be able to leave a message.

To record your Fax/Tel OGM follow the instructions on page 55 and choose **F/T OGM** (not **Msg Ctr OGM**). If you need to review the steps for setting up the Fax/Tel receive mode, see *Receive modes* on page 34.

Activating Message Center memory

When the  light glows, Message Center mode is active. Press  to enter **MC:Msg Ctr** mode.

MC:Msg Ctr

Managing your messages

Message Indicator

The  light flashes if you have new messages waiting for you. The LCD displays the total number of voice and fax messages stored in the Message Center memory.

Voice:03 Fax:00

*Fax messages are only stored when Fax Storage is turned on. To turn fax storage on press **Menu 2, 5, 1**.*

Playing voice messages

All messages are played in the order they were recorded. The LCD shows the number of the current message, the total number of messages, and the time and date the message was recorded. Follow the steps below to listen to your voice messages:

- 1 Press **Play**.
The following commands are available when playing messages:

- | | |
|---------|---------------------------|
| ✳ ⏮ | Repeats a message |
| # ⏭ | Skips to the next message |
| 🔊 or 🔊) | Adjusts the volume |

- 2 Press **Stop/Exit**.

Printing fax messages

Once you print a new fax message stored in memory it will automatically be erased from the memory.

- 1 Press **Play**. After two seconds, the fax machine begins to play voice messages.
- 2 If Fax Storage is on and there are fax messages in memory the LCD displays the following:

Print Fax

1.Yes 2.No
- 3 Do one of the following:
 - Press **1** to print your faxes.
 - Press **2** to exit without printing.

Erasing incoming messages

To erase voice messages individually

- 1 Press **Play**.
The machine will sound a two second beep and begins message playback. Each message is preceded by one long beep and followed by two short beeps.
- 2 To erase a specific message, press **Erase** immediately after the two short beeps or while the message is playing.
- 3 Do one of the following:

Erase this Msg.?

1.Yes 2.No

 - Press **1** to erase the message.
 - Press **2** to exit without erasing.
- 4 Press **Stop/Exit**.

To erase all of your messages

- 1 Press **Erase**.
- 2 Press **▲** or **▼** to choose one of the options below. Then press **OK**.

Erase All voice? All voice messages

Erase All Fax? All fax messages

Erase All Msg.? All voice and fax messages

- 3 Do one of the following:
 - Press **1** to erase all of your messages.
 - Press **2** to cancel.
- 4 Press **Stop/Exit**.

Additional Message Center operations

Setting maximum time for incoming messages

Your machine's default setting will save incoming messages up to 30 seconds long. To change this setting follow the steps below:

- 1 Press **Menu, 2, 7, 2.**

Setup Msg Ctr

2. ICM Max. Time

- 2 Press **▲** or **▼** to choose the maximum time setting for incoming messages (30, 60, 120 or 180 seconds). Press **OK**.

- 3 Press **Stop/Exit**.

Setting toll saver

When the toll saver feature is on, the machine will answer after two rings if you do have voice or fax messages, and after four rings if you *do not* have any messages.

This way, when you call your machine for remote retrieval, if it rings three times you have no messages and can hang up to avoid a toll charge.

The toll saver feature is only available when Message Center mode is on. When toll saver is On, it overrides your ring delay setting. If you are using Distinctive Ring do not use the Toll Saver feature.

- 1 Make sure you are in fax mode. If not then press  (**Fax**).

- 2 Press **Menu, 2, 1, 1.**

1. Setup Receive

1. Ring Delay

- 3 Press **▲** or **▼** to choose **Toll Saver**. Press **OK**.

- 4 Press **▲** or **▼** to choose **On** (or **Off**). Press **OK**.

- 5 Press **Stop/Exit**.

ICM Recording Monitor

This feature lets you turn the speaker volume for voice messages **On** or **Off**. When you turn the monitor **Off**, you will not hear messages as they come in.

- 1 Press **Menu, 2, 7, 3.**

Setup Msg Ctr

3. ICM Rec. Monitr

- 2 Press **▲** or **▼** to choose **Off** or **On**. Press **OK**.

- 3 Press **Stop/Exit**.

Remote fax options ARE NOT available for color fax.

You can use *only one* remote fax option at a time.

Fax Forwarding

The fax forwarding feature lets you automatically forward your received faxes to another machine. If you choose Backup Print:On the machine will also print the fax (this is a safety feature in case there is a power failure).

- 1 Press **Menu**, **2**, **5**, **1**.
- 2 Press **▲** or **▼** to choose **Fax Forward**. Press **OK**.
 The LCD will ask you to enter the fax number you want your faxes to be forwarded to.
- 3 Enter the forwarding number (up to 20 digits). Press **OK**.
- 4 Press **▲** or **▼** to choose
 Backup Print:On or
 Backup Print:Off.
 Press **OK**.



Note

When Fax Forwarding is turned on your machine will only receive black & white faxes into memory. Color faxes will not be received, unless the sending machine converts them to black & white before sending.

- 5 Press **Stop/Exit**.

Paging

When you choose Paging, your machine dials the pager number you have programmed, and then dials your Personal identification Number (PIN). This activates your pager so you will know that you have a fax message in the memory.

- 1 Press **Menu**, **2**, **5**, **1**.
- 2 Press **▲** or **▼** to choose **Paging**. Press **OK**.
- 3 Enter your pager phone number followed by ## (up to 20 digits). Press **OK**.
 Do not include the area code if it is the same as that of your machine.
 For example, press:
1 8 0 0 5 5 1 2 3 4 # #.
- 4 Do one of the following:
 - If your pager needs a PIN, enter the PIN, press **#**, press **Redial/Pause**, and then enter your fax number followed by ##.
 Press **OK**.
 For example, press:
1 2 3 4 5 # Redial/Pause 1 8 0 0 5 5 5 6 7 8 9 # #.
 - If you do not need a PIN, press:
Redial/Pause, and then enter your fax number followed by ##.
 Press **OK**.
 For example, press:
Redial/Pause 1 8 0 0 5 5 5 6 7 8 9 # #
- 5 Press **Stop/Exit**.

Note

- You cannot change a paging number or PIN remotely.
- If you have set Paging, a backup copy will automatically be printed at the machine.
- If Paging is turned on your machine cannot receive a color fax unless the sending machine converts it to black & white.
- If you want to be paged for voice messages, make sure you press the MC on/off key  to turn the Message Center on.

Fax Storage

The fax storage feature lets you store your received faxes in the machine's memory. You can retrieve stored fax messages from a fax machine at another location using the remote retrieval commands. (See *Retrieving fax messages* on page 62.) Your machine will automatically print a copy of the stored fax.

- 1 Press **Menu**, **2**, **5**, **1**.

1.Fwd/Page/Store

- 2 Press **▲** or **▼** to choose **Fax Storage**. Press **OK**.

- 3 Press **Stop/Exit**.

Note

If Fax Storage is turned on your machine cannot receive a color fax unless the sending machine converts it to black & white.

Changing Remote Fax Options

If received faxes are left in your machine's memory when you change the remote fax options, the LCD will ask you one of the following messages:

Erase All Fax?

1.Yes 2.No

Print All Fax?

1.Yes 2.No

- If you press **1**, faxes in the memory will be erased or printed before the setting changes. If a backup copy has already been printed it will not be printed again.
- If you press **2**, faxes in the memory will not be erased or printed and the setting will be unchanged.

Turning off Remote Fax Options

- 1 Press **Menu**, **2**, **5**, **1**.

1.Fwd/Page/Store

- 2 Press **▲** or **▼** to choose **Off**. Press **OK**.

- 3 Press **Stop/Exit**.

Note

The LCD will give you more options if there are received faxes still in your machine's memory. (See *Changing Remote Fax Options* on page 60.)

Remote Retrieval

You can call your machine from any touch tone telephone or fax machine, then use the remote access code and remote commands to retrieve fax messages.

Setting a Remote Access Code

The remote access code lets you access the remote retrieval features when you are away from your machine. Before you use the remote access and retrieval features, you have to set up your own code. The factory default code is inactive code (---✳).

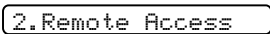
- 1 Press **Menu, 2, 5, 2**.

- 2 Enter a three-digit code using numbers **0-9, ✳, or #**.
 Press **OK**. (The preset '✳' cannot be changed.)
- 3 Press **Stop/Exit**.



Note

Do not use the same code as your fax receive code (**✳ 5 1**) or telephone answer code (**# 5 1**). (See *Using external and extension telephones* on page 49.)

You can change your code at any time by entering a new one. If you want to make your code inactive, press **Clear/Back** in step 2 to restore the inactive setting (---✳) and press **OK**.

Using your Remote Access Code

- 1 Dial your fax number from a telephone or another fax machine using touch tone.
- 2 When your machine answers, enter your remote access code (3 digits followed by ✳).
- 3 The machine signals if it has received messages:
 - 1 long beep — Fax messages
 - 2 long beeps — Voice messages (FAX-1960C only)
 - 3 long beeps — Fax & Voice messages (FAX-1960C only)
 - No beeps — No messages
- 4 When the machine gives two short beeps, enter a command.
 The machine will hang up if you wait longer than 30 seconds to enter a command.
 The machine will beep three times if you enter an invalid command.
- 5 Press **9 0** to reset the machine when you have finished.
- 6 Hang up.



Note

If your machine is set to **Manual** mode and you want to use the remote retrieval features, wait about 2 minutes after it starts ringing, and then enter the remote access code within 30 seconds.

Retrieving fax messages

- 1 Dial your fax number from a telephone or another fax machine using touch tone.
- 2 When your machine answers, enter your remote access code (3 digits followed by ✕). If you hear one long beep, you have messages.
- 3 When you hear two short beeps, press **9 6 2**.
- 4 Wait for the long beep, and then use the dial pad to enter the number (up to 20 digits) of the remote fax machine where you want your fax messages sent to, followed by **# #**.



Note

You cannot use ✕ and # as dial numbers. However, press # if you want to create a pause.

- 5 Press **9 0** to reset the machine when you have finished.
- 6 Hang up after you hear your machine beep. Your machine will call the other fax machine, which will then print your fax messages.



Note

You can insert a pause in a fax number by using the # key.

Changing your Fax Forwarding number

You can change the default setting of your fax forwarding number from another telephone or fax machine using touch tone.

- 1 Dial your fax number from a telephone or another fax machine using touch tone.
- 2 When your machine answers, enter your remote access code (3 digits followed by ✕) at once. If you hear one long beep, you have messages.
- 3 When you hear two short beeps, press **9 5 4**.
- 4 Wait for the long beep, and then use the dial pad to enter the new number (up to 20 digits) of the remote fax machine where you want your fax messages forwarded followed by **# #**.
- 5 Press **9 0** to reset the machine when you have finished.
- 6 Hang up after you hear your machine beep.



Note

You can insert a pause in a fax number by using the # key.

Remote fax commands

Follow the commands below to access features when you are away from the machine. When you call the machine and enter your remote access code (3 digits followed by *), the system will give two short beeps and you must enter a remote command.

Remote commands		Operation details	
91	Playing Voice messages (FAX-1960C)	After one long beep, the machine plays the ICMs.	
	1 Repeat or Skip Backward	Press 1 while listening to an ICM to repeat it. If you press 1 before a message, you will hear the previous message.	
	2 Skip Forward	While playing the ICM, you can skip to the next message.	
	9 STOP Playing	Stop Playing the ICM.	
93	Erase all ICM (FAX-1960C)	If you hear one long beep, the erase is accepted. If you hear three short beeps, you cannot erase the ICMs because all voice messages have not been played or there are no voice messages to erase. *This code erases all recorded messages, not one at a time.	
94	Play and Record OGM in Memory (FAX-1960C)		
	1 Play	1 Msg Ctr OGM	The machine plays the selected OGM. You can stop playing OGMs by pressing 9 .
		2 F/T OGM	
	2 Record	1 Msg Ctr OGM	After one long beep, you can record the selected OGM. You will hear the message played once. You can stop recording the message by pressing 9 .
2 F/T OGM			
95	Change the Fax Forwarding, Paging or Fax Storage settings		
	1 OFF	You can choose <i>OFF</i> after you have retrieved or erased all your messages.	
	2 Fax Forwarding	If you hear one long beep, the change has been accepted. If you hear three short beeps, you cannot change it because something has not been set up (for example, registering a Fax Forwarding number). You can register your Fax Forwarding number by entering 4. (See <i>Changing your Fax Forwarding number</i> on page 62.)	
	3 Paging		
	4 Fax Forwarding number		
	6 Fax Storage		
96	Retrieve a fax		
	2 Retrieve all faxes	Enter the number of a remote fax machine to receive stored fax messages. (See <i>Retrieving fax messages</i> on page 62.)	
	3 Erase faxes from the memory	If you hear one long beep, fax messages have been erased from the memory.	
97	Check the receiving status (MFC-3360C and FAX-1860C)		
	1 Fax	You can check whether your machine has received any faxes. If yes, you will hear one long beep. If no, you will hear three short beeps.	

Remote commands		Operation details
97	Check the receiving status (FAX-1960C only)	
	1 Fax	You can check whether your machine has received any fax or voice messages. If yes, you will hear one long beep. If no, you will hear three short beeps.
	2 Voice	
98	Change the Receive Mode (MFC-3360C and FAX-1860C)	
	1 External TAD	If you hear one long beep, your change has been accepted.
	2 Fax/Tel	
	3 Fax Only	
98	Change the Receive Mode (FAX-1960C)	
	1 Msg Ctr	If you hear one long beep, your change has been accepted.
	2 Fax/Tel	
	3 Fax Only	
90	Exit	Pressing 9 0 will allow you to exit Remote Retrieval. Wait for the long beep, then replace the handset.

Fax reports

You need to set up the Transmission Verification Report and Journal Period using the **Menu** keys.

Transmission Verification Report

You can use the Transmission Verification Report as proof that you sent a fax. This report lists the time and date of transmission and whether the transmission was successful (OK). If you choose *On* or *On+Image*, the report will print for every fax you send.

If you send a lot of faxes to the same place, you may need more than the job numbers to know which faxes you must send again. Choosing *On+Image* or *Off+Image* will print a section of the fax's first page on the report to help you remember.

When the Transmission Verification Report is turned *Off* or *Off+Image*, the Report will only print if there is a transmission error, with NG in the RESULT column.

- 1 Press **Menu, 2, 4, 1**.
- 2 Press **▲** or **▼** to choose *Off+Image*, *On*, *On+Image* or *Off*. Press **OK**.
- 3 Press **Stop/Exit**.

Fax Journal (activity report)

You can set the machine to print a journal at specific intervals (every 50 faxes, 6, 12 or 24 hours, 2 or 7 days). If you set the interval to *Off*, you can still print the report by following the steps in *How to print a report* on page 66. The default setting is *Every 50 Faxes*.

- 1 Press **Menu, 2, 4, 2**.
- 2 Press **▲** or **▼** to choose an interval. Press **OK**.
(If you choose 7 days, the LCD will ask you to choose the first day for the 7-day countdown.)
 - 6, 12, 24 hours, 2 or 7 days
The machine will print the report at the chosen time and then erase all jobs from its memory. If the machine's memory becomes full with 200 jobs before the time you chose has passed, the machine will print the Journal early and then erase all jobs from the memory. If you want an extra report before it is due to print, you can print it without erasing the jobs from the memory.
 - Every 50 Faxes
The machine will print the Journal when the machine has stored 50 jobs.
- 3 Enter the time to start printing in 24-hour format. Press **OK**.
(For example: enter 19:45 for 7:45 PM.)
- 4 Press **Stop/Exit**.

Reports

The following reports are available:

1. **Transmission**
Prints a Transmission Verification Report for your last transmission.
2. **Help List**
A help list about how to quickly program your machine.
3. **Quick-Dial**
Lists names and numbers stored in the One-Touch and Speed-Dial memory, in numerical order.
4. **Fax Journal**
Lists information about the last incoming and outgoing faxes. (TX: Transmit.) (RX: Receive.)
5. **User Settings**
Lists your settings.

How to print a report

- 1 Press **Menu**, **4**.
- 2 Do one of the following:
 - Press **▲** or **▼** to choose the report you want.
Press **OK**.
 - Enter the number of the report you want to print. For example, press **2** to print the Help List.
- 3 Press **Black Start**.



12 Polling

Polling lets you set up your machine so other people can receive faxes from you, but they pay for the call. It also lets you call somebody else's fax machine and receive a fax from it, so you pay for the call. The polling feature needs to be set up on both machines for this to work. Not all fax machines support polling.

Polling receive

Polling receive lets you call another fax machine to receive a fax.

Setup for polling receive

- 1 Make sure you are in Fax mode .
- 2 Press **Menu, 2, 1, 6**.

- 3 Enter the fax number you are polling.
- 4 Press **Black Start** or **Color Start**.
The LCD shows *Dialing*.

Sequential polling

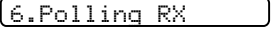
The machine can request documents from several fax machines in one operation. Afterwards, a Sequential Polling Report will be printed.

- 1 Make sure you are in Fax mode .
- 2 Press **Menu, 2, 1, 6**.

- 3 Specify the fax machines you want to poll by using One-Touch, Speed-Dial, Search, a Group or the dial pad. You must press **OK** between each location.
- 4 Press **Black Start** or **Color Start**.
The machine polls each number or Group number in turn for a document.

Press **Stop/Exit** while the machine is dialing to cancel the polling process.

To cancel all sequential polling receive jobs, see *Checking and canceling waiting jobs* on page 32.

Polled transmit (Black & White only)

Polled Transmit is when you set up your machine to wait with a document so another fax machine can call and retrieve it.

Setup for polled transmit

- 1 Make sure you are in Fax mode .
- 2 Load your document.
- 3 Press **Menu, 2, 2, 6**.
- 4 Press **▲** or **▼** to choose On (or Off).
Press **OK**.
- 5 Do one of the following:
 - Press **1** to leave a paper document waiting in the ADF.
 If you want to use the ADF before the paper document is polled, you must cancel the job.
 - Press **2** to scan the document into the memory.
- 6 The LCD shows:
- 7 Press **2** and press **Black Start**.



Note

If the document will be stored in the memory it can be retrieved by any other fax machine until you delete it from the memory. (See *Checking and canceling waiting jobs* on page 32.)



Copy

Making copies

70

13

Making copies

How to copy

Entering Copy mode

Press  (**Copy**) to enter Copy mode. The default setting is Fax. You can change the number of seconds or minutes that the machine stays in Copy mode. (See *Mode Timer* on page 19.)

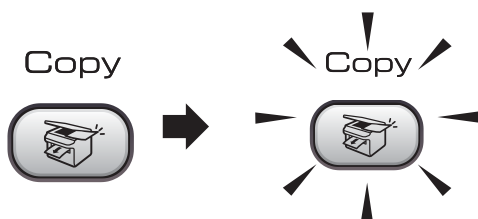

The LCD shows the default copy setting:

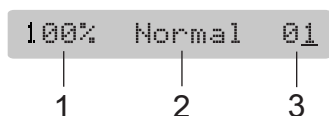

- 1 **Copy Ratio**
- 2 **Quality**
- 3 **No of Copies**

Making a single copy

- 1 Make sure you are in Copy mode .
- 2 Load your document.
- 3 Press **Black Start** or **Color Start**.

Making multiple copies

- 1 Make sure you are in Copy mode .
- 2 Load your document.
- 3 Use the dial pad to enter the number of copies (up to 99).
- 4 Press **Black Start** or **Color Start**.



Note

To sort your copies, press **Options** or **Copy Options**. (See *Sorting copies using the ADF (Black & White only)* on page 74.)

Stop copying

To stop copying, press **Stop/Exit**.

Copy keys

When you want to quickly change the copy settings *temporarily* for the next copy, use the Copy keys.

Options	Quality	MFC-3360C
Copy Options		FAX-1860C and FAX-1960C

The machine returns to its default settings after it finishes copying, or if the mode timer returns the machine to Fax mode. For more information see *Mode Timer* on page 19.

Changing copy quality

You can choose from a range of quality settings. The default setting is **Normal**.

To temporarily change the quality setting, follow the instructions below:

Normal	Normal is the recommended mode for ordinary printouts. This produces good copy quality with good copy speed.
Fast	Fast copy speed and lowest ink consumption. Use to save time printing documents to be proof-read, large documents, or many copies.
Best	Use best mode to copy precise images such as photographs. This provides the highest resolution and the slowest speed.

- 1 Make sure you are in Copy mode .
- 2 Load your document.
- 3 Use the dial pad to enter the number of copies (up to 99).
- 4 Do one of the following:
 - (MFC-3360C)
Press **Quality**.
 - (FAX-1860C and FAX-1960C)
Press **Copy Options** and **▲** or **▼** to choose **Quality**.
Press **OK**.
- 5 Press **▲** or **▼** to choose **Normal**, **Fast** or **Best**.
Press **OK**.
- 6 Press **Black Start** or **Color Start**.



To change the default setting, follow the instructions below:

- 1 Press **Menu**, **3**, **1**.
- 2 Press **▲** or **▼** to choose **Normal**, **Fast** or **Best**.
Press **OK**.
- 3 Press **Stop/Exit**.

Enlarging or reducing the image copied

You can select the following enlargement or reduction ratios:

Custom (25-400%) allows you to enter a ratio from 25% to 400%.

Press Options  or Copy Options  and ▲ or ▼ to choose Enlarge/Reduce	Custom (25-400%)
	200%
	198% 4"x6"→A4
	186% 4"x6"→LTR
	142% A5→A4
	104% EXE→LTR
	100%
	97% LTR→A4
	93% A4→LTR
	83% LGL→A4
	78% LGL→LTR
69% A4→A5	
50%	

To enlarge or reduce the next copy follow the instructions below:

- 1 Make sure you are in Copy mode .
- 2 Load your document.
- 3 Use the dial pad to enter the number of copies (up to 99).
- 4 Press **Options** or **Copy Options** and **▲** or **▼** to choose **Enlarge/Reduce**.
Press **OK**.

- 5 Do one of the following:
- Use ▲ or ▼ to choose the enlargement or reduction ratio you want.
Press **OK**.
 - Use ▲ or ▼ to choose Custom(25–400%). Press **OK**. Use the dial pad to enter an enlargement or reduction ratio from 25% to 400%. (For example, press **5 3** to enter 53%.)
Press **OK**.

- 6 Press **Black Start** or **Color Start**.





Note

Page Layout Options 2 in 1(P), 2 in 1(L), 4 in 1(P) or 4 in 1(L) are *not* available with Enlarge/Reduce.

Copy options

When you want to quickly change the copy settings *temporarily* for the next copy, use the **Options** or **Copy Options** key.

Press	Menu selection/	Options	Page
Press Options 	Paper Type	Plain Paper	75
		Inkjet Paper	
or Copy Options 	Paper Size	Brother Photo	
		Other Photo	
		Transparency	
	Brightness	Letter	76
		Legal	
		A4	
		A5	
		4" (W) x 6" (H)	
		- <input type="checkbox"/> <input type="checkbox"/> <input checked="" type="checkbox"/> <input type="checkbox"/> <input type="checkbox"/> +	74
	Stack/Sort	Stack	74
		Sort	
	Page Layout	Off(1 in 1)	73
		2 in 1 (P)	
		2 in 1 (L)	
		4 in 1 (P)	
		4 in 1 (L)	
	No. of Copies	No. of Copies:01 (01-99)	



Note

You can save the copy settings you use most often by setting them as default. You can find instructions on how to do this in the section for each feature.

Making N in 1 copies

The N in 1 copy feature can help you save paper by letting you copy two or four pages onto one printed page.

Important

- Please make sure paper size is set to Letter or A4.
- You cannot use the Enlarge/Reduce setting with the N in 1.
- N in 1 color copies are not available.
- (P) means Portrait and (L) means Landscape.

- 1 Make sure you are in Copy mode .
- 2 Load your document.
- 3 Use the dial pad to enter the number of copies (up to 99).
- 4 Press **Options** or **Copy Options** and ▲ or ▼ to select Page Layout. Press **OK**.
- 5 Press ▲ or ▼ to select Off (1 in 1), 2 in 1 (P), 2 in 1 (L), 4 in 1 (P), or 4 in 1 (L). Press **OK**.
- 6 Press **Black Start** to scan the document.



Note

If photo paper is selected as the paper type setting for N in 1 copies, the images will be printed as if plain paper had been selected.

Place your document face down in the direction shown below:

■ 2 in 1 (P)



■ 2 in 1 (L)



■ 4 in 1 (P)

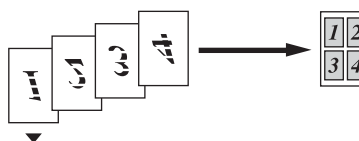

■ 4 in 1 (L)

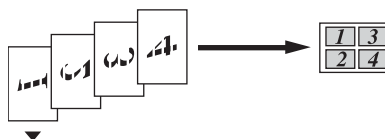

Sorting copies using the ADF (Black & White only)



You can sort multiple copies. Pages will be stacked in the order 1 2 3, 1 2 3, 1 2 3, and so on.

- 1 Make sure you are in Copy mode .
- 2 Load your document.
- 3 Use the dial pad to enter the number of copies (up to 99).
- 4 Press **Options** or **Copy Options** and ▲ or ▼ to select *Stack/Sort*. Press **OK**.
- 5 Press ▲ or ▼ to select *Sort*. Press **OK**.
- 6 Press **Black Start**.

Adjusting Brightness, Contrast and Color

Brightness

To temporarily change the brightness setting, follow the instructions below:

- 1 Make sure you are in Copy mode .
 - 2 Load your document.
 - 3 Use the dial pad to enter the number of copies (up to 99).
 - 4 Press **Options** or **Copy Options** and ▲ or ▼ to select *Brightness*. Press **OK**.
- □ □ ■ □ □ + 
- 5 Press ▲ or ▼ to make the copy lighter or darker. Press **OK**.
 - 6 Press **Black Start** or **Color Start**.

To change the default setting follow the instructions below:

- 1 Press **Menu**, **3**, **2**.
- 2 Press ▲ or ▼ to make the copy lighter or darker. Press **OK**.
- 3 Press **Stop/Exit**.

Contrast

Adjust the contrast to help an image look sharper and more vivid.

To change the default setting follow the instructions below:

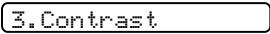
- 1 Press **Menu**, **3**, **3**.

- 2 Press **▲** or **▼** to change the contrast.
Press **OK**.
- 3 Press **Stop/Exit**.

Color saturation

The color saturation can only be changed through the default setting.

- 1 Press **Menu**, **3**, **4**.

- 2 Press **▲** or **▼** to select 1.Red, 2.Green or 3.Blue.
Press **OK**.
- 3 Press **▲** or **▼** to change the color saturation.
Press **OK**.
- 4 Do one of the following:
 - Return to 2 to select the next color.
 - Press **Stop/Exit**.

Paper options

Paper type

If you are copying on special paper, be sure to select the type of paper you are using so you will get the best print quality.

- 1 Make sure you are in Copy mode .
- 2 Load your document.
- 3 Use the dial pad to enter the number of copies (up to 99).
- 4 Press **Options** or **Copy Options** and **▲** or **▼** to select **Paper Type**.
Press **OK**.
- 5 Press **▲** or **▼** to select the type of paper you are using (Plain Paper, Inkjet Paper, Brother Photo, Other Photo or Transparency).
Press **OK**.
- 6 Press **Black Start** or **Color Start**.



Note

To change the default paper type setting see *Paper Type* on page 19.

Paper size

If copying on paper other than Letter or A4 size, you will need to change the paper size setting. You can copy on Letter, Legal, A4, A5 or Photo 4"(W) × 6"(H) paper.

- 1 Make sure you are in Copy mode .
- 2 Load your document.
- 3 Use the dial pad to enter the number of copies (up to 99).
- 4 Press **Options** or **Copy Options** and ▲ or ▼ to select **Paper Size**. Press **OK**.
- 5 Press ▲ or ▼ to select the size of paper you are using Letter, Legal, A4, A5 or 4" (W) × 6" (H). Press **OK**.
- 6 Press **Black Start** or **Color Start**.



Note

To change the default paper type setting see *Paper Size* on page 20.



Software

Software features (MFC-3360C only)

78

14

Software features (MFC-3360C only)

The CD-ROM includes the Software User's Guide for features available when connected to a computer (for example, printing and scanning). The guide has easy to use links that, when clicked, will take you directly to a particular section.

You can find information on these features:

- Printing
- Scanning
- ControlCenter3 (for Windows®)
- ControlCenter2 (for Macintosh®)
- Remote Setup
- Faxing from your computer

How to read the HTML User's Guide

This is a quick reference for using the HTML User's Guide.

(For Windows®)



Note

If you have not installed the software, see *Viewing Documentation* on page 2.

- 1 From the **Start** menu, point to **Brother**, **MFC-3360C** from the programs group, then click **User's Guide**.
- 2 Click **SOFTWARE USER'S GUIDE** from the top menu.

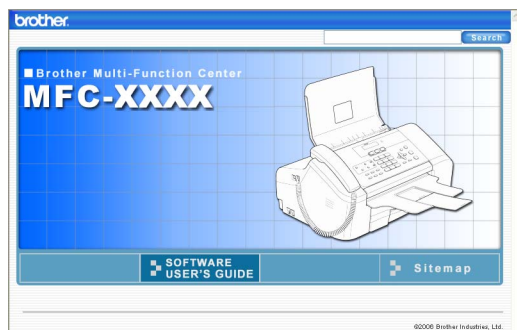

- 3 Click the heading you would like to read from the list at the left of the window.



(For Macintosh®)

- 1 Make sure your Macintosh® is turned on. Insert the Brother CD-ROM into your CD-ROM drive.
- 2 Double-click your **Documentation** icon.
- 3 Double-click your language folder and then double-click the top page of the HTML file.
- 4 Click **SOFTWARE USER'S GUIDE** in the top menu, and then click the heading you would like to read from the list at the left of the window.

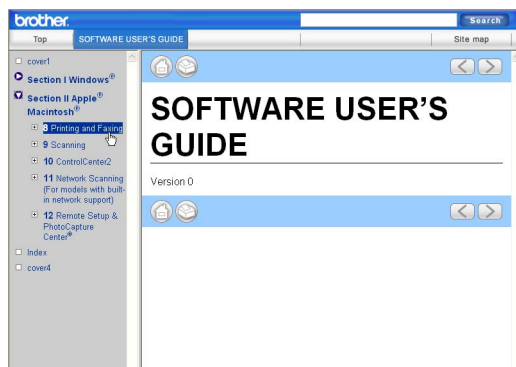



Appendixes

Safety and Legal	80
Troubleshooting and Routine Maintenance	90
Menu and Features	111
Specifications	121
Glossary	130

A

Safety and Legal

Choosing a location

Put your machine on a flat, stable surface that is free of vibration and shocks, such as a desk. Put the machine near a telephone wall jack and a standard AC power outlet. Choose a location where the temperature remains between 50° F and 95° F (10° and 35° C).

! CAUTION

- Avoid placing your machine in a high-traffic area.
- Avoid placing your machine on a carpet.
- DO NOT put the machine near heaters, air conditioners, refrigerators, medical equipment, chemicals or water.
- DO NOT expose the machine to direct sunlight, excessive heat, moisture, or dust.
- DO NOT connect your machine to electrical outlets controlled by wall switches or automatic timers.
- Disruption of power can wipe out information in the machine's memory.
- DO NOT connect your machine to electrical outlets on the same circuit as large appliances or other equipment that might disrupt the power supply.
- Avoid interference sources, such as speakers or the base units of non-Brother cordless phones.
- DO NOT place the FAX-1960C and the cordless handset near electro-medical equipment.

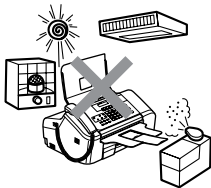

To use the machine safely

Please keep these instructions for later reference and read them before attempting any maintenance.



Note

(FAX-1960C only)

If there are faxes in the machine's memory you need to print them or save them before unplugging the machine from the AC power outlet for more than 24 hours. (To print the faxes in memory, see *Transferring faxes to another fax machine* on page 98.)



WARNING



There are high voltage electrodes inside the machine. Before you clean the inside of the machine, make sure you have unplugged the telephone line cord first and then the power cord from the AC power outlet. Doing this will prevent an electrical shock.

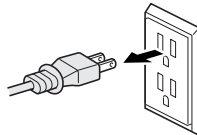

DO NOT handle the plug with wet hands. Doing this may cause an electrical shock.

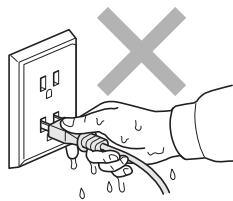

Always make sure the plug is fully inserted.



DO NOT pull in the middle of the AC power cord. Doing this might cause an electrical shock.



DO NOT put your hands on the edge of the machine under the panel cover or touch the document feed rollers. Doing this may cause injury.

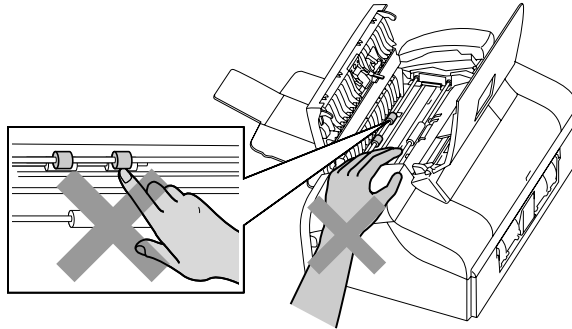

DO NOT put your hands on the edge of the paper tray under the output paper tray cover. Doing this may cause injury.

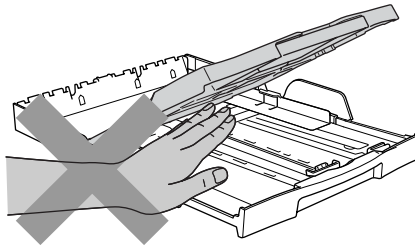

DO NOT touch the paper feed roller. Doing this may cause injury.

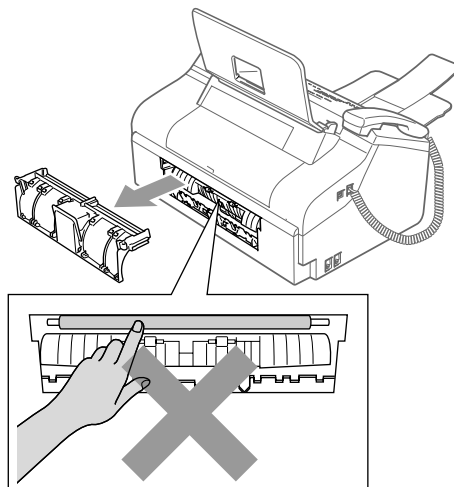



DO NOT touch the area shaded in the illustration. Doing this may cause injury.

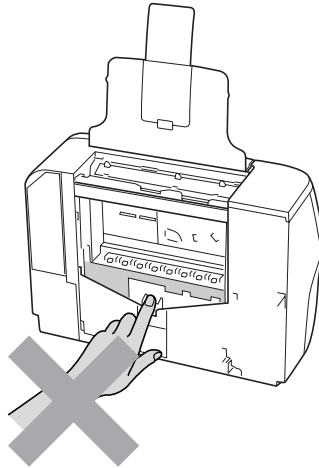

When moving the machine you must lift it from the base, by placing a hand at each side of the unit as shown in the illustration.

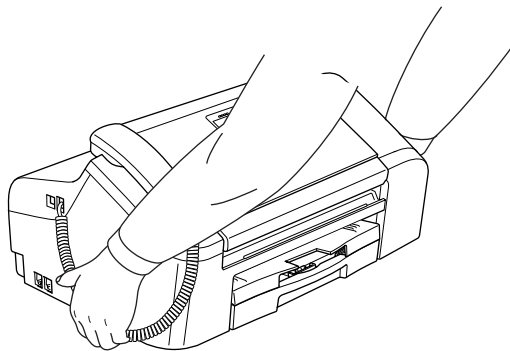

If the machine becomes hot, releases smoke or generates any strong smells, immediately unplug the machine from the AC power outlet. Call Brother Customer Service. (See *Brother numbers* on page i.)

If metal objects, water or other liquids get inside the machine, immediately unplug the machine from the AC power outlet. Call Brother Customer Service. (See *Brother numbers* on page i.)

WARNING

- Use caution when installing or modifying telephone lines. Never touch telephone wires or terminals that are not insulated unless the telephone line has been unplugged at the wall jack. Never install telephone wiring during a lightning storm. Never install a telephone wall jack in a wet location.
- This product must be installed near an AC power outlet that is easily accessible. In case of an emergency, you must unplug the power cord from the AC power outlet to shut off the power completely.
- Always make sure the plug is fully inserted.
- To reduce the risk of shock or fire, use only a No. 26 AWG or larger telecommunication line cord.

CAUTION

Lightning and power surges can damage this product! We recommend that you use a quality surge protection device on the AC power line and on the telephone line, or unplug the cords during a lightning storm.

WARNING

IMPORTANT SAFETY INSTRUCTIONS

When using your telephone equipment, basic safety precautions should always be followed to reduce the risk of fire, electric shock and injury to people, including the following:

- 1 DO NOT use this product near water, for example, near a bath tub, wash bowl, kitchen sink or washing machine, in a wet basement or near a swimming pool.
- 2 Avoid using this product during an electrical storm. There may be a remote risk of electric shock from lightning.
- 3 DO NOT use this product to report a gas leak in the vicinity of the leak.
- 4 Use only the power cord provided with the machine.

Important safety instructions

- 1 Read all of these instructions.
- 2 Save them for later reference.
- 3 Follow all warnings and instructions marked on the product.
- 4 Unplug this product from the wall outlet before cleaning the inside of the machine. Do not use liquid or aerosol cleaners. Use a damp cloth for cleaning.

- 5 Do not use this product near water.
- 6 Do not place this product on an unstable cart, stand, or table. The product may fall, causing serious damage to the product.
- 7 Slots and openings in the cabinet and the back or bottom are provided for ventilation. To ensure reliable operation of the product and to protect it from overheating, these openings must not be blocked or covered. The openings should never be blocked by placing the product on a bed, sofa, rug, or other similar surface. This product should never be placed near or over a radiator or heater. This product should never be placed in a built-in installation unless proper ventilation is provided.
- 8 This product should be operated from the type of power source indicated on the label. If you are not sure of the type of power available, call your dealer or local power company.
- 9 Use only the power cord supplied with this machine.
- 10 Do not allow anything to rest on the power cord. Do not place this product where people can walk on the cord.
- 11 If an extension cord is used with this product, make sure that the total ampere ratings of the products plugged into the extension cord do not exceed the extension cord ampere rating. Also, make sure that the total of all products plugged into the AC power outlet does not exceed 15 amperes (USA only).
- 12 Do not place anything in front of the machine that will block received faxes. Do not place anything in the path of received faxes.
- 13 Wait until pages have exited the machine before picking them up.
- 14 Never push objects of any kind into this product through cabinet slots, since they may touch dangerous voltage points or short out parts resulting in the risk of fire or electric shock. Never spill liquid of any kind on the product. Do not attempt to service this product yourself because opening or removing covers may expose you to dangerous voltage points and other risks and may void your warranty. Refer all servicing to a Brother Authorized Service Center. For the location of your nearest Brother Authorized Service Center, please call the following:
In USA: 1-800-284-4357
In Canada: 1-877-BROTHER
- 15 Unplug this product from the AC power outlet and refer all servicing to Brother Authorized Service Personnel under the following conditions:
 - When the power cord is damaged or frayed.
 - If liquid has been spilled into the product.
 - If the product has been exposed to rain or water.
 - If the product does not operate normally when the operating instructions are followed, adjust only those controls that are covered by the operating instructions. Improper adjustment of other controls may result in damage and will often require extensive work by a qualified technician to restore the product to normal operation.
 - If the product has been dropped or the cabinet has been damaged.
 - If the product exhibits a distinct change in performance, indicating a need for service.
- 16 To protect your product against power surges, we recommend the use of a power protection device (Surge Protector).

17 To reduce the risk of fire, electric shock and injury to people, note the following:

- Do not use this product near appliances that use water, a swimming pool, or in a wet basement.
- Do not use the machine during an electrical storm (there is the remote possibility of an electrical shock) or to report a gas leak in the vicinity of the leak.

18 Caution - To reduce the risk of fire, use only No.26 AWG or larger telecommunication line cord.

Standard telephone and FCC Notices (These notices are in effect on models sold and used in the United States only)

This equipment is hearing-aid compatible.

When programming emergency numbers or making test calls to emergency numbers:

- Remain on the line and briefly explain to the dispatcher the reason for the call before hanging up.
- Perform these activities in the off-peak hours, such as early morning or late evening.

This equipment complies with Part 68 of the FCC rules and the requirements adopted by the ACTA. On the backside of this equipment is a label that contains, among other information, a product identifier in the format US: AAAEQ##TXXXX. If requested, this number must be provided to the telephone company.

You may safely connect this equipment to the telephone line by means of a standard modular jack, USOC RJ11C.

A plug and jack used to connect this equipment to the premises wiring and telephone network must comply with the applicable FCC Part 68 rules and requirements adopted by the ACTA. A compliant telephone cord and modular plug is provided with this product. It is designed to be connected to a compatible modular jack that is also compliant. See installation instructions for details.

The REN is used to determine the number of devices that may be connected to a telephone line. Excessive RENs on a telephone line may result in the devices not ringing in response to an incoming call. In most but not all areas, the sum of RENs should not exceed five (5.0). To be certain of the number of devices that may be connected to a line, as determined by the total RENs, contact the local telephone company. For products approved after July 23, 2001, the REN for this product is part of the product identifier that has the format US:AAAEQ##TXXXX. The digits represented by ## are the REN without a decimal point (e.g., 06 is a REN of 0.6). For earlier products, the REN is separately shown on the label.

If this equipment causes harm to the telephone network, the telephone company will notify you in advance that temporary discontinuance of service may be required. But if advance notice isn't practical, the telephone company will notify the customer as soon as possible. Also, you will be advised of your right to file a complaint with the FCC if you believe it is necessary.

The telephone company may make changes in its facilities, equipment, operations or procedures that could affect the operation of the equipment. If this happens the telephone company will provide advance notice in order for you to make necessary modifications to maintain uninterrupted service.

If trouble is experienced with this equipment, for repair or warranty information, please contact Brother Customer Service. (See *Brother numbers* on page i.) If the equipment is causing harm to the telephone network, the telephone company may request that you disconnect the equipment until the problem is resolved.

Connection to party line service is subject to state tariffs. Contact the state public utility commission, public service commission or corporation commission for information.

If your home has specially wired alarm equipment connected to the telephone line, ensure the installation of this equipment does not disable your alarm equipment. If you have questions about what will disable alarm equipment, call your telephone company or a qualified installer.

If you are not able to solve a problem with your machine, call Brother Customer Service. (See *Brother numbers* on page i.)



WARNING

For protection against the risk of electrical shock, always disconnect all cables from the wall outlet before servicing, modifying or installing the equipment.

This equipment may not be used on coin service lines provided by the telephone company or connected to party lines.

Brother cannot accept any financial or other responsibilities that may be the result of your use of this information, including direct, special or consequential damages. There are no warranties extended or granted by this document.

This machine has been certified to comply with FCC standards, which are applied to the USA only.

Federal Communications Commission (FCC) Declaration of Conformity (USA only)

Responsible Party: Brother International Corporation
 100 Somerset Corporate Boulevard
 Bridgewater, NJ 08807-0911 USA
 TEL: (908) 704-1700

declares, that the products

Product Name: MFC-3360C, FAX-1860C and FAX-1960C

comply with Part 15 of the FCC Rules. Operation is subject to the following two conditions: (1) This device may not cause harmful interference, and (2) this device must accept any interference received, including interference that may cause undesired operation.

This equipment has been tested and found to comply with the limits for a Class B digital device, pursuant to Part 15 of the FCC Rules. These limits are designed to provide reasonable protection against harmful interference in a residential installation. This equipment generates, uses, and can radiate radio frequency energy and, if not installed and used in accordance with the instructions, may cause harmful interference to radio communications. However, there is no guarantee that interference will not occur in a particular installation. If this equipment does cause harmful interference to radio or television reception, which can be determined by turning the equipment off and on, the user is encouraged to try to correct the interference by one or more of the following measures:

- Reorient or relocate the receiving antenna.
- Increase the separation between the equipment and receiver.
- Connect the equipment into an outlet on a circuit different from that to which the receiver is connected.
- Call the dealer or an experienced radio/TV technician for help.
- This transmitter must not be co-located or operated in conjunction with any other antenna or transmitter.
- This equipment complies with FCC radiation exposure limits set forth for uncontrolled equipment and meets the FCC radio frequency (RF) Exposure Guidelines in Supplement C to OET65. This equipment should be installed and operated with at least 20cm and more between the radiator and person's body (excluding extremities: hands, wrists, feet and legs).

IMPORTANT

Changes or modifications not expressly approved by Brother Industries, Ltd. could void the user's authority to operate the equipment.

Industry Canada Compliance Statement (Canada only)

This Class B digital apparatus complies with Canadian ICES-003.

Cet appareil numérique de la classe B est conforme à la norme NMB-003 du Canada.

Legal limitations for copying

Color reproductions of certain documents are illegal and may result in either criminal or civil liability. This memorandum is intended to be a guide rather than a complete listing of every possible prohibition. In case of doubt, we suggest that you check with counsel as to any particular questionable documents.

The following documents issued by the United States/Canadian Government or any of its Agencies may not be copied:

- Money
- Bonds or other certificates of indebtedness
- Certificates of Deposit
- Internal Revenue Stamps (canceled or uncanceled)
- Selective Service or draft papers
- Passports
- United States/Canadian Postage Stamps (canceled or uncanceled)
- Food Stamps
- Immigration Papers
- Checks or drafts drawn by Governmental agencies
- Identifying badges or insignias

Copyrighted works cannot be copied. Sections of a copyrighted work can be copied for 'fair use.' Multiple copies would indicate improper use.

Works of art should be considered the equivalent of copyrighted works.

Licenses and Certificates of Title to motor vehicles may not be copied under certain state/provincial laws.

Trademarks

The Brother logo is a registered trademark of Brother Industries, Ltd.

Brother is a registered trademark of Brother Industries, Ltd.

Multi-Function Link is a registered trademark of Brother International Corporation.

© 2006 Brother Industries, Ltd. All rights reserved.

Windows and Microsoft are registered trademarks of Microsoft in the U.S. and other countries.

Macintosh and TrueType are registered trademarks of Apple Computer, Inc.

PaperPort is a registered trademark of ScanSoft, Inc.

Presto! PageManager is a registered trademark of NewSoft Technology Corporation.

Each company whose software title is mentioned in this manual has a Software License Agreement specific to its proprietary programs.

All other brand and product names mentioned in this User's Guide, the Software User's Guide and the Digital Cordless Handset User's Guide are registered trademarks of their respective companies.

B

Troubleshooting and Routine Maintenance

Troubleshooting

IMPORTANT

For technical help, you must call the country where you bought the machine. Calls must be made **from within** that country.

If you think there is a problem with your machine, check the chart below and follow the troubleshooting tips.

You can solve most problems by yourself. If you need additional help, the Brother Solutions Center offers the latest FAQs and troubleshooting tips. Visit us at <http://solutions.brother.com>.

If you are having difficulty with your machine

Printing

Difficulty	Suggestions
No printout	Check the interface cable on both the machine and your computer. (See the <i>Quick Setup Guide</i> .)
	Check that the machine is plugged in and that the On/Off key is on.
	One or more ink cartridges are empty. (See <i>Replacing the ink cartridges</i> on page 102.)
	Check to see if the LCD is showing an error message. (See <i>Error messages</i> on page 95.)
	Check that the correct printer driver has been installed and chosen.
	Make sure the machine is online. Click Start and then Printers and Faxes . Right-click and choose 'Brother MFC-XXXX ' (where XXXX is your model name), and make sure that 'Use Printer Offline' is unchecked.
Poor printing quality	Check the print quality. (See <i>Checking the print quality</i> on page 107.)
	Make sure the Printer Driver or Paper Type setting in the menu matches the type of paper you are using. (See <i>Printing for Windows®</i> or <i>Printing and Faxing for Macintosh®</i> in the Software User's Guide on the CD-ROM and <i>Paper Type</i> on page 19.)
	Make sure that your ink cartridges are fresh. The following may cause ink to clog: <ul style="list-style-type: none"> ■ The expiration date written on the cartridge package has passed. (Cartridges stay usable for up to two years if kept in their original packaging.) ■ The ink cartridge was in your machine over six months. ■ The ink cartridge may not have been stored properly before use.
	Try using the recommended types of paper. (See <i>Acceptable paper and other media</i> on page 9.)
	The recommended environment for your machine is between 68° F to 91° F (20° C to 33° C).

Printing (Continued)

Difficulty	Suggestions
White horizontal lines appear in text or graphics.	Clean the print head. (See <i>Cleaning the print head</i> on page 106.)
	Try using the recommended types of paper. (See <i>Acceptable paper and other media</i> on page 9.)
The machine prints blank pages.	Clean the print head. (See <i>Cleaning the print head</i> on page 106.)
Characters and lines are stacked.	Check the printing alignment. (See <i>Checking the print alignment</i> on page 108.)
Printed text or images are skewed.	Make sure the paper is loaded properly in the paper tray and the paper side guide is adjusted correctly. (See <i>Loading paper and other media</i> on page 13.)
	Make sure the Lower Jam Clear Cover is set properly.
Smudged stain at the top center of the printed page.	Make sure the paper is not too thick or curled. (See <i>Acceptable paper and other media</i> on page 9.)
Printing appears dirty or ink seems to run.	Make sure you are using the proper types of paper. (See <i>Acceptable paper and other media</i> on page 9.) Don't handle the paper until the ink is dry.
Stains appear on the reverse side or at the bottom of the page.	Make sure the printer platen is not dirty with ink. (See <i>Cleaning the machine printer platen</i> on page 105.)
	Make sure you are using the paper support flap. (See <i>Loading paper and other media</i> on page 13.)
There are some dense lines.	Check Reverse Order in the Basic tab of the printer driver.
The printouts are wrinkled.	In the printer driver Basic tab, click the Settings , and uncheck the Bi-Directional Printing .
Cannot perform '2 in 1 or 4 in 1' printing.	Check that the paper size setting in the application and in the printer driver are the same.
Print speed is too slow.	Try changing the printer driver setting. The highest resolution needs longer data processing, sending and printing time. Try the other quality settings in the printer driver Basic tab. Also, click the Settings tab, and make sure you uncheck Color Enhancement (True2Life®) .
	Turn the borderless feature off. Borderless printing is slower than normal printing. (See <i>Printing for Windows® or Printing and Faxing for Macintosh® in the Software User's Guide on the CD-ROM.</i>)
Machine feeds multiple pages	Make sure the paper is loaded properly in the paper tray. (See <i>Loading paper and other media</i> on page 13.)
	Check that more than two types of paper are not loaded in the paper tray at any one time.
Printed pages are not stacked neatly.	Make sure you are using the paper support flap. (See <i>Loading paper and other media</i> on page 13.)
Printed pages double-feed and cause a paper jam.	Close the output paper tray cover and slide it forward, then push the paper tray firmly back into the machine. While holding the paper tray in place, pull out the paper support until it clicks and unfold the paper support flap. (See <i>the illustrations in Loading paper and other media</i> on page 14.)
Machine does not print from Paint Brush.	Try setting the Display setting to '256 colors.'
Machine does not print from Adobe Illustrator.	Try to reduce the print resolution. (See <i>Printing for Windows® or Printing and Faxing for Macintosh® in the Software User's Guide on the CD-ROM.</i>)
The machine cannot print full pages of a document. Out of Memory message occurs.	Reduce the printing resolution. (See <i>Printing for Windows® or Printing and Faxing for Macintosh® in the Software User's Guide on the CD-ROM.</i>)
	Reduce the complexity of your document and try again. Reduce the graphic quality or the number of font sizes within your application software.

Printing Received Faxes

Difficulty	Suggestions
Condensed print and white streaks across the page or the top and bottom of sentences are cut off.	You probably had a bad connection, with static or interference on the telephone line. Ask the other party to send the fax again.
Vertical black lines when receiving.	The sender's scanner may be dirty. Ask the sender to make a copy to see if the problem is with the sending machine. Try receiving from another fax machine.
Received color fax prints only in black and white.	Replace the color ink cartridges that are empty or nearly empty, and then ask the other person to send the color fax again. (See <i>Replacing the ink cartridges</i> on page 102.)
Left and Right margins are cut off or a single page is printed on two pages.	Turn on Auto Reduction. (See <i>Printing a reduced incoming fax</i> on page 38.)

Phone Line or Connections

Difficulty	Suggestions
Dialing does not work. (No dial tone)	Check that the machine is plugged in and switched on.
	Check all line cord connections.
	(Canada only) Change Tone/Pulse setting. (See <i>Quick Setup Guide</i> .)
	Send a fax manually and wait to hear fax receiving tone before pressing Black Start or Color Start . (See <i>Sending a fax manually</i> on page 33.)
The machine does not answer when called.	Make sure the machine is in the correct receiving mode for your setup. (See <i>Receive modes</i> on page 34.) Check for a dial tone. If possible, call your machine to hear it answer. If there is still no answer, check the telephone line cord connection. If there is no ringing when you call your machine, ask your telephone company to check the line.

Receiving Faxes

Difficulty	Suggestions
Cannot receive a fax	Check all line cord connections.
	Make sure the machine is in the correct receiving mode for your setup. (See <i>Receive modes</i> on page 34.)
	If you often have interference on the phone line, try changing the menu setting of Compatibility to <i>Basic</i> or <i>Normal</i> . (See <i>Phone line interference</i> on page 101.)

Sending Faxes

Difficulty	Suggestions
Cannot send a fax	Check all line cord connections.
	Make sure that the Fax  key is illuminated. (See <i>Entering Fax mode</i> on page 28.)
	Ask the other party to check that the receiving machine has paper.
	Print the Transmission Verification Report and check for an error. (See <i>Reports</i> on page 66.)
	Make sure the panel cover is completely closed.
Transmission Verification Report says 'Result:NG' or 'Result:ERROR'.	There is probably temporary noise or static on the line. Try sending the fax again. If you send a PC FAX message and get 'Result:NG' on the Transmission Verification Report, your machine may be out of memory. If the problem continues, ask the telephone company to check your phone line.
	If you often get transmission errors due to possible interference on the phone line, try changing the menu setting of Compatibility to <i>Basic</i> . (See <i>Phone line interference</i> on page 101.)
Poor fax send quality.	Try changing your resolution to <i>Fine</i> or <i>S.Fine</i> . Make a copy to check your machine's scanner operation. If the copy quality is not good, clean the scanner. (See <i>Cleaning the scanner</i> on page 105.)
Vertical black lines when sending.	If the copy you made shows the same problem, clean the scanner. (See <i>Cleaning the scanner</i> on page 105.)

Handling Incoming Calls

Difficulty	Suggestions
The machine 'Hears' a voice as a CNG Tone.	If Easy Receive is set to on, your machine is more sensitive to sounds. It may mistakenly interpret certain voices or music on the line as a fax machine calling and respond with fax receiving tones. Deactivate the machine by pressing Stop/Exit . Try avoiding this problem by turning Easy Receive to off. (See <i>Easy Receive</i> on page 37.)
Sending a fax call to the machine.	If you answered at the machine, press Black Start and hang up at once. If you answered on an external or extension phone, press your Fax Receive Code (default setting is X51). When your machine answers, hang up.
Custom features on a single line.	If you have Call Waiting, Call Waiting/Caller ID, Voice Mail, an alarm system or other custom feature on a single phone line with your machine, it may create a problem sending or receiving faxes. For example: If you subscribe to Call Waiting or some other custom service and its signal comes through the line while your machine is sending or receiving a fax, the signal can temporarily interrupt or disrupt the faxes. Brother's ECM feature should help overcome this problem. This condition is related to the telephone system industry and is common to all devices that send and receive information on a single, shared line with custom features. If avoiding a slight interruption is crucial to your business, a separate phone line with no custom features is recommended.

Menu Setting Difficulty

Difficulty	Suggestions
The machine beeps when you try to access the Setup Receive menu.	If the Fax  key is not illuminated, press it to turn on Fax mode. The Setup Receive setting is available only when the machine is in Fax mode.

Copying Difficulty

Difficulty	Suggestions
Cannot make a copy	Make sure that the Copy  key is illuminated. (See <i>Entering Copy mode</i> on page 70.) Make sure the panel cover is completely closed.
Vertical streaks appear in copies	If you see vertical streaks on copies, clean the scanner. (See <i>Cleaning the scanner</i> on page 105.)

Scanning Difficulty (MFC-3360C only)

Difficulty	Suggestions
Cannot scan	Make sure the panel cover is completely closed.
TWAIN/WIA errors appear while scanning.	Make sure the Brother TWAIN/WIA driver is chosen as the primary source. In PaperPort® SE with OCR, click File, Scan and choose the Brother TWAIN/WIA driver.

Software Difficulty

Difficulty	Suggestions
Cannot install software or print	Run the Repair MFL-Pro Suite program on the CD-ROM. This program will repair and reinstall the software.
'Device Busy'	Make sure the machine is not showing an error message on the LCD.

Error messages

As with any sophisticated office product, errors may occur. If this happens, your machine identifies the error and shows an error message. The most common error messages are shown below.

You can correct most errors by yourself. If you need more help, the Brother Solutions Center offers latest FAQs and troubleshooting tips.

Visit us at <http://solutions.brother.com>.

Error Message	Cause	Action
Change Unable XX Clean Unable XX	The machine has a mechanical problem. —OR— A foreign objects such as a clip or ripped paper is in the machine.	Open the upper jam clear cover and remove any foreign objects inside the machine. (MFC-3360C and FAX-1860C) If the error message continues, see <i>Transferring your faxes or Fax Journal report</i> on page 98 before disconnecting the machine so you will not lose any important messages. Then, disconnect the machine from the power for several minutes and then reconnect it. (FAX-1960C) Disconnect the machine from the power for several minutes, then reconnect it. (The machine can be turned off for approximately 24 hours without losing faxes stored in the memory.)
Comm. Error	Poor phone line quality caused a communication error.	Send the fax again or connect the machine to another telephone line. If the problem continues, call the telephone company and ask them to check your phone line.
Cover Open Close all covers	The Upper Jam Clear Cover is not closed completely. The ink cartridge cover is not closed completely.	Open the Upper Jam Clear Cover and then close it again. Firmly close the ink cartridge cover until it clicks.
Data Remaining	Print data is left in the machine's memory. Print data is left in the machine's memory. The USB cable was unplugged while the computer was sending the data to the machine.	Re-start printing from your computer. Press Stop/Exit . The machine will cancel the job and clear it from the memory. Try to print again.
Disconnected	The other person or other person's fax machine stopped the call.	Try to send or receive again.
Document Jam	The document was not inserted or fed properly, or the document scanned from the ADF was too long. The panel cover is open.	See <i>Using the ADF</i> on page 8. See <i>Document jam</i> on page 98. Close the panel cover and press Stop/Exit .

Error Message	Cause	Action
DR Mode in Use	The machine is set to Distinctive Ring mode. You cannot change the Receive Mode from Manual to another mode.	Set Distinctive Ring to off. (See <i>Turning off Distinctive Ring</i> on page 43.)
High Temperature	The print head is too warm.	Allow the machine to cool down.
Init Unable XX	The machine has a mechanical problem. —OR— A foreign objects such as a clip or ripped paper is in the machine.	Open the upper jam clear cover and remove any foreign objects inside the machine. (MFC-3360C and FAX-1860C) If the error message continues, see <i>Transferring your faxes or Fax Journal report</i> on page 98 before disconnecting the machine so you will not lose any important messages. Then, disconnect the machine from the power for several minutes and then reconnect it. (FAX-1960C) Disconnect the machine from the power for several minutes, then reconnect it. (The machine can be turned off for approximately 24 hours without losing faxes stored in the memory.)
Ink Empty XX	One or more of the ink cartridges is empty. The machine will stop all print operations. While memory is available, black and white faxes will be stored in the memory. If a sending machine has a color fax, the machine's 'handshake' will ask that the fax be sent as black and white. If the sending machine has the ability to convert it, the color fax will be stored in the memory as a black and white fax.	Replace the ink cartridges. (See <i>Replacing the ink cartridges</i> on page 102.)
Low Temperature	The print head is too cold.	Allow the machine to warm up.
Near Empty XX	One or more of the ink cartridges are running out of ink. If a sending machine has a color fax, the machine's 'handshake' will ask that the fax be sent as black and white. If the sending machine has the ability to convert it, the color fax will be received into memory as a black and white fax.	Order a new ink cartridge. (See <i>Ordering accessories and supplies</i> on page iii.)
No Caller ID	There is no incoming call history. You did not receive calls or you have not subscribed to the Caller ID service from your telephone company.	If you want to use the Caller ID feature call your telephone company. (See <i>Caller ID</i> on page 44.)
No Cartridge	An ink cartridge is not installed properly.	Take out the ink cartridge and put it in again seating it properly. (See <i>Replacing the ink cartridges</i> on page 102.)

Error Message	Cause	Action
No Paper Fed	The machine is out of paper or paper is not properly loaded in the paper tray.	Do one of the following: <ul style="list-style-type: none"> ■ Refill the paper in the paper tray, and then press Black Start or Color Start. ■ Remove the paper and load it again and then press Black Start or Color Start.
	The paper is jammed in the machine.	See <i>Printer jam or paper jam</i> on page 99.
No Response/Busy	The number you dialed does not answer or is busy.	Verify the number and try again.
Not Registered	You tried to access a One-Touch or Speed Dial number that is not programmed.	Set up the One-Touch or Speed Dial number. (See <i>Storing Speed-Dial numbers</i> on page 52.)
Out of Memory	The machine's memory is full.	<p>Fax sending or copy operation in progress</p> <ul style="list-style-type: none"> ■ Press Stop/Exit and wait until the other operations in progress finish and then try again. ■ Clear the data from the memory. To gain extra memory, you can turn off Fax Storage. (See <i>Turning off Remote Fax Options</i> on page 60.) ■ Print the faxes that are in the memory. (See <i>Printing a fax from the memory</i> on page 39.) <p>Printing operation in progress</p> Reduce print resolution. (For details, see <i>Printing for Windows®</i> or <i>Printing and Faxing for Macintosh®</i> in the Software User's Guide on the CD-ROM.)
Paper Jam	Paper is jammed in the machine.	Open the upper and lower jam clear covers (at the back of the machine) and remove the jammed paper. (See <i>Printer jam or paper jam</i> on page 99.)
Print Unable XX Scan Unable XX Tel Disabled (FAX-1960C only)	The machine has a mechanical problem. —OR— A foreign objects such as a clip or ripped paper is in the machine.	Open the upper jam clear cover and remove any foreign objects inside the machine. (MFC-3360C and FAX-1860C) If the error message continues, see <i>Transferring your faxes or Fax Journal report</i> on page 98 before disconnecting the machine so you will not lose any important messages. Then, disconnect the machine from the power for several minutes and then reconnect it. (FAX-1960C) Disconnect the machine from the power for several minutes, then reconnect it. (The machine can be turned off for approximately 24 hours without losing faxes stored in the memory.)
Wrong Paper Size	Paper is not the correct size.	Load the correct size of paper (Letter, Legal or A4), and then press Black Start or Color Start .

Transferring your faxes or Fax Journal report

If the LCD shows:

- Change Unable XX
- Clean Unable XX
- Init Unable XX
- Print Unable XX
- Scan Unable XX
- Tel Disabled

we recommend transferring your faxes to another fax machine. (See *Transferring faxes to another fax machine* on page 98.)

You can also transfer the Fax Journal report to see if there are any faxes you need to transfer. (See *Transferring Fax Journal report to another fax machine* on page 98.)



Note

If there is an error message on the machine's LCD, after the faxes have been transferred, disconnect the machine from the power source for several minutes, and then reconnect it.

Transferring faxes to another fax machine

If you have not set up your Station ID, you cannot enter fax transfer mode.

- 1 Press **Stop/Exit** to interrupt the error temporarily.
- 2 Press **Menu, 9, 0, 1**.
- 3 Do one of the following:
 - If the LCD shows *No Data*, there are no faxes left in the machine's memory.
Press **Stop/Exit**.
 - If the LCD shows *Enter Fax No.*, enter the fax number to which faxes will be forwarded.
- 4 Press **Black Start**.

Transferring Fax Journal report to another fax machine

If you have not set up your Station ID, you cannot enter fax transfer mode.

- 1 Press **Menu 9, 0, 2**.
- 2 Enter the fax number to which the Fax Journal report will be forwarded.
- 3 Press **Black Start**.

Document jam

Documents can jam if they are not inserted or fed properly, or if they are too long. Follow the steps below to clear a document jam.

Document is jammed inside the front of the machine

- 1 Take out any paper from the ADF that is not jammed.
- 2 Pull the jammed document (1) out toward the front of the machine.

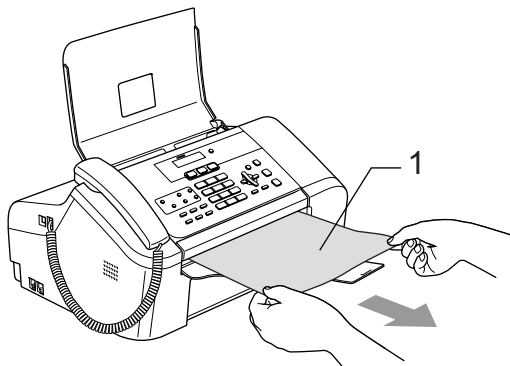

- 3 Press **Stop/Exit**.

Document is jammed inside the panel cover

- 1 Take out any paper from the ADF that is not jammed.
- 2 Open the panel cover.
- 3 Pull the jammed document out.

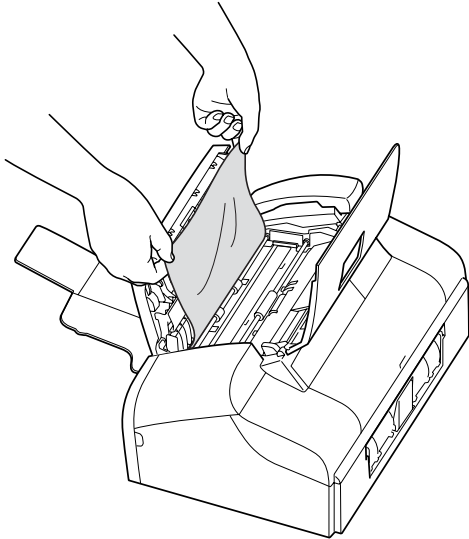

- 4 Close the panel cover.
- 5 Press **Stop/Exit**.

Printer jam or paper jam

Take out the jammed paper depending on where it is jammed in the machine.

- 1 Pull the paper tray (1) out of the machine.

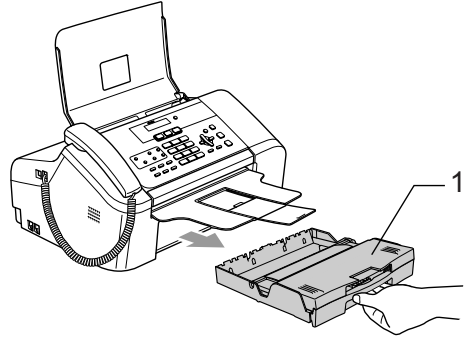

- 2 Pull out the jammed paper (1).

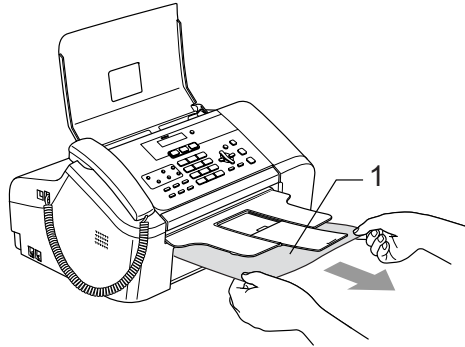

- 3 Reset the machine by opening the Upper Jam Clear Cover and then closing it.

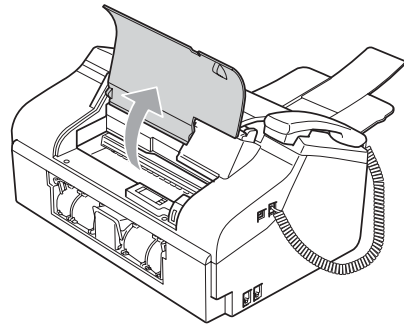

- If you cannot remove the jammed paper from the front of the machine, or the error message still appears on the LCD after you have removed the jammed paper, please go to the next step.

- 4 Remove the Lower Jam Clear Cover (1) from the back of the machine. Pull the jammed paper out of the machine.

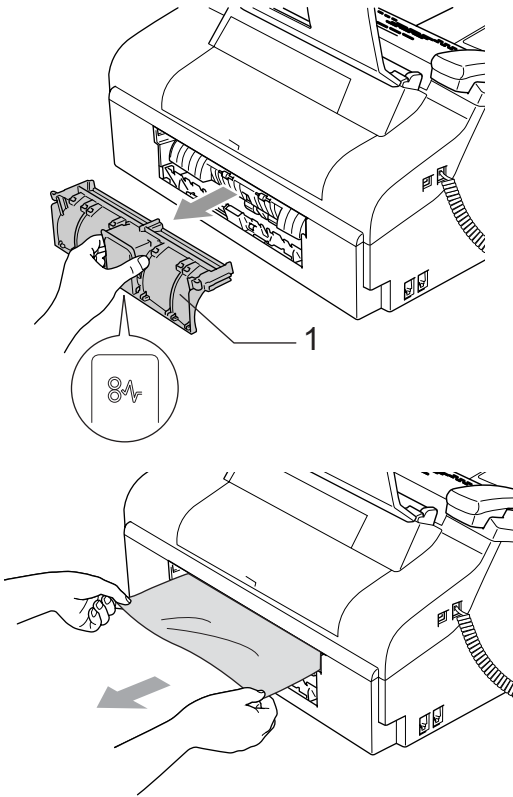

- 5 Put the Lower Jam Clear Cover back on. Make sure the cover is set properly.

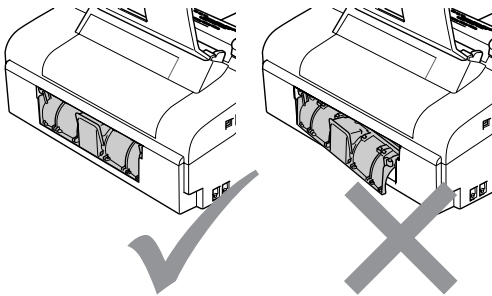

- 6 Open the Upper Jam Clear Cover (1). Make sure that there is no jammed paper left in the corners of the machine.

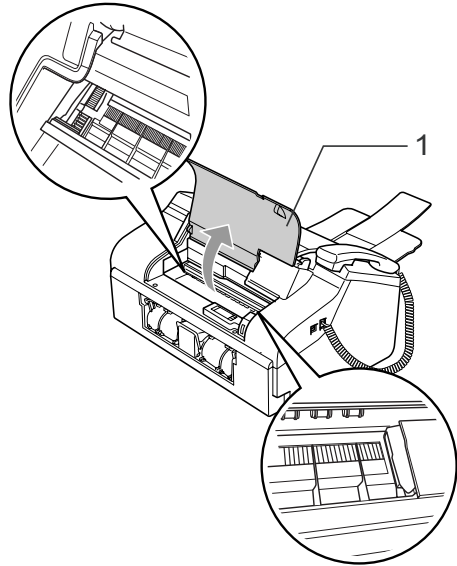

Note

If the paper is jammed under the print head, unplug the machine from the power source, and then move the print head to take out the paper.

- 7 Close the Upper Jam Clear Cover.

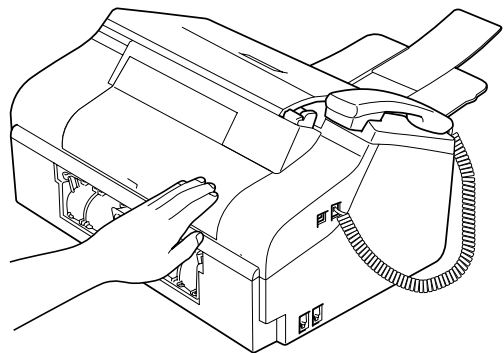

- 8 Push the paper tray firmly back into the machine. While holding the paper tray in place, pull out the paper support until it clicks and unfold the paper support flap. (See the illustrations in *Loading paper and other media* on page 13.)

Dial Tone

Setting the dial tone to Detection will shorten the dial detect pause.

- 1 Do one of the following:
 - (MFC-3360C and FAX-1960C)
Press **Menu, 0, 5**.
 - (FAX-1860C)
Press **Menu, 0, 4**.
- 2 Press **▲** or **▼** to choose *Detection* or *No Detection*.
Press **OK**.
- 3 Press **Stop/Exit**.

Phone line interference

If you are having problems sending or receiving a fax due to possible interference on the phone line, we recommend that you adjust the Equalization for compatibility to reduce the modem speed for fax operations.

- 1 Press **Menu, 2, 0, 2**.
 - 2 Press **▲** or **▼** to choose *Normal*, *Basic* (or *High*).
 - *Basic* reduces the modem speed to 9,600 bps. Unless interference is a recurring problem on your phone line, you may prefer to use it only when needed.
 - *Normal* sets the modem speed at 14,400 bps.
 - *High* sets the modem speed at 33,600 bps. (Default)
- Press **OK**.
- 3 Press **Stop/Exit**.



Note

When you change the compatibility to *Basic*, the ECM feature is only available for color fax sending.

Routine maintenance

Replacing the ink cartridges

Your machine is equipped with an ink dot counter. The ink dot counter automatically monitors the level of ink in each of the 4 cartridges. When the machine detects an ink cartridge is running out of ink, the machine will tell you with a message on the LCD.

The LCD will tell you which ink cartridge is low or needs replacing. Be sure to follow the LCD prompts to replace the ink cartridges in the correct order.

Even though the machine tells you that an ink cartridge is empty, there will be a small amount of ink left in the ink cartridge. It is necessary to keep some ink in the ink cartridge to prevent air from drying out and damaging the print head assembly.

- 1 Open the ink cartridge cover. If one or more ink cartridges are empty, for example Black, the LCD shows
Ink Empty Black and
Replace Ink.
- 2 Pull the lock release lever down and take out the ink cartridge for the color shown on the LCD.

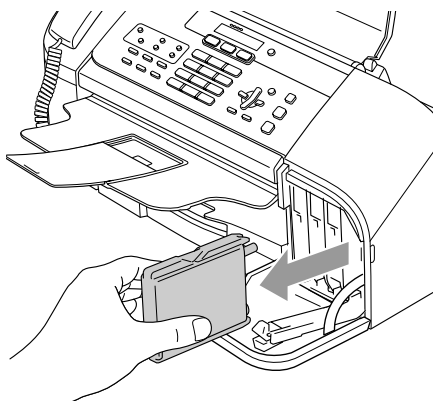
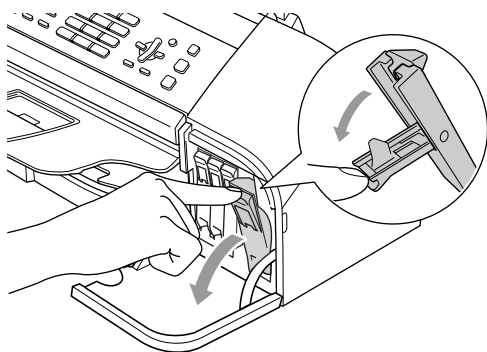

- 3 Open the new ink cartridge bag for the color shown on the LCD, and then take out the ink cartridge.
- 4 Remove the protective yellow cap (1).

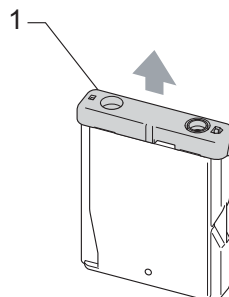

Improper Setup

DO NOT touch the area shown in the illustration below.

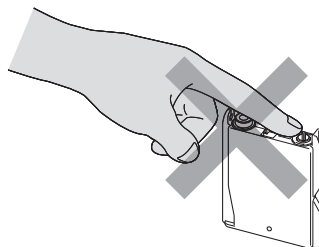

Note

If the protective yellow cap comes off when you open the bag, the cartridge will not be damaged.

- 5 Each color has its own correct position. Insert the ink cartridge in the direction of the arrow on the label.

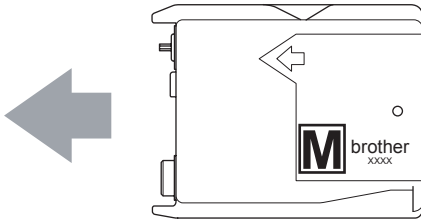

- 6 Lift each lock release lever and gently push it until it clicks, and then close the ink cartridge cover.

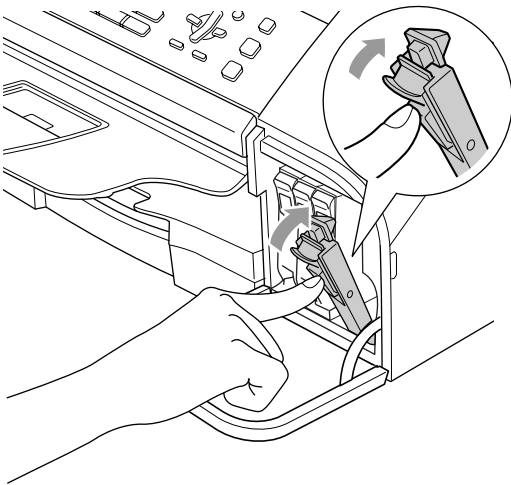

- 7 If you replaced an ink cartridge, the LCD may ask you to verify that it was a brand new one. (For example, Did You Change Blck?) For each new cartridge you installed, press **1** (Yes) to automatically reset the ink dot counter for that color. If the ink cartridge you installed is not a brand new one, be sure to press **2** (No). If you wait until the LCD shows Near Empty XX or Ink Empty XX, the machine will automatically reset the ink dot counter.



Note

If the LCD shows No Cartridge after you install the ink cartridges, check that the ink cartridges are installed properly.

! WARNING

If ink gets in your eyes, wash them out with water at once and call a doctor if you are concerned.

! CAUTION

Brother strongly recommends that you do not refill the ink cartridges provided with your machine. We also strongly recommend that you continue to use only Genuine Brother Brand replacement ink cartridges. Use or attempted use of potentially incompatible ink and/or cartridges in the Brother machine may cause damage to the machine and/or may result in unsatisfactory print quality. Our warranty coverage does not apply to any problem that is caused by the use of unauthorized third party ink and/or cartridges. To protect your investment and obtain premium performance from the Brother machine, we strongly recommend the use of Genuine Brother Supplies.

DO NOT take out ink cartridges if you do not need to replace them. If you do so, it may reduce the ink quantity and the machine will not know the quantity of ink left in the cartridge.

DO NOT touch the cartridge insertion slots. If you do so, the ink may stain your skin.

If ink stains your skin or clothing, wash with soap or detergent at once.

If you mix the colors by installing an ink cartridge in the wrong position, clean the print head several times after correcting the cartridge installation.

Once you open an ink cartridge, install it in the machine and use it up within six months of installation. Use unopened ink cartridges by the expiration date written on the cartridge package.

DO NOT dismantle or tamper with the ink cartridge; this can cause the ink to leak out of the cartridge.

Cleaning the outside of the machine

! CAUTION

Use neutral detergents. Cleaning with volatile liquids such as thinner or benzine will damage the outside surface of the machine.

DO NOT use cleaning materials that contain ammonia.

DO NOT use isopropyl alcohol to remove dirt from the control panel. It may crack the panel.

Clean the outside of the machine as follows:

- 1 Pull the paper tray (1) completely out of the machine.

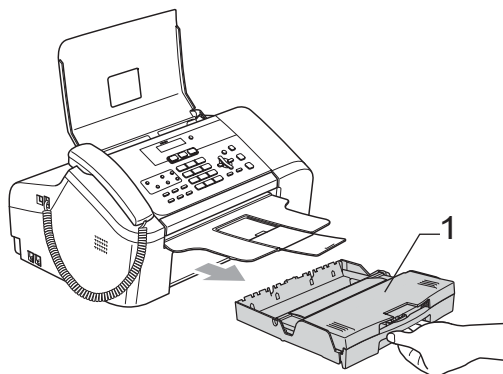

- 2 Wipe the outside of the machine with a soft cloth to remove dust.

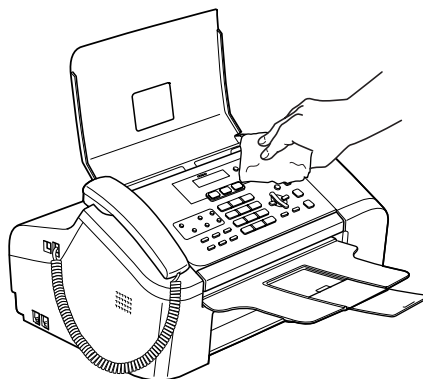

- 3 Remove anything that is stuck inside the paper tray.

- 4 Lift the output paper tray cover and wipe the inside and outside of the paper tray with a soft cloth to remove dust.

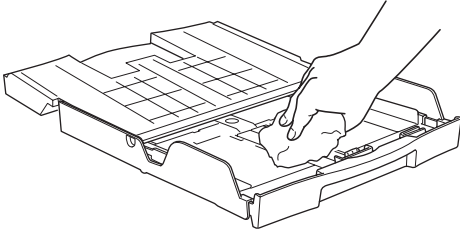

- 5 Close the output paper tray cover and put the paper tray firmly back in the machine.

Cleaning the scanner

- 1 Unplug the machine, open the panel cover (1). Clean the white bar (2) and the glass strip (3) with isopropyl alcohol on a soft lint-free cloth.

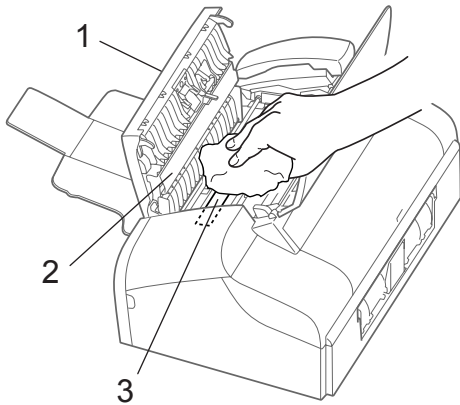

Cleaning the machine printer platen

WARNING

Unplug the machine from the AC power outlet before cleaning the printer platen (1).

If ink is scattered on or around the printer platen, wipe it off with a soft, dry, lint-free cloth.

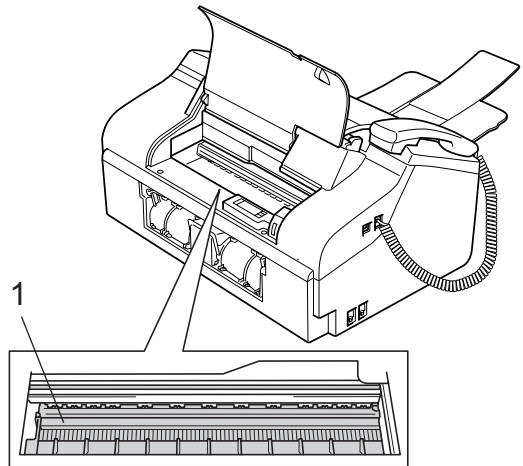

- 1 Clean the machine printer platen (1).

Cleaning the paper pick-up roller

- 1 Pull the paper tray completely out of the machine.
- 2 Unplug the machine from the AC power outlet and remove the Lower Jam Clear Cover (1).

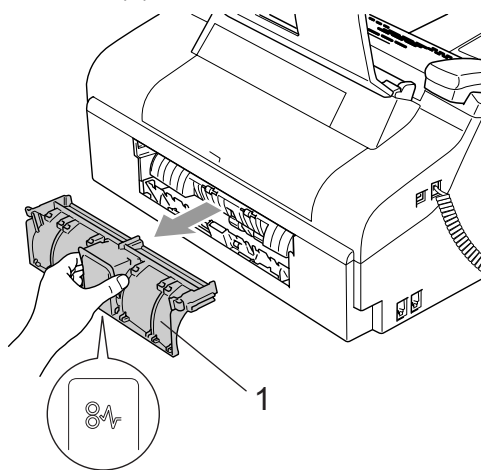

- 3 Clean the Paper Pick-up Roller (1) with isopropyl alcohol on a cotton swab.

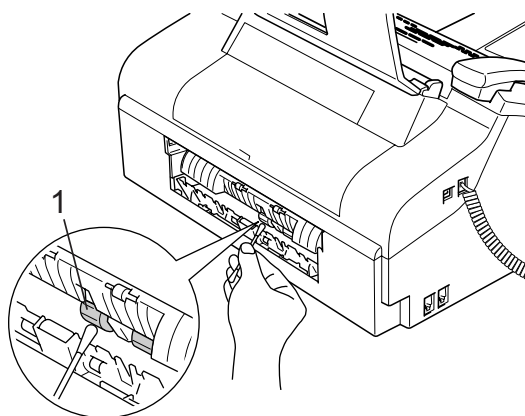

- 4 Put the Lower Jam Clear Cover back on. Make sure the cover is set properly.
- 5 Put the paper tray firmly back in the machine.
- 6 Re-connect the power cord.

Cleaning the print head

To ensure good print quality, the machine will regularly clean the print head. You can start the cleaning process manually if needed.

Clean the print head and ink cartridges if you get a horizontal line in the text or graphics on your printed pages. You can clean Black only, three colors at a time (Yellow/Cyan/Magenta), or all four colors at once.

Cleaning the print head consumes ink. Cleaning too often uses ink unnecessarily.

! CAUTION

DO NOT touch the print head. Touching the print head may cause permanent damage and may void the print head's warranty.

- 1 Press **Ink**.
- 2 Press **▲** or **▼** to choose **Cleaning**. Press **OK**.
- 3 Press **▲** or **▼** to choose **Black, Color** or **All**. Press **OK**.
The machine cleans the print head. When cleaning is finished, the machine will go back to standby mode automatically.



Note

If you clean the print head at least five times and the print has not improved, call Brother Customer Service. (See *Brother numbers* on page i.)

Checking the print quality

If faded or streaked colors and text appear on your output, some of the nozzles may be clogged. You can check this by printing the Print Quality Check Sheet and looking at the nozzle check pattern.

- 1 Press **Ink**.
- 2 Press **▲** or **▼** to choose **Test Print**. Press **OK**.
- 3 Press **▲** or **▼** to choose **Print Quality**. Press **OK**.
- 4 Press **Color Start**. The machine begins printing the Print Quality Check Sheet.

- 5 Check the quality of the four color blocks on the sheet.

Is Quality OK?

1.Yes 2.No

- 6 Do one of the following:
 - If all lines are clear and visible, press **1** to choose **Yes**. Press **Stop/Exit**.
 - If you can see missing short lines as shown below, press **2** to choose **No**.

OK

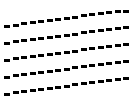

Poor

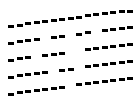

- 7 The LCD asks you if the print quality is OK for black and three colors.

Black OK?

1.Yes 2.No

Press **1** (Yes) or **2** (No).

- 8 The LCD asks you if you want to start cleaning.

Start Cleaning?

1.Yes 2.No

Press **1** (Yes).

The machine starts cleaning the print head.

- 9 After cleaning is finished, press **Color Start**.

The machine starts printing the Print Quality Check Sheet again and then returns to 5.

- 10 Press **Stop/Exit**.

If you repeat this procedure at least five times and the print quality is still poor, replace the ink cartridge for the clogged color.

After replacing the ink cartridge, check the print quality. If the problem still exists, repeat the cleaning and test print procedures at least five times for the new ink cartridge. If ink is still missing, call Brother Customer Service. (See *Brother numbers* on page i.)

! CAUTION

DO NOT touch the print head. Touching the print head may cause permanent damage and may void the print head's warranty.

Note



When a print head nozzle is clogged the printed sample looks like this.

After the print head nozzle is cleaned, the horizontal lines are gone.

Checking the print alignment

You may need to adjust the print alignment after transporting the machine if your printed text becomes blurred or images become faded.

- 1 Press **Ink**.
- 2 Press **▲** or **▼** to choose **Test Print**. Press **OK**.
- 3 Press **▲** or **▼** to choose **Alignment**. Press **OK**.
- 4 Press **Black Start** or **Color Start**. The machine starts printing the Alignment Check Sheet.

Is Alignment OK?

1.Yes 2.No

- 5 Check the 600 dpi and 1200 dpi test prints to see if number 5 most closely matches number 0.
 - If the number 5 sample of both the 600 dpi and 1200 dpi are the best matches, press **1** (**Yes**) to finish Alignment Check, and go to step **8**.
 - If another test print number is a better match for either 600 dpi or 1200 dpi, press **2** (**No**) to choose it.
- 6 For 600 dpi, press the number of the test print that most closely matches the number 0 sample (1-8).

600dpi Adjust

Select Best # 5

- 7 For 1200 dpi, press the number of the test print that most closely matches the number 0 sample (1-8).

1200dpi Adjust

Select Best # 5

- 8 Press **Stop/Exit**.

Checking the ink volume

You can check the ink that is left in the cartridge.

- 1 Press **Ink**.
- 2 Press **▲** or **▼** to choose **Ink Volume**. Press **OK**. The LCD shows the ink volume.

Ink Volume

BK: -□□□■□□□+

- 3 Press **▲** or **▼** to choose the color you want to check.
- 4 Press **Stop/Exit**.





Note

You can check the ink volume from your computer. (See *Printing for Windows®* or *Printing and Faxing for Macintosh®* in the *Software User's Guide on the CD-ROM*.)

Machine Information

Checking the serial number

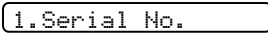
You can see the machine's serial number on the LCD.

- 1 Press **Menu**, **5**, **1**.

- 2 Press **OK**.

- 3 Press **Stop/Exit**.

Packing and shipping the machine

When you transport the machine, use the packing materials that came with your machine. If you do not pack the machine properly, you could void your warranty.

! CAUTION

It is important to allow the machine to 'park' the print head after a print job. Listen carefully to the machine before unplugging it to make sure that all mechanical noise has stopped. Not allowing the machine to finish this parking process may lead to print problems and possible damage to the print head.

- 1 Open the ink cartridge cover.
- 2 Pull the lock release levers down and take out all the ink cartridges.
- 3 Install the yellow protective part, lift each lock release lever and push it until it clicks, and then close the ink cartridge cover.

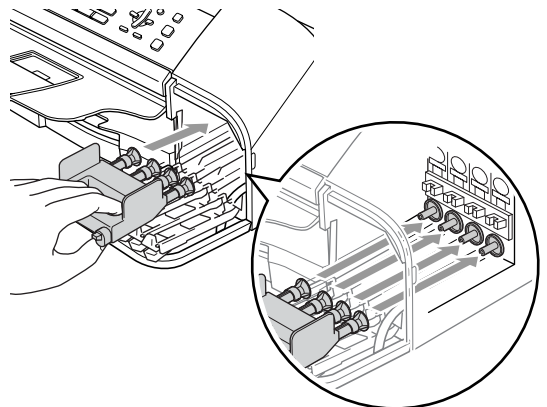

! CAUTION

If you are not able to find the yellow protective part, DO NOT remove the ink cartridges before shipping. It is essential that the machine be shipped with either the yellow protective part or the ink cartridges in position. Shipping without them will cause damage to your machine and may void your warranty.

- 4 Unplug the machine from the telephone wall jack and take the telephone line cord out of the machine.
- 5 Unplug the machine from the AC power outlet.
- 6 Unplug the interface cable from the machine, if it is connected.
- 7 If your machine has a handset, remove it and the handset curled cord.
- 8 Wrap the machine in the bag and put it in the original carton with the original packing material.

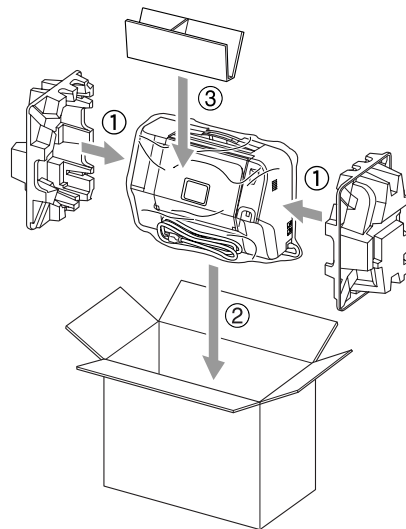
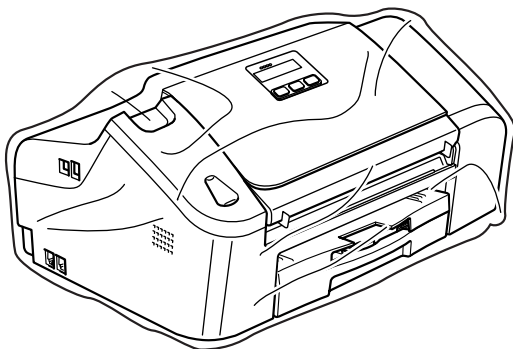

- 9 Pack the printed materials and additional parts in the original carton as shown below. Do NOT pack the used ink cartridges in the carton.

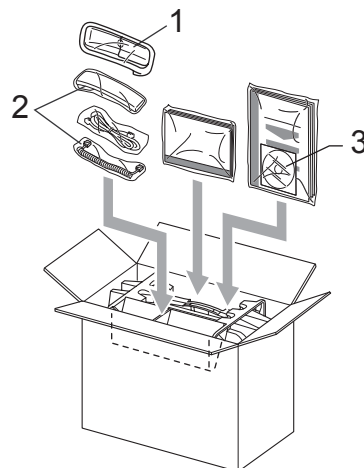

- 1 FAX-1960C only
- 2 MFC-3360C and FAX-1860C
- 3 MFC-3360C only

Note

If you are returning your machine to Brother as part of the Exchange Service, pack *only* the machine. Keep all separate parts and printed materials to use with your 'Exchange' machine.

- 10 Close the carton and tape it shut.

On-screen programming

Your machine is designed to be easy to use with LCD on-screen programming using the menu keys. User-friendly programming helps you take full advantage of all the menu selections your machine has to offer.

Since your programming is done on the LCD, we have created step-by-step on-screen instructions to help you program your machine. All you need to do is follow the instructions as they guide you through the menu selections and programming options.

Menu table

You can program your machine without the User's Guide by using the menu table that begins on page 113. These pages list the menu selections and options.

Press **Menu** followed by the menu numbers to program your machine.

For example, to set beeper volume to **Low**.

- 1 Press **Menu**, **1**, **4**, **2**.
- 2 Press **▲** or **▼** to choose **Low**.
- 3 Press **OK**.

Memory storage







Even if there is a power failure, you will not lose your menu settings because they are stored permanently. Temporary settings (such as Contrast, Overseas mode, and so on) will be lost. You may have to reset the date and time.

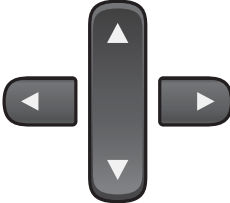

Note

During a power failure, the FAX-1960C will retain messages that are in the memory for approximately 24 hours.

Menu keys

	
 Menu	Access the menu.
 OK	Go to the next menu level. Accept an option.
 Clear / Back	Go back to the previous menu level. Delete an incorrect letter when you need to enter text into the machine.
	Scroll through the current menu level.
	Go back to the previous menu level.
	Exit the menu.

To access the menu mode:

- 1 Press **Menu**.
 - 2 Choose an option.
 - Press **1** for General Setup menu.
 - Press **2** for Fax menu.
 - Press **3** for Copy menu.
- ⋮
- Press **0** for Initial Setup.

You can scroll more quickly through each menu level by pressing **▲** or **▼** for the direction you want.

- 3 Press **OK** when that option appears on the LCD.
The LCD will then show the next menu level.
- 4 Press **▲** or **▼** to scroll to your next menu selection.
- 5 Press **OK**.
When you finish setting an option, the LCD shows *Accepted*.

Menu Table

The menu table will help you understand the menu selections and options that are found in the machine's programs. The factory settings are shown in Bold with an asterisk.

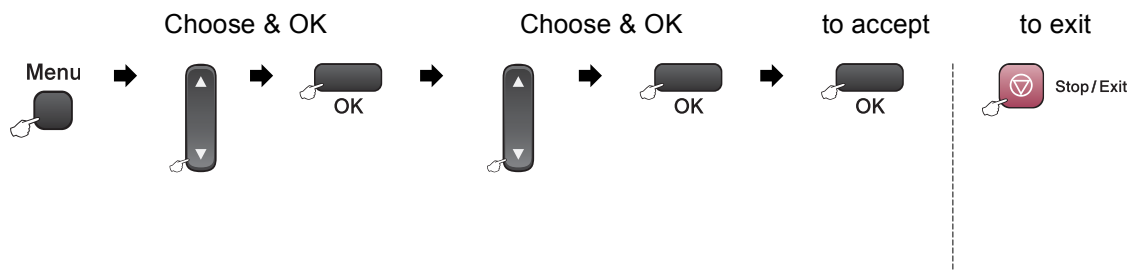

Main Menu	Submenu	Menu Selections	Options	Descriptions	Page
1.General Setup	1.Mode Timer	—	0 Sec*(FAX-1860C and FAX-1960C) 30 Sec*(MFC-3360C) 1 Min 2 Mins 5 Mins Off	Sets the time to return to Fax mode.	19
	2.Paper Type	—	Plain Paper* Inkjet Paper Brother Photo Other Photo Transparency	Sets the type of paper in the paper tray.	19
	3.Paper Size	—	Letter* Legal A4 A5 4"x6"	Sets the size of the paper in the paper tray.	20
	4.Volume	1.Ring		Off Low Med* High	Adjusts the ring volume.
2.Beeper			Off Low* Med High	Adjusts the volume level of the beeper.	20

Main Menu	Submenu	Menu Selections	Options	Descriptions	Page
1. General Setup (Continued)	4. Volume (Continued)	3. Speaker	Off Low Med* High	Adjusts the speaker volume.	20
		4. Handset (MFC-3360C and FAX-1860C)	Low* High	Adjusts the handset volume.	21
		5. Volume Amplify (MFC-3360C and FAX-1860C)	On (Permanent/ Temporary) Off*	For the hearing-impaired, you can set the volume to the Vol Amplify:On setting on a permanent or temporary basis.	22
	5. Auto Daylight	—	On Off*	Changes for Daylight Savings Time automatically.	22
	6. On/Off Setting	—	Fax Receive:On Fax Receive:Off*	Customizes the On/Off key to receive faxes even in off mode.	18
	7. LCD Contrast	—	Light Dark*	Adjusts the contrast of the LCD.	22
	8. Echo Control	—	level 1* level 2 level 3 level 4	Adjusts the Echo Control level if you hear an echo when using the cordless handset.	See Digital Cordless Handset User's Guide
2. Fax	1. Setup Receive (In Fax mode only)	1. Ring Delay (MFC-3360C and FAX-1860C)	00 01 02 03 04*	Sets the number of rings before the machine answers in Fax Only or Fax/Tel mode.	37
		1. Ring Delay (FAX-1960C only)	Ring Delay 20 Sec* 04 03 02 01 00	Sets the number of rings before the machine answers in Fax Only, Fax/Tel or MC:Msg Ctr mode.	37
		Toll Saver On Off*	Costs saving feature: the machine rings 2 times if there are messages and 4 times if there are no messages, so you can hang up and not pay for the call.	58	

Main Menu	Submenu	Menu Selections	Options	Descriptions	Page
2. Fax (Continued)	1. Setup Receive (In Fax mode only) (Continued)	2. F/T Ring Time	20 Sec* 30 Sec 40 Sec 70 Sec	Sets the pseudo/double-ring time in Fax/Tel mode.	37
		3. Easy Receive	On* Semi Off	Receives fax messages without pressing Start .	37
		4. Remote Codes	On* (*51, #51) Off	Allows you to answer all calls at an extension or external phone and use codes to turn the machine on or off. You can personalize these codes.	49
		5. Auto Reduction	On* Off	Cuts the size of incoming faxes.	38
		6. Polling RX	–	Sets up your machine to poll another fax machine.	67
	2. Setup Send (In Fax mode only)	1. Contrast	Auto* Light Dark	Changes the lightness or darkness of faxes you send.	30
		2. Fax Resolution	Standard* Fine S. Fine Photo	Sets the default resolution for outgoing faxes.	30
		3. Delayed Fax	–	Set the time of day in 24-hour format that the delayed faxes will be sent.	32
		4. Batch TX	On Off*	Combines delayed faxes to the same fax number at the same time of day into one transmission.	32
		5. Real Time TX	Next Fax Only Off* On	Sends a fax without using the memory.	31
		6. Polled TX	On Off*	Sets up the document on your machine to be retrieved by another fax machine.	68
		7. Overseas Mode	On Off*	If you are having problems sending faxes overseas, set this to on.	31

Main Menu	Submenu	Menu Selections	Options	Descriptions	Page	
2. Fax (Continued)	3. Set Quick-Dial	1. One-Touch Dial	—	Stores One-Touch Dial numbers, so you can dial by pressing only a few keys (and Start).	50	
		2. Speed-Dial	—	Stores Speed-Dial numbers, so you can dial by pressing only a few keys (and Start).	52	
		3. Setup Groups	—	Sets up a Group number for Broadcasting.	53	
	4. Report Setting	1. Transmission	On On+Image Off* Off+Image	Sets initial setup for Transmission Verification Report and Fax Journal.	66	
		2. Journal Period	Off Every 50 Faxes* Every 6 Hours Every 12 Hours Every 24 Hours Every 2 Days Every 7 Days		65	
	5. Remote Fax Opt	1. Fwd/Page/Store	Off* Fax Forward Paging Fax Storage	Sets the machine to forward fax messages or to store incoming faxes in the memory so you can retrieve them while you are away from your machine.	59	
			2. Remote Access	---*	You must set your own code for Remote Retrieval.	61
			3. Print Fax	—	Prints incoming faxes stored in the memory.	39
	6. Remaining Jobs	—	—	Checks which jobs are in the memory and lets you cancel chosen jobs.	32	
	7. Setup Msg Ctr (FAX-1960C)	1. OGM	Msg Ctr OGM F/T OGM	Play/Record or erase the outgoing message.	55	
		2. ICM Max. Time	30* 60 120 180	Select the maximum length of incoming messages.	58	
		3. ICM Rec. Monitr	On* Off	Allows you to turn the speaker volume for voice messages as they come in On or Off.	58	

Main Menu	Submenu	Menu Selections	Options	Descriptions	Page
2. Fax (Continued)	0. Miscellaneous	1. TX Lock (MFC-3360C and FAX-1860C)	—	Stops unauthorized users from changing the machine's current settings.	23
		1. Mem Security (FAX-1960C only)	—	Prohibits most functions except receiving faxes into memory.	24
		2. Compatibility	High* Normal Basic	Adjusts the equalization for transmission problems.	101
		3. Distinctive	Off* Set (On)	Uses the Telephone Company's Distinctive Ring subscriber service to register the ring pattern with the machine.	42
		4. Caller ID	Display#* Print Report	View or print a list of the last 30 Caller IDs stored in the memory.	44
3. Copy	1. Quality	—	Best Fast Normal*	Chooses the Copy resolution for your type of document.	71
	2. Brightness	—	-□□□□■+ -□□□■□+ -□□■□□+* -□■□□□+ -■□□□□+	Adjusts the brightness for copies.	74
	3. Contrast	—	-□□□□■+ -□□□■□+ -□□■□□+* -□■□□□+ -■□□□□+	Adjusts the contrast for copies.	75

Main Menu	Submenu	Menu Selections	Options	Descriptions	Page
3.Copy (Continued)	4.Color Adjust	1.Red	R:- □□□□■ + R:- □□□■□ + R:- □□■□□ +* R:- □■□□□ + R:- ■□□□□ +	Adjusts the amount of Red in copies.	75
		2.Green	G:- □□□□■ + G:- □□□■□ + G:- □□■□□ +* G:- □■□□□ + G:- ■□□□□ +	Adjusts the amount of Green in copies.	
		3.Blue	B:- □□□□■ + B:- □□□■□ + B:- □□■□□ +* B:- □■□□□ + B:- ■□□□□ +	Adjusts the amount of Blue in copies.	
4.Print Reports	1.Transmission	—	—	Prints a Transmission Verification Report for your last transmission.	65
	2.Help List	—	—	Prints the Help List so you can see at-a-glance how to quickly program your machine.	66
	3.Quick-Dial	—	—	Lists name and numbers stored in the One-Touch and Speed-Dial memory, in numerical order.	66
	4.Fax Journal	—	—	Lists information about the last incoming and outgoing faxes. (TX means Transmit.) (RX means Receive.)	65
	5.User Settings	—	—	Lists your settings.	66
5.Machine Info.	1.Serial No.	—	—	Lets you check the serial number of your machine.	109

MFC-3360C and FAX-1960C

Main Menu	Submenu	Menu Selections	Options	Descriptions	Page
0. Initial Setup	1. Receive Mode (MFC-3360C)	—	Fax Only* Fax/Tel External TAD Manual	Choose the receive mode that best suits your needs.	34
	1. Receive Mode (FAX-1960C)	—	Fax Only* Fax/Tel Manual	Choose the receive mode that best suits your needs.	34
	2. Date/Time	—	—	Puts the date and time on the LCD and in headings of faxes you send.	See Quick Setup Guide
	3. Station ID	—	Fax: Name:	Set your name and fax number to appear on each page you fax.	
	4. Tone/Pulse (Canada only)	—	Tone* Pulse	Choose the dialing mode.	
	5. Dial Tone	—	Detection No Detection*	You can shorten the dial tone detect pause.	101
	6. Register HS (FAX-1960C)	—		Sets the machine to register the cordless handset.	See Digital Cordless Handset User's Guide
	0. Local Language (Canada only)	—	English* French	Allows you to change the LCD language for your country.	See Quick Setup Guide

FAX-1860C

Main Menu	Submenu	Menu Selections	Options	Descriptions	Page
0. Initial Setup	1. Date/Time	—	—	Puts the date and time on the LCD and in headings of faxes you send.	See Quick Setup Guide
	2. Station ID	—	Fax: Name:	Set your name and fax number to appear on each page you fax.	
	3. Tone/Pulse (Canada only)	—	Tone* Pulse	Choose the dialing mode.	
	4. Dial Tone	—	Detection No Detection*	You can shorten the dial tone detect pause.	101

Entering Text

When you are setting certain menu selections, such as the Station ID, you may need to enter text into the machine. Most dial pad keys have three or four letters printed on keys. The keys for **0**, **#** and ***** do not have printed letters because they are used for special characters.

By pressing the proper dial pad key repeatedly, you can access the character you want.

Press Key	one time	two times	three times	four times
2	A	B	C	2
3	D	E	F	3
4	G	H	I	4
5	J	K	L	5
6	M	N	O	6
7	P	Q	R	S
8	T	U	V	8
9	W	X	Y	Z

Putting spaces

To enter a space in a fax number, press ► once between numbers. To enter a space in a name, press ► twice between characters.

Making corrections

If you entered an incorrect letter and want to change it, press ◀ to move the cursor under the incorrect character. Then press **Clear/Back**. Re-enter the correct character. You can also back up and insert letters.

Repeating letters

If you need to enter a letter that is on the same key as the letter before, press ► to move the cursor to the right before you press the key again.

Special characters and symbols

Press *****, **#** or **0**, and then press ◀ or ► to move the cursor under the special character or symbol you want. Then press **OK** to choose it.

Press ***** for (space)! " # \$ % & ' () *
+ , - . / €

Press **#** for ; : < = > ? @ [] ^ _

Press **0** for É À È Ê Î Ç Ë Ö 0

D

Specifications

General

Memory Capacity	16 MB
Memory Backup	Approx. 24 hours (FAX-1960C only)
ADF (automatic document feeder)	Up to 20 pages Temperature: 68° F - 86° F (20° C - 30° C) Humidity: 50% - 70% Paper: [20 lb (80 g/m ²)] Letter size
Paper Tray	100 Sheets [20 lb (80 g/m ²)]
Printer Type	Ink Jet
Print Method	Black: Piezo with 94 × 1 nozzles Color: Piezo with 94 × 3 nozzles
LCD (Liquid Crystal Display)	16 characters × 1 line
Power Source	AC 100 to 120V 50/60Hz MFC-3360C and FAX-1860C
Power Consumption	Off Mode: Average 4 W Standby: Average 6 W Operating: Average 27 W FAX-1960C Off Mode: Average 7 W Stand by: Average 8 W Operating: Average 30 W

Dimensions MFC-3360C and FAX-1860C

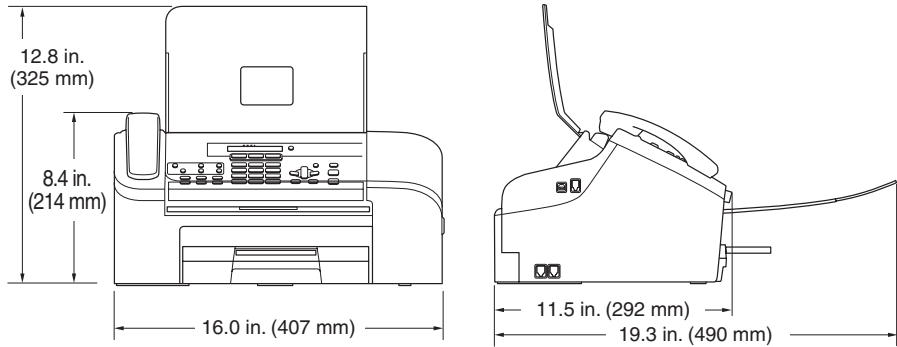

FAX-1960C

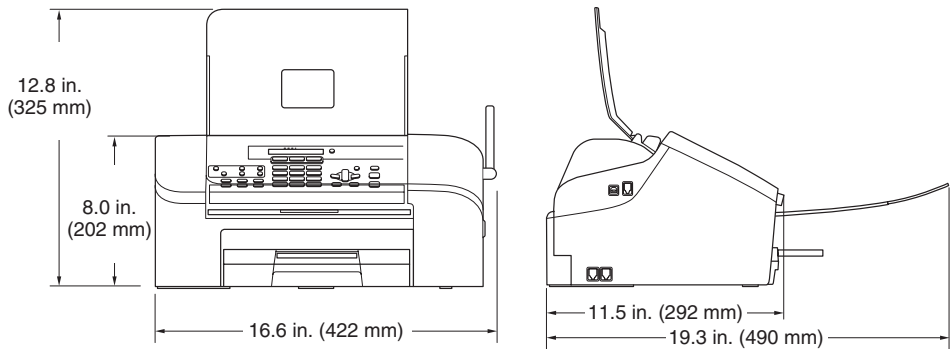

Weight	MFC-3360C and FAX-1860C:	13.2 lb (6.0 kg)
	FAX-1960C:	13.4 lb (6.1 kg)
Noise	Operating:	50 dB ¹
Temperature	Operating:	50° F to 95° F (10 to 35° C)
	Best Print Quality:	68° F to 91° F (20 to 33° C)
Humidity	Operating:	20 to 80% (without condensation)
	Best Print Quality:	20 to 80% (without condensation)

¹ This depends on print conditions.

Print media

Paper Input

Paper Tray

■ Paper type:

Plain paper, inkjet paper (coated paper), glossy paper², transparencies^{1 2} and envelopes

■ Paper size:

Letter, Legal, Executive, A4, A5, A6, JIS B5, envelopes (commercial No.10, DL, C5, Monarch, JE4), Photo 4" × 6", Index card and Post card³.

Width: 3.5 in (89 mm) – 8.5 in (216 mm)

Height: 5.0 in (127 mm) – 14.0 in (356 mm)

For more details, see *Paper weight, thickness and capacity* on page 12.

■ Maximum paper tray capacity: Up to 100 sheets of 20 lb (80 g/m²) plain paper

Paper Output

Up to 50 sheets of 20 lb (80 g/m²) plain paper (face up print delivery to the output paper tray)²

¹ Use only transparencies recommended for inkjet printing.

² For glossy paper or transparencies, we recommend removing printed pages from the output paper tray immediately after they exit the machine to avoid smudging.

³ See *Paper type and size for each operation* on page 11.

Fax

Compatibility	ITU-T Group 3
Coding System	MH/MR/MMR/JPEG
Modem Speed	Automatic Fallback 33,600 bps
Document Size	ADF Width: 3.5 in. to 8.5 in. (89 mm to 215.9 mm) ADF Height: 5 in. to 14 in. (127 mm to 355.6 mm)
Scanning Width	8.2 in. (208 mm)
Printing Width	8.03 in. (204 mm)
Gray Scale	256 levels
Polling Types	Standard, Sequential: (Black only)
Contrast Control	Automatic/Light/Dark (manual setting)
Resolution	■ Horizontal 203 dot/in. (8 dot/mm) ■ Vertical Standard 98 line/in. (3.85 line/mm) (Black) 196 line/in. (7.7 line/mm) (Color) Fine 196 line/in. (7.7 line/mm) (Black/Color) Photo 196 line/in. (7.7 line/mm) (Black) Superfine 392 line/in. (15.4 line/mm) (Black)
Speed-Dial	100 stations
One-Touch	10 stations
Broadcasting	160 stations
Automatic Redial	1 time after 5 minutes
Auto Answer	0, 1, 2, 3 or 4 rings
Communication Source	Public switched telephone network.
Memory Transmission	MFC-3360C: Up to 200 ¹ /170 ² pages FAX-1860C and FAX-1960C: Up to 250 ¹ /300 ² pages
Out of Paper Reception	MFC-3360C: Up to 200 ¹ /170 ² pages FAX-1860C and FAX-1960C: Up to 250 ¹ /300 ² pages

¹ 'Pages' refers to the 'Brother Standard Chart No. 1' (a typical business letter, Standard resolution, MMR code). Specifications and printed materials are subject to change without prior notice.

² 'Pages' refers to the 'ITU-T Test Chart #1' (a typical business letter, Standard resolution, MMR code). Specifications and printed materials are subject to change without prior notice.

Message Center (FAX-1960C only)

Message Center	Yes
ICM Recording Time	Max. 29 minutes / Max. 99 messages (Max. 180 secs / 1 message)
Toll Saver	Yes
OGM	Yes
Recording OGM Time	20 Secs

Digital Cordless Handset (FAX-1960C only)

Frequency	5.8 GHz
Technology	FHSS (Frequency Hopping Spread Spectrum)
Multi Handset Capability	Up to 4 handsets ¹

Dimensions

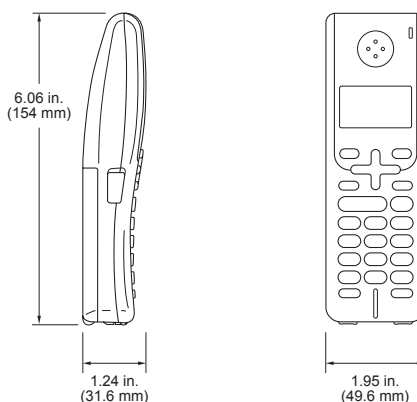

Weight (including battery)	5.43 oz (154 kg)
LCD (liquid crystal display)	16-Digit, 3-Line (+1-Line for Pict), Backlit (Orange)
Charge Indicator	Yes (LED)
Full charge Time	12 hours
While in Use (TALK)	4 hours ² 6 hours ³
While Not in Use (Standby)	200 hours

- ¹ Additional purchase required
² When Voice Enhance is set to On.
³ When Voice Enhance is set to Off.

Battery

Type:	BCL-BT10
Rating:	Ni-MH 3.6 V 730 mAh

Copy

Color/Black	Yes/Yes
Document Size	ADF Width: 3.5 in. to 8.5 in. (89mm to 215.9 mm) ADF Height: 5 in. to 14 in. (127mm to 355.6 mm)
Copy Speed	Black: Up to 18 pages/minute (Letter paper) ¹ Color: Up to 16 pages/minute (Letter paper) ¹
Multiple Copies	Stacks up to 99 pages Sorts up to 99 pages (Black only)
Enlarge/Reduce Resolution	25% to 400% (in increments of 1%) (Black) <ul style="list-style-type: none">■ Scans up to 600×1200 dpi■ Prints up to 1200×1200 dpi (Color) <ul style="list-style-type: none">■ Scans up to 600×1200 dpi■ Prints up to 600×1200 dpi

¹ Based on Brother standard pattern. (Fast mode/Stack Copy) Copy speeds vary with the complexity of the document.

Scanner (MFC-3360C only)

Color/Black	Yes/Yes
TWAIN Compliant	Yes (Windows [®] 98/98SE/Me/2000 Professional/XP ¹ /Windows [®] XP Professional x64 Edition) Mac OS [®] X 10.2.4 or greater
WIA Compliant	Yes (Windows [®] XP ¹)
Color Depth	36 bit color Processing (Input) 24 bit color Processing (Output) (Actual Input: 30 bit color/Actual Output: 24 bit color)
Resolution	Up to 2400 × 2400 dpi (interpolated) ² Up to 600 × 1200 dpi (optical)
Scanning Speed	Color: up to 8.49 sec. Black: up to 3.81 sec. (Letter size in 100 × 100 dpi)
Document Size	ADF Width: 3.5 in. to 8.5 in. (89 mm to 215.9 mm) ADF Height: 5 in. to 14 in. (127 mm to 355.6 mm)
Scanning Width	8.26 in. (210 mm)
Gray Scale	256 levels

¹ Windows[®] XP in this User's Guide includes Windows[®] XP Home Edition, Windows[®] XP Professional, and Windows[®] XP Professional x64 Edition.

² Maximum 1200 × 1200 dpi scanning when using the WIA Driver for Windows[®] XP.

Printer



Note

You can download the free Brother Printer Driver and PC-FAX Send driver from the Brother Solutions Center for use with the FAX-1860C and FAX-1960C. Visit us at:

<http://solutions.brother.com>

- Please download the printer driver first before connecting the machine to your computer with the USB cable.
- You must use an appropriate USB cable. If you do not have one, please purchase a USB 2.0 interface cable that is no longer than 6 feet (2 meters).
- Your machine has a USB 2.0 Full-speed interface. This interface is compatible with USB 2.0 Hi-Speed; however, the maximum data transfer rate will be 12 Mbits/s. The machine can also be connected to a computer that has a USB 1.1 interface.
- Third party USB ports are not supported for Macintosh®.

Printer Driver	Windows® 98/98SE/Me/2000 Professional and XP/ Windows® XP Professional x64 Edition driver supporting Brother Native Compression mode and bi-directional capability For Mac OS® X 10.2.4 or greater: Brother Ink Driver
Resolution	Up to 1200 × 6000 dpi ¹ 1200 × 2400 dpi 1200 × 1200 dpi 600 × 600 dpi 600 × 300 dpi 600 × 150 dpi
Print Speed	Black: Up to 25 pages/minute (Letter paper) ² Color: Up to 20 pages/minute (Letter paper) ²
Printing Width	8.26 in. [8.5 in. (borderless) ³] ⁵ 210 mm [216 mm (borderless) ³] ⁵
Disk-Based Fonts	35 TrueType
Borderless	Letter, A4, A6, Photo 4" × 6", Index Card, Photo 2L 5"×7", Post Card ⁴

¹ Output image quality varies based on many factors including, but not limited to input image resolution and quality and print media.

² Based on Brother standard pattern. Letter size in draft mode.

³ When you set the Borderless feature to On.

⁴ See *Paper type and size for each operation* on page 11.

⁵ When printing on letter size paper.

Interface

USB

A USB 2.0 interface cable that is no longer than 6 feet (2.0 m). ^{1 2}

- ¹ Your machine has a USB 2.0 interface. This interface is compatible with USB 2.0; however, the maximum data transfer rate will be 12 Mbits/s. The machine can also be connected to a computer that has a USB 1.1 interface.
- ² Third party USB ports are not supported for Macintosh®.

Computer requirements

Minimum System Requirements								
Computer Platform & Operating System Version		Supported PC Software Functions	PC Interface	Processor Minimum Speed	Minimum RAM	Recommended RAM	Available Hard Disk Space	
							for Drivers	for Applications
Windows® ¹ Operating Systems	98, 98SE	Printing, PC-FAXSend ³ , Scanning	USB	Intel® Pentium® II or equivalent	32 MB	128 MB	120 MB	130 MB
	Me				64 MB	256 MB		
	2000 Professional				128 MB	256 MB	170 MB	220 MB
	XP Home XP Professional			AMD Opteron™ AMD Athlon™64 Intel® Xeon™ with Intel® EM64T Intel® Pentium® 4 with Intel® EM64T	256 MB	512 MB	170 MB	220 MB
XP Professional x64 Edition								
Apple® Macintosh® Operating Systems	OS X 10.2.4 or greater	Printing, PC-FAXSend ³ , Scanning	USB ²	Power PC G3/G4/G5, Intel® Core™ Solo/Duo. 350MHz	128 MB	256 MB	80 MB	200 MB
¹ Microsoft® Internet Explorer 5 or greater. ² Third party USB ports are not supported. ³ PC Fax supports black and white faxing only.				For the latest driver updates, access the Brother Solutions Center at http://solutions.brother.com				

Consumable items

Ink

The machine uses individual Black, Yellow, Cyan and Magenta ink cartridges that are separate from the print head assembly.

Service Life of Ink Cartridge

The first time you install the ink cartridges the machine will use extra ink to fill the ink delivery tubes. This is a one-time process that enables high quality printing. Afterward, replacement ink cartridges will print the specified number of pages.

Replacement Ink Cartridges

Standard Black - Approximately 500 pages at 5% coverage

Yellow, Cyan and Magenta - Approximately 400 pages at 5% coverage

The above figures are based upon the following assumptions:

- Continuous printing at a resolution of 600 × 600 dpi in normal mode after installing new ink cartridge;
- The printing frequency;
- The number of pages printed;
- Periodic, automatic, print head assembly cleaning (Your machine will clean the print head assembly periodically. This process will use a small amount of ink); and,
- Ink remaining in cartridge identified as 'empty' (It is necessary to leave a small amount of ink in the ink cartridge to prevent air from drying out and damaging the print head assembly).

Replacement Consumables

<Black> LC51BK, <Yellow> LC51Y, <Cyan> LC51C, <Magenta>LC51M

E

Glossary

This is a comprehensive list of features and terms that appear in Brother manuals. Availability of these features depends on the model you purchased.

ADF (automatic document feeder)

The document can be placed in the ADF and scanned one page at a time automatically.

Auto Reduction

Reduces the size of incoming faxes.

Automatic fax transmission

Sending a fax without picking up the handset or pressing **Hook/Hold** or **Speaker Phone**.

Automatic Redial

A feature that enables your machine to redial the last fax number after five minutes if the fax did not go through because the line was busy.

Backup Print

Your machine prints a copy of every fax that is received and stored in memory. This is a safety feature so you will not lose messages during a power failure.

Batch Transmission

(Black and white faxes only) As a cost saving feature, all delayed faxes to the same fax number can be sent as one transmission.

Beeper Volume

Volume setting for the beep when you press a key or make an error.

Brightness

Changing the Brightness makes the whole image lighter or darker.

Broadcasting

The ability to send the same fax message to more than one location.

Caller ID

A service purchased from the telephone company that lets you see the number (or name) of the party calling you.

CNG tones

The special tones (beeps) sent by fax machines during automatic transmission to tell the receiving machine that a fax machine is calling.

Coding method

Method of coding the information contained in the document. All fax machines must use a minimum standard of Modified Huffman (MH). Your machine is capable of greater compression methods, Modified Read (MR), Modified Modified Read (MMR) and JPEG, if the receiving machine has the same capability.

Communication error (Comm. Error)

An error during fax sending or receiving, usually caused by line noise or static.

Compatibility group

The ability of one fax unit to communicate with another. Compatibility is assured between ITU-T Groups.

Contrast

Setting to compensate for dark or light documents, by making faxes or copies of dark documents lighter and light documents darker.

Delayed Fax

Sends your fax later at a specified time.

Distinctive Ring

A subscriber service purchased from the telephone company that gives you another phone number on an existing phone line. The Brother machine uses the new number to simulate a dedicated fax line.

Dual Access

Your machine can scan outgoing faxes or scheduled jobs into memory at the same time it is sending a fax from memory or receiving or printing an incoming fax.

Easy Receive

Enables your machine to respond to CNG tones if you interrupt a fax call by answering it.

ECM (Error Correction Mode)

Detects errors during fax transmission and resends the pages of the fax that had an error.

Extension phone

A telephone using the same line as your fax but plugged into a separate wall jack.

External phone

A telephone that is plugged into the EXT jack of your machine.

F/T Ring Time

The length of time that the Brother machine rings a pseudo/double-ring (when the Receive Mode setting is Fax/Tel) to notify you to pick up a voice call that it answered.

Fax Forwarding

Sends a fax received into the memory to another pre-programmed fax number.

Fax Journal

Lists information about the last 200 incoming and outgoing faxes. TX means Transmit. RX means Receive.

Fax Receive Code

Press this code (**✕ 5 1**) when you answer a fax call on an extension or external phone.

Fax Storage

You can store received faxes in the memory.

Fax tones

The signals sent by sending and receiving fax machines while communicating information.

Fax/Tel

You can receive faxes and telephone calls. Do not use this mode if you are using a telephone answering device (TAD).

Fine resolution

Resolution is 203 × 196 dpi. It is used for small print and graphs.

Gray scale

The shades of gray available for copying, scanning and faxing photographs.

Group number

A combination of One-Touch and Speed-Dial numbers that are stored on a One-Touch key or a Speed-Dial location for Broadcasting.

Help list

A printout of the complete Menu table that you can use to program your machine when you do not have the User's Guide with you.

Journal Period

The pre-programmed time period between automatically printed Fax Journal Reports. You can print the Fax Journal on demand without interrupting the cycle.

LCD (liquid crystal display)

The display screen on the machine that shows interactive messages during On-Screen Programming and shows the date and time when the machine is idle.

Manual fax

Depending on your model, you can lift the handset or press **Hook/Hold** or **Speaker Phone** on the machine to hear the receiving fax machine answer before you press **Black Start** or **Color Start** to begin sending.

Menu mode

Programming mode for changing your machine's settings.

OCR (optical character recognition)

(MFC-3360C only)

The bundled (ScanSoft® Paperport® SE with OCR or Presto!® PageManager) software application converts an image of text to text you can edit.

One-Touch

Keys on the machine's control panel where you can store numbers for easy dialing. You can store a second number on each key if you press Shift and the One-Touch Key together.

Out of Paper Reception

Receives faxes into the machine's memory when the machine is out of paper.

Overseas Mode

Makes temporary changes to the fax tones to accommodate noise and static on overseas phone lines.

Paging

This feature enables your machine to call your pager when a fax is received into its memory. The machine will also page for voice messages.

Pause

Allows you to place a 3.5 second delay in the dialing sequence stored on One-Touch and Speed-Dial numbers. Press **Redial/Pause** as many times as needed for longer pauses.

Polling

The process of a fax machine calling another fax machine to retrieve waiting a fax.

Pulse (Canada only)

A form of rotary dialing on a telephone line.

Quick Dial List

A listing of names and numbers stored in One-Touch and Speed-Dial memory, in numerical order.

Real Time Transmission

When memory is full, you can send faxes in real time.

Remaining jobs

You can check which jobs are waiting in memory and cancel jobs individually.

Remote Access Code

Your own four-digit code (---*) that allows you to call and access your machine from a remote location.

Remote Retrieval Access

The ability to access your machine remotely from a touch tone phone.

Resolution

The number of vertical and horizontal lines per inch. See: Standard, Fine, Super Fine and Photo.

Ring Delay

The number of rings before the machine answers in Fax Only and Fax/Tel modes.

Ring Volume

Volume setting for the machine's ring.

Scanning

The process of sending an electronic image of a paper document into your computer.

Search

An electronic, alphabetical listing of stored One-Touch, Speed-Dial and Group numbers.

Speed-Dial

A pre-programmed number for easy dialing. You must press **Search/Speed Dial**, #, the two digit code, and **Black Start** or **Color Start** to start the dialing process.

Standard resolution

203 × 97 dpi. It is used for regular size text and quickest transmission.

Station ID

The stored information that appears on the top of faxed pages. It includes the sender's name and fax number.

Super Fine resolution

392 × 203 dpi. Best for very small print and line art.

TAD (telephone answering device)

You can connect an external device or answering machine to the EXT. jack of your machine.

**Telephone Answer Code
(For Fax/Tel mode only)**

When the machine answers a voice call, it pseudo/double-rings. You can pick up at an extension phone by pressing this code (**# 5 1**).

Temporary settings

You can choose certain options for each fax transmission and copy without changing the default settings.

Tone

A form of dialing on the telephone line used for Touch Tone telephones.

Transmission

The process of sending faxes over the phone lines from your machine to the receiving fax machine.

Transmission Verification Report

A printed report for each fax sent, that shows its date, time and number.

User Settings

A printed report that shows the current settings of the machine.

- A**
-
- Accessories and supplies iii
 - ADF
(automatic document feeder) 8, 28, 40
 - Answering machine (TAD) 45
 - connecting 46
 - Apple® Macintosh® 127
 - See Software User's Guide on the CD-ROM.
 - Automatic
 - fax receive 34
 - Easy Receive 37
- B**
-
- Broadcasting 28
 - setting up Groups for 53
 - Brother
 - accessories and supplies iii
 - Brother numbers i
 - Customer Service ii
 - FAQs (frequently asked questions) i
 - fax back system ii
 - product support ii
 - Service center locations ii
 - Solutions Center i, 127
 - warranties iv, v, vii
- C**
-
- Caller ID 44
 - print list 44
 - view list 44
 - Canceling
 - Fax Forwarding 60, 63
 - Fax Storage 60
 - jobs awaiting redial 32
 - Paging 60, 63
 - Cleaning
 - paper pick-up roller 106
 - print head 106
 - printer platen 105
 - scanner 105
 - Connecting
 - external TAD 45
 - external telephone 48
 - two-line external TAD or telephone 47
 - Consumable items 129
 - Control panel overview 5
 - ControlCenter
 - See Software User's Guide on the CD-ROM.
 - Copy
 - color adjustment 75
 - enlarge/reduce 71
 - enter Copy mode 70
 - keys 70
 - multiple 70
 - paper 75
 - quality 71
 - single 70
 - sort 74
 - temporary settings 70
 - using ADF 70
 - Copy Options key (copying)
 - paper size 76
 - paper type 75
 - Cordless handset (FAX-1960C)
 - See Digital Cordless Handset User's Guide.
 - Cordless phone (non-Brother) 49
 - Custom telephone features on a single line 93
- D**
-
- Dialing
 - a pause 51
 - access codes and credit card numbers 53, 54
 - Groups 28
 - manual 50
 - One-Touch 50
 - Speed-Dial 50
 - Distinctive Ring 42
 - setting ring pattern 43
 - turning off 43
 - Dual Access 31

E

Easy Receive	37
Envelopes	11, 13, 15
Error messages on LCD	95
Change Unable	95
Clean Unable	95
Comm. Error	95
Init. Unable	95
Ink Empty	96
Near Empty	96
No Paper Fed	96
Not Registered	50
Out of Memory	97
Print Unable	95
Scan Unable	95
Tel Disabled	98
Extension telephone, using	49
External telephone, connecting	48

F

Fax codes	
changing	49, 61
Fax Receive Code	37, 49
Remote Access Code	61
Telephone Answer Code	49
Fax Forwarding	
changing remotely	62, 63
programming a number	59
Fax Storage	60
turning off	62
turning on	60
Fax, from PC	
See Software User's Guide on the CD-ROM.	
Fax, stand-alone	
receiving	34
at end of conversation	36, 38
difficulties	90, 92
Easy Receive	37
F/T Ring Time, setting	37
Fax Forwarding	63
from extension phone	49
Paging	59
phone line interference	101

Receive Mode, choosing	34
reducing to fit on paper	38
retrieving from a remote site	62
Ring Delay, setting	37
sending	28, 67
at end of conversation	33
Broadcasting	28
canceling from memory	32
color fax	28
contrast	30
delayed batch transmission	32
delayed fax	32
enter Fax mode	28
from memory (Dual Access)	31
manual	33
overseas	31
phone line interference	101
Real Time Transmission	31
Resolution	30

Fax/Tel mode

answering at extension phones	49
double-ringing (voice calls)	37
F/T Ring Time	37
Fax Receive Code	49
Ring Delay	37
Telephone Answer Code	49
FCC notices	86

G

Gray scale	124, 126
Groups for Broadcasting	53

H

HELP

LCD messages	111
using menu keys	112
Menu Table	111, 113

I

Ink cartridges

checking ink volume	108
ink dot counter	102, 103
replacing	102

J

Jacks	
convert to RJ11 jack	
triplex adapter	47
EXT	
external telephone	45
TAD (answering machine)	45
Jams	
document	98
paper	99

L

LCD (liquid crystal display)	111, 112
Contrast	22
Help List	66

M

Macintosh®	
See Software User's Guide on the	
CD-ROM.	
Maintenance, routine	102
Manual	
dialing	50
receive	34
transmission	33
Memory Storage	111
Menu Table	111
Message Center mode	55
erasing messages	57
Fax/Tel OGM (announcement)	56
Msg Ctr OGM (outgoing message)	55
playing voice messages	56
printing faxes from memory	57
setting up	55
Mode, entering	
Copy	70
Fax	28
Scan	7
Multi-line connections (PBX)	48

O

One-Touch	
changing	53
setting up	52
using	50
Out of Area (Caller ID)	44
Out of Memory message	33

P

Packing and shipping the machine	109
Paging	59
Paper	9, 123
capacity	12
document size	8, 28
loading	13, 15
size	11, 20
type	11, 19
PaperPort® SE with OCR	
See Software User's Guide on the	
CD-ROM.	
Phone line	
connections	46
difficulties	92
multi-line (PBX)	48
roll over lines	47
two-line phone system	47
Phone line interference	101
Photo paper	9, 10, 12, 73
Power failure	111
Print	
area	17
checking alignment	108
difficulties	90, 92
drivers	127
improving quality	106, 107
paper jams	99
reports	66
resolution	127
specifications	127
Printing	
See Software User's Guide on the	
CD-ROM.	
Programming your machine	111, 112

Q

Quality (copying)	70
Quick-Dial	
Access codes and credit card numbers	53, 54
Broadcasting	28
using Groups	28
Group dial	
changing	53
setting up Groups for Broadcasting	53
One-Touch	
changing	53
setting up	52
using	50
Search	51
Speed-Dial	
changing	53
setting up	52
using	50

R

Receive Mode	34
External TAD	34
Fax Only	34
Fax/Tel	34
Manual	34
Redial/Pause	51
Reducing	
copies	71
incoming faxes	38
Remote Retrieval	61
access code	61
commands	63
getting your faxes	39, 62
Remote Setup	
See Software User's Guide on the CD-ROM.	
Reports	65
Caller ID List	44
Fax Journal	66
Journal Period	65
Help List	66
how to print	66
Quick-Dial List	66
Transmission Verification	65, 66
User Settings	66

Resolution

copy	126
fax	124
print	127
scan	126
setting for next fax	30
Ring Delay, setting	37

S

Safety Instructions	84
Scanning (MFC-3360C only)	
See Software User's Guide on the CD-ROM.	
Serial Number	
how to find	See inside front cover
Shipping the machine	109
Speaker Phone (FAX-1960C)	6
Speed-Dial	
changing	53
setting up	52
using	50

T

TAD (telephone answering device),	
external	34, 45, 47
connecting	45, 46
receive mode	34
recording OGM	46
with two-line jack	47
Temporary copy settings	70
Text, entering	120
special characters	120
Transferring your faxes or Fax Journal ...	98
Transparencies	9, 10, 12, 123
Troubleshooting	90
checking ink volume	108
document jam	98
error messages on LCD	95
if you are having difficulty	
copying	94
document jam	98
incoming calls	93
phone line or connections	92
printing	90
printing receiving faxes	92
receiving faxes	92

scanning	94
sending faxes	93
software	94
paper jam	99
print quality	106, 107
Two-line phone system	47
TX Lock	24

V

Volume, setting

beeper	20
handset	21
amplify (for hearing-impaired)	21
ring	20
speaker	20

W

Warranties	iv
Canada	vii
Notice-Disclaimer	iv
USA	v
Windows®	
See Software User's Guide on the CD-ROM.	
World Wide Web	i

EQUIPMENT ATTACHMENT LIMITATIONS (Canada only)

NOTICE

This product meets the applicable Industry Canada technical specifications.

NOTICE

The Ringer Equivalence Number is an indication of the maximum number of devices allowed to be connected to a telephone interface. The termination on an interface may consist of any combination of devices subject only to the requirement that the sum of the RENs of all the devices does not exceed five.

Brother International Corporation
100 Somerset Corporate Boulevard
P.O. Box 6911
Bridgewater, NJ 08807-0911 USA
Brother International Corporation (Canada) Ltd.
1 rue Hôtel de Ville,
Dollard-des-Ormeaux, QC, Canada H9B 3H6

brother[®]

**Visit us on the World Wide Web
<http://www.brother.com>**

These machines are made for use in the USA and Canada only. We cannot recommend using them overseas because it may violate the Telecommunications Regulations of that country and the power requirements of your machine may not be compatible with the power available in foreign countries. **Using USA or Canada models overseas is at your own risk and may void your warranty.**

USA/CAN

Free Manuals Download Website

<http://myh66.com>

<http://usermanuals.us>

<http://www.somanuals.com>

<http://www.4manuals.cc>

<http://www.manual-lib.com>

<http://www.404manual.com>

<http://www.luxmanual.com>

<http://aubethermostatmanual.com>

Golf course search by state

<http://golfingnear.com>

Email search by domain

<http://emailbydomain.com>

Auto manuals search

<http://auto.somanuals.com>

TV manuals search

<http://tv.somanuals.com>