

Sonata

NP30

 **Cambridge Audio**

Your music + our passion

Contents

Introduction	2
Important safety instructions	3
Wi-Fi information	4
Limited warranty.....	5
Rear panel connections.....	6
Front panel controls.....	7
Remote control.....	8
Overview	9
Getting connected.....	9
Operating the NP30.....	10
Settings menu.....	13
UuVol Remote.....	14
Troubleshooting.....	15
Technical specifications	15

Important!

The NP30 is largely a software based product and new features and updates will be made available from time to time. See the Upgrade Firmware section at the end of this manual for how to check for and then automatically update your unit via the internet. The process takes only a few minutes.

We would encourage you to check for any updates before using your NP30 for the first time and then from time to time afterwards.

Also please do check the support page for the NP30 at <http://support.cambridgeaudio.com> for details of any new features, advice on compatibility with other products and audio formats and the most recent copy of this manual.

Make sure you register your purchase.

Visit: www.cambridge-audio.com/sts

By registering, you'll be the first to know about:

- Future product releases
- Software upgrades
- News, events and exclusive offers plus competitions!

This guide is designed to make installing and using this product as easy as possible. Information in this document has been carefully checked for accuracy at the time of printing; however, Cambridge Audio's policy is one of continuous improvement, therefore design and specifications are subject to change without prior notice.

This document contains proprietary information protected by copyright. All rights are reserved. No part of this manual may be reproduced by any mechanical, electronic or other means, in any form, without prior written permission of the manufacturer. All trademarks and registered trademarks are the property of their respective owners.

© Copyright Cambridge Audio Ltd 2011.

Cambridge Audio and the Cambridge Audio logo are trademarks of Cambridge Audio.

UuVol is a trademark of Audio Partnership Plc and is registered in the European Community and other countries.

Other brands mentioned are trademarks of their respective owners and are used for reference purposes only.

Cambridge Audio's policy of continuous improvement means design and specification may change without notice.

Introduction

Thank you for purchasing your Sonata NP30 Network Music Player. We are confident that you will enjoy many years of listening pleasure from it. Like all Cambridge Audio products the Sonata NP30 adheres to three core principles – stunning performance, ease of use and incredible value.

The Sonata NP30 can access a wide range of audio from UPnP servers or local media and directly from the internet such as from our own UuVol Internet Radio service or Streaming Services from other suppliers.

The free UuVol Radio service brings the best iRadio stations to your NP30 checked by us for reliability and sound quality with over 15,000 stations currently available and more being added each day.

Our UuVol.com website allows you to suggest new stations, manage your favourites and other settings for several UuVol enabled devices at once, find out about new features and Streaming Services as we add them and more. See UuVol.com for more details.

Streaming Services are services that come from partner suppliers. These usually require a subscription from them with different services being available in different countries.

In addition to pure internet content you can access your own locally stored music from USB flash-disks or hard-drives and network connected UPnP servers.

Various compressed formats are supported plus losslessly compressed and uncompressed PCM/WAV up to 'better-than-CD' 24 bit content at 24/96 which can be obtained from suitable download sites. Podcasts are also supported.

High quality components are used throughout including a WM8728 24 bit / 96kHz digital to analog converter (DAC) from renowned manufacturer Wolfson.

A proprietary audio buffering and re-clocking scheme re-constructs all incoming audio clocks inside the NP30 with a set of precision oscillators eliminating jitter and providing unprecedented sound quality.

The Sonata NP30 also features an environmentally friendly low power (<1w) standby circuit.

We have also developed a free iPhone/iPod Touch application that allows full wireless control of the NP30 (in conjunction with a Wi-Fi network).

Search for UuVol Remote on the Apple App Store or browse www.UuVol.com for further details on this and other Apps and features as they become available.

Ultimate sound quality depends on the whole of your system, naturally we particularly recommend speakers from the Cambridge Audio Sirocco range as these have been designed to the same exacting standards as this product.

Your dealer can also supply excellent quality Cambridge Audio interconnects to ensure your system realises its full potential.

Thanks for taking the time to read this manual; we do recommend you keep it for future reference.

Matthew Bramble

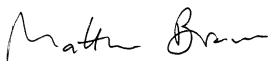

Cambridge Audio Technical Director
and the Sonata range development team

Important safety instructions

For your own safety please read the following important safety instructions carefully before attempting to connect this unit to the mains power supply. They will also enable you to get the best performance from and prolong the life of the unit:

1. Read these instructions.
2. Keep these instructions.
3. Heed all warnings.
4. Follow all instructions.
5. Do not use this apparatus near water.
6. Clean only with a dry cloth.
7. Do not block any ventilation openings. Install in accordance with the manufacturer's instructions.
8. Do not install near any heat sources such as radiators, heat registers, stoves, or other apparatus (including amplifiers) that produce heat.
9. Do not defeat the safety purpose of the polarized or grounding-type plug. A polarized plug has two blades with one wider than the other. A grounding-type plug has two blades and a third grounding prong. The wide blade or the third prong are provided for your safety. If the provided plug does not fit into your outlet, consult an electrician for replacement of the obsolete outlet.
10. Protect the power cord from being walked on or pinched, particularly at plugs, convenience receptacles and the point where they exit from the apparatus.
11. Only use attachments/accessories specified by the manufacturer.
12. Use with only the cart, stand, tripod, bracket, or table specified by the manufacturer, or sold with the apparatus. When a cart is used, use caution when moving the cart/ apparatus combination to avoid injury from tip-over. 
13. Unplug this apparatus during lightning storms or when unused for long periods of time.
14. Refer all servicing to qualified service personnel. Servicing is required when the apparatus has been damaged in any way, such as the power-supply cord or plug having been damaged, liquid has been spilled or objects have fallen into the apparatus, the apparatus has been exposed to rain or moisture, does not operate normally, or has been dropped.

WARNING

- To reduce the risk of fire or electric shock, do not expose this unit to rain or moisture.
- Batteries (battery pack or batteries installed) shall not be exposed to excessive heat such as sunshine, fire or the like.

The unit must be installed in a manner that makes disconnection of the mains plug from the mains socket outlet (or appliance connector from the rear of the unit) possible. Where the mains plug is used as the disconnect device, the disconnect device shall remain readily operable. Only use the mains cord supplied with this unit.

Please ensure there is ample ventilation (at least 10cm clearance all round). Do not put any objects on top of this unit. Do not situate it on a rug or other soft surface and do not obstruct any air inlets or outlet grilles. Do not cover the ventilation grilles with items such as newspapers, tablecloths, curtains, etc.

This unit must not be used near water or exposed to dripping or splashing water or other liquids. No objects filled with liquid, such as vases, shall be placed on the unit.



CAUTION

Risk of electric shock.
Do not open.

AVIS

Risque de choc électrique.
Ne pas ouvrir.

ACHTUNG

Vorm öffnen des Gerätes.
Netzstecker ziehen.



The lightning flash with the arrowhead symbol within an equilateral triangle is intended to alert the user to the presence of un-insulated 'dangerous voltage' within the product's enclosure that may be of sufficient magnitude to constitute a risk of electric shock to persons.

The exclamation point within an equilateral triangle is intended to alert the user to the presence of important operating and maintenance instructions in the service literature relevant to this appliance.



The symbol on this product indicates that it is of CLASS II (double insulated) construction.



WEEE symbol

The crossed-out wheeled bin is the European Union symbol for indicating separate collection for electrical and electronic equipment. This product contains electrical and electronic equipment which should be reused, recycled or recovered and should not be disposed of with unsorted regular waste. Please return the unit or contact the authorised dealer from whom you purchased this product for more information.



CE mark

This product complies with European Low Voltage (2006/95/EC), Electromagnetic Compatibility (2004/108/EC) and Environmentally-friendly design of Energy-related Products (2009/125/EC) Directives when used and installed according to this instruction manual. For continued compliance only Cambridge Audio accessories should be used with this product and servicing must be referred to qualified service personnel.



C-Tick mark

This product meets the Australian Communications Authority's Radio communications and EMC requirements.



Gost-R Mark

This product meets Russian electronic safety approvals.

Important safety instructions cont.

Ventilation

IMPORTANT – The unit will become hot when in use. Do not stack multiple units on top of each other. Do not place in an enclosed area such as a bookcase or in a cabinet without sufficient ventilation.

Ensure that small objects do not fall through any ventilation grille. If this happens, switch off immediately, disconnect from the mains supply and contact your dealer for advice.

Positioning

Choose the installation location carefully. Avoid placing it in direct sunlight or close to a source of heat. No naked flame sources, such as lighted candles, should be placed on the unit. Also avoid locations subject to vibration and excessive dust, cold or moisture. The unit can be used in a moderate climate.

This unit must be installed on a sturdy, level surface. Do not place in a sealed area such as a bookcase or in a cabinet. Do not place the unit on an unstable surface or shelf. The unit may fall, causing serious injury to a child or adult as well as serious damage to the product. Do not place other equipment on top of the unit.

Due to stray magnetic fields, turntables or CRT TVs should not be located nearby due to possible interference.

Electronic audio components have a running in period of around a week (if used several hours per day). This will allow the new components to settle down and the sonic properties will improve over this time.

Power sources

The unit should be operated only from the type of power source indicated on the marking label. If you are not sure of the type of power-supply to your home, consult your product dealer or local power company.

This unit can be left in Standby mode when not in use and will draw <1W in this state. To turn the unit off, switch off at the rear panel. If you do not intend to use this unit for a long period of time, unplug it from the mains socket.

Overloading

Do not overload wall outlets or extension cords as this can result in a risk of fire or electric shock. Overloaded AC outlets, extension cords, frayed power cords, damaged or cracked wire insulation and broken plugs are dangerous. They may result in a shock or fire hazard.

Be sure to insert each power cord securely. To prevent hum and noise, do not bundle the interconnect leads with the power cord or speaker leads.

Cleaning

To clean the unit, wipe its case with a dry, lint-free cloth. Do not use any cleaning fluids containing alcohol, ammonia or abrasives. Do not spray an aerosol at or near the unit.

Battery disposal

Batteries may contain substances harmful to the environment. Please dispose of any discharged batteries with due consideration and in accordance with local environmental/electronic recycling guidelines.

Servicing

These units are not user serviceable. Never attempt to repair, disassemble or reconstruct the unit if there seems to be a problem. A serious electric shock could result if this precautionary measure is ignored. In the event of a problem or failure, please contact your dealer.

Wi-Fi information

FCC Statement

DECLARATION OF CONFORMITY WITH FCC RULES FOR ELECTROMAGNETIC COMPATIBILITY

We, Cambridge Audio, of Gallery Court, Hankey Place, London SE1 4BB, declare under our sole responsibility that this device,

Sonata NP30 with Wi-Fi module

to which this declaration relates, complies with Part 15 of the FCC Rules. Operation is subject to the following two conditions: (1) this device may not cause harmful interference, and (2) this device must accept any interference received, including interference that may cause undesired operation.

Caution: Exposure to Radio Frequency Radiation.

The device shall be used in such a manner that the potential for human contact during normal operation is minimized.

When connecting an external antenna to the device, the antenna shall be placed in such a manner to minimize the potential for human contact during normal operation. This transmitter must not be co-located or operating in conjunction with any other antenna or transmitter.

Federal Communications Commission Notice

This equipment has been tested and found to comply with the limits for a Class B digital device, pursuant to Part 15 of the FCC Rules. These limits are designed to provide reasonable protection against harmful interference in a residential installation.

This equipment generates, uses, and can radiate radio frequency energy, and if not installed and used in accordance with the instructions, may cause harmful interference to radio communications. However, there is no guarantee that interference will not occur in a particular installation. If this equipment does cause harmful interference to radio or television reception, which can be determined by turning the equipment off and on, the user is encouraged to try and correct the interference by one or more of the following measures:

- Reorient or relocate the receiving antenna.
- Increase the distance between the equipment and the receiver.
- Connect the equipment to an outlet on a circuit different from that to which the receiver is connected.
- Consult the dealer or an experienced radio/TV technician for help.

FCC Caution: Any changes or modifications not expressly approved by the party responsible for compliance could void the user's authority to operate this equipment.

IMPORTANT NOTE:

FCC Radiation Exposure Statement:

This equipment complies with FCC radiation exposure limits set forth for an uncontrolled environment. This equipment should be installed and operated with a minimum distance of 20cm between the radiator and your body.

This transmitter must not be co-located or operating in conjunction with any other antenna or transmitter.

2.4GHz operation of this product in the USA is firmware-limited to channels 1 through 11.

Modifications

The FCC requires the user to be notified that any changes or modifications to this device that are not expressly approved by Cambridge Audio, may void the user's authority to operate the equipment.

Canada-Industry Canada (IC)

The wireless radio of this device complies with RSS 210 Industry Canada. This Class B digital apparatus complies with Canadian ICES-003. Operation is subject to the following two conditions:

- 1) this device may not cause interference, and
- 2) this device must accept any interference, including interference that may cause undesired operation of the device.

IMPORTANT NOTE:

IC Radiation Exposure Statement:

This equipment complies with Canada radiation exposure limits set forth for uncontrolled environments. This equipment should be installed and operated with a minimum distance of 20cm between the radiator and your body.

This transmitter must not be co-located or operating in conjunction with any other antenna or transmitter.

Cet appareil numérique de la classe B conforme á la norme NMB-003 du Canada.

Europe-European Union Notice

Radio products with the CE 0889 or CE alert marking comply with the R&TTE Directive (1995/5/EC) issued by the Commission of the European Community.

Compliance with this directive implies conformity to the following European Norms.

- EN 60950-1 – Product Safety.
- EN 300 328 – Technical requirement for radio equipment.
- EN 301 489 – General EMC requirements for radio equipment.

To determine the type of transmitter, check the identification label on your Cambridge Audio product.

Products with the CE marking comply with European Low Voltage (2006/95/EC), Electromagnetic Compatibility (2004/108/EC) and Environmentally-friendly design of Energy-related Products (2009/125/EC) Directives issued by the Commission of the European Community. Compliance with these directives implies conformity to the following European Norms.

- EN 55022 – Electromagnetic Interference.
- EN 55024 – Electromagnetic Immunity.
- EN 61000-3-2 – Power Line Harmonics.
- EN 61000-3-3 – Power Line Flicker.
- EN 60950-1 – Product Safety Products that contain the radio transmitter are labeled with CE 0889 or CE alert marking and may also carry the CE logo.
- EN 62301:2005 - Household electrical appliances. Measurement of standby power.
- 1275/2008 - Implementing EuP Directive for Standby Power Consumption.

Plug Fitting Instructions (UK only)

The cord supplied with this appliance is factory fitted with a UK mains plug fitted with a 3 amp fuse inside. If it is necessary to change the fuse, it is important that a 3 amp one is used. If the plug needs to be changed because it is not suitable for your socket, or becomes damaged, it should be cut off and an appropriate plug fitted following the wiring instructions below. The plug must then be disposed of safely, as insertion into a mains socket is likely to cause an electrical hazard. Should it be necessary to fit a 3-pin BS mains plug to the power cord the wires should be fitted as shown in this diagram. The colours of the wires in the mains lead of this appliance may not correspond with the coloured markings identifying the terminals in your plug. Connect them as follows:

The wire which is coloured BLUE must be connected to the terminal which is marked with the letter 'N' or coloured BLACK.

The wire which is coloured BROWN must be connected to the terminal which is marked with the letter 'L' or coloured RED.

The wire which is coloured GREEN/YELLOW must be connected to the terminal which is marked with the letter 'E' or coloured GREEN.

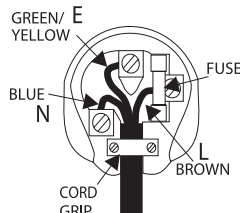

If a standard 13 amp (BS 1363) plug is used, a 5 amp fuse must be fitted, or if any other type of plug is used a 5 amp fuse must be fitted, either in the plug or adaptor, or on the distribution board.

Limited warranty

Cambridge Audio warrants this product to be free from defects in materials and workmanship (subject to the terms set forth below). Cambridge Audio will repair or replace (at Cambridge Audio's option) this product or any defective parts in this product. Warranty periods may vary from country to country. If in doubt consult your dealer and ensure that you retain proof of purchase.

To obtain warranty service, please contact the Cambridge Audio authorised dealer from which you purchased this product. If your dealer is not equipped to perform the repair of your Cambridge Audio product, it can be returned by your dealer to Cambridge Audio or an authorised Cambridge Audio service agent. You will need to ship this product in either its original packaging or packaging affording an equal degree of protection.

Proof of purchase in the form of a bill of sale or receipted invoice, which is evidence that this product is within the warranty period, must be presented to obtain warranty service.

This Warranty is invalid if (a) the factory-applied serial number has been altered or removed from this product or (b) this product was not purchased from a Cambridge Audio authorised dealer. You may call Cambridge Audio or your local country Cambridge Audio distributor to confirm that you have an unaltered serial number and/or you made a purchase from a Cambridge Audio authorised dealer.

This Warranty does not cover cosmetic damage or damage due to acts of God, accident, misuse, abuse, negligence, commercial use, or modification of, or to any part of, the product. This Warranty does not cover damage due to improper operation, maintenance or installation, or attempted repair by anyone other than Cambridge Audio or a Cambridge Audio dealer, or authorised service agent which is authorised to do Cambridge Audio warranty work. Any unauthorised repairs will void this Warranty. This Warranty does not cover products sold AS IS or WITH ALL FAULTS.

REPAIRS OR REPLACEMENTS AS PROVIDED UNDER THIS WARRANTY ARE THE EXCLUSIVE REMEDY OF THE CONSUMER. CAMBRIDGE AUDIO SHALL NOT BE LIABLE FOR ANY INCIDENTAL OR CONSEQUENTIAL DAMAGES FOR BREACH OF ANY EXPRESS OR IMPLIED WARRANTY IN THIS PRODUCT. EXCEPT TO THE EXTENT PROHIBITED BY LAW, THIS WARRANTY IS EXCLUSIVE AND IN LIEU OF ALL OTHER EXPRESS AND IMPLIED WARRANTIES WHATSOEVER INCLUDING, BUT NOT LIMITED TO, THE WARRANTY OF MERCHANTABILITY AND FITNESS FOR A PRACTICAL PURPOSE.

Some countries and US states do not allow the exclusion or limitation of incidental or consequential damages or implied warranties so the above exclusions may not apply to you. This Warranty gives you specific legal rights, and you may have other statutory rights, which vary from state to state or country to country.

For any service, in or out of warranty, please contact your dealer.

Rear panel connections

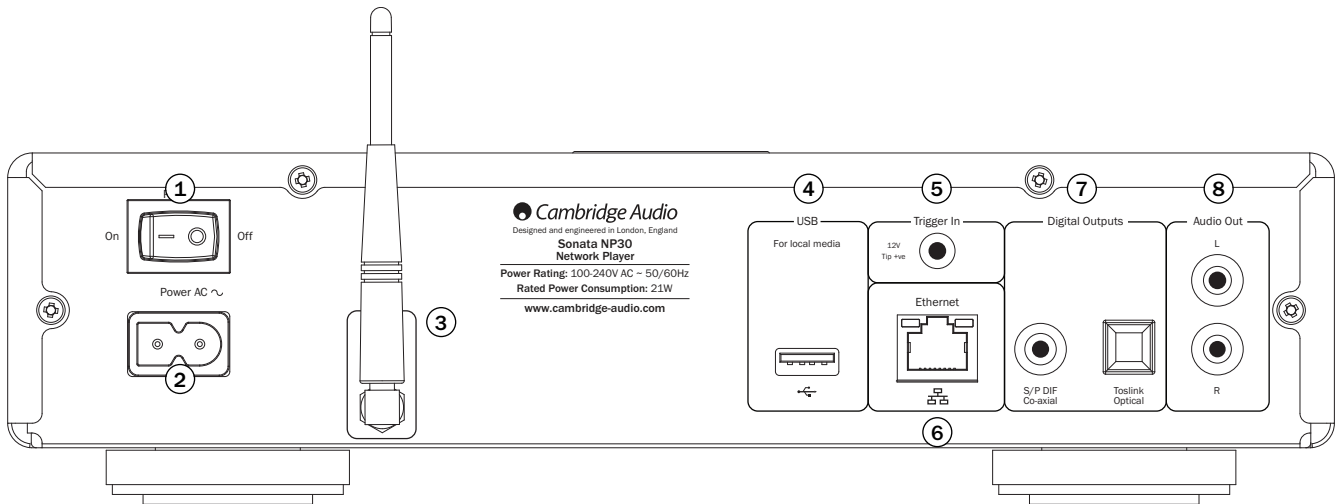

① Power On/Off

Switches the unit on or off.

② AC power socket

Once you have completed all connections to the amplifier, plug the AC power cable into an appropriate mains socket and turn the unit on. Your unit is now ready for use.

③ Wireless antenna

Should be in the upright position as shown. Allows connection to 802.11b/g or n networks (2.4 GHz will only be used for n networks).

④ USB

Use to connect a USB storage device or another portable device that is USB HD/flashdisk compatible containing music files. 500mA maximum current capability.

⑤ Trigger In

The Sonata NP30 can be turned on and off (i.e. brought in and out of Standby mode) by a trigger voltage connected to the Trigger In. A transition from or to 5-12 DC will turn the Sonata NP30 on. Another transition from or to 5-12 DC will put the Sonata NP30 into Standby mode. The matching Sonata AR30 or DR30+ receivers' feature a trigger output suitable for this purpose which allows the Sonata NP30 to be automatically powered up when Aux is selected on the Sonata AR30/DR30+.

⑥ Ethernet

Ethernet port for connecting to a 10/100BASE-T local area network (LAN).

⑦ Digital Outputs

S/P DIF co-axial digital output – For output to a separate DAC, such as Cambridge Audio DacMagic*. To obtain best results, use a high quality 75ohm digital RCA interconnect cable (not one designed for normal audio use).

TOSLINK Optical digital output – For output to a separate DAC*. Use a high quality TOSLINK fibre optic interconnect cable.

Note: To obtain the best results from your system we recommend using only high quality Cambridge Audio interconnects. This will ensure that you hear your system as we designed it. Please ask your dealer for details.

* For more information, see the DacMagic page on the Cambridge Audio website: www.cambridgeaudio.com/products.php

⑧ Audio output

Use good quality inter-connect cables from these sockets to any line level input on your amplifier (Aux, CD, Tape, etc.).

For the matching Sonata AR30/DR30 receivers, always use the Aux input as this corresponds to the NP button on the NP30 remote control.

Front panel controls

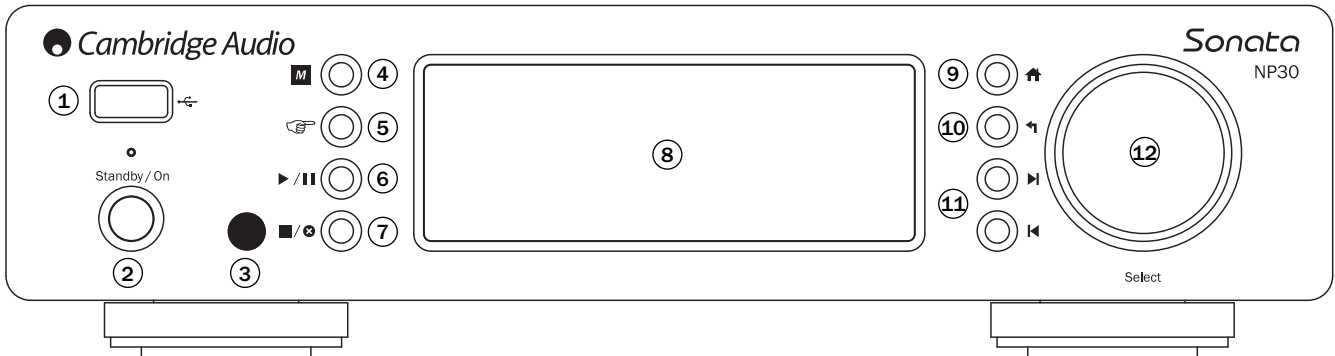

① USB

Use to connect a USB storage device or another portable device containing music files. 500mA maximum current consumption.

② Standby/On

When powering up from standby the Standby/On LED will flash approximately once a second as the unit boots up, the display will initially be blank before 'Starting...' appears. Note the startup sequence can take **approximately 30 seconds** to complete.

③ Infrared sensor

Receive IR commands from the supplied remote control. A clear unobstructed line of sight between the remote control and the sensor is required.

④ M (Memory)

Press to access the Memory features for preset recall and storage.

The Sonata NP30 can store up to 20 Presets which can be Internet Radio stations, Streams from Streaming Services or your own choice of Internet Radio URL. See later section.

⑤ (Reply)

This is the reply/interactive button. Press when listening to an Internet Radio station or Streaming Service that has some form of interaction with the user. This function will bring up an interactive menu (where available). This feature is commonly used allow indication that you like or don't like the current stream so the service can tailor the music served to your personal taste.

For Media playback (UPnP or Local) this button will toggle between the 'Now Playing' display and the current media browsing display.

⑥ ▶ / || Play/Pause

Plays and pauses playback.

⑦ ■ / ✕ Stop/Delete

Press during playback to stop or press in various menus to delete the present item.

⑧ Display

Displays the status of the unit.

⑨ ⬆ Home

Go directly to the top Home Menu.

⑩ ⬅ Return

Press to return to the previous menu.

⑪ ⏮ ⏭ Skip

Press once to skip forwards or backwards one track.

⑫ Navigation/Select (rotary dial)

Rotate to navigate around the menus. Pressing the rotary dial in will activate the 'Select' function to accept the item/function shown on the display.

Remote control

Important!

The default mode for the remote allows combined control of the NP30 and Cambridge Audio Azur range amplifiers.

The remote can be set to control the Cambridge Audio Sonata range receivers (AR30/DR30) or Cambridge Audio A/V Receivers instead. See later section on this page.

Standby/On

Switches the NP30 between On and low power eco-friendly Standby mode.

Note: The NP30 takes approximately 30 seconds to come out of Standby, during this time the front panel Standby/On LED will flash but nothing will be shown on the display.

0-9 numeric buttons

Press to recall stored presets.

-/- Numerical select

To recall a preset number greater than ten, press -/- followed by the required preset number.

(Memory)

Press to access the Memory features for preset recall and storage.

The Sonata NP30 can store up to 20 Presets which can be Internet Radio stations, Streams from Streaming Services or your own choice of Internet Radio URL. See later section.

Home

Go directly to the top Home Menu.

Return

Press to return to the previous menu.

Navigation

Press to navigate around the NP30's menus.

When in AR30/DR30 tuner mode, press to step through the preset stations.

When in AR30/DR30 iPod (MP3) mode press to browse your iPod's contents.

Enter

Press to accept the item/function highlighted in the display menu, or while navigating your iPod. In tuner mode, press and hold to store the current station in the preset bank.

Note: If browsing through DAB stations, press Select to immediately tune to the current station (DR30+ only).

(Reply)

This is the reply/interactive button. Press when listening to an Internet Radio station or Streaming Service that has some form of interaction with the user. This function will bring up an interactive menu (where available). This feature is commonly used allow indication that you like or don't like the current stream so the service can tailor the music served to your personal taste.

For Media Play back (UPnP or Local) this button will toggle between the 'Now Playing' display and the current media browsing display.

(info)

Changes the display to show information about the currently playing track.

Skip

Press once to skip forwards or backwards one track.

Stop/Delete

Press once to stop media playback. Also used to delete items where appropriate (press and hold).

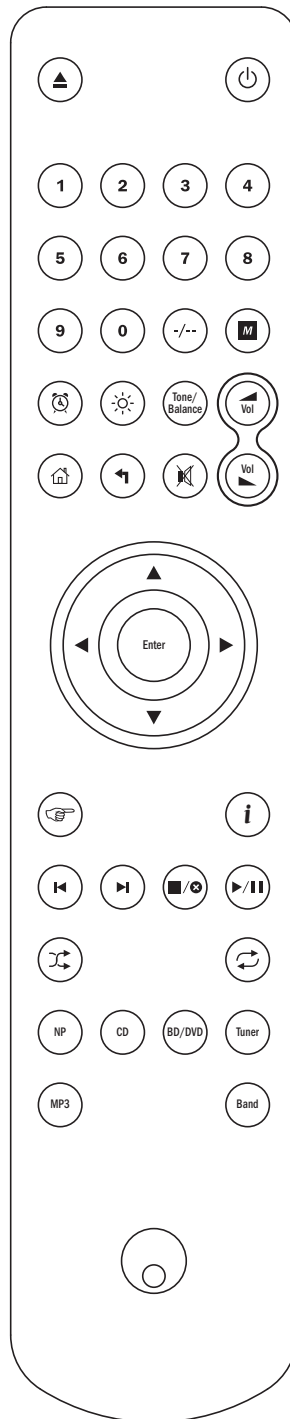

Play/Pause

Press once to start media playback. Press and hold to pause media playback.

Shuffle

Press to turn the random/shuffle playback function on and off.

Repeat

Press to turn repeat playback function (media play back only) on and off.

Changing the remote control functions

To change the remote to control the NP30 and Cambridge Audio Sonata range receivers (AR30/DR30) remove the batteries and wait 3 minutes, now press and hold down the NP button whilst re-inserting the batteries.

To change the remote to control the NP30 and Cambridge Audio A/V Receivers remove the batteries and wait 3 minutes, now press and hold down the CD button whilst re-inserting the batteries.

To return the remote to controlling the NP30 and Cambridge Audio Azur amplifiers remove the batteries and wait 3 minutes, now re-insert the batteries without holding down any buttons.

When in AR30/DR30 mode, note the remote switches functions depending on which source (NP, CD, DVD etc.) you select via the remote only.

To control the NP30 in this mode, first press the NP button on the remote (which also selects the NP source).

To control other functions of an AR30 or DR30+, their built-in tuners and DD30 dock for iPod or a DV30, first press the required source (e.g. MP3 for iPod, DVD for DV30, etc.) to select the right mode.

The following buttons control the function of Cambridge Audio Amplifiers/Receivers.

Volume

Increases or decreases the volume. It is also used to change the value of selected menu settings of the AR30/DR30.

Mute

Mutes the audio. Press again to cancel mute.

Source buttons (NP, CD, BD/DVD, Tuner, MP3)

Press the relevant source button to select desired input source.

Tone/Balance

Press for Tone/Balance adjustment, using the Volume buttons.

The following buttons control the functions of a matching AR30/DR30 2.1 Receiver only.

Alarm/Clock

Press once to enter the Alarm menu. Press and hold to enter the Sleep menu.

Brightness

Switches the display brightness between bright and dim.

Overview

The NP30 is able to receive and play back media from several distinct types of source. Here we have attempted to give an overview of the various types of service available and the terminology you may encounter.

UuVol/UuVol Radio

 UuVol is Cambridge Audio's evolving platform for streaming client devices.

It incorporates amongst other things UuVol Radio our Internet Radio service checked for broadcast reliability and quality and UuVol.com our website/portal.

The portal aspect of our website is the mechanism that allows transparent connection (and update) of all UuVol enabled units to the various services.

The website is our visible presence at www.UuVol.com which amongst other things allows you to also browse and play back the same stations from an internet connected PC and manage your presets and other preferences for your UuVol client products.

You can also add stations to your units that are currently not in the UuVol database, suggest new stations to us and more. There are also links and help for setting up third-party Streaming Services from a wide variety of other suppliers. Other UuVol features will be launched in the future, check the website from time to time to see the latest developments.

Streaming Services

Streaming Services are similar to Internet Radio but come from other suppliers and often have an element of interaction with the user. Because Streaming Services generally allow the user some choice over the content they listen to, they are also licensed differently to iRadio by the music companies and often each service only has arrangements in certain countries and may also charge a subscription for membership.

Examples of such services are Last.FM, Pandora, Rhapsody, Napster and others. All allow some control of the content from 'play me something that sounds like U2' to the ability to select and play whole albums of your choice. Some also offer the ability to download content for use off-line as well.

The NP30 supports many of these services, navigate to Streaming Services on the unit for a list or even better check out our portal at UuVol.com for more details of which services are available in your area, what they do and how to sign up. These services come from third parties and although we support connections to them they do not come from us and we are not responsible for their service in any way. Your account will be with the service, we are merely acting as a portal to make the connection simpler and more convenient plus we support the correct software on our unit to allow playback and browsing of their content.

Network Media

The NP30 supports a wide range of compressed formats; MP3, AAC, WMA and Ogg Vorbis CODEC types are all supported, plus for true audiophile use it also supports either uncompressed PCM (in a WAV container) or losslessly compressed FLAC, both can contain from 16 bits 44.1kHz from CDs right up to 24 bit / 96kHz for better than CD quality from suitable download sites.

Note: For this to work your server will also need to support the CODEC you wish to play as some have limitations and may not serve FLAC for instance. Always check that the server you wish to use also supports your favoured CODECs.

Also for lossless/uncompressed formats both the server and network connection will need to sustain the high bitrate necessary.

Note: It is not recommended to use Wi-Fi connections for content above 16 bits 44.1/48kHz if lossless/uncompressed.

Local Media

The NP30 also supports local media from USB Flash-disks or USB hard-drives and has two USB1.1 ports for this purpose. Here the NP30 simply browses the folders present on the media attached and displays them. Only content that the NP30 can play will be shown. This feature is provided for convenient access to temporary storage devices.

It is however highly recommended that UPnP is used for continued use of stored media as the UPnP system is able to support album art, sophisticated content browsing and filtering and other features not possible with simple folder browsing.

Note: Currently only the FAT32 file system is supported.

Podcasts

Podcasts are archived audio recordings downloadable over the internet. Often podcasts are recordings of previous live broadcasts or episodic content.

The NP30 supports various third party podcast services, navigate to Podcasts on the unit for the list available in your area. In addition the NP30 supports your own personal choice of podcasts where you know its URL (weblink) via the UuVol portal, see later section.

Getting connected

Basic connections

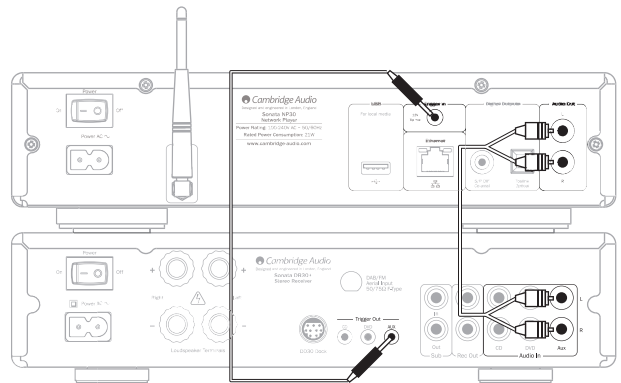

Sonata AR30/DR30+

Network connections

Before you can use your NP30 for iRadio/Streaming you must have the following:

- A broadband internet connection (such as ADSL) to a suitable internet service provider (ISP).
- A network connection either wirelessly via 802.11b/g or n Wi-Fi or wired Ethernet connection (10 or 100 M bits/sec via an RJ45 connection).

Note: If you wish to play 24/48 or 24/96 content from a UPnP server, a wired Ethernet connection will be required as the high data rate of these files is beyond most Wi-Fi networks capability.

In many cases the broadband modem, router and wireless access point will be a single combined unit supplied by your Internet Service Provider or bought from a computer store.

If your wireless network is configured to use Wired Equivalent Privacy (WEP) or Wi-Fi Protected Access (WPA) data encryption then you will need to know your WEP or WPA key so you can get the NP30 to communicate with the network.

IMPORTANT:

Before you continue, make sure that your wireless access point or router is powered up and working with your broadband internet service (use your computer to verify this). To get this part of the system working you must read the instructions supplied with the wireless access point or router.

The NP30 can be configured to connect to a Wired or Wireless network or has a (default) Auto setting. In Auto the NP30 looks for a each connection type and selects whichever is present. You can also force the unit to one or the other connection type, see later Settings section.

Connecting to a wired network

Plug one end of a network cable (Category 5/5E straight through Ethernet cable) into the LAN port on the back of the unit.

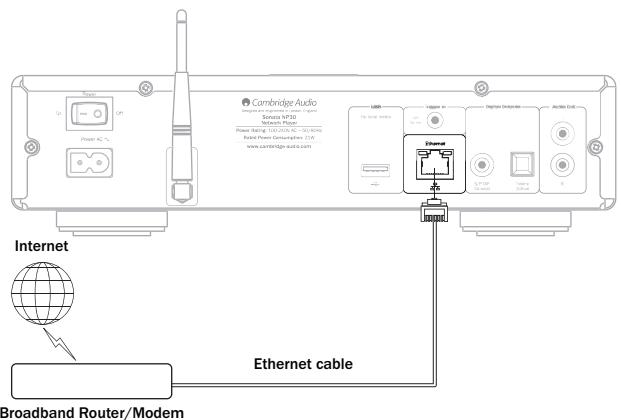

Note: Only connect the LAN port of the player to an Ethernet port that supports 10BASE-T or 100BASE-TX. Connecting to any other ports or jacks, such as a phone jack, can damage the unit

The NP30 should automatically connect to your network as below via DHCP; this means it will be given an IP address by your router automatically.

Getting connected cont.

Connecting to a wireless network

Place the NP30 in range of your wireless network (usually 10-30m of a suitable wireless transmitter, although this is affected by walls and the construction of your building) and turn it on, via the back panel switch and then on the front panel.

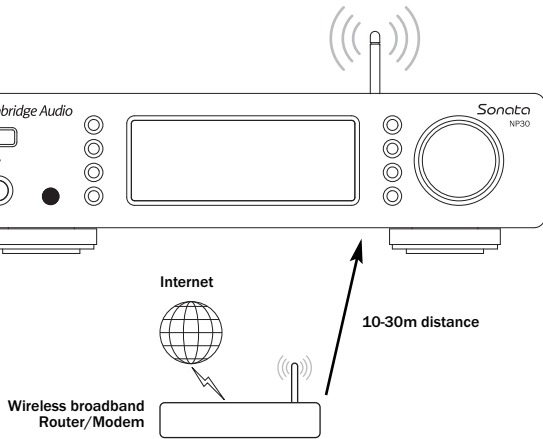

The NP30 will automatically connect and obtain an IP address from your wireless network. For advanced users, if you would like to give your NP30 a static IP address, then see the 'Network config' section of the manual.

Note: If you make a mistake at any point, you can always press the  button to go back to the previous screen.

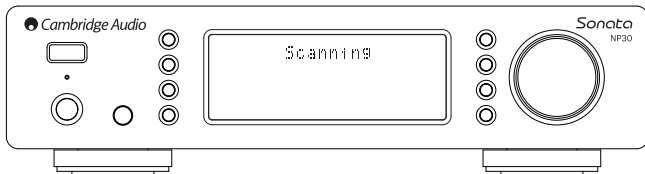

The unit will now scan for all available wireless networks and will display "Scanning". If it can't find one then the display will say: "No Wireless Networks Found". If this happens then you need to either move the NP30 nearer your wireless access point or investigate if there is an issue with your wireless network.

When the NP30 finds your wireless network, it displays the broadcast name (ESSID) for the access point - this is a name allocated to the access point by whoever set up the network, it may either be a default name for your router/wireless or may be a more familiar name such as "Johns Wi-Fi" etc. If your NP30 finds more than one wireless network you can simply choose which one you want to connect to. Turn the rotary dial to see the ESSID for each wireless network.

When the ESSID for the wireless network you want to connect to is displayed on the screen, press the SELECT button. If your network is not configured with an encryption code, the screen should say "Connecting to network" then "Network OK".

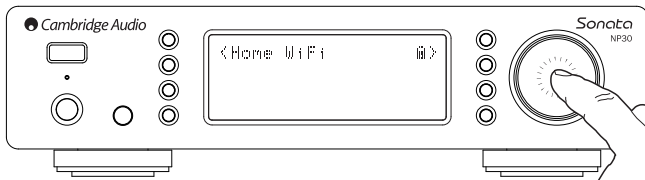

If the screen displays either "Enter WEP key" or "Enter WPA key", then the network is using one of the supported encryption systems: Wired Equivalent Privacy (WEP) or Wi-Fi Protected Access (WPA). You now need to enter your correct WEP or WPA code. The person who set up the wireless network in the first place will know what this code is (or be able to reset it to a new known code); if that person is not you, then you need to find out what it is.

After 3 seconds, the display goes into the code entry mode. To enter the code, use the rotary dial to select each character of the code in turn, pressing the SELECT button after entering each character.

Note: The WEP and WPA codes are case sensitive, so you must enter them exactly.

After entering the final character, use the rotary dial to select the  character and press the SELECT button. It's a little fiddly but you will only need to do this once. The NP30 will remember this code and use it automatically from now on.

The unit should now be able to connect to the network.

Operating the NP30

The NP30 home menu consists of 5 items:

- UuVol Radio**
- Streaming Services**
- Media**
- Podcasts**
- Settings**

These allow access to the four basic types of media choice plus a Settings menu for the unit.

You can return to this menu at any time by pressing the  button.

Simply scroll through the items with the scroll wheel or navigator buttons on the remote control and press in the scroll wheel or use the select button on the remote to select the item you want.

UuVol Radio

The UuVol Radio service brings thousands of internet radio stations to you. The sheer choice available on the internet allows you to find new music, listen to stations in your native language (or perhaps if you are learning another one), from your home town or by your Genre of choice.

It has to be said that the audio quality of internet radio varies greatly dependant on the bitrate and compression technology used by the broadcaster, but the choice more than makes up for this. UuVol Radio allows you to explore and find new music from all over the world.

Note: As an 'aggregator' service we are simply organising the browsing and connection process for these stations so that you don't have to manually search for them or type in any URLs (web links) etc to access them. Whilst we regularly check the stations to make sure they are still transmitting reliably and in reasonable quality we are not responsible for their content in any way.

As well as the thousands of stations we offer if you want to listen to a particular station that is not included in our service you can add it via UuVol portal at UuVol.com, see later section. You can also visit the UuVol.com portal on the web and put in a request suggesting new stations for us to add to the service. We welcome your feedback.

It is not necessary to register your NP30 to use the free UuVol service but by registering you will be able to edit settings on your NP30 via your own portal on our website, manage your presets, set up new 3rd party Streaming Services and more.

How to use UuVol Radio

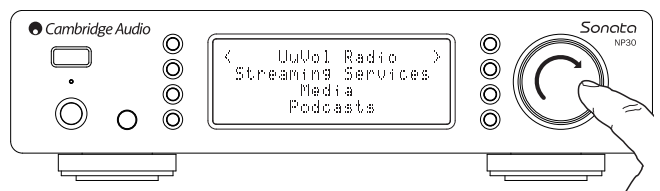

Press the  button to return to the top-level menu.

Select UuVol Radio from the list using the rotary dial then press the rotary dial to select it. The NP30 displays the following submenus.

UuVol Radio

- Location
- Genre
- Search

You can now turn the rotary dial to choose from Location, Genre or Search.

Location - Enables you to choose from the stations in any of the countries which you choose from a list.

Genre - Enables you to choose radio stations according to their declared content, for example Classic Rock, Sport, News, etc.

Search - Enables you to search for a station you know the name of. Enter the full name or first part of the name for your desired station. The NP30 will bring up a list of all stations that contain a word that starts with your search term.

Note: Although we check the stations for continuity of service, some radio stations do not broadcast 24 hours per day, and some stations may not always be on-line.

Registering your NP30 with the UuVol portal on the web

To access extra features on your NP30 such as editing and copying presets first you will need to set up an account on UuVol. Open www.UuVol.com from an Internet browser. Click on the 'Register' link and follow the on-screen instructions to register an account. .

After creating and logging into your new account, you can now add your NP30 to your account by accessing the 'My Products' link. Follow the instructions, you will need to enter your NP30s seven digit registration code, which can be found in the 'Settings > Register' menu of the NP30 itself.

This is a unique code generated by the unit during the registration process.

Note the key lasts for about 10 minutes, if you don't use it in that time you will need to exit and re-enter this menu to get a new key.

Your NP30 is now registered and you can use the portal to manage your presets, Podcasts and more. You can also suggest new stations to us, setup 3rd party Streaming Services and view information from us on new products.

Note: You can register as many products as you like and manage the presets etc. across several products which could be in different parts of the world all seamlessly from your UuVol portal.

Streaming Services

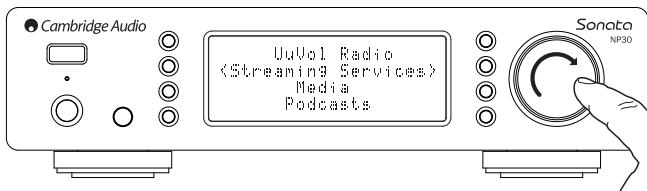

The NP30 supports a range of streaming services from other suppliers that often have an element of interaction with the user. The NP30 displays the following submenus.

Streaming Services

- Aupeol
- Live365
- MP3tunes
- Etc.

Note: The services available vary depending on your geographical location.

Because Streaming Services generally allow the user some choice over the content they listen to they are licensed differently to iRadio by the music companies and often each service only has arrangements in certain countries.

They may also charge a subscription for membership.

Examples of such services are Last.FM, Pandora, Rhapsody, Live365, Mp3Tunes and others.

When you enter this menu the ones that are available to you in your country will be shown. Those that are free to use or have a free to use version will work 'straight out of the box' Others will guide you to the relevant sign up page, should you so wish.

For more details on what these services offer please go to our UuVol.com website, links to each service can also be found here.

Also via the portal you can prevent services appearing in this menu that you do not wish to sign up to.

Media



The NP30 can access media from UPnP Servers or local media connected via USB. The NP30 displays the following submenus:

Media

- UPnP Servers
- Local Media
- Queue

UPnP is by far the preferred method as it allows for browsing by artist, album and other methods, has support for control from Wi-Fi controller and the media can be shared amongst several devices.

UPnP servers

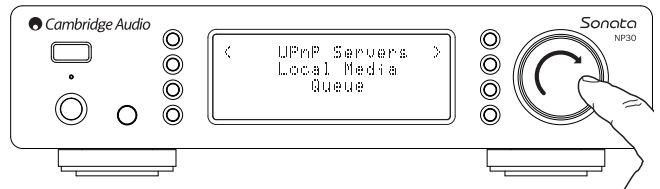

Your NP30 can connect with Computers or Network Attached Storage devices that feature a Universal Plug and Play (UPnP) AV Server.

When using a UPnP server to share your media, the search and selection criteria are determined by the server and not the NP30, but typically include Album, Artist and additional options such as Genre.

As long as the NP30 is correctly configured for your Network it will automatically discover and connect to UPnP servers it finds when you go into the UPnP playback menu. It will then allow navigation of the menu structure coming from that server.

There are many suitable UPnP server software packages available for PC and Mac. Stand-alone servers and Network Attached Storage (NAS) devices with built in UPnP server capabilities are also available. Please see the set-up guides on our website at <http://support.cambridgeaudio.com/>.

Once you have setup a suitable server, navigate to the Media/UPnP Servers menu within the NP30 and press Select.

The NP30 will perform a scan of your network and report any UPnP Servers it finds. If none are found it will display "No Servers Found" on the display. If a server or servers are found their names will be displayed and you can select which one you'd like to get content from.

Select the server you want and the NP30 will then load the appropriate menu structure from that sever. These typically allow you browse your content by Album, Artist, Genre etc.It is important to understand that the menu structure here is coming from the Server not the NP30.

You can now browse and select any music content in a format the NP30 supports (currently AAC, MP3, WMA, AIFF, FLAC, WAV and Ogg Vorbis).

Note not all servers support serving of all these formats. Always make sure the server you choose also supports your formats of choice.

Operating the NP30 cont.

Alphameric Search

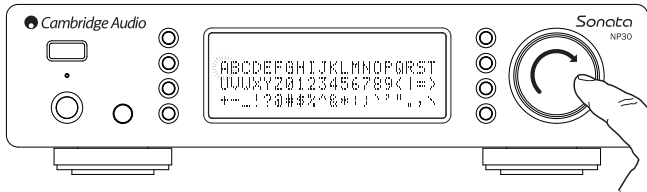

This is a search function menu inserted by the NP30 into the browse tree of UPnP servers that support an external search function.

Where available you can select Alphameric search and then enter the name or partial name of an album or track you wish to find.

Simply select each character in order using the Navigation/Select dial, rotate to each character and then press in to select. You can also use the Skip buttons to move forward/back a character, ▶/|| to enter a character and ■/⊗ to delete a character.

Once finished either press the ◀ button or navigate to the ◀ symbol and press the Enter button on the remote or press the Navigation/Select dial.

The NP30 then displays all Album names or Track names it can find that matches your chosen text.

You can then simply select your chosen item and press the Enter or ▶/|| button on the remote to start it playing.

The 'Now Playing' screen

Selecting a new Station, Stream or Media item will start playback and display the 'Now Playing' screen.

The current Artist/Album and Track or Station name will be shown with the relevant CODEC details (i.e. audio file type and bitrate/samplerate.)

For Media files the NP30 also shows the incremental track playback time.

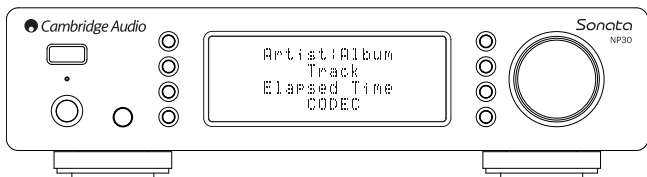

You can also display the now playing screen at any time by pressing **i** on the remote control.

Shuffle

Accessed via the remote only. Press the **↻** button to toggle Shuffle On or Off.

The NP30 displays a **⌘** in the 'Now Playing' screen when Shuffle is On.

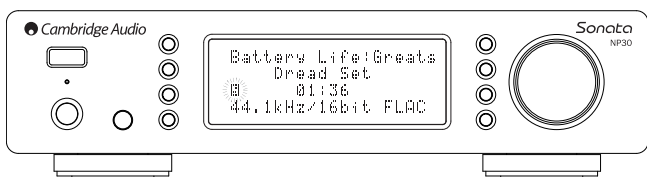

If the currently selected media item/folder contains fewer than 1000 tracks the NP30 generates a true random shuffle of those tracks and starts playback such that all are played once in a random order and then playback stops.

If more than 1000 tracks are contained the NP30 will instead pick a track at random for playback then pick another one randomly (and without reference to what has gone before) once the current one has finished.

This continues until Shuffle is turned Off. Thus for >1000 tracks the playback of any track may be repeated randomly.

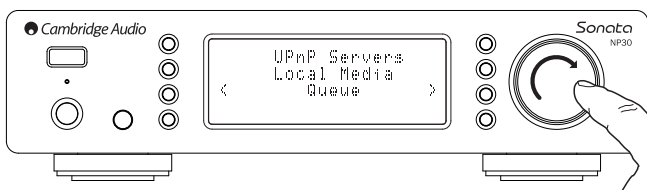

Repeat

Accessed via the remote only. Press the **↺** button to toggle Repeat On or Off.

If the currently selected media item is a track the NP30 will repeat that track, if it is an album or artist etc. the NP30 will repeat all tracks in that item.

The NP30 displays a **↺** in the 'Now Playing' screen when Repeat is On.

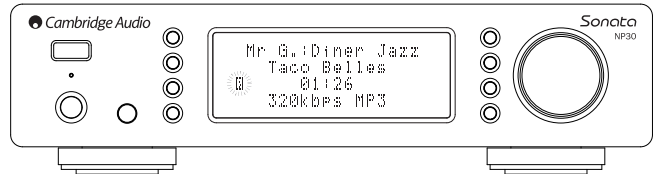

Local Media

The NP30 can also playback audio content from standard USB hard-drives and thumb drives. Simply copy your media files onto your USB drive and then connect it to the front or back USB socket of the unit.

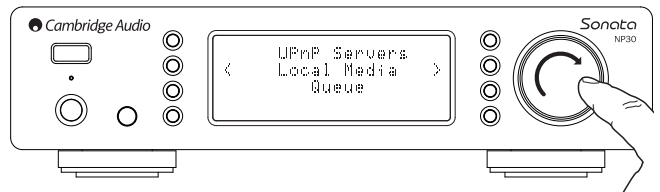

Press the **⬆** button to get to the top menu. Select the 'Media' menu and then the 'Local Media' item.

The NP30 will now scan the thumb drive for media files. Once the scan is completed, you will then be able to browse the files by selecting 'By Album' or 'By Artist'.

Queue

The NP30 features a queue function that allows you to select multiple albums and/or tracks you'd like to be played in order.

When in the UPnP or Local Media selection menus, if you highlight a track/artist or album name etc and press and hold the Navigation/Select dial (or Enter on the remote handset), the NP30 will add the current item to the Queue. If it is the first item to be queued playback will start. If it is an additional item 'Added to queue' will be displayed and that item will be appended to the queue.

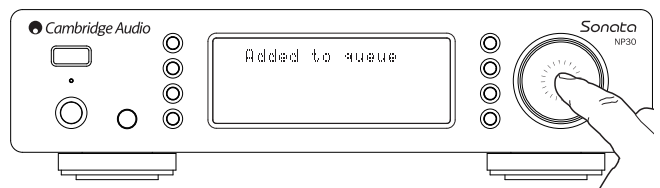

All component parts of that media item will be added, if the item is a track then only that track will be added but if the item is an album or an artist then all that albums or artists tracks will be added.

To view the Queue simply navigate back to Queue item in the Media menu or press the Reply button whilst a queue is playing. Tracks that are a component part of a media item will be shown indented by a **▮** below their parent media item as below.

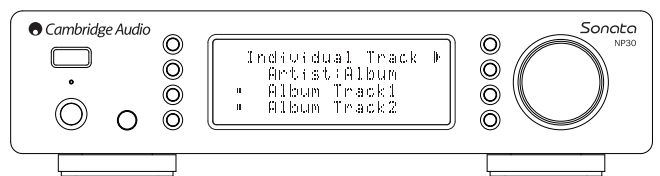

The displayed menu shows the queued content for playback, you can navigate to any item and select it (via Enter or ▶/||) to jump to playing that item. ■/⊗ can also be used to delete items from the Queue. The currently playing item will have a **⏮** next to it.

At the bottom of the Queue a Clear Queue command is available for deleting the whole queue.

During Queue play back the NP30 displays a  in the 'Now Playing' screen.

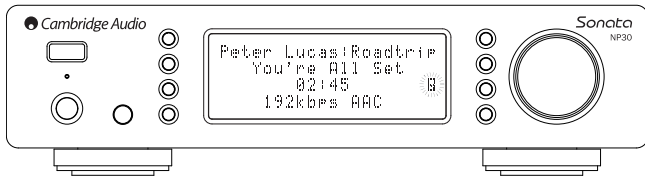

Pressing stop will stop the Queue playing but not delete it. Putting the NP30 into standby will delete the Queue.

To view the Queue at any time simply navigate back to Queue item in the Media menu or press the  button whilst a queue is playing.

Playlists

The NP30 also supports various playlist formats. For permanent storage of favourite media selections it is recommended to use suitable software to create playlists.

These can then be accessed by the NP30 from Local Media or UPnP servers that support Playlist serving.

Podcasts

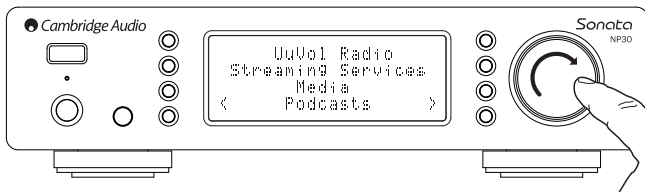

The podcast services in your area will be shown.

These typically allow you to choose different types of podcast by subject, date or perhaps popularity etc. It is important to understand that the menu structure here is coming from that service and is controlled by them. It may therefore change as the service updates its features etc. The NP30 displays the following submenus.

Podcasts

- BBC Podcasts
- BlogTalkRadio
- Personal Podcasts

Note: The services available vary depending on your geographical location.

There is also a menu item for your own choice of podcasts called Personal Podcasts. This allows access to podcast links that can input via the UuVol.com website.

To use Personal Podcasts sign up at UuVol.com and enter the URLs of podcasts you'd like the NP30 to automatically sync to.

My Podcasts

This feature allows you to access podcast on the NP30 that are not available in the Podcasts services we support.

This is done by entering the URL for the podcast you want via the UuVol portal. To do this you need to be registered as per the section under UuVol.

Simply login to your account and then click on the 'My Podcasts' link. From your 'My Podcasts' section, you can add your chosen podcast by entering in the podcast's name and its URL as prompted by the website. Please note, the podcast URL will have to be a direct RSS feed which will end with the '.xml' extension e.g. <http://someurl.com/podcast.xml>. Once you have podcasts available in your 'My Podcasts' list, you may access these feeds from your NP30. These podcasts will be available from the menu item: 'Podcasts > My Podcasts'.

Please note, the podcasts are pushed to your NP30 at turn on when the unit updates stations list and at intervals thereafter.

To cause the radio to download Podcasts and new stations list immediately, turn on and off your NP30 from the front panel.

Presets

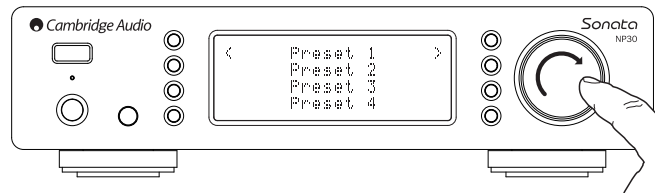

The NP30 supports 20 presets. These can be UuVol Radio stations or streams from most Streaming Services. UPnP/Local media cannot be set as a preset.. To add a station/stream to a preset first select that stream for playback in the normal way. Now press the  button this will bring up the presets menu.

Select the preset location you require and press and hold in the Navigation/Select dial to save the current station/stream to that preset.

Recalling presets is done simply by pressing the  button and selecting the preset you want with a brief push of the Navigation/Select dial.

Note: The NP30 loads the presets for display from our UuVol servers over the internet, thus they can take a few seconds to appear.

Settings menu

This menu contains various setup / configuration menus as shown below.

Settings

- Network Config
- Version
- Upgrade Firmware
- Language
- Factory Reset
- Register
- NP30 Name
- WiFi Strength
- Remote Code

Network Config

This menu enables you to set your NP30's network settings, scan again for a connection to another wireless network, or to manually configure the network parameters. This is useful if you move your NP30 to a new location for instance.

By default the NP30 will be set for Automatic wired/wireless detection and automatic IP addressing (DHCP) which will work without setup in most circumstances (for Wi-Fi you will need to enter your WEP/WPA key if you have one).

In Auto mode the NP30 will look for a wired connection first and then scan for wireless connections if it doesn't find one. It will also try to obtain an IP address automatically from your router/DHCP server.

If you wish to make changes to your setup the NP30 displays the following submenus.

Network Config

- Scan for networks
- Enter network name
- View Config
- Edit Config
- Signal Warning
- WiFi Region
- Wired/Wireless

Scan for networks

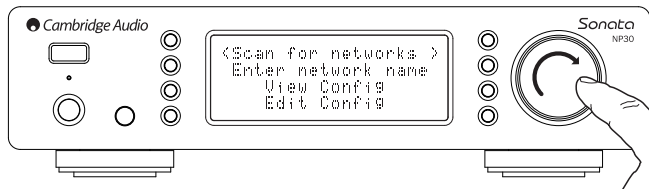

This option scans all available Wi-Fi frequencies for wireless networks and allows you to connect to them.



The NP30 can connect to 802.11b/g or n networks (2.4GHz frequency range only for n networks).

A list of available networks will be presented. If a particular network requires an encryption key, a  symbol will be seen at the end of the network name.

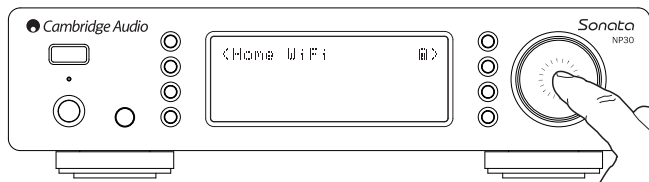
Select your local network using the Navigation/Select dial and press it in for enter.



The NP30 will then connect to the network using a saved key (if you have previously set one) or present you with an alphanumeric entry menu. Here you can enter the network key you set up when setting up your wireless network.

Select each character in turn using the Navigation/Select dial and then press  or navigate to the  symbol and press Navigation/Select dial to enter that key. If you make a mistake, press  to go back one character.

The NP30 can handle keys in WEP, WPA and WPA2 formats (the choice of format is made by appropriate settings on your router) and automatically generates the right format from your text according to the router request.

Enter the network name

This option allows the NP30 to search for and connect to a particular network name only.

Type your network name in using the alphanumeric entry screen.

If no matching network is found 'Network not found' will be displayed.

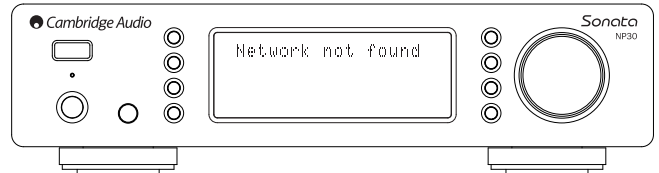

View Config

This menu firstly displays the IP mode (static or dynamic). This will be Auto/DHCP (i.e. dynamic, this is the default) or alternatively Static IP.

For either mode by turning the Navigation/Select dial the NP30 will scroll through the various current IP parameters, for instance the ESSID of the current wireless network, Wired and Wireless MAC addresses, current IP address, (Sub)Netmask, Gateway address etc.

Edit Config

This menu allows the selection of IP mode between static or dynamic (Auto/DHCP). Auto/DHCP is recommended for most people in most circumstances. Static IP requires quite a bit of knowledge about IP networks, and is for advanced users only.

The default setting is thus Auto / DHCP, here the NP30 obtains its IP address each time you switch in on by a process called DHCP which means it is different each time it is acquired. This process is completely automatic and much simpler than implementing Static IP.

However sometimes it is useful (especially in large networks) to know the exact IP address of each device, this can only be done by using static IP.

When using Static IP you will also need to enter the network mask you wish to use and the addresses of your gateway and DNS service, note there is no way for Cambridge Audio to know what these are in your network. Only select static IP if you know exactly what you are doing!

To set static IP, select the 'Settings > Network config > Edit Config' menu and then press SELECT.

The NP30 will now display 'Auto (DHCP)? YES / NO'. Turn the NP30's rotary dial to select 'NO' and then press SELECT.

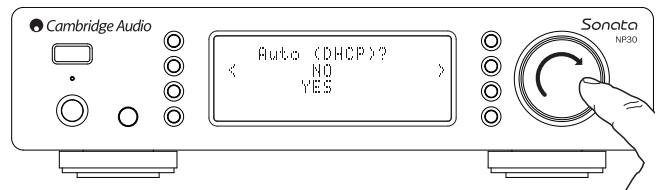

You will now be able to enter the fixed IP address you wish to give your NP30 by using the rotary dial to select the desired numbers followed by pressing Navigation/Select dial to end inputting the address.

The NP30 will now prompt you to enter the required network mask for the network. You will be able to enter this in the same way as before for entering the IP address.

You will now need to enter the default gateway's IP address used by the NP30 on the network.

Finally, you will need to enter the DNS IP address for the NP30. On some networks, you may need to enter your ISP's DNS IP address, which should be available on your ISP's support page on their website.

After entering the above information, the NP30 will now try to connect to your network. If you wish to use DHCP again simply select 'Settings > Network config > Edit Config' and then set 'Auto (DHCP)? YES / NO' to 'YES'.

Signal warning

The NP30 can display a warning if the Wi-Fi signal strength is low enough to be causing reduced throughput. The options for the Signal Warning are simply Yes or No.

Wi-Fi Region

Different parts of the world use slightly different frequencies for Wi-Fi. For best performance you should set the NP30 to the region you live in, the current options are US, Spain, Europe (i.e. other than Spain), Japan.

Wired/Wireless connection

It is possible to connect your NP30 to your network via an available Ethernet connection (RJ45) or via a Wi-Fi router. By default the unit is in AUTO mode, each time you turn the unit it looks for the presence of a wired connection, and tries to use this, if none is present or it cannot connect it then tries to use the wireless connection and so on. In Auto mode once the NP30 has established a certain type of connection to the network, then this type of connection will remain in use while the NP30 is on.

You can alternatively configure the NP30 to permanently only use the wired or wireless connection From the NP30's 'Network config' menu, select 'Wired/Wireless'. This menu will present you with three options: 'Auto', 'Wired Only' and 'Wireless Only'.

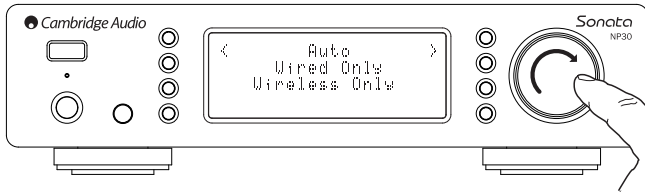

Selecting 'Wired Only' will cause the NP30 to reboot and then only use its Ethernet connection to communicate with the network. Selecting the 'Wireless Only' will cause the NP30 to reboot and only use its Wi-Fi connection. Selecting the 'Auto' option means the NP30 will try both and settle on the one it can make work as described above.

Version

This menu item displays some hardware/software version numbers for your NP30. Turn the rotary dial to scroll through the various items.

The Service Pack is the currently loaded firmware software. It's a good idea to note this down if you need to contact our technical support people as they may request it.

The Serial Number and Product Code are not normally required by the technical support team.

Note: This Serial Number is not the same as the physical serial number on the back of the product itself.

Upgrade Firmware

Use this option to download new firmware for the NP30 from Cambridge Audio over the Internet.

If you select this item the NP30 will contact our server and see if a newer version of software is available ('Checking for updates' will be shown in the display).

If new software is found the NP30 will prompt you if you want to download it or not. It is a good idea to update the firmware from time to time to take advantage of any bug fixes or new features. At this stage, you can press the NP30's **↵** button to cancel the firmware upgrade. A Firmware upgrade may take several minutes.

Note:

- It is very important that once the Firmware upgrade has started you do not switch off the power to the NP30 until the operation is complete otherwise the NP30 may become permanently damaged.
- Also do not interrupt the network or internet connection by removing the Ethernet lead or switching off your router etc.

Language

Allows you to change the display language used.

A list of the currently supported languages will be shown. Select your preferred one and press enter.

Note: The NP30 will then restart in order to start again in the new language, this will take approximately 30 seconds.

Factory Reset

Puts all the settings back to their defaults as they were when they left the factory.

The NP30 will ask you if you are sure you want to proceed before performing a reset.

Note: If you perform a factory reset, you will lose all your presets and any saved WEP/WPA keys for your wireless network connection.

Register

This will display a key that can be used to register your NP30 on the UuVol portal at www.UuVol.com. First you will need to set up an account on UuVol. Open www.UuVol.com from your Internet browser. See the section earlier on UuVol registration.

Note the generated key lasts for about 10 minutes, if you don't use it in that time you will need to exit and re-enter this menu to get a new key.

UPnP Name

This menu allows the setting of the declared UPnP Client name for your NP30.

This is the name other UPnP devices (such as control points and remote Apps etc.) will display when they see the NP30.

The default name will be 'NP30' but can be changed to any name you can easily recall such as 'Dads NP30' or 'Kitchen' etc.

WiFi Strength

Displays the strength of the received WiFi Signal.

Note: If WiFi has been turned off (Ethernet mode only) the signal strength will show as 0%.

Remote Code

There are two Options

Option 1 - is the default and works with the NP30 remote control when also in its default mode.

Option 2 - gives a secondary code set in cases where the remote codes are found to clash with another remote handset.

If Option 2 is selected on the NP30 then the remote handset must also be set to Option 2 remote codes as well as follows:

Press and hold down the **⏏** button for approx. 12 seconds, this will toggle between Option 1 and Option 2.

Performing the action again on the remote will toggle back to Option 1 codes.

UuVol Remote

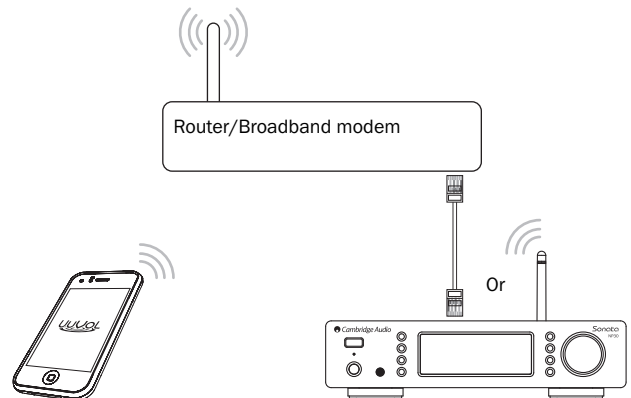

UuVol remote is a free iPhone/iPod Touch/iPad application that allows wireless control of the NP30 or other UuVol powered Cambridge Audio products.

The application allows full control of the NP30 including UuVol Radio, Streaming Services, UPnP Media, Presets, Queing and more.

It also supports display of Album artwork and Station logos (where available).

To use UuVol Remote you will need a Wi-Fi network or Access point for the application to connect to, the connection from your router to the NP30 can then be either Wi-Fi or Ethernet.

Search for UuVol Remote on the Apple App Store or browse www.UuVol.com for further details on this and other Apps and features as they become available.

Technical specifications

DAC	Wolfson WM8728 24 bit 96kHz capable
THD+N	0.003% @ 1kHz
Frequency Response	20Hz-20kHz +/- 0.2dB
Signal to Noise ratio	> 95dB
Total correlated jitter	<200pS
Digital outputs* **	S/PDIF Co-axial and TosLink Optical 16-24 Bits, 32-96kHz
Audio Formats**	WAV containing uncompressed PCM 16-24 bit 32-96kHz FLAC containing losslessly compressed PCM 16-24 bit 32-96kHz AIFF containing uncompressed PCM 16 bit 32-48kHz Microsoft® Windows Media™ Audio (WMA 9 Standard) 32-320kbps MP3 (CBR or VBR) 16-320kbps AAC, HE AAC and AAC+ (CBR or VBR) 16-320kbps OGG Vorbis 32-320kbps
Streaming Protocols	RTSP (Real Time Streaming Protocol) MMS (Microsoft Media Server Protocol) HTTP (Hyper Text Transfer Protocol)
Playlists	ASX (Microsoft® playlist format) M3U, PLS
Wi-Fi	IEEE 802.11 b / g or n (2.4GHz connection used only)
Wi-Fi Encryption	WEP, WPA, WPA2
Ethernet	IEEE 802.3, 10 Base-T or 100 Base-T
USB	2 x USB 1.1 current limited to 500mA each
File systems	FAT32
Trigger In	12V DC
Mains inlet voltage	100-240 VAC (switch mode)
Standby consumption	<1W
Max power consumption	21W
Dimensions (W x D x H)	270 x 285 x 67mm
Weight	2.1Kg/4.6lbs

* iRadio/Streaming Services are output as 16 bit data at the appropriate sample rate for the decompressed data. The sample rate will be 32kHz, 44.1kHz or 48kHz depending on the streams sample rate.

Incoming streams of less than 32kHz sample rate cannot be output over S/P DIF /Toslink.

For compressed streams the true resolution of the audio is of course limited by the encoding.

For Media content from local drives or UPnP this outputs in its native resolution of 16- 24 bits, 32 kHz 44.1kHz 48kHz or 96kHz with bit for bit transfer.

** 88.2kHz material is not supported.

Troubleshooting

If you experience any trouble with your NP30, then you may find it useful to visit the help section on our webpage at <http://support.cambridgeaudio.com/>.

If you have trouble with the UuVol service then you may also find it useful to visit the help section at www.UuVol.com.

General Help guidelines:

If you have trouble connecting the NP30 to your network, these steps may help to resolve the problem:

- Confirm that a connected PC can access the Internet (i.e. can browse the web) using the same network.
- Check that a DHCP server is available, or that you have configured a static IP address on the NP30. You can configure a static IP address on the NP30 using the menu item 'Settings -> Network Config -> Edit Config', and then select 'No' for 'Auto (DHCP)'. DHCP is however the recommended method.
- Check that your network's firewall is not blocking any outgoing ports. As a minimum, the radio needs access to UDP and TCP ports 80, 554, 1755, 5000, 6000 and 7070.
- Check your access point does not restrict connections to a particular MAC addresses. You can view the radio's MAC address using the menu item 'Settings -> Network Config -> View Config -> MAC address'.
- If you have an encrypted Wi-Fi network, check that you have entered the correct key or passphrase into the NP30. Remember that text-format keys are case sensitive. If, when attempting to connect to an encrypted network, your NP30 displays: 'Wireless error' followed by a 5-digit number, then please ensure that you enter the correct passphrase for the network. If the problem persists, then you may need to consult your network configuration.

If your NP30 can connect to the network successfully, but is unable to play particular UuVol stations, it may be due to one of the following causes:

- The station is not broadcasting at this time of the day (remember it may be located in a different time zone).
- The station has reached the maximum allowed number of simultaneous listeners.
- The station is not broadcasting anymore.
- The link in our database is simply out of date.
- The Internet connection between the server (often located in a different country) and you is slow.
- Try using a PC to play back the stream via the broadcaster's web site.

If you can play back the station with a PC, you can use the form at www.UuVol.com to notify us so that we can investigate.

If you have problems with UPnP playback always check the following:

- Ensure your chosen UPnP server software is capable of serving the file type you are trying to access. Some servers do not serve FLAC for instance.
- The NP30 can only play non DRM files. Files that have DRM controls cannot be played by the NP30. Some servers may be able to authorise and de-crypt Microsoft Playsforsure before then serving the content to the NP30 but this operation is not guaranteed as it is purely a function of the server.
- If attempting to play 24 bit WAV or FLAC content note a wired Ethernet connection is normally required for reliable operation due to bandwidth considerations.
- Check the NP30 is capable of playing back the file type you are trying to access. WMA, AAC, MP3, Vorbis, FLAC and WAV can currently be played. The NP30 does not support ALAC, WMA Pro, WMA lossless, RAW, AU or other file types not mentioned.

If you have problems with Local Media playback always check the following:

- Check the NP30 is capable of playing back the file type you are trying to access. WMA, AAC, MP3, Vorbis, FLAC and WAV can currently be played.
- The NP30 does not support ALAC, WMA Pro, WMA lossless, RAW, AU or other file types not mentioned.
- For local media the NP30 can only play non DRM files. Files that have DRM controls cannot be played.
- Check that your device does not require more than 500mA if it is powered from the USB socket itself.
- Check your device is formatted in FAT32 format.
- The way you organise your local media affects the size of internal database the NP30 needs to build dynamically as you browse content. Good practice is to create folders for Artists within which you should have a sub folders for each Album which then containing the tracks for that Album. Libraries with thousands of tracks in one folder will progressively slow down the NP30's media browsing.

For all servicing, in or out of warranty, please contact your dealer.

Cambridge Audio is a brand of Audio Partnership Plc
Registered Office: Gallery Court, Hankey Place,
London, SE1 4BB, United Kingdom
Registered in England No. 2953313

www.cambridge-audio.com

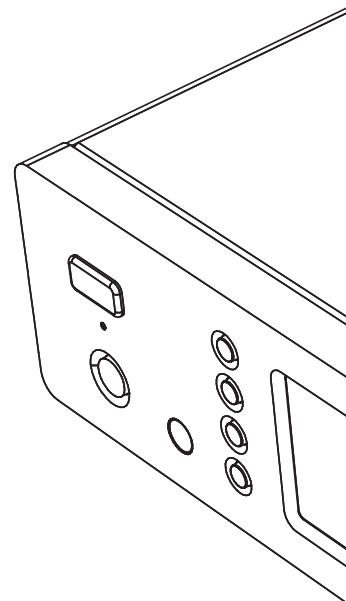

© 2011 Cambridge Audio Ltd

AP25650/1

Free Manuals Download Website

<http://myh66.com>

<http://usermanuals.us>

<http://www.somanuals.com>

<http://www.4manuals.cc>

<http://www.manual-lib.com>

<http://www.404manual.com>

<http://www.luxmanual.com>

<http://aubethermostatmanual.com>

Golf course search by state

<http://golfingnear.com>

Email search by domain

<http://emailbydomain.com>

Auto manuals search

<http://auto.somanuals.com>

TV manuals search

<http://tv.somanuals.com>