

azur

740A

 *Cambridge Audio*

Your music + our passion

Contents

Introduction	2
Limited warranty.....	3
Safety precautions	3
Important safety instructions	4
Rear panel connections.....	5
Front panel controls	6
Remote control.....	7
iPod compatibility.....	7
Connections	8
Operating instructions	9
Amplifier setup.....	9-10
Multi-Room connections.....	11
Custom installation use.....	11
CAP5 protection system	12
Troubleshooting.....	13
Technical Specifications.....	13

Make sure you register your purchase.

Visit: www.cambridgeaudio.com/sts

By registering, you'll be the first to know about:

- Future product releases
- Software upgrades
- News, events and exclusive offers plus competitions!

This guide is designed to make installing and using this product as easy as possible. Information in this document has been carefully checked for accuracy at the time of printing; however, Cambridge Audio's policy is one of continuous improvement, therefore design and specifications are subject to change without prior notice.

This document contains proprietary information protected by copyright. All rights are reserved. No part of this manual may be reproduced by any mechanical, electronic or other means, in any form, without prior written permission of the manufacturer. All trademarks and registered trademarks are the property of their respective owners.

Incognito and Incognito Ready are trademarks of Cambridge Audio Ltd. All rights reserved.

© Copyright Cambridge Audio Ltd 2008

A-BUS and A-BUS Ready are registered trademarks of LeisureTech Electronics Pty Ltd Australia.

iPod and Apple are trademarks of Apple Inc., registered in the U.S. and other countries.

Introduction

Thank you for purchasing this Azur 740A Integrated Amplifier. We hope that you will enjoy many years of listening pleasure from it.

The 740A is based on our award-winning amplifier topology as seen in our 540A and 640A models, further developed and enhanced for this new higher end model as part of our on-going development programme.

The 740A features three separate transformer secondaries for the left and right power amp channels and preamp, with separate rectifiers and PSU's allowing dual mono operation of the left and right power amplifiers. Two pairs of very high current output transistors per channel allow the 740A to drive almost any speaker with ease and ensure excellent bass response and dynamic control.

Other features include the use of a very high precision silicon gate volume / balance control rather than the more common potentiometer. Volume is controllable in 1 dB steps over most of the range, giving very fine control, an accurate logarithmic law and superbly accurate channel balance. Software control of all functions allows gain trim to be applied to any input and other functions.

The 740A also includes support for multi-room use. By plugging in one or two external Cambridge Audio Incognito keypads (or active speakers) and a power supply unit your amplifier can become the hub of a simple multi-room system. In addition, Control Bus Input/Output and IR Emitter Input are provided to make it easy to integrate this unit into Custom Installation systems if desired.

An Azur Navigator remote control is also provided, giving full remote control of your amplifier in an attractive and easy to use handset.

Your amplifier can only be as good as the system it is connected to. Please do not compromise on your source equipment, speakers or cabling. Naturally we particularly recommend models from the Cambridge Audio Azur range. These have been designed to the same exacting standards as this amplifier. Your dealer can also supply excellent quality Cambridge Audio interconnects to ensure your system realises its full potential.

Thanks for taking the time to read this manual; we do recommend you keep it for future reference.

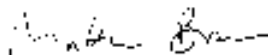

Matthew Bramble
Technical Director

Important safety instructions

For your own safety please read the following important safety instructions carefully before attempting to connect this unit to the mains power supply. They will also enable you to get the best performance from and prolong the life of the unit:

1. Read these instructions.
2. Keep these instructions.
3. Heed all warnings.
4. Follow all instructions.
5. Do not use this apparatus near water.
6. Clean only with a dry cloth.
7. Do not block any ventilation openings. Install in accordance with the manufacturer's instructions.
8. Do not install near any heat sources such as radiators, heat registers, stoves, or other apparatus (including amplifiers) that produce heat.
9. Do not defeat the safety purpose of the polarized or grounding-type plug. A polarized plug has two blades with one wider than the other. A grounding-type plug has two blades and a third grounding prong. The wide blade or the third prong are provided for your safety. If the provided plug does not fit into your outlet, consult an electrician for replacement of the obsolete outlet.
10. Protect the power cord from being walked on or pinched, particularly at plugs, convenience receptacles and the point where they exit from the apparatus.
11. Only use attachments/accessories specified by the manufacturer.
12. Use with only the cart, stand, tripod, bracket, or table specified by the manufacturer, or sold with the apparatus. When a cart is used, use caution when moving the cart/ apparatus combination to avoid injury from tip-over.
13. Unplug this apparatus during lightning storms or when unused for long periods of time.
14. Refer all servicing to qualified service personnel. Servicing is required when the apparatus has been damaged in any way, such as the power-supply cord or plug having been damaged, liquid has been spilled or objects have fallen into the apparatus, the apparatus has been exposed to rain or moisture, does not operate normally, or has been dropped.



WARNING - To reduce the risk of fire or electric shock, do not expose this unit to rain or moisture.

The unit is of Class 1 construction and must be connected to a mains socket outlet with a protective earthing connection.

The unit must be installed in a manner that makes disconnection of the mains plug from the mains socket outlet (or appliance connector from the rear of the unit) possible. Where the mains plug is used as the disconnect device, the disconnect device shall remain readily operable. Only use the mains cord supplied with this unit.

Please ensure there is ample ventilation. We recommend that you do not place the unit in an enclosed space; if you wish to place the unit on a shelf, use the top shelf to allow maximum ventilation. Do not put any objects on top of this unit. Do not situate it on a rug or other soft surface and do not obstruct any air inlets or outlet grilles. Do not cover the ventilation grilles with items such as newspapers, tablecloths, curtains, etc.

This unit must not be used near water or exposed to dripping or splashing water or other liquids. No objects filled with liquid, such as vases, shall be placed on the unit.



The lightning flash with the arrowhead symbol within an equilateral triangle is intended to alert the user to the presence of un-insulated 'dangerous voltage' within the product's enclosure that may be of sufficient magnitude to constitute a risk of electric shock to persons.

The exclamation point within an equilateral triangle is intended to alert the user to the presence of important operating and maintenance instructions in the service literature relevant to this appliance.



WEEE symbol

The crossed-out wheeled bin is the European Union symbol for indicating separate collection for electrical and electronic equipment. This product contains electrical and electronic equipment which should be reused, recycled or recovered and should not be disposed of with unsorted regular waste. Please return the unit or contact the authorised dealer from whom you purchased this product for more information.



CE mark

This product complies with European Low Voltage (2006/95/EC) and Electromagnetic Compatibility (89/336/EEC) Directives when used and installed according to this instruction manual. For continued compliance only Cambridge Audio accessories should be used with this product and servicing must be referred to qualified service personnel.



C-Tick mark

This product meets the Australian Communications Authority's Radio communications and EMC requirements.



Ross Test Stamp

This product meets Russian electronic safety approvals.

FCC regulations

NOTE: THE MANUFACTURER IS NOT RESPONSIBLE FOR ANY RADIO OR TV INTERFERENCE CAUSED BY UNAUTHORIZED MODIFICATIONS TO THIS EQUIPMENT. SUCH MODIFICATIONS COULD VOID THE USER AUTHORITY TO OPERATE THE EQUIPMENT.



This equipment has been tested and found to comply with the limits for a Class B digital device, pursuant to Part 15 of the FCC Rules. These limits are designed to provide reasonable protection against harmful interference in a residential installation. This equipment generates, uses and can radiate radio frequency energy and, if not installed and used in accordance with the instructions, may cause harmful interference to radio communications. However, there is no guarantee that interference will not occur in a particular installation.

If this equipment does cause harmful interference to radio or television reception, which can be determined by turning the equipment off and on, the user is encouraged to try to correct the interference by one or more of the following measures:

- Re-orient or relocate the receiving antenna.
- Increase the separation between the equipment and receiver.
- Connect the equipment into an outlet on a circuit different from that to which the receiver is connected.
- Consult the dealer or an experienced radio/TV technician for help.

Ventilation

IMPORTANT – The unit will become hot when in use. Do not place anything on top of the unit. Do not place in an enclosed area such as a bookcase or in a cabinet without sufficient ventilation.

Ensure that small objects do not fall through any ventilation grille. If this happens, switch off immediately, disconnect from the mains supply and contact your dealer for advice.

Positioning

Choose the installation location carefully. Avoid placing it in direct sunlight or close to a source of heat. No naked flame sources, such as lighted candles, should be placed on the unit. Also avoid locations subject to vibration and excessive dust, cold or moisture. The unit can be used in a moderate climate.

This unit must be installed on a sturdy, level surface. Do not place in a sealed area such as a bookcase or in a cabinet. Do not place the unit on an unstable surface or shelf. The unit may fall, causing serious injury to a child or adult as well as serious damage to the product. Do not place other equipment on top of the unit.

Due to stray magnetic fields, turntables or CRT TVs should not be located nearby due to possible interference.

Electronic audio components have a running in period of around a week (if used several hours per day). This will allow the new components to settle down and the sonic properties will improve over this time.

Power sources

The unit should be operated only from the type of power source indicated on the marking label. If you are not sure of the type of power-supply to your home, consult your product dealer or local power company.

This unit has been designed to be left in Standby mode when not in use as this will increase the life of the amplifier (this is true with all electronic equipment). To turn the unit off, switch off at the rear panel. If you do not intend to use this unit for a long period of time, unplug it from the mains socket.

Overloading

Do not overload wall outlets or extension cords as this can result in a risk of fire or electric shock. Overloaded AC outlets, extension cords, frayed power cords, damaged or cracked wire insulation and broken plugs are dangerous. They may result in a shock or fire hazard.

Be sure to insert each power cord securely. To prevent hum and noise, do not bundle the interconnect leads with the power cord or speaker leads.

Cleaning

To clean the unit, wipe its case with a dry, lint-free cloth. Do not use any cleaning fluids containing alcohol, ammonia or abrasives. Do not spray an aerosol at or near the unit.

Battery disposal

Please dispose of any discharged batteries according to local environmental/electronic waste disposal guidelines.

Loudspeakers

Before making any connections to loudspeakers, make sure all power is turned off and only use suitable interconnects.

Servicing

These units are not user serviceable. Never attempt to repair, disassemble or reconstruct the unit if there seems to be a problem. A serious electric shock could result if this precautionary measure is ignored. In the event of a problem or failure, please contact your dealer.

Limited warranty

Cambridge Audio warrants this product to be free from defects in materials and workmanship (subject to the terms set forth below). Cambridge Audio will repair or replace (at Cambridge Audio's option) this product or any defective parts in this product. Warranty periods may vary from country to country. If in doubt consult your dealer and ensure that you retain proof of purchase.

To obtain warranty service, please contact the Cambridge Audio authorised dealer from which you purchased this product. If your dealer is not equipped to perform the repair of your Cambridge Audio product, it can be returned by your dealer to Cambridge Audio or an authorised Cambridge Audio service agent. You will need to ship this product in either its original packaging or packaging affording an equal degree of protection.

Proof of purchase in the form of a bill of sale or receipted invoice, which is evidence that this product is within the warranty period, must be presented to obtain warranty service.

This Warranty is invalid if (a) the factory-applied serial number has been altered or removed from this product or (b) this product was not purchased from a Cambridge Audio authorised dealer. You may call Cambridge Audio or your local country Cambridge Audio distributor to confirm that you have an unaltered serial number and/or you made a purchase from a Cambridge Audio authorised dealer.

This Warranty does not cover cosmetic damage or damage due to acts of God, accident, misuse, abuse, negligence, commercial use, or modification of, or to any part of, the product. This Warranty does not cover damage due to improper operation, maintenance or installation, or attempted repair by anyone other than Cambridge Audio or a Cambridge Audio dealer, or authorised service agent which is authorised to do Cambridge Audio warranty work. Any unauthorised repairs will void this Warranty. This Warranty does not cover products sold AS IS or WITH ALL FAULTS.

REPAIRS OR REPLACEMENTS AS PROVIDED UNDER THIS WARRANTY ARE THE EXCLUSIVE REMEDY OF THE CONSUMER. CAMBRIDGE AUDIO SHALL NOT BE LIABLE FOR ANY INCIDENTAL OR CONSEQUENTIAL DAMAGES FOR BREACH OF ANY EXPRESS OR IMPLIED WARRANTY IN THIS PRODUCT. EXCEPT TO THE EXTENT PROHIBITED BY LAW, THIS WARRANTY IS EXCLUSIVE AND IN LIEU OF ALL OTHER EXPRESS AND IMPLIED WARRANTIES WHATSOEVER INCLUDING, BUT NOT LIMITED TO, THE WARRANTY OF MERCHANTABILITY AND FITNESS FOR A PRACTICAL PURPOSE.

Some countries and US states do not allow the exclusion or limitation of incidental or consequential damages or implied warranties so the above exclusions may not apply to you. This Warranty gives you specific legal rights, and you may have other statutory rights, which vary from state to state or country to country.

For any service, in or out of warranty, please contact your dealer.

Plug Fitting Instructions (UK Only)

The cord supplied with this appliance is factory-fitted with a UK mains plug fitted with a 5-amp fuse inside. If it is necessary to change the fuse, it is important that a 5-amp fuse is used. If the plug needs to be changed because it is not suitable for your socket, or becomes damaged, it should be cut off and an appropriate plug fitted following the wiring instructions below. The plug must then be disposed of safely, as insertion into a mains socket is likely to cause an electrical hazard. Should it be necessary to fit a 3-pin BS mains plug to the power cord, the wires should be fitted as shown in this diagram. The colours of the wires in the mains lead of this appliance may not correspond with the coloured markings identifying the terminals in your plug. Connect them as follows:

The wire which is coloured BLUE must be connected to the terminal which is marked with the letter 'N' or coloured BLACK.

The wire which is coloured BROWN must be connected to the terminal which is marked with the letter 'L' or coloured RED.

The wire which is coloured GREEN/YELLOW must be connected to the terminal which is marked with the letter 'E' or coloured GREEN.

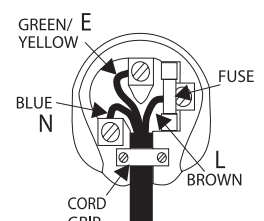

If a standard 13-amp (BS 1363) plug is used, a 5-amp fuse must be fitted or, if any other type of plug is used, a 5-amp fuse must be fitted, either in the plug or adaptor, or on the distribution board.

Rear panel connections

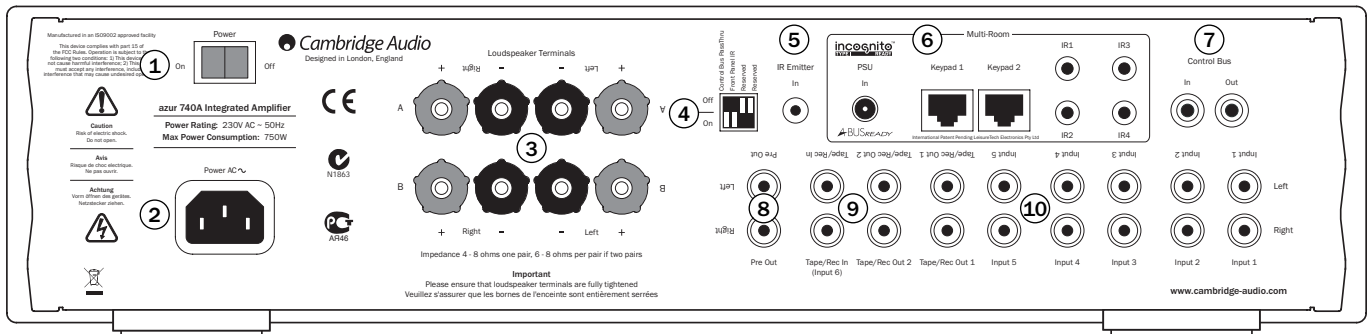

① Power On/Off

Switches the unit on and off.

② AC power socket

Once you have completed all connections to the amplifier, plug the AC power cable into an appropriate mains socket then switch on. Your amplifier is now ready for use.

③ Loudspeaker terminals

Two sets of loudspeaker terminals are available, A (main loudspeaker terminals) and B (secondary loudspeaker terminals). Both sets of speakers can be turned on and off independently. Connect the wires from your left channel loudspeaker to the LEFT + & - terminals, and the wires from the right channel loudspeaker to the RIGHT + & - terminals. In each case, the red terminal is the positive output and the black terminal is the negative output.

Care should be taken to ensure no stray strands of wire short the speaker outputs together. Please ensure that the loudspeaker terminals have been tightened completely to provide a good electrical connection. It is possible for the sound quality to be affected if the screw terminals are loose.

Note: When using one pair of speakers, use speakers with a nominal impedance of between 4-8 ohms. When using two pairs of speakers, use speakers with a nominal impedance of between 6-8 ohms. Please also note that when multiple speakers are connected across the amplifier's outputs, the load (as seen by the amplifier) is reduced. This will make the amplifier work harder, and hotter!

④ Dip-switches

Used in conjunction with custom installation (C.I.) systems. Refer to the 'Custom installation' section for more information.

Front Panel IR - Set to 'On' for normal operation.

Control Bus Passthru - Turns on/off looping of Control Bus signals from Input to Output.

Reserved - Not used.

⑤ IR (Infrared) Emitter In

Allows modulated IR commands from multi-room systems to be received by the amplifier. Commands received here are not looped out of the Control Bus. Refer to the 'Custom installation' section for more information.

⑥ A-BUS™ Ready / Incognito Ready™ multi-room outputs

PSU - Connect an Incognito PS5 to supply power to the connected multi-room keypads/speakers.

Keypad 1/2 - Connect one or two Incognito A-BUS KP10 keypads (or other A-BUS compatible keypads) using CAT5/5e cable. Incognito AS10 Active Ceiling Speakers can also be connected here.

IR - Four IR outputs for remote control of source equipment.

Please refer to the 'Multi-Room' section of this manual for more information on connections and set-ups.

⑦ Control Bus

In - Allows un-modulated commands from multi-rooms systems or other components to be received by the unit.

Out - Loop out for control bus commands to another unit. Also allows the 740A to control some Cambridge Audio units.

⑧ Pre Out

Connect these sockets to the inputs on an external power amplifier(s) or active subwoofers etc.

⑨ Tape/Rec In/Out

Connect to a tape deck or to the analog output sockets on a MiniDisc, portable digital music player or CD recorder using an interconnect cable from the recorder's Line Out sockets to the amplifier's Tape In sockets.

The Tape Input circuit of the 740A is a "monitor" type, different from the other 7 inputs. For the 7 normal inputs, the source selected for listening to will be sent out of the Tape Out for recording. The source currently being listened to and (optionally) recorded is then shown on the front panel display.

However, when the Tape Input is selected a solid circle will appear beside TAPE MON indicating that the Tape Input is now being listened to with a different source being sent out of the Tape Out for recording. The recording source is also shown by a solid circle by the selected input and can be changed by pressing the other source buttons. To switch Tape Monitor off, simply press the Tape Mon input select button again, toggling this function off.

This feature is most useful when using 3-head analog cassette decks which allow the signal being recorded to be played back live off tape (via a 3rd head) whilst it is simultaneously recorded. It is then possible by toggling the Tape Monitor input on and off to compare directly in real time the original and recorded signal so that adjustments to the recording parameters of the tape machine can be made (consult the manual of your 3-head analog cassette deck for full details).

⑩ Inputs 1-5

These inputs are suitable for any 'line level' source equipment such as CD players, DAB or FM/AM tuners etc.

Note: These inputs are for analog audio signals only. They should not be connected to the digital output of a CD player or any other digital device.

Front panel controls

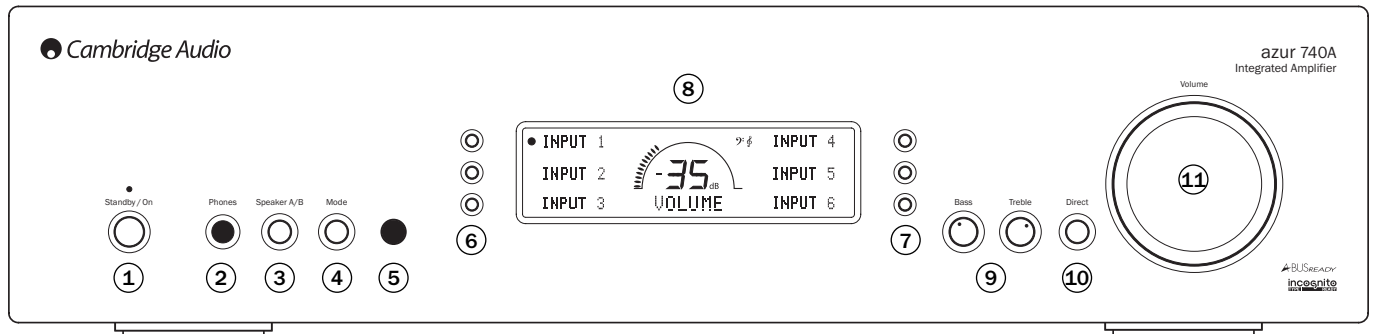

① Standby/On

Switches the unit between Standby mode (indicated by dim power LED) and On (indicated by bright power LED). Standby is a low power mode where the power consumption is less than 10 Watts. The unit should be left in Standby mode when not in use.

② Phones

Allows for the connection of stereo headphones with a ¼" Jack plug. Headphones with an impedance of between 32 and 600 ohms are recommended. When the headphones are connected, the loudspeaker relays are released switching off the output to the loudspeakers (speakers A and B).

③ Speaker A/B

Press to scroll through the speaker sets connected to the loudspeaker terminals on the back panel (speaker sets A, B or A and B). This can be used for listening to an extra set of loudspeakers in another room.

Please note that care should be taken when choosing speakers if two loudspeakers are going to be used on each channel. If the combined resistance measured on the loudspeaker terminals is too low the amplifier may not switch out of Standby mode until a suitable load resistance is detected. For more information refer to the CAP5 section of this manual.

Note: When using one pair of speakers, use speakers with a nominal impedance of between 4-8 ohms. When using two pairs of speakers, use speakers with a nominal impedance of between 6-8 ohms each.

④ Mode

Press to switch between Volume and Balance modes. Press and hold to enter the 740A System Configure menu.

⑤ Infrared sensor

Receives IR commands from the supplied Azur remote control. A clear unobstructed line of sight between the remote control and the sensor is required.

⑥ & ⑦ Input select buttons

Push the appropriate input selection button to select the source component that you wish to listen to (highlighted by a solid circle on the display). The signal selected is also fed to the Tape Out sockets so that it may be recorded. The input should not be changed whilst recording (but the recorded signal can be checked using the tape input Tape Monitor).

⑧ Display

LCD used to control the 740A. Please refer to the 'Operating instructions' and 'Amplifier setup' section of this manual for more information.

⑨ Bass and Treble

Press to release and rotate to allow subtle adjustments to the tonal balance of the sound.

⑩ Direct

This control gives the audio signal a more direct path to the power amplifier stage of your amplifier, bypassing the tone control circuits for the purest possible sound quality.

⑪ Volume

Use to increase/decrease the level of the sound from the outputs of the amplifier. This control affects the level of the loudspeaker output, the pre-amp output and the headphone output. It does not affect the Tape Out connections.

The Volume control is also used in navigating the 740A System Configure menus on the front panel display.

Please refer to the 'Operating instructions' section of this manual for more information on some functions of these buttons.

Remote control

The 740A is supplied with an Azur Navigator remote control that operates both this amplifier and Cambridge Audio Azur CD players. Insert the supplied AAA batteries to activate.

The functions relevant to the amplifier are as follows:

Standby/On

Switches the amplifier between On and Standby mode.

Numerical buttons 1-8

Press to change the input source to the amplifier. Button 6 toggles Tape Monitor on/off.

Bright

Adjust the backlight of the front panel display; bright, dim or off.

Mode

Press to switch between Volume and Balance modes.

Mute

Mutes the audio on the amplifier. The mute mode is indicated by MUTE appearing and the volume level being replaced by two flashing dashes in the display. Press again to cancel mute.

Volume

Increase or decrease the volume of the amplifier output.

The following functions can be optionally used to control Cambridge Azur range CD players:

Open/Close

Opens and closes the disc tray.

Play / Stop / Pause

Press the relevant button to play, stop or pause the CD.

Skip

Right Skip - Press once to skip forward by one track on the CD. Press and hold to skip forwards through tracks.

Left Skip - Press once to skip backward by one track on the CD. Press and hold to skip backwards through tracks.

Search

Press and hold to search within the selected track. Right button to fast forward, left button to rewind.

Repeat, Random, Remain

Refer to the 'Operating instructions' section of your CD player manual for information on the functions of these buttons.

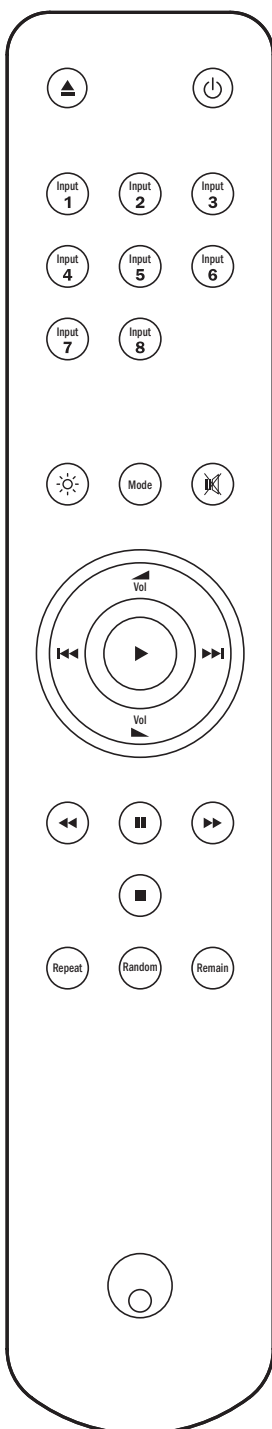

iPod compatibility

To make use of the iPod functionality, the iPod dock must be connected to 'Input 4'.

The 740A remote can also control the basic functions of Apple iPod models when mounted in Cambridge Audio's iPod docks, Apple's Universal Dock or other docks compatible with the Apple Remote. Refer to your dock's instruction manual on how to make connections.

To use the Azur remote to control the docked iPod, hold down the *Input 4* button whilst pressing one of the following buttons:

Play/Pause

Press to play the iPod, press again to pause play.

Skip

Press once to skip forwards or backwards one track.

Connections

When designing our amplifiers we have tried to include features that allow you to connect your system in various ways. The inclusion of features such as Pre-Out and Speaker B connections mean that you can flexibly configure your system depending on your requirements.

Basic connection

The diagram below shows the basic connection of your amplifier to a CD player and a single pair of loudspeakers.

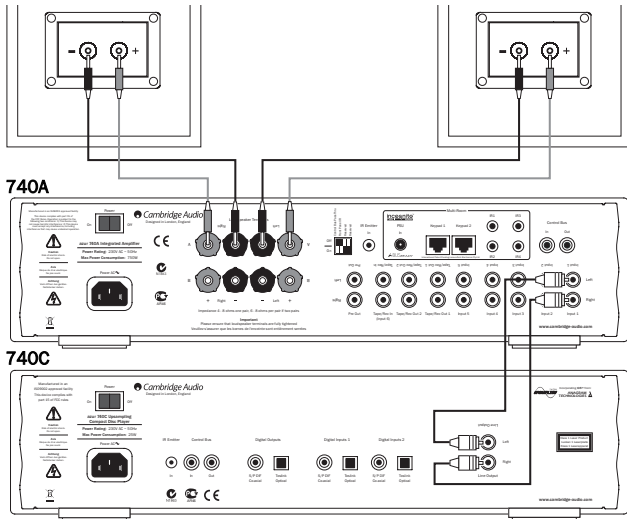

Tape connection

The diagram below shows how to connect the amplifier to a tape recorder or other source with a record and monitor connection.

Please note that either of the tape outputs can be used (as they are both the same signal in parallel).

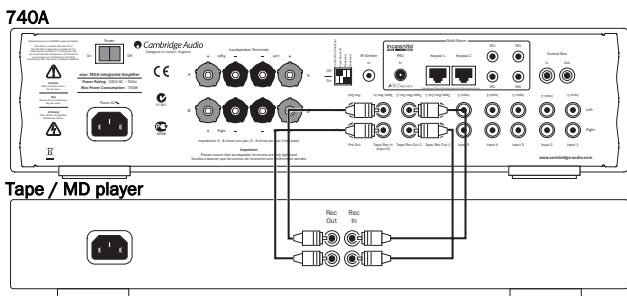

Speaker B connections

The Speaker B connections on the back of the amplifier allow for a second set of speakers to be used (i.e. speakers located in another room). The Speaker A/B button on the front panel allows this second set of speakers to be switched on and off.

Note: When using two pairs of speakers, use speakers with a nominal impedance of between 6-8 ohms each minimum.

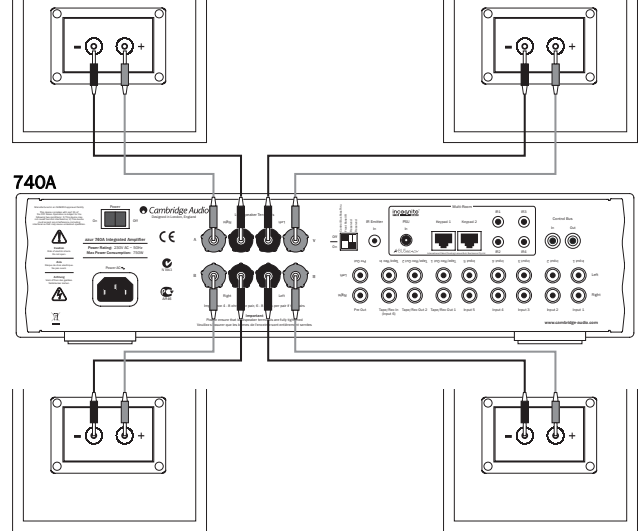

Preamp Out connections

The Preamp Out sockets are for connecting to the input sockets of a power amplifier or active subwoofer. The diagram below shows how to connect the amplifier to an active subwoofer via the Line In inputs on the subwoofer.

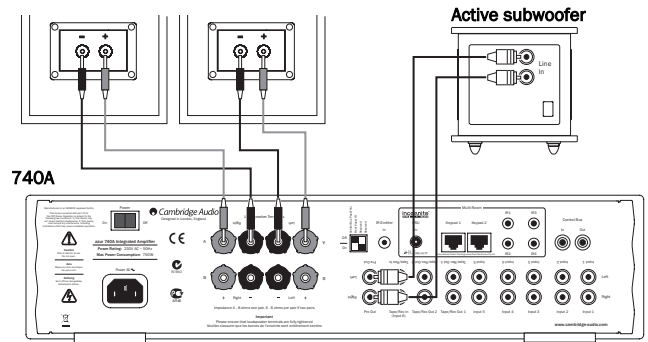

Operating instructions

The 740A has a custom-made display on the front of the unit showing the current status and allowing you to access the 740A System Configure menus. Here you can adjust the listening settings of the amplifier to personal preference. The menu system is easy to navigate and control, simply by using the input select buttons to turn a feature on (solid circle) or off (no circle) and the volume control knob to increase/decrease settings.

Volume

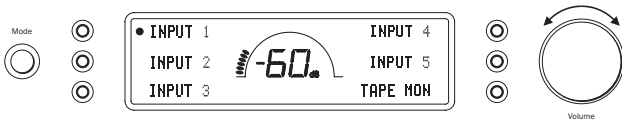

Adjust the volume control knob on the front panel (or using the remote control). The display will show the change in volume in decibels (dB). '0dB' indicates maximum volume while lower volume settings progress into the negative range. This can also be changed to volume units (0-72) in the System Configure menu.

Speaker A/B

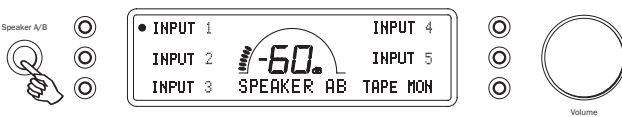

Press the *Speaker A/B* button to scroll through the speaker sets connected via the rear panel: speakers A, B or A and B.

Balance

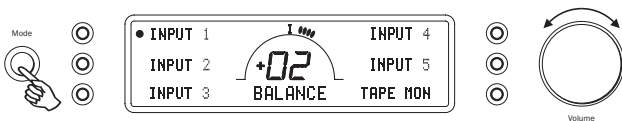

Press the *Mode* button to enter Balance mode. BALANCE will appear on the display and can be adjusted using the volume control. Press the *Mode* button again to return to Volume mode or wait 5 seconds for the 740A to automatically exit Balance mode.

Bass and Treble

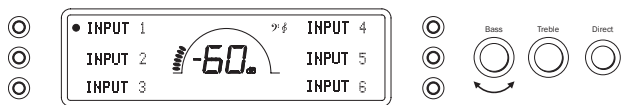

These controls allow subtle adjustments to the tonal balance of the sound. Press to release and rotate to adjust (press back in when desired settings found). An icon appears on the display to show if Bass/Treble has been adjusted. In the central position these controls have no effect.

These controls only modify the sound through your loudspeakers and the Pre-Out sockets; they do not affect the signals sent through the Tape Out connections. With a well produced CD and a good system the tone controls are unnecessary and can be switched out by pressing the *Direct* button:

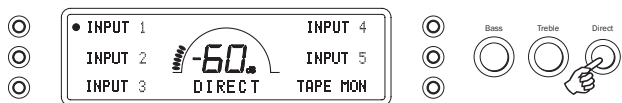

This completely removes them from the signal path for maximum fidelity. If the musical recording is of poor quality or other factors are affecting the sound quality, it may be necessary to adjust the tone controls to compensate.

Amplifier setup

The 740A features many advanced settings that allow it's use to be customised to user preference. The inputs can be named to reflect the actual source units you have, each input can be trimmed so that each sounds the same in terms of loudness when you switch between them and other options.

Changing input names / source naming



Press and hold the relevant input select button for four seconds to change its name. For example, if Input 1 is a CD player, name it "CD" etc. Letters are selected by turning the volume control to scroll through the available characters. Press LEFT or RIGHT to select which character you wish to edit. Press EXT CHAR to access an extended character set. Press OK to confirm and exit the input name change menu.

System Configure menu

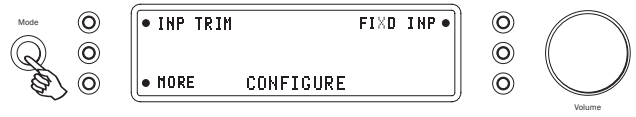

Press and hold the *Mode* button to access the System Configure menu. The first menu options are Input gain trim and Fixed input gain. Press MORE to access the second menu options of Clip detector, LCD brightness, Speaker short detector, Volume ramp and Volume display.

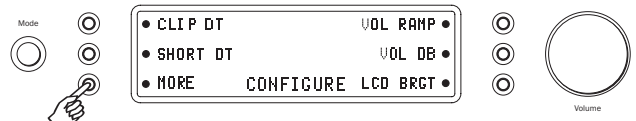

To exit the System Configure menu and its sub-menus, press the *Mode* button again.

Clip detector / Speaker short detector

Refer to the 'CAP5' section of this manual for more information on the Clip and Short detection features of the 740A, as both can be enabled (default) or disabled.

LCD brightness

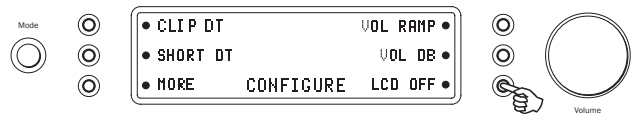

In the System Configure menu press the LCD input select button to scroll through bright/dim/off settings for the front panel display. Press the *Mode* button to exit.

Volume ramp

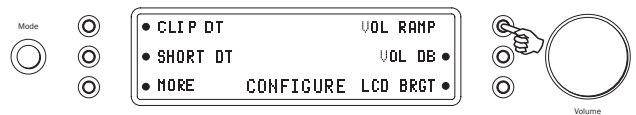

The 740A automatically ramps the volume down when going into Standby mode and up when coming out of Standby mode. To turn this feature off, press the VOL RAMP input select button in the System Configure menu and set to off. Press the *Mode* button to exit.

Amplifier setup continued

Volume display



To change the volume display from decibels (-84 to 0dB) to arbitrary volume units (0 to 72 units) select VOL DB in the System Configure menu. Press the input select button to turn off the volume in decibels. Press the *Mode* button to exit.

Input gain trim

The relative levels of the inputs can be adjusted by gain trim. This allows each to be adjusted so that each sounds the same in terms of average loudness when you switch between them. Pick the loudest sounding source and trim its level until it matches the average perceived level of the others. Repeat this process if other sources also stand out as louder than the average.

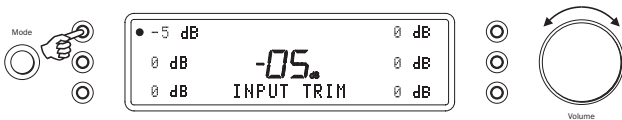

To set the input gain trim for each source, select INP TRIM in the System Configure menu. Select the input required and use the volume control to set the gain between 0 and -12 dB (the available range is restricted if the volume is set very low). Press the *Mode* button to exit.

Fixed level inputs

Any input of the 740A is able to be set for fixed gain. Whenever this input is selected the gain will automatically go to this value and will not be adjustable by the volume control. This feature allows the 740A to be effectively used as a stereo power amplifier (for that selected input only). For example, as well as operating as a pure stereo amplifier, the 740A can provide the amplification for the front left and right channels of a surround sound setup with an AV receiver providing amplification for the other channels and controlling the overall system volume.

When listening in stereo use the 740A and connected stereo sources as normal for best possible sound quality. For surround sound, select the fixed level input you have chosen on the 740A and now use the AV receiver to control the volume, select connected surround sound sources etc. You may wish to re-name the fixed level input as "A/V mode" or similar on the 740A. Make connections as below, the left and right preamp outputs of the AV receiver connect to the fixed gain input chosen on the 740A. As the gain can be fixed to any value it is easy to match the level of the 740A to that of the other AV channels.

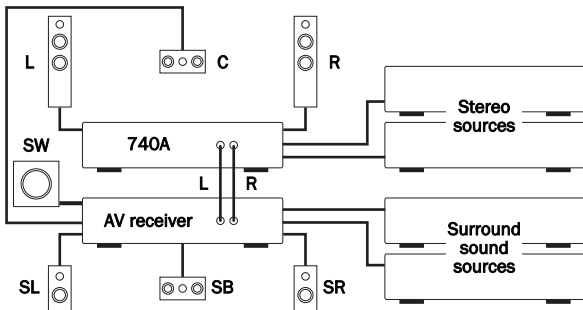

To set a fixed volume for a source, select FIXED INP in the System Configure menu:

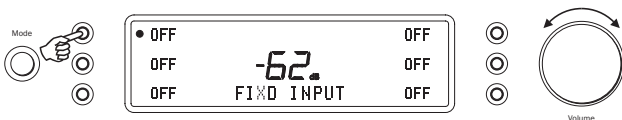

Select the input required and set the fixed gain using the volume control (the OFF setting does not disable the input but leaves the input gain subject to the volume control which is the default setting). When a source has a fixed input, the balance is always set to neutral. Press the *Mode* button to exit.

On/Off control menu

When going in/out of Standby mode the 740A can automatically turn on and off other connected Cambridge Audio Azur models that have control bus sockets. For this feature to work the units must be connected together (see diagram) by RCA/phono leads. The sockets are colour-coded orange on the rear panels of compatible Azur models. Loop out from the 740A Control Bus Out to the Control Bus In on another Azur model (e.g. 740C). Continue the chain to other Azur models if required.

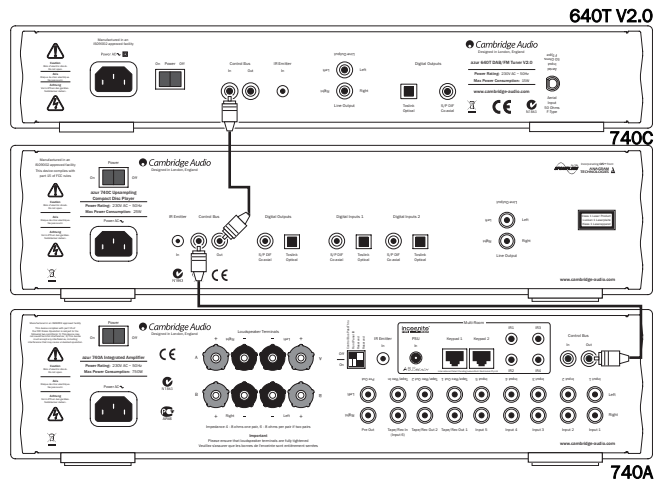

Now while the 740A is on press and hold the *Standby/On* button until ON/OFF CTR appears on the display:

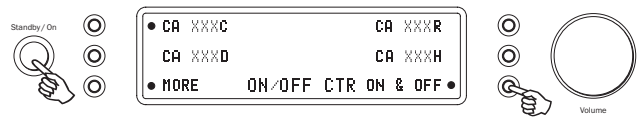

Select the connected Azur models by pressing the appropriate input select button. For example, CA XXXC for an Azur CD player (540C V2, 640C V2), CA XXXD for an Azur DVD player, CA DAB T for an Azur DAB tuner etc.

Press ON & OFF to scroll through the options of ON (turns all Azur units on only), OFF (turns all Azur units into Standby only) or ON & OFF (turns all Azur units on and into Standby mode). Press OK to confirm and exit.

Multi-room connections

The 740A features Incognito Ready/A-BUS Ready outputs, allowing multi-room capability. One or two amplified keypads can be plugged into the 740A (using Cat5/5e cable and RJ45 plugs) to provide multi-room audio in one or two secondary rooms or zones. The keypads are powered by an external PSU (also required) through the Cat5/5e cables and no mains connection is required in the secondary rooms.

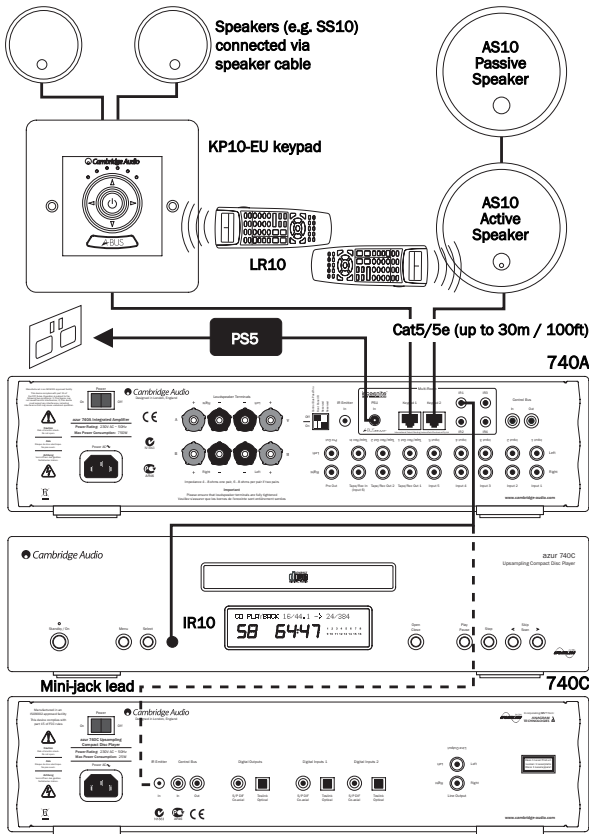

The 740A is Incognito Ready Type I, which means the keypads can operate independently of the amplifier in terms of volume/bass/treble etc, be independently turned on and off from the 740A and each other, but they can only listen to the same source as selected on the amplifier.

A-BUS is a standard that allows compatibility between different manufacturers equipment, so A-BUS compatible keypads from other manufacturers can also be used. If used with our own Incognito KP10 keypads, there are some extra features such as the ability to change source on the 740A from the keypad.

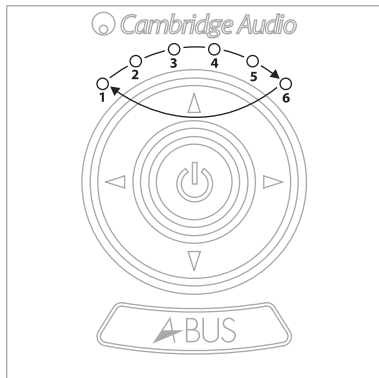

Order of selection:

1. Input 1
2. Input 2
3. Input 3
4. Input 4
5. Input 5
6. Input 6 (Tape)

Connections to the 740A's Incognito Ready / A-BUS Ready outputs are made by Cat-5 cable (terminated with an RJ45 jack plug). The RJ45 plug must be wired to the EIA/TIA 568A wiring standard:

Wire colours:

1. Green/White
2. Green

3. Orange/White

4. Blue
5. Blue/White

6. Orange

7. Brown/White
8. Brown

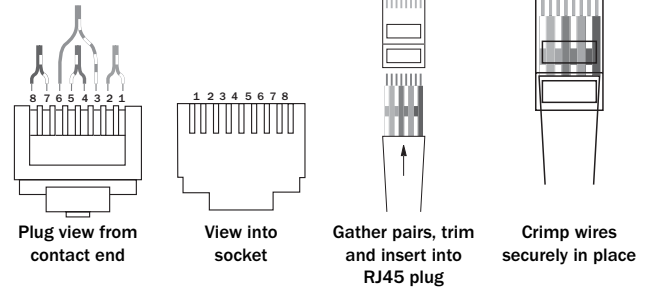

To allow control of your source equipment from the remote rooms an IR emitter (IR10) is plugged into one of the IR outputs on the rear of the unit and then attached over the IR window of the source unit. Alternatively, on our own products that feature IR emitter Inputs, a mini-jack to mini-jack lead can be used. Commands received by the keypads can now be sent back to the source equipment via the 740A.

It is then possible to control the source equipment from the remote rooms by using the source equipment's own remote controls or through a learning remote. The Incognito LR10 Learning Remote can fully control the keypads, "learn" the source's remote control codes (including those from other manufacturers) and change source input on the 740A etc.

For further details on the Incognito multi-room system please contact your local Cambridge Audio dealer or visit www.cambridge-audio.com.

Custom installation (C.I.) use

The 740A features a Control Bus input/output that allow un-modulated remote control commands (positive logic, TTL level) to be received electrically by the unit and looped to another unit if desired. These control commands are typically generated by custom installation (multi-room) systems or remote IR receiver systems. The Control Bus sockets are colour-coded orange.

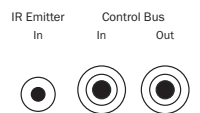

An IR Emitter Input is also provided that allows modulated IR remote control commands to be received electrically by the unit. Commands on this input operate the unit only and are not looped out demodulated on the Control Bus Output.

The 740A is also fitted with dip-switches which can be set for different C.I. configurations. When the 740A is used in a cupboard (or when using routed IR) it may be desirable to disable the Front Panel IR by setting the dip-switch to 'Off'.

By default, all Cambridge Audio source equipment loop the Control Bus signals from 'In' to 'Out'. If several units are used in a complete loop, set the Control Bus Passthru dip-switch to 'Off'.

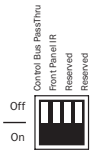

In addition the units feature 'direct' IR/Control codes as well as toggle codes for some of their features to simplify programming custom installation systems. Special direct On/Off and Mute commands can be accessed on the supplied remote control for teaching into C.I. systems as follows:

1. Press and hold the *Standby/On* button. The remote first generates it's standby (toggle) command. Keep the button held down, after 12 seconds an amplifier "On" command will be generated. If the button is kept held down for a further 12 seconds, an amplifier player "Off" command is generated.
2. Press and hold the *Mute* button. The remote first generates it's mute (toggle) command. Keep the button held down, after 12 seconds a "Mute on" command will be generated. If the button is kept held down for a further 12 seconds, a "Mute off" command is generated.

A full code table for this product is available on the Cambridge Audio website at www.cambridge-audio.com.

CAP5 - Fiveway protection system

Cambridge Audio has developed a proprietary protection system to ensure reliability and a long life for its amplifiers and the speakers they are connected to. **Note:** Due to the required sensitivity of the CAP5 system, it is possible that mains power disturbances can falsely trigger CAP5 in extreme situations. This protection system comprises of five main protection methods:

1. DC detection

Indication - Unit has switched off during operation, display flashes “DC ERROR”.

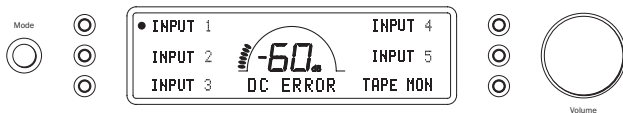

Description - CAP5 offers loudspeaker protection if the output of the amplifier goes to a high constant voltage (DC) because of some internal fault. This is a rare fault although detecting it could just save those expensive loudspeakers.

Remedy - Due to the necessary sensitivity of the DC protection circuit, extremely hard clipping of the amplifier may cause DC protection to be triggered. If this fault occurs please switch the unit off, power up again and check operation with a reduced volume level. If the DC fault occurs again please contact your dealer for service.

2. Over temperature detection

Indication - Unit has switched off during operation, display flashes “OVER TEMP”.

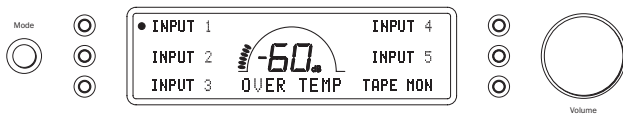

Description - Over temperature is caused by a combination of high listening levels and low impedance speakers. CAP5 includes temperature detection which constantly monitors the heat generated by the output transistors. If the monitored temperature reaches a high level (suitably within the limits of the output devices) the amplifier will automatically switch into a fault mode. The unit should ideally be left for 15 minutes in this state to cool down adequately. If the unit has not fully cooled down then the temperature may reach the limit soon after the amplifier is powered up. If the loudspeaker impedance is low the temperature of the amplifier may rise faster as the amplifier is working harder. If the amplifier is mounted in a cabinet or the ventilation slots are obstructed the over temperature detection may activate/reactivate after a short listening time.

Remedy - User related fault. The internal temperature of the output transistors has reached the over temperature limit. The unit is not damaged, although it should be left for 15 minutes to cool down before pressing the Standby button to resume normal operation.

3. Overvoltage/overcurrent detection

Indication - The display flashes “OVERLOAD”.

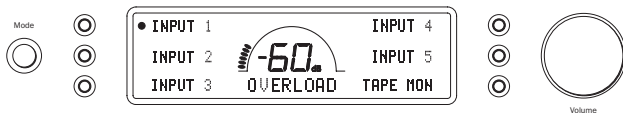

Description - CAP5 offers V/I protection by constantly monitoring the output transistors to keep them working inside their Safe Operating Area (SOA). The SOA is a set of limits given by the output transistor manufacturer to ensure reliability. When triggered, the output relays disconnect the amplifier from the loudspeakers and the display shows a flashing "OVERLOAD" indication.

Remedy - The resistance on the loudspeaker terminals may be too low. Switch off power and check to see if there is a short circuit between the loudspeaker terminals before switching power on again.

Note: If the indication remains the same and multiple loudspeakers are being used on each loudspeaker output then please remove a pair and retry. If too many loudspeakers are connected to any amplifier causing

the load resistance to drop too low the amplifier will be overloaded. CAP5 will detect this situation. If the indication remains the same with only one set of loudspeakers connected, there may be a fault with one or both of the loudspeakers.

4. Short circuit detection

Indication - Unit has not come out of Standby, display flashes “SPKR SHORT”.



Description - During power up from Standby CAP5 performs a check on the loudspeaker terminals to see if a short across the terminals has been accidentally introduced (display flashes “SPKR CHECK”). If the resistance measured across the loudspeaker terminals is too low the unit will stay in Standby mode until the fault has been removed and Power up is re-attempted (display flashes “SPKR SHORT”).

Remedy - User related fault. There may be a short circuit between the loudspeaker terminals. Check all loudspeaker connections before attempting to switch the unit out of Standby (display will flash “SPKR CHECK” then “SPKR OK” when short circuit fixed).

It is possible to disable the short circuit detection feature by pressing the SHORT DT button to off when in the 740A System Configure menu, but it is not recommended. This would only be required if the loudspeakers have very low DC resistance.

5. Intelligent clipping detection

Indication - Volume is reduced automatically, “CLIPPING” appears on the front panel display.

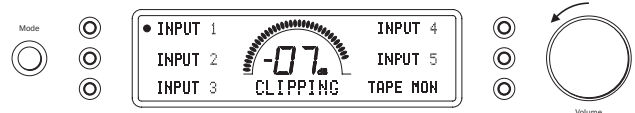

Description - CAP5 has the ability to detect when the amplifier starts to clip or overdrive at its output, which can damage loudspeakers, and degrade the sound. Clipping distortion is caused at high volume levels when the output signal attempts to go outside the maximum voltage that the amplifier can provide, causing the tops of the signal to flatten off. When CAP5 detects clipping the volume will be automatically reduced down until CAP5 detects an undistorted output.

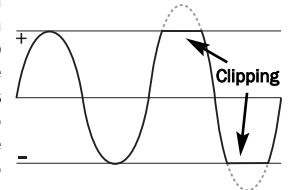

It is possible to disable the clipping detection feature by pressing the CLIP DT button to off when in the 740A System Configure menu.

Note: Disabling the clipping detection is not advised as this feature has been added deliberately to protect the amplifier and loudspeakers.

Troubleshooting

There is no power

Ensure the AC power cord is connected securely.
 Ensure the plug is fully inserted into the wall socket and is switched on.
 Check fuse in the mains plug or adaptor.

There is no sound

Make sure the unit is not in Standby mode.
 Check that source component is properly connected.
 Check that 'TAPE MON' is not switched on (unless tape input is required).
 Check that your speakers are properly connected.
 If using Speaker B terminals check they are switched on.
 Make sure unit is not in mute mode.

There is no sound on one channel

Ensure that balance control is in the correct position.
 Check speaker connections.
 Check interconnects.

There is a loud buzz or hum

Check turntable or tone arm for ground and connection lead fault.
 Ensure no interconnects are loose or defective.
 Ensure that your tape deck/turntable is not too close to the amplifier.

Unable to make or play tape recordings

Check that TAPE MON and TAPE OUT have been connected correctly.

There is weak bass or diffused stereo imaging

Ensure that speakers are not wired out of phase.

Message on display flashing

See section on CAP5 protection system.

The remote handset will not function

Check that the batteries have not expired.
 Ensure that nothing is blocking the remote sensor.
 Check that the Front Panel IR dip-switch on rear panel is set to 'On'.

No response from unit when both In and Out Control Bus sockets are connected

Set Control Bus Passthru dip-switch on rear panel to 'Off'.

For more frequently asked questions (FAQs), technical advice and information on getting the most out of your 740A, please visit the Support section on Cambridge Audio's website:
www.cambridge-audio.com/support.php

For all servicing, in or out of warranty, please contact your dealer.

Technical specifications

Power Output	100W RMS into 8 Ohms 150W RMS into 4 Ohms
THD (unweighted)	< 0.001% 1 kHz at 80% of rated power < 0.01% 20 Hz - 20 kHz at 80% of rated power
Frequency Response	10 Hz - 50 kHz +/- 1 dB
S/N ratio (ref 1W/8 Ohm)	> 96 dB
Input impedances	Inputs 1-6 47 kOhm Tape Input 47 kOhm
Power Amp damping factor	> 110 at 1 kHz
Max power consumption	750W
Minimum power consumption	Active (no signal) 45W Standby 6W
Bass & Treble controls	Shelving type Max bass boost/cut +/- 10 dB at 10 Hz Max treble boost/cut +/- 7.5 dB at 20 kHz
Dimensions (H x W x D)	115 x 430 x 350mm (4.5 x 16.9 x 13.8")
Weight	10.7kg (23.5Lbs)

Cambridge Audio is a brand of Audio Partnership Plc
Registered Office: Gallery Court, Hankey Place
London SE1 4BB, United Kingdom
Registered in England No. 2953313

www.cambridge-audio.com

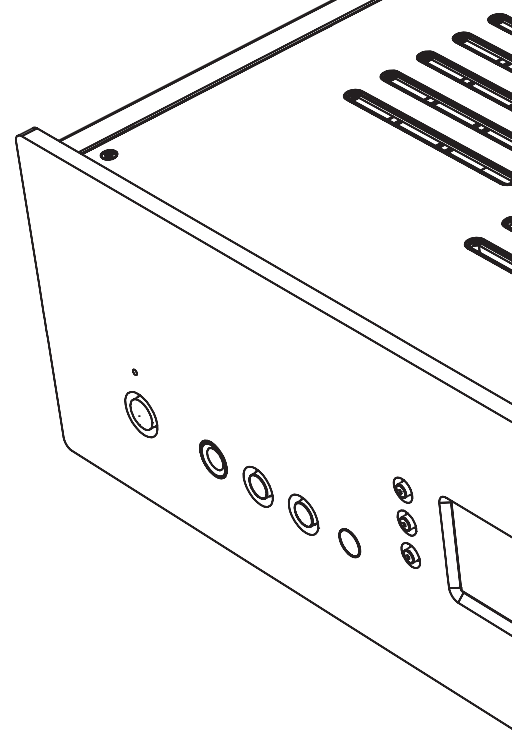

© 2009 Cambridge Audio Ltd

AP20100/3

Free Manuals Download Website

<http://myh66.com>

<http://usermanuals.us>

<http://www.somanuals.com>

<http://www.4manuals.cc>

<http://www.manual-lib.com>

<http://www.404manual.com>

<http://www.luxmanual.com>

<http://aubethermostatmanual.com>

Golf course search by state

<http://golfingnear.com>

Email search by domain

<http://emailbydomain.com>

Auto manuals search

<http://auto.somanuals.com>

TV manuals search

<http://tv.somanuals.com>