



Controls, Start-Up, Operation, Service, and Troubleshooting

SAFETY CONSIDERATIONS

Installing, starting up, and servicing this equipment can be hazardous due to system pressures, electrical components, and equipment location (elevated structures, mechanical rooms, etc.). Only trained, qualified installers and service mechanics should install, start up, and service this equipment.

When working on this equipment, observe precautions in the literature, and on tags, stickers, and labels attached to the equipment, and any other safety precautions that apply. Follow all safety codes. Wear safety glasses and work gloves. Use care in handling, rigging, and setting this equipment, and in handling all electrical components.

⚠ WARNING

Electrical shock can cause personal injury and death. Shut off all power to this equipment during installation. There may be more than one disconnect switch. Tag all disconnect locations to alert others not to restore power until work is completed.

⚠ WARNING

DO NOT VENT refrigerant relief valves within a building. Outlet from relief valves must be vented outdoors in accordance with the latest edition of ANSI/ASHRAE (American National Standards Institute/American Society of Heating, Refrigerating and Air Conditioning Engineers) 15 (Safety Code for Mechanical Refrigeration). The accumulation of refrigerant in an enclosed space can displace oxygen and cause asphyxiation. Provide adequate ventilation in enclosed or low overhead areas. Inhalation of high concentrations of vapor is harmful and may cause heart irregularities, unconsciousness or death. Misuse can be fatal. Vapor is heavier than air and reduces the amount of oxygen available for breathing. Product causes eye and skin irritation. Decomposition products are hazardous.

⚠ WARNING

DO NOT attempt to unbrazed factory joints when servicing this equipment. Compressor oil is flammable and there is no way to detect how much oil may be in any of the refrigerant lines. Cut lines with a tubing cutter as required when performing service. Use a pan to catch any oil that may come out of the lines and as a gage for how much oil to add to system. DO NOT re-use compressor oil. Damage to equipment or personal injury may result.

⚠ CAUTION

This unit uses a microprocessor-based electronic control system. Do not use jumpers or other tools to short out components, or to bypass or otherwise depart from recommended procedures. Any short-to-ground of the control board or accompanying wiring may destroy the electronic modules or electrical components.

⚠ CAUTION

To prevent potential damage to heat exchanger, always run fluid through heat exchanger when adding or removing refrigerant charge. Use appropriate brine solutions in cooler fluid loop to prevent the freezing of brazed plate heat exchanger when the equipment is exposed to temperatures below 32 F (0° C). Proof of flow switch is factory installed on all models. Do NOT remove power from this chiller during winter shutdown periods without taking precaution to remove all water from heat exchanger and optional hydronic system. Failure to properly protect the system from freezing may constitute abuse and may void warranty.

⚠ CAUTION

Compressors require specific rotation. Monitor control alarms during first compressor start up for reverse rotation protection. Damage to unit may result.

⚠ CAUTION

Refrigerant charge must be removed slowly to prevent loss of compressor oil that could result in compressor failure.

⚠ CAUTION

Puron® refrigerant (R-410A) systems operate at higher pressures than standard R-22 systems. Do not use R-22 service equipment or components on Puron refrigerant equipment. If service equipment is not rated for Puron refrigerant, equipment damage or personal injury may result.

CONTENTS

	Page
SAFETY CONSIDERATIONS	1
GENERAL	2-13
Conventions Used in this Manual	2
Basic Controls Usage	3
CONTROLS	14-33
General	14
Main Base Board (MBB)	14
Energy Management Module (EMM)	14
Current Sensor Board (CSB)	14
Enable/Off/Remote Contact Switch	14
Emergency On/Off Switch	14
Board Addresses	14
Control Module Communication	14
Carrier Comfort Network® Interface	14
Sensors	19
• COOLER LEAVING FLUID SENSOR	
• COOLER ENTERING FLUID SENSOR	
• CONDENSER LEAVING FLUID SENSOR	
• CONDENSER ENTERING FLUID SENSOR	
• COMPRESSOR RETURN GAS	
TEMPERATURE SENSOR	
• OUTDOOR-AIR TEMPERATURE SENSOR	
• DUAL LEAVING WATER TEMPERATURE SENSOR	
• REMOTE SPACE TEMPERATURE SENSOR	
Energy Management Module	21
Loss-of-Cooler Flow Protection	21
Condenser Flow Protection	21
Thermostatic Expansion Valves (TXV)	21
Capacity Control	21
• MINUTES LEFT FOR START	
• MINUTES OFF TIME	
• LEAD/LAG DETERMINATION	
• CAPACITY CONTROL OVERRIDES	
Operation of Machine Based on Control Method	
and Cooling Set Point Selection Settings	24
Cooling Set Point Select	24
Cooler Pump Control	24
Ice Mode	24
Service Test	24
Cooler Pump Sequence of Operation	25
Condenser Pump/Condenser Fan Output	
Control	25
Configuring and Operating Dual Chiller Control	25
Temperature Reset	27
Demand Limit	31
• DEMAND LIMIT (2-Stage Switch Controlled)	
• EXTERNALLY POWERED DEMAND LIMIT	
(4 to 20 mA Controlled)	
• DEMAND LIMIT (CCN Loadshed Controlled)	
Cooling Set Point (4 to 20 mA)	32
PRE-START-UP	33,34
System Check	33
START-UP AND OPERATION	34-36
Actual Start-Up	34
Check Refrigerant Charge	34
Operating Limitations	35
• TEMPERATURES	
• VOLTAGE — ALL UNITS	
OPERATION SEQUENCE	36
SERVICE	36-44
Electronic Components	36
• CONTROL COMPONENTS	
Compressor Replacement	36
30MPW Condenser and 30MP Cooler	36
• BRAZED-PLATE COOLER AND CONDENSER	
HEAT EXCHANGER REPLACEMENT	
• BRAZED-PLATE COOLER AND CONDENSER	
HEAT EXCHANGER CLEANING	
Oil Charge	37
Check Refrigerant Feed Components	37
• FILTER DRIER	
• MOISTURE-LIQUID INDICATOR	
• THERMOSTATIC EXPANSION VALVE (TXV)	

• MINIMUM LOAD VALVE	
• PRESSURE RELIEF DEVICES	
Check Unit Safeties	38
Thermistors	38
Pressure Transducers	38
Chilled Water Flow Switch	39
Strainer	43
Replacing Defective Modules	43
MAINTENANCE	44,45
Recommended Maintenance Schedule	44
TROUBLESHOOTING	44-52
Complete Unit Stoppage and Restart	44
• GENERAL POWER FAILURE	
• UNIT ENABLE-OFF-REMOTE CONTACT SWITCH IS OFF	
• CHILLED FLUID PROOF-OF-FLOW SWITCH OPEN	
• OPEN 24-V CONTROL CIRCUIT BREAKERS	
• COOLING LOAD SATISFIED	
• THERMISTOR FAILURE	
• LOW SATURATED SUCTION	
• COMPRESSOR SAFETIES	
Alarms and Alerts	45
APPENDIX A — LOCAL DISPLAY TABLES	53-64
APPENDIX B — CCN TABLES	65-72
START-UP CHECKLIST FOR 30MP LIQUID CHILLER	CL-1 to CL-8

GENERAL

This publication contains Start-Up, Service, Controls, Operation, and Troubleshooting information for the 30MPW water-cooled chillers and the 30MPA air-cooled chillers. See Table 1. These liquid chillers are equipped with *ComfortLink* controls and conventional thermostatic expansion valves (TXVs). The 30MPA units and the 30MPW units with optional medium temperature brine are also equipped with liquid line solenoid valves (LLSVs).

CAUTION

This unit uses a microprocessor-based electronic control system. Do not use jumpers or other tools to short out or bypass components or otherwise depart from recommended procedures. Any short-to-ground of the control board or accompanying wiring may destroy the board or electrical component.

Table 1 — Unit Sizes

UNIT MODEL	NOMINAL TONS
30MPA,MPW015	15
30MPA,MPW020	20
30MPA,MPW030	30
30MPA,MPW040	40
30MPA,MPW045	45

Conventions Used in This Manual — The following conventions for discussing configuration points for the local display (scrolling marquee or Navigator™ accessory) will be used in this manual.

Point names will be written with the mode name first, then any sub-modes, then the point name, each separated by an arrow symbol (→). Names will also be shown in bold and italics. As an example, the Minimum Load Valve Select Point, which is located in the Configuration mode, Option 1 sub-mode, would be written as ***Configuration→OPT1→MLVS***.

This path name will show the user how to navigate through the local display to reach the desired configuration. The user would scroll through the modes and sub-modes using the ▲ and ▼ keys. The arrow symbol in the path name represents pressing **ENTER** to move into the next level of the menu structure.

When a value is included as part of the path name, it will be shown at the end of the path name after an equals sign. If the value represents a configuration setting, an explanation will be shown in parenthesis after the value. As an example, **Configuration→OPT1→MLV.S = 1** (Minimum Load Valve Select).

Pressing the **ESCAPE** and **ENTER** keys simultaneously will scroll an expanded text description of the point name or value across the display. The expanded description is shown in the local display tables but will not be shown with the path names in text.

The CCN (Carrier Comfort Network®) point names are also referenced in the local display tables for users configuring the unit with CCN software instead of the local display. The CCN tables are located in Appendix B of the manual.

Basic Control Usage

SCROLLING MARQUEE DISPLAY — The scrolling marquee display is the standard interface display to the *ComfortLink* Control System for 30MP units. The display has up and down arrow keys, an **ENTER** key, and an **ESCAPE** key. These keys are used to navigate through the different levels of the display structure. Press the **ESCAPE** key until the highest operating level is displayed to move through the top 11 mode levels indicated by LEDs (light emitting diodes) on the left side of the display. See Fig. 1 and Tables 2-14.

Once within a mode or sub-mode, pressing the **ENTER** and **ESCAPE** keys simultaneously will put the scrolling marquee display into expanded text mode where the full meaning of all sub-modes, items and their values can be displayed for the current selection. Press the **ENTER** and **ESCAPE** keys to return the scrolling marquee display to its default menu of rotating display items (those items in **Run Status→VIEW**). In addition, the password will be disabled, requiring that it be entered again before changes can be made to password protected items. Press the **ESCAPE** key to exit out of the expanded text mode.

NOTE: When the Language Selection (**Configuration→DISP→LANG**), variable is changed, all appropriate display expansions will immediately change to the new language. No power-off or control reset is required when reconfiguring languages.

When a specific item is located, the item name alternates with the value. Press the **ENTER** key at a changeable item and the value will be displayed. Press **ENTER** again and the value will begin to flash indicating that the value can be changed. Use the up and down arrow keys to change the value, and confirm the value by pressing the **ENTER** key.

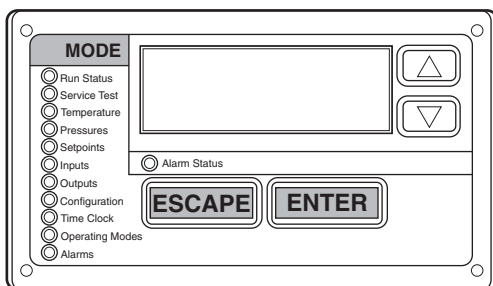

Fig. 1 — Scrolling Marquee Display

Changing item values or testing outputs is accomplished in the same manner. Locate and display the desired item. Press **ENTER** so that the item value flashes. Use the arrow keys to change the value or state and press the **ENTER** key to accept it. Press the **ESCAPE** key to return to the next higher level of structure. Repeat the process as required for other items.

Items in the Configuration and Service Test modes are password protected. The words ‘PASS’ and ‘WORD’ will alternate on the display when required. The default password is 0111. Press **ENTER** and the 1111 password will be displayed. Press **ENTER** again and the first digit will begin to flash. Use the arrow keys to change the number and press **ENTER** to accept the digit. Continue with the remaining digits of the password. The password can only be changed through CCN operator interface software such as *ComfortWORKS*®, *ComfortVIEW*™ and *Service Tool*.

See Tables 2-14 and Appendix A for further details.

ACCESSORY NAVIGATOR™ DISPLAY MODULE — The Navigator module provides a mobile user interface to the *ComfortLink*™ control system, which is only available as a field-installed accessory. The display has up and down arrow keys, an **ENTER** key, and an **ESCAPE** key. These keys are used to navigate through the different levels of the display structure. Press the **ESCAPE** key until ‘Select a Menu Item’ is displayed to move through the top 11 mode levels indicated by LEDs on the left side of the display. See Fig. 2.

Once within a Mode or sub-mode, a “>” indicates the currently selected item on the display screen. Pressing the **ENTER** and **ESCAPE** keys simultaneously will put the Navigator module into expanded text mode where the full meaning of all sub-modes, items and their values can be displayed. Pressing the **ENTER** and **ESCAPE** keys when the display says ‘Select Menu Item’ (Mode LED level) will return the Navigator module to its default menu of rotating display items (those items in **Run Status→VIEW**). In addition, the password will be disabled, requiring that it be entered again before changes can be made to password protected items. Press the **ESCAPE** key to exit out of the expanded text mode.

NOTE: When the Language Selection (**Configuration→DISP→LANG**), variable is changed, all appropriate display expansions will immediately change to the new language. No power-off or control reset is required when reconfiguring languages.

When a specific item is located, the item name appears on the left of the display, the value will appear near the middle of the display and the units (if any) will appear on the far right of the display. Press the **ENTER** key at a changeable item and the value will begin to flash. Use the up and down arrow keys to change the value, and confirm the value by pressing the **ENTER** key.

Changing item values or testing outputs is accomplished in the same manner. Locate and display the desired item. Press **ENTER** so that the item value flashes. Use the arrow keys to change the value or state and press the **ENTER** key to accept it. Press the **ESCAPE** key to return to the next higher level of structure. Repeat the process as required for other items.

Items in the Configuration and Service Test modes are password protected. The words **Enter Password** will be displayed when required, with 1111 also being displayed. The default password is 1111. Use the arrow keys to change the number

and press **ENTER** to enter the digit. Continue with the remaining digits of the password. The password can only be changed through CCN operator interface software such as ComfortWORKS, ComfortVIEW and Service Tool.

Adjusting the Contrast — The contrast of the display can be adjusted to suit ambient conditions. To adjust the contrast of the Navigator module, press the **ESCAPE** key until the display reads, “Select a menu item.” Using the arrow keys move to the Configuration mode. Press **ENTER** to obtain access to this mode. The display will read:

```
> TEST OFF
METR OFF
LANG ENGLISH
```

Pressing **ENTER** will cause the “OFF” to flash. Use the up or down arrow to change “OFF” to “ON”. Pressing **ENTER** will illuminate all LEDs and display all pixels in the view screen. Pressing **ENTER** and **ESCAPE** simultaneously allows the user to adjust the display contrast. Use the up or down arrows to adjust the contrast. The screen’s contrast will change with the adjustment. Press **ENTER** to accept the change. The Navigator module will keep this setting as long as it is plugged in to the LEN bus.

Adjusting the Backlight Brightness — The backlight of the display can be adjusted to suit ambient conditions. The factory default is set to the highest level. To adjust the backlight of the Navigator module, press the **ESCAPE** key until the display reads, “Select a menu item.” Using the arrow keys move to the

Configuration mode. Press **ENTER** to obtain access to this mode. The display will read:

```
> TEST OFF
METR OFF
LANG ENGLISH
```

Pressing **ENTER** will cause the “OFF” to flash. Use the up or down arrow keys to change “OFF” to “ON”. Pressing **ENTER** will illuminate all LEDs and display all pixels in the view screen. Pressing the up and down arrow keys simultaneously allows the user to adjust the display brightness. Use the up or down arrow keys to adjust screen brightness. Press **ENTER** to accept the change. The Navigator module will keep this setting as long as it is plugged in to the LEN bus.



Fig. 2 — Accessory Navigator™ Display Module

Table 2 — Scrolling Marquee Display Menu Structure*

MODE	RUN STATUS	SERVICE TEST	TEMPERATURES	PRESSURES	SET POINTS	INPUTS	OUTPUTS	CONFIGURATION	TIME CLOCK	OPERATING MODES	ALARMS
	Auto View of Run Status (VIEW)	Service Test Mode (TEST)	Unit Temperatures (UNIT)	Pressures Circuit A (PRC.A)	Cooling Setpoints (COOL)	General Inputs (GEN.I)	General Outputs (GEN.O)	Display Configuration (DISP)	Time of Day (TIME)	Modes (MODE)	Current (CRNT)
	Unit Run Hour and Start (RUN)	Outputs and Pumps (OUTS)	Temperatures Circuit A (CIR.A)		Head Pressure Setpoint (HEAD)	Circuit Inputs (CRCT)	Outputs Circuit A (CIR.A)	Unit Configuration (UNIT)	Month, Date, Day, and Year (DATE)		Reset Alarms (RCRN)
	Circuit and Compressor Run Hours (HOUR)	Circuit A Comp Test (CMPA)			Brine Freeze Setpoint (FRZ)	4-20mA Inputs (4-20)		Unit Options 1 Hardware (OPT1)	Daylight Savings Time (DST)		Alarm History (HIST)
	Compressor Starts (STRT)							Unit Options 2 Controls (OPT2)	Local Holiday Schedules (HOL.L)		
SUB-MODE	Preventive Maintenance (PM)							CCN Network Configuration (CCN)	Schedule Number (SCH.N)		
	Software Version (VERS)							Reset Cool Temp (RSET)	Local Occupancy Schedule (SCH.L)		
								Set Point and Ramp Load (SLCT)	Schedule Override (OVR)		
								Service Configuration (SERV)			
								Broadcast Configuration (BCST)			

LEGEND

Ckt — Circuit

*Throughout this text, the location of items in the menu structure will be described in the following format:

Item Expansion (Mode Name → Sub-mode Name → ITEM)

For example, using the language selection item:

Language Selection (**Configuration** → **DISP** → **LANG**)

Table 3 — Run Status Mode and Sub-Mode Directory

SUB-MODE	KEYPAD ENTRY	ITEM	DISPLAY	SUB-ITEM	DISPLAY	SUB-ITEM	DISPLAY	ITEM EXPANSION	COMMENT
VIEW	ENTER	EWT	XXX.X °F					ENTERING FLUID TEMP	
	↓	LWT	XXX.X °F					LEAVING FLUID TEMP	
	↓	SETP	XXX.X °F					ACTIVE SETPOINT	
	↓	CTPT	XXX.X °F					CONTROL POINT	
	↓	LOD.F	XXX					LOAD/UNLOAD FACTOR	
	↓	STAT	X					CONTROL MODE	0 = Service Test 1 = Off Local 2 = Off CCN 3 = Off Time 4 = Off Emrgcy 5 = On Local 6 = On CCN 7 = On Time 8 = Ht Enabled 9 = Pump Delay
	↓	OCC	YES/NO					OCCUPIED	
	↓	MODE	YES/NO					OVERRIDE MODES IN EFFECT	
	↓	CAP	XXX %					PERCENT TOTAL CAPACITY	
	↓	STGE	X					REQUESTED STAGE	
	↓	ALRM	XXX					CURRENT ALARMS & ALERTS	
	↓	TIME	XX.XX					TIME OF DAY	00.00-23.59
	↓	MNTH	XX					MONTH OF YEAR	1 = January, 2 = February, etc.
	↓	DATE	XX					DAY OF MONTH	01-31
↓	YEAR	XX					YEAR OF CENTURY		
RUN	ENTER	HRS.U	XXXX HRS					MACHINE OPERATING HOURS	
	↓	STR.U	XXXX					MACHINE STARTS	
	↓	HR.P1	XXXX.X					PUMP 1 RUN HOURS	
	↓	HR.P2	XXXX.X					PUMP 2 RUN HOURS	
HOUR	ENTER	HR.A1	XXXX HRS					COMPRESSOR A1 RUN HOURS	
	↓	HR.A2	XXXX HRS					COMPRESSOR A2 RUN HOURS	
	↓	HR.A3	XXXX HRS					COMPRESSOR A3 RUN HOURS	
STRT	ENTER	ST.A1	XXXX					COMPRESSOR A1 STARTS	
	↓	ST.A2	XXXX					COMPRESSOR A2 STARTS	
	↓	ST.A3	XXXX					COMPRESSOR A3 STARTS	
PM	ENTER	STRN						STRAINER MAINTENANCE	
	ENTER			SI.ST	XXXX HRS			STRAINER SRVC INTERVAL	
	↓			S.T.DN	XXXX HRS			STRAINER SRVC COUNTDOWN	
	↓			S.T.MN	YES/NO			STRAINER MAINT. DONE	User Entry
	↓			ST.DT				STRAINER MAINT. DATES	
	ENTER					S.T.M0		MM/DD/YY HH:MM	
	↓					S.T.M1		MM/DD/YY HH:MM	
	↓					S.T.M2		MM/DD/YY HH:MM	
	↓					S.T.M3		MM/DD/YY HH:MM	
↓					S.T.M4		MM/DD/YY HH:MM		

Table 3 — Run Status Mode and Sub-Mode Directory (cont)

SUB-MODE	KEYPAD ENTRY	ITEM	DISPLAY	SUB-ITEM	DISPLAY	SUB-ITEM	DISPLAY	ITEM EXPANSION	COMMENT
VERS	ENTER	AUX						CESR131333-xx-xx	xx-xx is Version number*
	↓	MBB						CESR131279-xx-xx	xx-xx is Version number*
	↓	EMM						CESR131174-xx-xx	xx-xx is Version number*
	↓	MARQ						CESR131171-xx-xx	xx-xx is Version number*
	↓	NAVI						CESR130227-xx-xx	xx-xx is Version number*



*Press  and  simultaneously to obtain version number.

Table 4 — Service Test Mode and Sub-Mode Directory

SUB-MODE	KEYPAD ENTRY	ITEM	DISPLAY	ITEM EXPANSION	COMMENT
TEST	ENTER		ON/OFF	SERVICE TEST MODE	To Enable Service Test Mode, move Enable/Off/Remote Contact switch to OFF. Change TEST to ON. Move switch to ENABLE.
OUTS				OUTPUTS AND PUMPS	
	↓	CLR.P	ON/OFF	COOLER PUMP RELAY	
	↓	CND.P	ON/OFF	CONDENSER PUMP	
	↓	UL.TM	0 to 15	COMP A1 UNLOAD TIME	
	↓	CC.H	ON/OFF	CRANKCASE HEATER	
	↓	CW.VO	ON/OFF	CONDENSER VALVE OPEN	
	↓	CW.VC	ON/OFF	CONDENSER VALVE CLOSE	
	↓	LL.SV	ON/OFF	LIQUID LINE SOLENOID	
CMPA				CIRCUIT A COMPRESSOR TEST	
	ENTER	CC.A1	ON/OFF	COMPRESSOR A1 RELAY	
	↓	UL.TM	0 to 15	COMP A1 UNLOAD TIME	
	↓	CC.A2	ON/OFF	COMPRESSOR A2 RELAY	
	↓	CC.A3	ON/OFF	COMPRESSOR A3 RELAY	
	↓	MLV	ON/OFF	MINIMUM LOAD VALVE RELAY	

Table 5 — Temperature Mode and Sub-Mode Directory

SUB-MODE	KEYPAD ENTRY	ITEM	DISPLAY	ITEM EXPANSION	COMMENT
UNIT				ENT AND LEAVE UNIT TEMPS	
	ENTER	CEWT	XXX.X °F	COOLER ENTERING FLUID	
	↓	CLWT	XXX.X °F	COOLER LEAVING FLUID	
	↓	CDET	XXX.X °F	CONDENSER ENTERING FLUID	
	↓	CDLT	XXX.X °F	CONDENSER LEAVING FLUID	
	↓	OAT	XXX.X °F	OUTSIDE AIR TEMPERATURE	
	↓	SPT	XXX.X °F	SPACE TEMPERATURE	
	↓	DLWT	XXX.X °F	LEAD/LAG LEAVING FLUID	

Table 5 — Temperature Mode and Sub-Mode Directory (cont)

SUB-MODE	KEYPAD ENTRY	ITEM	DISPLAY	ITEM EXPANSION	COMMENT
CIR.A				TEMPERATURES CIRCUIT A	
	ENTER	SCT.A	XXX.X °F	SATURATED CONDENSING TMP	
	↓	SST.A	XXX.X °F	SATURATED SUCTION TEMP	
	↓	RGT.A	XXX.X °F	COMPR RETURN GAS TEMP	
	↓	D.GAS	XXX.X °F	DISCHARGE GAS TEMP	
	↓	SH.A	XXX.X °F	SUCTION SUPERHEAT TEMP	

Table 6 — Pressure Mode and Sub-Mode Directory

SUB-MODE	KEYPAD ENTRY	ITEM	DISPLAY	ITEM EXPANSION	COMMENT
PRC.A				PRESSURES CIRCUIT A	
	ENTER	DPA	XXX.X PSIG	DISCHARGE PRESSURE	
	↓	SPA	XXX.X PSIG	SUCTION PRESSURE	

Table 7 — Set Points Mode and Sub-Mode Directory

SUB-MODE	KEYPAD ENTRY	ITEM	DISPLAY	ITEM EXPANSION	COMMENT
COOL				COOLING SETPOINTS	
	ENTER	CSP.1	XXX.X °F	COOLING SETPOINT 1	Default: 44 F
	↓	CSP.2	XXX.X °F	COOLING SETPOINT 2	Default: 44 F
	↓	CSP.3	XXX.X °F	ICE SETPOINT	Default: 32 F
HEAD				HEAD PRESSURE SETPOINTS	
	ENTER	H.DP	XXX.X °F	HEAD SETPOINT	Default: 95 F
FRZ				BRINE FREEZE SETPOINT	
	ENTER	BR.FZ	XXX.X °F	BRINE FREEZE POINT	Default: 34 F

Table 8 — Inputs Mode and Sub-Mode Directory

SUB-MODE	KEYPAD ENTRY	ITEM	DISPLAY	ITEM EXPANSION	COMMENT
GEN.I				GENERAL INPUTS	
	ENTER	STST	STRT/STOP	START/STOP SWITCH	
	↓	FLOW	ON/OFF	COOLER FLOW SWITCH	
	↓	CD.FL	OPEN/CLSE	CONDENSER FLOW SWITCH	
	↓	DLS1	ON/OFF	DEMAND LIMIT SWITCH 1	
	↓	DLS2	ON/OFF	DEMAND LIMIT SWITCH 2	
	↓	ICED	ON/OFF	ICE DONE	
	↓	DUAL	ON/OFF	DUAL SETPOINT SWITCH	
CRCT				CIRCUITS INPUTS	
	ENTER	FKA1	ON/OFF	COMPRESSOR A1 FEEDBACK	
	↓	FKA2	ON/OFF	COMPRESSOR A2 FEEDBACK	
	↓	FKA3	ON/OFF	COMPRESSOR A3 FEEDBACK	
4-20				4-20 MA INPUTS	
	ENTER	DMND	XX.X MA	4-20 MA DEMAND SIGNAL	
	↓	RSET	XX.X MA	4-20 MA RESET SIGNAL	
	↓	CSP	XX.X MA	4-20 MA COOLING SETPOINT	

Table 9 — Outputs Mode and Sub-Mode Directory

SUB-MODE	KEYPAD ENTRY	ITEM	DISPLAY	ITEM EXPANSION	COMMENT
GEN.O				GENERAL OUTPUTS	
	ENTER	C.LWP	ON/OFF	COOLER PUMP RELAY	
	↓	C.DWP	ON/OFF	CONDENSER PUMP	
	↓	ALRM	ON/OFF	ALARM RELAY	
	↓	CDWO	ON/OFF	CONDENSER VALVE OPEN	
	↓	CDWC	ON/OFF	CONDENSER VALVE CLOSE	
CIR.A				OUTPUTS CIRCUIT A	
	ENTER	CC.A1	ON/OFF	COMPRESSOR A1 RELAY	
	↓	D.SOL	ON/OFF	DIGITAL SCROLL SOLENOID	
	↓	CC.A2	ON/OFF	COMPRESSOR A2 RELAY	
	↓	CC.A3	ON/OFF	COMPRESSOR A3 RELAY	
	↓	CCH	ON/OFF	CRANKCASE HEATER RELAY	
	↓	LLSV	ON/OFF	LIQUID LINE SOLENOID	
	↓	MLV.R	ON/OFF	MINIMUM LOAD VALVE RELAY	

Table 10 — Configuration Mode and Sub-Mode Directory

SUB-MODE	KEYPAD ENTRY	ITEM	DISPLAY	ITEM EXPANSION	COMMENT
DISP				DISPLAY CONFIGURATION	
	ENTER	TEST	ON/OFF	TEST DISPLAY LEDS	
	↓	METR	ON/OFF	METRIC DISPLAY	Off = English On = Metric
	↓	LANG	X	LANGUAGE SELECTION	Default: 0 0 = English 1 = Espanol 2 = Francais 3 = Portuguese
	↓	PAS.E	ENBL/DSBL	PASSWORD ENABLE	Default: Enable
	↓	PASS	xxxx	SERVICE PASSWORD	Default: 1111
UNIT	ENTER			UNIT CONFIGURATION	
	↓	TYPE	x	UNIT TYPE	2=WaterCooled 3=Split System
	↓	SIZE	XX	UNIT SIZE	
	↓	SZA.1	XX	COMPRESSOR A1 SIZE	Unit Dependent
	↓	SZA.2	XX	COMPRESSOR A2 SIZE	Unit Dependent
	↓	SZA.3	XX	COMPRESSOR A3 SIZE	Unit Dependent
	↓	A1.TY	No/Yes	COMPRESSOR A1 DIGITAL?	Default: Yes (A1 Digital Scroll)
	↓	MAX.T	0 to 15	MAXIMUM A1 UNLOAD TIME	Default: 7

Table 10 — Configuration Mode and Sub-Mode Directory (cont)

SUB-MODE	KEYPAD ENTRY	ITEM	DISPLAY	ITEM EXPANSION	COMMENT
OPT1				UNIT OPTIONS 1 HARDWARE	
	ENTER	FLUD	X	COOLER FLUID	Default: Water 1 = Water 2 = Medium Temperature Brine
	↓	MLV.S	YES/NO	MINIMUM LOAD VALVE SELECT	Default: No
	↓	R.G.EN	ENBL/DSBL	RETURN GAS SENSOR ENABLE	
	↓	OAT.E	ENBL/DSBL	ENABLE OAT SENSOR	
	↓	D.G.EN	ENBL/DSBL	DISCHARGE GAS TEMP ENABLE	
	↓	CSB.E	ENBL/DSBL	CSB BOARDS ENABLE	
	↓	CPC	ON/OFF	COOLER PUMP CONTROL	Default: On
	↓	PM.DY	XX MIN	COOLER PUMP SHUTDOWN DLY	0 to 10 minutes, Default: 1 min.
	↓	DPME	x	ENABLE CONDENSER PUMP	0 to 2
	↓	DFLS	ENBL/DSBL	ENABLE COND FLOW SWITCH	
↓	CDWS	ENBL/DSBL	ENABLE COND WTR SENSORS		
OPT2				UNIT OPTIONS 2 CONTROLS	
	ENTER	CTRL	X	CONTROL METHOD	Default: Switch 0 = Enable/Off/Remote Switch 2 = Occupancy 3 = CCN Control
	↓	LCWT	XX.X ΔF	HIGH LCW ALERT LIMIT	Default: 60 Range: 2 to 60 °F
	↓	DELY	XX	MINUTES OFF TIME	Default: 0 Minutes Range: 0 to 15 Minutes
	↓	ICE.M	ENBL/DSBL	ICE MODE ENABLE	Default: Disable
CCN				CCN NETWORK CONFIGURATION	
	ENTER	CCNA	XXX	CCN ADDRESS	Default: 1 Range: 1 to 239
	↓	CCNB	XXX	CCN BUS NUMBER	Default: 0 Range: 0 to 239
	↓	BAUD	X	CCN BAUD RATE	Default: 9600 1 = 2400 2 = 4800 3 = 9600 4 = 19,200 5 = 38,400
RSET				RESET COOL TEMP	
	ENTER	CRST	X	COOLING RESET TYPE	Default: No Reset 0 = No Reset 1 = 4 to 20 mA Input 2 = Outdoor Air Temperature 3 = Return Fluid 4 = Space Temperature
	↓	MA.DG	XX.X ΔF	4-20 - DEGREES RESET	Default: 0.0 ΔF Range: -30 to 30 ΔF
	↓	RM.NO	XXX.X °F	REMOTE - NO RESET TEMP	Default: 125 F (51.7 C) Range: 0° to 125 F
	↓	RM.F	XXX.X °F	REMOTE - FULL RESET TEMP	Default: 0.0° F (-17.8 C) Range: 0° to 125 F
	↓	RM.DG	XX.X °F	REMOTE - DEGREES RESET	Default: 0.0° F Range: -30 to 30 F
	↓	RT.NO	XXX.X ΔF	RETURN - NO RESET TEMP	Default: 10.0 ΔF (5.6 ΔC) Range: 0° to 125 F COOLER ΔT
	↓	RT.F	XXX.X ΔF	RETURN - FULL RESET TEMP	Default: 0.0 ΔF (0.0 ΔC) Range: 0° to 125 F COOLER ΔT
	↓	RT.DG	XX.X °F	RETURN - DEGREES RESET	Default: 0.0° F Range: -30 to 30 F (-34.4 to -1.1 C)
	↓	DMDC	X	DEMAND LIMIT SELECT	Default: None 0 = None 1 = Switch 2 = 4 to 20 mA Input 3 = CCN Loadshed
	↓	DM20	XXX %	DEMAND LIMIT AT 20 MA	Default: 100% Range: 0 to 100%
	↓	SHNM	XXX	LOADSHED GROUP NUMBER	Default: 0 Range: 0 to 99
	↓	SHDL	XXX %	LOADSHED DEMAND DELTA	Default: 0% Range: 0 to 60%
	↓	SHTM	XXX	MAXIMUM LOADSHED TIME	Default: 60 minutes Range: 0 to 120 minutes
↓	DLS1	XXX %	DEMAND LIMIT SWITCH 1	Default: 80% Range: 0 to 100%	
↓	DLS2	XXX %	DEMAND LIMIT SWITCH 2	Default: 50% Range: 0 to 100%	

Table 10 — Configuration Mode and Sub-Mode Directory (cont)





















SUB-MODE	KEYPAD ENTRY	ITEM	DISPLAY	ITEM EXPANSION	COMMENT
RSET (cont)		LLEN	ENBL/DSBL	LEAD/LAG CHILLER ENABLE	Default: Disable
		MSSL	SLVE/MAST	MASTER/SLAVE SELECT	Default: Master
		SLVA	XXX	SLAVE ADDRESS	Default: 0 Range: 0 to 239
		LLBL	X	LEAD/LAG BALANCE SELECT	Default: Master Leads 0 = Master Leads 1 = Slave Leads 2 = Automatic
		LLBD	XXX	LEAD/LAG BALANCE DELTA	Default: 168 hours Range: 40 to 400 hours
		LLDY	XXX	LAG START DELAY	Default: 5 minutes Range: 0 to 30 minutes
		PARA	YES	PARALLEL CONFIGURATION	Default: YES (CANNOT BE CHANGED)
SLCT				SETPOINT AND RAMP LOAD	
		CLSP	X	COOLING SETPOINT SELECT	Default: Single 0 = Single 1 = Dual Switch 2 = Dual CCN Occupied 3 = 4 to 20 mA Input (requires EMM)
		RL.S	ENBL/DSBL	RAMP LOAD SELECT	Default: Enable
		CRMP	X.X	COOLING RAMP LOADING	Default: 1.0 Range: 0.2 to 2.0
		SCHD	XX	SCHEDULE NUMBER	Default: 1 Range: 1 to 99
SERV		Z.GN	X.X	DEADBAND MULTIPLIER	Default: 1.0 Range: 1.0 to 4.0
				SERVICE CONFIGURATION	
		EN.A1	ENBL/DSBL	ENABLE COMPRESSOR A1	Unit dependent
		EN.A2	ENBL/DSBL	ENABLE COMPRESSOR A2	Unit dependent
		EN.A3	ENBL/DSBL	ENABLE COMPRESSOR A3	Unit dependent
BCST		REV.R	ENBL/DSBL	REVERSE ROTATION ENABLE	Default: Enable
				BROADCAST CONFIGURATION	
		T.D.BC	ON/OFF	CCN TIME/DATE BROADCAST	
		OAT.B	ON/OFF	CCN OAT BROADCAST	
		G.S.BC	ON/OFF	GLOBAL SCHEDULE BROADCAST	
		BC.AK	ON/OFF	CCN BROADCAST ACK'ER	

Table 11 — Time Clock Mode and Sub-Mode Directory

SUB-MODE	KEYPAD ENTRY	ITEM	DISPLAY	SUB-ITEM	DISPLAY	ITEM EXPANSION	COMMENT
TIME						TIME OF DAY	
	ENTER	HH.MM	XX.XX			HOUR AND MINUTE	Military (00:00 – 23:59)
DATE						MONTH,DATE,DAY AND YEAR	
	ENTER	MNTH	XX			MONTH OF YEAR	1-12 (1 = January, 2 = February, etc)
	↓	DOM	XX			DAY OF MONTH	Range: 01-31
	↓	DAY	X			DAY OF WEEK	1-7 (1 = Monday, 2 = Tuesday, etc)
	↓	YEAR	XXXX			YEAR OF CENTURY	
DST						DAYLIGHT SAVINGS TIME	
	ENTER	STR.M	XX			MONTH	Default: 4, Range 1 – 12
	↓	STR.W	X			WEEK	Default: 1, Range 1 – 5
	↓	STR.D	X			DAY	Default: 7, Range 1 – 7
	↓	MIN.A	XX			MINUTES TO ADD	Default: 60, Range 0 – 99
	↓	STP.M	XX			MONTH	Default: 10, Range 1 – 12
	↓	STP.W	XX			WEEK	Default: 5, Range 1 – 5
	↓	STP.D	XX			DAY	Default: 7, Range 1 – 7
HOL.L						LOCAL HOLIDAY SCHEDULES	HD.01 through HD.30
	ENTER	MON	XX			HOLIDAY START MONTH	Range 0 – 12
	↓	DAY	XX			START DAY	Range 0 – 31
	↓	LEN	XX			DURATION (DAYS)	Range 0 - 99
SCH.N			XX			SCHEDULE NUMBER	Default: 1, Range 1 – 99
SCH.L						LOCAL OCCUPANCY SCHEDULE	
	ENTER	PER.1				OCCUPANCY PERIOD 1*	
	ENTER			OCC.1	XX:XX	PERIOD OCCUPIED TIME	Military (00:00 – 23:59)
	↓			UNC.1	XX.XX	PERIOD UNOCCUPIED TIME	Military (00:00 – 23:59)
	↓			MON.1	YES/NO	MONDAY IN PERIOD	
	↓			TUE.1	YES/NO	TUESDAY IN PERIOD	
	↓			WED.1	YES/NO	WEDNESDAY IN PERIOD	
	↓			THU.1	YES/NO	THURSDAY IN PERIOD	
	↓			FRI.1	YES/NO	FRIDAY IN PERIOD	
	↓			SAT.1	YES/NO	SATURDAY IN PERIOD	
	↓			SUN.1	YES/NO	SUNDAY IN PERIOD	
	↓			HOL.1	YES/NO	HOLIDAY IN PERIOD	
OVR						SCHEDULE OVERRIDE	
	ENTER	OVR.T	X			TIMED OVERRIDE HOURS	Default: 0, Range 0-4 hours
	↓	OVR.L	X			OVERRIDE TIME LIMIT	Default: 0, Range 0-4 hours
	↓	T.OVR	YES/NO			TIMED OVERRIDE	User Entry

* Repeats for Occupancy Periods 2 through 8.

Table 12 — Operating Mode and Sub-Mode Directory

SUB-MODE	KEYPAD ENTRY	ITEM	DISPLAY	ITEM EXPANSION	COMMENT
MODE				MODES CONTROLLING UNIT	
	ENTER	MD01	ON/OFF	CSM CONTROLLING CHILLER	
	↓	MD03	ON/OFF	MASTER/SLAVE CONTROL	
	↓	MD05	ON/OFF	RAMP LOAD LIMITED	
	↓	MD06	ON/OFF	TIMED OVERRIDE IN EFFECT	
	↓	MD07	ON/OFF	LOW COOLER SUCTION TEMPA	
	↓	MD09	ON/OFF	SLOW CHANGE OVERRIDE	
	↓	MD10	ON/OFF	MINIMUM OFF TIME ACTIVE	
	↓	MD13	ON/OFF	DUAL SETPOINT	
	↓	MD14	ON/OFF	TEMPERATURE RESET	
	↓	MD15	ON/OFF	DEMAND LIMITED	
	↓	MD16	ON/OFF	COOLER FREEZE PROTECTION	
	↓	MD17	ON/OFF	LOW TEMPERATURE COOLING	
	↓	MD18	ON/OFF	HIGH TEMPERATURE COOLING	
	↓	MD19	ON/OFF	MAKING ICE	
	↓	MD20	ON/OFF	STORING ICE	
↓	MD21	ON/OFF	HIGH SCT CIRCUIT A		
↓	MD23	ON/OFF	MINIMUM COMP ON TIME		
↓	MD24	ON/OFF	PUMP OFF DELAY TIME		

LEGEND

- CSM — Chillervisor System Manager
- SCT — Saturated Condensing Temperature
- WSM — Water System Manager

Table 13 — Alarms Mode and Sub-Mode Directory

SUB-MODE	KEYPAD ENTRY	ITEM	ITEM EXPANSION	COMMENT
CRNT	ENTER	AXXX OR TXXX	CURRENTLY ACTIVE ALARMS	Alarms are shown as AXXX. Alerts are shown as TXXX.
RCRN	ENTER	YES/NO	RESET ALL CURRENT ALARMS	
HIST	ENTER	AXXX OR TXXX	ALARM HISTORY	Alarms are shown as AXXX. Alerts are shown as TXXX.

Table 14 — Operating Modes

MODE NO.	ITEM EXPANSION	DESCRIPTION
01	CSM CONTROLLING CHILLER	Chillervisor System Manager (CSM) is controlling the chiller.
03	MASTER/SLAVE CONTROL	Dual Chiller control is enabled.
05	RAMP LOAD LIMITED	Ramp load (pull-down) limiting in effect. In this mode, the rate at which leaving fluid temperature is dropped is limited to a predetermined value to prevent compressor overloading. See Cooling Ramp Loading (Configuration → SLCT → CRMP). The pull-down limit can be modified, if desired, to any rate from 0.2° F to 2° F (0.1° to 1° C)/minute.
06	TIMED OVERRIDE IN EFFECT	Timed override is in effect. This is a 1 to 4 hour temporary override of the programmed schedule, forcing unit to Occupied mode. Override can be implemented with unit under Local (Enable) or CCN (Carrier Comfort Network®) control. Override expires after each use.
07	LOW COOLER SUCTION TEMPA	Circuit A cooler Freeze Protection mode. At least one compressor must be on, and the Saturated Suction Temperature is not increasing greater than 1.1° F (0.6° C) in 10 seconds. If the saturated suction temperature is less than the Brine Freeze Point (Set Points → FRZ → BR.FZ) minus 6° F (3.4° C) and less than the leaving fluid temperature minus 14° F (7.8° C) for 2 minutes, a stage of capacity will be removed from the circuit. Or, if the saturated suction temperature is less than the Brine Freeze Point minus 14° F (7.8° C), for 90 seconds, a stage of capacity will be removed from the circuit. The control will continue to decrease capacity as long as either condition exists.
09	SLOW CHANGE OVERRIDE	Slow change override is in effect. The leaving fluid temperature is close to and moving towards the control point.
10	MINIMUM OFF TIME ACTIVE	Chiller is being held off by Minutes Off Time (Configuration → OPT2 → DELY).
13	DUAL SETPOINT	Dual Set Point mode is in effect. Chiller controls to Cooling Set Point 1 (Set Points → COOL → CSP.1) during occupied periods and Cooling Set Point 2 (Set Points → COOL → CSP.2) during unoccupied periods.
14	TEMPERATURE RESET	Temperature reset is in effect. In this mode, chiller is using temperature reset to adjust leaving fluid set point upward and is currently controlling to the modified set point. The set point can be modified based on return fluid, outdoor-air-temperature, space temperature, or 4 to 20 mA signal.
15	DEMAND LIMITED	Demand limit is in effect. This indicates that the capacity of the chiller is being limited by demand limit control option. Because of this limitation, the chiller may not be able to produce the desired leaving fluid temperature. Demand limit can be controlled by switch inputs or a 4 to 20 mA signal.
16	COOLER FREEZE PROTECTION	Cooler fluid temperatures are approaching the Freeze point (see Alarms and Alerts section for definition). The chiller will be shut down when either fluid temperature falls below the Freeze point.
17	LOW TEMPERATURE COOLING	Chiller is in Cooling mode and the rate of change of the leaving fluid is negative and decreasing faster than -0.5° F per minute. Error between leaving fluid and control point exceeds fixed amount. Control will automatically unload the chiller if necessary.
18	HIGH TEMPERATURE COOLING	Chiller is in Cooling mode and the rate of change of the leaving fluid is positive and increasing. Error between leaving fluid and control point exceeds fixed amount. Control will automatically load the chiller if necessary to better match the increasing load.
19	MAKING ICE	Chiller is in an unoccupied mode and is using Cooling Set Point 3 (Set Points → COOL → CSP.3) to make ice. The ice done input to the Energy Management Module (EMM) is open.
20	STORING ICE	Chiller is in an unoccupied mode and is controlling to Cooling Set Point 2 (Set Points → COOL → CSP.2). The ice done input to the Energy Management Module (EMM) is closed.
21	HIGH SCT CIRCUIT A	Chiller is in a Cooling mode and the Saturated Condensing Temperature (SCT) is greater than the calculated maximum limit. No additional stages of capacity will be added. Chiller capacity may be reduced if SCT continues to rise to avoid high-pressure switch trips by reducing condensing temperature.
23	MINIMUM COMP ON TIME	Cooling load may be satisfied, however control continues to operate compressor to ensure proper oil return. May be an indication of oversized application, low fluid flow rate or low loop volume.
24	PUMP OFF DELAY TIME	Cooling load is satisfied, however cooler pump continues to run for the number of minutes set by the configuration variable Cooler Pump Shutdown Delay (Configuration → OPT1 → PM.DY).

CONTROLS

General — The 30MP liquid scroll chillers contain the *ComfortLink*[™] electronic control system that controls and monitors all operations of the chiller.

The control system is composed of several components as listed in the sections below. See Fig. 3 for a typical control box drawing. See Fig. 4 and 5 for control schematics.

Main Base Board (MBB) — See Fig. 6. The MBB is the heart of the *ComfortLink* control system. It contains the major portion of operating software and controls the operation of the machine. The MBB continuously monitors input/output channel information received from its inputs and from all other modules. The MBB receives inputs from the discharge and suction pressure transducers and thermistors. See Table 15. The MBB also receives the feedback inputs from each compressor current sensor board and other status switches. See Table 16. The MBB also controls several outputs. Relay outputs controlled by the MBB are shown in Table 17. Information is transmitted between modules via a 3-wire communication bus or LEN (Local Equipment Network). The CCN (Carrier Comfort Network) bus is also supported. Connections to both LEN and CCN buses are made at the LVT (low voltage terminal).

Energy Management Module (EMM) — The EMM module is available as a factory-installed option or as a field-installed accessory. The EMM module receives 4 to 20 mA inputs for the leaving fluid temperature reset, cooling set point and demand limit functions. The EMM module also receives the switch inputs for the field-installed 2-stage demand limit and ice done functions. The EMM module communicates the status of all inputs with the MBB, and the MBB adjusts the control point, capacity limit, and other functions according to the inputs received.

Current Sensor Board (CSB) — The CSB is used to monitor the status of the compressors by measuring current and providing an analog input to the main base board (MBB).

Enable/Off/Remote Contact Switch — The Enable/Off/Remote Contact switch is a 3-position switch used to control the chiller. When switched to the Enable position the chiller is under its own control. Move the switch to the Off position to shut the chiller down. Move the switch to the Remote Contact position and a field-installed dry contact can be used to start the chiller. The contacts must be capable of handling a 24 vac, 50-mA load. In the Enable and Remote Contact (dry contacts closed) positions, the chiller is allowed to operate and respond to the scheduling configuration, CCN configuration and set point data. See Fig. 7.

Emergency On/Off Switch — The Emergency On/Off switch should only be used when it is required to shut the chiller off immediately. Power to the MBB, EMM, and marquee display is interrupted when this switch is off and all outputs from these modules will be turned off. See Fig. 7.

Board Addresses — The main base board (MBB) has a 3-position instance jumper that must be set to '1.' The EMM board has 4-position DIP switches. All switches are set to 'On' for all boards except the AUX2 board. The AUX2 board DIP switch settings are shown on the wiring schematic.

Control Module Communication

RED LED — Proper operation of the control boards can be visually checked by looking at the red status LEDs (light-emitting diodes). When operating correctly, the red status LEDs should be blinking in unison at a rate of once every 2 seconds. If the red LEDs are not blinking in unison, verify that correct power is being supplied to all modules. Be sure that

the main base board (MBB) is supplied with the current software. If necessary, reload current software. If the problem still persists, replace the MBB. A red LED that is lit continuously or blinking at a rate of once per second or faster indicates that the board should be replaced.

GREEN LED — The MBB has one green LED. The Local Equipment Network (LEN) LED should always be blinking whenever power is on. All other boards have a LEN LED which should be blinking whenever power is on. Check LEN connections for potential communication errors at the board J3 and/or J4 connectors. Communication between modules is accomplished by a 3-wire sensor bus. These 3 wires run in parallel from module to module. The J4 connector on the MBB provides both power and communication directly to the marquee display only.

YELLOW LED — The MBB has one yellow LED. The Carrier Comfort Network (CCN) LED will blink during times of network communication.

Carrier Comfort Network[®] (CCN) Interface — The 30MP chiller units can be connected to the CCN if desired. The communication bus wiring is a shielded, 3-conductor cable with drain wire and is supplied and installed in the field. See Table 18. The system elements are connected to the communication bus in a daisy chain arrangement. The positive pin of each system element communication connector must be wired to the positive pins of the system elements on either side of it. This is also required for the negative and signal ground pins of each system element. Wiring connections for CCN should be made at LVT. Consult the CCN Contractor's Manual for further information.









NOTE: Conductors and drain wire must be 20 AWG (American Wire Gage) minimum stranded, tinned copper. Individual conductors must be insulated with PVC, PVC/nylon, vinyl, Teflon, or polyethylene. An aluminum/polyester 100% foil shield and an outer jacket of PVC, PVC/nylon, chrome vinyl, or Teflon with a minimum operating temperature range of -20 C to 60 C is required. Wire manufactured by Alpha (2413 or 5463), American (A22503), Belden (8772), or Columbia (02525) meets the above mentioned requirements.

It is important when connecting to a CCN communication bus that a color coding scheme be used for the entire network to simplify the installation. It is recommended that red be used for the signal positive, black for the signal negative, and white for the signal ground. Use a similar scheme for cables containing different colored wires.

At each system element, the shields of its communication bus cables must be tied together. If the communication bus is entirely within one building, the resulting continuous shield must be connected to a ground at one point only. If the communication bus cable exits from one building and enters another, the shields must be connected to grounds at the lightning suppressor in each building where the cable enters or exits the building (one point per building only). To connect the unit to the network:

1. Turn off power to the control box.
2. Cut the CCN wire and strip the ends of the red (+), white (ground), and black (-) conductors. (Substitute appropriate colors for different colored cables.)
3. Connect the red wire to (+) terminal on LVT of the plug, the white wire to COM terminal, and the black wire to the (-) terminal.
4. The RJ14 CCN connector on LVT can also be used, but is only intended for temporary connection (for example, a laptop computer running Service Tool).

LEGEND FOR FIG. 3-5

ALMR	—	Alarm Relay
AUX	—	Auxilliary
C	—	Contactora, Compressor
CB	—	Circuit Breaker
CCB	—	Compressor Circuit Breaker
CH	—	Crankcase Heater
CCH	—	Crankcase Heater Relay
COMP	—	Compressor
CR	—	Control Relay
CSB	—	Current Sensor Board
CWFS	—	Chilled Water Flow Switch
CWP	—	Chilled Water Pump
DGS	—	Digital Scroll Compressor
DPT	—	Discharge Pressure Transducer
DTT	—	Discharge Temperature Thermistor
DUS	—	Digital Unloader Solenoid
EMM	—	Energy Management
EWT	—	Entering Water Temperature
FB	—	Fuse Block
FIOP	—	factory Installed Option
FU	—	Fuse
GND	—	Ground
HPS	—	High-Pressure Switch
LLSV	—	Liquid Line Solenoid Valve
LON	—	Local Operating Network
LVT	—	Low Voltage Terminal
LWT	—	Leaving Water Temperature
MBB	—	Main Base Board
MLV	—	Minimum Load Valve
MP	—	Modular Motor Protection
NEC	—	National Electrical Code
OAT	—	Outdoor-Air Thermistor
PL	—	Plug
RLY	—	Relay
SPT	—	Suction Pressure Transducer
SW	—	Switch
TB	—	Terminal Block
TRAN	—	Transformer
UPC	—	Unitary Protocol Converter
		Terminal Block
		Terminal (Unmarked)
		Terminal (Marked)
		Splice
		Factory Wiring
		Field Wiring
		Accessory or Option Wiring
		To indicate common potential only; not to represent wiring.

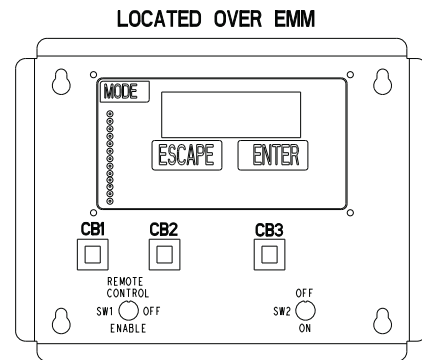
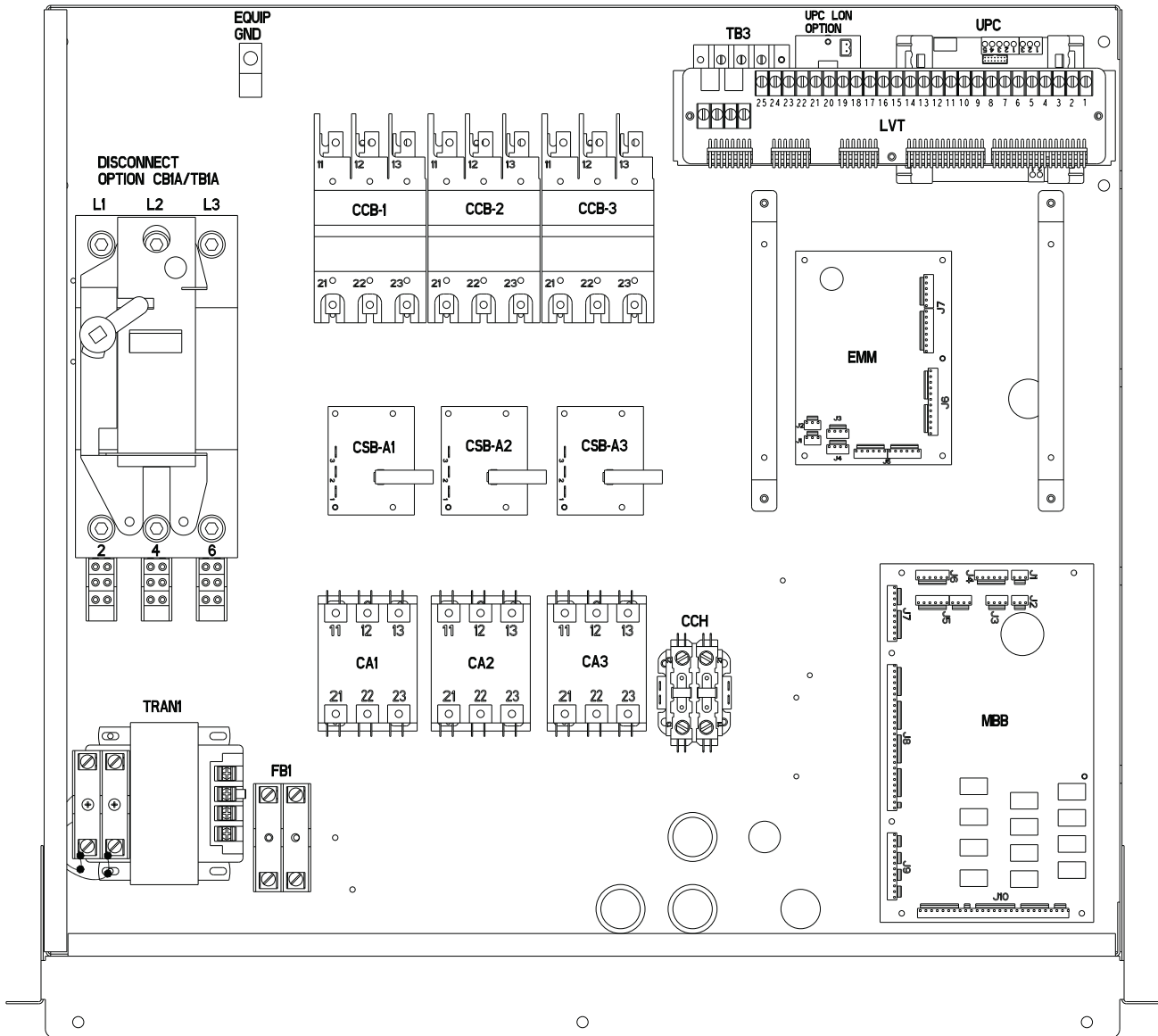

Fig. 3 — Typical Control Box — 30MP015-045 Units

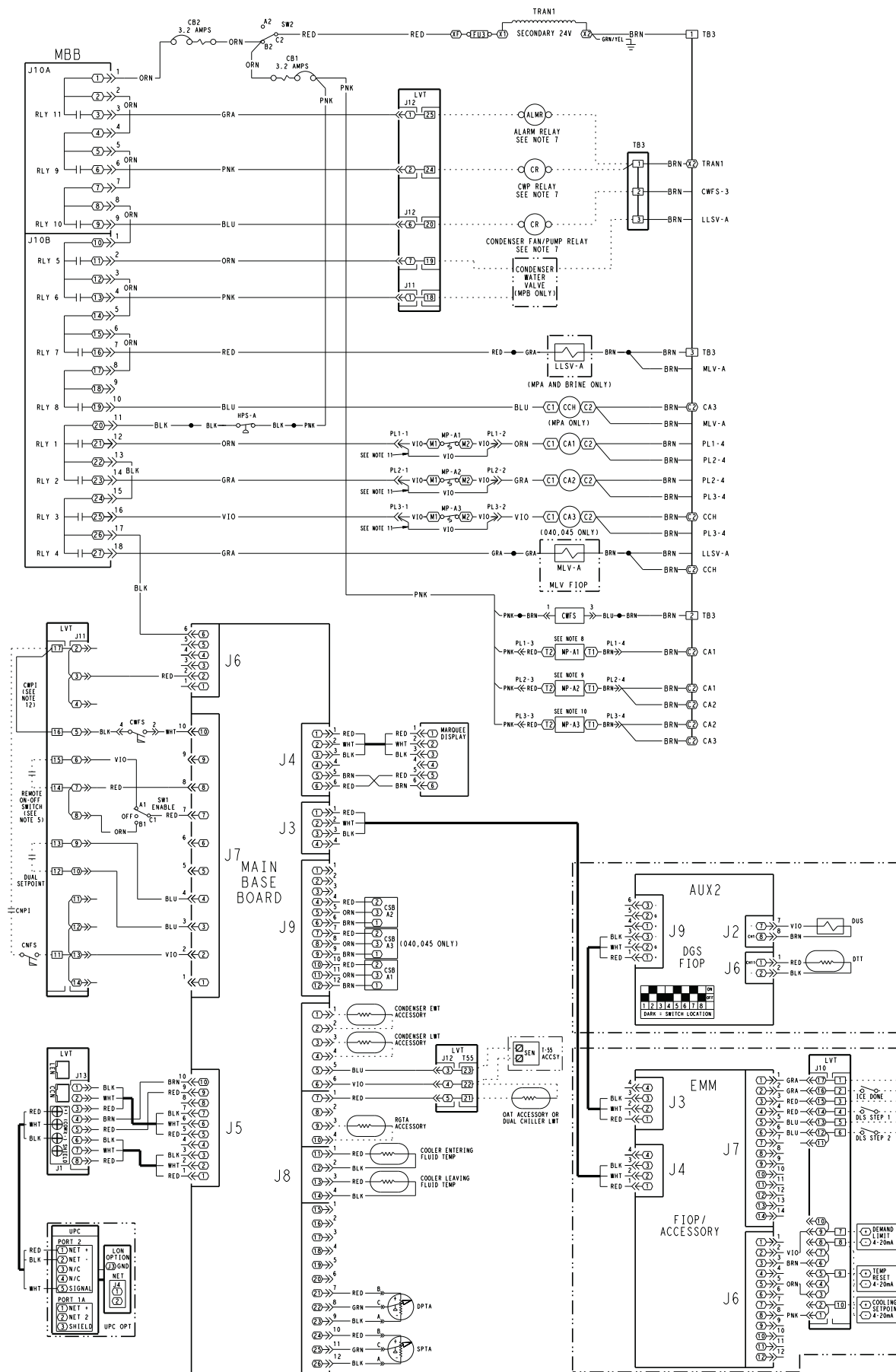

Fig. 5 — Typical Control Wiring Schematic — 30MP015-045 Units

IMPORTANT: A shorted CCN bus cable will prevent some routines from running and may prevent the unit from starting. If abnormal conditions occur, unplug the connector. If conditions return to normal, check the CCN connector and cable. Run new cable if necessary. A short in one section of the bus can cause problems with all system elements on the bus.

Table 15 — Thermistor Designations

THERMISTOR	PIN CONNECTION POINT	THERMISTOR INPUT
CLWT	J8-13,14 (MBB)	Cooler Leaving Fluid
CEWT	J8-11,12 (MBB)	Cooler Entering Fluid
RGTA	J8-9,10 (MBB)	Circuit A Return Gas Temperature (accessory)
OAT	J8-6,7 (MBB), LVT 4,13	Outdoor-Air Temperature Sensor (accessory) or Dual LWT Sensor
SPT	J8-5,6 (MBB) LVT-3,4	Accessory Remote Space Temperature Sensor
CNDE	J8-1,2	Condenser Entering Water Temperature Sensor
CNDL	J8-3,4	Condenser Leaving Water Temperature Sensor

LEGEND

LWT — Leaving Water Temperature
 MBB — Main Base Board

Table 16 — Status Inputs

STATUS SWITCH	PIN CONNECTION POINT
Condenser Flow Switch	LVT-11,17, J7-2, J6-2
Dual Set Point	LVT-12,13, J7-3,4
Remote On/Off	LVT-14,15
Cooler Flow Switch Interlock	LVT-16,17, J6-2, J7-10
Compressor Fault Signal, A1	J9-11,12
Compressor Fault Signal, A2	J9-5,6
Compressor Fault Signal, A3	J9-8,9

Table 17 — Output Relays

RELAY NO.	DESCRIPTION
K1	Energize Compressor A1
K2	Energize Compressor A2
K3	Energize Compressor A3
K4	Energize Minimum Load Valve
K5	Water Valve Open
K6	Water Valve Close
K7	Liquid Line Solenoid Valve
K8	Crankcase Heater Relay (30MPA Only)
K9	Chilled Water Pump
K10	Condenser Fan/Pump
K11	Alarm Relay

Table 18 — CCN Communication Bus Wiring

MANUFACTURER	PART NO.	
	Regular Wiring	Plenum Wiring
Alpha	1895	—
American	A21451	A48301
Belden	8205	884421
Columbia	D6451	—
Manhattan	M13402	M64430
Quabik	6130	—

Sensors — The electronic control uses 2 to 7 thermistors to sense temperatures for controlling chiller operation. See Table 15. These sensors are outlined below. Thermistors

RGTA, CNDE, CNDL, EWT, LWT, and OAT are identical in temperature versus resistance and voltage drop performance. The dual chiller thermistor (DLWT) is 5 kΩ at 77 F (25 C) thermistor. Space temperature thermistor (SPT) is a 10 kΩ at 77 F (25 C). See Thermistors section for temperature-resistance-voltage drop characteristics.

COOLER LEAVING FLUID SENSOR (LWT) — The thermistor is installed in a well in the factory-installed leaving fluid piping coming from the bottom of the brazed-plate heat exchanger.

COOLER ENTERING FLUID SENSOR (EWT) — The thermistor is installed in a well in the factory-installed entering fluid piping coming from the top of the brazed-plate heat exchanger.

CONDENSER LEAVING FLUID SENSOR (CNDL) — The thermistor is installed in a well in the factory-installed leaving fluid piping coming from the bottom of the brazed-plate heat exchanger.

COOLER ENTERING FLUID SENSOR (CNDE) — The thermistor is installed in a well in the factory-installed entering fluid piping coming from the top of the brazed-plate heat exchanger.

COMPRESSOR RETURN GAS TEMPERATURE SENSOR (RGTA) — This accessory thermistor can be installed in a well located in the suction line.

OUTDOOR-AIR TEMPERATURE SENSOR (OAT) — This sensor is an accessory that is remotely mounted and used for outdoor air temperature reset. See Table 15.

DUAL LEAVING WATER TEMPERATURE SENSOR (DLWT) — This input can be connected to the LVT. See Table 15. For dual chiller applications (parallel only are supported), connect the dual chiller leaving fluid temperature sensor (5 kΩ thermistor, Carrier part no. HH79NZ029) to the outside air temperature input of the Master chiller. If outside air temperature is required for reset applications, connect the sensor to the Slave chiller and configure the slave chiller to broadcast the value to the Master chiller.

REMOTE SPACE TEMPERATURE SENSOR (SPT) — The sensor (part no. 33ZCT55SPT) is an accessory sensor that is remotely mounted in the controlled space and used for space temperature reset. The sensor should be installed as a wall-mounted thermostat would be (in the conditioned space where it will not be subjected to either a cooling or heating source or direct exposure to sunlight, and 4 to 5 ft above the floor).

Space temperature sensor wires are to be connected to terminals in the unit main control box. The space temperature sensor includes a terminal block (SEN) and a RJ11 female connector. The RJ11 connector is used access into the Carrier Comfort Network® (CCN) at the sensor.

To connect the space temperature sensor (Fig. 8):

1. Using a 20 AWG twisted pair conductor cable rated for the application, connect 1 wire of the twisted pair to one SEN terminal and connect the other wire to the other SEN terminal located under the cover of the space temperature sensor.
2. Connect the other ends of the wires to terminals 3 and 4 on LVT located in the unit control box.

Units on the CCN can be monitored from the space at the sensor through the RJ11 connector, if desired. To wire the RJ11 connector into the CCN (Fig. 9):

IMPORTANT: The cable selected for the RJ11 connector wiring **MUST** be identical to the CCN communication bus wire used for the entire network. Refer to Table 18 for acceptable wiring.

1. Cut the CCN wire and strip ends of the red (+), white (ground), and black (–) conductors. (If another wire color scheme is used, strip ends of appropriate wires.)

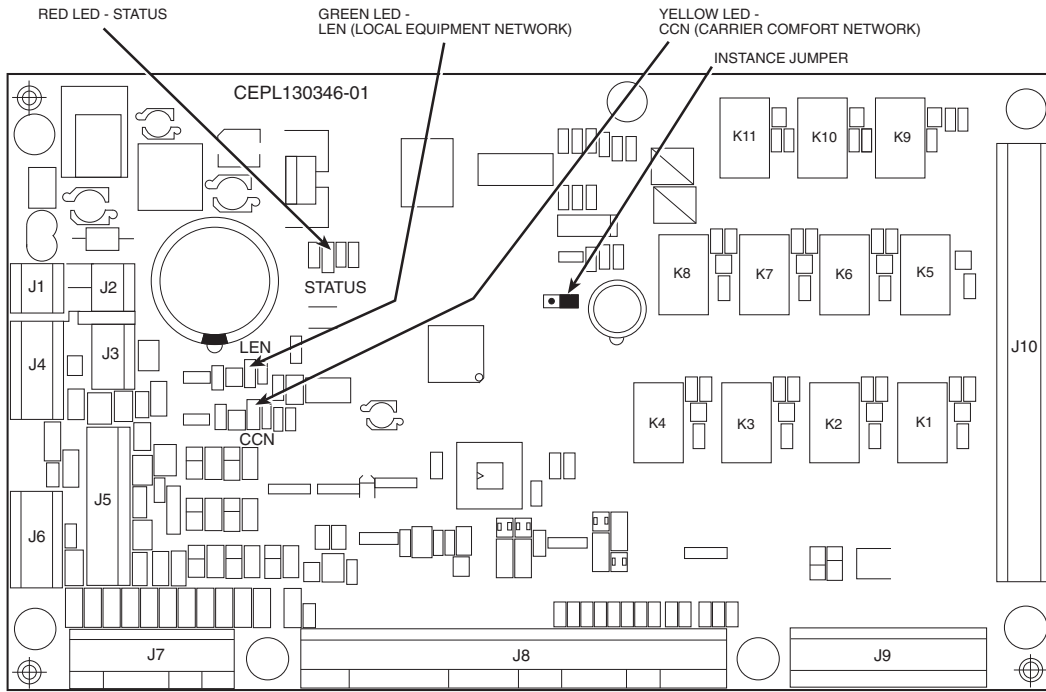

Fig. 6 — Main Base Board

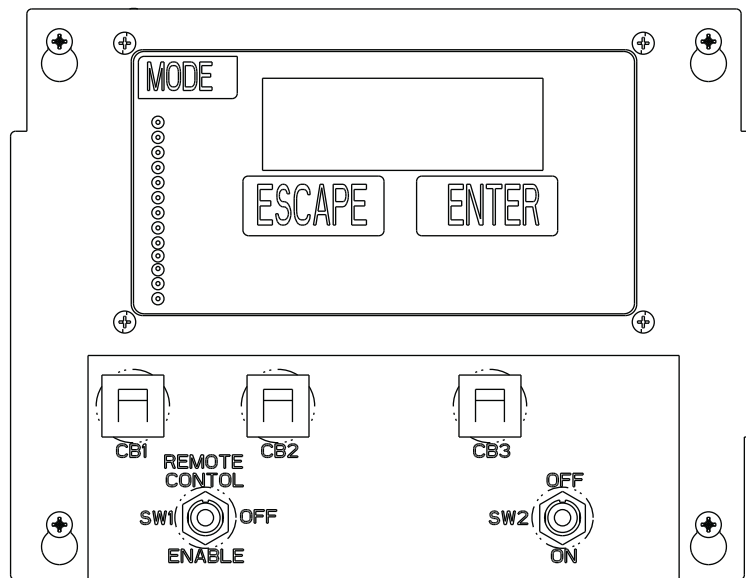

Fig. 7 — Enable/Off/Remote Contact Switch, and Emergency On/Off Switch Locations

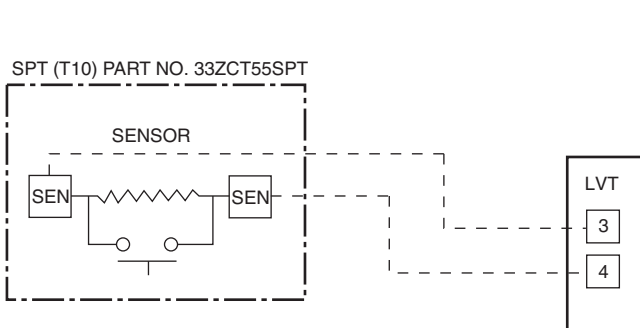

Fig. 8 — Typical Space Temperature Sensor Wiring

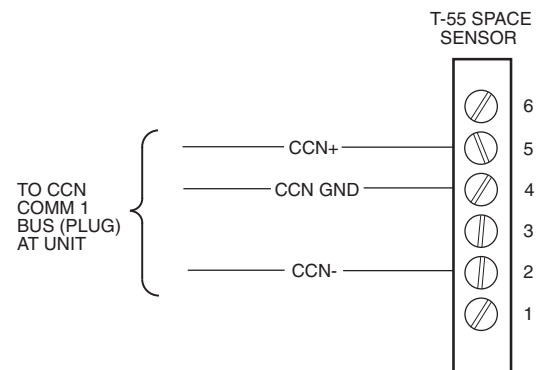

Fig. 9 — CCN Communications Bus Wiring to Optional Space Sensor RJ11 Connector

2. Insert and secure the red (+) wire to terminal 5 of the space temperature sensor terminal block.
3. Insert and secure the white (ground) wire to terminal 4 of the space temperature sensor.
4. Insert and secure the black (-) wire to terminal 2 of the space temperature sensor.
5. Connect the other end of the communication bus cable to the remainder of the CCN communication bus.

Energy Management Module (Fig. 10) — This factory-installed option (FIOP) or field-installed accessory is used for the following types of temperature reset, demand limit, and/or ice features:

- 4 to 20 mA leaving fluid temperature reset (requires field-supplied 4 to 20 mA generator)
- 4 to 20 mA cooling set point reset (requires field-supplied 4 to 20 mA generator)
- Discrete inputs for 2-step demand limit (requires field-supplied dry contacts capable of handling a 24 vac, 50 mA load)
- 4 to 20 mA demand limit (requires field-supplied 4 to 20 mA generator)
- Discrete input for Ice Done switch (requires field-supplied dry contacts capable of handling a 24 vac, 50 mA load)

See Demand Limit and Temperature Reset sections on pages 27 and 31 for further details.

⚠ CAUTION

Care should be taken when interfacing with other manufacturer's control systems due to possible power supply differences, full wave bridge versus half wave rectification. The two different power supplies cannot be mixed. *ComfortLink™* controls use half wave rectification. A signal isolation device should be utilized if a full wave bridge signal generating device is used.

Loss-of-Cooler Flow Protection — A proof-of-cooler flow device is factory installed in all chillers.

Condenser Flow Protection — A proof-of-condenser flow protection accessory can be field installed in the condenser water piping of all chillers. The unit must be configured for the input to be enabled.

Thermostatic Expansion Valves (TXV) — All units are equipped from the factory with conventional TXVs. The 30MPA units and 30MPW units with medium temperature brine also have factory-installed liquid line solenoids. The liquid line solenoid valves are not intended to be a mechanical shut-off. For 30MPW units, when service is required, reclaim the refrigerant from the system.

For 30MPA units when service is required, the compressor and evaporator can be serviced by closing the factory-installed liquid line service valve and field-installed discharge line service valve. After the valves are closed, reclaim the refrigerant from the system.

The TXV is set at the factory to maintain approximately 8 to 12° F (4.4 to 6.7° C) suction superheat leaving the cooler by monitoring the proper amount of refrigerant into the cooler. All TXVs are adjustable, *but should not be adjusted unless absolutely necessary.*

Capacity Control — The control system cycles compressors, digital scroll modulating solenoid (if equipped), and minimum load valve solenoids (if equipped) to maintain the user-configured leaving chilled fluid temperature set point. Entering fluid temperature is used by the main base board (MBB) to determine the temperature drop across the cooler and is used in determining the optimum time to add or subtract capacity

stages. The chilled fluid temperature set point can be automatically reset by the return fluid temperature, space, or outdoor-air temperature reset features. It can also be reset from an external 4 to 20-mA signal (requires energy management module FIOP or accessory).

The capacity control algorithm runs every 30 seconds. The algorithm attempts to maintain the Control Point at the desired set point. Each time it runs, the control reads the entering and leaving fluid temperatures. The control determines the rate at which conditions are changing and calculates 2 variables based on these conditions. Next, a capacity ratio is calculated using the 2 variables to determine whether or not to make any changes to the current stages of capacity. This ratio value ranges from -100 to +100%. If the next stage of capacity is a compressor, the control starts (stops) a compressor when the ratio reaches +100% (-100%). If installed, the minimum load valve solenoid will be energized with the first stage of capacity. Minimum load valve value is a fixed 30% in the total capacity calculation. The control will also use the minimum load valve solenoid as the last stage of capacity before turning off the last compressor. A delay of 90 seconds occurs after each capacity step change. Refer to Table 19.

MINUTES LEFT FOR START — This value is displayed only in the network display tables (using Service Tool, ComfortVIEW™ or ComfortWORKS® software) and represents the amount of time to elapse before the unit will start its initialization routine. This value can be zero without the machine running in many situations. This can include being unoccupied, ENABLE/OFF/REMOTE CONTACT switch in the OFF position, CCN not allowing unit to start, Demand Limit in effect, no call for cooling due to no load, and alarm or alert conditions present. If the machine should be running and none of the above are true, a minimum off time (DELY, see below) may be in effect. The machine should start normally once the time limit has expired.

MINUTES OFF TIME (Configuration → OPT2 → DELY) — This user-configurable time period is used by the control to determine how long unit operation is delayed after power is applied/restored to the unit. Typically, this time period is configured when multiple machines are located on a single site. For example, this gives the user the ability to prevent all the units from restarting at once after a power failure. A value of zero for this variable does not mean that the unit should be running.

LEAD/LAG DETERMINATION — This is a configurable choice and is factory set to be automatic for all units unless the unit is equipped with minimum load, then circuit A is lead (**Configuration → OPT2 → LLCS**). The value can be changed to Circuit A or Circuit B leading as desired. Set at automatic, the control will sum the current number of logged circuit starts and one-quarter of the current operating hours for each circuit. The circuit with the lowest sum is started first. Changes to which circuit is the lead circuit and which is the lag are also made when total machine capacity is at 100% or when there is a change in the direction of capacity (increase or decrease) and each circuit's capacity is equal.

CAPACITY CONTROL OVERRIDES — The following overrides will modify the normal operation of the routine.

Deadband Multiplier — The user configurable Deadband Multiplier (**Configuration → SLCT → Z.GN**) has a default value of 1.0. The range is from 1.0 to 4.0. When set to other than 1.0, this factor is applied to the capacity Load/Unload Factor. The larger this value is set, the longer the control will delay between adding or removing stages of capacity. Figure 11 shows how compressor starts can be reduced over time if the leaving water temperature is allowed to drift a larger amount above and below the set point. This value should be set in the range of 3.0 to 4.0 for systems with small loop volumes. Figure 12 shows the operating envelope for the compressor.

First Stage Override — If the current capacity stage is zero, the control will modify the routine with a 1.2 factor on adding the first stage to reduce cycling. This factor is also applied when the control is attempting to remove the last stage of capacity.

Slow Change Override — The control prevents the capacity stages from being changed when the leaving fluid temperature is close to the set point (within an adjustable deadband) and moving towards the set point.

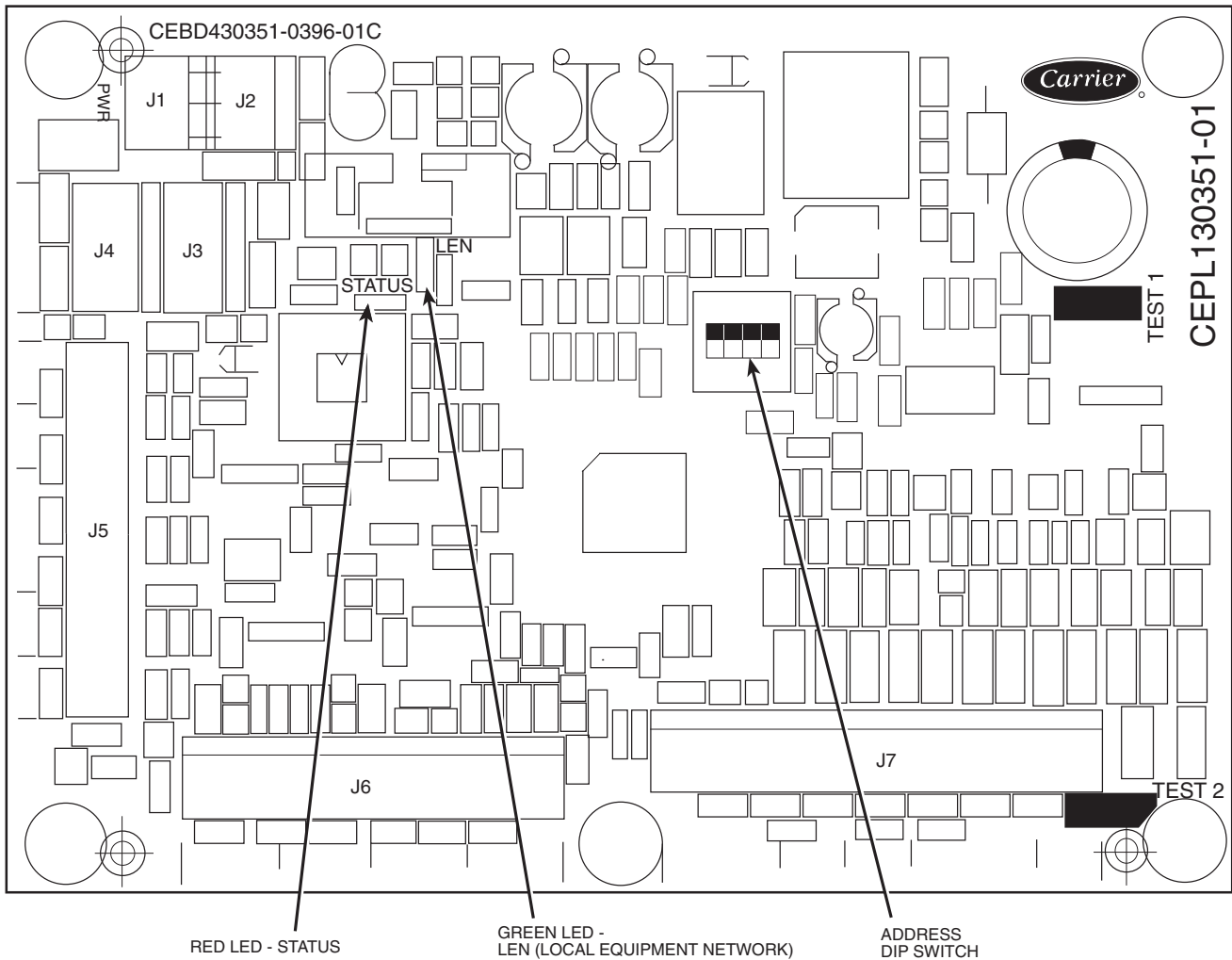

Fig. 10 — Energy Management Module

Table 19 — Part Load Data Percent Displacement, Standard Units with Minimum Load Valve

30MP UNIT SIZE	CONTROL STEPS	CAPACITY STEPS (% Displacement)
015	1	18*
	2	50
	3	100
020	1	25*
	2	50
	3	100
030	1	34*
	2	50
	3	100
040	1	21*
	2	33
	3	67
	4	100
045	1	22*
	2	33
	3	67
	4	100

*Hot gas bypass (minimum load) valve energized.

NOTE: These capacity steps may vary due to different capacity staging sequences.

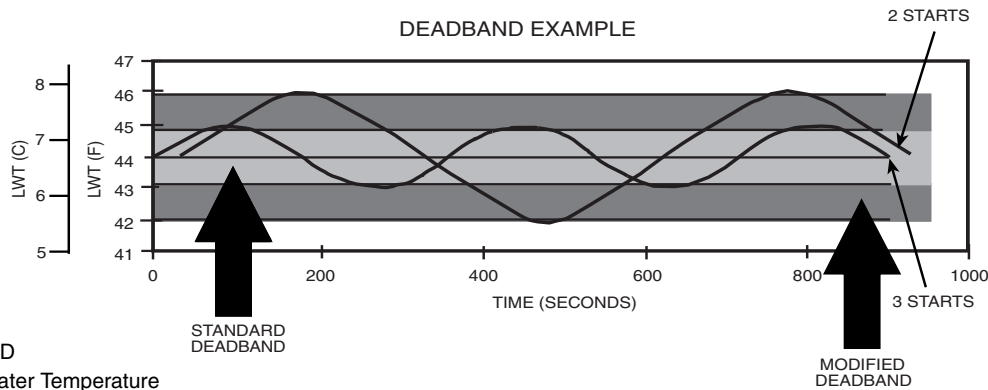

LEGEND
LWT — Leaving Water Temperature

Fig. 11 — Deadband Multiplier

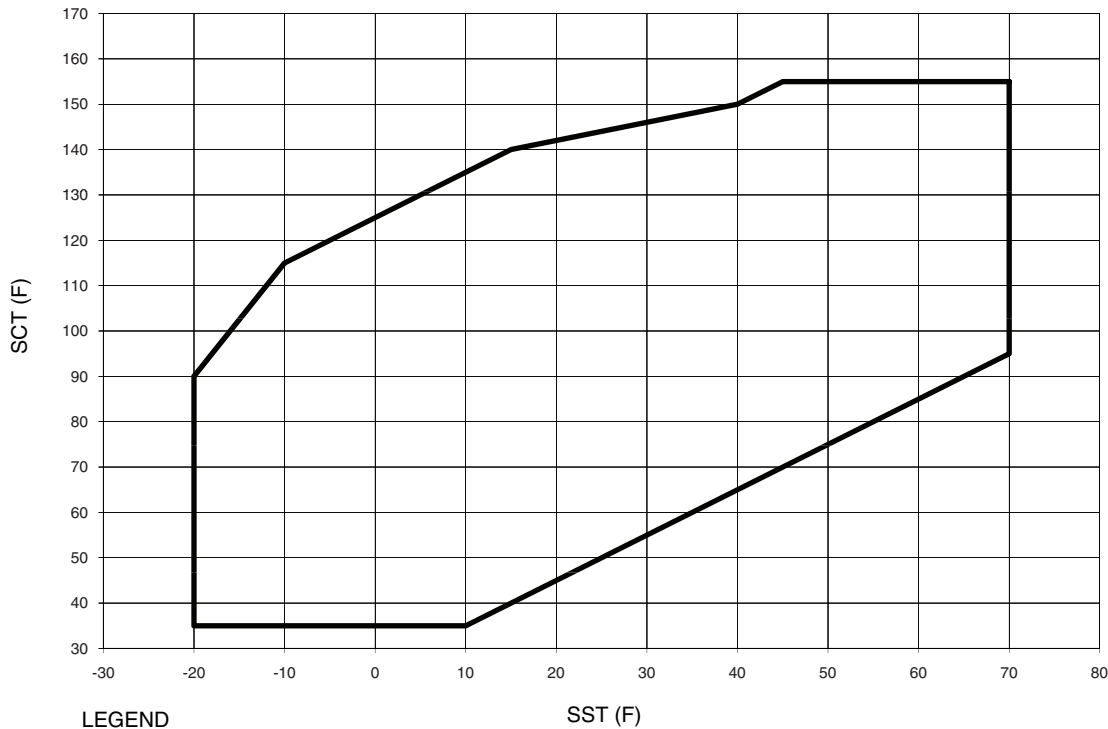

LEGEND
SCT — Saturated Condensing Temperature
SST — Saturated Suction Temperature

Fig. 12 — Operating Envelope for R-410A Compressor

Ramp Loading — Ramp loading (*Configuration* → *SLCT* → *CRMP*) limits the rate of change of leaving fluid temperature. If the unit is in a Cooling mode and configured for Ramp Loading, the control makes 2 comparisons before deciding to change stages of capacity. The control calculates a temperature difference between the control point and leaving fluid temperature. If the difference is greater than 4° F (2.2° C) and the rate of change (°F or °C per minute) is more than the configured Cooling Ramp Loading value (*CRMP*), the control does not allow any changes to the current stage of capacity.

Low Entering Fluid Temperature Unloading — When the entering fluid temperature is below the control point, the control will attempt to remove 25% of the current stages being used. If exactly 25% cannot be removed, the control removes an amount greater than 25% but no more than necessary. The lowest stage will not be removed.

Hot Gas Bypass — If equipped, the hot gas bypass valve is energized only when one compressor is running on circuit A. If the close control feature is enabled the hot gas bypass valve

may be used as needed to obtain leaving fluid temperature close to set point.

Cooler Freeze Protection — The control will try to prevent shutting the chiller down on a Cooler Freeze Protection alarm by removing stages of capacity. If the cooler fluid selected is Water, the freeze point is 34 F (1.1 C). If the cooler fluid selected is Brine, the freeze point is the Brine Freeze Point (*Set Points* → *FRZ* → *BR.FZ*). This alarm condition (A207) only references leaving fluid temperature and NOT Brine Freeze point. If the cooler leaving fluid temperature is less than the freeze point plus 2.0° F (1.1° C), the control will immediately remove one stage of capacity. This can be repeated once every 30 seconds.

Low Saturated Suction Protection — The control will try to prevent shutting a circuit down due to low saturated suction conditions by removing stages of capacity. The circuit alert condition (T116) compares saturated suction temperature to the configured Brine Freeze Point (*Set Points* → *FRZ* → *BR.FZ*). The Brine Freeze point is a user-configurable value that must be left at 34 F (1.1 C) for 100% water systems. A lower value

may be entered for systems with brine solutions, but this value should be set according to the freeze protection level of the brine mixture. Failure to properly set this brine freeze point value may permanently damage the brazed plate heat exchanger. The control will initiate Mode 7 (Circuit A) to indicate a circuit's capacity is limited and that eventually the circuit may shut down.

Operation of Machine Based on Control Method and Cooling Set Point Selection Settings

Machine On/Off control is determined by the configuration of the Control Method (*Configuration* → *OPT2* → *CTRL*) and Cooling Set Point Select (*Configuration* → *SLCT* → *CLSP*) variables. All units are factory configured with Cooling Set Point Select set to 0 (single set point). With the control method set to 0, simply switching the Enable/Off/Remote Contact switch to the Enable or Remote Contact position (external contacts closed) will put the chiller in an occupied state. The control mode (*Run Status* → *VIEW* → *STAT*) will be 1 (OFF LOCAL) when the switch is Off and will be 5 (ON LOCAL) when in the Enable position or Remote Contact position with external contacts closed.

Two other control methods are available for Machine On/Off control:

OCCUPANCY SCHEDULE (*Configuration* → *OPT2* → *CTRL* = 1) — The main base board will use the operating schedules as defined under the Time Clock mode in the scrolling marquee display. These schedules are identical. The schedule number must be set to 1 for local schedule.

The schedule number can be set anywhere from 65 to 99 for operation under a CCN global schedule. The Enable/Off/Remote Contact must be in the Enable or Remote Contact position. The control mode (*Run Status* → *VIEW* → *STAT*) will be 1 when the switch is Off. The control mode will be 3 when the Enable/Off/Remote Contact switch input is On and the time of day is during an unoccupied period. Similarly, the control mode will be 7 when the time of day is during an occupied period.

CCN SCHEDULE (*Configuration* → *OPT2* → *CTRL* = 2) — An external CCN device such as Chillervisor System Manager controls the On/Off state of the machine. This CCN device forces the variable 'CHIL_S_S' between Start/Stop to control the chiller. The control mode (*Run Status* → *VIEW* → *STAT*) will be 1 when the switch is Off. The control mode will be 2 when the Enable/Off/Remote Contact switch input is On and the CHIL_S_S variable is 'Stop.' Similarly, the control mode will be 6 when the CHIL_S_S variable is 'Start.'

Table 20 illustrates how the control method and cooling set point select variables direct the operation of the chiller and the set point to which it controls. The illustration also shows the ON/OFF state of the machine for the given combinations.

Cooling Set Point Select

SINGLE — Unit operation is based on Cooling Set Point 1 (*Set Points* → *COOL* → *CSP.1*).

DUAL SWITCH — Unit operation is based on Cooling Set Point 1 (*Set Points* → *COOL* → *CSP.1*) when the Dual Set Point switch contacts are open and Cooling Set Point 2 (*Set Points* → *COOL* → *CSP.2*) when they are closed.

DUAL CCN OCCUPIED — Unit operation is based on Cooling Set Point 1 (*Set Points* → *COOL* → *CSP.1*) during the Occupied mode and Cooling Set Point 2 (*Set Points* → *COOL* → *CSP.2*) during the Unoccupied mode as configured under the local occupancy schedule accessible only from CCN. Schedule Number in Table SCHEDOVR (See Appendix B) must be configured to 1. If the Schedule Number is set to 0, the unit will operate in a continuous 24-hr Occupied mode. Control method must be configured to 0 (switch). See Table 20.

4 TO 20 mA INPUT — Unit operation is based on an external 4 to 20 mA signal input to the Energy Management Module (EMM).

Cooler Pump Control — The AquaSnap® 30MP machines are configured with the Cooler Pump Control (*Configuration* → *OPT1* → *CPC*) = ON.

The maximum load allowed for the Chilled Water Pump Starter is 5 VA sealed, 10 VA inrush at 24 volts. The starter coil is powered from the chiller control system. The starter should be wired between LVT 24 and TB3-1. If equipped, the field-installed chilled water pump starter auxiliary contacts should be connected in series with the chilled water flow switch between LVT 16 and LVT 17.

Ice Mode — When Ice Mode is enabled Cooling Setpoint Select must be set to Dual Switch, Dual 7 day or Dual CCN Occupied and the Energy Management Module (EMM) must be installed. Unit operation is based on Cooling Setpoint 1 (*CSP.1*) during the Occupied mode, Ice Setpoint (*CSP.3*) during the Unoccupied mode with the Ice Done contacts open and Cooling Setpoint 2 (*CSP.2*) during the Unoccupied mode with the Ice Done contacts closed. These 3 set points can be utilized to develop your specific control strategy.

Service Test (See Table 4) — Both main power and control circuit power must be on.

The Service Test function should be used to verify proper operation of condenser output, compressors, minimum load valve solenoid (if installed), cooler pump, and remote alarm relay. To use the Service Test mode, the Enable/Off/Remote Contact switch must be in the OFF position. Use the display keys and Table 4 to enter the mode and display TEST. Press **ENTER** twice so that OFF flashes. Enter the password if required. Use either arrow key to change the TEST value to the ON position and press **ENTER**. Press **ESCAPE** and the **▼** button to enter the OUTS or COMP sub-mode.

Table 20 — Control Methods and Cooling Set Points

CONTROL TYPE (CTRL)	OCCUPANCY STATE	COOLING SET POINT SELECT (CLSP)			
		0 (single)	1 (dual, switch)	2 (dual, occ)	3 (4 to 20 mA)
0 (switch)	Occupied	ON,CSP1	ON*	ON,CSP1	ON†
	Unoccupied	ON,CSP1	ON*	ON,CSP2	ON
2 (Occupancy)	Occupied	ON,CSP1	ON*	Illegal	ON†
	Unoccupied	OFF	OFF	Illegal	OFF
3 (CCN)	Occupied	ON,CSP1	ON*	ON,CSP1	ON†
	Unoccupied	ON,CSP1	ON*	ON,CSP2	ON†

*Dual set point switch input used. CSP1 used when switch input is open. CSP2 used when switch input is closed.

†Cooling set point determined from 4 to 20 mA input to energy management module (EMM) to terminals TB6-3,5.

Test the condenser output, cooler pump, liquid line solenoid valve (30MPA only), crankcase heater, water valve (accessory), and alarm relay by changing the item values from OFF to ON. These discrete outputs are then turned off if there is no keypad activity for 10 minutes. When testing compressors, lead compressor must be started first. All compressor outputs can be turned on, but the control will limit the rate by staging one compressor per minute. Minimum load valve can be tested with the compressors on or off. The relays under the COMP mode will stay on for 10 minutes if there is no keypad activity. Compressors will stay on until they are turned off by the operator. The Service Test mode will remain enabled for as long as there is one or more compressors running. All safeties are monitored during this test and will turn a compressor, circuit or the machine off if required. Any other mode or sub-mode can be accessed, viewed, or changed during the TEST mode. The STAT item (**Run Status**→**VIEW**) will display "0" as long as the Service mode is enabled. The TEST sub-mode value must be changed back to OFF before the chiller can be switched to Enable or Remote contact for normal operation.

Cooler Pump Sequence of Operation — At any-time the unit is in an ON status, as defined by the one of the following conditions, the cooler pump relay will be enabled.

1. The Enable-Off-Remote Switch in ENABLE, (**CTRL**=0).
2. Enable-Off-Remote Switch in REMOTE with a Start-Stop remote contact closure (**CTRL**=0).
3. An Occupied Time Period from an Occupancy Schedule in combination with items 1 or 2 (**CTRL**=2).
4. A CCN Start-Stop Command to Start in combination with items 1 or 2 (**CTRL**=3).

There are certain alarm conditions and Operating Modes that will turn the cooler pump relay ON. This sequence will describe the normal operation of the pump control algorithm.

When the unit cycles from an "On" state to an "Off" state, the cooler pump output will remain energized for the Cooler Pump Shutdown Delay (**Configuration**→**OPT1**→**PM.DY**). This is configurable from 0 to 10 minutes. The factory default is 1 minute. If the pump output was deenergized during the transition period, the pump output will not be energized.

The Cooler Pump Relay will be energized when the machine is "On." The chilled water pump interlock circuit consists of a chilled water flow switch and a field-installed chilled water pump interlock. If the chilled water pump interlock circuit does not close within five (5) minutes of starting, an A200 - Cooler Flow/Interlock failed to close at Start-Up alarm1 will be generated and chiller will not be allowed to start.

If the chilled water pump interlock or chilled water flow switch opens for at least three (3) seconds after initially being closed, an A201 - Cooler Flow 1 Interlock Contacts Opened During Normal Operation alarm will be generated and the machine will stop.

Condenser Pump/Condenser Fan Output Control — The main base board (MBB) has the capability to control either a condenser fan output or a condenser pump output depending on the unit configuration.

If the unit is configured for **Configuration**→**UNIT**→**TYPE** = 2 (air cooled), then the output will be off as long as capacity is equal to 0 and will be energized 5 seconds before a compressor is started and remain energized until capacity is 0 again.

If the unit is configured for **Configuration**→**UNIT**→**TYPE** = 3 (water cooled), then the output will be used for condenser pump control and additional configuration is required. To enable the condenser pump control use **Configuration**→**OPT1**→**DPME**. The pump can be configured for no pump control, on when occupied, and on when capacity is greater than 0.

Configuring and Operating Dual Chiller Control — The dual chiller routine is available for the control of two units supplying chilled fluid on a common loop. This control algorithm is designed for parallel fluid flow arrangement only. One chiller must be configured as the master chiller, the other as the slave. An additional leaving fluid temperature thermistor (Dual Chiller LWT) must be installed as shown in Fig. 13 and 14 and connected to the master chiller. Refer to Sensors section, page 19, for wiring. The CCN communication bus must be connected between the two chillers. Connections can be made to the CCN screw terminals on LVT. Refer to Carrier Comfort Network® Interface section, page 14, for wiring information. Configuration examples are shown in Tables 21 and 22.

Refer to Table 21 for dual chiller configuration. In this example the master chiller will be configured at address 1 and the slave chiller at address 2. The master and slave chillers must reside on the same CCN bus (**Configuration**→**CCN**→**CCNB**) but cannot have the same CCN address (**Configuration**→**CCN**→**CCNA**). Both master and slave chillers must have Lead/Lag Chiller Enable (**Configuration**→**RSET**→**LLEN**) configured to ENBL. Master/Slave Select (**Configuration**→**RSET**→**MSSL**) must be configured to MAST for the master chiller and SLVE for the slave. Also in this example, the master chiller will be configured to use Lead/Lag Balance Select (**Configuration**→**RSET**→**LLBL**) and Lead/Lag Balance Delta (**Configuration**→**RSET**→**LLBD**) to even out the chiller run-times weekly. The Lag Start Delay (**Configuration**→**RSET**→**LLDY**) feature will be set to 10 minutes. This will prevent the lag chiller from starting until the lead chiller has been at 100% capacity for the length of the delay time. Parallel configuration (**Configuration**→**RSET**→**PARA**) can only be configured to YES. The variables **LLBL**, **LLBD** and **LLDY** are not used by the slave chiller.

Dual chiller start/stop control is determined by configuration of Control Method (**Configuration**→**OPT1**→**CTRL**) of the Master chiller. The Slave chiller should always be configured for **CTRL**=0 (Switch). If the chillers are to be controlled by Remote Contacts, both Master and Slave chillers should be enabled together. Two separate relays or one relay with two sets of contacts may control the chillers. The Enable/Off/Remote Contact switch should be in the Remote Contact position on both the Master and Slave chillers. The Enable/Off/Remote Contact switch should be in the Enable position for **CTRL**=2 (Occupancy) or **CTRL**=3 (CCN Control).

Both chillers will stop if the Master chiller Enable/Off/Remote Contact switch is in the Off position. If the Emergency Stop switch is turned off or an alarm is generated on the Master chiller the Slave chiller will operate in a Stand-Alone mode. If the Emergency Stop switch is turned off or an alarm is generated on the Slave chiller the Master chiller will operate in a Stand-Alone mode.

The master chiller controls the slave chiller by changing its Control Mode (**Run Status**→**VIEW**→**STAT**) and its operating setpoint or Control Point (**Run Status**→**VIEW**→**CT.PT**).

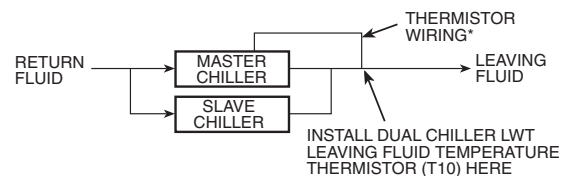

*Depending on piping sizes, use either:
 • HH79NZ014 sensor/10HB50106801 well (3-in. sensor/well)
 • HH79NZ029 sensor/10HB50106802 well (4-in. sensor/well)

Fig. 13 — Dual Chiller Thermistor Location

Table 21 — Dual Chiller Configuration (Master Chiller Example)

SUB-MODE	ITEM	KEYPAD ENTRY	DISPLAY	ITEM EXPANSION	COMMENTS
DISP					
UNIT					
OPT1					
OPT2		ENTER	CTRL	CONTROL METHOD	
	CTRL	ENTER	0	SWITCH	DEFAULT 0
		ESCAPE	OPT2		
CCN		↓	CCN		
	CCNA	ENTER	1	CCN ADDRESS	DEFAULT 1
		↓	CCNB		
	CCNB	ENTER	0	CCN BUS NUMBER	DEFAULT 0
		ESCAPE	CCN		
		↓	RSET		PROCEED TO SUBMODE RSET
RSET		ENTER	CRST	COOLING RESET TYPE	
		↓	LLEN	LEAD/LAG CHILLER ENABLE	↓ 15 ITEMS
	LLEN	ENTER	DSBL		SCROLLING STOPS
		ENTER	DSBL		VALUE FLASHES
		↑	ENBL		SELECT ENBL
	LLEN	ENTER	ENBL	LEAD/LAG CHILLER ENABLE	CHANGE ACCEPTED
		ESCAPE	LLEN		
		↓	MSSL	MASTER /SLAVE SELECT	
	MSSL	ENTER	MAST	MASTER /SLAVE SELECT	DEFAULT MAST
		ESCAPE	MSSL		
		↓	SLVA	SLAVE ADDRESS	
	SLVA	ENTER	0		SCROLLING STOPS
		ENTER	0		VALUE FLASHES
		↑	2		SELECT 2
	SLVA	ENTER	2	SLAVE ADDRESS	CHANGE ACCEPTED
		ESCAPE	SLVA		
		↓	LLBL	LEAD/LAG BALANCE SELECT	
	LLBL	ENTER	0		SCROLLING STOPS
		ENTER	0		VALUE FLASHES
		↑	2		SELECT 2 - Automatic

Table 21 — Dual Chiller Configuration (Master Chiller Example) (cont)

SUB-MODE	ITEM	KEYPAD ENTRY	DISPLAY	ITEM EXPANSION	COMMENTS
RSET	LLBL	<input type="button" value="ENTER"/>	2	LEAD/LAG BALANCE SELECT	CHANGE ACCEPTED
		<input type="button" value="ESCAPE"/>	LLBL		
		<input type="button" value="↓"/>	LLBD	LEAD/LAG BALANCE DELTA	
	LLBD	<input type="button" value="ENTER"/>	168	LEAD/LAG BALANCE DELTA	DEFAULT 168
		<input type="button" value="ESCAPE"/>	LLBD		
		<input type="button" value="↓"/>	LLDY	LAG START DELAY	
	LLDY	<input type="button" value="ENTER"/>	5		SCROLLING STOPS
		<input type="button" value="ENTER"/>	5		VALUE FLASHES
		<input type="button" value="↑"/>	10		SELECT 10
	LLDY	<input type="button" value="ENTER"/>	10	LAG START DELAY	CHANGE ACCEPTED
		<input type="button" value="ESCAPE"/>	LLDY		
		<input type="button" value="ESCAPE"/>	RSET		
	PARA	<input type="button" value="ENTER"/>	YES		MASTER COMPLETE

NOTES:

1. Master Control Method (CTRL) can be configured as 0-Switch, 2-Occupancy or 3-CCN.
2. Parallel Configuration (PARA) cannot be changed.

PART NUMBER	DIMENSIONS in. (mm)	
	A	B
10HB50106801	3.10 (78.7)	1.55 (39.4)
10HB50106802	4.10 (104.1)	1.28 (32.5)

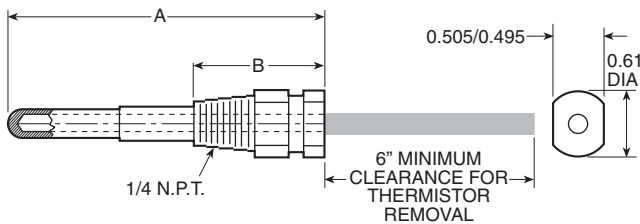

Fig. 14 — Dual Leaving Water Thermistor Well

Temperature Reset — The control system is capable of handling leaving-fluid temperature reset based on return cooler fluid temperature. Because the change in temperature through the cooler is a measure of the building load, the return temperature reset is in effect an average building load reset method. The control system is also capable of temperature reset based on outdoor-air temperature (OAT), space temperature (SPT), or from an externally powered 4 to 20 mA signal. Accessory sensors must be used for SPT reset (33ZCT55SPT) and for OAT reset (HH79NZ014). The energy management module (EMM) must be used for temperature reset using a 4 to 20 mA signal. See Tables 23 and 24.

Table 22 — Dual Chiller Configuration (Slave Chiller Example)

SUB-MODE	ITEM	KEYPAD ENTRY	DISPLAY	ITEM EXPANSION	COMMENTS
DISP					
UNIT					
OPT1					
OPT2		ENTER	CTRL	CONTROL METHOD	
	CTRL		0	SWITCH	DEFAULT 0
		ESCAPE	OPT2		
CCN		↓	CCN		
		↓	CCNA		
	CCNA	ENTER	1	CCN ADDRESS	SCROLLING STOPS
		ENTER	1		VALUE FLASHES
		↑	2		SELECT 2 (SEE NOTE 2)
	CCNA	ENTER	2	CCN ADDRESS	CHANGE ACCEPTED
		ESCAPE	CCN		
	CCNB	ENTER	0	CCN BUS NUMBER	DEFAULT 0 (SEE NOTE 3)
		ESCAPE	CCN		
		↓	RSET		PROCEED TO SUBMODE RSET
RSET		ENTER	CRST	COOLING RESET TYPE	
		↓	LLEN	LEAD/LAG CHILLER ENABLE	↓ 15 ITEMS
	LLEN	ENTER	DSBL		SCROLLING STOPS
		ENTER	DSBL		VALUE FLASHES
		↑	ENBL		SELECT ENBL
	LLEN	ENTER	ENBL	LEAD/LAG CHILLER ENABLE	CHANGE ACCEPTED
		ESCAPE	LLEN		
		↓	MSSL	MASTER /SLAVE SELECT	
	MSSL	ENTER	MAST		SCROLLING STOPS
		ENTER	MAST		VALUE FLASHES
		↑	SLVE		SELECT SLVE
	MSSL	ENTER	SLVE	MASTER /SLAVE SELECT	CHANGE ACCEPTED
		ESCAPE	MSSL		
		ESCAPE	RSET		SLAVE COMPLETE

NOTES:

1. Slave Control Method (CTRL) must be configured for 0.
2. Slave CCN Address (CCNA) must be different than Master.
3. Slave CCN Bus Number (CCNB) must be the same as Master
4. Slave does not require SLVA, LLBL, LLBD, or LLDY to be configured.

Table 23 — Menu Configuration of 4 to 20 mA Cooling Set Point Control

MODE (RED LED)	KEYPAD ENTRY	SUB-MODE	KEYPAD ENTRY	ITEM	DISPLAY	ITEM EXPANSION	COMMENT
CONFIGURATION	ENTER	DISP					
	▼	UNIT					
	▼	OPT1					
	▼	OPT2					
	▼	CCN					
	▼	RSET					
	▼	SLCT	ENTER	CLSP	0	COOLING SETPOINT SELECT	
			ENTER		0		Scrolling Stops
			ENTER		0		Flashing '0'
			▲		3		Select '3'
			ENTER		3		Change Accepted

Table 24 — 4 to 20 mA Reset

SUB-MODE	KEYPAD ENTRY	ITEM	DISPLAY	ITEM EXPANSION	COMMENT
RSET	ENTER	CRST	1	COOLING RESET TYPE	0 = no reset 1 = 4 to 20 mA input 2 = Outdoor air temp 3 = Return Fluid 4 = Space Temperature
	▼	MA.DG	5.0 F (2.8 C)	DEGREES COOL RESET	Default: 0° F (0° C) Reset at 20 mA Range: -30 to 30 F (-16.7 to 16.7 C)

NOTE: The example above shows how to configure the chiller for 4 to 20 mA reset. No reset will occur at 4.0 mA input, and a 5.0 F reset will occur at 20.0 mA. An EMM (energy management module) is required.

IMPORTANT: Care should be taken when interfacing with other control systems due to possible power supply differences: full wave bridge versus half wave rectification. Connection of control devices with different power supplies may result in permanent damage. *ComfortLink™* controls incorporate power supplies with half wave rectification. A signal isolation device should be utilized if the signal generator incorporates a full wave bridge rectifier.

To use outdoor air or space temperature reset, four variables must be configured. In the Configuration mode under the sub-mode RSET, items (*Configuration*→RSET→CRST), (*Configuration*→RSET→RM.NO), (*Configuration*→RSET→RM.F), and (*Configuration*→RSET→RT.DG) must be properly set. See Table 25 — Configuring Outdoor Air and Space Temperature Reset. The outdoor air reset example provides 0° F (0° C) chilled water set point reset at 85.0 F (29.4 C) outdoor-air temperature and 15.0 F (8.3 C) reset at 55.0 F (12.8 C) outdoor-air temperature. The space temperature reset example provides 0° F (0° C) chilled water set point reset at 72.0 F (22.2 C) space temperature and 6.0 F (3.3 C) reset at 68.0 F (20.0 C) space temperature. The variable CRST should be configured for the type of reset desired. The variable

RM.NO should be set to the temperature that no reset should occur. The variable *RM.F* should be set to the temperature that maximum reset is to occur. The variable *RM.DG* should be set to the maximum amount of reset desired. Figures 15 and 16 are examples of outdoor air and space temperature resets.

To use return reset, four variables must be configured. In the Configuration mode under the sub-mode RSET, items CRST, RT.NO, RT.F and RT.DG must be properly set. See Table 26 — Configuring Return Temperature Reset. This example provides 5.0 F (2.8 C) chilled water set point reset at 2.0 F (1.1 C) cooler ΔT and 0° F (0° C) reset at 10.0 F (5.6 C) cooler ΔT. The variable RT.NO should be set to the cooler temperature difference (ΔT) where no chilled water temperature reset should occur. The variable RT.F should be set to the cooler temperature difference where the maximum chilled water temperature reset should occur. The variable *RM.DG* should be set to the maximum amount of reset desired.

To verify that reset is functioning correctly proceed to Run Status mode, sub-mode VIEW, and subtract the active set point (*Run Status*→VIEW→SETP) from the control point (*Run Status*→VIEW→CTPT) to determine the degrees reset.

Table 25 — Configuring Outdoor Air and Space Temperature Reset

MODE (RED LED)	KEYPAD ENTRY	SUB- MODE	KEYPAD ENTRY	ITEM	DISPLAY		ITEM EXPANSION	COMMENT
					Outdoor Air	Space		
CONFIGURATION	ENTER	DISP						
	▼	UNIT						
	▼	OPT1						
	▼	OPT2						
	▼	CCN						
	▼	RSET	ENTER	CRST	2	4	COOLING RESET TYPE	2 = Outdoor-Air Temperature (Connect to LVT-4,5) 4 = Space Temperature (Connect to LVT-3,4)
			▼	RM.NO*	85 °F	72 °F	REMOTE - NO RESET TEMP	Default: 125.0 F (51.7 C) Range: 0° to 125 F
			▼	RM.F	55 °F	68 °F	REMOTE - FULL RESET TEMP	Default: 0.0° F (-17.7 C) Range: 0° to 125 F
			▼	RM.DG	15 °F	6 °F	REMOTE - DEGREES RESET	Default: 0° F (0° C) Range: -30 to 30 F (-34.4 to -1.1 °C)

*1 item skipped in this example.

Table 26 — Configuring Return Temperature Reset

MODE (RED LED)	KEYPAD ENTRY	SUB- MODE	KEYPAD ENTRY	ITEM	DISPLAY	ITEM EXPANSION	COMMENT
CONFIGURATION	ENTER	DISP	ENTER	TEST	ON/OFF	TEST DISPLAY LEDs	
	▼	UNIT	ENTER	TYPE	X	UNIT TYPE	
	▼	OPT1	ENTER	FLUD	X	COOLER FLUID	
	▼	OPT2	ENTER	CTRL	X	CONTROL METHOD	
	▼	CCN					
	▼	RSET	ENTER	CRST	3	COOLING RESET TYPE	0 = No Reset 1 = 4 to 20 mA Input (EMM required) (Connect to EMM TB6-2,3) 2 = Outdoor-Air Temperature 3 = Return Fluid 4 = Space Temperature (Connect to TB5-5,6)
			▼	RT.NO*	10.0 ΔF	RETURN FLUID - NO RESET TEMP	Default: 10.0 ΔF (5.6 ΔC) Range: 0° to 10 F COOLER ΔT
			▼	RT.F	2.0 ΔF	RETURN FLUID - FULL RESET TEMP	Default: 0 ΔF (-17.8 ΔC) Range: 0° to 30 F COOLER ΔT
			▼	RT.DG	5.0 ΔF	RETURN - DEGREES RESET	Default: 0 ΔF (0 ΔC) Range: -30 to 30°F (-16.7 to 16.7 C)

*1 item skipped in this example.

Under normal operation, the chiller will maintain a constant leaving fluid temperature approximately equal to the chilled fluid set point. As the cooler load varies, the entering cooler fluid will change in proportion to the load as shown in Fig. 17. Usually the chiller size and leaving-fluid temperature set point are selected based on a full-load condition. At part load, the fluid temperature set point may be colder than required. If the leaving fluid temperature was allowed to increase at part load, the efficiency of the machine would increase.

Return temperature reset allows for the leaving temperature set point to be reset upward as a function of the return fluid temperature or, in effect, the building load.

Demand Limit — Demand limit is a feature that allows the unit capacity to be limited during periods of peak energy usage. There are 3 types of demand limiting that can be configured. The first type is through 2-stage switch control, which will reduce the maximum capacity to 2 user-configurable percentages. The second type is by 4 to 20 mA signal input which will reduce the maximum capacity linearly between 100% at a 4 mA input signal (no reduction) down to the user-configurable level at a 20 mA input signal. The third type uses the CCN Loadshed module and has the ability to limit the current operating capacity to maximum and further reduce the capacity if required.

NOTE: The 2-stage switch control and 4 to 20-mA input signal types of demand limiting require the energy management module (EMM).

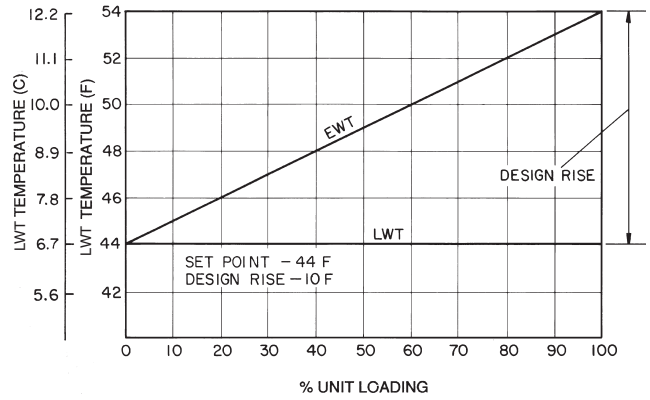

LEGEND
EWT — Entering Water (Fluid) Temperature
LWT — Leaving Water (Fluid) Temperature

Fig. 17 — Standard Chilled Fluid Temperature Control — No Reset

To use demand limit, select the type of demand limiting to use. Then configure the demand limit set points based on the type selected.

DEMAND LIMIT (2-Stage Switch Controlled) — To configure demand limit for 2-stage switch control set the Demand Limit Select (*Configuration* → **RSET** → **DMDC**) to 1. Then configure the 2 Demand Limit Switch points (*Configuration* → **RSET** → **DLS1**) and (*Configuration* → **RSET** → **DLS2**) to the desired capacity limit. See Table 27. Capacity steps are controlled by 2 relay switch inputs field wired to LVT as shown in Fig. 5.

For demand limit by 2-stage switch control, closing the first stage demand limit contact will put the unit on the first demand limit level. The unit will not exceed the percentage of capacity entered as Demand Limit Switch 1 set point (**DLS1**). Closing contacts on the second demand limit switch prevents the unit from exceeding the capacity entered as Demand Limit Switch 2 set point. The demand limit stage that is set to the lowest demand takes priority if both demand limit inputs are closed. If the demand limit percentage does not match unit staging, the unit will limit capacity to the closest capacity stage.

To disable demand limit configure **DMDC** to 0. See Table 27.

EXTERNALLY POWERED DEMAND LIMIT (4 to 20 mA Controlled) — To configure demand limit for 4 to 20 mA control set the Demand Limit Select (*Configuration* → **RSET** → **DMDC**) to 2. Then configure the Demand Limit at 20 mA (*Configuration* → **RSET** → **DM20**) to the maximum loadshed value desired. Connect the output from an externally powered 4 to 20 mA signal to terminal block LVT, terminals 7 and 8 (+,-). Refer to the unit wiring diagram for these connections to the optional/accessory energy management module and terminal block. The control will reduce allowable capacity to this level for the 20 mA signal. See Table 27 and Fig. 18.

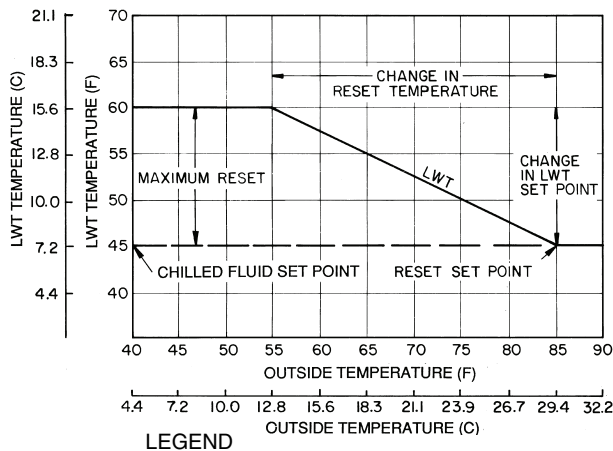

LWT — Leaving Water (Fluid) Temperature

Fig. 15 — Outdoor-Air Temperature Reset

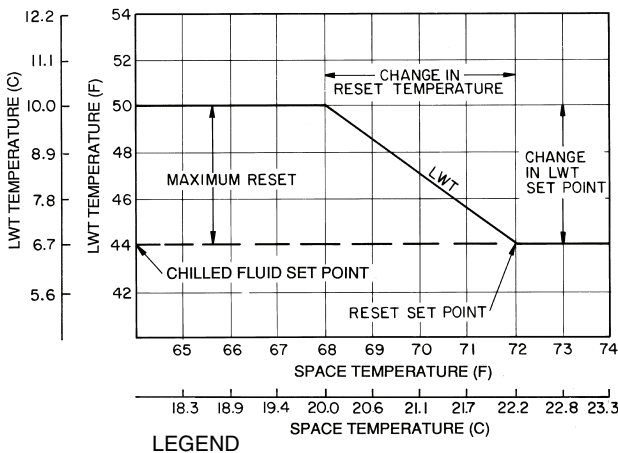

LWT — Leaving Water (Fluid) Temperature

Fig. 16 — Space Temperature Reset

CAUTION

Care should be taken when interfacing with other manufacturer's control systems, due to possible power supply differences, full wave bridge versus half wave rectification. The two different power supplies cannot be mixed. *ComfortLink*™ controls use half wave rectification. A signal isolation device should be utilized if a full wave bridge signal generating device is used.

DEMAND LIMIT (CCN Loadshed Controlled) — To configure Demand Limit for CCN Loadshed control set the Demand Limit Select (*Configuration* → *RSET* → *DMDC*) to 3. Then configure the Loadshed Group Number (*Configuration* → *RSET* → *SHNM*), Loadshed Demand Delta (*Configuration* → *RSET* → *SHDL*), and Maximum Loadshed Time (*Configuration* → *RSET* → *SHTM*). See Table 27.

The Loadshed Group number is established by the CCN system designer. The *ComfortLink*™ controls will respond to a Redline command from the Loadshed control. When the Redline command is received, the current stage of capacity is set to the maximum stages available. Should the loadshed control send a Loadshed command, the *ComfortLink* controls will reduce the current stages by the value entered for Loadshed Demand delta. The Maximum Loadshed Time is the maximum

length of time that a loadshed condition is allowed to exist. The control will disable the Redline/Loadshed command if no Cancel command has been received within the configured maximum loadshed time limit.

Cooling Set Point (4 to 20 mA) — A field supplied and generated, externally powered 4 to 20 mA signal can be used to provide the leaving fluid temperature set point. Connect the signal to LVT-10,8 (+,-). See Table 27 for instructions to enable the function. Figure 19 shows how the 4 to 20 mA signal is linearly calculated on an overall 10 F to 80 F range for fluid types (*Configuration* → *OPT1* → *FLUD*) 1 or 2. The set point will be limited by the fluid (*FLUD*) type. Be sure that the chilled water loop is protected at the lowest temperature.

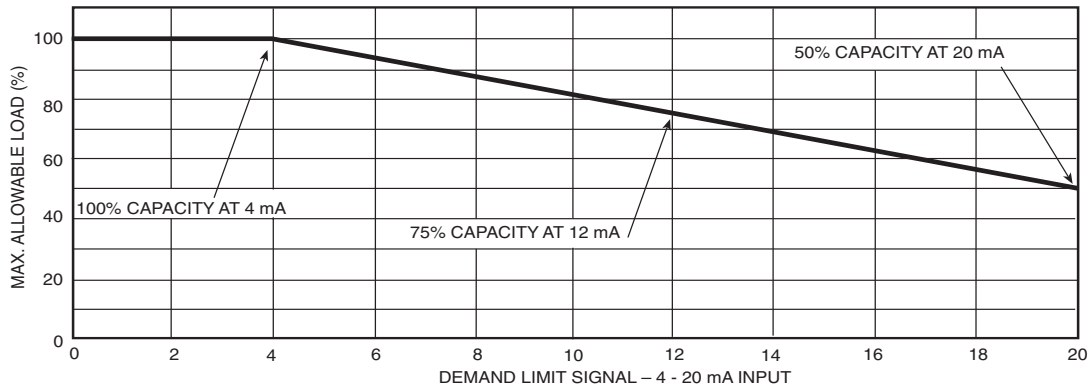
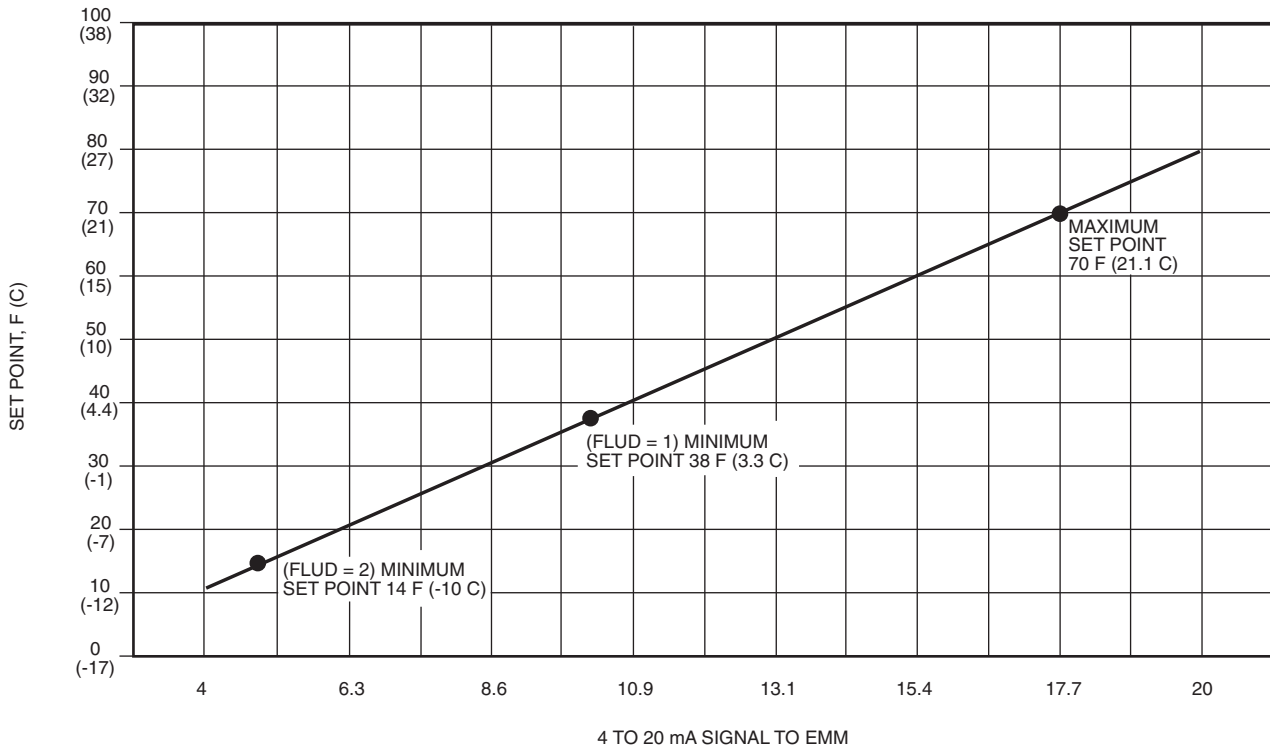

Fig. 18 — 4 to 20-mA Demand Limiting



EMM — Energy Management Module

Fig. 19 — Cooling Set Point (4 to 20 mA)

Table 27 — Configuring Demand Limit

MODE	KEYPAD ENTRY	SUB-MODE	KEYPAD ENTRY	ITEM	DISPLAY	ITEM EXPANSION	COMMENT
CONFIGURATION	ENTER	DISP	ENTER	TEST	ON/OFF	Test Display LEDs	
	▼	UNIT	ENTER	TYPE	X	Unit Type	
	▼	OPT1	ENTER	FLUD	X	Cooler Fluid	
	▼	OPT2	ENTER	CTRL	X	Control Method	
	▼	CCN	ENTER	CCNA	X	CCN Address	
	▼	RSET	ENTER	CRST	X	Cooling Reset Type	
			▼	DMDC*	X	Demand Limit Select	Default: 0 0 = None 1 = Switch 2 = 4 to 20 mA Input 3 = CCN Loadshed
			▼	DM20	XXX %	Demand Limit at 20 mA	Default: 100% Range: 0 to 100
			▼	SHNM	XXX	Loadshed Group Number	Default: 0 Range: 0 to 99
			▼	SHDL	XXX%	Loadshed Demand Delta	Default: 0% Range: 0 to 60%
			▼	SHTM	XXX MIN	Maximum Loadshed Time	Default: 60 min. Range: 0 to 120 min.
			▼	DLS1	XXX %	Demand Limit Switch 1	Default: 80% Range: 0 to 100%
			▼	DLS2	XXX %	Demand Limit Switch 2	Default: 50% Range: 0 to 100%

*Seven items skipped in this example.

PRE-START-UP

IMPORTANT: Before beginning Pre-Start-Up or Start-Up, complete Start-Up Checklist for 30MP Liquid Chiller at end of this publication (page CL-1 to CL-8). The checklist assures proper start-up of a unit, and provides a record of unit condition, application requirements, system information, and operation at initial start-up.

Do not attempt to start the chiller until following checks have been completed.

System Check

1. Check all auxiliary components, such as chilled fluid pumps, air-handling equipment, condenser pump or other equipment to which the chiller supplies liquid. Consult manufacturer's instructions. Verify that any pump interlock contacts have been properly installed. If the unit has field-installed accessories, be sure all are properly installed and wired correctly. Refer to unit wiring diagrams.
2. Use the scrolling marquee display to adjust the Cooling Set Point.
3. Fill chilled fluid circuit with clean water (with recommended inhibitor added) or other non-corrosive fluid to be cooled. Bleed all air out of the high points of the system. If chilled water is to be maintained at a temperature below 40 F (4.4 C), a brine of sufficient concentration must be used to prevent freeze-up at anticipated suction temperatures. To ensure sufficient loop volume, see Table 28.
4. Check tightness of all electrical connections.

5. Oil should be visible in the compressor sightglass(es). See Fig. 20. An acceptable oil level in the compressors is from 1/8 to 3/8 of sight glass when the compressors are off. Adjust the oil level as required. See Oil Charge section on page 37 for Carrier approved oils.
6. Crankcase heaters must be firmly attached to compressors, and must be on for 24 hours prior to start-up (30MPA units only).
7. Electrical power source must agree with unit nameplate.
8. Check rotation of scroll compressors. Monitor control alarms during first compressor start up for reverse rotation protection alarm.

Table 28 — Minimum Flow Rates and Minimum Loop Volume (for Comfort Cooling)

UNIT SIZE	EVAPORATOR		CONDENSER*		MINIMUM EVAPORATOR LOOP VOLUME	
	Gal./Min	L/s	Gal./Min	L/s	Gal.	L
30MP015	22	1.4	22	1.4	46.2	174.9
30MP020	28	1.8	28	1.8	60.9	230.5
30MP030	43	2.7	43	2.7	92.4	349.7
30MP040	55	3.5	55	3.5	78.4	296.7
30MP045	64	4.0	64	4.0	91.6	346.7

LEGEND

- AHRI — Air Conditioning, Heating, and Refrigeration Institute
- N — Liters per kW
- V — Gallons per ton

NOTES:
Gallons = V x AHRI capacity in tons.
Liters = N x AHRI capacity in kW.

APPLICATION	V	N
Normal Air Conditioning	3	3.25
Process Type Cooling	6 to 10	6.5 to 10.8
Low Ambient Operation	6 to 10	6.5 to 10.8

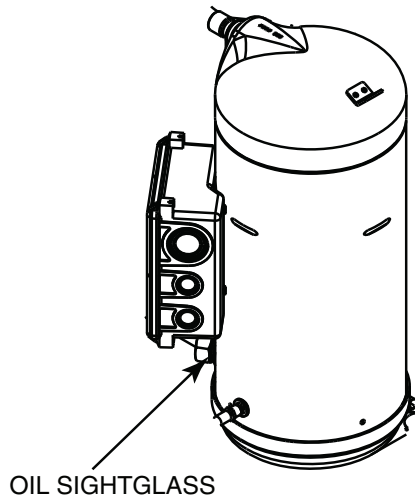

Fig. 20 — Sight Glass Location

START-UP AND OPERATION

⚠ CAUTION

Crankcase heaters on 30MPA units are wired into the control circuit, so they are always operable as long as the main power supply disconnect is on (closed), even if any safety device is open. Compressor heaters must be on for 24 hours prior to the start-up of any compressor. Equipment damage could result if heaters are not energized for at least 24 hours prior to compressor start-up.

Compressor crankcase heaters must be on for 24 hours before start-up. To energize the crankcase heaters, close the field disconnect. Leave the compressor circuit breakers off/open. The crankcase heaters are now energized.

NOTE: Refer to Start-Up Checklist on pages CL-1 to CL-8.

Actual Start-Up — Actual start-up should be done only under supervision of a qualified refrigeration mechanic.

1. Be sure all service valves are open (30MPA units only).
2. Using the scrolling marquee display, set leaving-fluid set point (**Set Points**→**COOL**→**CSP.1**). No cooling range adjustment is necessary.
3. Start chilled fluid pump (if not configured for cooler pump control).
4. Turn ENABLE/OFF/REMOTE CONTACT switch to ENABLE position.
5. Allow unit to operate and confirm that everything is functioning properly. Check to see that leaving fluid temperature agrees with leaving set point (**Set Points**→**COOL**→**CSP.1**) or (**Set Points**→**COOL**→**CSP.2**), or if reset is used, with the control point (**Run Status**→**VIEW**→**CTPT**).
6. Check the cooler leaving chilled water temperature to see that it remains well above 32 F (0° C), or the brine freezing point if the unit is a medium temperature brine unit.
7. Recheck compressor oil level (see Oil Charge section).

Check Refrigerant Charge — All 30MPW units are shipped with a complete operating charge of R-410A and should be under sufficient pressure to conduct a leak test after installation. If there is no system pressure, admit nitrogen until a pressure is observed and then proceed to test for leaks. After leaks are repaired, the system must be dehydrated.

All refrigerant charging should be done through the 1/4-in. Schraeder connection on the liquid line. Do NOT add refrigerant charge through the low-pressure side of the system. If complete charging is required, weigh in the appropriate charge for the circuit as shown on the unit nameplate. If partial charging is required, operate circuit at full load and add charge until the sight glass is clear of bubbles.

⚠ CAUTION

Never charge liquid into low-pressure side of system. Do not overcharge. Overcharging results in higher discharge pressure, possible compressor damage, and higher power consumption. During charging or removal of refrigerant, be sure water is continuously circulating through the cooler to prevent freezing.

The 30MPA units (condenserless) are shipped with a nitrogen holding charge only. After chiller assembly is completed in the field, system must be fully charged. While the unit is running at full capacity, add refrigerant until the sight glass is clear. R-410A is the normal refrigerant.

Do not open the liquid valve until there is a charge in remainder of system. *A positive pressure indicates a charge in system.* With the unit operating at **full load**, check liquid line sight glass to be sure the unit is fully charged (bubbles in the sight glass indicate the unit is **not** fully charged).

If there is no refrigerant vapor pressure in the system, the entire system must be leak tested. After repairing leaks, evacuate the system before recharging.

Follow approved evacuation procedures when removing refrigeration. Release remaining pressure to an approved evacuated cylinder.

The liquid charging method is recommended for complete charging or when additional charge is required.

⚠ CAUTION

Be careful not to overcharge the system. Overcharging results in higher discharge pressure, possible compressor damage, and higher power consumption.

EVACUATION AND DEHYDRATION — Because the 30MP systems use polyolester (POE) oil, which can absorb moisture, it is important to minimize the amount of time that the system interior is left exposed to the atmosphere. Minimizing the exposure time of the oil to the atmosphere will minimize the amount of moisture that needs to be removed during evacuation.

Once all of the piping connections are complete, leak test the unit and then pull a deep dehydration vacuum. Connect the vacuum pump to the high flow Schraeder valve in the suction line and liquid line. For best results, it is recommended that a vacuum of at least 500 microns (0.5 mm Hg) be obtained. Afterwards, to ensure that no moisture is present in the system, perform a standing vacuum-rise test.

With the unit in deep vacuum (500 microns or less), isolate the vacuum pump from the system. Observe the rate-of-rise of the vacuum in the system. If the vacuum rises by more than 50 microns in a 30-minute time period, then continue the dehydration process. Maintain a vacuum on the system until the standing vacuum requirement is met. This will ensure a dry system.

By following these evacuation and dehydration procedures, the amount of moisture present in the system will be minimized. It is required that liquid line filter driers be installed between the condenser(s) and the expansion devices to capture any foreign debris and provide additional moisture removal capacity.

LIQUID CHARGING METHOD — Add charge to the unit through the liquid line service valve. **Never charge liquid into the low-pressure side of the system.**

1. Close liquid line ball valve (30MPA only).
2. Connect a refrigerant cylinder loosely to the high flow Schraeder valve connection on the liquid line. Purge the charging hose and tighten the connections.
3. Open the refrigerant cylinder valve.
4. If the system has been dehydrated and is under vacuum, break the vacuum with refrigerant gas. For R-410A, build up system pressure to 101 psig and 32 F (697 kPa and 0° C). Invert the refrigerant cylinder so that the liquid refrigerant will be charged.
5.
 - a. For complete charge of 30MPW units, follow charging by weight procedure. When charge is nearly full, complete the process by observing the sight glass for clear liquid flow while the unit is operating. *The use of sight glass charging is valid only when unit is operating at full capacity.*
 - b. For complete charge of 30MPA units or where refrigerant cylinder cannot be weighed, follow the condenser manufacturer's charging procedure or follow charging by sight glass procedure. *The use of sight glass charging is valid only when unit is operating at full capacity.*
6.
 - a. The 30MPA condensers units are shipped with a nitrogen holding charge. After installation with the field-supplied system high side, the complete system should be evacuated and charged per the condenser manufacturer's charging procedure or charged until the sight glass is clear (with the unit running at full capacity). To achieve maximum system capacity, add additional charge equal to the difference between the condenser optimal charge and the condenser minimum charge, which can be obtained from the charge data provided in the condenser installation instructions.
 - b. To ensure maximum performance of 30MPW units, raise the compressor saturated discharge temperature (SDT) to approximately 100 F (37.8 C) by throttling the condenser water intake. Add charge until there is approximately 9 to 12° F (5.0 to 6.6° C) of system subcooling (SDT minus actual temperature entering the thermostatic expansion valve).

Operating Limitations

TEMPERATURES (See Table 29 for 30MP standard temperature limits).

⚠ CAUTION

Do not operate with cooler leaving chiller water (fluid) temperature (LCWT) below 32 F (0° C) for standard units with proper brine solution or 40 F (4.4 C) for the standard units with fresh water, or below 15 F (-9.4 C) for units factory built for medium temperature brine.

High Cooler Leaving Chilled Water (Fluid) Temperatures (LCWT) — During start-up with cooler the LCWT should not be above approximately 60 F (16 C).

Low Cooler LCWT — For standard units with fresh water, the LCWT must be no lower than 40 F (4.4 C). For standard units with a proper brine solution, the LCWT must be no lower than 32 F (0° C). If the unit is the factory-installed optional

medium temperature brine unit, the cooler LCWT can go down to 15 F (-9.4 C).

Table 29 — Temperature Limits for Standard 30MP Units

TEMPERATURE LIMIT	F	C
Maximum Condenser LWT	140	60
Minimum Condenser EWT	70	21
Maximum Cooler EWT*	95	35
Maximum Cooler LWT	70	21
Minimum Cooler LWT†	40	4

LEGEND

EWT — Entering Fluid (Water) Temperature
LWT — Leaving Fluid (Water) Temperature

*For sustained operation, EWT should not exceed 85 F (29.4 C).
†Unit requires modification below this temperature.

⚠ CAUTION

Medium temperature brine duty application (below 32 F [0° C] LCWT) for chiller normally requires factory modification. Contact your Carrier representative for applicable LCWT range for standard water-cooled chiller in a specific application.

VOLTAGE — ALL UNITS

Main Power Supply — Minimum and maximum acceptable supply voltages are listed in the Installation Instructions.

Unbalanced 3-Phase Supply Voltage — Never operate a motor where a phase imbalance between phases is greater than 2%. To determine percent voltage imbalance:

$$\% \text{ Voltage Imbalance} = 100 \times \frac{\text{max voltage deviation from avg voltage}}{\text{average voltage}}$$

The maximum voltage deviation is the largest difference between a voltage measurement across 2 legs and the average across all 3 legs.

Example: Supply voltage is 240-3-60.

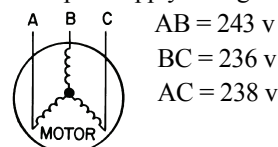

1. Determine average voltage:

$$\begin{aligned} \text{Average voltage} &= \frac{243 + 236 + 238}{3} \\ &= \frac{717}{3} \\ &= 239 \end{aligned}$$

2. Determine maximum deviation from average voltage:

$$\begin{aligned} (\text{AB}) \quad &243 - 239 = 4 \text{ v} \\ (\text{BC}) \quad &239 - 236 = 3 \text{ v} \\ (\text{AC}) \quad &239 - 238 = 1 \text{ v} \end{aligned}$$

Maximum deviation is 4 v.

3. Determine percent voltage imbalance:

$$\begin{aligned} \% \text{ Voltage Imbalance} &= 100 \times \frac{4}{239} \\ &= 1.7\% \end{aligned}$$

This voltage imbalance is satisfactory as it is below the maximum allowable of 2%.

IMPORTANT: If the supply voltage phase imbalance is more than 2%, contact your local electric utility company immediately. Do not operate unit until imbalance condition is corrected.

Control Circuit Power — Power for the control circuit is supplied from the main incoming power through a factory-installed control power transformer (TRAN1) for all models. Field wiring connections are made to the LVT.

OPERATION SEQUENCE

The unit is started by putting the ENABLE/OFF/REMOTE CONTACT switch in the ENABLE or REMOTE CONTACT position. When the unit receives a call for cooling (either from the internal control or CCN network command or remote contact closure), the unit stages up in capacity to maintain the leaving fluid set point. The first compressor starts 1½ to 3 minutes after the call for cooling.

For all units, if temperature reset is being used, the unit controls to a higher leaving-fluid temperature as the building load reduces. If demand limit is used, the unit may temporarily be unable to maintain the desired leaving-fluid temperature because of imposed power limitations.

SERVICE

⚠ WARNING

Electrical shock can cause personal injury and death. Shut off all power to this equipment during service. There may be more than one disconnect switch. Tag all disconnect locations to alert others not to restore power until work is completed.

Electronic Components

CONTROL COMPONENTS — Unit uses an advanced electronic control system that normally does not require service. For details on controls refer to Operating Data section.

Access to the controls is through a hinged panel. Inner panels are secured in place and should not be removed unless all power to the chiller is off.

Compressor Replacement — All models contain scroll compressors and have two or three compressors. A compressor is most easily removed from the side of the unit or above, depending on where clearance space was allowed during unit installation. See Fig. 21.

Remove the junction box cover bolts and disconnect the compressor power and crankcase heater connections (30MPA only). Remove the cable from the compressor junction box. Remove the connections from the high-pressure switch. Remove the crankcase heater. Knock the same holes out of the new compressor junction box and install the cable connectors from the old compressor.

The compressors are bolted to rails, which are in turn bolted to the unit basepan for all sizes. Remove the 4 bolts holding the compressor to the rail on the basepan. Save the mounting hardware for use with the new compressor. Carefully cut the compressor suction and discharge lines with a tubing cutter as close to the compressor as feasible. Remove high-pressure switch and pressure transducer(s) if required for compressor removal. Lift one corner of the compressor at a time and remove all the steel spacers. Remove the old compressor from the unit.

Slide the new compressor in place on the rails. Lifting one side of the compressor at a time, replace all of the compressor

mounting hardware. Using new tubing as required, reconnect compressor suction and discharge lines. Using hardware saved, reinstall the mounting bolts and washers through the compressor feet. Using proper techniques, braze suction and discharge lines and check for leaks. Reconnect oil equalization line.

Re-install the crankcase heater (30MPA units). Reconnect the compressor power connections and high-pressure switch wiring as on the old compressor. Refer to Fig. 21. Following the installation of the new compressor, tighten all hardware to the following specifications. (See Table 30.)

Table 30 — Unit Torque Specification

FASTENER	RECOMMENDED TORQUE
Compressor Mounting Bolts	7 to 10 ft-lb (9.5 to 13.5 N-m)
Compressor Power Connections	24 to 28 in.-lb (2.7- to 3.2 N-m)
Compressor Ground Terminal Connections	14 to 18 in.-lb (1.6 to 2.0 N-m)

30MPW Condenser and 30MP Cooler

BRAZED-PLATE COOLER AND CONDENSER HEAT EXCHANGER REPLACEMENT — Brazed-plate heat exchangers cannot be repaired if they develop a leak. If a leak (refrigerant or water) develops, the heat exchanger **must** be replaced. To replace a brazed plate heat exchanger:

1. Disconnect the liquid-in and liquid-out connections at the heat exchanger.
2. Check that the replacement heat exchanger is the same as the original heat exchanger. For the condensers, compare part numbers on the heat exchangers. For the coolers, insulation covers the manufacturer's part number. Make sure the depths of the replacement and original cooler heat exchangers are the same.
3. Recover the refrigerant from the system, and unsolder the refrigerant-in and refrigerant-out connections.
4. Remove the four nuts holding the heat exchanger to the brackets. Save the nuts.
5. Install the replacement heat exchanger in the unit and attach to the bracket using the four nuts removed in Step 4. For sizes 015 and 020, torque is 7-10 ft-lb. For sizes 030-045, torque is 35 to 50 ft-lb.
6. *Carefully* braze the refrigerant lines to the connections on the heat exchanger. Lines should be soldered using silver as the soldering material with a minimum of 45% silver. Keep the temperature below 1472 F (800 C) under normal soldering conditions (no vacuum) to prevent the copper solder of the brazed plate heat exchanger from changing its structure. Failure to do so can result in internal or external leakage at the connections which cannot be repaired.
7. For coolers, ensure that the original size tubing is used (½-in. for sizes 015 and 020 and 5/8-in. for sizes 030-045) between the TXV and the cooler. The TXV must be located within 1 ft of the heat exchanger, with no bends between the TXV outlet and the cooler inlet.
8. Reconnect the water/brine lines.
9. Dehydrate and recharge the unit. Check for leaks.

BRAZED-PLATE COOLER AND CONDENSER HEAT EXCHANGER CLEANING — Brazed-plate heat exchangers must be cleaned chemically. A professional cleaning service skilled in chemical cleaning should be used. Use a weak acid (5% phosphoric acid, or if the heat exchanger is cleaned frequently, 5% oxalic acid). Pump the cleaning solution through the exchanger, preferably in a backflush mode. After cleaning, rinse with large amounts of fresh water to dispose of all the acid. Cleaning materials must be disposed of properly.

The strainers in front of the water/brine inlets of the heat exchangers should be cleaned periodically, depending on condition of the chiller water/brine.

Oil Charge

⚠ CAUTION

The compressor in a Puron® refrigerant (R-410A) system uses a polyol ester (POE) oil. This is extremely hygroscopic, meaning it absorbs water readily. POE oils can absorb 15 times as much water as other oils designed for HCFC and CFC refrigerants. Take all necessary precautions to avoid exposure of the oil to the atmosphere. Failure to do so could result in possible equipment damage.

Puron refrigerant systems use a polyol ester (POE) oil. Use only Carrier approved compressor oil. Oil should be visible in compressor oil sight glass. An acceptable oil level is from $\frac{1}{8}$ to $\frac{3}{8}$ of sight glass. All compressors must be off when checking oil level. Recommended oil level adjustment method is as follows:

ADD OIL — Recover charge from the unit. Add oil to suction line Schrader valve on tandem compressors sets and the compressor Schrader on the trios. (See Fig. 21.) When oil can be seen at the bottom of the sight glass, add oil in 5 oz increments which is approximately $\frac{1}{8}$ in oil level. Run all compressors for 20 minutes then shut off to check oil level. Repeat procedure until acceptable oil level is present.

NOTE: Use only Carrier approved compressor oil. Approved sources are:

Totaline	3MAF POE, P903-1601
Mobil	EAL Arctic 32-3MA
Uniqema	RL32-3MAF

Do not reuse oil that has been drained out, or oil that has been exposed to atmosphere.

Check Refrigerant Feed Components

FILTER DRIER — The function of the filter drier is to maintain a clean, dry system. The moisture indicator (described below) indicates any need to change the filter drier. The filter drier is a sealed-type drier. When the drier needs to be changed, the entire filter drier must be replaced.

MOISTURE-LIQUID INDICATOR — The indicator is located immediately ahead of the TXV to provide an indication of the refrigerant moisture content. It also provides a sight glass for refrigerant liquid. Clear flow of liquid refrigerant (*at full unit loading*) indicates sufficient charge in the system. Bubbles in the sight glass (*at full unit loading*) indicate an undercharged system or the presence of noncondensables. Moisture in the system, measured in parts per million (ppm), changes the color of the indicator as follows:

- Green (safe) — Moisture is below 75 ppm
- Yellow-Green (caution) — 75 to 150 ppm
- Yellow (wet) — above 150 ppm

The unit must be in operation at least 12 hours before the moisture indicator gives an accurate reading, and must be in contact with *liquid* refrigerant. At the first sign of moisture in the system, change the corresponding filter drier.

THERMOSTATIC EXPANSION VALVE (TXV) — The TXV controls the flow of liquid refrigerant to the cooler by maintaining constant superheat of vapor leaving the cooler. The valve(s) is activated by a temperature-sensing bulb(s) strapped to the suction line(s).

The valve(s) is factory-set to maintain between 8° and 10° F (4.4° and 5.6° C) of superheat leaving the cooler. Check the superheat during operation after conditions have stabilized. If necessary, adjust the superheat to prevent refrigerant floodback to the compressor.

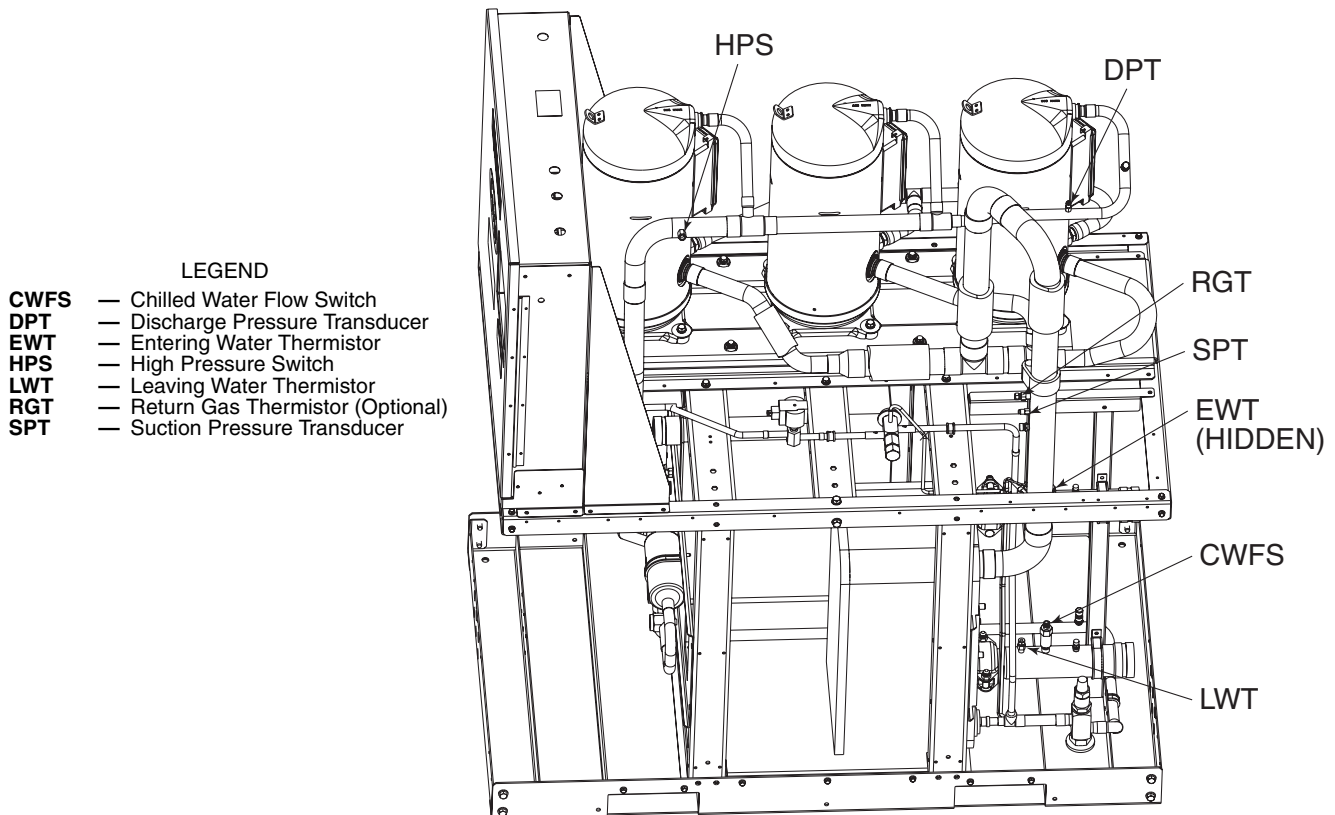

Fig. 21 — Compressor Location — 30MP015-045 Units (30MPW045 Unit Shown)

⚠ WARNING

On medium temperature brine units, the anti-freeze solution must be properly mixed to prevent freezing at a temperature of at least 15 F (8.3 C) below the leaving-fluid temperature set point. Failure to provide the proper anti-freeze solution mixture is considered abuse and may impair or otherwise negatively impact the Carrier warranty.

MINIMUM LOAD VALVE — On units equipped with the factory-installed hot gas bypass option, a solenoid valve and discharge bypass valve (minimum load valve) are located between the discharge line and the cooler entering-refrigerant line. The MBB cycles the solenoid to perform minimum load valve function and the discharge bypass valve modulates to the suction pressure set point of the valve. The bypass valve has an adjustable opening setting between 95 to 115 psig (655 to 793 kPa). The factory setting is 105 psig (724 kPa).

The amount of capacity reduction achieved by the minimum load valve is not adjustable. The total unit capacity with the minimum load valve is shown in Table 19.

PRESSURE RELIEF DEVICES — All units have one pressure relief device per circuit located in the liquid line which relieves at 210 F (100 C).

The 30MPW unit does not have a condenser pressure relief valve, because the brazed-plate condenser is not considered a pressure vessel, as defined in ANSI/ASHRAE 15 (American National Standards Institute/American Society of Heating, Refrigerating, and Air Conditioning Engineers) safety code requirements.

For 30MPA condenserless units, pressure relief devices designed to relieve at the pressure determined in local codes, must be field-supplied and installed in the discharge line piping in accordance with ANSI/ASHRAE 15 safety code requirements. Additional pressure relief valves, properly selected, must be field-supplied and installed to protect high side equipment and may be required by applicable codes.

Most codes require that a relief valve be vented directly to the outdoors. *The vent line must not be smaller than the relief valve outlet.* Consult ANSI/ASHRAE 15 for detailed information concerning layout and sizing of relief vent lines.

Check Unit Safeties

HIGH-PRESSURE SWITCH — A high-pressure switch is provided to protect each compressor and refrigeration system from unsafe high pressure conditions. See Table 31 for high-pressure switch settings.

The high-pressure switch is mounted in the discharge line of each circuit. If an unsafe, high-pressure condition should exist, the switch opens and shuts off the affected circuit. The CSB (current sensing board) senses the compressor feedback signal and generates an appropriate alarm. The MBB prevents the circuit from restarting until the alert condition is reset. The switch should open at the pressure corresponding to the appropriate switch setting as shown in Table 31.

Table 31 — Factory Settings, High-Pressure Switch (Fixed)

UNIT	CUTOUT		CUT-IN	
	Psig	kPa	Psig	kPa
30MP015-045	650	4482	500	3447

Clear the alarm using the scrolling marquee display. The unit should restart after the compressor anti-short-cycle delay, built into the unit control module, expires.

PRESSURE TRANSDUCERS — Each unit is equipped with a suction and discharge pressure transducer. These inputs to the MBB are not only used to monitor the status of the unit, but to also maintain operation of the chiller within the compressor manufacturer's specified limits. The input to the MBB from the suction pressure transducer is also used to protect the compressor from operating at low pressure conditions. If suction return gas thermistors are installed, then additional low superheat conditions are detected. In some cases, the unit may not be able to run at full capacity. The control module will automatically reduce the capacity of a circuit as needed to maintain specified maximum/minimum operating pressures.

The main base board (MBB) monitors cooler leaving fluid temperature at all times. The MBB will rapidly remove stages of capacity as necessary to prevent freezing conditions due to the rapid loss of load or low cooler fluid flow.

When the cooler is exposed to lower temperatures (40 F [4.4 C] or below), freeze-up protection is required using inhibited ethylene or propylene glycol.

Thermistors — Electronic control uses up to five 5 kΩ thermistors to sense temperatures used to control operation of the chiller. Thermistors EWT, LWT, RGTA, CNDE, CNDL, and OAT are identical in their temperature and voltage drop performance. The SPT space temperature thermistor has a 10 kΩ input channel and it has a different set of temperature vs. resistance and voltage drop performance. Resistance at various temperatures are listed in Tables 32-35. For dual chiller operation, a dual chiller sensor is required which is a 5 kΩ thermistor.

REPLACING THERMISTORS (EWT, LWT, RGT, CNDE, CNDL) — Add a small amount of thermal conductive grease to the thermistor well and end of probe. For all probes, tighten the retaining nut ¼ turn past finger tight. See Fig. 22.

THERMISTOR/TEMPERATURE SENSOR CHECK — A high quality digital volt-ohmmeter is required to perform this check.

1. Connect the digital voltmeter across the appropriate thermistor terminals at the J8 terminal strip on the main base board (see Fig. 23).
2. Using the voltage reading obtained, read the sensor temperature from Tables 32-35.
3. To check thermistor accuracy, measure temperature at probe location with an accurate thermocouple-type temperature measuring instrument. Insulate thermocouple to avoid ambient temperatures from influencing reading. Temperature measured by thermocouple and temperature determined from thermistor voltage reading should be close, ± 5° F (3° C) if care was taken in applying thermocouple and taking readings.

If a more accurate check is required, unit must be shut down and thermistor removed and checked at a known temperature (freezing point or boiling point of water) using either voltage drop measured across thermistor at the J8 terminal, by determining the resistance with chiller shut down and thermistor disconnected from J8. Compare the values determined with the value read by the control in the Temperatures mode using the scrolling marquee display.

Pressure Transducers — The suction and discharge transducers are different part numbers and can be distinguished by the color of the transducer body, suction (yellow) and discharge (red). No pressure transducer calibration is required. The transducers operate on a 5 vdc supply, which is generated by the main base board (MBB). See Fig. 23 for transducer connections to the J8 connector on the MBB.

TROUBLESHOOTING — If a transducer is suspected of being faulty, first check supply voltage to the transducer. Supply voltage should be 5 vdc ± 0.2 v. If supply voltage is correct, compare pressure reading displayed on the scrolling marquee display module against pressure shown on a calibrated pressure

gauge. Pressure readings should be within ± 15 psig. If the two readings are not reasonably close, replace the pressure transducer.

Chilled Water Flow Switch — A factory-installed flow switch is installed in the leaving fluid piping for all units. This is a thermal-dispersion flow switch with no field adjustments. The switch is set for approximately 0.5 ft/sec of flow. The sensor tip houses two thermistors and a heater element. One thermistor is located in the sensor tip, closest to the flowing fluid. See Fig. 24. This thermistor is used to detect changes in the flow velocity of the liquid. The second thermistor is bonded to the cylindrical wall and is affected only by changes in the temperature of the liquid. The thermistors are positioned to be in close contact with the wall of the sensor probe and, at the same time, to be kept separated from each other within the confines of the probe.

In order to sense flow, it is necessary to heat one of the thermistors in the probe. When power is applied, the tip of the probe is heated. As the fluid starts to flow, heat will be carried away from the sensor tip. Cooling of the first thermistor is a function of how fast heat is conducted away by the flowing liquid.

The difference in temperature between the two thermistors provides a measurement of fluid velocity past the sensor probe. When fluid velocity is high, more heat will be carried away from the heated thermistor and the temperature differential will be small. As fluid velocity decreases, less heat will be taken from the heated thermistor and there will be an increase in temperature differential.

When unit flow rate is above the minimum flow rate, then the output is switched on, sending 24 vac to the MBB to prove flow has been established.

For recommended maintenance, check the sensor tip for build-up every 6 months. Clean the tip with a soft cloth. If necessary, build-up (e.g., lime) can be removed with a common vinegar cleansing agent.

The flow sensor cable is provided with (3) LEDs that indicate if 24 vac power is present and also status of the switch contacts. The LEDs are as follows:

- Green LED ON – 24 vac present
- One Yellow LED ON – Flow sensor switch OPEN
- Two Yellow LED ON – Flow sensor switch CLOSED

If nuisance trips of the sensor are occurring, follow the steps below to correct the situation:

1. Check to confirm that the field-installed strainer is clean. Use the blow-down valve provided or remove the screen and clean it. For the case of VFD controlled pumps, ensure that the minimum speed setting has not been changed.
2. Measure the pressure drop across the cooler and compare this to the system requirements.
3. Verify that cable connections at the switch and at the terminal block are secure.

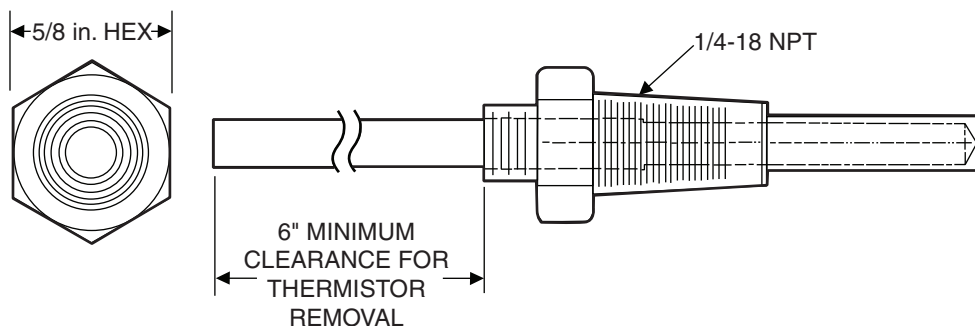
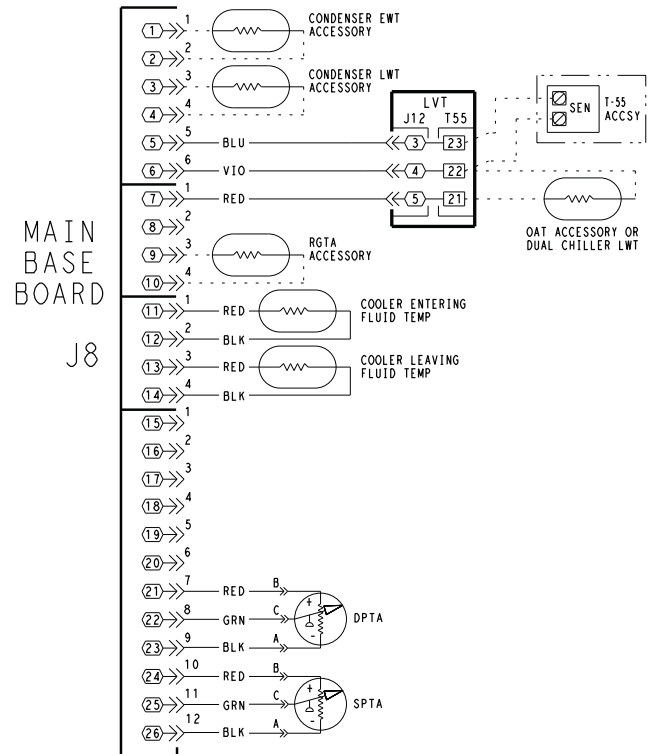

Fig. 22 — Thermistor Well

4. Wrong pump motor rotation. Pump must rotate clockwise when viewed from motor end of pump.



- LEGEND**
- ACCSY — Accessory
 - DPT — Discharge Pressure Transducer
 - EWT — Entering Water Temperature
 - LWT — Leaving Water Temperature Sensor
 - LVT — Low Voltage Terminal
 - OAT — Outdoor Air Temperature Sensor
 - RGT — Return Gas Temperature Sensor
 - SEN — Sensor Terminal Block
 - SPT — Space Temperature Sensor

Fig. 23 — Thermistor Connections to Main Base Board, J8 Connector

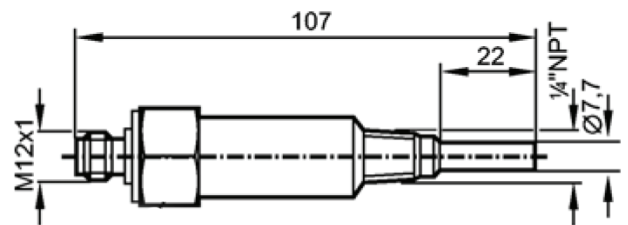

NOTE: Dimensions are in millimeters.

Fig. 24 — Chilled Water Flow Switch

**Table 32 — 5K Thermistor Temperatures (°F) vs. Resistance/Voltage Drop
(Voltage Drop for EWT, LWT, RGT, CNDE, CNDL, Dual Chiller, and OAT)**

TEMP (F)	VOLTAGE DROP (V)	RESISTANCE (Ohms)	TEMP (F)	VOLTAGE DROP (V)	RESISTANCE (Ohms)	TEMP (F)	VOLTAGE DROP (V)	RESISTANCE (Ohms)
-25	3.699	98,010	59	1.982	7,686	143	0.511	1,190
-24	3.689	94,707	60	1.956	7,665	144	0.502	1,165
-23	3.679	91,522	61	1.930	7,468	145	0.494	1,141
-22	3.668	88,449	62	1.905	7,277	146	0.485	1,118
-21	3.658	85,486	63	1.879	7,091	147	0.477	1,095
-20	3.647	82,627	64	1.854	6,911	148	0.469	1,072
-19	3.636	79,871	65	1.829	6,735	149	0.461	1,050
-18	3.624	77,212	66	1.804	6,564	150	0.453	1,029
-17	3.613	74,648	67	1.779	6,399	151	0.445	1,007
-16	3.601	72,175	68	1.754	6,238	152	0.438	986
-15	3.588	69,790	69	1.729	6,081	153	0.430	965
-14	3.576	67,490	70	1.705	5,929	154	0.423	945
-13	3.563	65,272	71	1.681	5,781	155	0.416	925
-12	3.550	63,133	72	1.656	5,637	156	0.408	906
-11	3.536	61,070	73	1.632	5,497	157	0.402	887
-10	3.523	59,081	74	1.609	5,361	158	0.395	868
-9	3.509	57,162	75	1.585	5,229	159	0.388	850
-8	3.494	55,311	76	1.562	5,101	160	0.381	832
-7	3.480	53,526	77	1.538	4,976	161	0.375	815
-6	3.465	51,804	78	1.516	4,855	162	0.369	798
-5	3.450	50,143	79	1.493	4,737	163	0.362	782
-4	3.434	48,541	80	1.470	4,622	164	0.356	765
-3	3.418	46,996	81	1.448	4,511	165	0.350	750
-2	3.402	45,505	82	1.426	4,403	166	0.344	734
-1	3.386	44,066	83	1.404	4,298	167	0.339	719
0	3.369	42,679	84	1.382	4,196	168	0.333	705
1	3.352	41,339	85	1.361	4,096	169	0.327	690
2	3.335	40,047	86	1.340	4,000	170	0.322	677
3	3.317	38,800	87	1.319	3,906	171	0.317	663
4	3.299	37,596	88	1.298	3,814	172	0.311	650
5	3.281	36,435	89	1.278	3,726	173	0.306	638
6	3.262	35,313	90	1.257	3,640	174	0.301	626
7	3.243	34,231	91	1.237	3,556	175	0.296	614
8	3.224	33,185	92	1.217	3,474	176	0.291	602
9	3.205	32,176	93	1.198	3,395	177	0.286	591
10	3.185	31,202	94	1.179	3,318	178	0.282	581
11	3.165	30,260	95	1.160	3,243	179	0.277	570
12	3.145	29,351	96	1.141	3,170	180	0.272	561
13	3.124	28,473	97	1.122	3,099	181	0.268	551
14	3.103	27,624	98	1.104	3,031	182	0.264	542
15	3.082	26,804	99	1.086	2,964	183	0.259	533
16	3.060	26,011	100	1.068	2,898	184	0.255	524
17	3.038	25,245	101	1.051	2,835	185	0.251	516
18	3.016	24,505	102	1.033	2,773	186	0.247	508
19	2.994	23,789	103	1.016	2,713	187	0.243	501
20	2.972	23,096	104	0.999	2,655	188	0.239	494
21	2.949	22,427	105	0.983	2,597	189	0.235	487
22	2.926	21,779	106	0.966	2,542	190	0.231	480
23	2.903	21,153	107	0.950	2,488	191	0.228	473
24	2.879	20,547	108	0.934	2,436	192	0.224	467
25	2.856	19,960	109	0.918	2,385	193	0.220	461
26	2.832	19,393	110	0.903	2,335	194	0.217	456
27	2.808	18,843	111	0.888	2,286	195	0.213	450
28	2.784	18,311	112	0.873	2,239	196	0.210	445
29	2.759	17,796	113	0.858	2,192	197	0.206	439
30	2.735	17,297	114	0.843	2,147	198	0.203	434
31	2.710	16,814	115	0.829	2,103	199	0.200	429
32	2.685	16,346	116	0.815	2,060	200	0.197	424
33	2.660	15,892	117	0.801	2,018	201	0.194	419
34	2.634	15,453	118	0.787	1,977	202	0.191	415
35	2.609	15,027	119	0.774	1,937	203	0.188	410
36	2.583	14,614	120	0.761	1,898	204	0.185	405
37	2.558	14,214	121	0.748	1,860	205	0.182	401
38	2.532	13,826	122	0.735	1,822	206	0.179	396
39	2.506	13,449	123	0.723	1,786	207	0.176	391
40	2.480	13,084	124	0.710	1,750	208	0.173	386
41	2.454	12,730	125	0.698	1,715	209	0.171	382
42	2.428	12,387	126	0.686	1,680	210	0.168	377
43	2.402	12,053	127	0.674	1,647	211	0.165	372
44	2.376	11,730	128	0.663	1,614	212	0.163	367
45	2.349	11,416	129	0.651	1,582	213	0.160	361
46	2.323	11,112	130	0.640	1,550	214	0.158	356
47	2.296	10,816	131	0.629	1,519	215	0.155	350
48	2.270	10,529	132	0.618	1,489	216	0.153	344
49	2.244	10,250	133	0.608	1,459	217	0.151	338
50	2.217	9,979	134	0.597	1,430	218	0.148	332
51	2.191	9,717	135	0.587	1,401	219	0.146	325
52	2.165	9,461	136	0.577	1,373	220	0.144	318
53	2.138	9,213	137	0.567	1,345	221	0.142	311
54	2.112	8,973	138	0.557	1,318	222	0.140	304
55	2.086	8,739	139	0.548	1,291	223	0.138	297
56	2.060	8,511	140	0.538	1,265	224	0.135	289
57	2.034	8,291	141	0.529	1,240	225	0.133	282
58	2.008	8,076	142	0.520	1,214			

**Table 33 — 5K Thermistor Temperatures (°C) vs. Resistance/Voltage Drop
(Voltage Drop for EWT, LWT, RGT, CNDE, CNDL, Dual Chiller, and OAT)**

TEMP (C)	VOLTAGE DROP (V)	RESISTANCE (Ohms)	TEMP (C)	VOLTAGE DROP (V)	RESISTANCE (Ohms)	TEMP (C)	VOLTAGE DROP (V)	RESISTANCE (Ohms)
-32	3.705	100,260	15	1.982	7,855	62	0.506	1,158
-31	3.687	94,165	16	1.935	7,499	63	0.490	1,118
-30	3.668	88,480	17	1.889	7,161	64	0.475	1,079
-29	3.649	83,170	18	1.844	6,840	65	0.461	1,041
-28	3.629	78,125	19	1.799	6,536	66	0.447	1,006
-27	3.608	73,580	20	1.754	6,246	67	0.433	971
-26	3.586	69,250	21	1.710	5,971	68	0.420	938
-25	3.563	65,205	22	1.666	5,710	69	0.407	906
-24	3.539	61,420	23	1.623	5,461	70	0.395	876
-23	3.514	57,875	24	1.580	5,225	71	0.383	836
-22	3.489	54,555	25	1.538	5,000	72	0.371	805
-21	3.462	51,450	26	1.497	4,786	73	0.360	775
-20	3.434	48,536	27	1.457	4,583	74	0.349	747
-19	3.406	45,807	28	1.417	4,389	75	0.339	719
-18	3.376	43,247	29	1.378	4,204	76	0.329	693
-17	3.345	40,845	30	1.340	4,028	77	0.319	669
-16	3.313	38,592	31	1.302	3,861	78	0.309	645
-15	3.281	38,476	32	1.265	3,701	79	0.300	623
-14	3.247	34,489	33	1.229	3,549	80	0.291	602
-13	3.212	32,621	34	1.194	3,404	81	0.283	583
-12	3.177	30,866	35	1.160	3,266	82	0.274	564
-11	3.140	29,216	36	1.126	3,134	83	0.266	547
-10	3.103	27,633	37	1.093	3,008	84	0.258	531
-9	3.065	26,202	38	1.061	2,888	85	0.251	516
-8	3.025	24,827	39	1.030	2,773	86	0.244	502
-7	2.985	23,532	40	0.999	2,663	87	0.237	489
-6	2.945	22,313	41	0.969	2,559	88	0.230	477
-5	2.903	21,163	42	0.940	2,459	89	0.223	466
-4	2.860	20,079	43	0.912	2,363	90	0.217	456
-3	2.817	19,058	44	0.885	2,272	91	0.211	446
-2	2.774	18,094	45	0.858	2,184	92	0.204	436
-1	2.730	17,184	46	0.832	2,101	93	0.199	427
0	2.685	16,325	47	0.807	2,021	94	0.193	419
1	2.639	15,515	48	0.782	1,944	95	0.188	410
2	2.593	14,749	49	0.758	1,871	96	0.182	402
3	2.547	14,026	50	0.735	1,801	97	0.177	393
4	2.500	13,342	51	0.713	1,734	98	0.172	385
5	2.454	12,696	52	0.691	1,670	99	0.168	376
6	2.407	12,085	53	0.669	1,609	100	0.163	367
7	2.360	11,506	54	0.649	1,550	101	0.158	357
8	2.312	10,959	55	0.629	1,493	102	0.154	346
9	2.265	10,441	56	0.610	1,439	103	0.150	335
10	2.217	9,949	57	0.591	1,387	104	0.146	324
11	2.170	9,485	58	0.573	1,337	105	0.142	312
12	2.123	9,044	59	0.555	1,290	106	0.138	299
13	2.076	8,627	60	0.538	1,244	107	0.134	285
14	2.029	8,231	61	0.522	1,200			

Table 34 — 10K Thermistor Temperature (°F) vs. Resistance/Voltage Drop (For SPT)

TEMP (F)	VOLTAGE DROP (V)	RESISTANCE (Ohms)	TEMP (F)	VOLTAGE DROP (V)	RESISTANCE (Ohms)	TEMP (F)	VOLTAGE DROP (V)	RESISTANCE (Ohms)
-25	4.758	196,453	61	2.994	14,925	147	0.890	2,166
-24	4.750	189,692	62	2.963	14,549	148	0.876	2,124
-23	4.741	183,300	63	2.932	14,180	149	0.862	2,083
-22	4.733	177,000	64	2.901	13,824	150	0.848	2,043
-21	4.724	171,079	65	2.870	13,478	151	0.835	2,003
-20	4.715	165,238	66	2.839	13,139	152	0.821	1,966
-19	4.705	159,717	67	2.808	12,814	153	0.808	1,928
-18	4.696	154,344	68	2.777	12,493	154	0.795	1,891
-17	4.686	149,194	69	2.746	12,187	155	0.782	1,855
-16	4.676	144,250	70	2.715	11,884	156	0.770	1,820
-15	4.665	139,443	71	2.684	11,593	157	0.758	1,786
-14	4.655	134,891	72	2.653	11,308	158	0.745	1,752
-13	4.644	130,402	73	2.622	11,031	159	0.733	1,719
-12	4.633	126,183	74	2.592	10,764	160	0.722	1,687
-11	4.621	122,018	75	2.561	10,501	161	0.710	1,656
-10	4.609	118,076	76	2.530	10,249	162	0.699	1,625
-9	4.597	114,236	77	2.500	10,000	163	0.687	1,594
-8	4.585	110,549	78	2.470	9,762	164	0.676	1,565
-7	4.572	107,006	79	2.439	9,526	165	0.666	1,536
-6	4.560	103,558	80	2.409	9,300	166	0.655	1,508
-5	4.546	100,287	81	2.379	9,078	167	0.645	1,480
-4	4.533	97,060	82	2.349	8,862	168	0.634	1,453
-3	4.519	94,020	83	2.319	8,653	169	0.624	1,426
-2	4.505	91,019	84	2.290	8,448	170	0.614	1,400
-1	4.490	88,171	85	2.260	8,251	171	0.604	1,375
0	4.476	85,396	86	2.231	8,056	172	0.595	1,350
1	4.461	82,729	87	2.202	7,869	173	0.585	1,326
2	4.445	80,162	88	2.173	7,685	174	0.576	1,302
3	4.429	77,662	89	2.144	7,507	175	0.567	1,278
4	4.413	75,286	90	2.115	7,333	176	0.558	1,255
5	4.397	72,940	91	2.087	7,165	177	0.549	1,233
6	4.380	70,727	92	2.059	6,999	178	0.540	1,211
7	4.363	68,542	93	2.030	6,838	179	0.532	1,190
8	4.346	66,465	94	2.003	6,683	180	0.523	1,169
9	4.328	64,439	95	1.975	6,530	181	0.515	1,148
10	4.310	62,491	96	1.948	6,383	182	0.507	1,128
11	4.292	60,612	97	1.921	6,238	183	0.499	1,108
12	4.273	58,781	98	1.894	6,098	184	0.491	1,089
13	4.254	57,039	99	1.867	5,961	185	0.483	1,070
14	4.235	55,319	100	1.841	5,827	186	0.476	1,052
15	4.215	53,693	101	1.815	5,698	187	0.468	1,033
16	4.195	52,086	102	1.789	5,571	188	0.461	1,016
17	4.174	50,557	103	1.763	5,449	189	0.454	998
18	4.153	49,065	104	1.738	5,327	190	0.447	981
19	4.132	47,627	105	1.713	5,210	191	0.440	964
20	4.111	46,240	106	1.688	5,095	192	0.433	947
21	4.089	44,888	107	1.663	4,984	193	0.426	931
22	4.067	43,598	108	1.639	4,876	194	0.419	915
23	4.044	42,324	109	1.615	4,769	195	0.413	900
24	4.021	41,118	110	1.591	4,666	196	0.407	885
25	3.998	39,926	111	1.567	4,564	197	0.400	870
26	3.975	38,790	112	1.544	4,467	198	0.394	855
27	3.951	37,681	113	1.521	4,370	199	0.388	841
28	3.927	36,610	114	1.498	4,277	200	0.382	827
29	3.903	35,577	115	1.475	4,185	201	0.376	814
30	3.878	34,569	116	1.453	4,096	202	0.370	800
31	3.853	33,606	117	1.431	4,008	203	0.365	787
32	3.828	32,654	118	1.409	3,923	204	0.359	774
33	3.802	31,752	119	1.387	3,840	205	0.354	762
34	3.776	30,860	120	1.366	3,759	206	0.349	749
35	3.750	30,009	121	1.345	3,681	207	0.343	737
36	3.723	29,177	122	1.324	3,603	208	0.338	725
37	3.697	28,373	123	1.304	3,529	209	0.333	714
38	3.670	27,597	124	1.284	3,455	210	0.328	702
39	3.654	26,838	125	1.264	3,383	211	0.323	691
40	3.615	26,113	126	1.244	3,313	212	0.318	680
41	3.587	25,396	127	1.225	3,244	213	0.314	670
42	3.559	24,715	128	1.206	3,178	214	0.309	659
43	3.531	24,042	129	1.187	3,112	215	0.305	649
44	3.503	23,399	130	1.168	3,049	216	0.300	639
45	3.474	22,770	131	1.150	2,986	217	0.296	629
46	3.445	22,161	132	1.132	2,926	218	0.292	620
47	3.416	21,573	133	1.114	2,866	219	0.288	610
48	3.387	20,998	134	1.096	2,809	220	0.284	601
49	3.357	20,447	135	1.079	2,752	221	0.279	592
50	3.328	19,903	136	1.062	2,697	222	0.275	583
51	3.298	19,386	137	1.045	2,643	223	0.272	574
52	3.268	18,874	138	1.028	2,590	224	0.268	566
53	3.238	18,384	139	1.012	2,539	225	0.264	557
54	3.208	17,904	140	0.996	2,488			
55	3.178	17,441	141	0.980	2,439			
56	3.147	16,991	142	0.965	2,391			
57	3.117	16,552	143	0.949	2,343			
58	3.086	16,131	144	0.934	2,297			
59	3.056	15,714	145	0.919	2,253			
60	3.025	15,317	146	0.905	2,209			

Table 35 — 10K Thermistor Temperature (°C) vs. Resistance/Voltage Drop (For SPT)

TEMP (C)	VOLTAGE DROP (V)	RESISTANCE (Ohms)	TEMP (C)	VOLTAGE DROP (V)	RESISTANCE (Ohms)	TEMP (C)	VOLTAGE DROP (V)	RESISTANCE (Ohms)
-32	4.762	200,510	15	3.056	15,714	62	0.940	2,315
-31	4.748	188,340	16	3.000	15,000	63	0.913	2,235
-30	4.733	177,000	17	2.944	14,323	64	0.887	2,157
-29	4.716	166,342	18	2.889	13,681	65	0.862	2,083
-28	4.700	156,404	19	2.833	13,071	66	0.837	2,011
-27	4.682	147,134	20	2.777	12,493	67	0.813	1,943
-26	4.663	138,482	21	2.721	11,942	68	0.790	1,876
-25	4.644	130,402	22	2.666	11,418	69	0.767	1,813
-24	4.624	122,807	23	2.610	10,921	70	0.745	1,752
-23	4.602	115,710	24	2.555	10,449	71	0.724	1,693
-22	4.580	109,075	25	2.500	10,000	72	0.703	1,637
-21	4.557	102,868	26	2.445	9,571	73	0.683	1,582
-20	4.533	97,060	27	2.391	9,164	74	0.663	1,530
-19	4.508	91,588	28	2.337	8,776	75	0.645	1,480
-18	4.482	86,463	29	2.284	8,407	76	0.626	1,431
-17	4.455	81,662	30	2.231	8,056	77	0.608	1,385
-16	4.426	77,162	31	2.178	7,720	78	0.591	1,340
-15	4.397	72,940	32	2.127	7,401	79	0.574	1,297
-14	4.367	68,957	33	2.075	7,096	80	0.558	1,255
-13	4.335	65,219	34	2.025	6,806	81	0.542	1,215
-12	4.303	61,711	35	1.975	6,530	82	0.527	1,177
-11	4.269	58,415	36	1.926	6,266	83	0.512	1,140
-10	4.235	55,319	37	1.878	6,014	84	0.497	1,104
-9	4.199	52,392	38	1.830	5,774	85	0.483	1,070
-8	4.162	49,640	39	1.784	5,546	86	0.470	1,037
-7	4.124	47,052	40	1.738	5,327	87	0.457	1,005
-6	4.085	44,617	41	1.692	5,117	88	0.444	974
-5	4.044	42,324	42	1.648	4,918	89	0.431	944
-4	4.003	40,153	43	1.605	4,727	90	0.419	915
-3	3.961	38,109	44	1.562	4,544	91	0.408	889
-2	3.917	36,182	45	1.521	4,370	92	0.396	861
-1	3.873	34,367	46	1.480	4,203	93	0.386	836
0	3.828	32,654	47	1.439	4,042	94	0.375	811
1	3.781	31,030	48	1.400	3,889	95	0.365	787
2	3.734	29,498	49	1.362	3,743	96	0.355	764
3	3.686	28,052	50	1.324	3,603	97	0.345	742
4	3.637	26,686	51	1.288	3,469	98	0.336	721
5	3.587	25,396	52	1.252	3,340	99	0.327	700
6	3.537	24,171	53	1.217	3,217	100	0.318	680
7	3.485	23,013	54	1.183	3,099	101	0.310	661
8	3.433	21,918	55	1.150	2,986	102	0.302	643
9	3.381	20,883	56	1.117	2,878	103	0.294	626
10	3.328	19,903	57	1.086	2,774	104	0.287	609
11	3.274	18,972	58	1.055	2,675	105	0.279	592
12	3.220	18,090	59	1.025	2,579	106	0.272	576
13	3.165	17,255	60	0.996	2,488	107	0.265	561
14	3.111	16,464	61	0.968	2,400			

Strainer — Periodic cleaning of the required field-installed strainer is required. Pressure drop across strainer in excess of 3 psi (21 kPa) indicates the need for cleaning. Normal (clean) pressure drop is approximately 1 psi (6.9 kPa). Open the blowdown valve to clean the strainer. If required, shut the chiller down and remove the strainer screen to clean. When strainer has been cleaned, enter ‘YES’ for Strainer Maintenance Done (*Run Status* → *PM* → *S.T.M.N.*)

Replacing Defective Modules — The *Comfort-Link™* replacement modules are shown in Table 36. If the main base board (MBB) has been replaced, verify that all configuration data is correct. Follow the *Configuration* mode table and verify that all items under sub-modes *UNIT*, *OPT1* and *OPT2* are correct. Any additional field-installed accessories or options (*RSET*, *SLCT* sub-modes) should also be verified as well as any specific time and maintenance schedules.

Refer to the Start-Up Checklist for 30MP Liquid Chillers (completed at time of original start-up) found in the job folder. This information is needed later in this procedure. If the checklist does not exist, fill out the current information in the Configuration mode on a new checklist. Tailor the various options and configurations as needed for this particular installation.

⚠ WARNING

Electrical shock can cause personal injury and death. Shut off all power to this equipment during installation. There may be more than one disconnect switch. Tag all disconnect locations to alert others not to restore power until work is completed.

1. Check that all power to unit is off. Carefully disconnect all wires from the defective module by unplugging its connectors.
2. Remove the defective module by removing its mounting screws with a Phillips screwdriver, and removing the module from the control box. Save the screws later use.
3. Verify that the instance jumper (MBB) or address switches (all other modules) exactly match the settings of the defective module.

NOTE: Handle boards by mounting standoffs only to avoid electrostatic discharge.

4. Package the defective module in the carton of the new module for return to Carrier.
5. Mount the new module in the unit’s control box using a Phillips screwdriver and the screws saved in Step 2.

6. Reinstall all module connectors. For accessory Navigator™ device replacement, make sure the plug is installed at TB3 in the LEN connector.
7. Carefully check all wiring connections before restoring power.
8. Verify the ENABLE/OFF/REMOTE CONTACT switch is in the OFF position.
9. Restore control power. Verify that all module red LEDs blink in unison. Verify that all green LEDs are blinking and that the scrolling marquee or Navigator™ display is communicating correctly.
10. Verify all configuration information, settings, set points and schedules. Return the ENABLE/OFF/REMOTE CONTACT switch to its previous position.

Table 36 — Replacement Modules

MODULE	REPLACEMENT PART NO. (with Software)
Main Base Board (MBB)	30MP500346
Scrolling Marquee Display	HK50AA031
Energy Management Module (EMM)	30GT515218
Navigator Display	HK50AA033

MAINTENANCE

Recommended Maintenance Schedule — The following are only recommended guidelines. Jobsite conditions may dictate that maintenance schedule is performed more often than recommended.

Routine:

Every month:

- Check moisture indicating sight glass for possible refrigerant loss and presence of moisture.

Every 3 months (for all machines):

- Check refrigerant charge.
- Check all refrigerant joints and valves for refrigerant leaks, repair as necessary.
- Check chilled water flow switch operation.
- Check compressor oil level.

Every 12 months (for all machines):

- Check all electrical connections, tighten as necessary.
- Inspect all contactors and relays, replace as necessary.
- Check accuracy of thermistors, replace if greater than $\pm 2^\circ\text{F}$ (1.2°C) variance from calibrated thermometer.
- Check to be sure that the proper concentration of anti-freeze is present in the chilled water loop, if applicable.
- Verify that the chilled water loop is properly treated.
- Check refrigerant filter driers for excessive pressure drop, replace as necessary.
- Check chilled water and condenser strainers, clean as necessary.
- Perform Service Test to confirm operation of all components.
- Check for excessive cooler approach (Leaving Chilled Water Temperature — Saturated Suction Temperature) which may indicate fouling. Clean evaporator if necessary.

TROUBLESHOOTING

Complete Unit Stoppage and Restart — Possible causes for unit stoppage and reset methods are shown below and in Table 37. Refer to Fig. 3-7 for component arrangement and control wiring diagrams.

GENERAL POWER FAILURE — After power is restored, restart is automatic through normal MBB start-up.

UNIT ENABLE-OFF-REMOTE CONTACT SWITCH IS OFF — When the switch is OFF, the unit will stop immediately. Place the switch in the ENABLE position for local switch control or in the REMOTE CONTACT position for control through remote contact closure.

CHILLED FLUID PROOF-OF-FLOW SWITCH OPEN — After the problem causing the loss of flow has been corrected, reset is manual by resetting the alarm with the scrolling marquee.

OPEN 24-V CONTROL CIRCUIT BREAKER(S) — Determine the cause of the failure and correct. Reset circuit breaker(s). Restart is automatic after MBB start-up cycle is complete.

COOLING LOAD SATISFIED — Unit shuts down when cooling load has been satisfied. Unit restarts when required to satisfy leaving fluid temperature set point.

THERMISTOR FAILURE — If a thermistor fails in either an open or shorted condition, the unit will be shut down. Replace EWT, or LWT as required. Unit restarts automatically, but must be reset manually by resetting the alarm with the scrolling marquee.

⚠ CAUTION

If unit stoppage occurs more than once as a result of any of the safety devices listed, determine and correct cause before attempting another restart.

LOW SATURATED SUCTION — Several conditions can lead to low saturated suction alarms and the chiller controls have several override modes built in which will attempt to keep the chiller from shutting down. Low fluid flow, low refrigerant charge and plugged filter driers are the main causes for this condition. To avoid permanent damage and potential freezing of the system, do NOT repeatedly reset these alert and/or alarm conditions without identifying and correcting the cause(s).

COMPRESSOR SAFETIES — The 30MP units with *ComfortLink™* controls include a compressor protection board that protects the operation of each of the compressors. Each board senses the presence or absence of current to each compressor.

If there is a command for a compressor to run and there is no current, then one of the following safeties or conditions have turned the compressor off:

Compressor Overcurrent — All compressors have internal line breaks or a motor protection device located in the compressor electrical box.

Compressor Short Circuit — There will not be current if the compressor circuit breaker that provides short circuit protection has tripped.

Compressor Motor Over Temperature — The internal line-break or over temperature switch has opened.

High-Pressure Switch Trip — The high pressure switch has opened. See Table 31 for the factory settings for the fixed high pressure switch.

ASTP Protection Trip — All non-digital Copeland compressors are equipped with an advanced scroll temperature protection (ASTP). A label located above the terminal box identifies models that contain this technology. See Fig. 25.

Advanced scroll temperature protection is a form of internal discharge temperature protection that unloads the scroll compressor when the internal temperature reaches approximately 300 F. At this temperature, an internal bi-metal disk valve opens and causes the scroll elements to separate, which stops compression. Suction and discharge pressures balance while the motor continues to run. The longer the compressor runs unloaded, the longer it must cool before the bi-metal disk resets. See Fig. 26 for approximate reset times.



Fig. 25 — Advanced Scroll Temperature Protection Label

To manually reset ASTP, the compressor should be stopped and allowed to cool. If the compressor is not stopped, the motor will run until the motor protector trips, which occurs up to 90 minutes later. Advanced scroll temperature protection will reset automatically before the motor protector resets, which may take up to 2 hours.

High Discharge Gas Temperature Protection — Units equipped with optional digital compressors have an additional thermistor located on the discharge line. If discharge temperature exceeds 265 F (129.4 C), the digital compressor will be shut off.

Alarms will also occur if the current sensor board malfunctions or is not properly connected to its assigned digital input. If

the compressor is commanded OFF and the current sensor reads ON, an alert is generated. This will indicate that a compressor contactor has failed closed. In this case, a special mode, Compressor Stuck on Control, will be enabled and all other compressors will be turned off. An alarm will then be enabled to indicate that service is required. Outdoor fans will continue to operate. The condenser output is turned on immediately.

Alarms and Alerts — These are warnings of abnormal or fault conditions, and may cause either one circuit or the whole unit to shut down. They are assigned code numbers as described in Table 38.

Automatic alarms will reset without operator intervention if the condition corrects itself. The following method must be used to reset manual alarms:

Before resetting any alarm, first determine the cause of the alarm and correct it. Enter the Alarms mode indicated by the LED on the side of the scrolling marquee display. Press **ENTER** and **▼** until the sub-menu item RCRN “RESET ALL CURRENT ALARMS” is displayed. Press **ENTER**. The control will prompt the user for a password, by displaying PASS and WORD. Press **ENTER** to display the default password, 1111. Press **ENTER** for each character. If the password has been changed, use the arrow keys to change each individual character. Toggle the display to “YES” and press **ENTER**. The alarms will be reset.

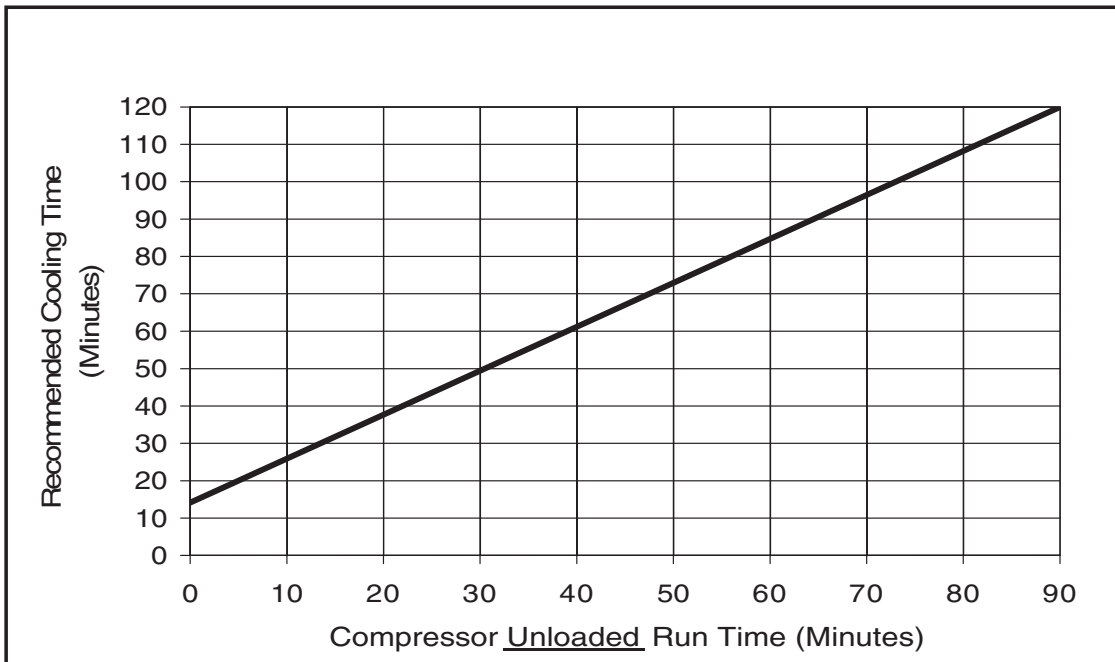

*Times are approximate.
NOTE: Various factors, including high humidity, high ambient temperature, and the presence of a sound blanket will increase cool-down times.

Fig. 26 — Recommended Minimum Cool Down Time After Compressor is Stopped*

Table 37 — Troubleshooting

SYMPTOMS	CAUSE	REMEDY
Compressor Cycles Off on Loss of Charge	Loss of charge control. Acting erratically.	Repair leak and recharge. Replace control.
	Low refrigerant charge	Add refrigerant.
	Low suction temperature	Raise cooler leaving fluid temperature set point.
Compressor Cycles Off on Out of Range Condition	Thermistor failure	Replace thermistor.
	System load was reduced faster than controller could remove stages	Unit will restart after fluid temperature rises back into the control band. Avoid rapidly removing system load or increase loop volume.
	Temperature controller deadband setting is too low	Raise deadband setting.
Compressor Shuts Down on High-Pressure Control	High-pressure control acting erratically	Replace control.
	Noncondensables in system	Purge system.
	Condenser scaled/dirty	Clean condenser.
	Fans in remote condensing unit (30MPA only) not operating	Repair or replace if defective.
	System overcharged with refrigerant	Reduce charge.
Unit Operates Too Long or Continuously	Low refrigerant charge	Add refrigerant.
	Control contacts fused	Replace control.
	Air in system	Purge system.
	Partially plugged or plugged expansion valve or filter drier	Clean or replace as needed.
	Defective insulation	Replace or repair as needed.
	Service load	Keep doors and windows closed.
	Damaged compressor	Check compressor and replace if necessary.
Unusual or Loud System Noises	Piping vibration	Support piping as required. Check for loose pipe connections or damaged compressor
	Expansion valve hissing	Add refrigerant. Check for plugged liquid line filter drier.
	Compressor noisy	Replace compressor (worn bearings). Check for loose compressor holddown bolts.
	Leak in system	Repair leak.
	Mechanical damage (Failed seals or broken scrolls)	Replace compressor.
Compressor Loses Oil	Oil trapped in line	Check piping for oil traps.
	Shortage of refrigerant due to leak	Repair leak and recharge.
Hot Liquid Line	Restricted filter drier	Replace filter drier.
Frosted Liquid Line	Expansion valve admitting excess refrigerant (note: this is a normal condition for brine applications)	Replace valve if defective.
	Stuck TXV	Replace valve if defective.
Frosted Suction Line	Improper charging	Make sure a full quantity of fluid is flowing through the cooler while charging, and suction pressure in cooler is equal to or greater than pressure corresponding to 32 F (0° C).
	System not drained for winter shutdown	<i>Recommended that system be filled with an appropriate glycol mixture to prevent freezing of pumps and fluid tubing.</i>
	Loose Thermistor	Verify thermistors are fully inserted in wells.

Table 38 — Alarm and Alert Codes

ALARM/ ALERT CODE	ALARM OR ALERT	DESCRIPTION	WHY WAS THIS ALARM GENERATED?	ACTION TAKEN BY CONTROL	RESET METHOD	PROBABLE CAUSE
A048	Alarm	Circuit A Compressor Availability Alarm	Two compressors on circuit failed	Circuit shut down	Manual	Only one compressor operating.
T051	Alert	Circuit A, Compressor 1 Failure	Compressor feedback signal does not match relay state	Compressor A1 shut down.	Manual	High-pressure switch open, faulty CSB, loss of condenser flow, filter drier plugged, non-condensables, operation beyond capability.
A051	Alarm	Circuit A, Compressor 1 Failure	Respective current sensor board (CSB) feedback signal is ON when the compressor should be off	Unit shut down	Manual	High-pressure switch open, faulty CSB, loss of condenser flow, filter drier plugged, non-condensables, operation beyond capability.
T052	Alert	Circuit A, Compressor 2 Failure	Compressor feedback signal does not match relay state	Compressor A2 shut down.	Manual	High-pressure switch open, faulty CSB, loss of condenser flow, filter drier plugged, non-condensables, operation beyond capability.
A052	Alarm	Circuit A, Compressor 2 Failure	Respective current sensor board (CSB) feedback signal is ON when the compressor should be off	Unit shut down	Manual	High-pressure switch open, faulty CSB, loss of condenser flow, filter drier plugged, non-condensables, operation beyond capability.
T053	Alert	Circuit A, Compressor 3 Failure	Compressor feedback signal does not match relay state	Compressor A3 shut down.	Manual	High-pressure switch open, faulty CSB, loss of condenser flow, filter drier plugged, non-condensables, operation beyond capability.
A053	Alarm	Circuit A, Compressor 3 Failure	Respective current sensor board (CSB) feedback signal is ON when the compressor should be off	Unit shut down	Manual	High-pressure switch open, faulty CSB, loss of condenser flow, filter drier plugged, non-condensables, operation beyond capability.
A060	Alarm	Cooler Leaving Fluid Thermistor Failure	Thermistor outside range of -40 to 245 F (-40 to 118 C)	Chiller shut down immediately	Automatic	Thermistor failure, damaged cable/wire or wiring error.
A061	Alarm	Cooler Entering Fluid Thermistor Failure	Thermistor outside range of -40 to 245 F (-40 to 118 C)	Chiller shut down immediately	Automatic	Thermistor failure, damaged cable/wire or wiring error.
T062	Alert	Condenser Leaving Fluid Thermistor Failure	Thermistor outside range of -40 to 245 F (-40 to 118 C)	Alert only. No action taken.	Automatic	Thermistor failure, damaged cable/wire or wiring error.
T063	Alert	Condenser Entering Fluid Thermistor Failure	Thermistor outside range of -40 to 245 F (-40 to 118 C)	Alert only. No action taken.	Automatic	Thermistor failure, damaged cable/wire or wiring error.
T068	None	Circuit A Return Gas Thermistor Failure	If return gas sensors are enabled (RG.EN) and thermistor is outside range of -40 to 245 F (-40 to 118 C)	Circuit A shut down	Automatic	Thermistor failure, damaged cable/wire or wiring error.
T073	Alert	Outside Air Thermistor Failure	Thermistor outside range of -40 to 245 F (-40 to 118 C) (if enabled)	Temperature reset disabled. Chiller runs under normal control/set points.	Automatic	Thermistor failure, damaged cable/wire or wiring error.
T074	Alert	Space Temperature/Dual Chiller Thermistor Failure	Thermistor outside range of -40 to 245 F (-40 to 118 C) (if enabled)	Temperature reset disabled. Chiller runs under normal control/set points.	Automatic	Thermistor failure, damaged cable/wire or wiring error.
A077	Alarm	Circuit A Saturated Suction Temperature exceeds Cooler Leaving Fluid Temperature	Faulty expansion valve, suction pressure transducer or leaving fluid thermistor.	Circuit A shutdown after pumpdown complete.	Manual	Faulty expansion valve or suction pressure transducer or leaving fluid thermistor.
T079	Alert	Lead/Lag LWT Thermistor Failure	Thermistor outside range of -40 to 245 F (-40 to 118 C)	Chiller runs as a stand alone machine	Automatic	Dual LWT thermistor failure, damaged cable/wire or wiring error.
A090	Alarm	Circuit A Discharge Pressure Transducer Failure	Outside of range (0 - 667 psig)	Circuit A shut down	Automatic	Transducer failure, poor connection to MBB, or wiring damage/error.
A092	Alarm	Circuit A Suction Pressure Transducer Failure	Outside of range (0 - 420 psig)	Circuit A shut down	Automatic	Transducer failure, poor connection to MBB, or wiring damage/error.
T094	Alert	Discharge Gas Thermistor Failure	Discharge thermistor (DTT) is either open or shorted	Digital compressor shut down.	Automatic	Thermistor failure, damaged cable/wire or wiring error.
A110	Alarm	Circuit A Loss of Charge	If the compressors are off and discharge pressure reading is < 26 psig for 30 sec.	Circuit not allowed to start.	Manual	Refrigerant leak or transducer failure
A112	Alarm	Circuit A High Saturated Suction Temperature	Circuit saturated suction temperature pressure transducer > 70 F (21.1 C) for 5 minutes	Circuit shut down	Manual	Faulty Expansion valve, faulty suction pressure transducer or high entering fluid temperature.
A114	Alarm	Circuit A Low Suction Superheat	Suction superheat is less than 5° F (2.8 C) for 5 minutes. (if RGT installed)	Circuit A shut down.	Automatic restart after first daily occurrence. Manual restart thereafter.	Faulty expansion valve, faulty suction pressure transducer, faulty suction gas thermistor, circuit overcharged

Table 38 — Alarm and Alert Codes (cont)

ALARM/ ALERT CODE	ALARM OR ALERT	DESCRIPTION	WHY WAS THIS ALARM GENERATED?	ACTION TAKEN BY CONTROL	RESET METHOD	PROBABLE CAUSE
A116	Alarm	Circuit A Low Cooler Suction Temperature	Mode 7 caused the compressor to unload 6 consecutive times with less than a 30-minute interval between each circuit shutdown.	Circuit shut down	Manual	Faulty expansion valve, low refrigerant charge, plugged filter drier, faulty suction pressure transducer, low cooler fluid flow
A122	Alarm	High Pressure Switch Trip Circuit A	High Pressure A Switch Input open to MBB	Circuit shut down	Manual	Faulty transducer/high pressure switch.
A126	Alarm	Circuit A High Discharge Pressure	SCT >Maximum condensing temperature from operating envelope	Circuit shut down	Automatic, only after first 3 daily occurrences. Manual reset thereafter. Reading from OAT sensor must drop 5 F (2.8 C) before restart	Faulty transducer/high pressure switch, low/restricted condenser airflow
T133	Alert	Circuit A Low Suction Pressure	Suction pressure below 34 psig for 8 seconds or below 23 psig	Circuit shut down	Automatic restart after first daily occurrence. Manual restart thereafter.	Faulty or plugged EXV, low refrigerant charge, EXV out of adjustment, liquid line valve partially closed
A140	Alert	Reverse Rotation Detected	Incoming chiller power leads not phased correctly	Chiller not allowed to start.	Manual	Reverse any two incoming power leads to correct. Check for correct fan rotation first.
A150	Alarm	Emergency Stop	CCN emergency stop command received	Chiller shutdown without going through pumpdown.	Automatic once CCN command for EMSTOP returns to normal	CCN Network command.
A151	Alarm	Illegal Configuration	One or more illegal configurations exists.	Chiller is not allowed to start.	Manual once configuration errors are corrected	Configuration error. Check unit settings.
A152	Alarm	Unit Down Due to Failure	Both circuits are down due to alarms/alerts.	Chiller is unable to run.	Automatic once alarms/alerts are cleared that prevent the chiller from starting.	Alarm notifies user that chiller is 100% down.
T153	Alert	Real Time Clock Hardware Failure	Internal clock on MBB fails	Occupancy schedule will not be used. Chiller defaults to Local On mode.	Automatic when correct clock control restarts.	Time/Date/Month/Day/Year not properly set.
A154	Alarm	Serial EEPROM Hardware Failure	Hardware failure with MBB	Chiller is unable to run.	Manual	Main Base Board failure.
T155	Alert	Serial EEPROM Storage Failure	Configuration/storage failure with MBB	No Action	Manual	Potential failure of MBB. Download current operating software. Replace MBB if error occurs again.
A156	Alarm	Critical Serial EEPROM Storage Failure	Configuration/storage failure with MBB	Chiller is not allowed to run.	Manual	Main Base Board failure.
A157	Alarm	A/D Hardware Failure	Hardware failure with peripheral device	Chiller is not allowed to run.	Manual	Main Base Board failure.
T173	Alert	Loss of Communication with EMM	MBB loses communication with EMM	4 to 20 mA temperature reset disabled. Demand Limit set to 100%. 4 to 20 mA set point disabled.	Automatic	Wiring error, faulty wiring or failed Energy Management Module (EMM).
T174	Alert	4 to 20 mA Cooling Set Point Input Failure	If configured with EMM and input less than 2 mA or greater than 22 mA	Set point function disabled. Chiller controls to CSP1.	Automatic	Faulty signal generator, wiring error, or faulty EMM.
T176	Alert	4 to 20 mA Temperature Reset Input Failure	If configured with EMM and input less than 2 mA or greater than 22 mA	Reset function disabled. Chiller returns to normal set point control.	Automatic	Faulty signal generator, wiring error, or faulty EMM.
T177	Alert	4 to 20 mA Demand Limit Input Failure	If configured with EMM and input less than 2 mA or greater than 22 mA	Demand limit function disabled. Chiller returns to 100% demand limit control.	Automatic	Faulty signal generator, wiring error, or faulty EMM.

See legend on page 51.

Table 38 — Alarm and Alert Codes (cont)

ALARM/ ALERT CODE	ALARM OR ALERT	DESCRIPTION	WHY WAS THIS ALARM GENERATED?	ACTION TAKEN BY CONTROL	RESET METHOD	PROBABLE CAUSE
T200	Alert	Cooler Flow/Interlock Contacts failed to Close at start-up	Cooler flow switch contacts failed to close within 1 minute (if cooler pump control is enabled) or within 5 minutes (if cooler pump control is not enabled) after start-up	Chiller not allowed to start. For models with dual pumps, the second pump will be started if available	Manual	Faulty flow switch or interlock.
A201	Alarm	Cooler Flow/Interlock Contacts Opened During Normal Operation	Flow switch opens for at least 3 seconds after being initially closed	All compressors shut down. For models with dual pumps, the second pump will be started if available	Manual	Cooler pump failure, faulty flow switch or interlock.
A202	Alarm	Cooler Pump Interlock Closed When Pump is Off	If configured for cooler pump control and flow switch input is closed for 5 minutes while pump output(s) are off	Chiller shut down	Automatic when aux contacts open	Wiring error, faulty pump contactor (welded contacts)
T203	Alert	Loss of Communication with slave chiller	Master chiller MBB loses communication with slave chiller MBB	Dual chiller control disabled. Chiller runs as a stand-alone machine.	Automatic	Wiring error, faulty wiring, failed Slave chiller MBB module, power loss at slave chiller, wrong slave address.
T204	Alert	Loss of Communication with master chiller	Slave chiller MBB loses communication with master chiller MBB	Dual chiller control disabled. Chiller runs as a stand-alone machine	Automatic	Wiring error, faulty wiring, failed master chiller MBB module, power loss at Master chiller.
T205	Alert	Master and slave chiller with same address	Master and slave chiller have the same CCN address (CCN.A)	Dual chiller routine disabled. Master/slave run as stand-alone chillers.	Automatic	CCN Address for both chillers is the same. Must be different. Check CCN.A under the OPT2 sub-mode in Configuration at both chillers.
T206	Alert	High Leaving Chilled Water Temperature	LWT read is greater than LCW Alert Limit, Total capacity is 100% and LWT is greater than LWT reading one minute ago	Alert only. No action taken.	Automatic	Building load greater than unit capacity, low water/brine flow or compressor fault. Check for other alarms/alerts.
A207	Alarm	Cooler Freeze Protection	Cooler EWT or LWT is less than Brine Freeze (BR.FZ)	Chiller shutdown without going through pumpdown. Cooler pump continues to run a minimum of 5 minutes (if control enabled).	Both EWT and LWT must be at least 6 F (3.3 C) above Brine Freeze point (BR.FZ). Automatic for first, Manual reset there after.	Faulty thermistor (T1/T2), low water flow.
A208	Alarm	EWT or LWT Thermistor failure	Cooler EWT is less than LWT by 3° F (1.7° C) for 1 minute after a circuit is started	Chiller shutdown. Cooler pump shut off (if control enabled).	Manual	Faulty cooler pump, low water flow, plugged fluid strainer.
A220	Alarm	Condenser Pump Interlock Failure to Close at Start-Up	If configured for condenser pump interlock and the flow switch input fails to close within 5 minutes after start-up. Also valid when configured for condenser pump control.	Condenser and cooler pumps shut off. Chiller shutdown without going through pumpdown.	Manual	Failure of condenser pump or controls. Wiring error.
A221	Alarm	Condenser Pump Interlock Opened During Normal Operation	If configured for condenser pump interlock and the flow switch opens for 15 seconds during normal operation (or when the condenser pump relay is on when condenser pump control is configured.)	Condenser and cooler pumps shut off. Chiller shutdown without going through pump-down.	Manual	Failure of condenser pump or controls. Wiring error.
A222	Alarm	Condenser Pump Interlock Closed When Pump is Off	If configured for condenser pump interlock condenser pump control, and the flow switch is closed when pump relay is off.	Chiller is not allowed to start.	Manual	Failure of condenser pump relays or interlocks, welded contacts.

Table 38 — Alarm and Alert Codes (cont)

ALARM/ALERT CODE	ALARM OR ALERT	DESCRIPTION	WHY WAS THIS ALARM GENERATED?	ACTION TAKEN BY CONTROL	RESET METHOD	PROBABLE CAUSE
T302	Alert	Strainer Blowdown Scheduled Maintenance Due	Strainer Service Countdown (S.T.DN) expired. Complete strainer blowdown and enter 'YES' for Strainer Maintenance Done (S.T.MN) item.	None	Automatic	Routine strainer maintenance required
T500	Alert	Current Sensor Board A1 Failure	Alert occurs when CSB output is a constant high value	Compressor A1 shut down	Automatic	CSB failure.
T501	Alert	Current Sensor Board A2 Failure	Alert occurs when CSB output is a constant high value	Compressor A2 shut down	Automatic	CSB failure.
T502	Alert	Current Sensor Board A3 Failure	Alert occurs when CSB output is a constant high value	Compressor A3 shut down	Automatic	CSB failure.
T950	Alert	Loss of Communication with Water System Manager	No communications have been received by the MBB within 5 minutes of last transmission	WSM forces removed. Chiller runs under own control	Automatic	Failed module, wiring error, failed transformer, loose connection plug, wrong address
T951	Alert	Loss of Communication with Chillervisor System Manager	No communications have been received by the MBB within 5 minutes of last transmission	CSM forces removed. Chiller runs under own control	Automatic	Failed module, wiring error, failed transformer, loose connection plug, wrong address

LEGEND

- CCN — Carrier Comfort Network
- CSB — Current Sensor Board
- CSM — Chiller System Manager
- CXB — Compressor Expansion Board
- EEPROM — Electronic Erasable Programmable Read Only Memory
- EMM — Energy Management Module
- EWT — Entering Fluid Temperature
- EXV — Electronic Expansion Valve
- HSM — Hydronic System Manager
- LCW — Leaving Chilled Water
- LWT — Leaving Fluid Temperature
- MBB — Main Base Board
- OAT — Outdoor-Air Temperature
- RG T — Return Gas Thermistor
- WSM — Water System Manager

COMPRESSOR FAILURE ALERTS

A048 (Circuit A Compressor Availability Alarm) — This alarm occurs when two compressors are unavailable to run on a 3 compressor circuit. The control ensures proper oil return by ensuring a circuit does not operate with one compressor for longer than one hour of cumulative run time.

T051, T052, T053 (Circuit A Compressor Failures) — Alert codes 051, 052, and 053 are for compressors A1, A2, and A3 respectively. These alerts occur when the current sensor (CS) does not detect compressor current during compressor operation. When this occurs, the control turns off the compressor.

If the current sensor board reads OFF while the compressor relay has been commanded ON, an alert is generated.

POSSIBLE CAUSES

Compressor Overload — Either the compressor internal overload protector is open or the external overload protector (Kriwan module) has activated. The external overload protector modules are mounted in the compressor wiring junction box. Temperature sensors embedded in the compressor motor windings are the inputs to the module. The module is powered with 24 vac from the units main control box. The module output is a normally closed contact that is wired in series with the compressor contactor coil. In a compressor motor overload condition, contact opens, deenergizing the compressor contactor.

Low Refrigerant Charge — If the compressor operates for an extended period of time with low refrigerant charge, the compressor ASTP device will open, which will cause the compressor to trip on its overload protection device.

Circuit Breaker Trip — The compressors are protected from short circuit by a breaker in the control box.

Wiring Error — A wiring error might not allow the compressor to start.

To check out alerts T051-T053:

1. Turn on the compressor in question using Service Test mode. If the compressor does not start, then most likely the problem is one of the following: HPS open, open internal protection, circuit breaker trip, incorrect safety wiring, or incorrect compressor wiring.
2. If the compressor does start, verify it is rotating in the correct direction.

IMPORTANT: Prolonged operation in the wrong direction can damage the compressor. Correct rotation can be verified by a gage set and looking for a differential pressure rise on start-up.

IMPORTANT: If the CS is always detecting current, verify that the compressor is on. If the compressor is on, check the contactor and the relay on the MBB. If the compressor is off and there is no current, verify the CSB wiring and replace if necessary.

IMPORTANT: Return to Normal mode and observe compressor operation to verify that compressor current sensor is working.

COMPRESSOR STUCK ON FAILURE ALARMS

Circuit A A051, A052, A053 — Alarm codes 051, 052, and 053 are for compressors A1, A2, and A3. These alarms occur when the CSB detects current when the compressor should be off. When this occurs, the control turns off the compressor.

If the current sensor board reads ON while the compressor relay has been commanded OFF for a period of 4 continuous seconds, an alarm is generated. These alarms are only monitored for a period of 10 seconds after the compressor relay has

been commanded OFF. This is done to facilitate a service technician forcing a relay to test a compressor.

In addition, if a compressor stuck failure occurs and the current sensor board reports the compressor and the request off, certain diagnostics will take place as follows:

1. If any of the compressors are diagnosed as stuck on and the current sensor board is on and the request is off, the control will command the condenser fans to maintain normal head pressure.
2. The control will shut-off all other compressors.

The possible causes include welded contactor or frozen compressor relay on the MBB.

To check out alarms A051 to A053:

1. Place the unit in Service Test mode. All compressors should be off.
2. Verify that there is not 24-v at the contactor coil. If there is 24 v at the contactor, check relay on MBB and wiring.
3. Check for welded contactor.
4. Verify CSB wiring.
5. Return to Normal mode and observe compressor operation to verify that compressor current sensor is working and condenser fans are energized.

A060 (Cooler Leaving Fluid Thermistor Failure) — The sensor reading is outside the range of -40 to 245 F (-40 to 118 C) then the alarm will occur. The cause of the alarm is usually a faulty thermistor, a shorted or open thermistor caused by a wiring error, or a loose connection. Failure of this thermistor will shut down the entire unit.

A061 (Cooler Entering Thermistor Failure) — If the sensor reading is outside the range of -40 to 240 F (-40 to 116 C) then the alarm will occur. The cause of the alarm is usually a faulty thermistor, a shorted or open thermistor caused by a wiring error, or a loose connection. Failure of this thermistor will shut down the entire unit.

T062 (Condenser Leaving Fluid Thermistor Failure) — The sensor reading is outside the range of -40 to 245 F (-40 to 118 C) then the alert will occur. The cause of the alert is usually a faulty thermistor, a shorted or open thermistor caused by a wiring error, or a loose connection. Failure of this thermistor will send out an alert only.

T063 (Condenser Entering Thermistor Failure) — If the sensor reading is outside the range of -40 to 240 F (-40 to 116 C) then the alert will occur. The cause of the alert is usually a faulty thermistor, a shorted or open thermistor caused by a wiring error, or a loose connection. Failure of this thermistor will send out an alert only.

T068 (Circuit A Compressor Return Gas Temperature Thermistor Failure) — This alert occurs if the RGT is configured and the compressor return gas temperature sensor is outside the range of -40 to 240 F (-40 to 116 C). Failure of this thermistor will shut down the appropriate circuit.

T073 (Outside Air Temperature Thermistor Failure) — This alert occurs when the outside air temperature sensor is outside the range of -40 to 240 F (-40 to 116 C). Failure of this thermistor will disable any elements of the control which requires its use. The OAT must be configured.

T074 (Space Temperature Thermistor Failure) — This alert occurs when the space temperature sensor is outside the range of -40 to 245 F (-40 to 118 C). Failure of this thermistor will disable any elements of the control which requires its use. The cause of the alert is usually a faulty thermistor in the T55, or T58 device, a shorted or open thermistor caused by a wiring error, or a loose connection. The SPT must be configured.

A077 (Circuit Saturated Suction Temperature Exceeds Cooler Leaving Water Temperature) — This alarm occurs when the saturated suction temperature (SST) is greater than

leaving water for 5 minutes. This alarm will occur if either the suction pressure transducer reading, which is used to calculate SST, or cooler leaving water is incorrect. Potential causes for this alarm are loose wiring connection, sensor not located in well or bad Schrader fitting. Reset is manual.

T079 (Dual Chiller Thermistor Failure) — This alert occurs when the dual chiller temperature sensor is outside its range of -40 to 240 F. Failure of this thermistor will disable Dual Chiller operation and return to stand-alone operation. The unit must be configured for Dual Chiller operation for this alert to occur. The cause of the alert is usually a faulty thermistor, a shorted or open thermistor caused by a wiring error, or a loose connection. Reset is automatic.

A090 (Circuit A Discharge Pressure Transducer Failure) — This alarm occurs when the pressure is outside the range of 0.0 to 667.0 psig. A circuit cannot run when this alarm is active. Use the scrolling marquee to reset the alarm. The cause of the alarm is usually a faulty transducer, faulty 5-v power supply, or a loose connection.

A092 (Circuit A Suction Pressure Transducer Failure) — This alarm occurs when the pressure is outside the range of 0.0 to 420.0 psig. A circuit cannot run when this alarm is active. Use the scrolling marquee to reset the alarm. The cause of the alarm is usually a faulty transducer, faulty 5-v power supply, or a loose connection.

T094 (Discharge Gas Thermistor Failure) — This alert occurs for units which have the digital compressor installed on circuit A. If discharge gas temperature is open or shorted, the circuit will be shut off. The alert will reset itself when discharge temperature is less than 250 F (121.1 C). The cause of the alert is usually low refrigerant charge or a faulty thermistor.

A110 (Circuit A Loss of Charge) — This alarm occurs when the compressor is OFF and the discharge pressure is less than 26 psig.

A112 (Circuit A High Saturated Suction Temperature) — Alarm code 112 occurs when compressors in a circuit have been running for at least 5 minutes and the circuit saturated suction temperature is greater than 70 F (21.1 C). The high saturated suction alarm is generated and the circuit is shut down.

A114 (Circuit A Low Superheat) — Alarm code 114 occurs when the superheat of a circuit is less than 5 F (2.8 C) for 5 continuous minutes. The low superheat alarm is generated and the circuit is shut down. The RGT sensor must be installed.

A122 (Circuit A High Pressure Switch Failure) — The high pressure switch is wired in series with the compressor contactor coils of each compressor on the circuit to disable compressor operation immediately upon a high discharge pressure condition. The normally closed contacts in the switches are calibrated to open at 650 ± 10 psig which corresponds to a saturated condensing temperature of 155.6 ± 1.3 F. The pressure switches will automatically reset when the discharge pressure is reduced to 500 ± 15 psig which corresponds to a saturated condensing temperature of 134.1 ± 2.4 F.

The output of the high pressure switch is wired to inputs on the MBB to provide the control with an indication of a high pressure switch trip. This alert could occur when compressors are off if the wiring to the switch is broken or the switch has failed open.

If the high pressure switch trips on a circuit with compressors commanded on, the discharge pressure is recorded. If the recorded discharge pressure is between 630 to 660 psig (saturated condensing temperature between 153.0 and 156.9 F), and is also less than the value recorded on any previous high pressure switch trip, the upper horizontal portion of the compressor operating envelope (see Fig. 12) is lowered 0.4 F (3 psig). The control will not allow the compressor operating envelope to be lowered below 153.0 F (630 psig).

This is done to make a rough calibration of the high pressure switch trip point. In most cases this allows the control to detect a high head pressure condition prior to reaching the high pressure switch trip point.

When the trip occurs, all mechanical cooling on the circuit is shut down for 15 minutes. After 15 minutes, the circuit is allowed to restart.

A126 (Circuit A High Head Pressure) — This alarm occurs when the appropriate saturated condensing temperature is greater than the operating envelope shown in Fig 12. Prior to the alarm, the control will shut down one compressor on a circuit if that circuit's saturated condensing temperature is greater than the maximum SCT minus 5° F (2.7° C). If SCT continues to rise to greater than the maximum SCT, the alarm will occur and the circuit's remaining compressor will shut down. The cause of the alarm is usually an overcharged system, high outdoor ambient temperature coupled with dirty outdoor coil (30MPa only), plugged filter drier, a faulty high-pressure switch, or loss of condenser water flow.

A140 (Reverse Rotation Detected) — A test is made once, on power up, for suction pressure change on the first activated circuit. The unit control determines failure as follows:

1. The suction pressure is sampled 5 seconds before the compressor is brought on, right when the compressor is brought on and 5 seconds afterwards.
2. The rate of suction pressure change from 5 seconds before the compressor is brought on to when the compressor is brought on is calculated.
3. The rate of suction pressure change from when the compressor is brought on to 5 seconds afterwards is calculated.
4. With the above information, the test for reverse rotation is made. If the suction pressure change 5 seconds after compression is greater than the suction pressure change 5 seconds before compression - 1.25, then there is a reverse rotation error.

This alarm will disable mechanical cooling and will require manual reset. This alarm may be disabled once the reverse rotation check has been verified by setting **REVR** = Yes.

A150 (Unit is in Emergency Stop) — If the CCN emergency stop command is received, the alarm is generated and the unit will be immediately stopped.

If the CCN point name "EMSTOP" in the system table is set to emergency stop, the unit will shut down immediately and broadcast an alarm back to the CCN, indicating that the unit is down. This alarm will clear when the variable is set back to "enable."

A151 (Illegal Configuration) — An A151 alarm indicates an invalid configuration has been entered. The following are illegal configurations.

- Invalid unit size has been entered.
- Unit configuration set to invalid type.

A152 (Unit Down Due to Failure) — Reset is automatic when all alarms are cleared. This alarm indicates the unit is at 0% capacity.

T153 (Real Time Clock Hardware Failure) — A problem has been detected with MBB real time clock hardware. Try resetting the power and check the indicator lights. If the alarm continues, the board should be replaced.

A154 (Serial EEPROM Hardware Failure) — A problem has been detected with the EEPROM on the MBB. Try resetting the power and check the indicator lights. If the alarm continues, the board should be replaced.

T155 (Serial EEPROM Storage Failure Error) — A problem has been detected with the EEPROM storage on the MBB. Try resetting the power and check the indicator lights. If the alert continues, the board should be replaced.

A156 (Critical Serial EEPROM Storage Failure Error) — A problem has been detected with the EEPROM storage on the MBB. Try resetting the power and check the indicator lights. If the alarm continues, the board should be replaced.

A157 (A/D Hardware Failure) — A problem has been detected with A/D conversion on the boards. Try resetting the power and check the indicator lights. If the alarm continues, the board should be replaced.

T173 (Energy Management Module Communication Failure) — This alert indicates that there are communications problems with the energy management. All functions performed by the EMM will stop, which can include demand limit, reset and capacity input. The alert will automatically reset.

T174 (4 to 20 mA Cooling Set point Input Failure) — This alert indicates a problem has been detected with cooling set point 4 to 20 mA input. The input value is either less than 2 mA or greater than 22 mA.

T176 (4 to 20 mA Reset Input Failure) — This alert indicates a problem has been detected with reset 4 to 20 mA input. The input value is either less than 2 mA or greater than 22 mA. The reset function will be disabled when this occurs.

T177 (4 to 20 mA Demand Limit Input Failure) — This alert indicates a problem has been detected with demand limit 4 to 20 mA input. The input value is either less than 2 mA or greater than 22 mA. The reset function will be disabled when this occurs.

T500, T501, T502 (Current Sensor Board Failure — A xx Circuit A) — Alert codes 500, 501, and 502 are for compressors A1, A2, and A3 respectively. These alerts occur when the output of the CSB is a constant high value. These alerts reset automatically. If the problem cannot be resolved, the CSB must be replaced.

APPENDIX A — LOCAL DISPLAY TABLES

Run Status Mode and Sub-Mode Directory

SUB-MODE	ITEM	DISPLAY	ITEM DESCRIPTION	CCN POINT	COMMENT
VIEW	AUTO VIEW OF RUN STATUS				
	EWT	xxx.x °F	Entering Fluid Temp	EWT	
	LWT	xxx.x °F	Leaving Fluid Temp	LWT	
	SETP	xxx.x °F	Active Setpoint	SP	
	CTPT	xxx.x °F	Control Point	CTRL_PNT	
	LOD.F	xxx	Load/Unload Factor	SMZ	
	STAT		Control Mode	STAT	
	OCC	NO/YES	Occupied	OCC	
	MODE	NO/YES	Override Modes in Effect	MODE	
	CAP	xxx	Percent Total Capacity	CAP_T	
	STGE	x	Requested Stage	STAGE	
	ALRM	xxx	Current Alarms & Alerts	ALRMALRT	
	TIME	xx.xx	Time of Day	TIMECOPY	00:00-23:59
	MNTH	xx	Month of Year	MOY	1 - 12 (1 = January, 2 = February, etc.)
	DATE	xx	Day of Month	DOM	01-31
YEAR	xx	Year of Century	YOCDISP		
RUN	UNIT RUN HOUR AND START				
	HRS.U	xxxx HRS	Machine Operating Hours	HR_MACH	0 to 999999
	STR.U	xxxx	Machine Starts	CY_MACH	0 to 1000000
	HR.P1	xxxx HRS	Cooler Pump Run Hours	HR_CPUMP	0 to 999999.9
	HR.P2	xxxx HRS	Condenser Pump Run Hours	HR_DPUMP	0 to 999999.9
HOUR	CIRC AND COMP RUN HOURS				
	HR.A1	xxxx HRS	Compressor A1 Run Hours	HOURS_A1	0 to 999999
	HR.A2	xxxx HRS	Compressor A2 Run Hours	HOURS_A2	0 to 999999
	HR.A3	xxxx HRS	Compressor A3 Run Hours	HOURS_A3	0 to 999999
STRT	COMPRESSOR STARTS				
	ST.A1	xxxx	Compressor A1 Starts	CY_A1	0 to 999999
	ST.A2	xxxx	Compressor A2 Starts	CY_A2	0 to 999999
	ST.A3	xxxx	Compressor A3 Starts	CY_A3	0 to 999999
PM	PREVENTIVE MAINTENANCE				
	STRAINER MAINTENANCE				
	STRN				
	SI.ST	xxxx HRS	Strainer Svc Interval	SI_STRNR	0 to 65535
	S.T.DN	xxxx HRS	Strainer Svc Countdown	ST_CDOWN	0 to 65535
	S.T.MN	NO/YES	Strainer Maint. Done	ST_MAINT	
	ST.DT				
	STRAINER MAINT. DATES				
	S.T.M0		MM/DD/YY HH:MM		
	S.T.M1		MM/DD/YY HH:MM		
S.T.M2		MM/DD/YY HH:MM			
S.T.M3		MM/DD/YY HH:MM			
S.T.M4		MM/DD/YY HH:MM			
VERS	SOFTWARE VERSION NUMBERS				
	AUX		CESR131333-xx-xx		
	MBB		CESR131279-xx-xx		
	EMM		CESR131174-xx-xx		
	MARQ		CESR131171-xx-xx		
	NAVI		CESR130227-xx-xx		

APPENDIX A — LOCAL DISPLAY TABLES (cont)

Service Test Mode and Sub-Mode Directory

SUB-MODE	ITEM	DISPLAY	ITEM DESCRIPTION	CCN POINT	COMMENT
TEST		ON/OFF	Service Test Mode	MAN_CTRL	To enable Service Test mode, move Enable/Off/Remote contact switch to OFF. Change TEST to ON. Move switch to ENABLE
OUTPUTS AND PUMPS					
OUTS	CLR.P	OFF/ON	Cooler Pump Relay	S_CLPMP	
	CND.P	OFF/ON	Condenser Pump	S_CNDPMP	
	UL.TM	xx	Comp A1 Unload Time	S_A1ULTM	0 to 15
	CC.H	OFF/ON	Crankcase Heater	S_CCH	
	CW.VO	OFF/ON	Condenser Valve Open	S_CWVO	
	CW.VC	OFF/ON	Condenser Valve Close	S_CWVC	
	LL.SV	OFF/ON	Liquid Line Solenoid	S_LLSV	
RMT.A	OFF/ON	Remote Alarm Relay	S_ALM		
CIRCUIT A COMPRESSOR TST					
CMPA	CC.A1	OFF/ON	Compressor A1 Relay	S_A1_RLY	
	UL.TM	xx	Comp A1 Unload Time	S_A1ULTM	0 to 15
	CC.A2	OFF/ON	Compressor A2 Relay	S_A2_RLY	
	CC.A3	OFF/ON	Compressor A3 Relay	S_A3_RLY	
	MLV	OFF/ON	Minimum Load Valve Relay	S_MLV	

Temperature Mode and Sub-Mode Directory

SUB-MODE	ITEM	DISPLAY	ITEM DESCRIPTION	CCN POINT
ENT AND LEAVE UNIT TEMPS				
UNIT	CEWT	xxx.x °F	Cooler Entering Fluid	COOL_EWT
	CLWT	xxx.x °F	Cooler Leaving Fluid	COOL_LWT
	CDET	xxx.x °F	Condenser Entering Fluid	COND_EWT
	CDLT	xxx.x °F	Condenser Leaving Fluid	COND_LWT
	OAT	xxx.x °F	Outside Air Temperature	OAT
	SPT	xxx.x °F	Space Temperature	SPT
	DLWT	xxx.x °F	Lead/Lag Leaving Fluid	DUAL_LWT
TEMPERATURES CIRCUIT A				
CIR.A	SCT.A	xxx.x °F	Saturated Condensing Tmp	TMP_SCTA
	SST.A	xxx.x °F	Saturated Suction Temp	TMP_SSTA
	RGTA	xxx.x °F	Compr Return Gas Temp	TMP_RGTA
	D.GAS	xxx.x °F	Discharge Gas Temp	DISGAS
	SH.A	xxx.x ΔF	Suction Superheat Temp	SH_A

Pressures Mode and Sub-Mode Directory

SUB-MODE	ITEM	DISPLAY	ITEM DESCRIPTION	CCN POINT
PRESSURES CIRCUIT A				
PRC.A	DPA	xxx.x PSIG	Discharge Pressure	DP_A
	SPA	xxx.x PSIG	Suction Pressure	SP_A

APPENDIX A — LOCAL DISPLAY TABLES (cont)

Set Points Mode and Sub-Mode Directory

SUB-MODE	ITEM	DISPLAY	ITEM DESCRIPTION	RANGE	CCN POINT
COOLING SETPOINTS					
COOL	CSP.1	xxx.x °F	Cooling Setpoint 1	-20 to 70	CSP1
	CSP.2	xxx.x °F	Cooling Setpoint 2	-20 to 70	CSP2
	CSP.3	xxx.x °F	ICE Setpoint	-20 to 32	CSP3
HEAD PRESSURE SETPOINTS					
HEAD	H.DP	xxx.x °F	Head Setpoint	85 to 120	HSP
BRINE FREEZE SETPOINT					
FRZ	BR.FZ	xx.x °F	Brine Freeze Point	-20 to 34	BRN_FRZ

Inputs Mode and Sub-Mode Directory

SUB-MODE	ITEM	DISPLAY	ITEM DESCRIPTION	CCN POINT
GENERAL INPUTS				
GEN.I	STST	OFF/ON	Start/Stop Switch	START
	FLOW	OFF/ON	Cooler Flow Switch	COOLFLOW
	CD.FL	OFF/ON	Condenser Flow Switch	CONDFLOW
	DLS1	OFF/ON	Demand Limit Switch 1	DMD_SW1
	DLS2	OFF/ON	Demand Limit Switch 2	DMD_SW2
	ICED	OFF/ON	Ice Done	ICE_DONE
	DUAL	OFF/ON	Dual Setpoint Switch	DUAL_IN
CIRCUIT INPUTS				
CRCT	FKA1	OFF/ON	Compressor A1 Feedback	K_A1_FBK
	FKA2	OFF/ON	Compressor A2 Feedback	K_A2_FBK
	FKA3	OFF/ON	Compressor A3 Feedback	K_A3_FBK
	HPS.A	OFF/ON	High Pressure Switch A	HPSA
4-20 MA INPUTS				
4-20	DMND	xx.x	4-20 ma Demand Signal	LMT_MA
	RSET	xx.x	4-20 ma Reset Signal	RST_MA
	CSP	xx.x	4-20 ma Cooling Setpoint	CSP_IN

Outputs Mode and Sub-Mode Directory

SUB-MODE	ITEM	DISPLAY	ITEM DESCRIPTION	CCN POINT
GENERAL OUTPUTS				
GEN.O	C.LWP	OFF/ON	Cooler Pump Relay	COOLPUMP
	C.DWP	OFF/ON	Condenser Pump	CONDPUMP
	ALRM	OFF/ON	Alarm State	ALM
	CDWO	OFF/ON	Condenser Valve Open	COND_WVO
	CDWC	OFF/ON	Condenser Valve Close	COND_WVC
OUTPUTS CIRCUIT A				
CIR.A	CC.A1	OFF/ON	Compressor A1 Relay	K_A1_RLY
	D.SOL	OFF/ON	Digital Scroll Solenoid	DISCRSOL
	CC.A2	OFF/ON	Compressor A2 Relay	K_A2_RLY
	CC.A3	OFF/ON	Compressor A3 Relay	K_A3_RLY
	CCH	OFF/ON	Crankcase Heater Relay	CCH_RLY
	LLSV	OFF/ON	Liquid Line Solenoid	LLSV_A
	MLV.R	OFF/ON	Minimum Load Valve Relay	MLV_RLY

APPENDIX A — LOCAL DISPLAY TABLES (cont)

Configuration Mode and Sub-Mode Directory

SUB-MODE	ITEM	DISPLAY	ITEM DESCRIPTION	CCN POINT	COMMENT
DISPLAY CONFIGURATION					
DISP	TEST	OFF/ON	Test Display LEDs	DISPTEST	
	METR	OFF/ON	Metric Display	DISPUNIT	Off = English On = Metric
	LANG	X	Language Selection	LANGUAGE	Default: 0 0 = English 1 = Espanol 2 = Francais 3 = Portuguese
	PAS.E	DSBL/ENBL	Password Enable	PASS_EBL	
	PASS	XXXX	Service Password	PASSCOPY	0 to 9999
UNIT CONFIGURATION					
UNIT	TYPE	X	Unit Type	UNIT_TYP	2=Water Cooled, 3=Split System
	SIZE	XXX	Unit Size	SIZE	10 to 100
	SZA.1	XX	Compressor A1 Size	SIZE_A1	
	SZA.2	XX	Compressor A2 Size	SIZE_A2	
	SZA.3	XX	Compressor A3 Size	SIZE_A3	
	A1.TY	NO/YES	Compressor A1 Digital?	CPA1TYPE	
	MAX.T	XX	Maximum A1 Unload Time	MAXULTME	0 to 15
UNIT OPTIONS 1 HARDWARE					
OPT1	FLUD	X	Cooler Fluid	FLUIDTYP	1 = Water 2 = Medium Temperature Brine
	MLV.S	NO/YES	Minimum Load Vlv Select	MLV_FLG	
	RG.EN	DSBL/ENBL	Return Gas Sensor Enable	RGT_ENA	
	OAT.E	DSBL/ENBL	Enable OAT Sensor	OAT_ENA	
	D.G.EN	DSBL/ENBL	Dischrge Gas Temp Enable	DISGASEN	
	CSB.E	DSBL/ENBL	CSB Boards Enable	CSB_ENA	
	CPC	OFF/ON	Cooler Pump Control	CPC	
	PM.DY	XX MIN	Cooler Pump Shutdown Dly	PUMP_DLY	0 to 10
	DPME	X	Enable Condenser Pump	CONDPMPPE	0 to 2
DFLS	DSBL/ENBL	Enable Cond Flow Switch	CONDFLSW		
CDWS	DSBL/ENBL	Enable Cond Wtr Sensors	CONDWTRS		
UNIT OPTIONS 2 CONTROLS					
OPT2	CTRL	X	Control Method	CONTROL	0=Switch, 1=Occupancy, 2=Occupancy, 3=CCN
	LCWT	XX	High LCW Alert Limit	LCW_LMT	2 to 60
	DELY	XX	Minutes Off Time	DELAY	0 to 15
	ICE.M	DSBL/ENBL	Ice Mode Enable	ICE_CNFG	
CCN NETWORK CONFIGS					
CCN	CCNA	XXX	CCN Address	CCNADD	1 to 239
	CCNB	XXX	CCN Bus Number	CCNBUS	0 to 239
	BAUD	X	CCN Baud Rate	CCNBAUDD	1 = 2400 2 = 4800 3 = 9600 4 =19,200 5 =38,400

APPENDIX A — LOCAL DISPLAY TABLES (cont)
Configuration Mode and Sub-Mode Directory (cont)

SUB-MODE	ITEM	DISPLAY	ITEM DESCRIPTION	CCN POINT	COMMENT
RSET	RESET COOL TEMP				
	CRST	X	Cooling Reset Type	CRST_TYP	0 = No Reset 1 = 4 to 20 mA Input 2 = Outdoor Air Temperature 3 = Return Fluid 4 = Space Temperature
	MA.DG	XX.XΔF	4-20 - Degrees Reset	420_DEG	-30 to 30
	RM.NO	XXX.X °F	Remote - No Reset Temp	REM_NO	0 to 125
	RM.F	XXX.X °F	Remote - Full Reset Temp	REM_FULL	0 to 125
	RM.DG	XX.X °F	Remote - Degrees Reset	REM_DEG	-30 to 30
	RT.NO	XXX.XΔF	Return - No Reset Temp	RTN_NO	0 to 30
	RT.F	XXX.XΔF	Return - Full Reset Temp	RTN_FULL	0 to 10
	RT.DG	XX.X °F	Return - Degrees Reset	RTN_DEG	-30 to 30
	DMDC	X	Demand Limit Select	DMD_CTRL	0 = None 1 = Switch 2 - 4 to 20 mA Input 3 = CCN Loadshed
	DM20	XXX%	Demand Limit at 20 mA	DMT20MA	0 to 100
	SHNM	XXX	Loadshed Group Number	SHED_NUM	0 to 99
	SHDL	XXX%	Loadshed Demand Delta	SHED_DEL	0 to 60
	SHTM	XXX	Maximum Loadshed Time	SHED_TIM	0 to 120
	DLS1	XXX%	Demand Limit Switch 1	DLSWSP1	0 to 100
	DLS2	XXX%	Demand Limit Switch 2	DLSWSP2	0 to 100
	LLEN	DSBL/ENBL	Lead/Lag Chiller Enable	LL_ENA	
	MSSL	SLVE/MAST	Master/Slave Select	MS_SEL	
SLVA	XXX	Slave Address	SLV_ADDR	0 to 239	
LLBL	X	Lead/Lag Balance Select	LL_BAL	0 = Master Leads 1 = Slave Leads 2 = Automatic	
LLBD	XXX	Lead/Lag Balance Delta	LL_BAL_D	40 to 400 hours	
LLDY	XXX	Lag Start Delay	LL_DELAY	0 to 30 minutes	
PARA	NO/YES	Parallel Configuration	PARALLEL		
SLCT	SETPOINT AND RAMP LOAD				
	CLSP	X	Cooling Set Point Select	CLSP_TYP	0 = Single 1 = Dual Switch 2 = Dual CCN Occupied 3 = 4 to 20 mA Input
	RL.S	DSBL/ENBL	Ramp Load Select	RAMP_EBL	
	CRMP	X.X	Cooling Ramp Loading	CRAMP	0.2 to 2
	SCHD	XX	Schedule Number	SCHEDNUM	0 to 99
Z.GN	X.X	Deadband Multiplier	Z_GAIN	1 to 4	
SERV	SERVICE CONFIGURATION				
	EN.A1	DSBL/ENBL	Enable Compressor A1	ENABLEA1	
	EN.A2	DSBL/ENBL	Enable Compressor A2	ENABLEA2	
	EN.A3	DSBL/ENBL	Enable Compressor A3	ENABLEA3	
REV.R	DSBL/ENBL	Reverse Rotation Enable	REVR_ENA		
BCST	BROADCAST CONFIGURATION				
	T.D.BC	OFF/ON	CCN Time/Date Broadcast	CCNBC	
	OAT.B	OFF/ON	CCN OAT Broadcast	OATBC	
	G.S.BC	OFF/ON	Global Schedule Broadcast	GSBC	
BC.AK	OFF/ON	CCN Broadcast Ack'er	CCNBCACK		

APPENDIX A — LOCAL DISPLAY TABLES (cont)

Time Clock Mode and Sub-Mode Directory

SUB-MODE	ITEM	DISPLAY	ITEM DESCRIPTION	CCN POINT	COMMENT	
TIME	TIME OF DAY					
	HH.MM	XX.XX	Hour and Minute	TIME		
DATE	MONTH, DATE, DAY, AND YEAR					
	MNTH	XX	Month of Year	MOY	1 to 12 (1 = January, 2 = February, etc.)	
	DOM	XX	Day of Month	DOM	1 to 31	
	DAY	X	Day of Week	DOWDISP	1 - 7 (1 = Sunday, 2 = Monday, etc.)	
	YEAR	XXXX	Year of Century	YOCDISP	1999 to 2098	
DST	DAYLIGHT SAVINGS TIME					
	STR.M	XX	Month	STARTM	Default: 4 Range 1 to 12	
	STR.W	X	Week	STARTW	Default: 1 Range 1 to 5	
	STR.D	X	Day	STARTD	Default: 7 Range 1 to 7	
	MIN.A	XX	Minutes to Add	MINADD	Default: 60 Range 0 to 90	
	STP.M	XX	Month	STOPM	Default: 10 Range 1 to 12	
	STP.W	XX	Week	STOPW	Default: 5 Range 1 to 5	
	STP.D	XX	Day	STOPD	Default: 7 Range 1 to 7	
HOL.L	LOCAL HOLIDAY SCHEDULES					
	HOLIDAY SCHEDULE 01					
	HD.01	MON	XX	Holiday Start Month	HOLMON01	0 to 12
		DAY	XX	Start Day	HOLDAY01	0 to 31
		LEN	XX	Duration (days)	HOLLEN01	0 to 99
	HOLIDAY SCHEDULE 02					
	HD.02	MON	XX	Holiday Start Month	HOLMON02	0 to 12
		DAY	XX	Start Day	HOLDAY02	0 to 31
LEN		XX	Duration (days)	HOLLEN02	0 to 99	
HOLIDAY SCHEDULE 03						
HD.03	MON	XX	Holiday Start Month	HOLMON03	0 to 12	
	DAY	XX	Start Day	HOLDAY03	0 to 31	
	LEN	XX	Duration (days)	HOLLEN03	0 to 99	
HOLIDAY SCHEDULE 04						
HD.04	MON	XX	Holiday Start Month	HOLMON04	0 to 12	
	DAY	XX	Start Day	HOLDAY04	0 to 31	
	LEN	XX	Duration (days)	HOLLEN04	0 to 99	
HOLIDAY SCHEDULE 05						
HD.05	MON	XX	Holiday Start Month	HOLMON05	0 to 12	
	DAY	XX	Start Day	HOLDAY05	0 to 31	
	LEN	XX	Duration (days)	HOLLEN05	0 to 99	
HOLIDAY SCHEDULE 06						
HD.06	MON	XX	Holiday Start Month	HOLMON06	0 to 12	
	DAY	XX	Start Day	HOLDAY06	0 to 31	
	LEN	XX	Duration (days)	HOLLEN06	0 to 99	
HOLIDAY SCHEDULE 07						
HD.07	MON	XX	Holiday Start Month	HOLMON07	0 to 12	
	DAY	XX	Start Day	HOLDAY07	0 to 31	
	LEN	XX	Duration (days)	HOLLEN07	0 to 99	
HOLIDAY SCHEDULE 08						
HD.08	MON	XX	Holiday Start Month	HOLMON08	0 to 12	
	DAY	XX	Start Day	HOLDAY08	0 to 31	
	LEN	XX	Duration (days)	HOLLEN08	0 to 99	

APPENDIX A — LOCAL DISPLAY TABLES (cont)

Time Clock Mode and Sub-Mode Directory (cont)

SUB-MODE	ITEM	DISPLAY	ITEM DESCRIPTION	CCN POINT	COMMENT
HD.09	HOLIDAY SCHEDULE 09				
	MON	XX	Holiday Start Month	HOLMON09	0 to 12
	DAY	XX	Start Day	HOLDAY09	0 to 31
	LEN	XX	Duration (days)	HOLLEN09	0 to 99
HD.10	HOLIDAY SCHEDULE 10				
	MON	XX	Holiday Start Month	HOLMON10	0 to 12
	DAY	XX	Start Day	HOLDAY10	0 to 31
	LEN	XX	Duration (days)	HOLLEN10	0 to 99
HD.11	HOLIDAY SCHEDULE 11				
	MON	XX	Holiday Start Month	HOLMON11	0 to 12
	DAY	XX	Start Day	HOLDAY11	0 to 31
	LEN	XX	Duration (days)	HOLLEN11	0 to 99
HD.12	HOLIDAY SCHEDULE 12				
	MON	XX	Holiday Start Month	HOLMON12	0 to 12
	DAY	XX	Start Day	HOLDAY12	0 to 31
	LEN	XX	Duration (days)	HOLLEN12	0 to 99
HD.13	HOLIDAY SCHEDULE 13				
	MON	XX	Holiday Start Month	HOLMON13	0 to 12
	DAY	XX	Start Day	HOLDAY13	0 to 31
	LEN	XX	Duration (days)	HOLLEN13	0 to 99
HD.14	HOLIDAY SCHEDULE 14				
	MON	XX	Holiday Start Month	HOLMON14	0 to 12
	DAY	XX	Start Day	HOLDAY14	0 to 31
	LEN	XX	Duration (days)	HOLLEN14	0 to 99
HD.15	HOLIDAY SCHEDULE 15				
	MON	XX	Holiday Start Month	HOLMON15	0 to 12
	DAY	XX	Start Day	HOLDAY15	0 to 31
	LEN	XX	Duration (days)	HOLLEN15	0 to 99
HD.16	HOLIDAY SCHEDULE 16				
	MON	XX	Holiday Start Month	HOLMON16	0 to 12
	DAY	XX	Start Day	HOLDAY16	0 to 31
	LEN	XX	Duration (days)	HOLLEN16	0 to 99
HD.17	HOLIDAY SCHEDULE 17				
	MON	XX	Holiday Start Month	HOLMON17	0 to 12
	DAY	XX	Start Day	HOLDAY17	0 to 31
	LEN	XX	Duration (days)	HOLLEN17	0 to 99
HD.18	HOLIDAY SCHEDULE 18				
	MON	XX	Holiday Start Month	HOLMON18	0 to 12
	DAY	XX	Start Day	HOLDAY18	0 to 31
	LEN	XX	Duration (days)	HOLLEN18	0 to 99
HD.19	HOLIDAY SCHEDULE 19				
	MON	XX	Holiday Start Month	HOLMON19	0 to 12
	DAY	XX	Start Day	HOLDAY19	0 to 31
	LEN	XX	Duration (days)	HOLLEN19	0 to 99

APPENDIX A — LOCAL DISPLAY TABLES (cont)

Time Clock Mode and Sub-Mode Directory (cont)

SUB-MODE	ITEM	DISPLAY	ITEM DESCRIPTION	CCN POINT	COMMENT
HD.20	HOLIDAY SCHEDULE 20				
	MON	XX	Holiday Start Month	HOLMON20	0 to 12
	DAY	XX	Start Day	HOLDAY20	0 to 31
	LEN	XX	Duration (days)	HOLLEN20	0 to 99
HD.21	HOLIDAY SCHEDULE 21				
	MON	XX	Holiday Start Month	HOLMON21	0 to 12
	DAY	XX	Start Day	HOLDAY21	0 to 31
	LEN	XX	Duration (days)	HOLLEN21	0 to 99
HD.22	HOLIDAY SCHEDULE 22				
	MON	XX	Holiday Start Month	HOLMON22	0 to 12
	DAY	XX	Start Day	HOLDAY22	0 to 31
	LEN	XX	Duration (days)	HOLLEN22	0 to 99
HD.23	HOLIDAY SCHEDULE 23				
	MON	XX	Holiday Start Month	HOLMON23	0 to 12
	DAY	XX	Start Day	HOLDAY23	0 to 31
	LEN	XX	Duration (days)	HOLLEN23	0 to 99
HD.24	HOLIDAY SCHEDULE 24				
	MON	XX	Holiday Start Month	HOLMON24	0 to 12
	DAY	XX	Start Day	HOLDAY24	0 to 31
	LEN	XX	Duration (days)	HOLLEN24	0 to 99
HD.25	HOLIDAY SCHEDULE 25				
	MON	XX	Holiday Start Month	HOLMON25	0 to 12
	DAY	XX	Start Day	HOLDAY25	0 to 31
	LEN	XX	Duration (days)	HOLLEN25	0 to 99
HD.26	HOLIDAY SCHEDULE 26				
	MON	XX	Holiday Start Month	HOLMON26	0 to 12
	DAY	XX	Start Day	HOLDAY26	0 to 31
	LEN	XX	Duration (days)	HOLLEN26	0 to 99
HD.27	HOLIDAY SCHEDULE 27				
	MON	XX	Holiday Start Month	HOLMON27	0 to 12
	DAY	XX	Start Day	HOLDAY27	0 to 31
	LEN	XX	Duration (days)	HOLLEN27	0 to 99
HD.28	HOLIDAY SCHEDULE 28				
	MON	XX	Holiday Start Month	HOLMON28	0 to 12
	DAY	XX	Start Day	HOLDAY28	0 to 31
	LEN	XX	Duration (days)	HOLLEN28	0 to 99
HD.29	HOLIDAY SCHEDULE 29				
	MON	XX	Holiday Start Month	HOLMON29	0 to 12
	DAY	XX	Start Day	HOLDAY29	0 to 31
	LEN	XX	Duration (days)	HOLLEN29	0 to 99
HD.30	HOLIDAY SCHEDULE 30				
	MON	XX	Holiday Start Month	HOLMON30	0 to 12
	DAY	XX	Start Day	HOLDAY30	0 to 31
	LEN	XX	Duration (days)	HOLLEN30	0 to 99

APPENDIX A — LOCAL DISPLAY TABLES (cont)

Time Clock Mode and Sub-Mode Directory (cont)

SUB-MODE	ITEM	DISPLAY	ITEM DESCRIPTION	CCN POINT	COMMENT
SCH.N			Schedule Number 0	SCHEDNUM	0 to 99
SCH.L	LOCAL OCCUPANCY SCHEDULE				
PER.1	OCCUPANCY PERIOD 1				
	OCC.1	XX:XX	Period Occupied Time	PER1OCC	
	UNC.1	XX:XX	Period Unoccupied Time	PER1UNC	
	MON.1	NO/YES	Monday In Period	PER1MON	
	TUE.1	NO/YES	Tuesday In Period	PER1TUE	
	WED.1	NO/YES	Wednesday In Period	PER1WED	
	THU.1	NO/YES	Thursday In Period	PER1THU	
	FRI.1	NO/YES	Friday In Period	PER1FRI	
	SAT.1	NO/YES	Saturday In Period	PER1SAT	
SUN.1	NO/YES	Sunday In Period	PER1SUN		
HOL.1	NO/YES	Holiday In Period	PER1HOL		
PER.2	OCCUPANCY PERIOD 2				
	OCC.2	XX:XX	Period Occupied Time	PER2OCC	
	UNC.2	XX:XX	Period Unoccupied Time	PER2UNC	
	MON.2	NO/YES	Monday In Period	PER2MON	
	TUE.2	NO/YES	Tuesday In Period	PER2TUE	
	WED.2	NO/YES	Wednesday In Period	PER2WED	
	THU.2	NO/YES	Thursday In Period	PER2THU	
	FRI.2	NO/YES	Friday In Period	PER2FRI	
	SAT.2	NO/YES	Saturday In Period	PER2SAT	
SUN.2	NO/YES	Sunday In Period	PER2SUN		
HOL.2	NO/YES	Holiday In Period	PER2HOL		
PER.3	OCCUPANCY PERIOD 3				
	OCC.3	XX:XX	Period Occupied Time	PER3OCC	
	UNC.3	XX:XX	Period Unoccupied Time	PER3UNC	
	MON.3	NO/YES	Monday In Period	PER3MON	
	TUE.3	NO/YES	Tuesday In Period	PER3TUE	
	WED.3	NO/YES	Wednesday In Period	PER3WED	
	THU.3	NO/YES	Thursday In Period	PER3THU	
	FRI.3	NO/YES	Friday In Period	PER3FRI	
	SAT.3	NO/YES	Saturday In Period	PER3SAT	
SUN.3	NO/YES	Sunday In Period	PER3SUN		
HOL.3	NO/YES	Holiday In Period	PER3HOL		
PER.4	OCCUPANCY PERIOD 4				
	OCC.4	XX:XX	Period Occupied Time	PER4OCC	
	UNC.4	XX:XX	Period Unoccupied Time	PER4UNC	
	MON.4	NO/YES	Monday In Period	PER4MON	
	TUE.4	NO/YES	Tuesday In Period	PER4TUE	
	WED.4	NO/YES	Wednesday In Period	PER4WED	
	THU.4	NO/YES	Thursday In Period	PER4THU	
	FRI.4	NO/YES	Friday In Period	PER4FRI	
	SAT.4	NO/YES	Saturday In Period	PER4SAT	
SUN.4	NO/YES	Sunday In Period	PER4SUN		
HOL.4	NO/YES	Holiday In Period	PER4HOL		
PER.5	OCCUPANCY PERIOD 5				
	OCC.5	XX:XX	Period Occupied Time	PER5OCC	
	UNC.5	XX:XX	Period Unoccupied Time	PER5UNC	
	MON.5	NO/YES	Monday In Period	PER5MON	
	TUE.5	NO/YES	Tuesday In Period	PER5TUE	
	WED.5	NO/YES	Wednesday In Period	PER5WED	
	THU.5	NO/YES	Thursday In Period	PER5THU	
	FRI.5	NO/YES	Friday In Period	PER5FRI	
	SAT.5	NO/YES	Saturday In Period	PER5SAT	
SUN.5	NO/YES	Sunday In Period	PER5SUN		
HOL.5	NO/YES	Holiday In Period	PER5HOL		

APPENDIX A — LOCAL DISPLAY TABLES (cont)

Time Clock Mode and Sub-Mode Directory (cont)

SUB-MODE	ITEM	DISPLAY	ITEM DESCRIPTION	CCN POINT	COMMENT
PER.6	OCCUPANCY PERIOD 6				
	OCC.6	XX:XX	Period Occupied Time	PER6OCC	
	UNC.6	XX:XX	Period Unoccupied Time	PER6UNC	
	MON.6	NO/YES	Monday In Period	PER6MON	
	TUE.6	NO/YES	Tuesday In Period	PER6TUE	
	WED.6	NO/YES	Wednesday In Period	PER6WED	
	THU.6	NO/YES	Thursday In Period	PER6THU	
	FRI.6	NO/YES	Friday In Period	PER6FRI	
	SAT.6	NO/YES	Saturday In Period	PER6SAT	
SUN.6	NO/YES	Sunday In Period	PER6SUN		
HOL.6	NO/YES	Holiday In Period	PER6HOL		
PER.7	OCCUPANCY PERIOD 7				
	OCC.7	XX:XX	Period Occupied Time	PER7OCC	
	UNC.7	XX:XX	Period Unoccupied Time	PER7UNC	
	MON.7	NO/YES	Monday In Period	PER7MON	
	TUE.7	NO/YES	Tuesday In Period	PER7TUE	
	WED.7	NO/YES	Wednesday In Period	PER7WED	
	THU.7	NO/YES	Thursday In Period	PER7THU	
	FRI.7	NO/YES	Friday In Period	PER7FRI	
	SAT.7	NO/YES	Saturday In Period	PER7SAT	
SUN.7	NO/YES	Sunday In Period	PER7SUN		
HOL.7	NO/YES	Holiday In Period	PER7HOL		
PER.8	OCCUPANCY PERIOD 8				
	OCC.8	XX:XX	Period Occupied Time	PER8OCC	
	UNC.8	XX:XX	Period Unoccupied Time	PER8UNC	
	MON.8	NO/YES	Monday In Period	PER8MON	
	TUE.8	NO/YES	Tuesday In Period	PER8TUE	
	WED.8	NO/YES	Wednesday In Period	PER8WED	
	THU.8	NO/YES	Thursday In Period	PER8THU	
	FRI.8	NO/YES	Friday In Period	PER8FRI	
	SAT.8	NO/YES	Saturday In Period	PER8SAT	
SUN.8	NO/YES	Sunday In Period	PER8SUN		
HOL.8	NO/YES	Holiday In Period	PER8HOL		
OVR	SCHEDULE OVERRIDE				
	OVR.T	X	Timed Override Hours	OVR_EXT	0 to 4 hours
	OVR.L	X	Override Time Limit	OTL	0 to 4 hours
	T.OVR	NO/YES	Timed Override	TIMEOVER	

APPENDIX A — LOCAL DISPLAY TABLES (cont)

Operating Mode and Sub-Mode Directory

SUB-MODE	ITEM	DISPLAY	ITEM DESCRIPTION	CCN POINT	COMMENT
MODE	MODES CONTROLLING UNIT				
	MD01	OFF/ON	FSM controlling Chiller	MODE_1	
	MD02	OFF/ON	WSM controlling Chiller	MODE_2	
	MD03	OFF/ON	Master/Slave control	MODE_3	
	MD05	OFF/ON	Ramp Load Limited	MODE_5	
	MD06	OFF/ON	Timed Override in effect	MODE_6	
	MD07	OFF/ON	Low Cooler Suction TempA	MODE_7	
	MD09	OFF/ON	Slow Change Override	MODE_9	
	MD10	OFF/ON	Minimum OFF time active	MODE_10	
	MD13	OFF/ON	Dual Setpoint	MODE_13	
	MD14	OFF/ON	Temperature Reset	MODE_14	
	MD15	OFF/ON	Demand Limited	MODE_15	
	MD16	OFF/ON	Cooler Freeze Protection	MODE_16	
	MD17	OFF/ON	Low Temperature Cooling	MODE_17	
	MD18	OFF/ON	High Temperature Cooling	MODE_18	
	MD19	OFF/ON	Making ICE	MODE_19	
	MD20	OFF/ON	Storing ICE	MODE_20	
	MD21	OFF/ON	High SCT Circuit A	MODE_21	
	MD23	OFF/ON	Minimum Comp. On Time	MODE_23	
	MD24	OFF/ON	Pump Off Delay Time	MODE_24	

APPENDIX A — LOCAL DISPLAY TABLES (cont)

Alarms Mode and Sub-Mode Directory

SUB-MODE	ITEM	DISPLAY	ITEM DESCRIPTION	CCN POINT	COMMENT
CURRENTLY ACTIVE ALARMS					
CRNT	AA01 AA02 AA03 AA04 AA05 AA06 AA07 AA08 AA09 AA10 AA11 AA12 AA13 AA14 AA15 AA16 AA17 AA18 AA19 AA20 AA21 AA22 AA23 AA24 AA25	AXXX TXXX PXXX	Current Alarms 1-25		Alarms are shown as AXXX Alerts are shown as TXXX
RCRN	NO/YES		Reset All Current Alarms	ALRESET	
ALARM HISTORY					
HIST	AL01 AL02 AL03 AL04 AL05 AL06 AL07 AL08 AL09 AL10 AL11 AL12 AL13 AL14 AL15 AL16 AL17 AL18 AL19 AL20	AXXX TXXX PXXX	Alarm History 1-20		Alarms are shown as AXXX Alerts are shown as TXXX

APPENDIX B — CCN TABLES

CCN DISPLAY TABLES — A_UNIT (General Unit Parameters)

DESCRIPTION	VALUE	UNITS	POINT NAME	FORCIBLE
Control Mode	10-char ASCII		STAT	N
Occupied	No/Yes		OCC	N
CCN Chiller	Stop/Start		CHIL_S_S	Y
Alarm State	6-char ASCII		ALM	N
Active Demand Limit	NNN	%	DEM_LIM	Y
Override Modes in Effect	No/Yes		MODE	N
Percent Total Capacity	NNN	%	CAP_T	N
Requested Stage	NN		STAGE	N
Active Setpoint	NNN.n	degF	SP	N
Control Point	NNN.n	degF	CTRL_PNT	Y
Entering Fluid Temp	NNN.n	degF	EWT	N
Leaving Fluid Temp	NNN.n	degF	LWT	N
Emergency Stop	Enable/EMStop		EMSTOP	Y
Minutes Left for Start	5-char ASCII		MIN_LEFT	N
PUMPS				
Cooler Pump Relay	Off/On		COOLPUMP	N
Condenser Pump	Off/On		CONDPUMP	N
Cooler Flow Switch	Off/On		COOLFLOW	N

CCN DISPLAY TABLES — CIRCA_AN (Circuit A Analog Parameters)

DESCRIPTION	VALUE	UNITS	POINT NAME	FORCIBLE
CIRCUIT A ANALOG VALUES				
Percent Total Capacity	NNN	%	CAPA_T	N
Percent Available Cap.	NNN	%	CAPA_A	N
Discharge Pressure	NNN.n	PSIG	DP_A	N
Suction Pressure	NNN.n	PSIG	SP_A	N
Head Setpoint	NNN.n	degF	HSP	N
Saturated Condensing Tmp	NNN.n	degF	TMP_SCTA	N
Saturated Suction Temp	NNN.n	degF	TMP_SSTA	N
Compr Return Gas Temp	NNN.n	degF	TMP_RGTA	N
Discharge Gas Temp	NNN.n	degF	DISGAS	N
Suction Superheat Temp	NNN.n	deltaF	SH_A	N

CCN DISPLAY TABLES — CIRCADIO (Circuit A Discrete Inputs/Outputs)

DESCRIPTION	VALUE	UNITS	POINT NAME	FORCIBLE
CIRC. A DISCRETE OUTPUTS				
Compressor A1 Relay	Off/On		K_A1_RLY	N
Compressor A2 Relay	Off/On		K_A2_RLY	N
Compressor A3 Relay	Off/On		K_A3_RLY	N
Minimum Load Valve Relay	Off/On		MLV_RLY	N
CIRC. A DISCRETE INPUTS				
Compressor A1 Feedback	Off/On		K_A1_FBK	N
Compressor A2 Feedback	Off/On		K_A2_FBK	N
Compressor A3 Feedback	Off/On		K_A3_FBK	N

APPENDIX B — CCN TABLES (cont)

CCN DISPLAY TABLES — OPTIONS (Unit Parameters)

DESCRIPTION	VALUE	UNITS	POINT NAME	FORCIBLE
UNIT ANALOG VALUES				
Cooler Entering Fluid	NNN.n	degF	COOL_EWT	N
Cooler Leaving Fluid	NNN.n	degF	COOL_LWT	N
Condenser Entering Fluid	NNN.n	degF	COND_EWT	N
Condenser Leaving Fluid	NNN.n	degF	COND_LWT	N
Lead/Lag Leaving Fluid	NNN.n	degF	DUAL_LWT	N
TEMPERATURE RESET				
4-20 ma Reset Signal	NN.n	milliAmps	RST_MA	N
Outside Air Temperature	NNN.n	degF	OAT	Y
Space Temperature	NNN.n	degF	SPT	Y
DEMAND LIMIT				
4-20 ma Demand Signal	NN.n	milliAmps	LMT_MA	N
Demand Limit Switch 1	Off/On		DMD_SW1	N
Demand Limit Switch 2	Off/On		DMD_SW2	N
CCN Loadshed Signal	N		DL_STAT	N
MISCELLANEOUS				
Dual Setpoint Switch	Off/On		DUAL_IN	N
Cooler LWT Setpoint	NNN.n	degF	LWT_SP	N
Ice Done	Off/On		ICE_DONE	N

CCN MAINTENANCE TABLES — STRTHOUR

DESCRIPTION	VALUE	UNITS	POINT NAME
Machine Operating Hours	NNNNNN	hours	HR_MACH
Machine Starts	NNNNNN		CY_MACH
Compressor A1 Run Hours	NNNNNN.n	hours	HR_A1
Compressor A2 Run Hours	NNNNNN.n	hours	HR_A2
Compressor A3 Run Hours	NNNNNN.n	hours	HR_A3
Compressor A1 Starts	NNNNNN		CY_A1
Compressor A2 Starts	NNNNNN		CY_A2
Compressor A3 Starts	NNNNNN		CY_A3
PUMP HOURS			
Cooler Pump Run Hours	NNNNNN.n	hours	HR_CPUMP
Condenser Pump Run Hours	NNNNNN.n	hours	HR_DPUMP

APPENDIX B — CCN TABLES (cont)

CCN MAINTENANCE TABLES — CURRMODS

DESCRIPTION	VALUE	POINT NAME
CSM controlling Chiller	Off/On	MODE_1
WSM controlling Chiller	Off/On	MODE_2
Master/Slave control	Off/On	MODE_3
Ramp Load Limited	Off/On	MODE_5
Timed Override in effect	Off/On	MODE_6
Low Cooler Suction TempA	Off/On	MODE_7
Slow Change Override	Off/On	MODE_9
Minimum OFF time active	Off/On	MODE_10
Dual Setpoint	Off/On	MODE_13
Temperature Reset	Off/On	MODE_14
Demand Limited	Off/On	MODE_15
Cooler Freeze Protection	Off/On	MODE_16
Low Temperature Cooling	Off/On	MODE_17
High Temperature Cooling	Off/On	MODE_18
Making ICE	Off/On	MODE_19
Storing ICE	Off/On	MODE_20
High SCT Circuit A	Off/On	MODE_21
Minimum Comp. On Time	Off/On	MODE_23
Pump Off Delay Time	Off/On	MODE_24
Low Sound Mode	Off/On	MODE_25

CCN MAINTENANCE TABLES — ALARMS

DESCRIPTION	VALUE	POINT NAME
Active Alarm #1	4-char ASCII	ALARM01C
Active Alarm #2	4-char ASCII	ALARM02C
Active Alarm #3	4-char ASCII	ALARM03C
Active Alarm #4	4-char ASCII	ALARM04C
Active Alarm #5	4-char ASCII	ALARM05C
Active Alarm #6	4-char ASCII	ALARM06C
Active Alarm #7	4-char ASCII	ALARM07C
Active Alarm #8	4-char ASCII	ALARM08C
Active Alarm #9	4-char ASCII	ALARM09C
Active Alarm #10	4-char ASCII	ALARM10C
Active Alarm #11	4-char ASCII	ALARM11C
Active Alarm #12	4-char ASCII	ALARM12C
Active Alarm #13	4-char ASCII	ALARM13C
Active Alarm #14	4-char ASCII	ALARM14C
Active Alarm #15	4-char ASCII	ALARM15C
Active Alarm #16	4-char ASCII	ALARM16C
Active Alarm #17	4-char ASCII	ALARM17C
Active Alarm #18	4-char ASCII	ALARM18C
Active Alarm #19	4-char ASCII	ALARM19C
Active Alarm #20	4-char ASCII	ALARM20C
Active Alarm #21	4-char ASCII	ALARM21C
Active Alarm #22	4-char ASCII	ALARM22C
Active Alarm #23	4-char ASCII	ALARM23C
Active Alarm #24	4-char ASCII	ALARM24C
Active Alarm #25	4-char ASCII	ALARM25C

CCN MAINTENANCE TABLES — VERSIONS

DESCRIPTION	VERSION	VALUE
AUX	CESR131333-	5-char ASCII
MBB	CESR131279-	5-char ASCII
EMM	CESR131174-	5-char ASCII
MARQUEE	CESR131171-	5-char ASCII
NAVIGATOR	CESR130227-	5-char ASCII

APPENDIX B — CCN TABLES (cont)

CCN MAINTENANCE TABLES — LOADFACT

DESCRIPTION	VALUE	UNITS	POINT NAME
CAPACITY CONTROL			
Load/Unload Factor	NNN		SMZ
Control Point	NNN.n	degF	CTRL_PNT
Entering Fluid Temp	NNN.n	degF	EWT
Leaving Fluid Temp	NNN.n	degF	LWT
Ramp Load Limited	Off/On		MODE_5
Slow Change Override	Off/On		MODE_9
Cooler Freeze Protection	Off/On		MODE_16
Low Temperature Cooling	Off/On		MODE_17
High Temperature Cooling	Off/On		MODE_18
Minimum Comp. On Time	Off/On		MODE_23

CCN MAINTENANCE TABLES — LEARNFNS

DESCRIPTION	VALUE	UNITS	POINT NAME
SCT Delta for Comp A1	NNN.n	deltaF	A1SCTDT
SCT Delta for Comp A2	NNN.n	deltaF	A2SCTDT
SCT Delta for Comp A3	NNN.n	deltaF	A3SCTDT
SAGP for Compressor A1	NNN.n		SAGA1P
SAGM for Compressor A1	NNN.n		SAGA1M
SAGP for Compressor A2	NNN.n		SAGA2P
SAGM for Compressor A2	NNN.n		SAGA2M
SAGP for Compressor A3	NNN.n		SAGA3P
SAGM for Compressor A3	NNN.n		SAGA3M
Reset short loop gain	Yes/No		RESET_GN

CCN MAINTENANCE TABLES — PM-STRN

DESCRIPTION	VALUE	UNITS	POINT NAME
Strainer Srvc Interval	NNNNN	hours	SI_STRNR
Strainer Srvc Countdown	NNNNN	hours	ST_CDOWN
Strainer Maint. Done	No/Yes		ST_MAINT
Strainer Maint. Date	15-char ASCII		STRN_PM0
Strainer Maint. Date	15-char ASCII		STRN_PM1
Strainer Maint. Date	15-char ASCII		STRN_PM2
Strainer Maint. Date	15-char ASCII		STRN_PM3
Strainer Maint. Date	15-char ASCII		STRN_PM4

CCN MAINTENANCE TABLES — TESTMODE

DESCRIPTION	VALUE	UNITS	POINT NAME
Service Test Mode	Off/On		NET_CTRL
Compressor A1 Relay	Off/On		S_A1_RLY
Compressor A2 Relay	Off/On		S_A2_RLY
Compressor A3 Relay	Off/On		S_A3_RLY
Cooler Pump Relay	Off/On		S_CLPMP
Condenser Pump	Off/On		S_CNDPMP
Comp A1 Unload Time	NN	secs	S_A1ULTM
Remote Alarm Relay	Off/On		S_ALM

APPENDIX B — CCN TABLES (cont)

CCN MAINTENANCE TABLES — RUNTEST

DESCRIPTION	VALUE	UNITS	POINT NAME
Percent Total Capacity	NNN	%	CAPA_T
Percent Available Cap.	NNN	%	CAPA_A
Discharge Pressure	NNN.n	PSIG	DP_A
Suction Pressure	NNN.n	PSIG	SP_A
Saturated Condensing Tmp	NNN.n	degF	TMP_SCTA
Saturated Suction Temp	NNN.n	degF	TMP_SSTA
Compr Return Gas Temp	NNN.n	degF	TMP_RGTA
Discharge Gas Temp	NNN.n	degF	DISGAS
Suction Superheat Temp	NNN.n	deltaF	SH_A
Compressor A1 Relay	Off/On		K_A1_RLY
Compressor A2 Relay	Off/On		K_A2_RLY
Compressor A3 Relay	Off/On		K_A3_RLY
Minimum Load Valve Relay	Off/On		MLV_RLY
Compressor A1 Feedback	Off/On		K_A1_FBK
Compressor A2 Feedback	Off/On		K_A2_FBK
Compressor A3 Feedback	Off/On		K_A3_FBK
Outside Air Temperature	NNN.n	degF	OAT
Space Temperature	NNN.n	degF	SPT
Cooler Pump Relay	Off/On		COOLPUMP
Condenser Pump	Off/On		CONDPUMP
Cooler Entering Fluid	NNN.n	degF	COOL_EWT
Cooler Leaving Fluid	NNN.n	degF	COOL_LWT
Cooler Flow Switch	Off/On		COOLFLOW

CCN MAINTENANCE TABLES — DUALCHIL

DESCRIPTION	VALUE	UNITS	POINT NAME
Dual Chiller Link Good?	No/Yes		DC_LINK
Master Chiller Role	12-char ASCII		MC_ROLE
Slave Chiller Role	12-char ASCII		SC_ROLE
Lead Chiller Ctrl Point	NNN.n	degF	LEAD_CP
Lag Chiller Ctrl Point	NNN.n	degF	LAG_CP
Control Point	NNN.n	degF	CTRL_PNT
Cool Entering Fluid-Slave	NNN.n	degF	COOLEWTS
Cool Leaving Fluid-Slave	NNN.n	degF	COOLLWTS
Cooler Entering Fluid	NNN.n	degF	COOL_EWT
Cooler Leaving Fluid	NNN.n	degF	COOL_LWT
Lead/Lag Leaving Fluid	NNN.n	degF	DUAL_LWT
Percent Avail.Capacity	NNN	%	CAP_A
Percent Avail.Cap.Slave	NNN	%	CAP_A_S
Lag Start Delay Time	5-char ASCII		LAGDELAY
Load/Unload Factor	NNN		SMZ
Load/Unload Factor-Slave	NNNN		SMZSLAVE
Lead SMZ Clear Commanded	No/Yes		LEADSMZC
Lag SMZ Clear Commanded	No/Yes		LAG_SMZC
Lag Commanded Off?	No/Yes		LAG_OFF
Dual Chill Lead CapLimit	NNN.n	%	DCLDCAPL
Dual Chill Lag CapLimit	NNN.n	%	DCLGCAPL

APPENDIX B — CCN TABLES (cont)

CCN CONFIGURATION TABLES — UNIT (Unit Configuration)

DESCRIPTION	VALUE	DEFAULT	UNITS	POINT NAME
Unit Type	N			UNIT_TYP
Unit Size	NNN		tons	SIZE
Compressor A1 Size	NNN		tons	SIZE_A1
Compressor A2 Size	NNN		tons	SIZE_A2
Compressor A3 Size	NNN		tons	SIZE_A3
Suction Superheat Setpt	NN.n		deltaF	SH_SP
Compressor A1 Digital?	No/Yes			CPA1TYPE
Maximum A1 Unload Time	NN		secs	MAXULTME

CCN CONFIGURATION TABLES — OPTIONS1 (Options 1 Configuration)

DESCRIPTION	VALUE	DEFAULT	UNITS	POINT NAME
Cooler Fluid	N			FLUIDTYP
Minimum Load Vlv Select	No/Yes			MLV_FLG
Return Gas Sensor Enable	Dsable/Enable			RGT_ENA
Enable OAT Sensor	Dsable/Enable			OAT_ENA
Dischrge Gas Temp Enable	Dsable/Enable			DISGASEN
CSB Boards Enable	Dsable/Enable			CSB_ENA
Reverse Rotation Enable	Dsable/Enable			REVR_ENA
Cooler Pump Control	Off/On			CPC
Cooler Pump Shutdown Dly	NN		mins	PUMP_DLY
EMM Module Installed	No/Yes			EMM_BRD
Enable Condenser Pump	N			CONDPMPPE
Enable Cond Wtr Sensors	Dsable/Enable			CONDWTRS
Enable Cond Flow Switch	Dsable/Enable			CONDFLSW

CCN CONFIGURATION TABLES — OPTIONS2 (Options 2 Configuration)

DESCRIPTION	VALUE	DEFAULT	UNITS	POINT NAME
Control Method	N			CONTROL
Loading Sequence Select	N			SEQ_TYPE
Lead/Lag Circuit Select	N			LEAD_TYP
Cooling Setpoint Select	N			CLSP_TYP
Ramp Load Select	Dsable/Enable			RAMP_EBL
High LCW Alert Limit	NN.n		deltaF	LCW_LMT
Minutes off time	NN		mins	DELAY
Deadband Multiplier	N.n			Z_GAIN
Ice Mode Enable	Dsable/Enable			ICE_CNFG

CCN CONFIGURATION TABLES — SCHEDOVR (Timed Override Setup)

DESCRIPTION	VALUE	DEFAULT	UNITS	POINT NAME
Schedule Number	NN	1		SCHEDNUM
Override Time Limit	N	0	hours	OTL
Timed Override Hours	N	0	hours	OVR_EXT
Timed Override	No/Yes	No		TIMEOVER

APPENDIX B — CCN TABLES (cont)

CCN CONFIGURATION TABLES — RESETCON (Temperature Reset and Demand Limit)

DESCRIPTION	VALUE	DEFAULT	UNITS	POINT NAME
COOLING RESET				
Cooling Reset Type	N	0		CRST_TYP
4-20 MA RESET				
4-20 - Degrees Reset	NNN.n		deltaF	420_DEG
REMOTE RESET				
Remote - No Reset Temp	NNN.n		degF	REM_NO
Remote - Full Reset Temp	NNN.n		degF	REM_FULL
Remote - Degrees Reset	NNN.n		deltaF	REM_DEG
RETURN TEMPERATURE RESET				
Return - No Reset Temp	NNN.n		deltaF	RTN_NO
Return - Full Reset Temp	NNN.n		deltaF	RTN_FULL
Return - Degrees Reset	NNN.n		deltaF	RTN_DEG
DEMAND LIMIT				
Demand Limit Select	N			DMD_CTRL
Demand Limit at 20 mA	NNN		%	DMT20MA
Loadshed Group Number	NN			SHED_NUM
Loadshed Demand Delta	NN		%	SHED_DEL
Maximum Loadshed Time	NNN		mins	SHED_TIM
Demand Limit Switch 1	NNN		%	DLSWSP1
Demand Limit Switch 2	NNN		%	DLSWSP2

CCN CONFIGURATION TABLES — DUALCHIL (Dual Chiller Configuration Settings)

DESCRIPTION	VALUE	DEFAULT	UNITS	POINT NAME
LEAD/LAG				
Lead/Lag Chiller Enable	Dsable/Enable			LL_ENA
Master/Slave Select	Master/Slave			MS_SEL
Slave Address	NNN			SLV_ADDR
Lead/Lag Balance Select	N			LL_BAL
Lead/Lag Balance Delta	NNN		hours	LL_BAL_D
Lag Start Delay	NN		mins	LL_DELAY
Parallel Configuration	No/Yes			PARALLEL

CCN CONFIGURATION TABLES — DISPLAY (Marquee Display SETUP)

DESCRIPTION	VALUE	DEFAULT	UNITS	POINT NAME
Service Password	NNNN			PASSWORD
Password Enable	Dsable/Enable			PASS_EBL
Metric Display	Off/On			DISPUNIT
Language Selection	N			LANGUAGE

CCN CONFIGURATION TABLES — HPA

DESCRIPTION	VALUE	DEFAULT	UNITS	POINT NAME
SCT Delta for Comp A1	NNN.n		deltaF	A1SCTDT
SCT Delta for Comp A2	NNN.n		deltaF	A2SCTDT

APPENDIX B — CCN TABLES (cont)

CCN SERVICE TABLES — SERVICE

DESCRIPTION	VALUE	DEFAULT	UNITS	POINT NAME
SERVICE				
Brine Freeze Point	NNN.n		degF	BRN_FRZ
COMPRESSOR ENABLE				
Enable Compressor A1	Dsable/Enable			ENABLEA1
Enable Compressor A2	Dsable/Enable			ENABLEA2
Enable Compressor A3	Dsable/Enable			ENABLEA3

CCN SETPOINT TABLES — SETPOINT

DESCRIPTION	VALUE	DEFAULT	UNITS	POINT NAME
COOLING				
Cooling Setpoint 1	NNN.n		degF	CSP1
Cooling Setpoint 2	NNN.n		degF	CSP2
ICE Setpoint	NNN.n		degF	CSP3
RAMP LOADING				
Cooling Ramp Loading	N.n			CRAMP
Brine Freeze Point	NNN.n		degF	BRN_FRZ

START-UP CHECKLIST FOR 30MP LIQUID CHILLER

(Remove and use for job file.)

A. Preliminary Information

JOB NAME _____

LOCATION _____

INSTALLING CONTRACTOR _____

DISTRIBUTOR _____

START-UP PERFORMED BY _____

EQUIPMENT: Chiller: MODEL NO. _____ SERIAL NO. _____

COMPRESSORS:

CIRCUIT A

MODEL NO. _____

SERIAL NO. _____

B. Preliminary Equipment Check (Yes or No)

IS THERE ANY SHIPPING DAMAGE? _____ IF SO, WHERE _____

WILL THIS DAMAGE PREVENT UNIT START-UP? _____

CHECK POWER SUPPLY. DOES IT AGREE WITH UNIT? _____

HAS THE CIRCUIT PROTECTION BEEN SIZED AND INSTALLED PROPERLY? (refer to Installation Instructions) _____

ARE THE POWER WIRES TO THE UNIT SIZED AND INSTALLED PROPERLY? (refer to Installation Instructions) _____

HAS THE GROUND WIRE BEEN CONNECTED? _____

ARE ALL ELECTRICAL TERMINALS TIGHT? _____

ON BRINE UNITS, HAS THE COOLER FLUID BEEN PROPERLY PROTECTED FROM FREEZING TO AT LEAST 15° F (8.3° C) BELOW THE LOWEST ANTICIPATED LEAVING FLUID TEMPERATURE SET POINT?

HAVE THE MAIN BASE BOARD, ENERGY MANAGEMENT MODULE (OPTION) AND CONTROL RELAY CONNECTIONS BEEN CHECK FOR TIGHTNESS? _____

C. Unit Start-Up (insert check mark as each item is completed)

- CHILLER HAS BEEN PROPERLY INTERLOCKED WITH THE AUXILIARY CONTACTS OF THE CHILLED FLUID PUMP STARTER.
- CHILLER HAS BEEN PROPERLY INTERLOCKED WITH THE AUXILIARY CONTACTS OF THE CONDENSER WATER PUMP STARTER.
- CRANKCASE HEATERS HAVE BEEN ENERGIZED FOR A MINIMUM OF **24 HOURS** PRIOR TO START-UP. (30MPA UNITS ONLY)
- COMPRESSOR OIL LEVEL IS CORRECT.
- LIQUID LINE SERVICE VALVE IS BACKSEATED (30MPA UNITS ONLY).
- SET POINT SHOULD BE ADJUSTED TO THE DESIRED COOLER LEAVING FLUID TEMPERATURE. (refer to installation instructions).
- LEAK CHECK **THOROUGHLY**: CHECK ALL COMPRESSORS, CONDENSER MANIFOLDS AND HEADERS, TXVs, SOLENOID VALVES, FILTER DRIERS, FUSIBLE PLUGS, THERMISTORS, AND COOLER CONNECTIONS USING ELECTRONIC LEAK DETECTOR.
- LOCATE, REPAIR, AND REPORT ANY REFRIGERANT LEAKS.
- CHECK VOLTAGE IMBALANCE: AB _____ AC _____ BC _____
AB + AC + BC (divided by 3) = AVERAGE VOLTAGE = _____ V
MAXIMUM DEVIATION FROM AVERAGE VOLTAGE = _____
VOLTAGE IMBALANCE = $\frac{(\text{MAX. DEVIATION})}{\text{AVERAGE VOLTAGE}} \times 100 = \text{_____ \% VOLTAGE IMBALANCE}$

IF OVER 2% VOLTAGE IMBALANCE, DO NOT ATTEMPT TO START CHILLER!
CALL LOCAL POWER COMPANY FOR ASSISTANCE.
- INCOMING POWER VOLTAGE TO CHILLER MODULES IS WITHIN RATED UNIT VOLTAGE RANGE.

SYSTEM FLUID VOLUME IN LOOP: _____ GAL (L)

REFER TO INSTALLATION INSTRUCTIONS FOR MINIMUM FLUID VOLUME

C. Unit Start-Up (cont)

CHECK PRESSURE DROP ACROSS COOLER.

FLUID ENTERING COOLER: _____ PSIG (kPa)

FLUID LEAVING COOLER: _____ PSIG (kPa)

(PSIG DIFFERENCE) x 2.31 = FT OF FLUID PRESSURE DROP = _____

PLOT COOLER PRESSURE DROP ON PERFORMANCE DATA CHART (LOCATED IN INSTALLATION INSTRUCTIONS LITERATURE) TO DETERMINE TOTAL GPM (L/s).

TOTAL GPM (L/s) = _____ UNIT'S RATED MIN GPM (L/s) = _____

JOB'S SPECIFIED GPM (L/s) (if available): _____

NOTE: IF UNIT HAS LOW FLUID FLOW, FIND SOURCE OF PROBLEM: CHECK FLUID PIPING, IN-LINE FLUID STRAINER, SHUT-OFF VALVES, CWP ROTATION, ETC.

COOLER LOOP FREEZE PROTECTION IF REQUIRED:

GALLONS (LITERS) ADDED: _____

PIPING INCLUDES ELECTRIC TAPE HEATERS IF PIPING IS EXPOSED TO TEMPERATURES BELOW FREEZING (Y/N): _____

COOLER/CONDENSER PROTECTION:

IN-LINE MINIMUM 40-MESH STRAINER INSTALLED WITHIN 10 FT OF THE COOLER/CONDENSER WATER INLET.

COOLER: YES _____ NO _____

CONDENSER: YES _____ NO _____

VISUALLY CHECK MAIN BASE BOARD FOR THE FOLLOWING:

- INSPECT ALL THERMISTORS AND TRANSDUCERS FOR POSSIBLE CROSSED WIRES.
- CHECK TO BE SURE ALL WELL-TYPE THERMISTORS ARE FULLY INSERTED INTO THEIR RESPECTIVE WELLS.

TO START THE CHILLER:

TURN THE EMERGENCY ON/OFF SWITCH (SW2) TO ON POSITION.

TURN THE ENABLE/OFF/REMOTE CONTACT SWITCH (SW1) TO THE ENABLE POSITION.

IF EQUIPPED WITH THE OPTIONAL SCROLLING MARQUEE, LEAVE THE ENABLE/OFF/REMOTE CONTACT SWITCH (SW1) IN THE OFF POSITION.

NOTE: USE ESCAPE KEY TO GO UP ONE LEVEL IN THE STRUCTURE.

USE ARROW/ESCAPE KEYS TO ILLUMINATE RUN STATUS LED. PRESS ENTER KEY UNTIL 'VERS' IS DISPLAYED. PRESS ENTER KEY. RECORD INFORMATION ON THE FOLLOWING PAGE.

C. Unit Start-Up (cont)

Record Software Versions MODE — RUN STATUS

VERS	SOFTWARE VERSION NUMBERS		
	AUX	CESR131333-xx-xx	
	MBB	CESR131279-xx-xx	
	EMM	CESR131174-xx-xx	
	MARQ	CESR131171-xx-xx	
	NAVI	CESR130227-xx-xx	

(PRESS ENTER AND ESCAPE SIMULTANEOUSLY TO OBTAIN SOFTWARE VERSIONS)

USE ARROW/ESCAPE KEYS TO ILLUMINATE CONFIGURATION LED. PRESS ENTER KEY. RECORD INFORMATION BELOW.

UNIT (Configuration Settings)

SUBMODE	ITEM	ITEM EXPANSION	DISPLAY	ENTRY
UNIT		UNIT CONFIGURATION		
	SIZE	UNIT SIZE	XXX	
	SZA.1	COMPRESSOR A1 SIZE	XX	
	SZA.2	COMPRESSOR A2 SIZE	XX	
	SZA.3	COMPRESSOR A3 SIZE	XX	
	A1.TY	COMPRESSOR A1 DIGITAL?	NO/YES	
	MAX.T	MAXIMUM A1 UNLOAD TIME	XX	

PRESS ESCAPE KEY TO DISPLAY 'UNIT'. PRESS DOWN ARROW KEY TO DISPLAY 'OPT1'.
PRESS ENTER KEY. RECORD CONFIGURATION INFORMATION BELOW:

OPTIONS1 (Options Configuration)

SUBMODE	ITEM	ITEM EXPANSION	DISPLAY	ENTRY
OPT1		UNIT OPTIONS 1 HARDWARE		
	FLUD	COOLER FLUID	X	
	MLV.S	MINIMUM LOAD VALVE SELECT	NO/YES	
	RG.EN	RETURN GAS SENSOR ENABLE	ENBL/DSBL	
	OAT.E	ENABLE OAT SENSOR	ENBL/DSBL	
	D.G.EN	DISCHARGE GAS TEMP ENABLE	ENBL/DSBL	
	CSB.E	CSB BOARDS ENABLE	ENBL/DSBL	
	CPC	COOLER PUMP CONTROL	ON/OFF	
	PM.DY	COOLER PUMP SHUTDOWN DLY	XX MIN	
	DPME	ENABLE CONDENSER PUMP	ENBL/DSBL	
	DFLS	ENABLE COND FLOW SWITCH	ENBL/DSBL	
	CDWS	ENABLE COND WTR SENSORS	ENBL/DSBL	

PRESS ESCAPE KEY TO DISPLAY 'OPT1'. PRESS DOWN ARROW KEY TO DISPLAY 'OPT2'.
PRESS ENTER KEY.

RECORD CONFIGURATION INFORMATION ON NEXT PAGE.

C. Unit Start-Up (cont)

OPTIONS2 (Options Configuration)

SUBMODE	ITEM	ITEM EXPANSION	DISPLAY	ENTRY
OPT2		UNIT OPTIONS 2 CONTROLS		
	CTRL	CONTROL METHOD	X	
	LCWT	HIGH LCW ALERT LIMIT	XX.X ΔF	
	DELY	MINUTES OFF TIME	XX	
	ICE.M	ICE MODE ENABLE	ENBL/DSBL	

PRESS ESCAPE KEY TO DISPLAY 'OPT2'. PRESS DOWN ARROW KEY TO DISPLAY 'CCN'. PRESS ENTER KEY.

RECORD CONFIGURATION INFORMATION BELOW.

CCN (CCN Network Configuration)

SUB-MODE	ITEM	ITEM EXPANSION	DISPLAY	ENTRY
CCN	CCNA	CCN ADDRESS	XXX	
	CCNB	CCN BUS NUMBER	XXX	
	BAUD	CCN BAUD RATE	X	

PRESS ESCAPE KEY SEVERAL TIMES TO GET TO THE MODE LEVEL (BLANK DISPLAY). USE THE ARROW KEYS TO SCROLL TO THE SET POINT LED. PRESS ENTER TO DISPLAY SETPOINTS. RECORD CONFIGURATION INFORMATION BELOW:

SETPOINT

SUBMODE	ITEM	ITEM EXPANSION	DISPLAY	ENTRY
COOL		COOLING SETPOINTS		
	CSP.1	COOLING SETPOINT 1	XXX.X °F	
	CSP.2	COOLING SETPOINT 2	XXX.X °F	
	CSP.3	ICE SETPOINT	XXX.X °F	
HEAD		HEAD PRESSURE SETPOINTS		
	H.DP	HEAD SET POINT	XXX.X °F	
FRZ		BRINE FREEZE SETPOINT		
	BR.FZ	BRINE FREEZE POINT	XXX.X °F	

COMPONENT TEST

USE ESCAPE/ARROW KEYS TO ILLUMINATE CONFIGURATION LED. PRESS ENTER TO DISPLAY 'DISP'. PRESS ENTER AGAIN TO DISPLAY 'TEST' FOLLOWED BY 'OFF'. PRESS ENTER TO STOP DISPLAY AT 'OFF' AND ENTER AGAIN SO 'OFF' DISPLAY FLASHES. 'PASS' AND 'WORD' WILL FLASH IF PASSWORD NEEDS TO BE ENTERED. PRESS ENTER TO DISPLAY PASSWORD FIELD AND USE THE ENTER KEY FOR EACH OF THE FOUR PASSWORD DIGITS. USE ARROW KEYS IF PASSWORD IS OTHER THAN STANDARD. AT FLASHING 'OFF' DISPLAY, PRESS THE UP ARROW KEY TO DISPLAY 'ON' AND PRESS ENTER. ALL LED SEGMENTS AND MODE LEDS WILL LIGHT UP. PRESS ESCAPE TO STOP THE TEST. PRESS ESCAPE TO RETURN TO THE 'DISP' DISPLAY. PRESS THE ESCAPE KEY AGAIN AND USE THE ARROW KEYS TO ILLUMINATE THE SERVICE TEST LED. PRESS ENTER TO DISPLAY 'TEST'. PRESS ENTER TO STOP DISPLAY AT 'OFF' AND ENTER AGAIN SO 'OFF' FLASHES. PRESS THE UP ARROW KEY AND ENTER TO ENABLE THE MANUAL MODE. PRESS ESCAPE AND DISPLAY NOW SAYS 'TEST' 'ON'. TURN SWITCH (SW1) TO THE ENABLE POSITION.

PRESS THE DOWN ARROW TO DISPLAY 'OUTS'. PRESS THE ENTER KEY TO DISPLAY 'LL.SV'. PRESS THE ENTER KEY TO STOP DISPLAY AT 'OFF' AND ENTER AGAIN SO 'OFF' FLASHES. PRESS THE UP ARROW KEY AND ENTER TO TURN THE OUTPUT ON. PRESS ENTER SO THE 'ON' DISPLAY FLASHES, PRESS THE DOWN ARROW KEY AND THEN ENTER TO TURN THE OUTPUT OFF. OUTPUTS WILL ALSO BE TURNED OFF OR SENT TO 0% WHEN ANOTHER OUTPUT IS TURNED ON. CHECK OFF THE ITEMS IN THE SERVICE TEST TABLE ON THE NEXT PAGE THAT APPLY AFTER BEING TESTED.

C. Unit Start-Up (cont)

USE ESCAPE KEY TO RETURN TO 'OUTS' DISPLAY. PRESS DOWN ARROW TO DISPLAY 'CMPA'. PRESS ENTER KEY TO DISPLAY 'CC.A1'. NOTE THAT UNLOADERS AND HOT GAS BYPASS SOLENOIDS CAN BE TESTED BOTH WITH AND WITHOUT COMPRESSOR(S) RUNNING. MAKE SURE ALL SERVICE VALVES ARE OPEN AND COOLER/CONDENSER PUMPS HAVE BEEN TURNED ON BEFORE STARTING COMPRESSORS. CHECK OFF EACH ITEM AFTER SUCCESSFUL TEST. THE CONTROL WILL ONLY START ONE COMPRESSOR PER MINUTE. WHEN AT THE DESIRED ITEM, PRESS THE ENTER KEY TWICE TO MAKE THE 'OFF' FLASH. PRESS THE UP ARROW KEY AND ENTER TO TURN THE OUTPUT ON. CHECK OFF THE ITEMS IN THE SERVICE TEST TABLE BELOW THAT APPLY AFTER BEING TESTED.

SERVICE TEST

SUB-MODE	KEYPAD ENTRY	ITEM	DISPLAY	ITEM EXPANSION	COMMENT	Completed (Yes/No)
TEST	ENTER		ON/OFF	SERVICE TEST MODE	To Enable Service Test Mode, move Enable/Off/Remote Contact switch to OFF. Change TEST to ON. Move switch to ENABLE.	
		OUTPUTS AND PUMPS				
OUTS	ENTER	CLR.P	ON/OFF	COOLER PUMP RELAY		
	↓	CND.P	ON/OFF	CONDENSER PUMP		
	↓	UL.TM	0 TO 15	COMP A1 UNLOAD TIME		
	↓	CC.H	ON/OFF	CRANKCASE HEATER		
	↓	CW.VO	ON/OFF	CONDENSER VALVE OPEN		
	↓	CW.VC	ON/OFF	CONDENSER VALVE CLOSE		
	↓	LL.SV	ON/OFF	LIQUID LINE SOLENOID		
	↓	RMT.A	ON/OFF	REMOTE ALARM RELAY		
CMPA	CIRCUIT A COMPRESSOR TEST					
	ENTER	CC.A1	ON/OFF	COMPRESSOR A1 RELAY		
	↓	UL.TM	0 TO 15	COMP A1 UNLOAD TIME		
	↓	CC.A2	ON/OFF	COMPRESSOR A2 RELAY		
	↓	CC.A3	ON/OFF	COMPRESSOR A3 RELAY		
	↓	MLV	ON/OFF	MINIMUM LOAD VALVE RELAY		

USE ARROW/ESCAPE KEYS TO ILLUMINATE THE TEMPERATURES LED. PRESS ENTER TO DISPLAY 'UNIT'. PRESS ENTER AND USE THE ARROW KEYS TO RECORD TEMPERATURES FOR SENSORS BELOW.

TEMPERATURE

CLWT _____

CEWT _____

CDET _____

CDLT _____

OAT or DLWT _____

SPT _____

C. Unit Start-Up (cont)

ALL UNITS:

MEASURE THE FOLLOWING (MEASURE WHILE MACHINE IS IN A STABLE OPERATING CONDITION):

CIRCUIT A

DISCHARGE PRESSURE	_____
SUCTION PRESSURE	_____
DISCHARGE LINE TEMP	_____
SUCTION LINE TEMP	_____
SATURATED COND TEMP	_____
COOLER ENTERING FLUID	_____
COOLER LEAVING FLUID	_____
CONDENSER ENTERING FLUID	_____
CONDENSER LEAVING FLUID	_____

CHECK AND ADJUST SUPERHEAT AS REQUIRED.

Free Manuals Download Website

<http://myh66.com>

<http://usermanuals.us>

<http://www.somanuals.com>

<http://www.4manuals.cc>

<http://www.manual-lib.com>

<http://www.404manual.com>

<http://www.luxmanual.com>

<http://aubethermostatmanual.com>

Golf course search by state

<http://golfingnear.com>

Email search by domain

<http://emailbydomain.com>

Auto manuals search

<http://auto.somanuals.com>

TV manuals search

<http://tv.somanuals.com>