

COBY

OPERATION MANUAL

CX-CD425 MINI CD HOME STEREO SYSTEM WITH AM/FM DIGITAL TUNER

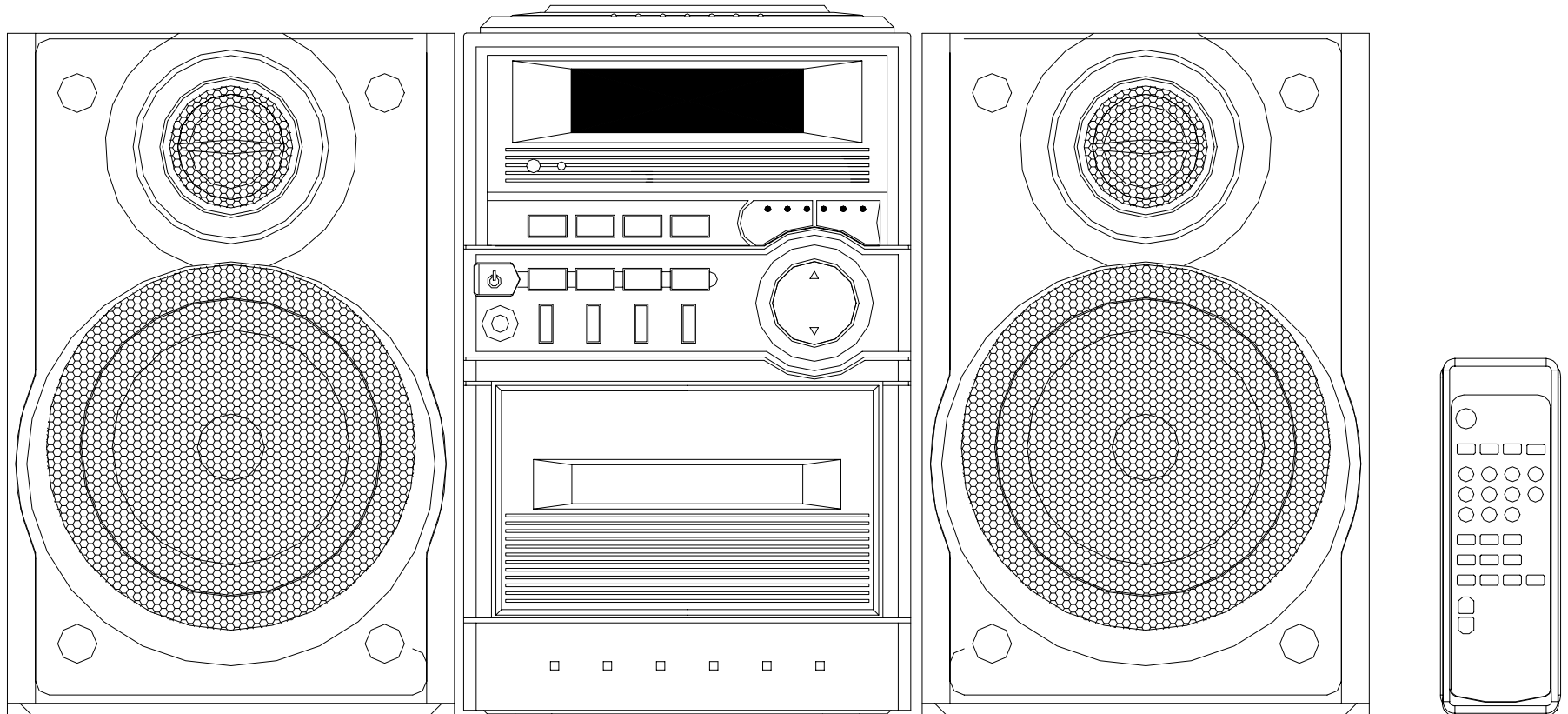

Safety Precautions

- * This product is designed for use in moderate climates. Do not use or install this unit where it would be exposed to direct sunlight or in extremely hot temperatures, or near a radiator, stove or appliance that produces heat.
- * Do not take this unit into the bathroom, or near a swimming pool. Do not use it where it would be exposed to water, moisture, dripping or splashing.
- * No objects filled with liquids, such as vases, shall be placed on the product.
- * No naked flame sources, such as lighted candles, should be placed on the product.
- * If water gets inside the unit. Unplug the power cord from the supply socket and consult your dealer.
- * Do not handle the power cord with wet hands. To avoid electric shock, NEVER touch any internal parts. Repairs/Service should be left to qualified service personnel.
- * When connecting or disconnecting from the mains supply, hold the plug, not the cord. Pulling the cord may damage it and could be dangerous.
- * Do not drop the unit, spill liquid into it or allow objects to fall in it.
- * If the unit fails to operate, disconnect from the mains and consult qualified service personnel.
- * When plugged in, a very small current will flow. To save electricity and for safety when not using the unit for an extended period of time, it is recommended that the product is completely disconnected at the AC mains socket.
- * Consult your nearest dealer when damage, disconnection or contact failure is found with the cord.
- * Do not bend the cord sharply, pull or twist it.
- * Do not modify the power cord in any manner.
- * Do not insert any metallic object into the unit.
- * Unplug the power cord when there is the possibility of lightning.

Positioning the unit

- * A minimum distance of 6 INCHES must be maintained to provide sufficient ventilation.
- * Allow adequate ventilation for the unit ventilation should not be impeded by covering the ventilation openings with items such as newspapers, table cloths, curtains etc. Do not stand it on a thick pile carpet, or install it in a place with poor air flow.
- * Place the unit on a flat even surface.
- * Do not use the unit in excessively hot, cold, dusty, damp or humid place.
- * Condensation may form inside the CD player if the unit is left anywhere warm and damp, or if you move the unit from somewhere cold (e.g. Your car boot) to a warm room. In this case, let the unit stand for 1-2 hours, or gradually increase the room temperature so the unit is dry before you use it.
- * Do not place it where it could be subject to vibration.
- * Do not place it where it could be magnetised by a magnet or speaker since there are magnets in the speakers, do not place tapes or magnetic cards on them as recorded data could be erased.
- * When this unit is used near a TV, the TV picture could be distorted. If this happens, move the unit away from the TV. If this does not correct the situation, avoid using the unit when the TV is turned on.
- * Keep the CD door closed so the lens is not contaminated by dust. Do not touch the lens.

Safety Mechanism:

This unit incorporates a safety interlock mechanism which switches the laser beam on and off, so that when the disc holder is open, the laser beam stops automatically.

Technical specifications

General

Power Supply	AC 230V ~ 50 Hz AC 110V/220V ~ 60/50 Hz (option)
Output Power	2.5 Watt RMS per channel 5.0 Watt RMS per channel (option)
Main Unit Dimension	220 (L) X 160 (W) X 250 (H) mm
Speaker Box Dimension	197 (L) X 160 (W) X 246 (H) mm
Net Weight	4 Kgs with Plastic Speaker Boxes 6 Kgs with Wooden Speaker Boxes (option)

Radio frequency coverage

FM	88 - 108 MHz
AM/MW	540 - 1600 KHz 530 - 1710 KHz (option)

CD Player

Optical Pick Up	3 beams, Semi-conductor Laser
Frequency Response	100Hz - 16 KHz

Cassette Player

Tape Speed	4.75 CM/Sec.
Frequency Response	125 Hz - 8 KHz
Bias System	DC Bias

Speaker Section

Speakers :	3.5" Full Range Speaker X 2 2" Tweeter Speaker X 2 (option)
Impedance :	4 Ohms.
Headphones :	3.5mm stereo jack plug, 8-32 Ohms

Care & Maintenance

Cleaning CDs

Use a soft cloth to wipe off any fingerprints and dust from the disc surface. Wipe in a straight line from the centre to the outside of the disc. Small dust particles and light stains will not affect reproduction quality.

- * Never use chemicals such as record sprays, anti-static sprays, benzine or thinners to clean your CDs.
- * To reduce the risk of scratches, always put CDs back in their cases after use.
- * Do not expose CDs to direct sunlight, high humidity or high temperatures for long periods.
- * Do not stick paper or write anything on either side of the CD.
- * Only discs displaying this symbol can be played on this unit.

Cleaning the Lens

A dirty lens will cause sound skipping and, if the lens is very dirty, the CD may not work. Open the CD door and clean the lens as follows:

- * Unplug the power supply.
- * Dust or Dry Particles:
Using a camera lens brush/blower, blow on the lens a couple of times, then wipe it lightly with the brush to remove dust. Then blow on the lens once more.
- * Finger Prints:
If the lens cannot be cleaned by using a brush/blower, use a dry cotton swab and starting in the middle work to the outside edge.

Preparation for use

Carefully unpack the unit from its carton (do not attempt to connect anything at this stage). You should have the following items:

Packing included

1. This User Guide.
2. Main Unit with built in AC plug.
3. Two Speakers Box.
4. Remote Control (batteries not included).

If any these items is missing, consult your dealer. Keep any packaging in case you want to transport the Main unit at some later date.

Connections

- * Connect the speakers to the speaker sockets on the back of the main unit.
- * Connect the right speaker to the right socket and left speaker to the left socket. Connect the left/right speaker lead wires to the speaker terminals. Pay attention to the polarity. The polarity wires (Red wire or Black wire with White stripe) should connect to the red colour (+) terminals. The Black wire should connect to the black colour (-) terminals.
- * Connect the AC Power cord to the AC outlet.
- * Unwind the FM antenna.

AC Power Operation

- * If you wish to power your Main unit from the mains, find a location that is close to and within easy access of a mains socket. Do not stretch the cable - if you cannot reach a supply you should find an alternative location for the system.
- * Connect the AC power cord into a suitable outlet and switch on at the mains plug if the socket has a switch.

Switching on Main Power

Your System comes fitted with a mains power cable and plug.

Plug into the mains socket and switch on. Ensure the voltage is compatible. The Power **Standby** LED Indicator will On and LCD display the Timer.

Press the **Power Button** to turn on your system. The Power **Standby** LED Indicator will Off and LCD become On and display the previously selected function.

When not in use, switch off and unplug your system from the mains power.

Adjusting the sound

To adjust the sound level turn the **Volume** control located on the right side of your system.

- Press the VOLUME "Up" or "Down" to get a satisfactory sound level when you select the desired program.
- Press the **Mute** button to muting the sound.

Using Headphones

Plug your headphones into the headphones socket located in the middle of your system on the left hand side.

The sound will be hear through the headphones, *not* the speakers.

Please note :

Headphones should have a 3.5mm diameter stereo plug and an impedance of 8-32 ohms.

Location of Controls

FRONT VIEW

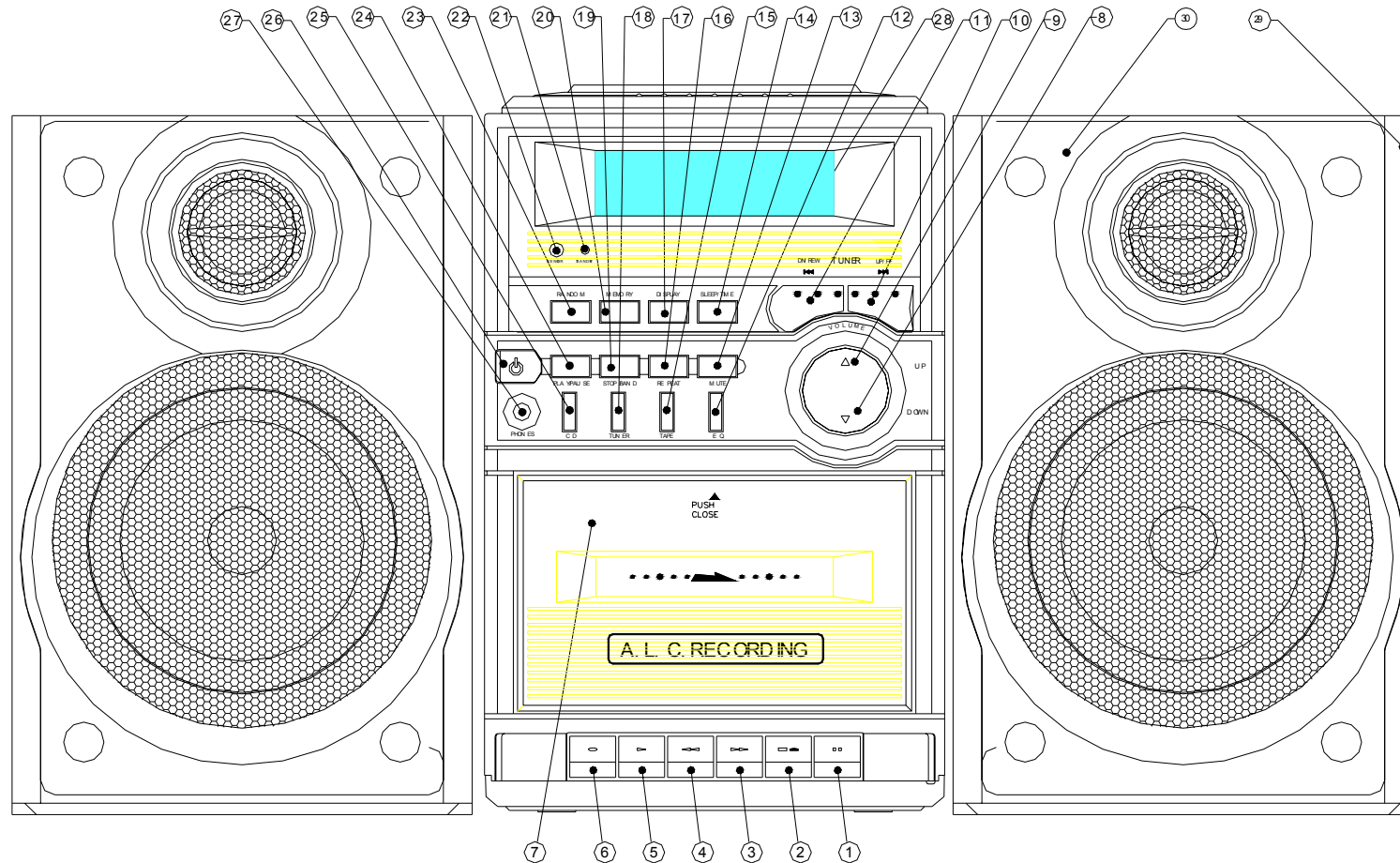

Location of Controls (Cont.)

SIDE VIEW

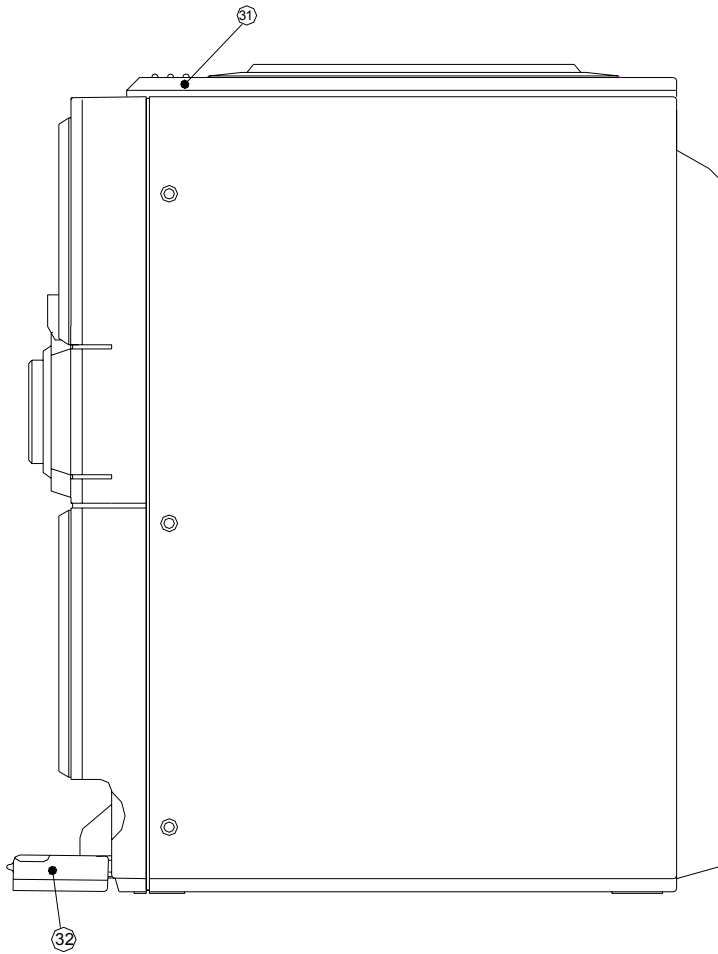

REAR VIEW

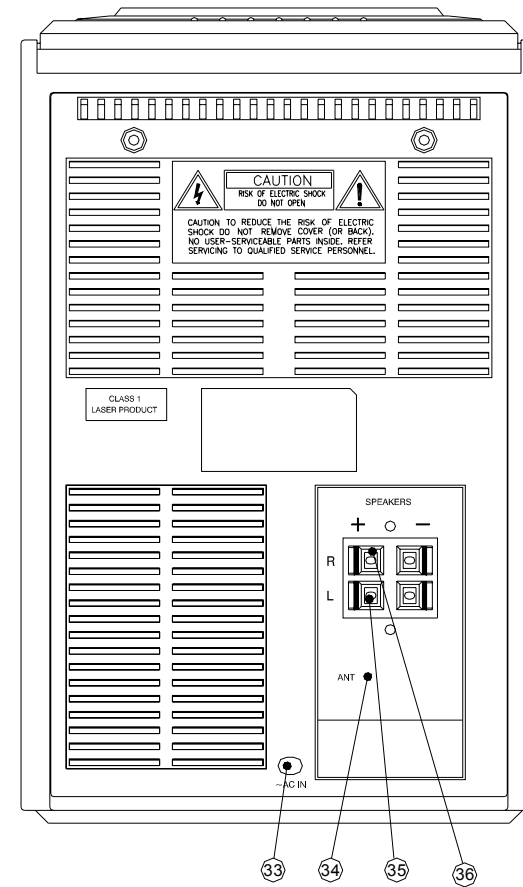

Location of Controls (Cont.)

1. PAUSE BUTTON
2. STOP & EJECT BUTTON
3. FAST FORWARD BUTTON
4. REWIND BUTTON
5. PLAY BUTTON
6. RECORDING BUTTON
7. CASSETTE COMPARTMENT
8. VOLUME DOWN : Press to adjust sound level down.
9. VOLUME UP : Press to adjust sound level up.
10. UP/FF : CD - Skip/Search forward or
TUNER - Radio frequency tuning up.
11. DN/REW : CD - Skip/Search backward or
TUNER - Radio frequency tuning down.
12. EQ : Press to select EQ mode (FLAT/CLASSIC/ROCK/POP).
13. MUTE : Press to muting the sound.
14. SLEEP/TIMER : SLEEP - Press to select sleep function or
TIMER - Press to switch Timer function on or off.
15. TAPE : Press to select Tape mode.
16. REPEAT/PRESET : CD - Repeat play or
TUNER - To select preset station
17. DISPLAY : Press to display the Clock Time or Timer.
18. TUNER : Press to select Tuner mode.
19. STOP/BAND : STOP - CD Stop.
BAND - Press to select MW (AM)/FM band in Tuner mode.
20. MEMORY : CD - Press to program the CD tracks.
TUNER - Press to program the Radio stations.
21. POWER STANDBY INDICATOR
22. REMOTE CONTROL SENSOR
23. RANDOM : CD Random play.
24. PLAY/PAUSE : CD Play/Pause.
25. CD : Press to select CD mode.
26. POWER : ON/OFF-Standby button
27. HEADPHONE JACK
28. LCD DISPLAY
29. SPEAKER BOX
30. SPEAKER FRONT COVER
31. CD OPEN/CLOSE CONTROL DOOR
32. TAPE CONTROL DOOR (FLIP DOWN)
33. AC POWER CORD
34. FM ANTENNA WIRE
35. SPEAKER SOCKET (LEFT)
36. SPEAKER SOCKET (RIGHT)

Location of Controls (Cont.)

Remote Control (28 Keys)

Front View

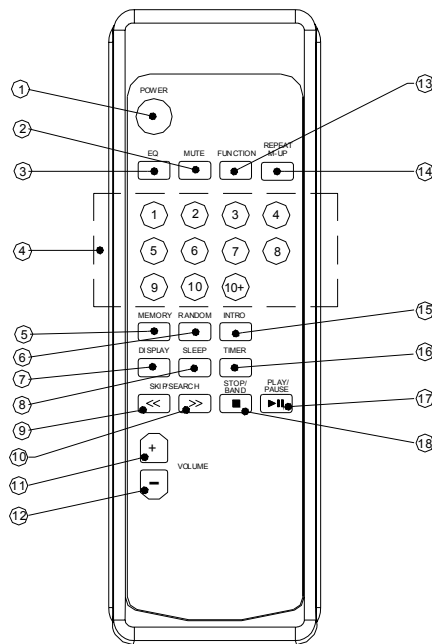

Rear View

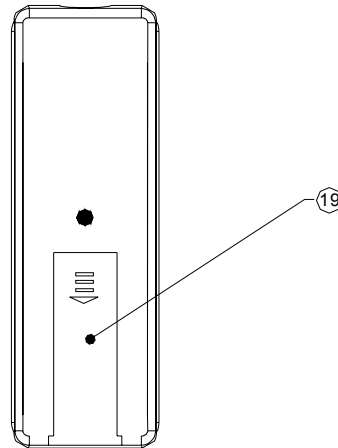

1. POWER : ON/OFF-Standby button
2. MUTE : Press to muting the sound.
3. EQ : Press to select EQ mode (FLAT/CLASSIC/ROCK/POP).
4. Program select buttons
TUNER - To recall preset stations.
CD - To recall tracks.
For 1 - 9, press 1 - 9 buttons.
For 10, press 10+ and then 0 .
For 11 -19, press 10+ once then 1 - 9.
For 20, press 10+ twice and then 0 .
For 21 - 20, press 10+ twice then 1 - 9.
For 30, press 10+ three times and then 0 .
5. MEMORY : CD - Press to program the CD tracks.
TUNER - Press to program the Radio stations.
6. RANDOM : CD Random play.
7. DISPLAY : Press to display the Clock Time or Timer.
8. SLEEP : Press to select sleep function.
9. <<< : CD - Skip/Search backward / TUNER - Tuning down.
10. >>> : CD - Skip/Search forward / TUNER - Tuning up.
11. VOLUME + : Volume up
12. VOLUME - : Volume down
13. FUNCTION : Press to select CD/Tuner/Tape mode.
14. REPEAT/PRESET : CD - Repeat play or
TUNER - To select Preset station
15. INTRO : CD Intro play
16. TIMER : Press to switch Timer function on or off.
17. PLAY/PAUSE : CD Play/Pause.
18. STOP/BAND : CD Stop.
BAND : Press to select MW (AM)/FM band in Tuner mode.
19. Battery Compartment.

GENERAL OPERATION

POWER ON

When power is connected for the first time, or if the power cord was unplugged and reconnected:

- The STANDBY LED lights, and the LCD panel appears Clock Time as follows :



- Press the POWER button. The STANDBY LED turns off and the unit defaults to the FM band of tuner mode.

Afterward, when the POWER is turned on, the previously chosen function will be selected.

SETTING THE CLOCK

- At Standby mode (Power Off), press the **MEMORY** button for some seconds will access the time format change mode.
- At Normal (Standby Off) mode (Power On), press **DISPLAY** to display the clock time, then press the **MEMORY** button for some seconds will access the time format change mode.
- The actual time format will be shown in the display '12 H' or '24 H' flash continuously.
- Press the Skip/Search >> or << button to change the 12h or 24h format.

- Press the **MEMORY** button ONCE. The Minutes segments display "00" . The Hour segments flash continuously



- Press the Skip/Search >> or << button to select the desired hour.
- Press the MEMORY button again and the minute segments flash.

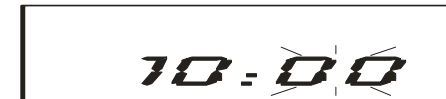

- Press the Skip/Search >> or << button to select the desired minute.
- Press the MEMORY button once more. The flashing stops and the time is set.

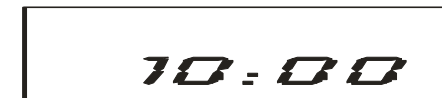

- All the time information is shown in either 12h or 24h format.
- In case of a 12-hour clock , watch the AM/PM indication.

GENERAL OPERATION (CONT.)

TIMER OPERATION

To set the wake-up timer

- Press the POWER button to turn the unit off STANDBY
 - Press DISPLAY button. The TIMER indicator appears on the LCD and flashes. Press MEMORY button the hour segment flashes.
 - Press the Skip/Search >> or << button to select the wake-up hour.
 - Press the MEMORY button again. The hour segment stops flashing, the minute segment flashes.
 - Press the Skip/Search >> or << button to select te wake-up minute.
- Press TIMER button once for timer operation. To disable timer operation, press the TIMER button again. Setting will still be kept in memory for future occasions when timer operation is desired. (Press the TIMER button again to activate.)

NOTE: The timer will turn on the function last used as follows:

- Previously selected radio station
- CD-track 1

Sleep-to-music function

- Press CD/TUNER/TAPE button to select the desired function mode.
- Press the SLEEP button. "90" displays on LCD.
- The system will remain on for 90 minutes, then turn off into standby mode automatically.
- To decrease the time in 10-minute-increments, press the SLEEP button and hold until the desired time is set.
- The SLEEP time will be displayed for about 3 seconds, then go back to original display.

TUNER OPERATION

Basic operation

- Press POWER button to turn on the power.
- Press the TUNER button and press the BAND button to select AM or FM.
- Press and release the Skip/Search >> or << button to select the desire radio station.
- Press and hold the Skip/Search >> or << button briefly to search up or down for the next receivable station. (Auto Scan)

To store favourite stations in memory

- You can store up to 10 stations for FM and 10 station for AM randomly in memory.
- Select the desired radio station as described above.
 - Press the MEMORY button. The MEMORY indicator flashes on LCD.
 - Press the PRESET / REPEAT button to assign the present number.

For example : To store a particular radio station on preset CH19, you can press the PRESET / REPEAT button 19 times. The LCD shows the preset number.

- Press the MEMORY button to store the selection. The MEMORY indicator will be disap
- Repeat steps 3 and 4 to store additional radio stations in memory.

Antenna

For best FM reception, extend the wire antenna located at the back of the unit. Move it around until you get the best FM reception.

There is a built in ferrite antenna for AM signal. Move or rotate your Main Unit to obtain the best AM reception.

Using the Cassette Player

LISTENING TO TAPE

Stop/Eject button - Press to stop all deck operations. Press again to open the Cassette Doors.

Fast Forward Button - Press to start rapid tape Fast winding in forward direction.

Fast Rewind Button - Press the to start rapid tape Fast winding in reverse direction.

Play Button - Press to start playing a tape.

Pause Button - Press to stop tape operation temporarily.
Press again to resume tape operation.

Record Button - Press together with **Play button** to start recording.

Auto Stop

When the tape reaches the end in play or record, the built-in Auto Stop system releases the depressed play, record buttons.

When the Auto Stop system operates while recording from the built-in radio or CD Player, only the cassette function is brought automatically to a stop and the radio or CD Player will continue to play.

INSERTING/REMOVING CASSETTES

- Open/Flip down the **Tape Control Door**.
- Press the **Stop/Eject Button** to open the cassette door.
- Slide the cassette tape into the door with the exposed section of the tape facing downwards.
- Push the cassette door closed and securely before starting.
- To remove a cassette, press the **Stop/Eject Button** to open the door and lift out your tape.

PLAYBACK

- Press the **TAPE** button to select Cassette Player mode .
- Insert your cassette tapes.
- Press the **Play Button** to activate playback.
- Adjust the **Volume Controls** to the desired level.
- Use **Pause Button** whenever you wanted to stop playback temporarily.
- Press the **Stop/Eject Button** when finished.

RECORDING

A. Recording from Radio to Tape

- Press the **TUNER** button to select tuner mode, and press the **STOP/BAND** button to select the desired band.
- Tune in your station and insert your cassette tapes.
- To start recording, press the **Record button and the Play button** of deck at the same time to start recording
- To stop recording, press the **Stop/Eject Button**.

B. Recording from CD to Tape

- Press the **CD** button to select CD mode.
- Insert the CD you want to record.
- Insert your cassette suitable for recording, press **Pause button** then press the **Record button and the Play button** of deck at the same time. Recording function will be stand by.
- Activate the CD player, and then press (to release) **Pause button** to start recording.
- The recording level is set automatically.
- To stop recording, first press **Stop button** on CD player, then press the **Stop/Eject Button** on the tape deck.

CAUTION

To avoid damage to the cassette mechanism or to the cassette tapes, always depress the **Stop/Eject Button** between each operation.

Using the CD Player

LOADING/PLAYING DISCS

- Press **Power Button** to switch On the unit.
- Press the **CD Button** to select CD mode.
- Open the CD door by hand gently. Do not force open the CD door by hand at any time.
- Place the CD in the compartment with the label side facing upwards.
- Close the CD door by hand. When fully closed the CD will rotate briefly. The **LCD Display** will indicate the total number of tracks on the disc.
- Once you have loaded a CD, press the **CD Play/Pause Button**. Playback will begin from track 1 on the disc you have specified to play. The **LCD Display** shows the track currently playing.
- You can open the CD door at any time by pressing the **Stop Button**. Then open the CD door by hand on the top of the player.
- Only remove the CD when it has stopped spinning.
- To stop play at any time, press the **Stop Button**.

TO INTERRUPT PLAYBACK

- To stop a track temporarily, press the **Play/Pause Button**. The disc will pause and **LCD Display** at the current paly position.
- Press the **Play/Pause Button** again to resume playback from the same point.

TO STOP PLAYBACK

- Press the **Stop Button** to stop playback at any time.

TO RANDOMING PLAY

- Press **RANDOM Button** to play the CD randoming.
- To stop play at any time, press the **Stop Button**.

Skip Forward or Backward through tracks

- The Skip/Seach function can be used at any time during play.
- To select the next track, press **Forward Skip Button**. If you are on the last track of the disc, the player will move to track 1.
- To go back to the beginning of the current track press **Backward Skip Button** *once*.
- To go back to the previous track press a the **Backward Skip Button** *twice*.
- To play a particular track, load the disc in the CD player and press **Forward Skip Button** until the track number you want is shown in the **LCD Display**.
- Press the **Play/Pause Button** to play that track.

Handle Compact Discs

- To remove a CD from its storage case, press down on the centre of the case and lift the disc out.
- Hold the disc by the edges. Avoid touching the recorded side of the disc.

Please note :

- * Do not put anything other than a CD in the compartment. Other objects can damage the mechanism.
- * Do not force open/close the CD door by and any time.
- * Keep the CD door closed when not in use to prevent dirt and dust from getting into the mechanism.
- * Never insert more than one CD at a time.
- * If a disc is deeply scratched or too dirty, it may not play.
- * This unit can playback the following media, CD/CD-R/CD-RW can Readable.

Using the CD Player (Cont.)

Programmed track selection

You can set your Mini Tower System to play a selection of tracks from your disc.

To select specific tracks

Make sure there is no CD playing.

Press the **MEMORY Button** *once*. The **LCD Display** the desired number to program.

Press **Skip/Search** Forward or Backward to display the track number you want.

Press the **MEMORY Button** *once* to select the next track. The previous track is now saved.

Repeat these steps until all the tracks you want are stored. You can select a maximum of **20** tracks. You can select a track more than once.

Press the **Play/Pause Button**. The **Program LED** indicator light up. The first programmed track of your selection starts playing.

After all the programmed tracks have been played, the CD player stops automatically.

To cancel your memorised program, press the **Stop Button** and *open* the CD door.

Please note

If during track selection, you press the **Play/Pause Button** before pressing the **PROG Button**, the track will not be stored in the memory and the disc will start playing from the first selected track.

Repeat disc play

You can set your CD player to repeat play a single track, the whole disc or your programmed track selection.

To repeat a single track

Ensure that the track is first playing by pressing the **Play/Pause Button**.

Press the **REPEAT Button** twice. The "**Repeat 1**" LED indicator light up to indicate 'track repeat' is on.

The selected track will play continuously until you press the **Stop Button**.

or press the **REPEAT Button** *once* more.

To repeat the whole disc

Ensure that the disc is first playing by pressing the **Play/Pause Button**.

Press the **REPEAT Button** once. The '**Repeat All**' LED indicator light up to indicate 'disc repeat' is on.

The entire disc will play continuously until you press the **Stop Button**.

or press the **REPEAT Button** twice more.

Using the CD Player (Cont.)

To repeat a programmed selection

Refer to section titled "Programmed Track Selection" on previous page and select your tracks.

Press **Play/Pause Button** to play your first selected track.

Press the **REPEAT Button** *twice* to repeat a particular track once. The '**Repeat 1**' LED indicator light up.

The programmed track will play continuously until you press the **Stop Button**.

or press the **REPEAT Button** *once* more.

Press the **REPEAT Button** *once* your complete selection of programmed tracks will repeat. The '**Repeat All**' LED indicator light up.

The programmed tracks will play continuously until you press the **Stop Button**.

or press the **REPEAT Button** *twice* more.

CAUTION

This product uses a laser. Avoid any direct exposure to the laser beam. Use of controls, adjustments or procedures not listed in this guide may result in hazardous exposure.

TUNER OPERATION

Basic operation

- Press POWER button to turn on the power.
- Press the TUNER button and press the BAND button to select AM or FM.
- Press and release the Skip/Search >> or << button to select the desire radio station.
- Press and hold the Skip/Search >> or << button briefly to search up or down for the next receivable station. (Auto Scan)

To store favourite stations in memory

- You can store up to 10 stations for FM and 10 station for AM randomly in memory.
- Select the desired radio station as described above.
 - Press the MEMORY button. The MEMORY indicator flashes on LCD.
 - Press the PRESET / REPEAT button to assign the present number.

For example : To store a particular radio station on preset CH19, you can press the PRESET / REPEAT button 19 times. The LCD shows the preset number.

- Press the MEMORY button to store the selection. The MEMORY indicator will be disap
- Repeat steps 3 and 4 to store additional radio stations in memory.

Antenna

For best FM reception, extend the wire antenna located at the back of the unit. Move it around until you get the best FM reception.

There is a built in ferrite antenna for AM signal. Move or rotate your Main Unit to obtain the best AM reception.

TROUBLESHOOTING

Before requesting service, check the chart below for a possible cause of the problem you are experiencing. Some simple checks or a minor adjustment on your part may eliminate the problem and restore proper operation.

If you are in doubt about some of the check points, or if the remedies indicated in the chart do not solve the problem, please consult your dealer for instruction.

Problem	Checkpoint	Remedy
No operation	<ol style="list-style-type: none">1. Is the AC plug connected?2. Is the desired mode selected?3. Is the disc inserted correctly?4. Is the compartment closed?5. Is the CD lens dirty?	<ol style="list-style-type: none">1. Reconnect the AC plug properly.2. Press the desired function button.3. Insert the disc correctly.4. Close the compartment lid securely.5. Clean the CD lens.
No display	Is the AC plug connected?	Reconnect the AC plug.
No sound	<ol style="list-style-type: none">1. Are the speakers connected?2. Is the headphone plugged in firmly?3. Is the wake-up function activated?4. Is mute activated?	<ol style="list-style-type: none">1. Check the speaker connections.2. Insert the headphone plug into the phone jack firmly.3. Turn the power off, then set up again.4. De - activate mute.
Noise or weak radio reception		Rotate the unit for better reception (AM), move the FM antenna wire for better reception (FM).

Remarks : The manufacturer reserves the right to amend the specification without prior notice.

Free Manuals Download Website

<http://myh66.com>

<http://usermanuals.us>

<http://www.somanuals.com>

<http://www.4manuals.cc>

<http://www.manual-lib.com>

<http://www.404manual.com>

<http://www.luxmanual.com>

<http://aubethermostatmanual.com>

Golf course search by state

<http://golfingnear.com>

Email search by domain

<http://emailbydomain.com>

Auto manuals search

<http://auto.somanuals.com>

TV manuals search

<http://tv.somanuals.com>