

TV/DVD COMBO

INSTRUCTION MANUAL

TVD2000



Please read this manual carefully before operation.

<None>WARNING

To reduce the risk of fire or electric shock, do not expose this product to rain or moisture.

The apparatus shall not be exposed to dripping or splashing and that no objects filled with liquids, such as vases, shall be placed on the apparatus.



Caution: To reduce the risk of electric shock, do not remove cover (or back). No user serviceable parts inside. Refer servicing to qualified service personnel.

 This symbol indicates "dangerous voltage" inside the product that presents a risk of electric shock or personal injury.

 This symbol indicates important instructions accompanying the product.

Caution: To prevent electric shock, match wide blade of plug to wide slot, fully insert.

Attention: Pour é viter les chocs é lectriques, introduire la lame la plus large de la fiche dans la borne correspondante de la prise et pousser jusqu' au fond.

USE OF CONTROLS OR ADJUSTMENTS OR PERFORMANCE OF PROCEDURES OTHER THAN THOSE SPECIFIED HEREIN MAY RESULT IN HAZARDOUS RADIATION EXPOSURE. **DO NOT STARE INTO BEAM.**

The unit employs a Laser System. To prevent direct exposure to the laser beam, do not try to open the enclosure. Visible laser radiation when open and interlocks defeated.

Refer to the identification/rating label located on the back panel of your product for its proper operating voltage.

Caution: Using video games or any external accessory with fixed images for extended periods of time can cause them to be permanently imprinted on the picture tube (or projection TV picture tubes). ALSO, some network/program logos, phone numbers, etc. may cause similar damage. This damage is not covered by your warranty.

Cable TV Installer

This reminder is provided to call your attention to Article 820-40 of the National Electrical Code (Section 54 of the Canadian Electrical Code, Part 1) which provides guidelines for proper grounding and, in particular, specifies that the cable ground shall be connected to the grounding system of the building as close to the point of cable entry as practical.

Customer Record

You will find the model number of your unit on the back of your unit. Record these numbers in the spaces provided below. Refer to them whenever you call customer service or your dealer regarding this product.

Model Number: _____

| PACKING LIST | |
|------------------------|------------|
| Parts | QTY |
| TV/DVD Combo | 1 |
| Remote Control | 1 |
| Operation Manual | 1 |
| AAA Alkaline Batteries | 2 |

IMPORTANT SAFETY INSTRUCTIONS

1. Read these instructions.
2. Keep these instructions.
3. Heed all warnings.
4. Follow all instructions.
5. Do not use this apparatus near water.
6. Clean only with dry cloth.
7. Do not block any ventilation openings. Install in accordance with the manufacturer's instructions.
8. Do not install near any heat sources such as radiators, heat registers, stoves, or other apparatus (including amplifiers) that produce heat.
9. Do not defeat the safety purpose of the polarized or grounding-type plug. A polarized plug has two blades with one wider than the other. A grounding type plug has two blades and a third grounding prong. The wide blade or third prong is provided for your safety. If the provided plug does not fit into your outlet, consult an electrician for replacement of the obsolete outlet.
10. Protect the power cord from being walked on or pinched particularly at plugs, convenience receptacles, and the point where they exit from the apparatus.
11. Only use attachments/accessories specified by the manufacturer.
12. Use only the cart, stand, tripod, bracket, or table specified by the manufacturer, or sold with the apparatus. When a cart is used, use caution when moving the cart/apparatus combination to avoid injury from tip-over.
13. Unplug this apparatus during lightning storms or when unused for long periods of time.
14. Refer all servicing to qualified service personnel. Servicing is required when the apparatus has been damaged in any way, such as power-supply cord or plug is damaged, liquid has been spilled or objects have fallen into the apparatus, the apparatus has been exposed to rain or moisture, does not operate normally, or has been dropped.
15. **Warning - This unit should only be serviced by an authorized and properly trained technician. Opening the cover or other attempts by the user to service this unit may result in serious injury or death from electrical shock, and may increase the risk of fire.**



FCC Warning

Class B Computing Device
Information to User

This equipment has been tested and found to comply with the limits for a Class B Digital Device pursuant to part 15 of FCC Rules. These limits are designed to provide reasonable protection against harmful interference in a residential installation. This equipment generates, uses, and can radiate radio frequency energy and, if not installed and used in accordance with the instructions, may cause harmful interference to radio communications. However, there is no guarantee that interference will not occur in a particular installation. If this equipment receives interference while off and on, the user is encouraged to try to correct the interference by one or more of the following measures:

- 1) Reorient or relocate the receiving antenna.
- 2) Increase the separation between the equipment and unit.
- 3) Connect the equipment into an outlet on a circuit different from that to which the unit is connected.
- 4) Consult the dealer or an experienced radio/TV technician for help and for additional suggestions.

The user may find the following booklet prepared by the Federal Communications Commission helpful: "How to Identify and Resolve Radio - TV Interference Problems". This booklet is available from the US Government Printing Office, Washington, D.C. 20402, Stock No. 004-000-00345-4.

FCC Warning

The user is cautioned that changes or modifications not expressly approved by the manufacturer could void the user's authority to operate the equipment.

NOTE: In order for an installation of the product to maintain compliance with the limits for a Class B Device, shielded cables must be used.



WARNING:
THE REGION CODE FOR THE UNIT IS 1.



Since it is very usual for DVD movies to be released at different times in different regions of the world, all players have region codes and disks can have an optional region code. If you load a disk of a different region code to your player, you will see the region code notice on the screen. The disk will not play, and should be unloaded.

Notes on Discs

HOW TO HANDLE, CLEAN, AND STORE DISCS.

Handling discs

- DO NOT TOUCH THE PLAYBACK SIDE OF THE DISC.
- DO NOT ATTACH PAPER OR TAPE TO DISCS.

Note:

CURTIS SHALL NOT BE RESPONSIBLE FOR DAMAGE THAT MAY OCCUR TO A DISC FROM BEING OPERATED IN THE UNIT.



Cleaning discs

- Fingerprints and dirt on the disc cause picture and sound deterioration. Wipe the disc from the center outward with a soft cloth. Always keep the disc clean.
- If you cannot wipe off the dirt off, wipe the disc lightly with a slightly moistened soft cloth and finish with a dry cloth.
- Do not use any of solvent such as paint thinner, benzene, commercially available cleaners or anti-static spray for vinyl LP's.

Storing discs

- Do not store discs in places subject to direct sunlight or near heat sources.
- Do not store discs in places subject to moisture and dust.
- Store discs vertically in a case. Stacking or placing objects on discs outside of their case may cause warping.

Playable discs

This unit can play back the following discs.

| | Disk Mark | Contains | Disc Size | Maximum playback time |
|-------------------------|-----------|--------------------------------|-----------|-------------------------------------|
| DVD video disc | | Audio +Video (moving pictures) | 12cm | Approx. 4 hours (single sided disc) |
| | | | | Approx. 8 hours (double sided disc) |
| KODAK Picture CD | | Spec. | 12cm | |

Notes on regional numbers

DVDs are divided into separate regions. The United States and Canada are designated as region 1 DVD. Your unit plays region 1 DVDs only.

TABLE OF CONTENTS

INTRODUCTION

| | |
|-----------------------------------|---|
| Safety Precautions | 1 |
| Feature Descriptions | 5 |
| Specifications | 5 |
| Front and Rear Unit Profiles..... | 6 |
| Remote Control Features | 6 |

INSTALLATION

| | |
|---|---|
| Connecting the Antenna..... | 8 |
| Installing the Remote Control Batteries | 8 |
| Connecting A/V Equipment | 9 |

FUNCTIONS & FEATURES

| | |
|--------------------------------------|----|
| Turn On/Off..... | 11 |
| Basic Functions | 11 |
| Function Selection Menus | |
| Picture Menu | 11 |
| Tuner Menu | 12 |
| Timer Menu | 12 |
| System Menu..... | 12 |
| Useful Remote Control Features | 14 |

DVD FUNTIONS

| | |
|---|----|
| Playing Back a Disc | 15 |
| Using the On-Screen Display | 16 |
| Locating a Specific Title, Chapter or Track..... | 17 |
| Selecting Subtitles | 18 |
| Selecting the Camera Angles/Language/Audio Settings | 18 |
| Setting the Parent Lock | 19 |
| Customizing the Function Selectings | 20 |

| | |
|-----------------------------------|-----------|
| TROUBLESHOOTING GUIDE..... | 21 |
|-----------------------------------|-----------|

| | |
|--------------------------------------|-----------|
| LIMITED PRODUCT WARRANTY..... | 22 |
|--------------------------------------|-----------|

Note:

The OSD and illustration in this manual may be somewhat different from the actual situation, depending on your model.

Instruction Manual

Feature Descriptions

181 Channel Tuner - total number of channels the TV can receive: 2-69 in Air mode, or 1-125 in Cable mode

AV Input (Rear/Front) - standard composite input designed for use with A/V devices, such as a VCR or DVD player

AV Output (Rear) - output signals from TV to devices such as VCR's

RF IN Jack - standard coaxial antenna jack

Channel Recall - instant return to the last channel viewed

Closed Captions Display - feature that displays the closed captions or text of a TV broadcast

Remote Control - A wireless remote control unit for the TV

On/Off Timer - feature that allows the user to set a time for the TV to turn on or off

Parental Control - feature that allow parents to block out selected type of programming

Screen Size - the diagonal size of the TV screen

Selectable Picture Modes - preset standards for TV display: User, Normal, Movie and Sports

Trilingual On Screen Display (OSD) - TV's on screen display can be either English, French or Spanish

DVD/CD/KODAK Picture CD Support

SPECIFICATIONS

| MODEL | TVD2000 |
|------------------------------|---|
| Television System | NTSC-M |
| Channel Coverage | VHF 2-13, UHF 14~69 |
| Cable TV Coverage | Mid Band (A-8~A-1, A~I); Super Band (J~W) Hyper Band (AA~ZZ, AAA, BBB) Ultra Band (65~94, 100~125) |
| Channels Preset | 181 |
| Antenna Input | 75 ohm (unbalanced) |
| Screen Dimensions (Approx.) | 406 mm x 305 mm |
| Audio Output | Main channel: 2W+2W |
| Total Harmonic Distortion | <7% |
| Power Source | 110V ~, 60Hz |
| Unit Weight | 25kg |
| Unit Dimensions (Approx.) | 512mm x 502mmx 481 mm |
| Power Consumption | 120W |

Instruction Manual

Front and Rear Unit Profiles

Front panel

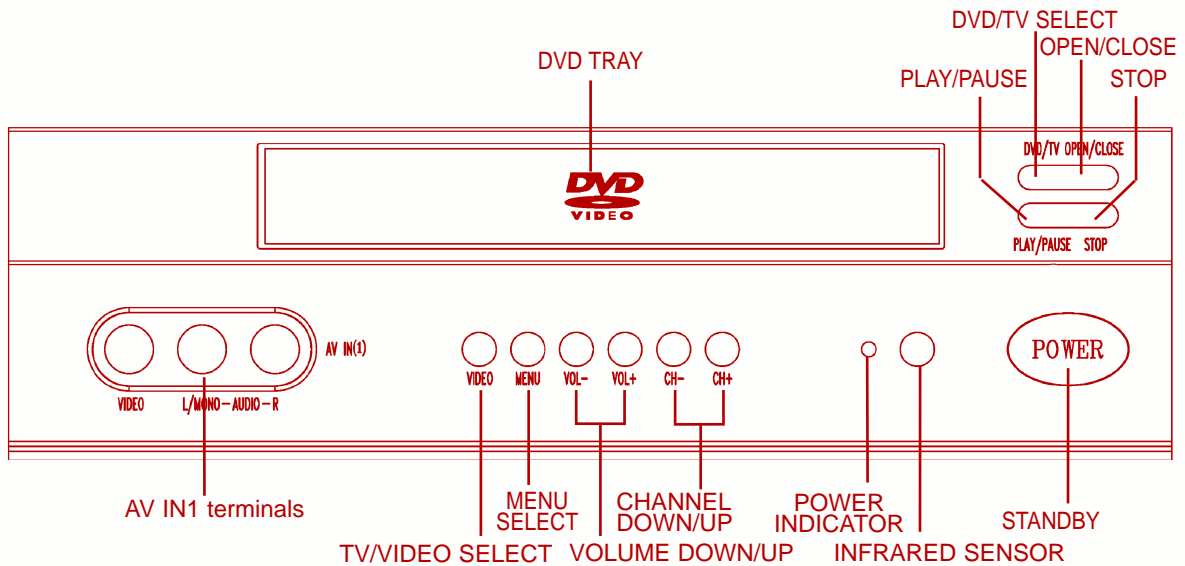

Rear panel

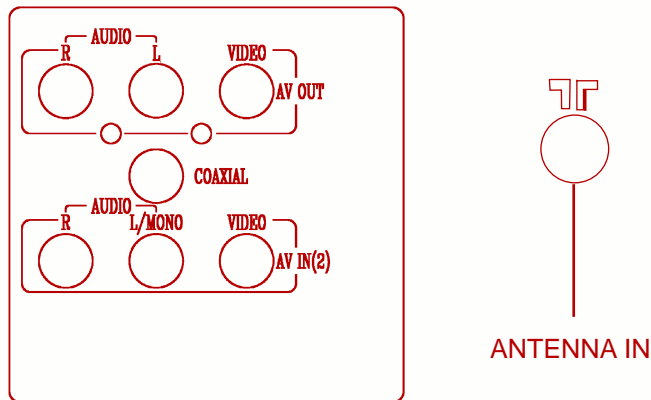

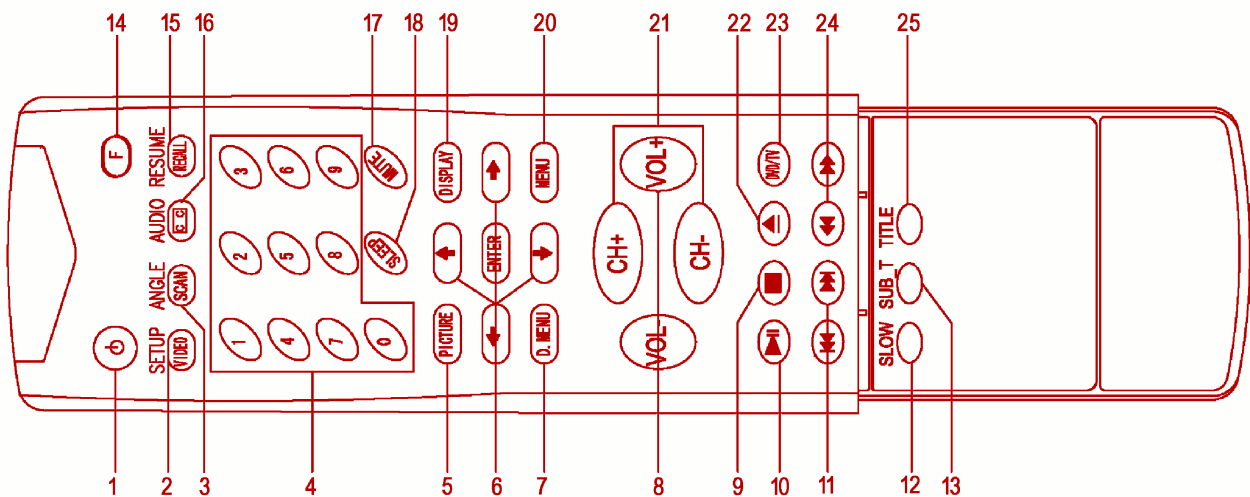

Remote Control Features



Instruction Manual

Remote Control Features

The keys marked with * have composite functions and the key in boldface type function for DVD only as shown below.

| No. | Button | Function Description | |
|-----|--|---|----------------------------|
| | | TV | DVD |
| 1 |  | Standby | |
| *2 | VIDEO(SETUP) | TV/Video select | Setup |
| *3 | SCAN(ANGLE) | Channel scan | Angle select |
| *4 | 0~9 | Channel number (0~9) | Number (0~9) |
| 5 | PICTURE | Picture mode select | |
| 6 |  | Used to navigate the menus/Accesses the sub menus | |
| 7 | D_MENU | — | DVD menu |
| 8 | VOL-/VOL+ | Volume down/up | |
| 9 | STOP | — | Stop |
| 10 | PLAY/PAUSE | To play | Play/Pause |
| 11 | PREV/NEXT | — | Previous skip/Forward skip |
| 12 | SLOW | — | Slow playback |
| 13 | SUB-T | — | Sub title |
| 14 | F+VOL-/F+VOL+ | Decrease/Increase volume by 4 levels | |
| | F+MUTE | Child lock | |
| *15 | RECALL(RESUME) | Recall | Resume |
| *16 |  (AUDIO) | CCD/Text | Audio |
| 17 | MUTE | Mute on/off | |
| 18 | SLEEP | Sleep off | |
| 19 | DISPLAY | On-screen display | |
| 20 | MENU | Menu select | |
| 21 | CH+/CH- | Channel down/up | — |
| 22 | OPEN/CLOSE | To open | Open/Close |
| 23 | DVD/TV | DVD/TV select | |
| 24 | REV/FWD | — | Fast rewind/Fast forward |
| 25 | TITLE | — | Title |

Notes:

1. When in operation, please point your remote control directly to the infrared sensor.
2. Do not expose the remote control to impacts, water or disassemble it.
3. Do not repeatedly press the buttons on the remote control. Allow interval of no less than one second between selections.
4. When "  " displayed during DVD playback, the function is not operational.

Instruction Manual

INSTALLATION

- Please read the safety instructions in this manual completely before installation.
- Install your unit in an area where direct sunlight will not fall upon the screen.
- Soft, indirect light is best for television viewing.
- Allow enough space (at least 4 in.) between the TV and any walls or enclosures for proper ventilation.
- Optimum television viewing distance is 3-5 times the screen's size.

Auto-Degaussing

Color TV is easily affected by magnetism which leads to color distortion. If your unit is moved or affected by near magnetic components or appliances with power on, please power off your unit for at least 1 hour. The built-in auto-degaussing circuit will eliminate the magnetism interference.

Auto off when no signal received

The TV set will automatically enter into Standby mode when the following conditions are met.

1. TV is in antenna mode.
2. Current channel has no signal.
3. No key is pressed within 15 minutes.

Connecting the Antenna

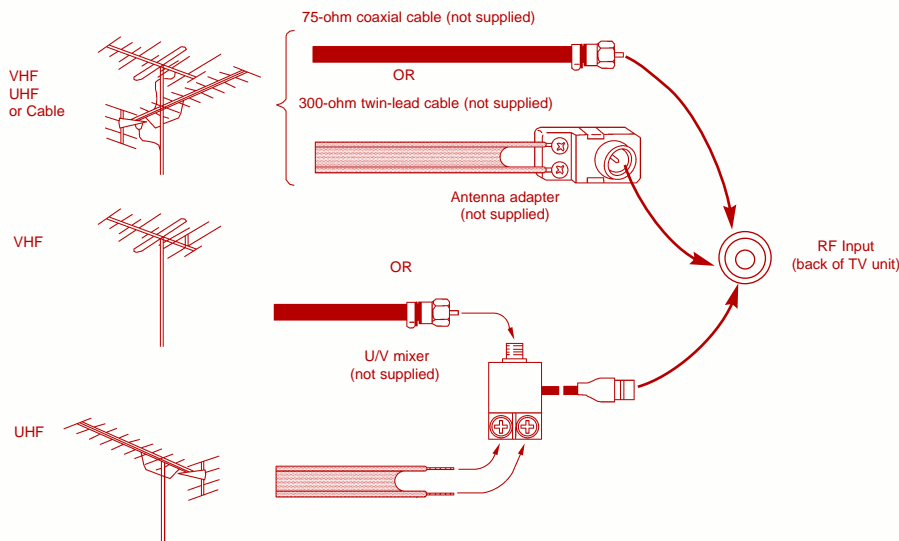

Notes:

- 1) It is recommended that a 75 ohm coaxial cable be used in order to eliminate interference and noise which may occur due to nearby radio transmissions.
- 2) The antenna cable should not be tied together with other wiring.
- 3) Set up a lightning rod and check it regularly when an outdoor antenna is used.

Installing the Remote Control Batteries

1. Remove the battery compartment lid. Insert two AAA batteries (included) into the battery compartment in the rear of the remote control.
2. Make sure the positive (+) and negative (-) polarities are correctly aligned.
3. Reattach the battery lid.

Notes:

- 1) Alkaline batteries are recommended for longer life.
- 2) Always replace both batteries at the same time.
- 3) Do not expose batteries to fire or break them open.
- 4) To avoid battery leakage, remove batteries from the remote control when it is not being used for a long period of time.

INSTALLATION (continued)

Connecting A/V Equipment

The following are diagrams showing basic instructions for attaching external equipment, like a VCR or DVD player, to your unit. Please refer to operation manuals of external audio/video equipment that will be connected to your set for additional instructions. PLEASE TURN OFF ALL POWER BEFORE CONNECTING DEVICES TOGETHER.

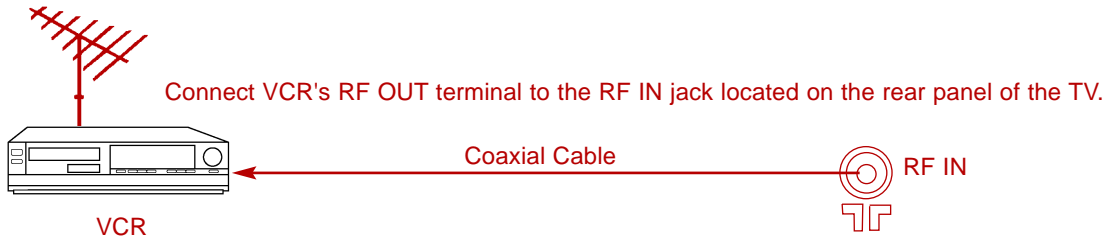

Input from Device to TV

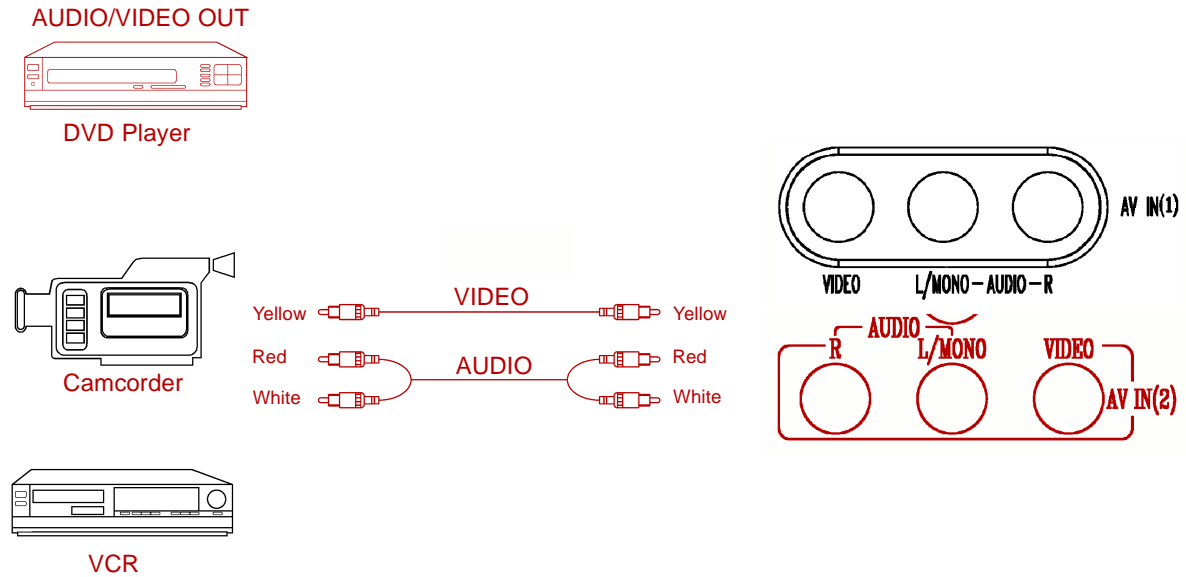

Output from TV to Device

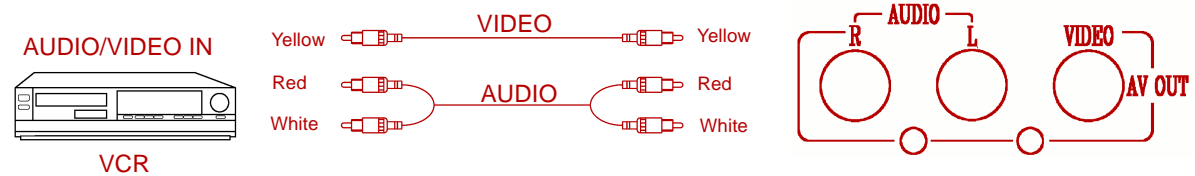

INSTALLATION (continued)

Connecting A/V Equipment (continued)

Enjoying Digital Stereo Sound (Digital Stereo)

Enjoy the dynamic sound of Digital Stereo by connecting an amplifier equipped with a digital audio input and speaker system (right and left front speakers).

Set "Spdif Output" to "Spdif/PCM" via the setup menu.

- **How to setup the sound output:**

From the SETUP MENU display, select AUDIO SETUP by pressing **ENTER**. Use ↓ key, set "Spdif Output" to "Spdif/Raw".

This product incorporates copyright protection technology that is protected by method claims of certain U.S. patents and other intellectual property rights owned by Macrovision Corporation and other rights owners. Use of this copyright protection technology must be authorized by Macrovision Corporation, and is intended for home and other limited viewing uses only unless otherwise authorized by Macrovision Corporation. Reverse engineering or disassembly is prohibited.

It is forbidden by law to copy, broadcast, show, play in public, or rent copyrighted material without permission. DVD video discs are copy protected, and any recordings made from these discs will be distorted.

Notes:

- (1) The input of the AV receiver is not compatible with the PCM/BITSTREAM jack and is primarily for Laserdiscs only.
- (2) Refer to the manual of the connected Equipment.
- (3) Adjust the volume of your receiver to a comfortable listening level to avoid any speaker damage.

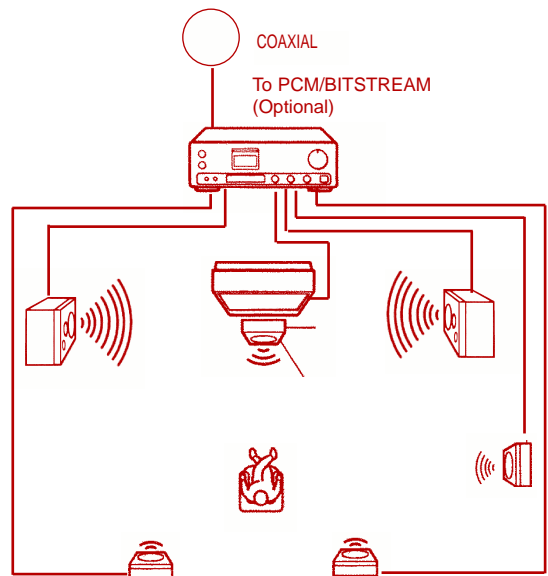
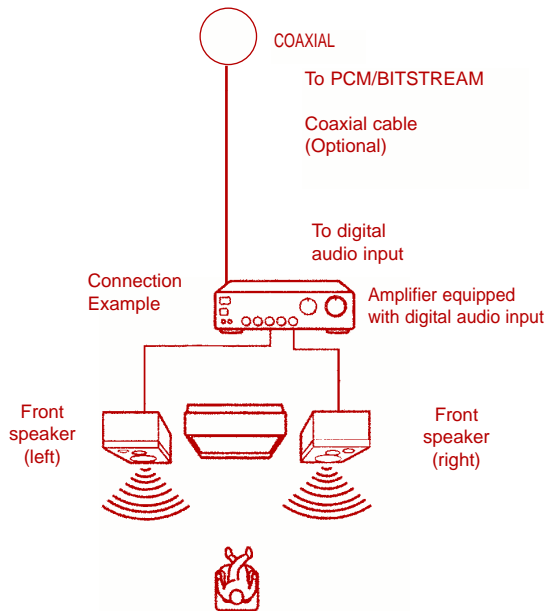

FUNCTIONS & FEATURES

Turn On/Off

1. Turn On

Plug in the power cord, and the TV should enter into Standby mode. Pressing **STANDBY** key will turn on the TV and its power indicator light.

2. Standby (Soft Off)

While the TV is on, press the **STANDBY** key will put the TV in Standby or off mode. The power indicator light on the TV set will turn off.

Basic Functions

Changing the Channel

While in Tuner mode, press the **CH+/-** keys to change the channel, or use the **numeric** keypad to enter a new channel.

Adjusting the Volume

To adjust the volume, press the **VOL+/-** keys. Also, you may press the **FUNCTION (F)** key along with the **VOL +/-** keys to adjust the volume in increments or decrements of 4.

Muting the Volume

To mute the volume, press the **MUTE** key. To restore the volume, press **MUTE** again or press the **VOL +** key.

Function Selection Menus

To change the setting of any function, press the **MENU** key to bring up the main menu. Press **↑/↓** to highlight the desire sub-menu and press **←/→** (or **ENTER**) to access. While in the sub-menu, press **↑/↓** to select the item and **←/→** to adjust the setting. Press the **MENU** key to return to the main menu and exit.

While in the setup menu, **CH-/+** and **VOL-/+** key on the front panel will function as the **↓ / ↑ / ←/→** on the remote control.

Picture Menu

Features

This menu allows you to adjust the various picture settings.

Press **↑/↓** to move between the various settings, and **←/→** to adjust them. When finished, press the **MENU** key to return to the main menu.

- Tint:** -31 (more purplish) to +31 (more greenish)
Brightness: 0 (dimmiest) to 63 (brightest)
Contrast: 0 (minimum contrast) to 63 (maximum contrast)
Color: 0 (minimum color) to 63 (maximum color)
Sharpness: 0 (minimum sharpness) to 63 (maximum sharpness)

Note:

To control picture artifacts reduce the sharpness setting when viewing DVD discs.

| Picture | |
|---|---------------|
|  Tint |00 |
| Brightness |32 |
| Contrast |32 |
| Color |32 |
| Sharpness |32 |

Instruction Manual

FUNCTIONS & FEATURES (continued)

Tuner Menu

Note: This menu is only accessible while the TV is in Tuner mode.

Channel: This feature allows you to change the channel displaying on screen. Press \leftarrow/\rightarrow or the numeric keypad to change the channel.

Add/Erase: This feature allows you to add or remove the channel currently display on screen to the "active channel list". Active channel list is the list of channel that is available by pressing the **CH+/-** keys. Press \leftarrow/\rightarrow to add or erase.

Antenna: This feature sets the TV tuner to an Air antenna or a Cable antenna. Please use *Air* mode when using an over-the-air antenna; use *Cable* mode for a cable hookup. Press \leftarrow/\rightarrow to select between the two options.

Auto Program: This feature will setup the Active channel list for the user. The list will include only the channels with a signal detected. Press \rightarrow to begin and \leftarrow to stop the process.

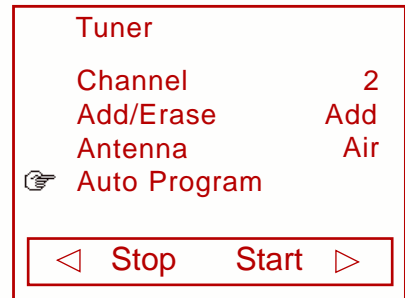

Timer Menu

Time

This feature allows you to set the clock on the TV.

On Time

This feature allows you to preset a time when the TV set will turn on.

On Channel

This feature allows you to preset the channel on display when the On Time is activated.

Off Time

This feature allows you to preset a time when the TV set will turn off.

Timer

Timer can be set to *Once* or *Always*.



System Menu

Language

This feature allows you to pick a language used for the on screen display (OSD). Press \leftarrow/\rightarrow to select the language of your choice - English (Eng.), French (Fra.) or Spanish (Esp.).

Blue Back

This feature gives you the option to display a blue background on the TV screen when there is no signal present. Press \leftarrow/\rightarrow to toggle between on and off.

Closed Caption

Closed caption is a feature that allows your TV set to display, on screen, the dialogue, narration, and sound effect of a TV program. It also allows you to display teletext signal. Text and caption will be displayed at either the top or the bottom of the screen. There is nine different setting for closed caption. You can set it to one of the 4 Closed Caption settings (CC1-4), one of the 4 Text settings (T1-4), or set this feature to off (CCD/Text off).

Notes: A Closed Caption signal may not be displayed under the following conditions:

- When there is no Closed Caption/Text signal to decode
- When the signal is weak or altered (due to interference or poor reception)
- When viewing a dubbed video tape

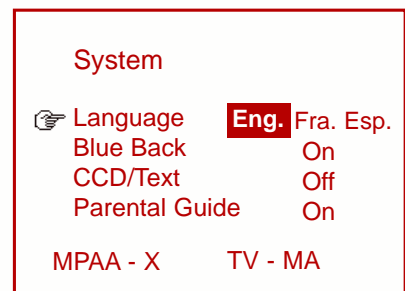

FUNCTIONS & FEATURES (continued)

System Menu (continued)

Parental Guide

This feature allows parents to block certain programs from being viewed, based on the programs' rating. In order to access this menu, you must first enter a pass code. The factory default is **6688**. Enter the pass code while the Parental Guide is highlighted. Now, with Parental Guide set as On, press → to access the TV Rating grid.

TV Rating

Press ↑/↓ to navigate between the ratings, press the **MENU** key to block out a particular rating completely. Or, if you wish, press ↓ to highlight an individual rating (anywhere a *U* is displayed in the middle of the grid.) Pressing the **MENU** key with one of these individual ratings highlighted will block only programs that feature that particular aspect. See the TV rating diagram at right for an example. TV ratings are defined in the charts below:

| Age | Defined as | Contents | Defined as |
|---------|-------------------------------------|----------|-------------------|
| TV - Y | All Children | FV | Fantasy Violence |
| TV - Y7 | Directed to Older Children (over 7) | D | Sexual Dialogue |
| TV - G | General Audience | L | Adult Language |
| TV - PG | Parental Guidance Suggested | S | Sexual Situations |
| TV - 14 | Parents Strongly Cautioned | V | Violence |
| TV - MA | Mature Audience Only | | |

MPAA Rating

Press → while in the TV Rating grid to access this grid. Press ↑/↓ to navigate between the MPAA ratings. Pressing the **MENU** key with a rating highlighted will block that particular rating from being shown on this TV. A *B* will show in red next to the blocked rating. Please note that blocking a lower rating (for example, PG) will block all higher ratings (PG-13, R, NC-17, X.)

Pass Code Menu

This menu allows you to change the access code for the Parental Guide functions of the TV set. Press the **MENU** key when Pass Code Control is highlighted. This will turn on or off the Pass Code function. With the Pass Code function ON, you can also change the Pass Code. Press ↓ to highlight *Pass Code*, then enter the new Pass Code using the numeric keypad.

Note:

The factory pre-set password is **6688**. The initial password will be replaced when the new one is used. Please contact the service centre in case you forget the password.

System

Language **Eng.** Fra. Esp.
 Blue Back On
 CCD/Text Off
 Parental Guide On
 MPAA-X TV-MA

Enter Pass Code - - - -

TV-Rating

| Rating | FV | D | L | S | V |
|-----------|----|---|---|---|---|
| TV-Y U | | | | | |
| TV-Y7 U U | | | | | |
| TV-G U | | | | | |
| TV-PG U | | U | U | U | U |
| TV-14 B | | B | B | B | B |
| TV-MA B | | B | B | B | B |

Age Based Rating

MPAA - Rating

| Movie | Rating |
|-------|--------|
| G | U |
| PG | U |
| PG-13 | U |
| R | U |
| NC-17 | U |
| X | U |

Age Based Rating

Pass Code Menu

Pass Code Control
 Pass Code 6688

Enter Pass Code - - - -

FUNCTIONS & FEATURES (continued)

Useful Remote Control Features

DISPLAY

This key allows you to display the current information of the TV screen on the upper right hand corner of the screen. (channel, antenna mode, time, video, etc.)

SCAN

Press the **SCAN** key twice, and the TV will begin to scan through all active channels. To stop the Scan, pressing any key can interrupt scanning. Please note that Scan will only work in Antenna mode.

PICTURE

Your TV has factory preset picture modes that allow you to optimize your TV viewing. To activate these picture modes, press this key, and you can choose among User, Normal, Movie and Sports.

RECALL

This key will allow you to return to the last channel you were viewing. Pressing it again will return you to the channel you just left.

CC

Pressing the **CC** key will activate the currently selected Closed Caption or Text under the System Menu. Pressing it again will turn off the Closed Caption or Text.

VIDEO

This key allows you to toggle between antenna and different video modes.

Child Lock

The Child Lock feature prevents unauthorized viewing of the TV. To activate, press and hold the **F** key, and then press **MUTE**. You should see a key symbol appear on the screen. This will lock out all remote functions (except for Standby). To unlock the TV, press and hold the **F** key and press **MUTE**. This will unlock the TV. Please note that the only way to activate or deactivate the Child Lock feature is via remote control - please insure that it is stored securely.

0-9

Press the **0-9** keys to enter channel numbers directly (2-69 in the Air mode or 1-125 in the Cable mode). Press the corresponding Number key(s) to enter a channel number from high-digit to low-digit. Each digit should be entered at 3 seconds time interval.

SLEEP

Press the **SLEEP** key repeatedly to switch the TV to one of the following modes :

-- → 15 → 30 → 45 → 60 → 90 → 120 → 150 → 180 (Unit: Minute)

The TV will automatically enter the Standby mode when the preset Sleep time is up.

The TV will display a message one minute before the Sleep timer runs out.

DVD FUNCTIONS

Playing Back a Disc

1. How to playback a disc

- 1) Press **DVD/TV** to enter the DVD mode.
- 2) Press **OPEN/CLOSE** to open the disc tray.
- 3) Place the disc on the disc tray. Be sure the playback side is faced down.

Note:

A disc may be damaged if not correctly placed on the guides in the disc tray.
This may also cause the DVD player to malfunction.

- 4) Press the **PLAY** key. After closing the disc tray playback will start.
The menu screen will appear automatically or you may access the menu screen by pressing **TITLE**.

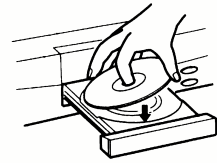

Notes:

- (1) Moving the unit during playback may cause damage to the disc as well as the unit.
- (2) To open and close the disc tray, you should only use the **OPEN/CLOSE** key.

2. About DVD CD

DVD or CD icons will appear depending on the disc being played back.

DVD: DVD video discs

CD: Audio CDs

3. How to start playback from the menu screen

- 1) Press **↑/↓ / ←/→** or the **Number** keys to select the title.
- 2) Press the **ENTER** key. The DVD player will start playback from the title selected.

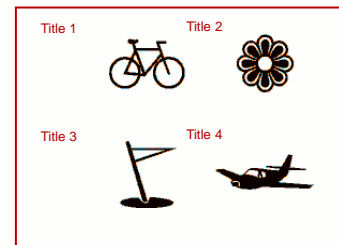

4. How to pause playback (still playback)

Press the **PAUSE** key during playback.
Press the **PAUSE** key to resume normal playback.

5. How to remove the disc

Press the **OPEN/CLOSE** key. Wait until the disc tray is completely open before removing any discs.
After removing the discs, press the **OPEN/CLOSE** key to close the disc tray.

6. How to stop playback

Press the **STOP** key once. The DVD player is stopped.
Press the **PLAY** or **RESUME** key to replay.
Press the **STOP** key twice. The DVD player is stopped completely.

Note:

At the completion of each movie a menu screen may appear. Be aware that the on-screen setup menu may damage your TV by permanently burning that image onto the screen. To avoid this, press the **STOP** key at the completion of each movie. You may also decide to setup the **SCREEN SAVER**.

7. Advanced playback

The DVD player allows you to playback discs at various speeds.



- 1) You can play back a disc at 2x, 4x, 8x, or 16x the normal speed.
Press the **REV** or **FWD** key during playback.
The playback speed becomes 2x the normal speed.
The playback speed changes each time you press the **REV** or **FWD** key.
REV: Fast reverse **FWD:** Fast forward
Press **PLAY/PAUSE** to resume normal playback.

Instruction Manual

DVD FUNCTIONS(continued)

Playing Back a Disc (continued)

Note:

- The DVD Player may not playback sound during scan reverse or forward playback of DVD video discs. The DVD Player will play sound during fast forward or fast reverse playback of audio CDs.
 - The speeds may vary slightly from disc to disc and the 2x, 4x, 8x, and 16x speeds are only approximate speeds.
- 2) Playing in slow-motion
A disc can be played back in slow-motion.
Press **PLAY/PAUSE** key to resume normal playback.

Note:

During the slow-motion playback, the sound may not be heard. Some discs do not utilize this feature.

8. Resuming playback from the same location

This DVD player allows you to stop playback and continue playback later from the same location on the disc.

- 1) Press the **STOP** key.
This will interrupt the playback and the DVD player will memorizes the location where you stopped playback.
- 2) Press the **RESUME** key.
The DVD player will resume the playback from the location where you stopped playback.

Notes:

- (1) The following actions will cancel the RESUME function:
 - Unplugging the unit after you stop playback.
 - Ejecting the disc.
- (2) Depending on the disc, you may experience a difference of location where playback resumes
- (3) Some discs do not utilize this feature.

Using the On-Screen Display

THE UNIT ALLOWS YOU TO VIEW THE DISC INFORMATION ON THE TV SCREEN.

Press **DISPLAY** during playback, you can view the following on the TV:

-Current title, Track number, Total playing time

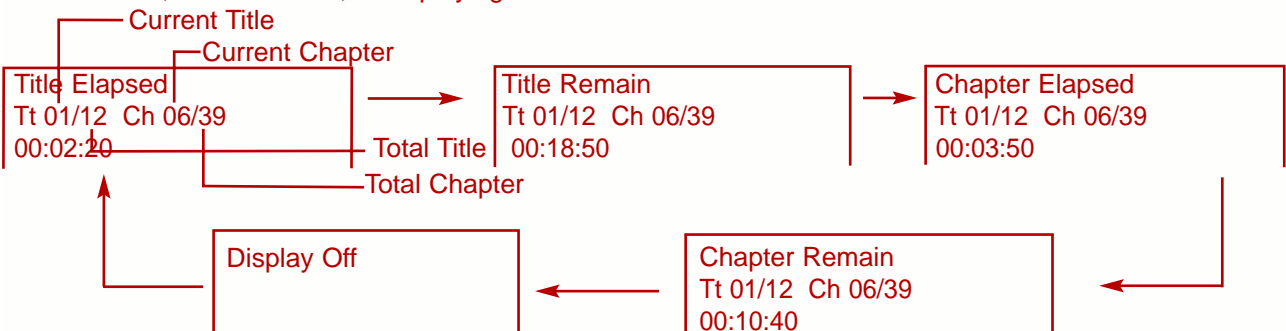

To turn off the on-screen display, press **DISPLAY** repeatedly.

DVD FUNCTIONS(continued)

Locating a Specific Title, Chapter or Track

THE DVD VIDEO DISCS ARE NORMALLY DIVIDED INTO TITLES. THE TITLES ARE SUB-DIVIDED INTO CHAPTERS. MOREOVER, AUDIO CD ARE DIVIDED INTO TRACKS. YOU CAN CONVENIENTLY LOCATE ANY SPECIFIC TITLE, CHAPTER, OR TRACK WITH THIS UNIT.

Chapter1 Chapter2 Chapter3 Chapter4 Chapter5



DVD Video Disc

Track1 Track2 Track3 Track4 Track5



Audio CD

1. Locating a title using the title menu

You can locate a specific title using the title menu function, if a DVD video disc contains a title menu.

- 1) Press the **TITLE** key. On the TV screen, the title menu will appear.
- 2) Press the **↑/↓ / ←/→** keys to select the title you want.

You can also directly locate a specific title by pressing its assigned number with the **Number** keys.

- 3) Press the **ENTER** key. This will cause the unit to start playback from chapter 1 of the title selected.

Notes:

- (1) You may find that some discs will not respond to this function.
- (2) If different instructions appear on the TV screen, follow those instructions. The instructions above are describing the basic procedure where the procedures may vary depending on the contents of the DVD video disc.

2. Locating a specific chapter or track

This unit allows you to locate consecutive chapters or tracks.

Press the **PREV** or **NEXT** key repeatedly to display the requested chapter or track.

The DVD player starts playback from the selected chapter or track.

How to locate preceding chapters or tracks

- When you press the **PREV** key, the DVD player starts playback from the beginning of the preceding chapter or track.

How to locate succeeding chapters or tracks

- When you press the **NEXT** key, the DVD player starts playback from the beginning of the succeeding chapter or track.

Note:

On some discs the titles may not display the sub-divided chapters.

DVD FUNCTIONS(continued)

Setting the Parental Lock

YOU CAN USE THE PARENTAL LOCK FUNCTION ONLY WITH DVD VIDEO DISCS EQUIPPED WITH THE PARENTAL LOCK FEATURE.

Setting the parental lock

DVD video discs equipped with the parental lock function are rated according to their content. The contents allowed by a parental lock level and the way a DVD video disc can be controlled may vary from disc to disc. For example, if the disc allows, you can edit out violent scenes unsuitable for children and replace them with more suitable scenes, or lock out playback of the disc all together.

- 1. Press **STOP** twice during playback.
- 2. Press **SETUP**. The SETUP MENU appears on the TV screen.
- 3. Select Preference page, press **ENTER**.
- 4. Select Parental, press direction keys.
Select Parental, press **ENTER**.
- 5. Enter your password then press **ENTER** key.
The preset password is **1225**.

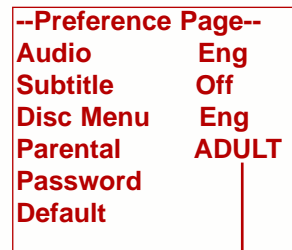

To change your password:

- 1) Follow step 3 to select password change.
- 2) Enter old password.
- 3) Enter new password.
- 4) Re-enter to confirm your new password.
- 5) Press **ENTER**.
- 6) Press **SETUP**.



Customizing the Function Settings

THIS UNIT ALLOWS YOU TO CUSTOMIZE THE PERFORMANCE TO YOUR PERSONAL PREFERENCES.

Displaying the setup menu screen

The SETUP MENU screen asks you to select a setting category from General Setup, Speaker Setup, Audio Setup, and Preferences. The selected category will provide you the setting details on-screen.

1. Press **SETUP**.
2. Press **↑/↓ / ←/→** to select category (highlight), then press **ENTER**.
3. Press **SETUP** to normal playback.

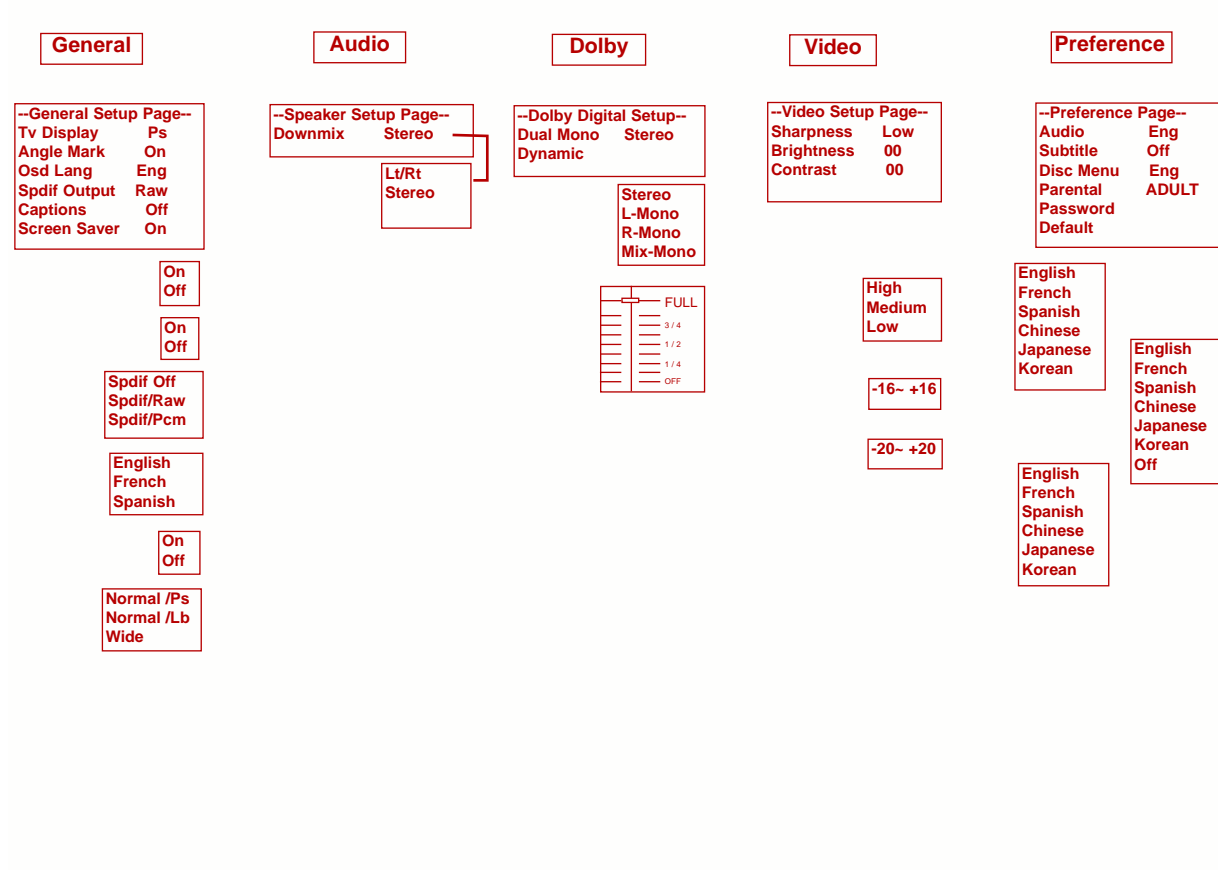

Notes:

- Preset password is **1225**.
- Highlighted function will be expanded at bottom of the screen.
- The SETUP MENU screen disappears if you press the **SETUP** key while it is displayed.
- Functions and menu may change without notice.
- You must press **STOP** twice to set up Preference.

TROUBLESHOOTING GUIDE

Check the following guide for a possible correction to a problem before contacting customer support.

| Symptoms | Correction |
|--|--|
| No power | <ul style="list-style-type: none"> • Connect the power plug into the wall outlet securely. |
| Dark, Poor or No picture | <ul style="list-style-type: none"> • Verify the connection from the VCR video output to the TV video input is secure. Then switch TV to the appropriate Video mode by pressing TV/VIDEO button. • Adjust picture setting for tint, color brightness and sharpness. • Verify coaxial cable from antenna is connected to RF IN. |
| No sound | <ul style="list-style-type: none"> • Connect the audio cables into the terminals securely. • Verify the connection from the VCR audio output to the TV audio input. Then switch to the appropriate mode on the receiver. Refer to your audio amplifier owner's manual. • Verify the volume is at an appropriate level and the mute feature is not on. |
| No TV signal | <ul style="list-style-type: none"> • If television is connected through a stereo receiver use its volume control to adjust stereo speaker sound. • Verify the TV is set to Antenna mode. • Make sure the antenna is securely connected to the RF in jack. • Unplug the TV from the wall for 30 seconds, then plug in and try again. • Unplug the antenna connection from the back of the TV, unplug the TV from the wall, wait for 30 seconds, then try again. |
| Stripe or purple interference appears in the screen | <ul style="list-style-type: none"> • Verify the speakers around the TV set are shielded otherwise move them at least 6 inches away. |
| Picture becomes snowy. | <ul style="list-style-type: none"> • Verify the antenna lead wire is in working condition. • Verify the antenna is connected securely to the RF in jack. |
| Picture with multi-image | <ul style="list-style-type: none"> • Use an omni directional outdoor antenna. • Move the antenna around to minimize multi-images. |
| TV channel not received | <ul style="list-style-type: none"> • Make sure the Air/Cable setting is correct. • Channel may be locked with block channel feature, such as Parental Control. Factory default setting is 6688. • Check Add/Erase feature, as channel may be have been erased during set up. |
| Black box appears on screen. | <ul style="list-style-type: none"> • Verify Closed Caption feature is off. |
| Remote control doesn't operate. | <ul style="list-style-type: none"> • Batteries may be weak. Replace batteries. • Recheck the batteries are installed correctly with the correct +/- polarity. • Make sure nothing is in between the remote and the remote sensor. |
| Brightness is unstable or noises are produced on playback pictures | <ul style="list-style-type: none"> • What you're viewing may be effect of the copy protection circuitry required on all DVD players. Change another disc, and try again. |
| The DVD video player doesn't start playback | <ul style="list-style-type: none"> • Place the disc with the graphics side up. • Place the disc on the disc tray correctly inside the guide. • Make sure the disc is free from scratches & fingerprints. • Press the SETUP button to turn off the menu screen. • Cancel the parental lock function or change the parental lock level. (The preset password is 1225.) • Turn the power off then disconnect the power plug and reinsert it back into the wall. Retry again. • Use region 1 disc only. |
| Black bars appear at top and Bottom of screen | <ul style="list-style-type: none"> • This is normal for a widescreen presentation offered on certain DVDs. |

LIMITED PRODUCT WARRANTY



**Audio Product
Telecom Product
TV
DVD Player**

This quality product is warranted to be free from manufacturer's defects in material and workman-ship, provided that the unit is used under the normal operating conditions intended by the manufacturer.

Should you have any problem with this product, please and it is highly recommended to visit our website at www.curtisint.com before you take any other steps as we have additional copies of instruction manuals, operating manuals and trouble shooting tips on our website which gives you the answer on most of the questions you could have in operating the unit.

TERMS OF WARRANTY

C.I. Service Dept. warrants this product to be free from defects in materials and workmanship for 1 year on parts and 90 days on labor.

Nothing within this warranty shall imply that C.I. will be responsible or liable for any damage to any items placed in this product, whether due to any defect of the product, or its use, whether proper or improper.

EXCLUSIONS

Save as herein provided, C.I. Service Dept. (Canada) or C.I. Service Dept. (USA), there are no other warranties, conditions, representations or guarantees, express or implied, made or intended by C.I. or its authorized distributors and all other warranties, conditions, representations or guarantees, including any warranties, conditions, representations or guarantees under any Sale of Goods Act or like legislation or statute is hereby expressly excluded. Save as herein provided, C.I. Service Dept. (Canada) or C.I. Service Dept. (USA), shall not be responsible for any damages to persons or property, including the unit itself, howsoever caused or any consequential damages arising from the malfunction of the unit and by the purchase of the unit, the purchaser does hereby agree to indemnify and save harmless C.I. from any claim for damages to persons or property caused by the unit.

TO OBTAIN REPAIRS UNDER THE TERMS OF THIS WARRANTY

1. The original purchaser must present a copy of the original bill of sale and the service warranty card.
2. Any alterations, abuse, misuse, battery corrosion or accidental damage voids the warranty.
3. The warranty does not cover cabinets and accessories.
4. No warranty or insurance contained or set out shall apply when damage or repair is caused by power failure; damage in transit or when moving the unit; improper power supply; use for commercial or industrial purposes; service calls resulting in customer education, etc.
5. The defective product should be taken or mailed to:

**Canada
C.I. Service Dept.
315 Attwell Drive
Etobicoke, Ontario.
M9W 5C1**

**U.S.A
C.I. Service Dept.
181 Cooper Avenue
Unit 104
Tonawanda, N.Y.
14150**

For service assistance and product information, please call: 1-800-968-9853.

If mailing the product, the freight must be prepaid and a money order for \$7.00 should be included to cover the cost of insurance and the return of the product.

6. C.I. reserves the right to repair or replace the parts which have become defective.

Model No. _____ Date Purchased _____ Serial No. _____

Curtis International Ltd.
315 Attwell Drive, Toronto, ON, M9W 5C1

Free Manuals Download Website

<http://myh66.com>

<http://usermanuals.us>

<http://www.somanuals.com>

<http://www.4manuals.cc>

<http://www.manual-lib.com>

<http://www.404manual.com>

<http://www.luxmanual.com>

<http://aubethermostatmanual.com>

Golf course search by state

<http://golfingnear.com>

Email search by domain

<http://emailbydomain.com>

Auto manuals search

<http://auto.somanuals.com>

TV manuals search

<http://tv.somanuals.com>