

# Dell™ Streak User's Manual



# Notes, Cautions, and Warnings



**NOTE:** A NOTE indicates important information that helps you make better use of your device.



**CAUTION:** A CAUTION indicates potential damage to hardware or loss of data if instructions are not followed.



**WARNING:** A WARNING indicates a potential for property damage, personal injury, or death.

-----  
**Information in this document is subject to change without notice.**

**© 2010 Dell Inc. All rights reserved.**

Reproduction of these materials in any manner whatsoever without the written permission of Dell Inc. is strictly forbidden.

Trademarks used in this text: *Dell* and the *DELL* logo are trademarks of Dell Inc.

Adobe Acrobat is a trademark of Adobe Systems Incorporated which may be registered in certain jurisdictions; Microsoft, Windows, Microsoft Office Word, Microsoft Office Excel, and Microsoft Office PowerPoint, are either trademarks or registered trademarks of Microsoft Corporation in the United States and/or other countries.

Other trademarks and trade names may be used in this document to refer to either the entities claiming the marks and names or their products. Dell Inc. disclaims any proprietary interest in trademarks and trade names other than its own.

**October 2010**

## **Federal Communications Commission (FCC) Statement**

**This device complies with Part 15 of the FCC Rules. Operation is subject to the following two conditions:**

- 1) this device may not cause harmful interference and
- 2) this device must accept any interference received, including interference that may cause undesired operation of the device.

## **FCC RF Radiation Exposure Statement:**

For body worn operation, this device has been tested and meets FCC RF exposure guidelines when used with an accessory that contains no metal and that positions the handset a minimum of 1.5 cm from the body. Use of other accessories may not ensure compliance with FCC RF exposure guidelines.

# Contents

1	Package Contents	7
2	Dell™ Streak Features	8
3	Setting Up Your Dell™ Streak	12
	<b>Getting Your Device Ready for Use</b>	12
	<b>Turning On Your Device</b>	15
	<b>Turning Off Your Device</b>	16
	<b>Turning Off the Screen</b>	16
4	Understanding Your Dell™ Streak	17
	<b>Out Of Box Wizard</b>	17
	<b>Touch Screen</b>	17
	<b>Screen Orientation</b>	20
	<b>Applications, Widgets, and Shortcuts</b>	20
	<b>The Stage Desktop</b>	21
	<b>Dell™ Stage Widgets</b>	24
	<b>Status Bar</b>	33
	<b>Quick Buttons</b>	36

	<b>Navigating the Applications</b> . . . . .	<b>37</b>
<b>5</b>	<b>Using Your Dell™ Streak</b> . . . . .	<b>40</b>
	<b>Calling</b> . . . . .	<b>40</b>
	<b>Managing Contacts</b> . . . . .	<b>48</b>
	<b>Messaging</b> . . . . .	<b>52</b>
	<b>Pop-up Menu</b> . . . . .	<b>58</b>
	<b>Android Keyboard</b> . . . . .	<b>59</b>
	<b>Swype Keyboard</b> . . . . .	<b>63</b>
	<b>Google Search</b> . . . . .	<b>65</b>
	<b>Power Control widget</b> . . . . .	<b>66</b>
	<b>Managing Your Device Settings</b> . . . . .	<b>67</b>
<b>6</b>	<b>Internet</b> . . . . .	<b>70</b>
	<b>Connecting to the Internet</b> . . . . .	<b>70</b>
	<b>Browsing the Internet</b> . . . . .	<b>73</b>
	<b>E-mail</b> . . . . .	<b>80</b>
	<b>Web Applications</b> . . . . .	<b>83</b>
	<b>Synchronizing Your Google Data</b> . . . . .	<b>122</b>
<b>7</b>	<b>Customizing Your Dell™ Streak</b> . . . . .	<b>123</b>
	<b>To change display settings</b> . . . . .	<b>123</b>

	To change sound and ringtone settings . . . . .	124
	To manually set the date, time, and time zone	126
	To choose a language. . . . .	127
8	Protecting Your Dell™ Streak . . . . .	128
	Protect Your Device Data With a Screen Unlock Pattern. . . . .	128
	Protect Your Device Data With a PIN . . . . .	130
	Protect Your Device Data With a Password . . . . .	131
	Protect Your SIM Card With the SIM Lock Password . . . . .	132
9	Applications. . . . .	133
	Camera . . . . .	133
	Copying Files to and from MicroSD. . . . .	136
	Bluetooth®. . . . .	137
	Gallery . . . . .	140
	Music . . . . .	143
	Calendar . . . . .	146
	Clock . . . . .	149
	Calculator . . . . .	151
	Sound Recorder . . . . .	152
	Voice Dialer. . . . .	152

<b>SIM Manager</b> . . . . .	<b>153</b>
10 Playing Videos on HDMI Devices . . . . .	154
11 Troubleshooting . . . . .	155

# Package Contents

Your device may come with varying accessories. Check the contents of your package to verify that you have the following:



**NOTE:** Availability of accessories may vary depending on the country/region where you purchased the device.

## U.S.A

Streak device

Battery

Quick Start Guide

Safety, Environmental, and Regulatory Information

Warranty Service Information

USB cable

Charger

US plug

Pouch

Headset with mic

## Europe

Streak device

Battery

Quick Start Guide

Safety, Environmental, and Regulatory Information

Warranty Service Information

USB cable

Charger

UK plug





EURO plug

Pouch

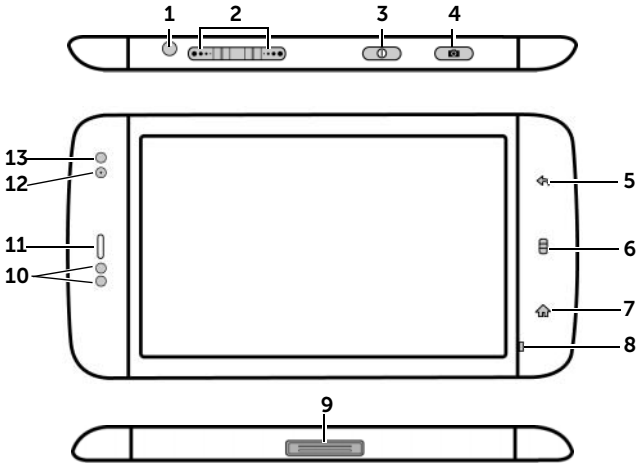



Headset with mic



# Dell™ Streak Features



Buttons/Connectors/Parts	Functionality
1 Headphone connector	Connects to headphones.
2 Volume up/down button Landscape mode: Volume up button  / Volume down button  Portrait mode:  Volume up button  Volume down button	<ul style="list-style-type: none"> <li>While playing media such as music tracks or video clips: <ul style="list-style-type: none"> <li>Press to increase or decrease the media volume by one level.</li> <li>Press and hold to continuously increase or decrease the media volume.</li> </ul> </li> <li>Press either button to mute the ringer while receiving a call.</li> <li>In all other situations: <ul style="list-style-type: none"> <li>Press to increase or decrease the ringer volume by one level.</li> <li>Press and hold to continuously increase or decrease the ringer volume.</li> </ul> </li> </ul>



Buttons/Connectors/Parts	Functionality
<p>3 Power and Sleep/Wake button</p> 	<ul style="list-style-type: none"> <li>• If the device is off, press and hold to power on the device.</li> <li>• If the device is on, but the screen is off, press to turn on the screen.</li> <li>• If both the device and the screen are on, <ul style="list-style-type: none"> <li>– Press to turn the screen off.</li> <li>– Press and hold to select one of these options: <p><b>Silent mode:</b> The device does not vibrate and disables all sounds except for alarms.</p> <p><b>Airplane Mode:</b> Select to disable all wireless connections.</p> <p><b>Power off:</b> Turn off the device.</p> </li> </ul> </li> </ul>
<p>4 Camera button</p> 	<ul style="list-style-type: none"> <li>• If the camera is not active, press and hold to start the camera.</li> <li>• If the camera is active, press to capture a photo or record a video.</li> <li>• When recording a video, press to stop.</li> </ul>
<p>5 Back button</p> 	<p>Touch to return to the previous screen, close a dialog box, menu, or pop-up message, and to dismiss the keyboard.</p>
<p>6 Menu button</p> 	<ul style="list-style-type: none"> <li>• Touch to open or close the pop-up menu displaying available options for the current application or actions that you can perform on the current screen.</li> <li>• Touch and hold to bring up the on-screen keyboard for text input.</li> </ul>

Buttons/Connectors/Parts	Functionality
7 Home button 	<ul style="list-style-type: none"> <li>• Touch to return to the Home screen.</li> <li>• Touch and hold for quick access to the recently accessed applications.</li> </ul>
8 Microphone	Use for voice calls
9 30-pin connector	<ul style="list-style-type: none"> <li>• Connects to a USB cable to transfer files to a computer.</li> <li>• Connects to a charger to charge the device.</li> <li>• Connects to the Home Dock for audio and video output.</li> </ul>
10 Proximity sensors	Turn off the screen as you bring the device close to your face to make or receive a call, in order to prevent unintentional touches.
11 Earpiece	Use to listen to phone conversations.
12 Front-facing camera lens	Use for taking a front view picture, e.g. self-portrait.
13 Ambient light sensor	<p>Controls screen brightness according to the surrounding lighting conditions.</p> <p><b>NOTE:</b> To enable the ambient light sensor, touch the Home button  → Menu button , and then select <b>Settings</b> → <b>Display</b> → <b>Brightness</b>. <b>Automatic brightness</b></p>

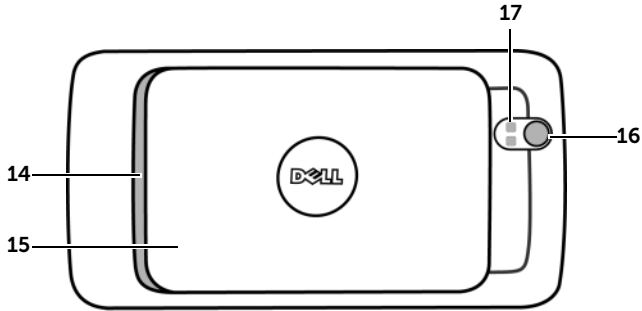

Parts/controls	Functionality
<b>14</b> Speaker	Audio output for video and music playback.
<b>15</b> Back cover	Secures the battery in place.
<b>16</b> Camera lens	Captures pictures and videos.
<b>17</b> Camera flash	For using flash to take pictures.

# Setting Up Your Dell™ Streak

## Getting Your Device Ready for Use

### 1 Remove the back cover

- a Slide the back cover downwards in the direction towards the end of the device.
- b Lift the back cover off the device.

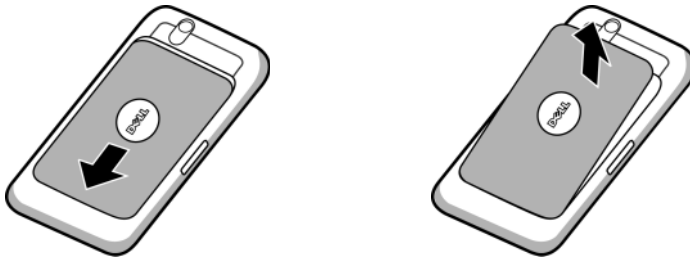

 **NOTE:** The device will shut down automatically if you remove the back cover while the device is on.

 **NOTE:** You cannot turn on the device if the back cover is removed.

### 2 Insert the SIM card

Insert the SIM card in the illustrated direction under the metal plate that covers the SIM card holder.



 **NOTE:** If you have trouble inserting the card, ensure that you have aligned the angled corner on the card with the corner of the card holder.

### 3 Insert the battery

Align the metal contacts on the battery with the contacts on the battery holder and insert the battery.

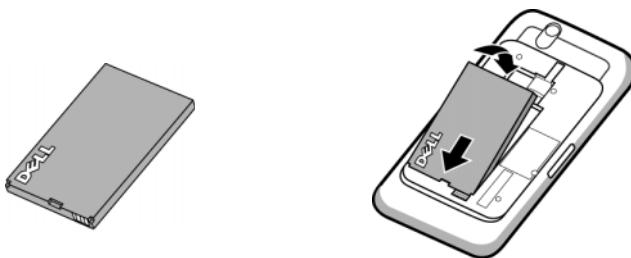

### 4 Install the microSD card

- a Hold the microSD card with the metal contacts facing down.
- b Slide the microSD card into the microSD card holder.

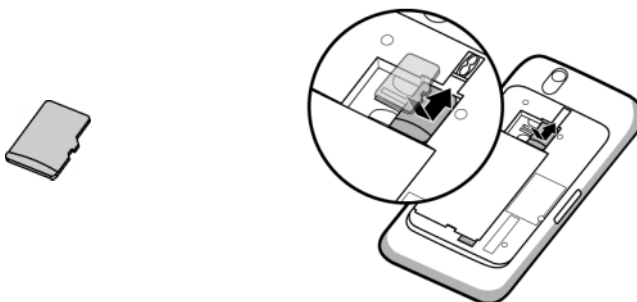

## 5 Close the back cover

- a Push the end of the back cover against the groove near the bottom of the device.
- b Place the cover onto the back of the device, and then push the cover towards the top of the device to secure the cover in place.



## 6 Charge the device

 **NOTE:** Charge the battery in an environmental temperature between 0°C and 45°C.

The battery is not fully charged when first unpacked.

- a Plug the supplied USB cable's 30-pin connector into the 30-pin connector on the device.
- b Plug the cable's USB connector into the supplied USB wall charger adaptor.
- c Plug the USB wall charger adaptor into a power outlet and charge the device till the battery is fully charged.

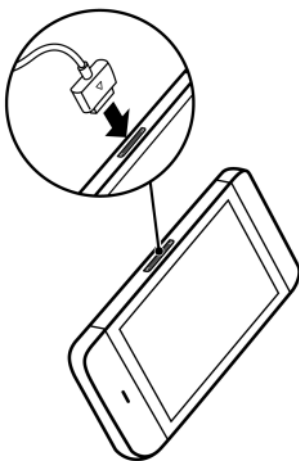



**NOTE:** The device is fully charged within four hours from a power outlet.

**NOTE:** To charge your device using a computer, connect the supplied USB cable's 30-pin connector to the device, and the cable's USB connector to a USB port on the computer.

## Turning On Your Device

 **NOTE:** Use this device in an environmental temperature between -10°C and 55°C.

- 1 Press and hold the Power button  to turn on your device. The operating system starts up.
- 2 If the screen is locked automatically, flick the  icon to unlock the screen.

- 3 If your SIM card is locked by a Personal Identification Number (PIN), type the PIN by touching the corresponding number keys using the on-screen keypad. Touch the **OK** button to confirm your input.
- 4 The device is ready for use when the home screen is displayed.

## Turning Off Your Device

- 1 Press and hold the Power button .
- 2 Touch the Power off option on the screen.

## Turning Off the Screen

If both the device and the screen are on, press the Power and Sleep/Wake button  to turn off the screen.





**NOTE:** If the device is on, but the screen is off, press the Power and Sleep/Wake button  to turn on the screen. For how to unlock the screen, see The Screen Lock Wallpaper.



# Understanding Your Dell™ Streak

## Out Of Box Wizard

To view the on-screen Out Of Box Wizard for basic controls of your device, touch the Home button  → the Launcher button  → **welcome**, and follow the instructions to proceed.

The wizard has demonstrative videos that you can play, pause or skip, giving you a quick overview of the device.

At any point during the video, you can touch **CONTINUE** and **PREVIOUS** to go to next or previous page.

After viewing the last page, touch **DONE** to return to the Home screen.

## Touch Screen

Your device has a multi-touch sensitive screen. You can touch the surface of the screen to operate the device.

Finger Gestures	Allows you to:
<p><b>Touch</b></p> <p>Tap gently on the screen with your fingertip.</p> 	<ul style="list-style-type: none"><li>• Select the items on the screen including options, entries, images, and icons.</li><li>• Start applications.</li><li>• Press the buttons on the screen.</li><li>• Input text using the on-screen keyboard.</li></ul>

---

## Finger Gestures

---

Allows you to:

### Touch and hold

Touch and hold your finger on the screen.



- Enable the moving mode of an item on the Home screen.
- Open the context menu.

---

### Drag

- 1 Touch and hold your finger on an item on the screen.
- 2 Keeping your finger in contact with the screen, move your fingertip to the desired location.
- 3 Take your finger off the screen to drop the item in the desired location.

- Move items such as images and icons on the screen.
- Scroll through Home screens, web pages, lists, entries, photo thumbnails, contacts, and so on.



---

## Finger Gestures

---

## Allows you to:

### Flick or swipe

Move your finger in a vertical or horizontal direction on the screen.

Quickly scroll through Home screens, web pages, lists, entries, photo thumbnails, contacts, and so on.



---

### Zoom-out

Move two fingers close together on the screen.

Reduce the view of an image or web page (zoom out).



---

## Finger Gestures

Allows you to:

---

### Zoom-in

Move two fingers apart on the screen. Enlarge the view of an image or web page (zoom in).



---

## Screen Orientation

For optimal viewing experience, the screen orientation changes automatically to portrait or landscape format depending on how you hold the device.



**NOTE:** Applications downloaded from the Android Market may not support automatic screen rotation to portrait or landscape format.



**NOTE:** To modify the default rotating behavior, open the rotation settings by touching the Home button → Menu button → Settings → Display → Auto-rotate screen.

## Applications, Widgets, and Shortcuts

**Application** - Software which allows you to perform a specific task. Your device is preloaded with a variety of applications, and additional ones can be downloaded from the Android Market.

**Widget** - A small application which resides on the Home screen and provides quick and easy access to information. For example, the Facebook widget allows you to read posts on your wall and update your status.

**Shortcut** - A link that you can put on your Home Screen to provide quicker access to an application or a folder containing contacts or bookmarks.

## The Stage Desktop



As part of the new Dell™ Stage interface, the Stage desktop is composed of seven individual screens including the Home screen. The desktop displays predefined Stage widgets, shortcuts, and widgets to give you quick and easy access to frequently-used applications, Twitter or Facebook postings, music, pictures, and more.



You can customize the Stage desktop to your personal preferences by adding your own shortcuts or widgets, or by displaying your favorite picture as the desktop wallpaper.

 **NOTE:** The desktop screens are fixed, and cannot be added or deleted.

 **NOTE:** For more information on using Dell Stage widgets, see "Dell™ Stage Widgets" on page 24.

 **NOTE:** To return to the Home screen from anywhere, touch the Home screen button .

## To navigate across the desktop

Flick the desktop horizontally until the desired Home screen is displayed.



## To control the Home screens using Home screen thumbnails

The Home screen thumbnails work as shortcuts to their individual Home screens. The icon of the thumbnail will change to represent the Stage widget displayed on the Home screen.

- To bring up the Home screen thumbnails:



- 1 Touch the bottom area on either side of the quick buttons, as illustrated in red.
- 2 Touch and hold the Launcher button  to display the thumbnails.

- To control the Home screens using the thumbnails, either:
  - Touch the corresponding thumbnail to go to the desired screen.



Home screen thumbnails

- To quickly pan through the Home screens, drag your finger horizontally across the shortcuts, until the desired Home screen appears.



# Dell™ Stage Widgets

Dell™ Stage gives you direct access to your most recently-used applications, e-mails, photos, music, videos, contacts, Facebook & Twitter updates, and frequently-used websites.

You can create your own Stage widgets on free desktop screens to access applications easily and quickly.

## Adding a Stage Widget

- 1 Flick to the desktop screen where you want to add a Stage widget.
- 2 To reserve enough space for the widget, remove unwanted items from the screen. See "To remove a Home screen item" on page 32.
- 3 To access the **Add to Home screen** menu, either:
  - Touch and hold an empty area on the home screen.
  - Touch the Menu button  and then touch the **Add** option.
- 4 Touch **Stage Widgets**.
- 5 From the **Select Stage Widget** menu, touch to select the Stage widget you want to add to the screen.

## Deleting a Stage Widget

- 1 Touch and hold the Stage widget.
- 2 Drag the widget over the  icon.
- 3 When the widget turns red, release your finger from the screen to delete the widget.



## Using Stage Widgets

Touching the label of any Stage Widget opens the supporting application to its default screen. For example, touching the label of the **MUSIC** widget opens up the **Music** player just as it would by touching the **Music** icon in the application drawer.

### To use the HOME Stage widget

From the **HOME** Stage widget, you can touch application shortcuts to access your most recently-used applications.

### To use the CONTACTS Stage widget

From the **CONTACTS** Stage widget, you can view your existing contacts or add a new contact quickly.

- Touch the tile of an existing contact and select the action to proceed with the contact.
- Touch the **ADD** tile to add a new contact.

### To use the EMAIL Stage widget

From the **EMAIL** Stage widget, you can read your e-mails in your e-mail account or compose a new e-mail. If you have not set up an e-mail account, touch **Add an Account** and follow the on-screen instructions to complete your e-mail configuration.

### To use the GALLERY Stage widget

From the **GALLERY** Stage widget, you can view thumbnails of your recent pictures and videos from the **Gallery** application. Touch the thumbnail of a picture or video to view or play it back.

### To use the MUSIC Stage widget

From the **MUSIC** Stage widget, you can view the music albums or playlists created on your device.

- Touch a music album to browse for its songs. Touch a song to start playback.
- Touch a playlist to view the playlist you created. Touch a song to start playback.

## To use the SOCIAL Stage widget

The **SOCIAL** Stage widget provides widgets to display the latest postings from your Twitter or Facebook account. To use the Twitter and Facebook widgets, you need to sign in to your Twitter or Facebook account with your e-mail address and password.

### The Twitter widget

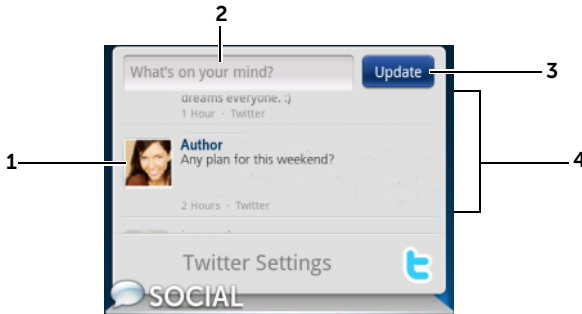

- 1 Touch to view the tweets (Twitter messages) posted by the authors you follow.
- 2 To post your tweet, touch the text box, type your tweet, and then touch **Update**.
- 3 You can also touch the **Update** button to compose and post your tweet.
- 4 Flick through tweets posted by the authors you follow.





**NOTE:** For more information on using Facebook and Twitter, see Facebook and Twitter.

## To use the WEB Stage widget

The **WEB** Stage widget shows your recently-visited websites and bookmarks. Touch the web site you want to visit, or touch **MORE BOOKMARKS** to select a website to visit.



To find information on the Internet, you can also:

- Touch the Google search text box on the top of the widget, enter the name or keyword of the topic you look for, and touch the  key on the keyboard or the search icon  on the search box.

- Touch  on the right corner of the search box, and say the name or keyword of the topic you are looking for.

## Customizing Your Home screen



### To add an item to a Home screen

- 1 Touch the Home button .
- 1 Flick to the screen where you want to add the item.
- 2 To access the **Add to Home screen** menu, either:
  - Touch and hold an empty area on the home screen.
  - Touch the Menu button  and then touch the **Add** option.
- 3 Touch the item you want to add on the Home screen:

Items	Steps
<b>Shortcuts</b> Add shortcuts for items that you wish to access directly from the Home screen.	<ul style="list-style-type: none"> <li>• <b>Applications:</b> <ol style="list-style-type: none"> <li>1 Scroll through the application menu to locate the desired application.</li> <li>2 Touch the desired application to create the shortcut on the current Home screen.</li> </ol> </li> <li>• <b>Bookmark:</b> <ol style="list-style-type: none"> <li>1 Flick through the Bookmarks list to locate the desired bookmark.</li> <li>2 Touch the desired bookmark to create the shortcut on the current Home screen.</li> </ol> </li> <li>• <b>Contact:</b> <ol style="list-style-type: none"> <li>1 Flick through the Contacts entries to locate the desired contact.</li> <li>2 Touch the desired contact entry to create the shortcut on the current Home screen.</li> </ol> </li> <li>• <b>Direct dial:</b>            Touch the desired phone number to create the shortcut on the Home screen. You can touch the shortcut to dial the number directly.         </li> <li>• <b>Direct message:</b>            Touch the desired phone number to create the shortcut on the Home screen. You can touch the shortcut to compose and send a message to the number.         </li> </ul>

Items	Steps
Shortcuts	<ul style="list-style-type: none"> <li>• <b>Directions &amp; Navigation:</b> Create a shortcut that you can touch to open Google Maps and view directions to a location. <ol style="list-style-type: none"> <li>1 Enter your destination in the text box.</li> <li>2 Choose how you want to get to your destination by touching the driving, public transportation, or walking icon (from left to right).</li> <li>3 Enter a name for the shortcut.</li> <li>4 Touch the shortcut icon that you want to use for the shortcut.</li> <li>5 Touch the <b>Save</b> button.</li> </ol> <p><b>NOTE:</b> For more information on getting directions using Google Maps, see To get directions.</p> <ul style="list-style-type: none"> <li>• <b>Gmail label:</b> Touch to create a desired Gmail label shortcut so that you can access your e-mails with that label from the desktop.</li> <li>• <b>Latitude:</b> Create a shortcut that you can touch to open Google Latitude to share locations with your friends and family who have signed in to the service with their Google accounts.</li> <li>• <b>Music playlist:</b> Create a <b>Play all</b> or a <b>Recently added</b> shortcut that you can touch to play all songs or recently added songs.</li> <li>• <b>Settings:</b> <ol style="list-style-type: none"> <li>1 Scroll through the settings to locate the desired one.</li> <li>2 Touch the desired setting to create the shortcut on the current Home screen, where you can touch the shortcut to access the setting.</li> </ol> </li> </ul> </li> </ul>

Items	Steps
<p><b>Widgets</b></p> <p>Add widgets to display active Home screen windows or controls for your favorite applications or web-based services, such as an analog clock, the music player, the Google Quick Search Box, or a calendar showing upcoming events.</p>	<ol style="list-style-type: none"> <li><b>1</b> Touch and hold an empty area on a Home screen.</li> <li><b>2</b> Touch <b>Widgets</b> in the <b>Add to Home screen</b> menu that appears.</li> <li><b>3</b> Flick through the available applications or services to locate the desired one.</li> <li><b>4</b> Touch the desired widget to add it on the Home screen.</li> </ol>
<p><b>Folders</b></p> <p>You can create the following folders:</p> <p><b>New folder:</b> Add a folder where you can store your Home screen shortcuts.</p> <p><b>All contacts:</b> Add a shortcut to all your contacts stored in the Contacts application.</p> <p><b>Bluetooth received:</b> Add a shortcut to access files received through Bluetooth®.</p> <p><b>Contacts with phone numbers:</b> Add a shortcut to the contacts with phone numbers.</p> <p><b>Starred contacts:</b> Add a shortcut to the contacts marked with a star.</p>	<p>Touch the desired folder to create one on the Home screen.</p> <p>Once the folder is on your Home screen, you can drag and drop an item on top of the folder in order to add it to the folder.</p>

Items	Steps
<p><b>Wallpapers</b></p> <p>Change the wallpaper of your Home screen.</p> <p><b>NOTE:</b> You can also touch the Home button  → the Menu button  → <b>Wallpaper</b> to change your Home screen wallpaper.</p>	<ul style="list-style-type: none"> <li>• <b>Gallery:</b> Open the Gallery application and select a saved picture as a wallpaper, or touch  to open the camera application and capture a picture that you can set as a wallpaper.</li> </ul> <ol style="list-style-type: none"> <li>1 Touch a picture category from your collection, such as <b>Camera</b>, <b>downloaded</b>, and so on.</li> <li>2 Flick the picture thumbnails horizontally to locate the desired picture.</li> <li>3 Touch the picture to display it.</li> <li>4 To cut a portion of the picture as the wallpaper, move the crop frame and drag the angles to locate the desired part.</li> <li>5 Touch the <b>Save</b> button to set the wallpaper.</li> </ol> <ul style="list-style-type: none"> <li>• <b>Live wallpapers:</b> Select an animated and interactive wallpaper.</li> <li>• <b>Wallpapers:</b> Flick to or touch a picture thumbnail to display a picture, then touch <b>Set wallpaper</b> to set it as a wallpaper.</li> </ul>

### To add an application shortcut from the main applications view

- 1 Touch the Launcher button  at the bottom of the screen to enter the main applications view.
- 2 On the main applications view, touch and hold a desired application and drag it onto the current Home screen, then the application's icon appears on the Home screen.

### To move a Home screen item

- 1 Touch and hold the item you want to reposition until it magnifies and becomes movable. The device vibrates to indicate that the item's moving mode is activated.



**NOTE:** To disable the item's moving mode, release the item.

- 2 With your finger remaining in contact with the item on the screen, drag the item to another location on the screen.
- 3 Release the item in the desired location.

### To remove a Home screen item

- 1 Touch and hold an item such as a widget, shortcut, or folder that you want to remove, until it magnifies and becomes movable.
- 2 Drag the item onto the top of the Trash icon , and when the item turns red release it.

### To open a Home screen folder

- 1 Touch the folder to open a black panel displaying the contents of the folder.
- 2 Touch the desired application shortcut to run the application.

### To close a Home screen folder

Touch the Close icon  to close the black panel.

### To move a Home screen shortcut into a folder

- 1 Touch and hold a shortcut to make it movable.
- 2 Drag and drop the shortcut into a folder on the Home screen.



**NOTE:** Widgets and folders cannot be moved inside a folder.

### To remove a Home screen shortcut from a folder

- 1 Touch a folder on the Home screen to view the contents.
- 2 Touch and hold a shortcut to make it movable. The shortcut jumps out and the folder closes automatically.
- 3 Drag the shortcut to another location on the Home screen.



## To rename a Home screen folder

- 1 Touch a folder to open the folder panel.
- 2 Touch and hold the top area of the folder panel  
, until the **Rename folder** menu opens.
- 3 Touch the **Folder name** text box to type the name using the on-screen keyboard.
- 4 Touch **OK** to confirm.





























## Status Bar

The status bar at the top of the Home screen displays the notification, status, and time areas.

























- |                     |   |
|---------------------|---|
| 1 Notification area | <ul style="list-style-type: none"><li>• The notification area displays notification icons to inform you of missed calls, new e-mail, messages, and so on.</li><li>• Touch and drag down the status bar to view the notifications listed in the order of arrival time, and then touch a notification to view the desired message, e-mail, or missed call record.</li></ul> |
| 2 Status area       | <ul style="list-style-type: none"><li>• Displays status icons to show the current state of your device, such as battery power, charging progress, alarms set, network connections, and so on.</li><li>• Touch and drag down the status bar to view the information regarding the carrier currently in use, remaining battery charge, and so on.</li></ul>                 |
| 3 Time area         | Displays the current time.  |

**The status area may also display some of the following icons:**

 Alarm is set	 3G data network is connected
 Battery status — 100% full	 3G data network is in use
 Battery is low and needs to be charged	 GPRS data network is connected
 Battery is extremely low and needs to be charged immediately	 GPRS data network is in use
 Battery is charging	 EDGE data network is connected
 Vibrate mode is enabled	 EDGE data network is in use
 Silent mode is enabled	 HSPA data network is connected (only available for carrier-specific versions)
 Microphone is on mute	 HSPA data network is in use (only available for carrier-specific versions)
 Speakerphone is on	 Roaming signal strength — strong
 Signal strength — strong	 Connected to a Wi-Fi network
 No signal	 No SIM card is inserted
 Airplane mode is enabled	 GPS satellites function is enabled
 Bluetooth is enabled	 Receiving location data from GPS satellites
 Connected to a new Bluetooth device	 Ongoing data synchronization

**The notification area may also display some of the following icons:**

 Missed call	 Problem with sign-in or sync
 Call in progress	 SD card is full
 Call on hold	 A Wi-Fi network is found
 Call forwarding is enabled	 USB cable is connected
 Call in progress using a Bluetooth headset	 Some notifications not displayed
 New Gmail message	 New e-mail message
 New SMS/MMS	 Download in progress
 Problem with SMS/MMS delivery	 Download finished
 New Google Talk message	 Application update available
 New voicemail	 The SD card is safe to remove
 Upcoming calendar event	 Song is playing

# Quick Buttons

The quick buttons at the bottom of the Home screen allows you to quickly access the application drawer and some main functions.

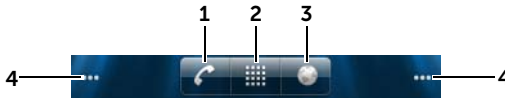

---

**1** Phone button





Touch the Phone button  to open the **Phone** application to make calls or find contacts.

---

**2** Launcher button



- Touch the Launcher button  to display the applications menu.
  - Touch and hold the Launcher button  to display shortcuts to the Home screens.
- 

**3** Browser button



Touch the Browser button  to open the **Browser** application.

---

**4** Home screen dots

Touch the dots at the bottom right and left of the screen to move to the desired room of the Home screen.

---



# Navigating the Applications

You can find applications available on your device in these screen elements:

## Application Drawer

The application drawer can be accessed from any home screen and contains all of the applications installed on the device, including those you have downloaded from the Android Market.



### To open the application drawer

- 1 Touch the Home button  to display the default Home screen on the desktop.
- 2 From any of the desktop Home screens, you can:
  - Drag up in the lower area of the screen.
  - Touch the Launcher button .

### To navigate pages of applications

Flick the applications drawer horizontally and touch an application to run it.

### To close the application drawer

- Drag down anywhere within the application drawer.
- To return to the default Home screen, touch .
- To return to the current Home screen, touch .

## Application Shortcuts

To quickly launch applications on the Home screen, you can add shortcuts for frequently-used applications to the Home screen or to the folder that you created on the Home screen. For more information, see "Customizing Your Home screen" on page 27.

### To open an application using the application shortcuts

- 1 Touch the Home button .
- 2 If the desired application shortcut displays on the Home screen, touch the shortcut to run the application.  
If the desired application is stored in a folder on the Home screen, touch the folder to display the contents of the folder, and then touch the desired application shortcut.

## Recent Applications

### To open a recently used application

- 1 Touch and hold the Home button  to view the recently used applications, or create the **HOME** Stage widget on the Home screen which contains the most recently used applications. See Adding a Stage Widget.
- 2 Touch the desired application shortcut to run the application.

## The Screen Lock Wallpaper

You can set the display to turn off automatically after a timeout period of inactivity, or turn it off manually by pressing the power button .

When you press the power button  to wake up the display, the screen lock wallpaper appears to help prevent unintentional touches of the screen, and displays current time, date, and the alarm set indicator.

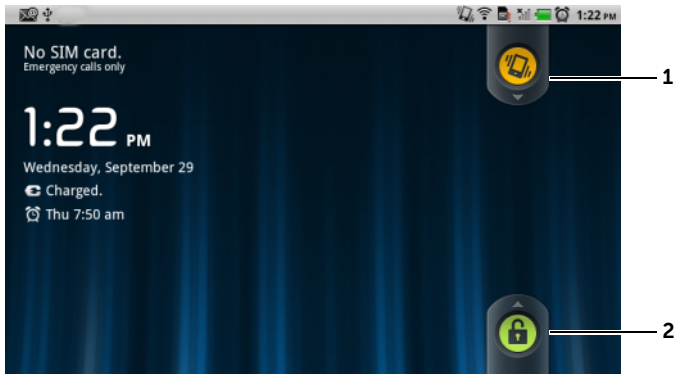

---



**1** Drag or flick this button downward to enable or disable the vibration mode.

---

**2** Drag or flick this button upward to unlock the screen.

---







**NOTE:** To set how long the screen remains on before turning off after the last operation, touch the Home button  → Menu button  → **Settings** → **Display** → **Screen timeout**.

# Using Your Dell™ Streak

## Calling

### Making Calls







#### To open the Phone application

- Touch the Phone button  on the Home screen to open the Phone application quickly.
- Touch the Home button  → the Launcher button  → **Phone**  on the Home screen.



## To make a call



- 1 Touch to select a contact from your Favorites contact list.
  - Touch  next to a contact to call the contact directly.
  - Touch a contact and then touch  to call, touch  to text message, or touch  to e-mail the contact.
- 2 Touch to select a contact from your Contacts list. Touch a contact and then touch  to call, touch  to text message, or touch  to e-mail the contact.
- 3 Touch to view the call log.
- 4 Touch to open the on-screen dialpad.
- 5
  - Touch to bring up the additional keypad.
  - Touch to move the cursor.
  - Touch and hold to open the **Edit text** context menu, which allows you to select, cut, copy, and paste numbers, and select the input keypad to use.

---

**6** Type the number to call using the on-screen dialpad.

---

**7** Touch to call your voicemail box.

**NOTE:** If no voicemail number is stored on your SIM card, you will be prompted to enter a number. Touch **Add number** to enter and save your voicemail number.

---

**8** Touch to call the typed number.

---

**9** Touch to clear an incorrect number; touch and hold to clear all the entered numbers.

---



**10** Touch to make a call using voice commands.

---

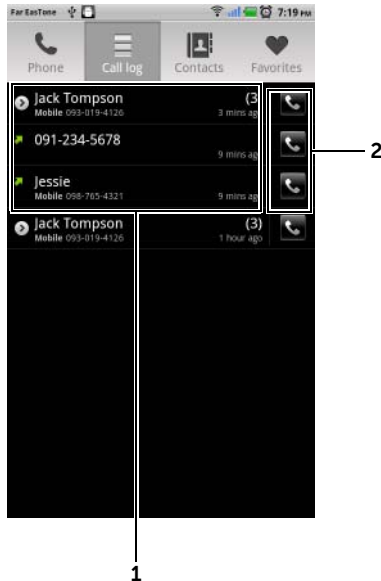
## To use the call log



1

- Touch a contact and then touch  to call, touch  to text message, or touch **View contact** to view the information of the contact.
- Touch a phone number and then touch **Add to contacts** to save the caller in Contacts.
- If a caller entry shows the number of calls, touch the caller to view all the calls from the caller.
- Touch and hold a contact or phone number to remove it from the call log.

**NOTE:** To erase all calls from the call log, touch the Menu button  → **Clear call log** → **OK**.

2

Touch to call a contact or phone number directly.

## To call a number with an extension

- 1 Type the number to call using the on-screen dialpad.
- 2 Touch and hold the asterisk key on the dialpad until “p” appears.

- 3 Type the extension.
- 4 Touch  to make a call.

### To make an international call

- 1 Touch and hold the number 0 key on the dialpad until "+" appears.
- 2 Enter the country code, area code, and phone number.
- 3 Touch  to make a call.

### To listen to your voicemail

Touch  or touch and hold the number 1 key on the dialpad to call your voicemail box.

 **NOTE:** If no voicemail number is stored on your SIM card, you will be prompted to enter a number. Touch **Add number** to enter and save your voicemail number.

### To answer or reject an incoming call

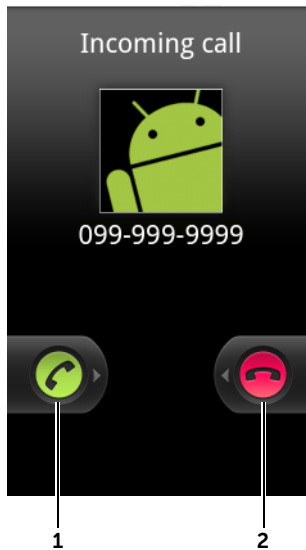





- 
- 1 Drag right to answer an incoming call.
-

- 
- 2 Drag left to reject an incoming call.
- 

### Controls during a call



- 
- 1
- Touch to hold an active call. To resume a held call, touch .
  - Touch  to swap between active and held calls.
- 
- 2
- Touch  to bring up the dialpad and make another call. The first call is placed on hold automatically.
  - Touch  to connect active and held calls to have a conference call.
- 
- 3
- Touch to accept calls using a Bluetooth headset when a Bluetooth headset is connected to your device. For information on connecting a Bluetooth headset to your device, see "Bluetooth®" on page 137
- 
- 4
- Touch to mute the microphone during a call.
-

---

5 Touch to turn the speaker on or off.



**WARNING:** Ensure that you turn off the speaker before you hold the device close to your ear as this could damage your hearing.

---

6 Touch to open the dialpad for dialing.



---

7 Touch to end an active call or cancel dialing.

---

## Adjust Call Settings

You can change call settings to suit your personal needs, or enable the call services available from your network service provider.

Touch the Home button  → Menu button  → **Settings** → **Call settings**.

---

**Fixed Dialing Numbers (FDN)** Restricts outgoing calls to the phone numbers on the FDN list. To enable this service, you need to enter your SIM card's PIN2 that you can obtain from your network service provider.

---

**Voicemail**

- **Voicemail service:** Displays the name of your carrier.
- **Voicemail settings:** Stores another voicemail number other than the one already on your SIM card.

---

---

## Other call settings

- **Call forwarding:** Diverts incoming calls to a designated phone number when your device is busy, unreachable, does not answer, or if you want to always forward calls.

To enable call forwarding, enter the number to divert to or touch  to select a contact from your Contacts list. Then touch **Enable**.

**NOTE:** Your device can use Call forwarding only if the Call forwarding function is supported by your network service provider.

- **Call barring:** Blocks certain types of incoming or outgoing calls.

- **Additional settings:**

– **Caller ID:** Shows the caller ID or number on the display based on the setting.

**NOTE:** Your device displays the caller ID only if the caller ID function is supported by your network service provider.

– **Call waiting:** Alerts an incoming call with a call waiting tone or message when you are on another call.

**NOTE:** To use call waiting, you may need to register this service with your service provider.



- **Auto Answer:** Sets how long your device waits before automatically answering an incoming call.
- **TTY mode:** Enable Teletypewriter (TTY) mode to let the user with speech or hearing disabilities conduct a phone conversation by typing.
- **Hearing aids:** Enable Hearing Aid Compatible (HAC) mode to minimize interference from the device with the user's hearing aid, and optimize audio output for the hearing aid.

**NOTE:** Enabling the HAC mode disables the Bluetooth and Wi-Fi transmitter functions.

---

# Managing Contacts

To view and manage your contacts:

- Touch **Contacts** 
- Touch  →  **Contacts**.

## To add a new contact

- 1 Touch the Menu button  → **New contact**.
- 2 Select the account where you want to add this contact, such as your Gmail account.

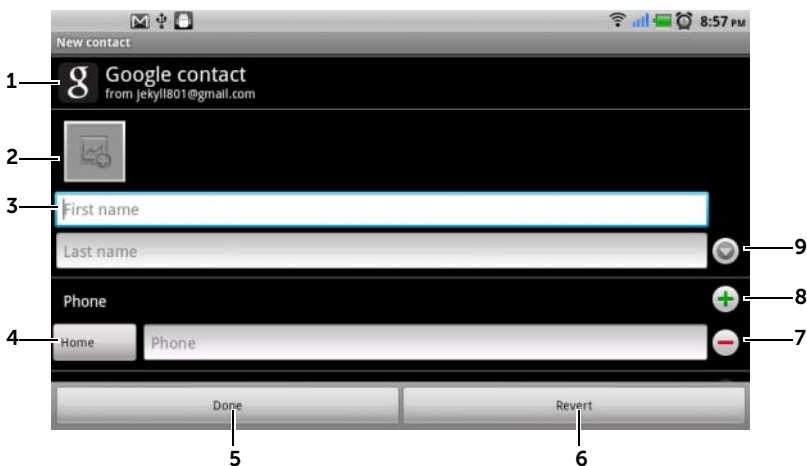

- 1 This area shows the account in which the new contact is stored.
- 2 Touch to take a photo or select a photo from the **Gallery** application to use as the contact's visual caller ID.
- 3 Enter the contact information using the on-screen keyboard. Scroll the screen to find more items to fill.
- 4 Touch to replace a default information label with another one that you choose from the **Select label** list, for example from **Mobile** phone number to **Home** phone number.
- 5 Touch **Done** to save the new contact to your Contacts list.



- 
- 6 Touch to return to your Contacts list.

---

  - 7 Touch to remove an item from the current information category.

---

  - 8 Touch to add a new item to the current information category, for example a second phone number.

---

  - 9 Touch to fill more name information.

---

### To find a contact

- 1 To locate a contact, you can either:
  - Flick the contact list until you find the contact.
  - Touch the Menu button  → **Search**, and then type either the contact's full name or only the first letters of it into the **Search contacts** text box. The screen displays the matching contacts.
- 2 Once the contact is located, touch the contact's entry to view the contact's details.

### To call, e-mail, or send a message to a contact

- From the Contacts list, select a desired contact.



- 
- 1 Touch to see the actions that you can do with the contact.

---

  - 2 Touch to call the contact.

---

  - 3 Touch to text message the contact.

---

  - 4 Touch to e-mail the contact using your available e-mail accounts.

---

  - 5 Touch to view the contact's address using Google Maps.

---

- When viewing the contact details.

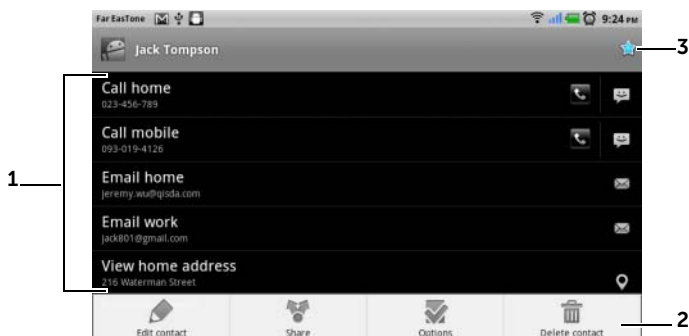

---

**1** Touch an action you want to do with the contact.

---

**2** Touch the Menu button  to edit the contact details or share the contact info with your friends through e-mail or Bluetooth. To designate a ringtone for the contact's incoming calls, or to let your device automatically send the contact's calls to your voicemail box, touch **Options**.

---

**3** Touch to add this contact to your Favorites list.

---



**NOTE:** For information about composing and sending SMS and MMS, see Messaging. For information about using the e-mail applications, see Gmail and E-mail.

## Contacts settings

In **Contacts**  or **Phone**  →  **Contacts**, touch the Menu button .

---

### Display options

Choose from which accounts you want to display the contacts, or set your device to only display the contacts who have phone numbers.



---

### Accounts

Contacts stored on your personal e-mail account like Gmail can be synchronized through an Internet connection.

- To select the data to synchronize:
  - 1 Select **Background data** to make all the sync options available.
  - 2 Select **Auto-sync** to let the device automatically synchronize the selected data in your e-mail account, which may include Contacts, Gmail, Calendar, Picasa Web Albums, or Twitter data.
- To select the data to sync from your e-mail account:
  - 1 Touch your e-mail account to open the **Data & synchronization** list.
  - 2 Select the data that you want the device to synchronize automatically, such as **Sync Contacts, Sync Gmail, Sync Calendar, Sync Picasa Web Albums, and Sync Twitter data.**

**NOTE:** If you wish to synchronize individual data manually, clear **Auto-sync**, and then from your account, touch a data item to start synchronization of that data.

**NOTE:** While data is syncing, the sync icon  appears on the status bar, and the sync icon  appears on the option of the data being synced.



---

### Import/Export

You can import contacts from your SIM/SD card to your device, export contacts from your device to your SD card, and share visible contacts using Bluetooth or Gmail.



---

# Messaging

To compose, send, and read text (SMS) or multimedia (MMS) messages, touch  → **Messaging** . The Messaging screen opens with a list of messages or message threads representing all the received, sent, and draft messages.



 **NOTE:** For information about the message thread, see Receiving text and multimedia messages.



## To compose and send a text message

- 1 On the Messaging screen, touch the **New message** thread. The composer screen opens.
- 2 In the **To** field, type the mobile phone number or the contact name of the recipient. As you type a phone number or contact name, matching contacts with their mobile numbers appear below the **To** field. Touch a matched contact to enter the contact's mobile number, or continue typing the desired phone number. You can also touch  to select the recipient from the previous message recipients, or touch  to select from your contacts.
- 3 Repeat step 2 to enter more mobile numbers if you wish to send the message to multiple mobile phone users.
- 4 Touch the **Type to compose** text field to start composing your message.
- 5 Touch the **Send** button to send the text message.
- 6 To start a text conversation similar to online instant messaging, you can continue to compose and send messages to the same recipient(s). All of the sent and received messages between you and recipient(s) appear in the form of chat logs.

## To compose and send a multimedia message

- 1 In the **To** field, type the recipient's mobile phone number, e-mail address, or contact name. Matching contacts with their mobile numbers or e-mail addresses appear below the **To** field. Touch a

matched contact, or continue manually typing the desired phone number or e-mail address. You can also touch  to select the recipient from the previous message recipients, or touch  to select from your contacts.

- 2 You can add a subject line to the message by touching the Menu button  → **Add subject**.
- 3 Touch the **Type to compose** text field to start composing your message.
- 4 While editing your message, you can touch the Menu button  → **Attach** to insert media items into the message (see below).
- 5 When you have completed editing the multimedia message, touch the **Send** button to send the message.

You can attach any of the following items to a multimedia message:

<b>Picture</b>	Open the <b>Gallery</b> application and touch a picture file to attach it to your message.
<b>Capture picture</b>	Open the <b>Camera</b> application to capture a picture, then attach it to your message. For information about the Camera application, see "Camera" on page 133.
<b>Videos</b>	Open the <b>Gallery</b> application and touch a video clip to attach it to your message.
<b>Capture video</b>	Open the <b>Camcorder</b> application to capture a video clip, then attach it to your message. For more information about the Camcorder application, see "Camera" on page 133

---

## Audio



Open the **Select audio** menu. Touch a desired audio file, and then touch **OK** to attach the file to your message.

To attach an audio file stored on the SD card to your MMS:

- 1 Create a folder named Ringtones in the SD card.
- 2 Open the Ringtones folder.
- 3 Copy the audio file you want to attach to your MMS into the Ringtones folder.
- 4 On the MMS composer screen, touch the Menu button  → **Attach** → **Audio**.
- 5 Select the audio file to attach it to your MMS.

---



## Record audio

- Open the **Music** application and select a music file from the list.
  - Open the **Sound Recorder** application to record an audio clip:
    - Touch  to start recording.
    - Touch  to stop recording.
    - Touch  to listen to the recording.
    - Touch **Use this recording** to attach the recording to your message.
-



---

## Slideshow

Open the **Edit slideshow** screen to create a slide show and attach it to your message.

- 1 Touch **Add slide** to create new slides.
- 2 Touch a created slide such as **Slide 1** to open the slideshow editor screen.
- 3 Touch **Add picture**, and then select the picture you want to add to the slide.
- 4 You can touch the text field on the lower part of the screen to compose a caption for the displayed slide.
- 5 Touch the Menu button  to preview the slide, remove the picture, add a music to the current slide, add a new slide, or change the slide duration or the text and picture layout.
- 6 When editing multiple slides, touch  to edit the next slide; touch  to return to the previous slide.

**NOTE:** You can create a slideshow of up to ten slides.

- 7 To replace a picture, on the slideshow editor screen, touch the **Replace picture** button and select a new picture to replace. To remove the current slide, touch the **Remove Slide** button. To preview the slideshow, touch the **Preview** button.
  - 8 When complete, touch the **Done** button at the bottom right to attach the slideshow to your message.
  - 9 On the message composer screen, touch the slideshow attachment icon  to play back the slide show; touch **Edit** to modify the slideshow.
  - 10 To remove the slideshow attachment from your message, touch **Edit**→Menu button  →**Discard slideshow**.
-

## Receiving text and multimedia messages

Depending on your notification settings, the device rings, vibrates, or displays a message briefly in the status bar as a new text or multimedia message arrives.



A new message icon  appears and stays in the notifications area of the status bar to remind you of a new message.



**NOTE:** To alter the notification settings for new messages, in the Messaging application touch the Menu button  → **Settings** → **Notification settings**. You can then decide whether to receive a text notification in the status bar when a new message arrives, select a ringtone that rings on the arrival of a new message, or let the device vibrate to report a new message.

Text and multimedia messages that are sent to and received from the same contact or a number are grouped into message threads similar to text conversations of an online chat. You can see all of the messages exchanged between you and the contact. Message threads are listed according to when they are sent or received, with the latest message at the top.

### To read a text message

- Touch and drag down the status bar where the new message icon  is displayed. A list of notifications opens. Touch a new message notification to open and read the message.
- Touch  → **Messaging**  to open the message list, and then touch a text message or message thread to open and read it.

### If the message includes a:

- Website link — touch the link to open the **Browser** application and visit the website.
- Phone number — touch the number to open the **Phone** application and call the number.



- E-mail address — touch the e-mail address to open the **Email/Gmail** application and compose an e-mail to send to the address.



### To forward the message

- 1 Touch and hold the message. The **Message options** menu pops up.
- 2 Select **Forward** to forward the message.

### To view a multimedia message

- 1 Touch and drag down the status bar where the new message icon  is displayed. A list of notifications opens. Touch a new message notification to open the message.

Or

Touch  → **Messaging**  to open the message list, and then touch a multimedia message or message thread to open the message.

- 2 Touch the thumbnail of the attached picture to display the picture; touch the **Play** button  to play back the attached video.

 **NOTE:** Touch the **Download** button, to manually download the media file in the message.

 **NOTE:** To save the attached media item to your microSD card, touch and hold the message until the **Message options** menu pops open. Touch **Copy attached to SD card**.

### To reply to a text or multimedia message

- 1 Touch a message or message thread to open it.
- 2 Type your reply message into the **Type to compose** text field.
- 3 Touch **Send** to send your message to the sender.

### To delete a message or a message thread

- 1 In the Messaging list, touch and hold the message thread that you want to delete.
- 2 To delete the entire thread, touch **Delete thread** and then touch **Delete** to confirm deletion.  
To delete a message within a thread, touch and hold the message to delete, and then touch **Delete message** on the Message options menu. Touch **Delete** to confirm deletion.



**NOTE:** To delete all messages in the Messaging list, touch the Menu button  → **Delete threads**.



### To edit message settings

In the Message application, touch the Menu button  → **Settings** to change the text or multimedia message settings. Follow the instructions on the screen.

## Pop-up Menu

Touch the Menu button  to open or close the pop-up menu that lists available options for the current application, or actions that you can perform on the current screen.

### To select an option or item on the pop-up menu

- 1 Touch the Menu button  to open the pop-up menu.
- 2 Touch the desired item on the pop-up menu.
- 3 Touch the Menu button  again to close the pop-up menu.

# Android Keyboard

You can type text using the Android on-screen keyboard. The keyboard automatically rotates to either the portrait or landscape mode based on the device orientation.

## To open the Android keyboard

Touch a text box, or touch and hold the Menu button .

 **NOTE:** The Android keyboard is the default keyboard that opens when you touch a text box for the first time. To open the Swype keyboard:

- Touch and hold a text box to open the **Edit text** context menu→**Input method**→**Swype**.
- On the Android keyboard, touch and hold  to open the **Android keyboard** context menu→**Input method**→**Swype**. For information on using the Swype keyboard, see Swype Keyboard.

 **NOTE:** To switch back to the Android keyboard from the Swype keyboard, touch and hold a text box to open the **Edit text** context menu→**Input method**→**Android keyboard**.

## To close the keyboard

Touch the Back button  or touch and hold the Menu button .

## Keyboard controls for composing an e-mail

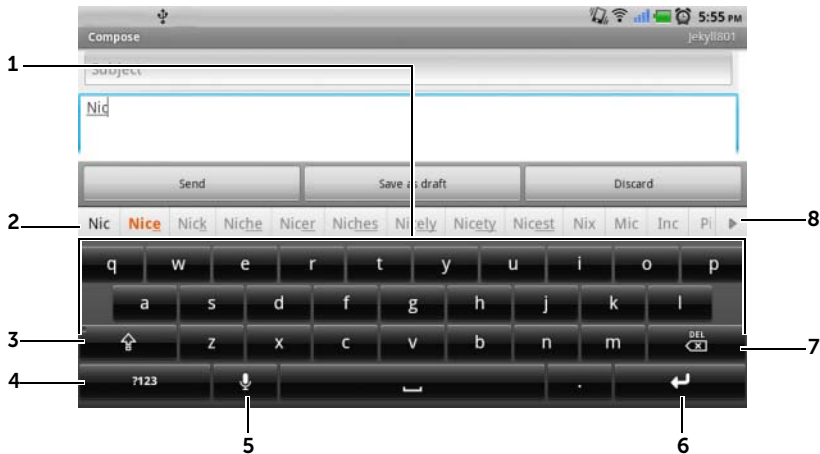

- 1
  - Touch to type letters into the text box where the cursor appears.
  - Touch and hold to type accented letters for applicable languages.

---

- 2
  - Based on the letters being typed, the keyboard shows suggested words along the top of the keyboard, the most probable one highlighted in color.
  - You can touch a suggested word to enter it into the text box.

---

- 3
  - Touch once to show the uppercase keyboard for typing a capital letter.
  - Touch twice to enable the Caps Lock mode.
  - Touch to change back to the lowercase keyboard.

---

- 4
  - Touch to show the keyboard for typing numbers, punctuation marks, and symbols other than the period.
  - Touch to switch back to the alphabet keyboard.
  - Touch and hold to select from the following options:
    - **Android keyboard settings:** Configure the keyboard settings.
    - **Input method:** Choose to use the Swype or Android keyboard.

---

- 5
  - Touch to use voice input. Say the words you want to enter to the microphone. The device enters the words that it can recognize from your voice.





---

- 6
  - Touch to enter a line feed.

- 
- 7
- Touch to delete a typed character, symbol, or a space.
  - Touch and hold to quickly delete typed text.
- 

- 8
- Touch  to see more suggested words.
- 

### To configure the keyboard settings

- 1 Touch the Home button  → Menu button  → **Settings** → **Language & keyboard** → **Android keyboard**. Or from the Android keyboard, touch and hold  to open the **Android keyboard** context menu → **Android keyboard settings**.
- 2 To enable a setting, touch the setting option to select the check box ; to disable a setting, touch the setting option to clear the check box .

### Available keyboard settings

---

<b>Vibrate on keypress</b>	The device vibrates when you touch a key.
<b>Sound on keypress</b>	The device beeps when you touch a key. <b>NOTE:</b> To activate this item, you also need to select <b>Settings</b> → <b>Sound</b> → <b>Audible selection</b> .
<b>Auto-capitalization</b>	The first letter of the word in a new sentence is capitalized.
<b>Voice input</b>	Turn on the microphone to enable voice input for the main keyboard or symbols keyboard.

---

### Word suggestion settings

---



<b>Quick fixes</b>	Mark and correct wrong spellings and typos.
<b>Show suggestions</b>	Show suggested words as you type.
<b>Auto-complete</b>	Touching the spacebar or a punctuation key automatically inserts a highlighted word suggestion.

---



## Create your personal dictionary

The keyboard uses the default dictionary to display suggested words as you type. You can create a personal dictionary to include words not found in the main dictionary. The keyboard will also look at the words that are added to your personal dictionary to make word suggestions.



### To add a word to the dictionary

- 1 Touch the Home button  → Menu button  → **Settings** → **Language & keyboard** → **User dictionary**.
- 2 Touch the Menu button  → **Add**.
- 3 Type a desired word into the **Add to dictionary** text box.
- 4 Touch **OK**.

### To edit a word in the dictionary

- 1 Touch the Home button  → Menu button  → **Settings** → **Language & keyboard** → **User dictionary**.
- 2 Touch a desired word.
- 3 Touch **Edit**.
- 4 Edit the spelling of the word in the **Edit word** text box.
- 5 Touch **OK**.

### To delete a word from the dictionary

- 1 Touch the Home button  → Menu button  → **Settings** → **Language & keyboard** → **User dictionary**.
- 2 Touch the word to delete.
- 3 Touch **Delete**.

# Swype Keyboard

The Swype keyboard allows you to enter text by drawing a path through the letters of a word, instead of touching each key to type the word.

## To open the Swype keyboard

Touch and hold a text box to open the **Edit text** context menu→**Input method**→**Swype**.

## Swype Keyboard controls for composing an e-mail

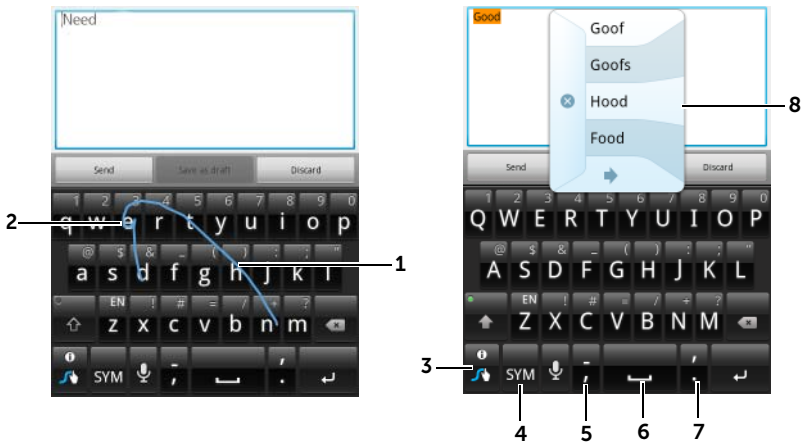

- 1 To enter the word "Need" for example, place your finger on the first letter "N" and glide to the following letters. Lift your finger after the last letter "d". The keyboard predicts and enters the word according to the letters that the path you drew goes through. Letters irrelevant to the spelling of the word are ignored.
- 2 To enter the double letters "ee" for the word "Need", do a quick back-and-forth scribble or draw a loop on the letter "e".

- 
- 3
- When no word is entered into the text box, touch the key to choose from the following:
    - **Tutorial:** Play the animated tutorial demonstrating how to use Swype.
    - **More Help:** Read Swype Help for detailed information on using Swype.
    - **Options:** Adjust the Swype keyboard settings.
  - After words are entered into the text box, touch the key to see other word suggestions to replace the word where the cursor is inserted.
  - Touch and hold the key to access Swype Help directly.
- 

- 4
- Touch to show the keyboard for typing numbers, punctuation marks, and symbols.
- 

- 5
- Touch to enter “,”.
  - Touch and hold to enter “-”.
- 

- 6
- Touch to enter a space.
  - Touch and hold to enter a tab space.
- 

- 7
- Touch to enter “.”.
  - Touch and hold to enter “’”.
- 

- 8
- The Swype keyboard display word suggestions when it cannot predict the word according to the trace you draw, or when you touch .
-





# Google Search

You can use the Google Quick Search Box to find websites and information on Google, applications installed on your device or available from Android Market, and contacts stored in your Contacts list.

## To search by typing

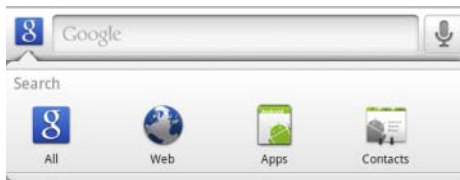

- 1 From the Google Search widget you created on the Home screen, touch  to select the type of your search: **All**, **Web**, **Apps** or **Contacts**.



- 2 Touch the Google Quick Search Box. The on-screen keyboard opens.
- 3 Type a keyword or text into the box using the keyboard. As you type, the search results that fully or partially match the text being typed appear below the search box.
- 4 Scroll the listed search results and touch to select a desired one. If you only want to view matching web links on Google, either touch the  key on the keyboard or the search icon  on the search box.
- 5 The matching application or the browser with matching web links opens.
- 6 Touch the desired link if you want to view a web page.

## To search by voice

- 1 Touch  on the right corner of the search box.
- 2 Say the name or keyword of the item you are looking for.
- 3 The browser with matching web links opens.

 **NOTE:** You can also access the Voice Search function by touching the Launcher button  →Voice Search .

## Power Control widget

 **NOTE:** To use the Power Control widget, you need to create it on the Home screen of your device. For information on configuring the Internet connection, see "Connecting to the Internet" on page 70. For information on adding widgets to the Home screen, see "Customizing Your Home screen" on page 27.



**NOTE:** To conserve battery, you may choose to disable one of these modes when not in use.





- 
- 1** Indicates if the appropriate mode is enabled or disabled.
- 
- 2** Touch to enable or disable Wi-Fi connection.
- 
- 3** Touch to enable or disable Bluetooth®.
- 
- 4** Touch to enable or disable the Use GPS satellites mode, which allows you to pinpoint locations down to the street-level. This mode requires a clear view of the sky and more battery power.
- 
- 5** Touch to enable or disable the Auto-sync mode, which lets your device automatically sync your Gmail, Twitter, Facebook, Outlook data, or the data from other accounts you set up on the device.
- 
- 6** Touch repeatedly to adjust the brightness of your display backlight.
-

# Managing Your Device Settings



## To check storage spaces

Touch the Home button  → Menu button  → **Settings** → **SD card & phone storage**. The screen displays the total and available space on the device and on the microSD card.

## To erase unwanted application data to free storage space

- 1 Touch the Home button  → Menu button  → **Settings** → **Applications** → **Manage applications**.
- 2 From the Manage applications list, touch the application whose cache or data you want to remove.
- 3 In the Application info screen, touch **Clear data** under **Storage** to erase unwanted application data; touch **Clear cache** under **Cache** to erase unwanted cache.

## To format the microSD card

- 1 Touch the Home button  → Menu button  → **Settings** → **SD card & phone storage**.
- 2 Touch **Unmount SD card** to enable the **Format SD card** option.



 **CAUTION: Formatting a microSD card erases all data and downloaded applications stored on it. Ensure that you back up the data that you need before formatting your microSD card.**

- 3 Touch **Format SD card** → **Format SD card** button.

## To remove the microSD card safely

Removing the microSD card while the device is working may cause data lost or result in application errors.

 **CAUTION: It is strongly recommended to unmount the microSD card before removing it.**

- 1 Touch the Home button  → Menu button  → **Settings** → **SD card & phone storage**.
- 2 Touch **Unmount SD card**.

- 3 Turn off your device.
- 4 Remove the back cover.
- 5 Remove the microSD card from your device.

### To erase all data from your device

 **CAUTION:** The following steps will erase all the data including your Google account and downloaded applications from your device. Ensure that you back up all the required data before you proceed.

- 1 Touch the Home button  → Menu button  → **Settings** → **Privacy** → **Factory data reset**.
- 2 Touch **Reset phone**.







**NOTE:** You need to draw your screen unlock pattern if it is enabled.

- 3 Touch **Erase everything** after you read the warning.





### To reset your device to the default state

 **CAUTION:** The following steps will restore your device to the default state and erase all data and downloaded applications stored on it. Ensure that you back up all the required data before you reset the device.

- 1 Press and hold the power button  and then touch the **Power off** option on the screen to turn off the device.
- 2 Simultaneously press and hold the volume up button  and volume down button .
- 3 Without releasing the volume buttons, press and hold the power button, until the device turns on the configuration screen.
- 4 Press the volume buttons to move the highlight bar on the screen to the **Factory reset** option.
- 5 Press the Camera button  to start the reset process.
- 6 Wait for the device to restart.

### To upgrade the software version on your device

 **CAUTION:** The following steps will erase all data including your Google account and downloaded applications from your device. Ensure that you back up all the required data before you proceed.

- 1 Follow steps 1 to 3 in To reset your device to the default state to turn on the configuration screen.
  - 2 Press the volume buttons to move the highlight bar to the **Software upgrade via Update.pkg on SD Card** option, and press the Camera button  to confirm your selection.
  - 3 Press the Camera button  to confirm and start emergency software recovery.
-  **NOTE:** If you wish to cancel software recovery, press the volume down button .
- 4 Wait for the device to load files and restart the system.

# Internet

## Connecting to the Internet

To browse the web and access web-based utilities such as instant messaging, one of these data networking connections must be available:



- GPRS
- EDGE
- 3G
- HSPA
- Wi-Fi

### GPRS/EDGE/3G/HSPA

#### To connect to the web using GPRS, EDGE, 3G, or HSPA

Your device is configured with GPRS, EDGE, 3G, or HSPA network available with the service provider of the SIM card installed in your device. However, this is only limited to voice calling and text messaging. If a Wi-Fi connection is currently available, the device automatically uses the Wi-Fi connection to access the Internet. The Internet connection through GPRS, EDGE, 3G, or HSPA becomes temporarily inactive, until the Wi-Fi connection ends.

If you wish to connect to the Internet using a GPRS, EDGE, 3G, or HSPA data network:



- 1 Touch the Home button  → Menu button  → **Settings** → **Wireless & networks**, then touch **Wi-Fi** to disable it.
- 2 Touch the Home button  → Menu button  → **Settings** → **Wireless & networks** → **Mobile networks**, then touch **Data enabled** to enable it.





**NOTE:** Depending on whether a GPRS, EDGE, 3G, or HSPA network is currently in use, a corresponding data network icon appears on the status bar after a data connection is established. For information about the mapping of the data network icons, see Status Bar.

You can set the device to search for available networks if you are outside your home network or want to register to a different network.

### To manually select a new network

- 1 Touch the Home button  → Menu button  → **Settings** → **Wireless & networks** → **Mobile networks** → **Network operators** → **Search networks**. The list of networks currently available is displayed.
- 2 Select a network manually from the network list.

### To automatically select a new network

Touch the Home button  → Menu button  → **Settings** → **Wireless & networks** → **Mobile networks** → **Network operators** → **Select automatically**.

## Wi-Fi



You can connect your device to the Internet using Wi-Fi.

To use Wi-Fi on your device, you need access to a wireless point or “hotspot” within a distance of up to 300 feet (100 meters).



**NOTE:** The range and quality of the Wi-Fi signal is affected by the number of connected devices, infrastructure, and objects through which the signal is transmitted.

### To turn on Wi-Fi and connect to a network

- 1 Touch the Home button  → Menu button  → **Settings** → **Wireless & networks** → **Wi-Fi** to select the Wi-Fi check box. The device scans for available wireless networks.
- 2 Touch **Wi-Fi settings**. The network names and security settings (Open network or Secured with WEP/WPA/WPA2/WPS) of discovered Wi-Fi networks display in the **Wi-Fi networks** list.
- 3 Flick the list and touch to select a Wi-Fi network to connect to.
- 4 Enter a password (if necessary), then touch **Connect** to connect to the Wi-Fi network.

 **NOTE:** To connect to a network protected by Wired Equivalent Privacy (WEP), WPA (Wi-Fi Protected Access), WPA2, or WPS (Wireless Protected Setup), you must enter the WEP/WPA/WPA2/WPS security key to obtain authorized access to the network. The next time your device connects to a previously accessed secured wireless network, you will not be asked to enter the WEP/WPA/WPA2/WPS key again, unless you reset your device to its factory default settings.

 **NOTE:** Your device has the ability to maintain a constant Internet connection through Wi-Fi or mobile networks (GPRS, EDGE, 3G, or HSPA). However, Wi-Fi connection has priority over mobile network connection if both are available.

### To check the current Wi-Fi network connection



From the status bar:

When your device is connected to a wireless network, the Wi-Fi icon

 in the status bar indicates the signal strength (number of bands that light up). If **Wireless & networks**→**Wi-Fi settings**→**Network**

**notification** is enabled, this icon  appears in the status bar as the device discovers an accessible Wi-Fi network within range.



From the Wi-Fi network:



- 1 Touch the Home button →Menu button →**Settings**→**Wireless & networks**→**Wi-Fi settings**.
- 2 Touch the Wi-Fi network that the device is currently connected to (labeled **Connected**). A window opens displaying the Wi-Fi network's name, status, security info, signal strength, link speed, and IP address.

 **NOTE:** If you want to disconnect the Wi-Fi network from your device, touch **Forget** on this window. You will need to configure the Wi-Fi settings again if you want to restore connection to this wireless network.



## To connect to another Wi-Fi network

- 1 Touch the Home button  → Menu button  → **Settings** → **Wireless & networks** → **Wi-Fi settings**. The detected Wi-Fi networks are displayed in the **Wi-Fi networks** list.



 **NOTE:** To start a new search for available Wi-Fi networks, on the **Wi-Fi settings** screen, touch the Menu button  → **Scan**.

- 2 Flick through the Wi-Fi networks list and touch the name of the network you would like to connect to.

 **NOTE:** If the wireless network you want to connect to is not in the list of detected networks, flick to the bottom of the list to touch **Add Wi-Fi network**. Enter the Wi-Fi network settings, and then touch **Save**.

## Disable all Connections Using the Airplane Mode

Selecting the Airplane mode disables all mobile and Wi-Fi connections. This feature is useful when wireless connectivity is strictly prohibited, such as on an airplane.

Touch the Home button  → Menu button  → **Settings** → **Wireless & networks** → **Airplane mode** to enable or disable the Airplane mode.

# Browsing the Internet

## To open the browser

Touch the Launcher button  → **Browser** .

## To use the browser controls bar





- 1 Touch the web page address field and type the address of the web page you want to go to.
- 2 Touch to view bookmarks, most visited web pages, and browsing history.

### To go to a web page

- 1 On the browser screen, touch the web page address field on the screen.
- 2 Type the web page address using the on-screen keyboard. As you type the address, matching web page addresses appear.
- 3 Touch an address displayed on the screen to go directly to that web page, or complete typing the web page address, then touch **Go**.

### To set up your home page

- To manually enter a home page:
  - 1 Touch the Menu button  → **More** → **Settings** → **Set home page**.
  - 2 Enter the web address of the web site you want to use as your home page and then touch **OK**.
- To set the current page as the home page:
  - 1 Go to the web page that you want to set as the home page.
  - 2 Touch the Menu button  → **More** → **Settings** → **Set home page**.
  - 3 Touch **Use current page** → **OK**.
- To select a home page from bookmarks:
  - 1 Touch  from the browser control bar to call up the lists of bookmarks, most visited sites, and browsing history.
  - 2 Touch and hold a desired bookmark to call up the commands menu → **Set as homepage**.

## Viewing Web Pages

### To navigate on a web page

Flick your finger horizontally or vertically on the screen to scroll and view desired areas of a web page.

### To zoom in on a web page

Pinch-out a desired area of a web page by moving two fingers apart on the screen.



### To zoom out on a web page

Pinch-in a desired area of a web page by bringing two fingers closer together on the screen.



**NOTE:** You can also double-tap the desired area of a web page to toggle between the zoom-in and zoom-out views of the area.

### To view the next or previous page



Touch the back button  to view the previous page; touch Menu button  **More** **Forward** to view the next page.

### To open a new window



Touch the Menu button  **New window**. A new browser window opens and displays the home page.

### To switch between browser windows

You can open multiple browser windows to easily switch from one web page to another.

- 1 On a browser window, touch the Menu button  **Windows**.
- 2 Touch the web address of a desired web page. The window opens displaying the page in full screen.
- 3 To close a browser window, touch  on the browser window.

### To find text within a web page

- 1 When viewing a web page, touch the Menu button  **More** **Find on page**.
- 2 Type the search item into the search bar.
- 3 Touch  or  to go to the previous or next matching item.



**NOTE:** Touch  to close the search bar.

### To copy text on a web page

You can copy and paste text from a web page to your e-mail or text messages.

- 1 Go to the web page from where you want copy the text.
- 2 Locate the text you want to copy and then touch the Menu button →**More**→**Select text**.
- 3 Position your finger at the start of the text you want to copy and then drag to the end of the text you want to copy. The copied text is highlighted in pink.
- 4 Release your finger from the screen.
- 5 To paste text on an e-mail or text message, touch and hold the text field on a message or e-mail screen and then touch **Paste** on the context menu.

### Using Web Links, History, and Downloads



#### To select a link on a web page

Move to a link you want on a web page. The link is framed by an orange box when you touch it.

Link type	Functionality
Web page address	<ul style="list-style-type: none"><li>• Touch the link to open the web page.</li><li>• Touch and hold the link to open a context menu that allows you to open, bookmark, and save the link, copy the link of the web page to the clipboard, or share the link through Bluetooth, e-mail, Facebook, text messaging, or Twitter.</li></ul>
E-mail address	<ul style="list-style-type: none"><li>• Touch to send an e-mail to the e-mail address.</li><li>• Touch and hold till a context menu appears.<ul style="list-style-type: none"><li>– Touch <b>Send email</b> to send an e-mail to the e-mail address.</li><li>– Touch <b>Copy</b> to copy the e-mail address to the clipboard. You can paste the e-mail address later to a new contact or while composing a new e-mail.</li></ul></li></ul>

Link type	Functionality
Phone number	<p>Touch to open the Phone application to call the phone number.</p> <p><b>NOTE:</b> You can call a number from the web page only if the feature is supported by your service provider.</p>

### To check the history of visited web pages



- 1 On the browser screen, touch , or touch the Menu button  → **Bookmarks**.
- 2 Touch the **History** tab.
- 3 Touch the day when your desired web page was last visited.
- 4 Touch a web address to open the web page.

 **NOTE:** To check your most visited web pages, touch the **Most visited** tab.

### To allow download of web applications

 **CAUTION:** Applications downloaded from the web can be from unknown sources. To protect your device and personal data, download applications only from trusted sources such as Android Market.

To download web applications, enable your device's downloading feature.



- 1 Touch the Home button  → Menu button  → **Settings** → **Applications**.
- 2 Touch **Unknown sources** to select the check box.
- 3 When the **Attention** dialog box opens, touch **OK**.

 **NOTE:** All downloaded applications are saved to the microSD card. Before you download an application from the web, ensure that you have installed a microSD card on your device. For information on how to install a microSD card, see Install the microSD card.

### To install an application

- 1 On the browser screen, touch the application you want to download.
- 2 The application details screen opens. Read details about the application, such as its cost, overall rating, comments by users, the developer contact info, and more.
- 3 To install the application, select either **Install** if the item is free or **Buy** if it requires purchase.



### To check downloads

On the browser screen, touch the Menu button  **More**  **Downloads**.



### Manage Bookmarks

You can store as many bookmarks as you want on your device.

### To bookmark a web page



- 1 On the browser screen, go to the web page you want to bookmark.
- 2 Touch  or touch the Menu button  **Bookmarks**. The Bookmarks window opens.
- 3 On the **Bookmarks** tab, touch the **Add** thumbnail .
- 4 Enter the bookmark name or edit the web address as needed.
- 5 Touch **OK** to save the web page as a bookmark.

### To open a bookmark

- 1 On the browser screen, touch  or touch the Menu button  **Bookmarks**. The **Bookmarks** window opens.
- 2 On the **Bookmarks** window, you can either:
  - Touch the bookmark you want to open in the same browser window.

- Touch and hold the bookmark you want to open, then on the context menu touch **Open** to open the bookmark in the same browser window, or touch **Open in new window** to open the bookmark in a new window.

### To manage your bookmarks

- 1 On the browser window, touch  or touch the Menu button  → **Bookmarks**.
- 2 On the **Bookmarks** window, touch and hold a desired bookmark to open the context menu that provides the following options:

<b>Open</b>	Open the bookmarked website in the same browser window.
<b>Open in new window</b>	Open the bookmarked website in a new window.
<b>Edit bookmark</b>	Touch to open the <b>Edit bookmark</b> window. Enter the bookmark's name and address and touch <b>OK</b> .
<b>Add shortcut to Home</b>	Touch to create the bookmark's shortcut on the current Home screen. You can touch the shortcut on the Home screen to start the browser and go directly to the bookmarked page.
<b>Share link</b>	Touch to share the bookmark's address through Bluetooth, e-mail, Facebook, text messaging, or Twitter.
<b>Copy link URL</b>	Copy the web address of the bookmarked website to the clipboard.
<b>Delete bookmark</b>	Touch to delete the selected bookmark.
<b>Set as homepage</b>	Set the bookmarked website as your browser homepage.

### To configure browser settings

On the browser screen, touch the Menu button  → **More** → **Settings** to adjust the browser settings.

# E-mail

You can create POP3, IMAP, and exchange e-mail accounts from web-based e-mail services on your device.

## To open the e-mail application

Touch the Launcher button  →Email .

## To set up an e-mail account

- 1 On the **Set up email** screen, type the e-mail address and password of the e-mail account you want to add and then touch **Next**.

 **NOTE:** If the e-mail account you want to set up is not in the device e-mail database, you will be asked to manually enter the e-mail account settings, including the e-mail server, protocol, and so on after touching **Next**.

 **NOTE:** Touch **Manual setup** rather than **Next** to directly enter incoming and outgoing settings for the account being set up.

- 2 Enter the name for the account and the name you want displayed in outgoing e-mails and then touch Done.

After creating one e-mail account, touch the Menu button  →**Add account** if you need to create another e-mail account.



## To view your e-mails

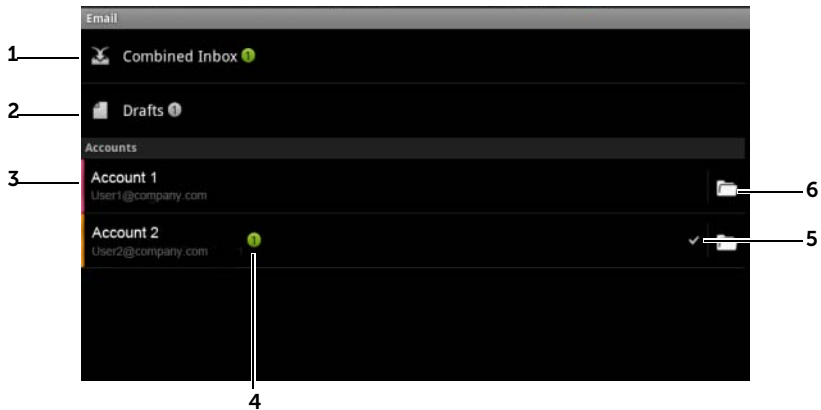



- 1 The **Combined Inbox** contains all e-mails received in all your accounts.
- 2 E-mail not sent and saved as drafts are stored in the **Drafts** folder.
- 3 Select an account to view e-mails received in the inbox of the account.
- 4 The number of new e-mails received in this account.
- 5 The check symbol indicates that this account is the default one for sending e-mail.
- 6 Touch to view e-mails in the other folders of this account.



## To select an account as default for sending e-mail



- 1 Touch an account → Menu button  → **Account settings**, or touch and hold the account, then touch **Account settings** from the context menu.
- 2 Touch **Default account** to select the check box.

## To compose and send e-mail

- 1 Touch the Launcher button  → **Email** .
- 2 Select an email account to use if you have set up more than one account on your device.

 **NOTE:** If you do not select an account, the one marked as default by a check symbol will be the one used for sending e-mail.





- 3 In an e-mail account inbox, touch the Menu button →  
**Compose.**
- 4 Type the recipient's e-mail address in the **To** field. As you type information, matching contacts appear on the screen. Touch the recipient to automatically add the e-mail address, or continue typing the e-mail address manually. If you are sending the e-mail to multiple recipients, separate their e-mail addresses with a comma. You can add as many recipients as you need.
- 5 Type the subject.
- 6 Compose your message.
- 7 Touch the Menu button →**Send.**

 **NOTE:** If you want to save the message as a draft and modify it later, touch  or touch **Save as draft.**

### To delete an e-mail

- 1 On the e-mail account inbox, touch and hold the e-mail you want to delete.
- 2 On the context menu, touch **Delete.**

### To delete or edit an e-mail account on your device

- 1 Touch the Launcher button →**Email** .
- 2 Touch the Menu button →**Accounts.**
  - To delete an e-mail account, touch and hold the account you want to remove under the **Accounts** bar, then touch **Remove account** on the context menu. When asked to confirm deletion, touch **OK.**
  - To edit an e-mail account, touch an account→Menu button →**Account settings**, or touch and hold the account then touch **Account settings** on the context menu.

# Web Applications



**NOTE:** To use the following applications, you require an active Wi-Fi or mobile data network connection (GPRS, EDGE, 3G, or HSPA) to be able to connect to the Internet. For more information about configuring your device for Internet connectivity, see Connecting to the Internet.



**NOTE:** Available applications may vary from region to region.

## Facebook

Touch the Launcher button  → **Facebook** .



Facebook is a social networking website where you can post your personal profile and pictures, find and contact your friends, classmates or work associates, and exchange messages with them.

### To log in to Facebook



- 1 Type your e-mail and password with which you registered your Facebook account.
- 2 Touch the **Login** button

If you do not have a Facebook account, touch the **Sign Up** button and follow on-screen instructions to create one.

## To use Facebook on your device

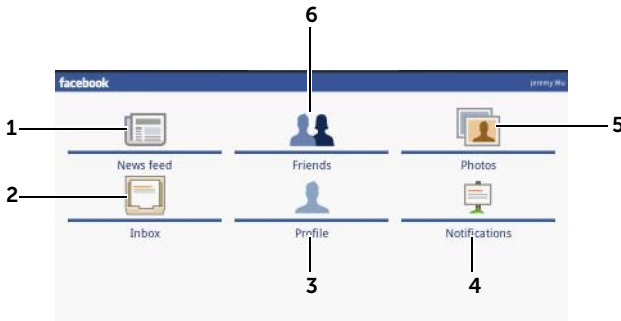
Once logged in, touch the Menu button  → **Home**  at the bottom of the screen to enter your Facebook main page



- 1 Touch **News feed** to view the messages and pictures you and your friends posted. From here you can also:
  - Type the message you want your friends to know into the **What's on your mind?** text box, then touch the **Share** button to post the message on the Wall of your Facebook Profile page.
  - Touch  to take a picture, then touch the **Upload** button to post it to your Facebook account for your friends to see.
- 2 Touch **Inbox** to view e-mails sent between you and your friends. Touch a desired email to read it.
  - To delete an email, touch the check box next to a desired e-mail, then touch the **Delete** button.
  - To reply to the e-mail, type your reply into the text box at the bottom then touch the **Send** button.
  - To compose a new e-mail, touch the Menu button  → **Compose**.
- 3 Touch **Profile** to view your Facebook Profile page.
  - Touch the **Wall** tab to view your Facebook wall, where you can see the messages and pictures you and your friends posted.
  - Touch the **Info** tab to view your account details.
  - Touch the **Photos** tab to view the pictures you posted.
- 4 Touch **Notifications** to view notifications of your friends' wall postings.
- 5 Touch **Photos** to view the pictures you posted.

- 
- 6 Type the name of a friend you are looking for on Facebook, then touch the name of the friend you found to:
- View the friend's wall, info, and pictures on their profile page.
  - On your friend's Wall screen, type a message into the **Write something...** text box, then touch **Share** to post your message on their wall.
- 

### The Facebook widget

From the Facebook widget you created on the Home screen, you can view your friends' wall postings.

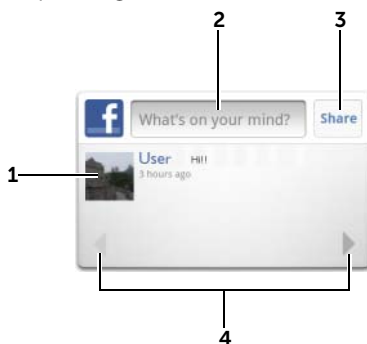

- 
- 1 Touch to view a Facebook friend's wall postings.
- 
- 2 To respond to this friend's postings, touch the text box then type the message you want to post on this friend's wall.
- 
- 3 Touch **Share** to post your message on this friend's wall.
- 
- 4 Touch the arrow buttons to scroll and view other friends' postings.
- 



**NOTE:** For detailed information on using Facebook, visit [facebook.com/help](https://www.facebook.com/help).

## Twitter

Touch the Launcher button  → **Twitter** .



Twitter is a social networking service application that lets you view short messages called Tweets posted by Twitter users. You can also post your own Tweets for others to read.





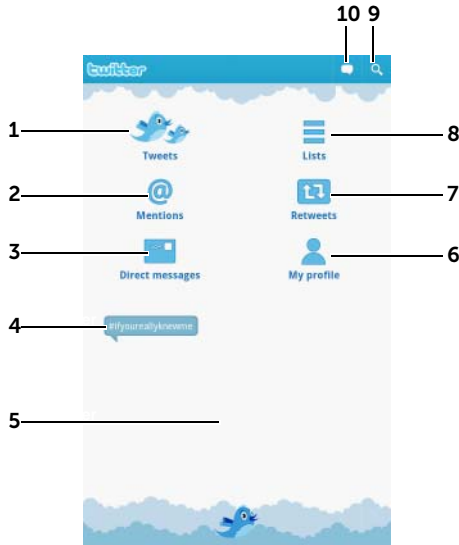



### To sign in to Twitter

- 1** To use Twitter, you need to create a Twitter account if you do not have one. Touch **Sign up now** and follow the instructions to proceed.
- 2** To sign in to Twitter, type your user name or e-mail address and your password, and then touch **Sign in**.
- 3** Choose whether to sync the people you follow in your Twitter account to your Contacts list, then touch the **Done** button.

## To use Twitter on your device



- 1 Touch to read the tweets from authors you choose to follow.
  - Touch an author's picture to view the tweets from the author.
  - Touch  on a tweet and choose to reply to the author, forward (Retweet) the tweet to your followers on Twitter, add the author to your favorites list, or share the tweet through Bluetooth, Facebook, e-mail, Messaging, or Twitter.
- 2 Tweets that contain "@username" in the body of the tweet are collected in here as "Mentions".
- 3 Touch to send private tweets, called direct messages, to the people you follow. From the Direct messages screen touch  to compose and send your message. Touch  and choose the person you want to send your message.
- 4 View the most popular trending topics at the moment. Touch a trending topic to view the tweets related to that topic.
- 5 Touch the lower blank area of the Twitter home screen to view the lists of current, daily and weekly trending topics.

- 
- 6** Touch to view your profile and the tweets you posted. To post your profile picture onto Twitter, touch the Menu button  → **Change profile photo**, then select a desired picture from Gallery.
- 
- 7** Touch to read the tweets forwarded by you or by the people you follow.
- 
- 8** Organize users you follow into listed groups. To create a list:
- 1** Touch  or the Menu button  → **Create list**.
  - 2** Give the list a name and description.
  - 3** Choose to make the list public (everyone can see it) or private (only you can see it).
  - 4** Touch the **Create list** button to create the list.
- 
- 9**
- Touch to search for tweets about a desired topic, or tweets sent by authors around your location.
    - To search for tweets about a topic, type the topic or keyword into the **Search Tweets** text box, then touch .
    - To search for tweets around your location, touch or drag  to turn **Location** on, then touch  to display available tweets around.
  - Touch to find people who use Twitter.
    - Touch . From the pop-up menu, touch to select . Type a name in the **Search people** text box, then touch .
- 
- 10** Touch to compose and post your tweet. See To create a tweet.
- 

### To create a tweet

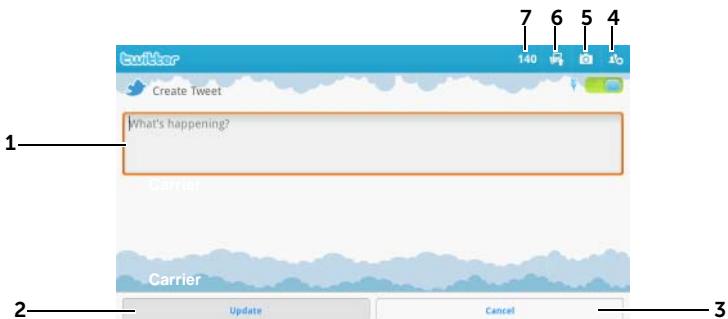

- 
- 1** Type your tweet message here.
  - 2** Touch the **Update** button to post your tweet.
-



- 
- 3 Touch the **Cancel** button to quit composing your tweet.

---

  - 4 Touch to view the people you follow, then select who you want to talk to in your tweet. Their names will appear in your tweet as “@name”.

---

  - 5 Touch to start the camera and capture a picture to post along with your tweet.

---

  - 6 Touch to open Gallery and select a picture to post along with your tweet.

---

  - 7 Shows the number of remaining characters allowed in your tweet.
- 

 **NOTE:** For information on how to use Twitter, visit [Twitter.com/Help](https://twitter.com/Help).

## Gmail

Gmail is a web-based e-mail service provided by Google.

### To open Gmail



Touch the Launcher button  → **Gmail** .

### To set up your Google account

You need to sign in to a Google account to use Google applications and services such as Gmail, Google Talk, and Android Market. Signing in to your Google account also synchronizes all e-mails and contacts on your Google account with your device.

 **NOTE:** You will not be required to sign in with your Google account if you have already done this when previously using an application that requires signing in to your Google account.

- 1 On the **Add a Google account** screen, touch the **Next** button to proceed.
- 2 Touch the **Sign in** button. Enter your Google user name and password, then touch the **Sign in** button.

 **NOTE:** If you need to use another Google account with a different user name and password on your device, touch the Menu button  → **Accounts** → **Add account** → **Next** → **Sign in**. Enter your Google user name and password, then touch the **Sign in** button.

 **NOTE:** Signing in to your Google Account requires an Internet connection. Ensure that your device has an active Wi-Fi or mobile data connection (GPRS, EDGE, 3G, or HSPA) before you sign in. See [Connecting to the Internet](#) for more information on how to set up a data connection.

 **NOTE:** Touch the **Create** button if you do not have a Google Account. Your Gmail inbox opens as the default Gmail view. All your received e-mails are delivered to your inbox.



- 
- 1 Folder (or Label) and number of unread e-mails.

---

  - 2 Touch the check box  to select the e-mail thread. To use this feature, touch the Menu button  → **More** → **Settings**, then enable **Batch operations**.

---

  - 3 Touch **Archive** to store the selected e-mail thread in the **All Mail** folder.

---

  - 4 Touch **Delete** to delete the selected e-mail thread.

---

  - 5 Touch **Labels** to label the selected e-mail thread.

---

  - 6 Starred e-mail. Touch the star to add or remove the star.

---

  - 7 The number of e-mails grouped under the same subject.
- 

## To refresh Gmail

Touch the Menu button  → **Refresh** to send or receive e-mails and to synchronize your e-mails with your Gmail account on the Internet.

## To view e-mails in different folders or with labels

To view e-mails stored in the folders other than the inbox, such as in the Sent or All Mail folders, or to view labeled or starred e-mails:



- 1 Touch the Menu button  → **Go to labels.**
- 2 Touch the folder that stores the e-mails you want to view, or touch the label with which the e-mails are marked.

## To read e-mails

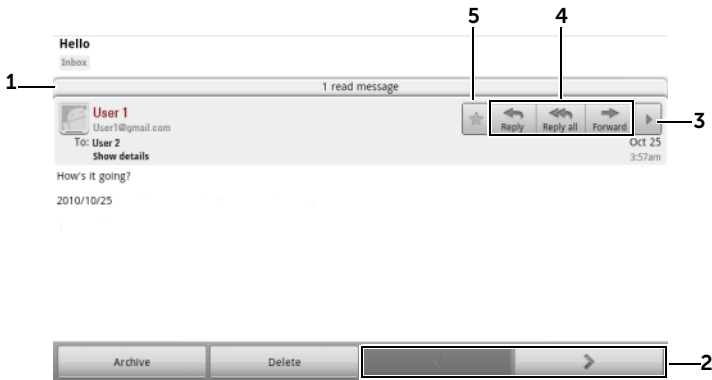



- When you receive a new e-mail, the e-mail icon  appears on the status bar to alert you of a new e-mail. Drag down the status bar to open the **Notifications** panel and touch the new e-mail to view it.
- While in the inbox or in any other folder, scroll the e-mail threads on the screen, and then touch an e-mail thread to view the e-mails inside.



- 1 Touch to view previous e-mails with the same subject.
- 2 Touch to read the next or previous e-mail thread.
- 3 Touch to open or close the **Reply all** and **Forward** buttons.
- 4 Touch **Reply** to reply to the contact.  
Touch **Reply all** to reply to all contacts in the mail loop.  
Touch **Forward** to forward the e-mail to another contact.

- 
- 5 Touch  to star an e-mail. To check the starred e-mails, in **Inbox**, touch the Menu button  → **Go to labels** → **Starred**.
- 



### To create and send an e-mail

- 1 Touch the Menu button  → **Compose**.
  - 2 Enter the contact's e-mail address in the **To** field. To send e-mail to multiple contacts, separate their e-mail addresses with a comma. To send a carbon copy (Cc) or a blind carbon copy (Bcc), touch the Menu button  → **Add Cc/Bcc**.
  - 3 Enter the e-mail subject.
  - 4 Compose your e-mail. To attach a picture, touch the Menu button  → **Attach**. Select the picture you want to attach from the Gallery application.
-  **NOTE:** Touch  to remove an attachment.
- 5 Touch **Send** to send the e-mail.

### Google Talk

Google Talk is an instant messaging program provided by Google.

#### To activate Google Talk

- 1 Touch the Launcher button  → **Talk** .
  - 2 Follow the instructions on the screen to create a Google account if you don't have one, or sign in with your account if you already have one. For more information, see To set up your Google account.
-  **NOTE:** Skip step 2 if you have already signed in to your Google account.
- 3 The Google Talk window opens with your friends list.

### To sign in automatically

You can sign in to your Google Talk account automatically whenever you turn on the device.

- 1 In the friends list, touch the Menu button  → **Settings**.
- 2 Select **Automatically sign in**.

### To add a new friend to your friends list

 **NOTE:** You can only add people who have a Google Account.

- 1 In the friends list, touch the Menu button  → **Add friend**.
- 2 Enter the Google Talk instant messaging ID or Gmail address of the friend you want to add to your friends list.

 **NOTE:** When you type the instant messaging ID of a friend who is already a contact saved in Contacts with the same ID, this matching contact will display on the screen before you finish typing. You can touch the contact whose ID is then entered automatically.

- 3 Touch **Send invitation**.

### To view and accept an invitation

- 1 In the friends list, touch the Menu button  → **More** → **Invites**. All chat invitations you have sent or received but have not been answered are listed on the pending invitations screen.
- 2 Touch a pending invitation.
- 3 Touch **Accept** or **Cancel**.

When a friend accepts your chat invitation, the pending invitation disappears from the list.

### To change your online status and message

- 1 Touch the online status icon  next to your name.
- 2 Select the status you want from the Set Status menu.
- 3 To enter your status message, touch the text box and enter your message.

- 4 To change your ID photo, touch the photo icon to open Gallery, then select the photo to use.
- 5 When finished, touch **Done**.

### To start a conversation

- 1 Touch to select a friend in the friends list.
- 2 Type your message in the text box.
- 3 Touch the **Send** button to send the message.

### To add a friend to an active conversation

- 1 On the chat screen, touch the Menu button  → **Add to chat**.
- 2 Select the friend you want to invite to the current conversation.

### To disable the chat log

On the chat screen, touch the Menu button  → **Chat off record**. The subsequent chat conversations will not be recorded. To resume the chat log, touch **Chat on record**.

### To switch between active conversations

- 1 While on a chat screen or in the friends list, touch the Menu button  → **Switch chats**.
- 2 In the panel that opens, touch the name of the friend you want to chat with.

### To close a conversation

- In your friends list, touch and hold the name of a friend with an active chat. Touch **End chat** on the menu that pops up.
- On a chat screen, touch the Menu button  → **End chat**.

### To display all friends in your friends list

Only the friends that you chat with most frequently are listed as the most popular ones. If you want to display all your friends, touch the Menu button  → **All friends**.

### To show a friend in the most popular list

- 1 In the friends list, touch and hold the friend's name to open the options menu.
- 2 Touch **Show friend**.

### To always show a friend in most popular list

You can let a friend always appear in your most popular friends list.

- 1 In the friends list, touch and hold the friend's name to open the options menu.
- 2 Touch **Always show friend**.



**NOTE:** To remove a friend from the most popular list, in the friends list, touch and hold the friend you want to remove from the list, and then touch **Auto show friend** in the options menu.



**NOTE:** To keep a friend from appearing in the most popular list, touch and hold the friend's name, and then touch **Hide friend** in the menu.

### To block a friend from sending you messages

- 1 In the friends list, find the friend to block.
- 2 Touch and hold the friend's name, and then touch **Block friend**.

Your friend is removed from your friends list and is added to the blocked friends list.



**NOTE:** To unblock a friend, in the friends list, touch the Menu button  **More** **Blocked**. In the blocked friends list, touch the name of the friend to unblock, then touch **OK**.

### To permanently remove a friend

- 1 In the friends list, find the friend to remove.
- 2 Touch and hold the friend's name, and then touch **Remove friend**.

## To find out what device your friend uses to chat on Google talk

- 1 In the friends list, ensure that the Menu button  → **Settings** → **Mobile indicator** is selected.
- 2 In the friends list, check the image that appears to the right of your friend's name. For example, if your friend is using an Android phone, the Android image will appear. If no image is displayed, it indicates that your friend has signed in to Google using a computer.

## To sign out from Google Talk

In the friends list, touch the Menu button  → **Sign out**.

## Maps



Google Maps helps you find your current location, view real-time traffic situations, and get directions to your destination. You can also use the search tool to locate addresses or places of interest on a map or in a street view.



**NOTE:** The Google Maps application does not completely cover every location.

## To enable location source



To search for desired places or find your current location using Google Maps, you need to enable My location sources:

- 1 Touch Home button  → Menu button  → **Settings** → **Location & security**.
- 2 Select **Use wireless networks**, **Use GPS satellites**, or both.



**NOTE:** Selecting **Use GPS satellites** allows you to pinpoint locations down to the street-level. However, this mode requires a clear view of the sky and more battery power.

## To open Google Maps

Touch the Launcher button  → **Maps** .





## To see your location on a map

On the Maps screen, touch the Menu button  → **My Location**. Your location is marked on the map with a blinking blue dot.

 **NOTE:** Enabling GPS satellites allows you to pinpoint your current location down to the street-level. However, this mode requires a clear view of the sky and more battery power.

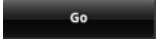
## To find a location on the map

- 1 On the Maps screen, touch the Menu button  → **Search**.
- 2 To search by typing:
  - a Type the place you want to find into the search box. You can enter an address, a city or country, or a type of business or organization such "restaurant" or "school".
  - b Touch the search key  on the keyboard or the search icon  on the search box.

To search by voice:

- a Touch .
- b Say your destination.

 **NOTE:** As you enter information, previous searches or matching locations appear below the search box. You can touch a place name or address to show the location on the map.

3 The search results are marked on the map by lettered balloons.



---

1 Touch the place name to view the address, details, and reviews for the place if the information is available (For more information, see To view the details of a place).

---

2 Touch to show the list of search results.

---

3 Touch to zoom in or out on the map.

---

4 The search result is marked by a lettered marker. Touch the marker to display the name of the place.

---

## To view the details of a place

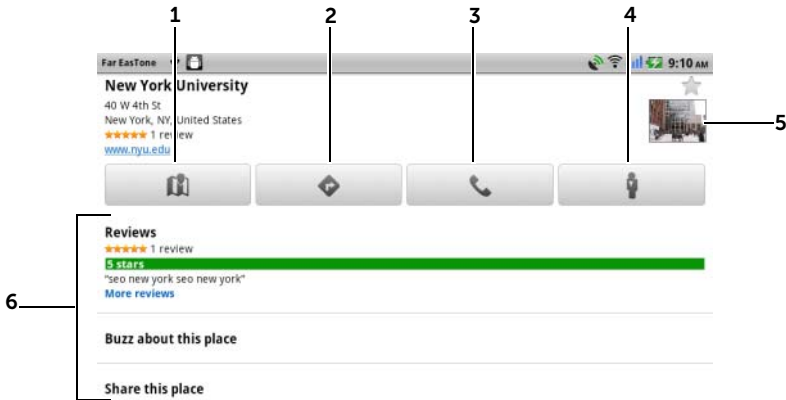



- 1 Touch to display the map view.
- 2 Touch to obtain directions. (see To get directions for more information).
- 3 Touch to call the contact number of the place if available.
- 4 Touch to switch to street view for the location (see To view a map in street view for more information).
- 5 Touch the photo thumbnail to open the browser and find more information about the location on Google.
- 6
  - Touch to view the address, details, and reviews for the place if the information is available.
  - Select the action you can do with the location. You can select **Buzz about this place** to post your opinions about the place, or select **Share this place** to share the address and contact information about the place using e-mail, Twitter, Facebook, Bluetooth, and more. Scroll down the list to find more actions you can do.

## To move around a map

- 1 Flick or drag the map in any direction on the screen to view desired areas.
- 2 If you spot a place of interest while navigating the map, touch and hold the place to display the address (a picture thumbnail is also displayed if the street view for the location is available).



## To zoom in or out on a map

- Touch  to zoom out and touch  to zoom in.
- Move two fingers close together on the screen to zoom out; move two fingers further apart to zoom in.

## To change map layers

Google Maps opens with the default map layer. You can apply different types of layers to view additional information or images on the map.

- 1 Touch the Menu button  → **Layers**.
- 2 From the Layers menu, touch the desired layer to display it on the map.



## Map layer

The map layer displays streets, highways, buildings, main establishments, mass transit stations, parks, rivers, lakes, mountains, boundaries, and so on.



## Traffic layer

The traffic layer displays colored lines along the roads where real-time traffic data can be collected. Green lines indicate good traffic speeds, yellow ones indicate slower speeds, and brown ones indicate congested traffic.

 indicates where construction work is taking place;  indicates where the road is blocked.

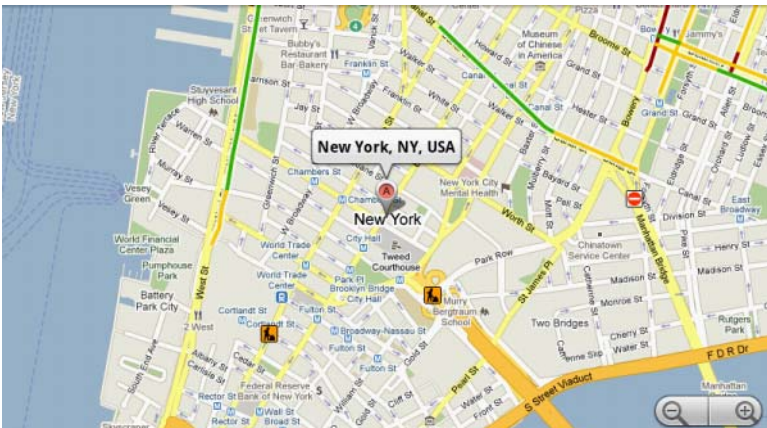

## Satellite layer

The satellite layer displays the map in non-real-time satellite view.



## Terrain layer

The terrain layer combines street maps with visual information about terrains.

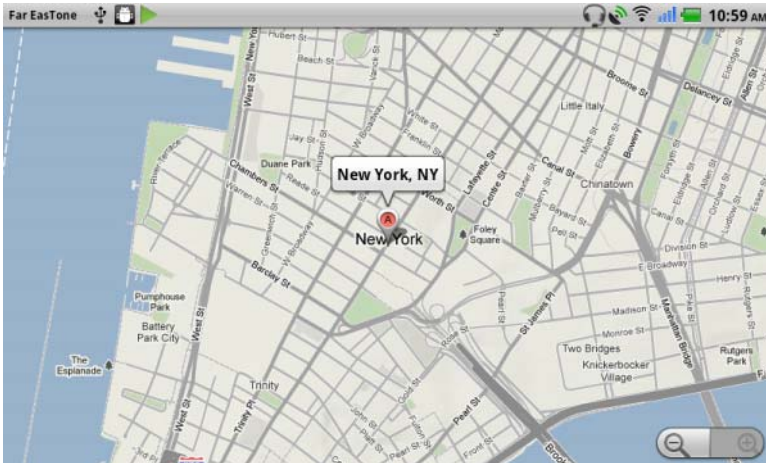





## Transit Lines layer

The transit lines layer displays mass-transit routes around the area.



**NOTE:** Touch the Menu button  → **Layers** → **More layers** to find more layers that you can apply to the map. For information about the other layers, visit the Google Maps website.





**NOTE:** To remove all of the layers other than the map layer, touch the Menu button  → **Layers** → **Clear Map**.

## To view a map in street view

You can switch to street view for the location that you found on the map. The street view is composed of imagery captured from the streets.

- 1 Locate a place of interest on the map. For more information, see To find a location on the map and To move around a map.
- 2 On the map, touch the name or address of the place.
- 3 On the location details screen, touch .
- 4 To view the 360-degree panorama of the area around the place, turn the view on the screen with your finger.

- To move the view along the street, touch the arrows displayed on the screen, or touch the Menu button  → **Step forward** or **Step backward**.

 **NOTE:** While viewing a street view of a location, touch the Menu button  → **Compass mode** to enable the compass mode, which allows you to view the area around the selected location by tilting or turning your device, rather than by moving the view on the screen with your finger.

## To get directions

Use Google Maps to obtain directions to your destination.

- When viewing a map:

touch the Menu button  → **Directions**.

Or

When a place is found:

- Touch the place's name or address displayed on the map.
  - On the location details screen, touch .
- Enter the starting point in the first text box and your destination in the second text box.

 **NOTE:** By default, your current location is the starting point, and the place you found on the map is your destination.



- 
- Starting point
  - Destination
  - Choose how you want to get to your destination: driving, public transportation, or walking.
  - Touch to render directions.
-



- 
- 5 Touch to set your current location, a contact address, or a place on the map as the starting point or destination.
- 

- 3 Touch **Go**. The directions to your destination are listed.
- 4 Touch **Show on map**, or touch a direction instruction on the list to show the directions or routes on the map.

 **NOTE:** To obtain driving directions using the Google GPS navigation services, touch **Navigate**. For more information see Navigation.

### To clear a map

Touch the Menu button  → **More** → **Clear Map**. All the search results, directions and traffic indicators are deleted from the map.

### Using Google Latitude



 **NOTE:** To use Google Latitude, you will be required to sign in to a Google account.

The Google Latitude location service allows you to share locations with your friends and family who have signed in to the service with their Google accounts. You can also send instant messages and e-mails, make phone calls, and get directions to your friends' locations.

To let your friends view your location and accept their invitations, you need to enable **Latitude**.

- 1 While viewing a map in any mode, touch the Menu button  → **Join Latitude**.
- 2 Follow the instructions on the screen to create a Google account if you don't have one, or sign in with your account if you already have one. For more information, see To set up your Google account.

 **NOTE:** Skip step 2 if you have already signed in to your Google account.

 **NOTE:** If you have set up two or more Google accounts on your device, and want to use Latitude with another account, touch the Menu button  → **More** → **Switch Account**.

- 3 Read the privacy policy. If you accept, touch **Agree & Share**.

## To run Latitude

While viewing a map, touch the Menu button  → **Latitude**.

## To invite friends to share locations

- 1 On the Latitude screen, touch the Menu button  → **Add friends**.
- 2 Choose the friends you want to share locations with:
  - **Select from Contacts:** Select friends from your contacts. Friends already using Latitude have an icon next to their names.
  - **Add via email address:** Enter an e-mail address.
- 3 Touch **Add friends** then **Yes**.
- 4 Your friends already using Latitude receive an e-mail request and a notification on Latitude that ask them to share locations. If they have not yet joined Latitude, they receive an e-mail that requests them to sign in to Latitude with their Google accounts.

## To accept an invitation

When you receive a request to share your location with a friend on Latitude, touch the request and choose how you want to respond:

- **Accept and share back:** You can see your friend's location, and your friend can see yours.
- **Accept, but hide my location:** You can see your friend's location, but they cannot see yours.
- **Don't accept:** Reject the sharing request. No location information is shared.

## To show your friends

You can show your friends on the map or in the list view.

- **Map view**

When you open Google Maps, it displays the locations of your friends. Each friend is marked by a photo icon with an arrow that indicates their location. To see a friend's profile and communicate

with them, touch the photo, then touch their location callout right above their photo. To see other friends, touch either one of the arrow buttons next to the callout.

- **List view**

To show a list of your friends, touch the Menu button  → **Latitude**. To see a friend's profile and communicate with them, touch the friend's name from the list.

### To connect with your friends

Touch a friend's name in map view or list view to open the friend's profile. In the profile screen, you can communicate with your friend and configure privacy options.

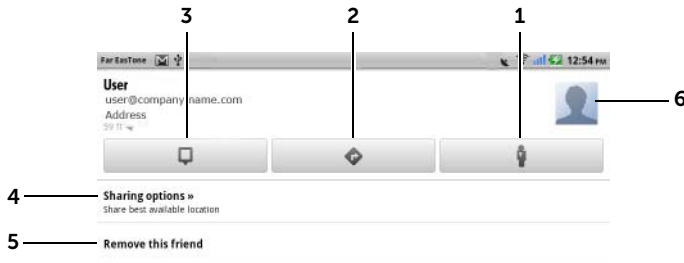

---

**1** Switch to street view of the friend's location.

---

**2** Get directions to the friend's location.

---

**3** See a friend's location on the map.

---

**4** **Sharing options:**

- **Share best available location:** Share street-level location with your friend.
  - **Share only city level location:** Share only the city or the approximate area you are in, not the street-level location. Your friend can see your photo icon in the middle of the city you are in.
  - **Hide from this friend:** Stop location sharing with this friend. Your friend cannot see your photo icon on the map.
- 

**5** **Remove this friend:** Remove this friend from your list and end all location sharing.

---

- 
- 6 Touch the thumbnail to open the pop-up menu. Depending on available settings, you may use Messaging and Gmail services to send a message to your friend.
- 

### To control what to share and change your public profile

- 1 In Maps, touch the Menu button  → **Latitude**.
- 2 Touch your name on the list of friends to open your public profile window.
- 3 Set the following options to your preferences.

---

<b>Change your photo</b>	Change the picture that your friends see on the map or in their list of friends. You can take a picture using the Camera application, or select one stored in Gallery.
--------------------------	---

---



<b>Send location to others</b>	Send the address of your current location using Twitter, Facebook, Bluetooth, text messaging, or e-mail.
--------------------------------	--

---

<b>Edit privacy settings</b>	Manage how your location is shared with your friends: <ul style="list-style-type: none"><li>• <b>Turn off Latitude:</b> Disable Latitude and end location sharing.</li><li>• <b>Detect your location:</b> Latitude automatically detects and updates your current location.</li></ul> <p><b>NOTE:</b> To let Latitude report your location, you must enable My location sources. For more information, see To enable location source.</p> <ul style="list-style-type: none"><li>• <b>Set your location:</b> Select a location from the map, contact addresses or nearby places, or type an address.</li><li>• <b>Hide your location.</b> All of your friends will not be able to see your location on their maps.</li></ul>
------------------------------	---

---

## Places

Touch the Launcher button  → **Places** .

Places automatically detects your current location and offers guide to nearby restaurants, coffee shops, bars, hotels, attractions, ATMs, gas stations, and more.

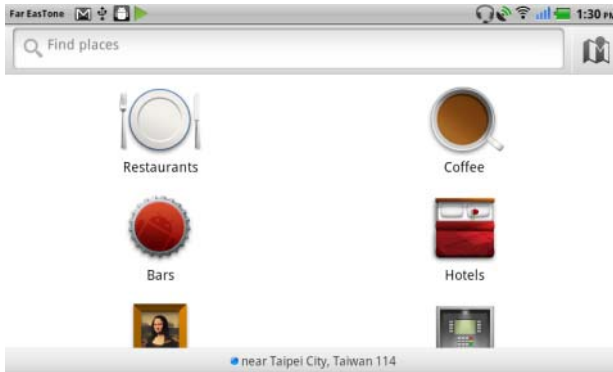

- 1 Touch to select a category.
- 2 From the list of places, touch the desired one to view more details. For more information on using the controls on this screen, see To view the details of a place.

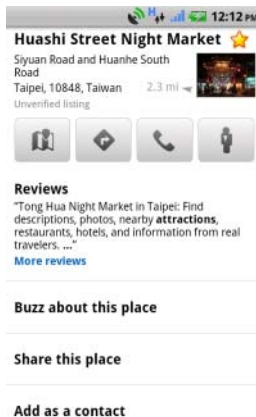

## Navigation

 **NOTE:** Google Maps Navigation is not available in all areas.

 **WARNING:** It is your sole responsibility to use this application in a safe and responsible manner. You must obey local traffic laws, posted road signs, and safety regulations. Do not operate the device while driving.

Touch the Launcher button  → **Navigation** .

Google Maps Navigation is an Internet-connected GPS satellite navigation system with voice guidance. Navigation provides the following features:

Feature	Description
Searching in plain language	Type the name or address of the place, the business, or the organization you want to find.
Searching by voice	Name your destination using Google Search by voice (English only).

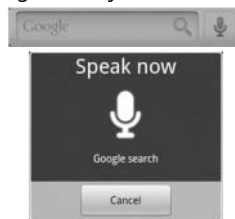
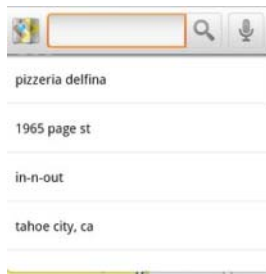

Feature	Description
Traffic view	Traffic view provides live traffic data and displays up-to-date traffic conditions on the screen. Press the Menu button  → <b>Layers</b> → <b>Traffic</b> to turn on Traffic view.



Searching along route	Search for any kind of business along your route. Press the Menu button  → <b>Layers</b> to access popular types of places.
-----------------------	--



Feature	Description
Satellite View	Satellite view allows you to view your route overlaid on 3D satellite views with Google's high-resolution aerial imagery. Press the Menu button  → <b>Layers</b> → <b>Satellite</b> to turn on Satellite view.
Street View	Street view helps visualize turns with Street View imagery. Navigation automatically switches to Street View as you approach your destination.
Car dock mode	Place your phone in a car dock to access Navigation and Voice Search easily.
Navigation shortcut	<ul style="list-style-type: none"> <li>• <b>Speak Destination:</b> Say your destination using Google voice search.</li> <li>• <b>Type Destination:</b> Type your destination.</li> <li>• <b>Contacts:</b> Select a destination from the location of your contacts.</li> <li>• <b>Starred Places:</b> Select a desalination from the list of Starred Places.</li> </ul>

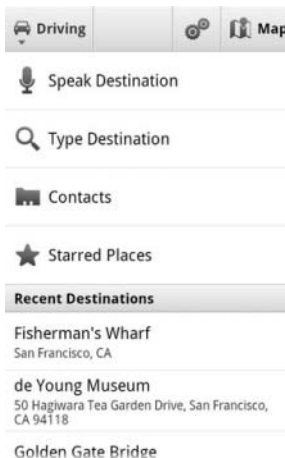



Feature	Description
Walking navigation	Get voice-guided navigation for walking directions. Your device vibrates for turn notifications.

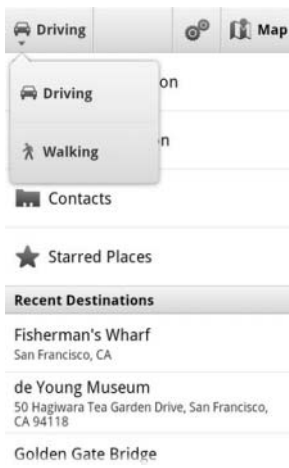

## News and Weather

Touch the Launcher button  → **News and Weather** .



### Weather

The Weather service automatically detects your current location and shows the local weather information.



- 1 • Current weather.
  - Touch this area to view temperatures, wind speed, and humidity data within the next 24 hours.
- 2 Weather forecast for the next 6 days.
- 3 Touch the **The Weather Channel** icon to start the browser and visit **The Weather Channel** website to find more weather information.

If your current location is temporarily unavailable, you need to set your location manually as follows.

- 1 Touch the Menu button  → **Settings** → **Weather settings**.
- 2 Clear the **Use my location** check box.
- 3 Touch **Set location**.
- 4 Enter a city or postal code.
- 5 Touch . The weather location will be updated to the location you manually set.

## News

Flick pages horizontally to view news topics, such as **Top Stories**, **U.S.**, **Sports**, and **Entertainment**. Touch the news headline you are interested in to view the full content.

### To add/remove news topics

You can manage the news topics to be displayed on your device as follows.

- 1 Touch the Menu button  → **Settings** → **News settings**.
- 2 Touch **Select news topics**.
  - Select the check boxes next to the news topics you want to display on the device.
  - Clear the check boxes next to the unwanted news topics.

### To configure news and weather refresh settings

- 1 Touch the Menu button  → **Settings** → **Refresh settings**.
- 2 To refresh news and weather automatically, select the **Auto-refresh** check box.
- 3 Touch **Refresh interval** to adjust the refresh interval. Faster refresh intervals increase data usage and consume more battery power.



**NOTE:** To refresh news and weather manually, touch the Menu button  → **Refresh**.

## YouTube

YouTube is an Internet video streaming service that allows you to view videos uploaded by YouTube members.





 **NOTE:** Browsing and viewing videos does not require you to sign in to a YouTube account. However, to use all of the YouTube features, such as rating or commenting on a video or viewing “My account”, you must create and sign in to a YouTube account.

### To open YouTube



Touch the Launcher button  → **YouTube** .

The YouTube screen opens with the videos grouped into categories such as **Most viewed**, **Most discussed**, **Top rated**, and so on.

### To search for a video by typing

- 1 Touch the icon  on the top right of the YouTube screen, or touch the Menu button  → **Search** to open the search bar.
- 2 Type the video name or keyword into the search box using the on-screen keyboard. The search results that fully or partially match the text being typed appear below the search box. You can:
  - a Scroll the search results and touch a desired one.
  - b Touch  on the keyboard or the search icon  on the search box to search for results that match the entered text, then touch a desired search result.
- 3 The videos that match the selected result are listed.
- 4 Touch the video to start playing the video.

### To search for a video by voice command

- 1 Touch the icon  on the top right corner of the YouTube screen, or touch the Menu button  → **Search** to open the search bar.
- 2 Touch .

- 3 Say the video name or a keyword.
- 4 The videos that match the words you said are listed.
- 5 Touch the video to start playing the video.



### To search for a video by category

- 1 Touch the Menu button  → **Categories**.
- 2 Scroll the listed categories and touch the category under which the video appears.
- 3 Touch to start playing the video.

### To filter videos by different time frames

- 1 From a category screen, touch the Menu button  → **Time filter**.
- 2 Select a time frame such as **Today** or **This week**.
- 3 The videos that match the selected time frame are listed.

### To watch videos

- 1 Select a video listed on the on the YouTube screen. The video starts playing automatically.
- 2 To control video playback, touch anywhere on the screen to display and use the playback controls.
- 3 To end playback, touch the Back button  or the Home button .

### To manage a video

- 1 When browsing videos in a list, touch and hold a video to open the options menu.  
When playing a video, touch the Menu button .
- 2 You can perform these actions that require signing in to your YouTube account.

<b>Rate</b>	Rate the video with stars.
<b>Comments</b>	Write and send your comments about the video.
<b>Favorite</b>	Add the video's web link to your browser bookmarks.

---

<b>Share</b>	Send the video's web link to others using Bluetooth, e-mail, Facebook, Twitter, text messaging, and so on.
<b>Flag</b>	If you find the video inappropriate to get posted and want to have it removed, you can flag the video to notify the service provider.

---



## Android Market

You can use Android Market to download and install applications and games on your device.



**NOTE:** Applications downloaded from Android Market may not support automatic screen rotation to portrait or landscape.

### To open Android Market

- 1 Touch the Launcher button  → **Market** .
  - 2 Follow the instructions on the screen to create a Google account if you don't have one, or sign in with your account if you already have one. For more information, see [To set up your Google account](#).
-  **NOTE:** Skip step 2 if you have already signed in to your Google account.
- 3 Touch the **Accept** button after you read and agree with the **Android Market Terms of Service**.

#### 4 The Android Market screen opens.



- 1
  - Touch the **Apps** tab to view the application categories. All applications available for download are sorted by these categories.
  - Touch the **Games** tab to view the game categories. All games available for download are sorted by these categories.
- 2 The Market screen displays popular application categories here for direct access.
- 3 The Market screen opens with featured applications for direct access.
- 4 Shows user rating about the item and whether it is free or requires a purchase.
- 5 Touch the **Downloads** tabs to view your downloads.
- 6 Touch to search Android Market for applications or games.

When a category is selected, for example, touch the **Games** tab→  
**Brain & Puzzle:**

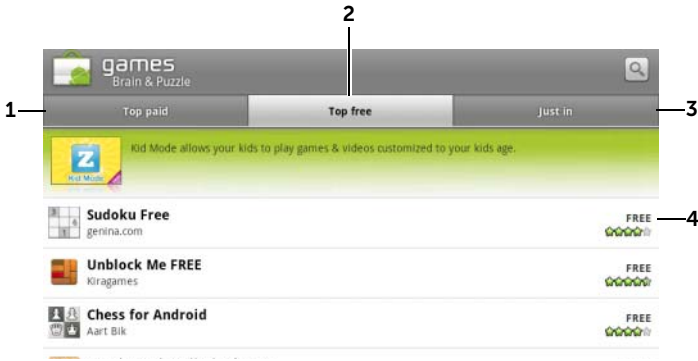

- 1 Touch **Top paid** to view the paid games downloaded most often.
- 2 Touch **Top free** to view the free games downloaded most often.
- 3 Touch **Just in** to view new games available for download.
- 4 Touch the game to download and install on your device.

### To download and install an application or game

- 1 Scroll and browse listed applications or games to locate the desired one.
- 2 Touch the application or game you want to download and install.
- 3 On the application details screen, you can read the introduction to the application or game, user ratings and comments, and developer information.





**NOTE:** Touch the Menu button  and select **Security** to view the functions or data this can access on your device.

- 4 On the application details screen, touch **Install** to start download and installation. The application's downloading screen will show the download progress.



**NOTE:** If the application requires access to any of your data or functions on your device, Market tells you what the application can access. Touch the OK button to start download and installation.



 **NOTE:** During installation, the icon  appears in the notification area of the status bar. Touch the notification area of the status bar to open the Notifications panel and check download progress.

 **NOTE:** To stop downloading an application, touch Cancel download on the application's downloading screen.

- 5 After the application is downloaded and installed on your device, the download icon  appears in the notification area of the status bar.

### To open an application or game

From the Market screen:

- 1 Touch the **Downloads** tab on the Market screen, or touch the Menu button  → **Downloads**.
- 2 Touch the installed application in the list.
- 3 Touch **Open**. The selected application starts running.

From the main application menu:

- 1 Touch the Launcher button .
- 2 Touch the application's icon.

From the status bar:

- 1 Drag down the status bar to view the **Notifications** panel where the download icon  appears to indicate a recently downloaded application.
- 2 Touch the name of the application you want to open.



### To uninstall an application or game

- 1 On the downloads screen, touch the application you want to uninstall.
- 2 Touch **Uninstall**.
- 3 After the uninstall is completed, you can select the reason for removing the application.

# Synchronizing Your Google Data

Through a web connection, your device can synchronize your Google data including Gmail, calendar, and contacts with your computer or any other device that you use to access your Google account.



## To select the applications to synchronize

- 1 Touch Home button  → Menu button  → **Settings** → **Accounts & sync**.
- 2 Under the **General sync settings** bar, touch to select **Background data** to make all the sync options available.
- 3 Under the **General sync settings** bar, touch to select **Auto-sync** to let the device automatically synchronize the selected data.
- 4 Under the **Manage accounts** bar, touch your account to select the data that you want the device to synchronize automatically, such as **Sync Contacts**, **Sync Gmail**, **Sync Picasa Web Albums**, and **Sync Calendar**.



**NOTE:** If you wish to synchronize individual applications manually, touch to clear the **Auto-sync** check box, then touch a data option to start synchronization of the touched data. To sync all of the data manually, touch the Menu button  → **Sync now**.









**NOTE:** While data is syncing, the sync icon  appears on the status bar, and the sync icon  appears on the option of the data being synced.

# Customizing Your Dell™ Streak

With the Settings menu, you can customize the way your device works to suit your preferences.

## To change display settings

- 1 Touch the Home button  → Menu button  → **Settings** → **Display**, or touch the Launcher button  → **Settings** icon  → **Display**.
- 2 Touch the desired item under **Display settings**.
- 3 To enable a setting, touch the setting option to select the check box ; to disable a setting, touch the setting option to clear the check box .

---

### Brightness

Manually adjust screen brightness.

- 1 Drag the brightness slider horizontally or touch the desired portion of it to increase or decrease the yellow bar. The length of the yellow bar determines the brightness of the screen.

- 2 Touch **OK** to confirm adjustment.

**NOTE:** If **Automatic brightness** is enabled, the device will adjust the screen brightness automatically based on the surrounding light conditions.

---

### Auto-rotate screen

If enabled, the screen will switch the orientation to landscape or portrait as you rotate the device.

---

### Animation

Set the device to play an animation for opening and closing windows.

---

---

## Screen timeout

- Set how long the screen remains on after the last operation. Scroll the options and touch a preferred timeout period; to disable this feature select **Never timeout**.
- The screen automatically turns off and locks itself after an inactivity timeout selected here has passed.
- To turn on and unlock the screen, press the







Power button and then flick the  icon up to unlock the screen if it is automatically locked.

**NOTE:** If you select **Never timeout**, the screen remains on indefinitely and quickly consumes battery power.

**NOTE:** If **Settings**→**Location & security**→**Setup up screen lock**→**Pattern** is enabled, you need to draw the unlock pattern to unlock the screen. For more information, see Protect Your Device Data With a Screen Unlock Pattern.

---

## To change sound and ringtone settings

- 1 Touch the Home button →Menu button →**Settings**→**Sound**, or touch →**Settings** icon →**Sound**.
- 2 Use the options grouped under the **Sound settings** bar, and then touch a desired option.
- 3 Flick the list to locate and touch a desired item.
- 4 To enable a setting, touch the setting option to select the check box ; to disable a setting, touch the setting option to clear the check box .

## General settings

<b>Silent mode</b>	Silence all sounds except media and alarms.
<b>Vibrate</b>	Set the device to vibrate under the selected configuration.
<b>Volume</b>	<ul style="list-style-type: none"><li>• <b>Ringtone:</b> Adjust ringer volume for incoming calls and notifications.</li><li>• <b>Media:</b> Adjust volume for music and video playback.</li><li>• <b>Alarm:</b> Adjust volume for alarm ringtone.</li></ul> <ol style="list-style-type: none"><li>1 To adjust volume, drag the sliders horizontally or touch the desired portion of them to increase or decrease volume.</li><li>2 If you want to set a different volume for notifications, touch <b>Use incoming call volume for notifications</b> to clear its check box. Then adjust the <b>Notification</b> volume in the same way.</li><li>3 Touch <b>OK</b> to confirm adjustment.</li></ol>

## Incoming calls settings

<b>Phone ringtone</b>	Select a desired ringtone for incoming calls.
-----------------------	---







## Notifications settings

<b>Notification ringtone</b>	Select a desired ringtone for notifications.
<b>Notification sound</b>	Select this item to enable notification sound.

## Feedback settings

<b>Audible touch tones</b>	You can hear a tone as you dial using the on-screen dial pad.
<b>Audible selection</b>	You can hear a tone as you touch the screen to select items.
<b>Screen lock sounds</b>	You can hear a tone when the screen is locked and unlocked.
<b>Haptic feedback</b>	The device vibrates when you touch the buttons or when specific interactions with the device occur.

# To manually set the date, time, and time zone

- 1 Touch the Home button  → Menu button  → **Settings** → **Date & time**, or touch  → **Settings** icon  → **Date & time**.
- 2 Flick the list to locate and touch a desired item.
- 3 To enable a setting, touch the setting option to select the check box ; to disable a setting, touch the setting option to clear the check box .



---

## Select time source

Choose to set the device time manually or automatically from your mobile network or from the Internet.

---

## Set date

- 1 Touch or touch and hold  or  to adjust the day, month, and year; you can also touch the day, month, or year to type a date using the on-screen keyboard.
- 2 Touch **Set** to confirm the date.



---

## Set time zone

Select a city or region that represents the time zone for your device. Touch the Menu button  to sort the time zone list alphabetically or by time zone.

---

## Set time

- 1 Touch or touch and hold  or  to adjust the hour and minute; you can also touch the hour or minute to type a time using the on-screen keyboard.
- 2 Touch the AM/PM button if the 12-hour format is in use.
- 3 Touch **Set** to confirm the time.

---

## Use 24-hour format

Clear the check box of this feature if you want to display time using the 12-hour format.

---





## Select date format

Select a format used for displaying the date.

---

# To choose a language

Set the language of the display text.

- 1 Touch the Home button  → Menu button  → **Settings** → **Language & keyboard** → **Select language**, or  
touch  → **Settings** icon  → **Language & keyboard** → **Select language**.
- 2 Select a language of your choice from the Locale list that appears.

# Protecting Your Dell™ Streak





## Protect Your Device Data With a Screen Unlock Pattern

You can protect your device data against unauthorized access by locking the touch screen with a screen unlock pattern. Once the unlock pattern is enabled and the screen is locked, you need to draw the correct unlock pattern to unlock the screen.

After you fail to draw the correct unlock pattern on the screen for five consecutive times, you will be asked to wait for 30 seconds before you can try again. If you no longer remember your screen unlock pattern, follow these steps to unlock your screen:

- 1 Touch **Forgot pattern**.
- 2 When prompted, sign on to the Google website using your Google account name and password.
- 3 Draw a new screen unlock pattern as described in To create a screen unlock pattern.
- 4 If you fail to obtain a new unlock pattern following the above steps, visit **support.dell.com**.

### To create a screen unlock pattern

- 1 Touch the Home button  → Menu button  → **Settings** → **Location & security** → **Set up screen lock** → **Pattern**, or touch the Launcher button  → **Settings** icon  → **Location & security** → **Set up screen lock** → **Pattern**.
- 2 Read the instructions on the screen and then touch **Next**.



- 3 Study the animated example of how to draw a pattern. Then touch **Next** when you are ready to draw your own pattern.



- 4 Drag your finger to draw the unlock pattern by connecting at least four dots in a vertical, horizontal and/or diagonal direction. Take your finger off the screen when a pattern is drawn.

 **NOTE:** You must flick your finger on the screen to create the pattern and not touch individual dots.

- 5 The device records the pattern if it is correctly drawn. Touch **Continue**.

- 6 Draw the pattern again as prompted, and then touch **Confirm**.

 **NOTE:** To change your unlock screen pattern, you need to draw the old pattern before proceeding with steps 4 to 6 to draw a new one.







### To disable or change the screen unlock pattern

- 1 Touch the Home button  → Menu button  → **Settings** → **Location & security** → **Change screen lock**, or

touch the Launcher button  → **Settings** icon  → **Location & security** → **Change screen lock**.

- 2 Draw the pattern you created.
- 3 Select **None** to disable screen unlock security; select **Pattern** to draw a new unlock pattern.

## To change unlock pattern settings

- 1 Touch the Home button  → Menu button  → **Settings** → **Location & security**, or  
touch the Launcher button  → **Settings** icon  → **Location & security**.
- 2 To enable a setting, touch the setting option to select the check box ; to disable a setting, touch the setting option to clear the check box .

---

### Use visible pattern

Clear this option if you do not want the lines of the unlock pattern to display on the screen when you draw it.





---

### Use tactile feedback





Clear this option if you do not want the device to give you tactile feedback when drawing the unlock pattern.

---





## Protect Your Device Data With a PIN

- 1 Touch the Home button  → Menu button  → **Settings** → **Location & security** → **Set up screen lock** → **PIN**, or  
touch the Launcher button  → **Settings** icon  → **Location & security** → **Set up screen lock** → **PIN**.
- 2 On the **Choose your PIN** page that appears, enter a PIN in the text box. Your PIN must be 4 characters at least.
- 3 Touch **OK** to proceed.
- 4 Enter the PIN again to confirm.
- 5 Touch **OK**.





### To disable or change PIN

- 1 Touch the Home button  → Menu button  → **Settings** → **Location & security** → **Change screen lock**, or  
touch the Launcher button  → **Settings** icon  → **Location & security** → **Change screen lock**.
- 2 Enter the PIN you have enabled.
- 3 Select **None** to disable the PIN; select **PIN** to change PIN.

## Protect Your Device Data With a Password

- 1 Touch the Home button  → Menu button  → **Settings** → **Location & security** → **Set up screen lock** → **Password**, or  
touch the Launcher button  → **Settings** icon  → **Location & security** → **Set up screen lock** → **Password**.
- 2 On the **Choose your password** page that appears, enter a password in the text box. A valid password consists of at least 4 characters and contains at least one letter.
- 3 Touch **OK** to proceed.
- 4 Enter the password again to confirm.
- 5 Touch **OK**.

### To disable or change the password

- 1 Touch the Home button  → Menu button  → **Settings** → **Location & security** → **Change screen lock**, or  
touch the Launcher button  → **Settings** icon  → **Location & security** → **Change screen lock**.
- 2 Enter the password you have enabled.
- 3 Select **None** to disable the PIN; select **Password** to change the password.

# Protect Your SIM Card With the SIM Lock Password

You can protect your SIM card against unauthorized use with a personal identification number (PIN). After a PIN is enabled to lock your SIM, you will need to enter the PIN each time you turn on the device in order to unlock your SIM.





 **NOTE:** The SIM card will be permanently locked if you enter the incorrect PIN for three consecutive times. You must then enter the Personal Unblocking Key (PUK) to unlock the SIM card. Please contact your service provider to obtain the PUK.

 **NOTE:** You can make emergency calls without unlocking the SIM.

## To enable the SIM card PIN

- 1 Touch the Home button  → Menu button  → **Settings** → **Location & security** → **Set up SIM card lock** → **Lock SIM Card**, or touch the Launcher button  → **Settings** icon  → **Location & security** → **Set up SIM card lock** → **Lock SIM Card**.
- 2 Type your SIM card PIN, and then touch **OK**.

## To change the SIM card PIN

- 1 Touch the Home button  → Menu button  → **Settings** → **Location & security** → **Set up SIM card lock** → **Change SIM PIN**, or touch the Launcher button  → **Settings** icon  → **Location & security** → **Set up SIM card lock** → **Change SIM PIN**.
- 2 Type the old SIM card PIN, and then touch **OK**.
- 3 Type the new SIM card PIN, and then touch **OK**.
- 4 Type the new SIM card PIN again, and then touch **OK**.

# Applications

 **NOTE:** Available applications may vary from region to region.

## Camera



Your device has a 5.0 megapixel camera with auto-focus feature that allows you to capture and share high-quality pictures and videos.

 **NOTE:** Before you use the camera application, you need to install a microSD card in your device. All pictures and videos that you capture using your device camera are stored on the microSD card. For more information on how to install a microSD card on your device, see "Install the microSD card" on page 13.

### To start the camera in picture mode



Do one of the following:



- Press and hold the camera button .

- Touch the Launcher button  → **Camera** .

## Camera controls



- 
- 1 Viewfinder screen.
  - 2 Camera setting indicator. Touch each indicator to bring up the camera settings, and touch to select the desired setting.
  - 3
    - On-screen shutter button.
    - To capture a picture:
      - 1 Focus on the object in the viewfinder screen.
      - 2 To start the auto focus mode, half-press and hold the camera button , or touch and hold the on-screen shutter button.
      - 3 Touch the on-screen shutter button or press the camera button  all the way down and release to capture the picture.

 **NOTE:** To achieve optimal focus such as for taking a close shot, half-press and hold the camera button  to use the auto-focus mode. Then without releasing  press it again to take a picture.
  - 4 Drag this on-screen switch to toggle between the camera mode for capturing pictures, and the camcorder mode for shooting videos.
  - 5 Touch the thumbnail view of the last taken picture to view and manage the picture using the Gallery application.
-

## Additional camera settings

Touch the Menu button .

---

<b>Front-Facing/Rear-Facing Camera</b>	Use the front-facing or rear-facing camera to take pictures.
<b>Gallery</b>	Open the Gallery application to view and manage pictures.
<b>Switch to video/camera</b>	Toggle between the camera mode for capturing pictures, and the camcorder mode for shooting videos.

---

## To start the camcorder mode

Touch the Menu button  → **Switch to video**, or touch  to switch to the camcorder screen.

## Camcorder controls



- 
- 1 Viewfinder screen.
  - 2 Camcorder setting indicator. Touch each indicator to bring up camcorder settings.
  - 3 To start or stop recording, touch this on-screen video recording button or press the camera button .
-

- 
- 4 Drag this on-screen switch to toggle between the camera mode for capturing pictures, and the camcorder mode for shooting videos.
  - 5 Touch the thumbnail view of the last captured video to play and manage the video using the Gallery application.
- 

## Copying Files to and from MicroSD

The files on your device are stored on the microSD card. To exchange pictures, videos, music, and other files between your device and a computer, use the microSD card as a USB drive by connecting the device to a computer with the included USB cable.

### To set the microSD card as a USB drive

- 1 Connect the device to the computer by plugging the 30-pin connector into the device and the USB connector into the USB port on the computer.
- 2 The **USB connected** banner flashes on the status bar, then the USB notification icon  stays on the status bar's notification area.
- 3 Drag down the status bar, and from the Notifications panel that opens, touch **USB connected**.
- 4 Touch **Turn on USB storage** → **OK**, if you want to copy files between your computer and the microSD card.
- 5 From the pop-up dialogue window, touch the Mount button.
- 6 Open the **My Computer** window on your computer to locate a removable drive which is the microSD card installed in your device. Then copy desired files such as music or pictures from another drive/folder to the removable drive, or vice versa.

### To turn off USB storage

The device will not recognize the microSD card when the card is being used as a USB drive. You will not be able to use the device's applications that involve saving or retrieving files on the microSD card,



such as camera or music playback. You need to turn off USB storage for the device to recognize the microSD card when the device is connected to a computer.

To turn off the USB storage function:

- 1 Drag down the status bar to open the Notifications panel.
- 2 Touch **Turn off USB storage**.

### To remove the microSD card

- 1 Press and hold the Power button  and then touch the Power off option to turn the device off.
- 2 Remove the back cover.
- 3 Slide and lift the microSD card out of the slot on the device.

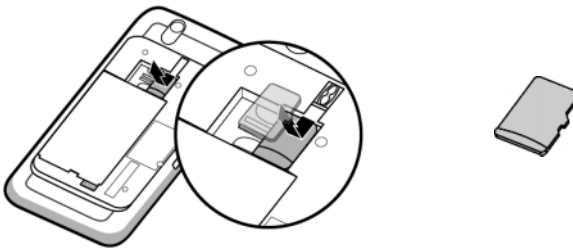



## Bluetooth®

Bluetooth is a short-range wireless communications technology that lets your device connect over a wireless network to other Bluetooth-enabled devices for data exchange.



Bluetooth on your device operates in three different modes:

<b>On</b>	Bluetooth is turned on. Your device is enabled to detect Bluetooth devices within range, but will not be found by them.
<b>Discoverable</b>	Bluetooth is turned on, and other Bluetooth devices can detect your device.
<b>Off</b>	Bluetooth is turned off. Your device is unable to send and receive data using Bluetooth.

## To turn on Bluetooth and make the device discoverable

- 1 Touch the Home button  → Menu button  → **Settings** → **Wireless & networks**.
- 2 Select the **Bluetooth** check box to turn on Bluetooth. The Bluetooth icon  appears in the status bar.
- 3 Touch **Bluetooth settings**, then select the **Discoverable** check box to make the device recognizable by other nearby Bluetooth devices.

## To pair and connect a Bluetooth device

- 1 Touch the Home button  → Menu button  → **Settings** → **Wireless & networks** → **Bluetooth settings**.
- 2 Touch and select the **Bluetooth** check box. Your device starts to scan for Bluetooth devices within range and then displays all detected devices below the **Bluetooth devices** banner.



**NOTE:** To detect more devices, touch **Scan for devices**.

- 3 To initiate a connection with a device, touch the name of the device.
- 4 You may be prompted to enter a password to authenticate. Enter the same password on both devices, or enter the specific one provided by the device manufacturer. Ensure that you read the documentation of the pairing device to check if it requires a default password.
- 5 When the pairing is successful, **Paired but not connected** is displayed under the paired device.
- 6 Touch the paired device to start connection. When the paired device is successfully connected to your device, the Bluetooth connected icon  appears in the status bar.



**NOTE:** To make and receive calls or listen to the music using a Bluetooth headset, pair it first with your device.





**NOTE:** Pairing is a one-time process. Once your device successfully pairs with another device, your device recognizes that device without re-entering your password.



### To end a Bluetooth connection

- 1 Touch the Home button  → Menu button  → **Settings** → **Wireless & networks** → **Bluetooth settings**.
- 2 Touch and hold the name of a connected device.
- 3 Touch **Disconnect** on the pop-up menu that appears.

### To terminate a pairing partnership

- 1 Touch the Home button  → Menu button  → **Settings** → **Wireless & networks** → **Bluetooth settings**.
- 2 Touch and hold the name of a paired device.
- 3 Touch **Unpair** on the pop-up menu that appears to erase all pairing information with that device. You need to re-enter the password if you want to restore a Bluetooth connection to that device.

### To change your device's Bluetooth name

- 1 Ensure that you have turned on Bluetooth on your device ( indicates in the status bar that Bluetooth is enabled).
- 2 Touch the Home button  → Menu button  → **Settings** → **Wireless & networks** → **Bluetooth settings** → **Device name**.
- 3 Enter a name to identify the device when you connect using Bluetooth.
- 4 Touch **OK**.

# Gallery

To view and manage the pictures and videos stored on your device,

touch the Launcher button  → **Gallery** .

The Gallery application displays not only the pictures and videos stored on your microSD card, but also those uploaded to the Picasa web album of your Gmail account which you signed in with on your device.

 **NOTE:** Before you run the Gallery application, ensure that a microSD card containing media files is installed on your device. All pictures and videos that you capture using your device camera are stored on the microSD card. For more information on how to install a microSD card on your device, see "Install the microSD card" on page 13.

## To share or delete albums

All pictures and videos are grouped in separate albums as overlapping thumbnails, according to their dates, sources, or folders in which they are stored. For example, pictures taken using the device camera are grouped as **Camera**, and downloaded pictures are grouped as **download**.





Overlapping thumbnails as one album.

- 1 Touch and hold an album until the check box  appears.
- 2 Touch more albums to select them if you want to do the same task for those albums.
  - To post the selected album to Picasa or video album to YouTube, or to send the album using Bluetooth, messaging, or e-mail, touch **Share**.
  - To delete the album, touch **Delete**.



## To browse picture and video thumbnails

- 1 Touch an album to display the thumbnails of all pictures and videos inside.
- 2 To browse the thumbnails:



- Touch or drag  to display all the thumbnails in grid view, or group them by date as overlapping thumbnails.
  - When the thumbnails are displayed in grid view, drag  or touch the arrows on it to move thumbnails horizontally, until the desired one is located.
- 3** To select a thumbnail, touch and hold it until  appears; touch more thumbnails as you need.
- To post a selected picture or video to Facebook, Twitter, Picasa, Facebook, YouTube, or to send it using Bluetooth, messaging, or email, touch **Share**.
  - To delete a selected picture or video, touch **Delete**.
  - To set a picture as the Home screen wallpaper, touch **More**→**Set as**→**Wallpaper**.
  - To set a picture as a contact's picture ID, touch **More**→**Set as**→**Contact icon**.

### To display a full picture

Touch a desired picture thumbnail to display the picture in full screen.

- Flick the picture to view the next or previous one.
- To bring up the picture viewing controls, touch anywhere on the screen, or touch  twice.
- To zoom the picture in or out, you can:
  - Touch .
  - Pinch the picture with two fingers, then move the fingers away from each other to enlarge the picture, or bring them closer together to reduce the picture.
  - To zoom in or out a particular area of the picture, tap that area twice.
  - When a picture view is being enlarged, flick or drag the enlarged picture across the screen until the required area appears.

## To play a video

- 1 Touch a video thumbnail to start playback of the video.
- 2 To control playback, use these controls below the viewing screen:
  - Touch the  button to pause and the  button to resume playback.
  - Touch or drag the playback progress bar at the bottom to rewind or fast-forward the video.

# Music

 **NOTE:** The Music application only plays audio files saved on the microSD card of your device. Before opening Music, ensure that the needed audio files have been copied to the microSD card of your device.

## To open Music

Touch the Launcher button  → **Music** .

The Music library screen opens, which is organized by **Artists**, **Albums**, **Songs**, and **Playlists** tabs. You can touch a tab to display your desired category.

## To select a song

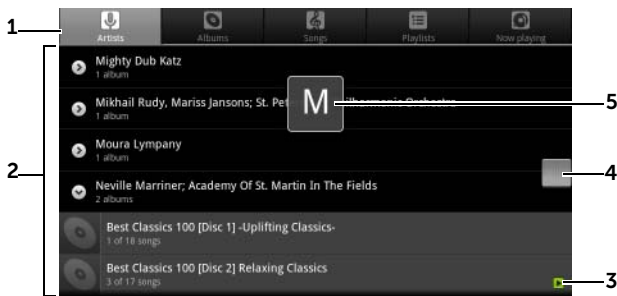

- 1 All the music files available on your device are grouped into these categories: **Artists**, **Albums**, **Songs**, and **Playlists**. Touch a category to view the list within it.

**NOTE:** If you rotate your device to landscape mode, an additional **Now playing** category appears.

- 2 Flick the list until you find the music you want to play. For instance, to select music by artist:
  - a Flick the list of artists in alphabetical order.
  - b Touch the name of an artist. A list of albums by the artist appears.
  - c Touch an album to find the songs inside.
  - d Touch a song to open the music playback screen and play the music.

- 3  indicates the current album or song being played.

---

4 You can flick or drag a long list, and then drag the icon  that appears to quickly scroll the list by alphabet.

---

5 The letter icon indicates the alphabet of the list you scroll to.

---

### To control music playback

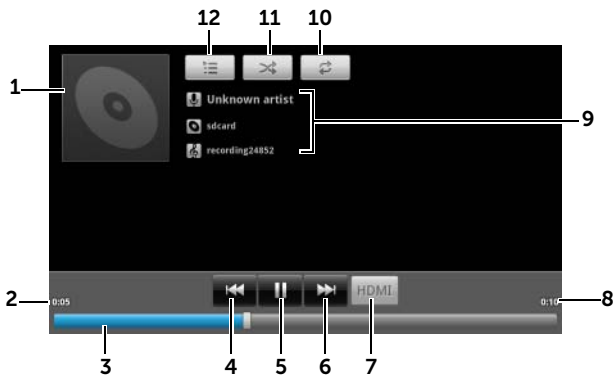

---

1 The album's cover image if it has one.

---

2 The passing playback time.

---

3

- Touch the playback control bar to jump to any part of the song.
- Drag and scroll the playback control bar forward to fast-forward the song.
- Drag and scroll the playback control bar backward to rewind the song.

---

4

- If the song is playing for more than five seconds, touch to jump to the beginning of the song.
- If the song is playing for less than five seconds, touch to play the previous song.

---

5 Touch  to pause playback; touch  to resume playback.

---

6

- Touch to play the next song.
- Touch and hold to fast-forward the song.

---

7 Touch to turn the HDMI mode on and off when connecting to an HDMI output device.



---

8 The duration of the song.

---



- 
- 9
    - The name of the artist, album, and the song being played.
    - Touch and hold the artist, album, or song to search for relevant information or videos from the Internet using the Browser or Youtube application, or do the search inside the Music application.
- 
- 10 Touch to cycle through the repeat modes.
- 
- 11 Touch to turn the shuffle mode on and off.
- 
- 12 Go to the Now playing list.
- 

 **NOTE:** Press the volume up button  or volume down button  to adjust the playback volume.

 **NOTE:** On the Music library screen, touch **Shuffle all** to play all songs in your library in random order. The first randomly selected song starts to play.

### To create a playlist

- 1 On the **Music** screen, touch the **Artists, Albums, Songs** tabs as needed.
- 2 Flick the screen until you reach the artist, album, or song that you want to add to the playlist.
- 3 Touch and hold the artist, album, or song that you want to add in the playlist. A pop-up menu opens.
- 4 Touch **Add to playlist**.
- 5 In the **Add to playlist** window, touch **New**.

 **NOTE:** If you want to add the artist, album, or song to the current playlist, touch **Current playlist** in the **Add to playlist** options menu.

- 6 Enter the name for your new playlist in the text field and then touch **Save**.

# Calendar

Use the calendar to schedule and manage your events, meetings, and appointments.

## To open the calendar

Touch the Launcher button  → **Calendar** .

## To set up an event

- 1 On any calendar view, touch the Menu button  → **More** → **New event** to open the **Event details** screen.
- 2 Type the event name using the on-screen keyboard.
- 3 If there is a time period for the event, touch and type the **From** and **To** date and time.  
If the event is a special occasion such as a birthday or takes a whole day, set the **From** and **To** date, and then select the **All day** check box.
- 4 Type the event location and description.
- 5 If you have set up more than one account on your device, under the **Calendar** option, choose the account calendar to which to add the event.
- 6 To invite your friends to join this event, type their e-mail addresses into the **Guests** text box. The invitation will be e-mailed to them when this event is set up.
- 7 Decide whether it is a recurring event in **Repetition** and choose how often it occurs.
- 8 In **Reminders**, set when the reminder appears before the event.
- 9 Touch **Done** and the event is created.



**NOTE:** To quickly set up an event in day, week, or month view, touch and hold an empty time slot → **New event**. A new **Event details** screen opens with the selected time slot and date in the **From** and **To** fields.

## To view the calendar

You can display the calendar in daily, weekly, monthly, or agenda view.

To change the calendar view, touch the Menu button →

**Day/Week/Month/Agenda/Today.**

While viewing the calendar you can:

- In day or week views, touch an event to open a quick view window of the event on the lower part of the screen.
- Touch the event or the quick view window to view details about the event.
- Touch and hold an event to open a menu with options for viewing, editing, or deleting the event, or creating a new event.

## To view and synchronize multiple calendars

If you have set up more than one account on your device, you can view multiple calendars from the accounts on your device. You can configure which calendars to synchronize to the device, and which of those to show or hide on the device in **Calendar**.

To set whether calendars are synchronized to the device or visible, follow the steps below.

- 1 In **Calendar**, touch the Menu button →**More**→**Calendars**. The **Calendars** screen displays all the calendars you have added or subscribed to for each account on your device, organized by account. Touch the name of an account to show or hide its calendars on your device. The icon to the right of each calendar indicates whether the events on that calendar are synchronized to the device and whether they are visible in **Calendar**.
- 2 Touch the icon next to a calendar to change whether it is synchronized to the device and visible in **Calendar**.



Calendar events are synchronized to the device and visible in **Calendar**.



Calendar events are synchronized to the device but not visible in **Calendar**.



Calendar events are not synchronized to the device.

---

- 3 Touch **OK**.

## Event reminders

If you set a reminder for an event, the upcoming event icon  appears in the notifications area of the status bar when the reminder time arrives.

### To view, dismiss, or snooze a reminder

- 1 Drag the notification area of the status bar to open the **Notification** menu.
- 2 Touch the upcoming event name to display the event.



**NOTE:** If you have other pending event reminders, these events will also appear on the screen.

- 3 Touch **Snooze all** to put off all event reminders for five minutes. Touch **Dismiss all** to turn off all event reminders. Press  to keep the reminders pending in the notification area of the status bar.

# Clock

Your device can work as a desk alarm clock to display current time and date, local weather, and play picture slideshow and music.

Touch the Launcher button  → **Clock** .



- 
- 1 Displays the first active alarm time.

---

  - 2 The current time and date.

---

  - 3 Touch to set the alarm.

---

  - 4 Touch to play the slideshow of the pictures stored on your device.

---

  - 5 Touch to start the Music application and choose the music to play.

---

  - 6 Touch to return to the Home screen.

---

  - 7
    - Displays the local weather.
    - Touch to start the News and Weather application to find more weather updates.

---

  - 8 Touch to turn the backlight down to the minimum level.

**NOTE:** After a period of inactivity, the screen turns off the backlight automatically to only display the current time, date, and alarm time.



**NOTE:** To turn on the backlight, touch anywhere on the screen.

---

## To set an alarm

You can set multiple alarms.

- 1 On the Clock main screen, touch .
- 2 On the **Alarms** screen, touch **Add alarm**.
- 3 The **Set alarm** menu opens with these settings:

<b>Turn on alarm</b>	Turn on the alarm that you have set on the device.
<b>Time</b>	Set the alarm time. Adjust the time by touching  or  , or touch the hour and minute fields to enter a time. Touch <b>AM</b> to change to <b>PM</b> or vice versa, then touch <b>Set</b> when done.
<b>Repeat</b>	Select the days you want the alarm to ring, then touch <b>OK</b> . <b>NOTE:</b> If you did not select any days for the alarm, <b>Never</b> appears to hint that your alarm will only go off once.
<b>Ringtone</b>	Select the alarm ringtone.
<b>Vibrate</b>	Select the check box if you want the device to vibrate when the alarm goes off.
<b>Label</b>	Give the alarm a name for a special event.

- 4 Touch **Done** to set the alarm.



**NOTE:** On the **Alarms** screen you can also add a new alarm by touching the Menu button  → **Add alarm**.

## To temporarily disable an alarm

On the **Alarms** screen, clear the green bar of the alarm time you want to disable.

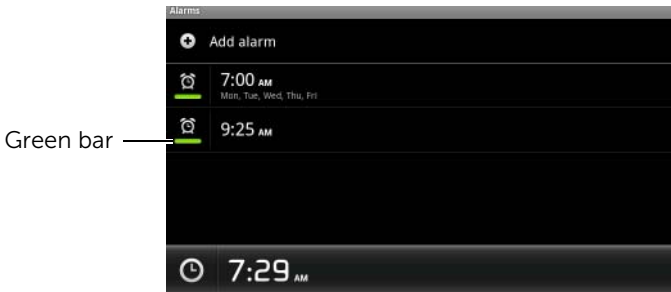

## To delete an alarm



- 1 On the **Alarms** screen, touch the alarm time you want to delete.
- 2 On the **Set alarm** screen, touch **Delete**.

## To silence all alarms

You can change the settings to choose if the alarm should ring when the device is in Silent mode.

- 1 On the **Alarms** screen, touch the Menu button  → **Settings**.
- 2 Touch **Alarm in silent mode** to set if the alarm should ring when the device is in Silent mode.









# Calculator

- 1 Touch the Launcher button  → **Calculator**. The basic calculator panel opens.
- 2 Perform calculations by touching the corresponding buttons on the calculator panel; touch the **CLEAR** button to clear the displayed numbers or symbols.
- 3 To perform advanced calculations, flick the basic calculator panel away to the left and reveal the advanced panel, or touch the Menu button  → **Advanced panel**.

# Sound Recorder

Open this application to record voice and sounds and then play them back. You can also set the recording as a ringtone for your device.

 **NOTE:** Recorder only supports recording in the amr format.

- 1 Touch the Launcher button  → **Sound Recorder** .
- 2 Touch  to start recording.
- 3 Touch  to end recording.
- 4 Touch  to start playback of the recording; touch  to stop playback.
- 5 Touch **Save this recording** to save the recording on the microSD card.
- 6 To play back a sound recording again, touch the Launcher button  → **Music**  → **Songs**, then select a recording to play. For information about **Music**, see Music.

# Voice Dialer

Touch the Launcher button  → **Voice Dialer** .

With Voice Dialer you can make calls and run applications by saying matching voice commands to your device.

Follow on-screen examples and prompts to say the voice commands that trigger needed actions.



### To say a voice command to start an action

- 1 When Voice Dialer prompts you with voice command examples such as to call a contact, say the command that includes the name of the contact you want to call. For example, if you want to call a contact named John, use this command **Call <Name>** and say "Call John" to your device.
- 2 Once your device recognizes your command, it automatically lists the matching actions. You can now choose to call a contact or open an application from the list.





## SIM Manager

Touch the Launcher button  → **SIM Manager** .

You can add and delete contacts on your SIM card, and check the number of the contacts and messages stored on it.

To copy selected entries from your device's contacts to your SIM card, touch the Menu button  → **More** → **Import Contacts**.

# Playing Videos on HDMI Devices

- 1 Insert the 30-pin connector on the bottom of your device into the 30-pin connector on the home dock.
- 2 Connect your device to a HDMI device for example a HDMI monitor or TV using a HDMI data cable.
- 3 Touch the Launcher button  → **Gallery** .
- 4 Touch a video thumbnail to start playback of the video.
- 5 The device screen displays **Video out** to ask for your confirmation. Touch **Yes** to play the video on the display of the connected HDMI device. Touch **No** if you want to play the video on the device.
- 6 To switch video playback between the device screen and the HDMI display, touch the Menu button  → **Change video out**.
- 7 To control playback, use these controls on the device screen:
  - Touch the  button to pause and the  button to resume playback.
  - Touch or drag the playback progress bar to rewind or fast-forward the video.









**NOTE:** The device supports MPEG-4/H264/H263 video files through HDMI output.



**NOTE:** The HDMI output resolution is 720p.

# Troubleshooting

Problem	Possible causes	Possible solutions
<b>Call-related problems</b>		
SIM card error	SIM card malfunction or damage.	Take the SIM card to your service provider for testing.
	The SIM card is inserted improperly.	Insert the SIM card properly.
	Dirt or dust on the SIM card's metal contacts.	Use a soft, dry cloth to clean the SIM card's metal contacts.
Poor reception	The network signal is too weak at your current location, for example, in a basement or near a tall building. Wireless transmissions can not effectively reach it.	Move to a location where the network signal can be properly received.
	The network is busy at the current time (for example, during peak times, there may be too much network traffic to handle additional calls).	Avoid using the device at such times, or try again after waiting a short time.
	You are too far away from a base station for your service provider.	You can request a service area map from your service provider.

<b>Problem</b>	<b>Possible causes</b>	<b>Possible solutions</b>
You cannot make outgoing calls	The SIM card is not installed.	Install a valid SIM card in your device.
	Poor signal.	Move to an open space, or if you are inside a building, move closer to a window.
	Your device is in Airplane mode with no wireless connectivity.	Touch the status area on the status bar and clear the Airplane mode check box.
	You have enabled the Call barring feature.	Touch the Home button  → Menu button  → Settings → Call settings → Call barring → Deactivate all.
	You have enabled Fixed Dialing Numbers.	Touch the Home button  → Menu button  → Settings → Call settings → Fixed Dialing Numbers. Disable Fixed Dialing Numbers (FDN).
You cannot answer incoming calls	Poor signal.	Move to an open space, or if you are inside a building, move closer to a window.
	Your device is in Airplane mode with no wireless connectivity.	Touch the status area on the status bar and clear the Airplane mode check box.
	You have enabled the Call barring feature.	Touch the Home button  → Menu button  → Settings → Call settings → Additional call settings → Call barring → Deactivate all.
Unable to add contacts to the device	Memory for storing contacts is already full.	Delete unnecessary contact information from the device.
Echo or noise	Poor network trunk quality on the part of your service provider, or poor local telephone line quality.	Hang up and dial again. You may be switched to a better-quality network trunk or phone line.





<b>Problem</b>	<b>Possible causes</b>	<b>Possible solutions</b>
Noises during a call	You may be near a strong electromagnetic source (such as a TV, a microwave oven, etc.) during a call.	Move to another location to reduce the interference effects.
You cannot enable certain call features	Your service provider does not support these features, or you have not applied for services that provide these features.	Contact your service provider.
PIN Code is blocked	You have entered an incorrect PIN code three consecutive times.	Contact your service provider. If the service provider provides the SIM card's PUK code, use the PUK code to unlock the SIM card.
<b>System problems</b>		
Battery does not charge	The battery or battery charger is damaged.	Contact the dealer.
	The device's temperature is below 0°C or higher than 45°C.	Adjust the battery charging environment to avoid extreme temperatures.
	Poor contact between the battery and charger.	Check all connectors to ensure that all connections have been properly made.
Unable to turn the device on.	The battery is empty.	Charge the device.
	The back cover has come off.	Ensure that the back cover is firmly secured to the device.
	The device system is corrupted	See "If the device cannot power on due to system corruption, take either of these recovery actions:" on page 160 for solutions.
	Battery contacts are not clean.	Seek your dealer's help to clean the contacts.
The device turns off automatically	The back cover has come off.	Ensure that the back cover is firmly secured to the device.

<b>Problem</b>	<b>Possible causes</b>	<b>Possible solutions</b>
Shortened standby time	The length of standby time is affected by your service provider's system configuration. The same device used with different service providers' systems does not have the same length of standby time.	If you are located in an area where the network signal is weak, temporarily turn off your device.
	The battery is depleted. In high-temperature environments, battery life will be shortened.	Use a new battery.
	If you are not able to connect to the network, the device will continue to send out signals as it attempts to locate a base station. Doing this consumes battery power and consequently shortens standby time.	Change your location to one where the network is accessible, or temporarily turn off your device.
<b>Messaging problems</b>		
Unable to send or receive text messages.	Your device is in Airplane mode with no wireless connectivity.	Touch the status area on the status bar and clear the Airplane mode check box.
	The signal strength is not strong enough.	Try moving to a different location for better signal reception.
Unable to send or receive e-mail.	The Internet connection or the e-mail setting is not configured properly.	Check your network connection, and confirm with your e-mail service provider if your e-mail setting has been configured correctly.

<b>Problem</b>	<b>Possible causes</b>	<b>Possible solutions</b>
<b>Internet problems</b>		
Unable to connect to the network.	Invalid SIM card.	Contact your service provider.
	You are not within the network's service area.	Check the service area with your service provider.
	Poor signal.	Move to an open space or if you are inside a building, move closer to a window.
<b>Media problems</b>		
Windows Media Player on my computer cannot play the sounds of the video captured using the device.	The device records video sounds in amr format, but Windows Media Player does not support amr decoding.	Play the video using a video player with the amr decoder, such as QuickTime.

**If the device cannot power on due to system corruption, take either of these recovery actions:**



#### **Reset your device to the default state**

- 1 Press and hold the power button  and then touch the Power off option on the screen to turn off the device.
- 2 Simultaneously press and hold the volume up button  and volume down button .
- 3 Without releasing the volume buttons, press and hold the power button, until the device turns on the configuration screen.
- 4 Press the volume buttons to move the highlight bar on the screen to the Factory reset option.
- 5 Press the Camera button  to start the reset process.
- 6 Wait for the device to reboot.

#### **Start software recovery**

- 1 Take out the microSD card from the device.
- 2 Connect the microSD card to your computer using a microSD adapter.
- 3 On your computer, go to support.dell.com and follow the instructions to download the software upgrade package to the microSD card.

**NOTE:** The device only recognizes the software upgrade package as "Update.pkg". Rename the downloaded package to "Update.pkg" if it is not named so.

- 4 Disconnect the microSD card from the computer and install the microSD card into the device.
- 5 Follow steps 1 to 3 in Reset your device to the default state to turn on the configuration screen.
- 6 Press the volume buttons to move the highlight bar to the Software upgrade via Update.pkg on SD Card option, and press the Camera button  to confirm your selection.
- 7 Press the Camera button  to confirm and start software recovery.





**NOTE:** If you wish to cancel software recovery, press the volume down button .

- 8 Wait for the device to load files and reboot the system.



**If necessary, you can calibrate your touch screen as follows:**

**NOTE:** Do not touch the screen during calibration.

- 1 Press and hold the power button  and then touch the Power off option on the screen to turn off the device.
- 2 Simultaneously press and hold the volume up button  and volume down button .
- 3 Without releasing the volume buttons, press and hold the power button , until the device turns on the configuration screen.
- 4 Press the volume buttons to move the highlight bar on the screen to the Screen calibration option.
- 5 Touch the Camera button  to start the touch screen calibration.
- 6 Wait for the device to reboot.

**COMPLIES WITH  
IDA STANDARDS  
DA103861**



# Index

## A

- Airplane Mode, 73
- Alarm Clock, 149
- Ambient light sensor, 10
- Android Market, 118
- Applications
  - Definition, 20
  - Erase data, 67
  - Navigate, 37
  - Recently used, 38
  - Shortcuts, 38

## B

- Back cover
  - Close, 14
  - Remove, 12
- Battery
  - Charge, 15
  - Insert, 13
- Bluetooth, 137
- Button
  - Back, 9
  - Camera, 9
  - Home, 10
  - Menu, 9
  - Power and Sleep/Wake, 9
  - Volume up/down, 8

## C

- Calculator, 151
- Calendar, 146
- Calling, 40
- Camcorder, 135
- Camera, 133
  - Camcorder, 135
  - Shoot videos, 135
  - Take pictures, 134
- Charging, 15
- Connection
  - Mobile networks, 70
  - To a computer, 136
  - Wi-Fi, 71
- Contacts, 48
  - Add, 48
  - Sync, 51
  - View, 49
- Controls, 8
  - Touch screen, 17
- Customize, 123

## D

- Data connection, 70
- Date, 126
- Device
  - Customize, 123

- Overview, 8
- Protect, 128
- Reset, 68
- Settings, 67
- Setup, 12
- Turn off, 16
- Turn on, 15

Disable all connections, 73

Display settings, 123

## **E**

E-mail, 80

Emergency software  
recovery, 160

Erase all data, 68

## **F**

Facebook, 83

Factory reset, 68

## **G**

Gallery, 140

Gmail, 89

Google Account  
Setup, 89

Google Maps, 96

Google Maps Navigation, 110

Google Search, 65

Google Talk, 92

## **H**

Home Screen  
Customize, 27

Home screen, 21

## **I**

Internet  
Browse, 73  
Connection, 70

## **K**

Keyboard, 59

## **L**

Language, 127

## **M**

Maps, 96

Messaging, 52  
Compose, 52  
Receive, 56

microSD, 136  
Format, 67  
Install, 13  
Remove, 67  
Set as USB drive, 136

- Turn off USB storage, 136
- Unmount, 67

Mobile networks, 70

Music, 143

- Create a playlist, 145
- Playback, 144

## N

Navigation, 110

News and Weather, 114

## O

On-Screen Keyboard, 59

## P

Package Contents, 7

Pictures and videos, 140

PIN

- Change, 132
- Device, 130
- Enable, 132

Places, 109

Pop-Up menu, 58

Proximity sensors, 10

## R

Recorder, 152

Ringtone, 124

## S

Screen

- Calibration, 161
- Orientation, 20
- Turn off/on, 16

Screen Unlock Pattern, 128

- Create, 128
- Disable/change, 129
- Settings, 130

Search, 65

Sensor, 10

Settings

- Date and time, 126
- Display, 123
- Language, 127
- Sound and ringtone, 124

Shortcuts, 38

- Add, 28
- Definition, 21

SIM card

- Insert, 12

SIM Manager, 153

Software

- Recovery, 160
- Upgrade, 68

Sound, 124

Stage

- Desktop, 21
- Home screen, 21
- Widgets, 24

Status bar, 33  
Icons, 34  
Synchronize Google Data, 122

**Y**  
YouTube, 116

## **T**

Text message, 52  
Time, 126  
Time zone, 126  
Touch screen, 17  
Troubleshooting, 155  
Twitter, 86

## **V**

Videos  
Play on HDMI devices, 154  
Voice Dialer, 152  
Voice Search, 65

## **W**

Web  
Applications, 83  
Bookmarks, 78  
Widgets  
Add, 30  
Definition, 20  
Google Search, 65  
Wi-Fi, 71

## Free Manuals Download Website

<http://myh66.com>

<http://usermanuals.us>

<http://www.somanuals.com>

<http://www.4manuals.cc>

<http://www.manual-lib.com>

<http://www.404manual.com>

<http://www.luxmanual.com>

<http://aubethermostatmanual.com>

Golf course search by state

<http://golfingnear.com>

Email search by domain

<http://emailbydomain.com>

Auto manuals search

<http://auto.somanuals.com>

TV manuals search

<http://tv.somanuals.com>