

50-900 Series Dust Collector

INSTRUCTION MANUAL



SHOWN WITH
ACCESSORY 50-311
DRUM DOLLIES
(DRUMS NOT SUPPLIED)

DATED 5-21-93

PART NO. 1345315

©Delta International Machinery Corp. 1993

 **DELTA**

TABLE OF CONTENTS

SAFETY RULES	3
INTRODUCTION	3
UNPACKING	3
ASSEMBLY INSTRUCTIONS	
Assembling Cyclone Separator To Fan Housing	4
Assembling Legs To Blower Assembly	5
Assembling Support Braces To Leg Assembly	6
Assembling Feet To Leg Assembly	6
Assembling Outlet Connector To Fan Housing	7
Lifting The Dust Collector	8
Assembling Dust Filter Bag Support Assembly	8
Assembling Hose To Dust Collector	9
Assembling Dust Filter Bag To Dust Collector	10
CONNECTING DUST COLLECTOR TO POWER SOURCE	11
MOTOR RATINGS	11
50-900 SERIES DUST COLLECTOR SPECIFICATIONS	12
CENTRAL SYSTEM DESIGN	12
MAINTENANCE	12
PARTS, SERVICE OR WARRANTY ASSISTANCE	13
AUTHORIZED SERVICE STATIONS	14-15
WARRANTY	16

READ INSTRUCTIONS CAREFULLY BEFORE ATTEMPTING TO ASSEMBLE, INSTALL, OPERATE OR SERVICE YOUR DUST COLLECTOR! RETAIN INSTRUCTIONS FOR FUTURE REFERENCE.

SAFETY RULES

1. Follow all local electrical and safety codes, as well as the National Electric Code (NEC) and the Occupational Safety and Health Act (OSHA). All electrical connections and wiring should be performed by qualified personnel only.
2. National Fire Protection Association (NFPA) standards require specific duct design and dust collector configuration when collecting potentially reactive metal dusts, such as aluminum and magnesium. Consult current NFPA standards before setting up a dust collector and/or duct design for these two materials. Also review all other NFPA standards concerning wood dust collection, especially NFPA 664.
3. Ground the dust collector as per National Electric Code (NEC) requirements.
4. Replace or repair damaged or worn power cable immediately.
5. Protect the power cable and never allow the cable to come in contact with sharp objects.
6. Do not kink power cable and never allow the cable to come in contact with oil, grease, hot surfaces or chemicals.
7. Make certain that the power source conforms to the requirements of your equipment.
8. **KEEP AWAY FROM UNIT WHEN IT IS OPERATING.**
 - a. There is a high speed blower wheel inside the blower housing that can amputate fingers, grab loose clothes or neckties.
 - b. There is also a high speed cooling fan wheel on the top of the motor that should be avoided for the same reasons mentioned in item (a).
9. This unit is heavier than the legs it sits on and can be overturned if bumped or not placed on a clean, level surface.
10. **DISCONNECT DUST COLLECTOR FROM POWER SOURCE BEFORE ATTEMPTING TO CLEAN OR SERVICE THE UNIT.**

INTRODUCTION

These dust collectors are designed to help maintain clean, safe conditions around dust creating machines in workshops and factories.

Dust collectors work by moving larger volumes of air at lower suction pressures than vacuum cleaners. These units are not designed to be used as high-suction vacuum cleaners.

WARNING: The blower housing contains a high speed radial blade that can amputate fingers, grab loose clothing and neckties, or propel dust at high velocities. DO NOT OPERATE WITHOUT THE DISCHARGE GUARD AND DUST BAG IN POSITION.

Do not attempt to clean, remove dust bag, service unit or move a dust collector while in operation. Always disconnect from power source first.

UNPACKING

Remove the dust collector components from the shipping containers. Check parts list for missing or damaged parts. Set the blower housing (A) Fig. 2 on the floor or sturdy supporting surface, as shown.

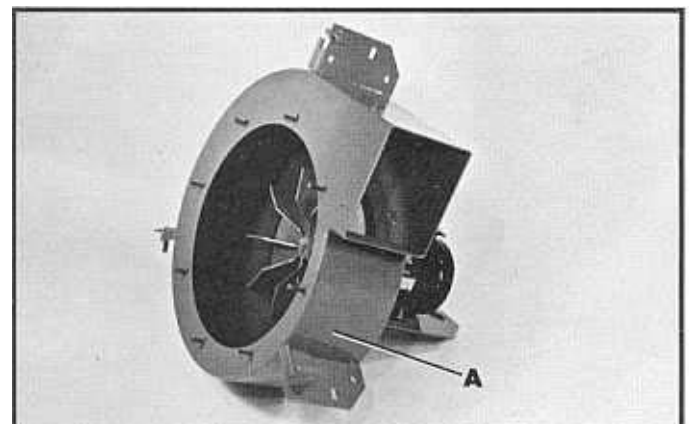

Fig. 2

ASSEMBLY INSTRUCTIONS

ASSEMBLING CYCLONE SEPARATOR TO FAN HOUSING

1. Place cyclone separator (B) Fig. 3, on the floor or a sturdy supporting surface.

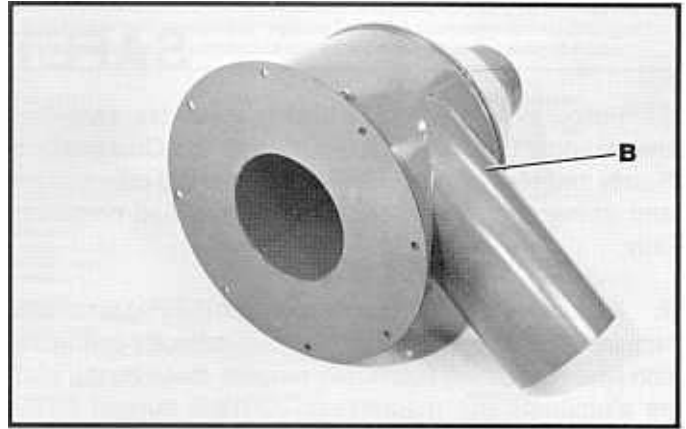

Fig. 3

2. Remove the paper backing and start the 1/2" wide gasket material (C) Fig. 4, supplied, around the outer edge of cyclone separator (B), and continue until a complete circle is formed as shown in Fig. 5. Cut off any excess gasket material. **NOTE:** The purpose of this gasket is to prevent any air leakage into the blower. If the gasket is not installed properly, sound levels will increase during operation.

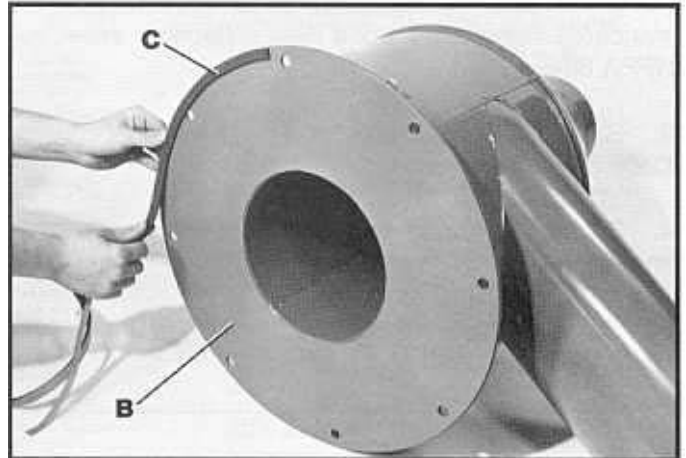

Fig. 4

3. Remove protective sleeves from studs (E) Fig. 6. Align the eight holes (D) Fig. 5, of cyclone separator (B) with threaded studs (E) Fig. 6, of blower housing (A) and attach the units together as shown in Fig. 7. **IMPORTANT:** Cyclone separator (B) Fig. 7, can be rotated to any position best suited for the inlet tube (E); however, do not position cyclone separator (B) so intake tube (E) will interfere with three leg mounting lugs (F).

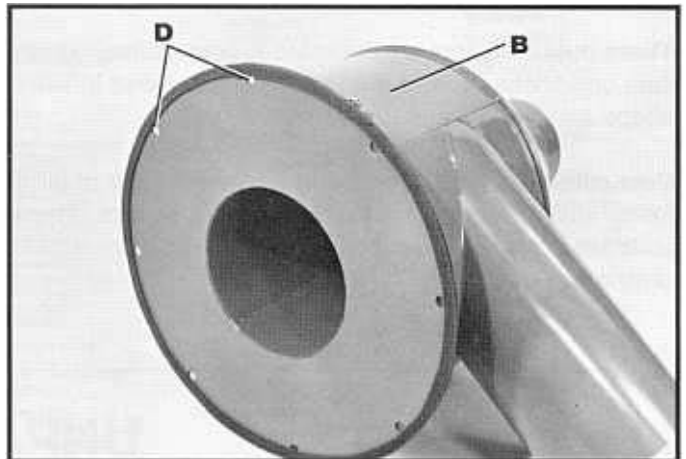

Fig. 5

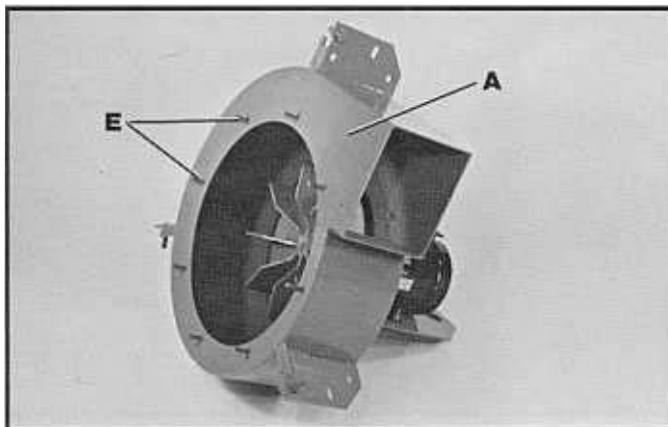

Fig. 6

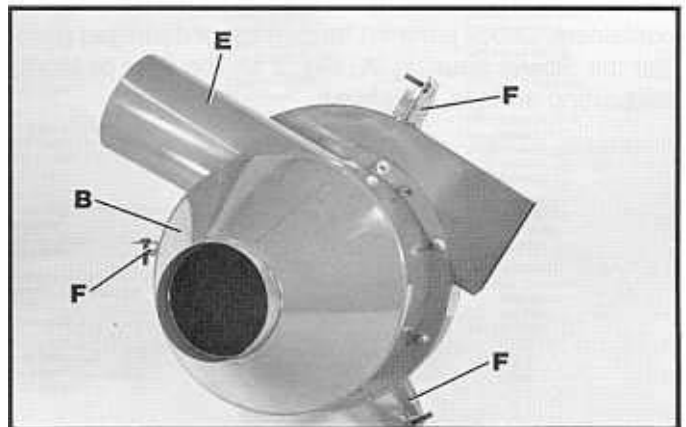

Fig. 7

4. Fasten cyclone separator (B) Fig. 8, to blower housing (A) with eight 3/8" flat washers, 3/8" lockwashers and hex nuts (G).

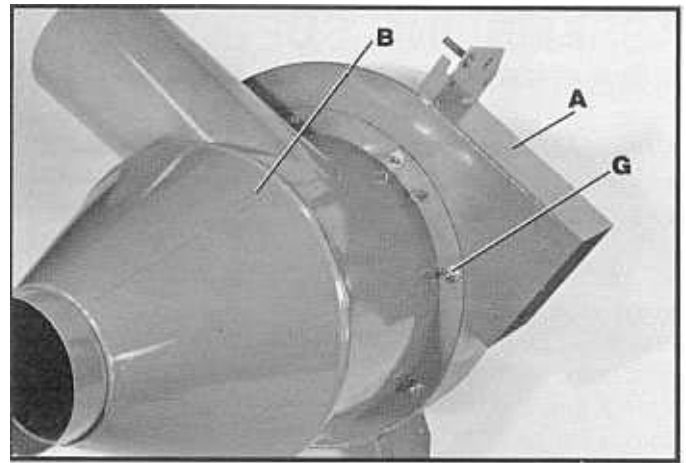

Fig. 8

ASSEMBLING LEGS TO BLOWER ASSEMBLY

1. Remove hex nut from welded bolt on lug (B) Fig. 9. Assemble one leg section (A) Fig. 9, to lug (B) and fasten with one 1-1/2 inch-long screw (C), three flat washers, two lockwashers and two hex nuts. **NOTE:** Do not completely tighten hardware at this time. Make certain single slot (D) Fig. 9, in leg section (A) is facing outward as shown, and edge of leg angle (A) is pointing counterclockwise when viewed from below the cyclone separator.

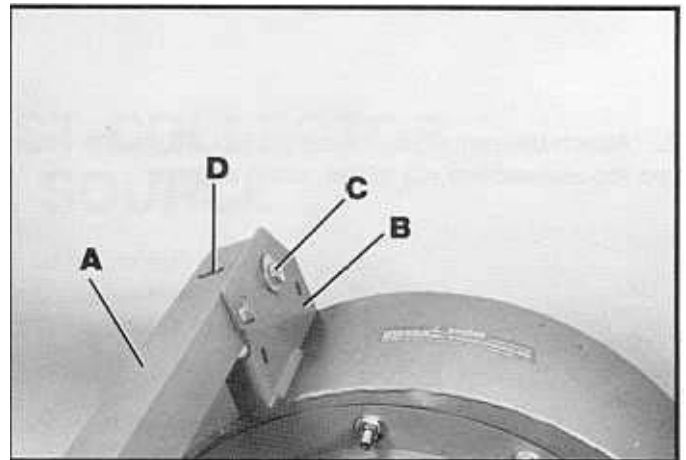

Fig. 9

2. Assemble remaining two legs to mounting lugs in the same manner.

3. Fig. 10, illustrates upper legs (A) assembled to blower assembly.

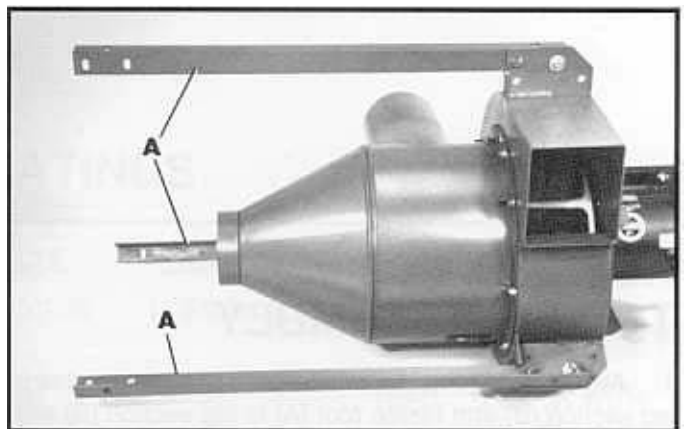

Fig. 10

4. Assemble lower leg section (F) Fig. 11, over upper leg (A) as shown using two 1 1/2 inch-long screws, (G) and (H) Fig. 11, four flat washers, two lockwashers and hex nuts. **NOTE:** Assemble screw (G) Fig. 11, first. **IMPORTANT:** Lower leg (F) must overlap leg (A). Do not completely tighten hardware at this time. Adjustments will be necessary after unit is upright.

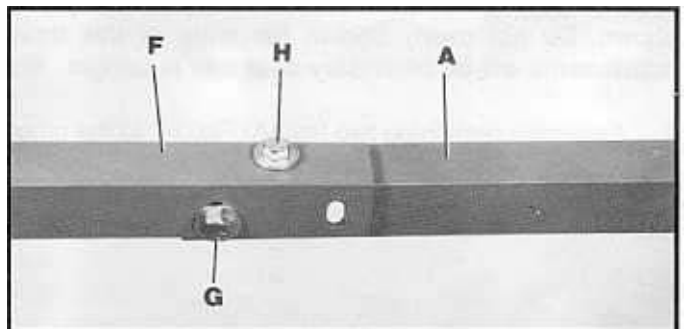

Fig. 11

5. Assemble remaining two lower legs to upper legs in the same manner.

ASSEMBLING SUPPORT BRACES TO LEG ASSEMBLY

IMPORTANT: Two support brackets (A) and (B) Fig. 12, must be assembled to a leg section (C) simultaneously for proper assembly.

1. Place one support brace (A) Fig. 12, on the outside of leg assembly (C), and brace (B) on the inside of leg assembly (C). Fasten support braces to leg assembly (C) with one 2 inch-long screw (D), two flat washers, lock-washer and hex nut. **NOTE:** Do not overly tighten hardware at this time. Adjustments will be necessary after unit is upright.

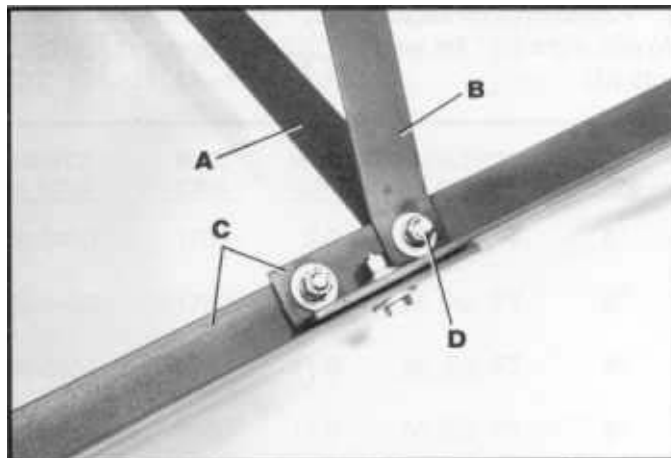

Fig. 12

2. Attach the remaining brace (E) Fig. 13, to the other two leg assemblies (C) in the same manner.

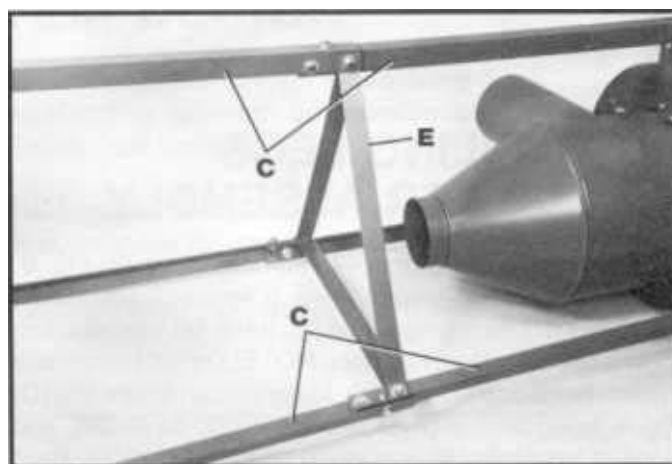

Fig. 13

ASSEMBLING FEET TO LEG ASSEMBLY

1. Align foot (A) Fig. 14 with welded bolt, with holes in leg section (B) and fasten foot (A) to leg section (B) with one 1-1/2 inch-long screw (C), three flat washers, two lock-washers and two hex nuts. **IMPORTANT:** Foot (A) Fig. 14, must be positioned on the outside of leg Section (B) as shown. Do not overly tighten hardware at this time; adjustments will be necessary after unit is upright.

2. Assemble remaining two feet (A) Fig. 14, to the other leg sections in the same manner.

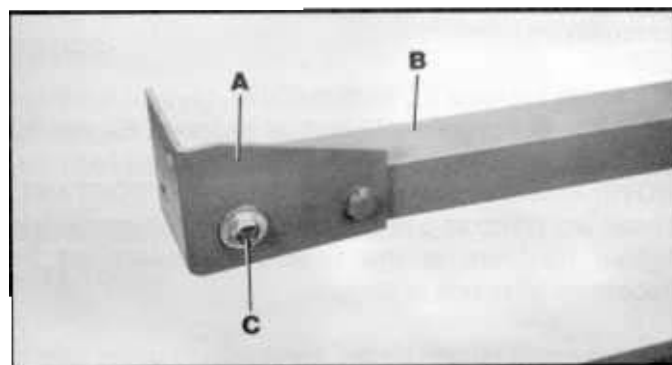

Fig. 14

ASSEMBLING OUTLET CONNECTOR TO FAN HOUSING

NOTE: Silicone sealant supplied, should be applied to the joint between the outlet and fan housing to ensure an airtight seal which will prevent increased sound levels during operation.

1. Apply a bead of sealant (A) Fig. 15, around the opening of fan housing (B) as shown.

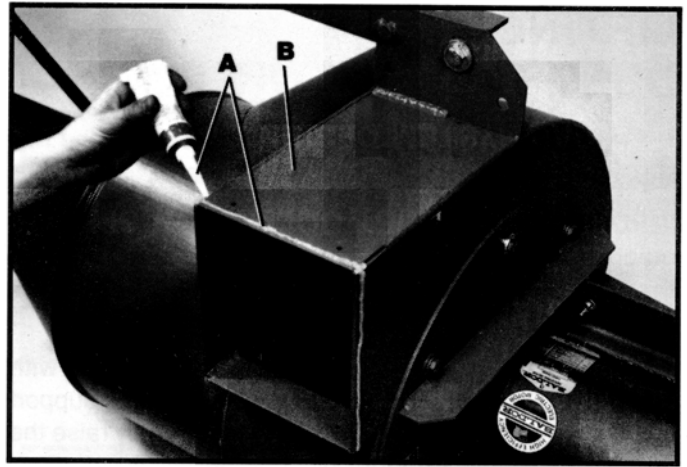

Fig. 15

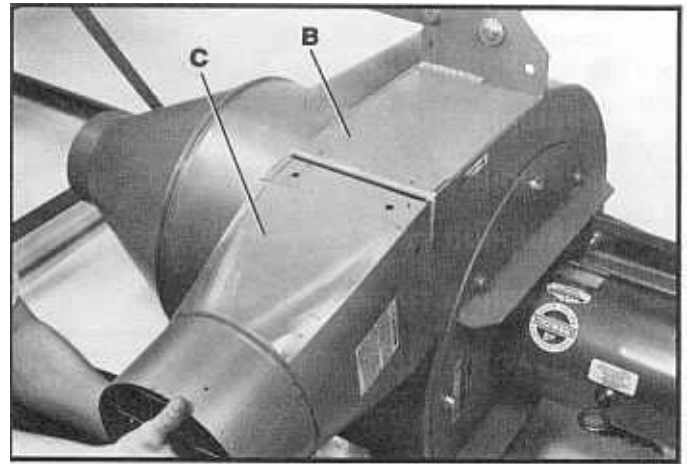

Fig. 16

2. Position outlet connector (C) Fig. 16, over lip of fan housing (B). Align holes in outlet connector (C) Fig. 16, with pre-drilled holes in fan housing (B), and fasten with eight #14 x 1/2" pan head screws, four of which are shown at (D) Fig. 17.

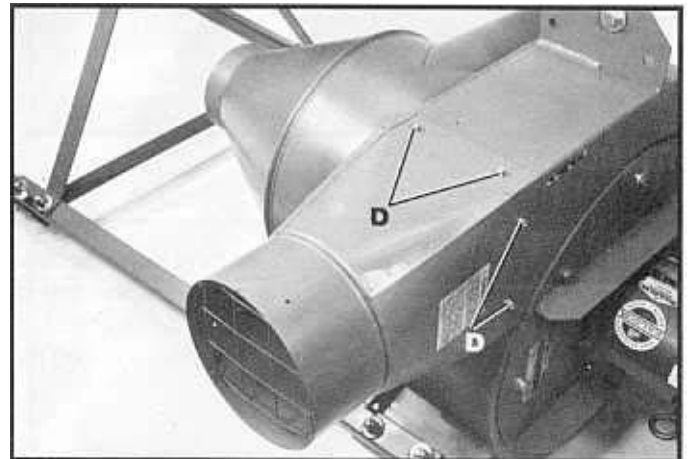

Fig. 17

LIFTING THE DUST COLLECTOR

1. Position the dust collector on the floor, with the two legs nearest the motor resting on the floor.

IMPORTANT: The dust collector can be raised mechanically or manually. Because of the weight of the dust collector, we strongly recommend using a forklift or hoist with guide ropes to set the unit upright.

2. **CAUTION:** Attach a sling or cable (A) Fig. 18, with at least a 750 pound live load capacity to the motor support frame (B) as shown. Using guide ropes, carefully raise the dust collector to an upright position on the floor.

3. Without removing the lifting sling or cable and keeping the sling or cable taut, carefully check the alignment of the fan housing and feet. The fan housing should be level with the floor with the feet adjusted to the floor surface.

4. **IMPORTANT:** Carefully loosen mounting hardware just enough to adjust dust collector, mounting legs and feet to floor surface. Tighten all leg and foot mounting hardware after unit is level with the floor surface.

WARNING: Do not assemble casters to the feet, as they can affect the stability of the machine and create a hazard. After the dust collector is in its final position, the holes provided in the feet should be used to anchor the dust collector to the floor.

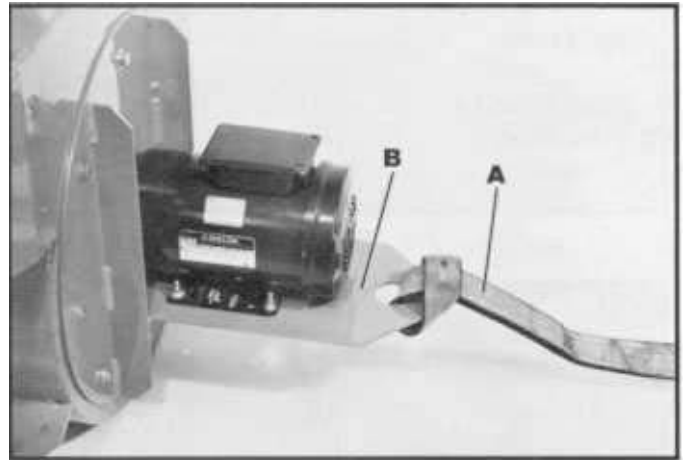

Fig. 18

ASSEMBLING DUST FILTER BAG SUPPORT ASSEMBLY

1. Assemble the four-foot long angle section (with four holes) (A) Fig. 19, upright to mounting lug (B) of fan housing next to outlet with two 1-1/4 inch-long screws (C), four flat washers, two lockwashers and hex nuts as shown. Make certain the angle section (A) is vertical, then securely tighten screws (C).

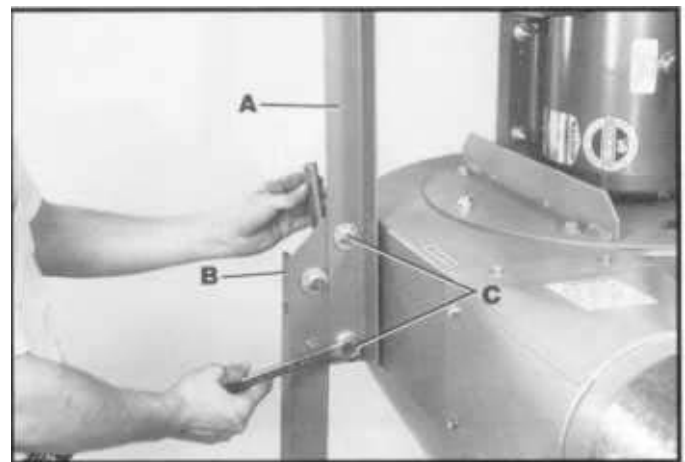

Fig. 19

2. Assemble the remaining four foot-long angle section (with five holes) (D) Fig. 20, horizontally to the top of vertical angle section (A) which was assembled in **STEP 1**. Fasten with a 1-1/4 inch-long screw (C), two flat washers, lockwashers and hex nut.

3. Assemble slotted hole end of 34 inch-long angle support bar (E) Fig. 20, to horizontal angle section (D) and fasten with 1-1/4 inch-long hex head screw (F), two flat washers, lockwasher and hex nut as shown. **NOTE:** End of support bar (E), with 45 degree angle, should be at the bottom.

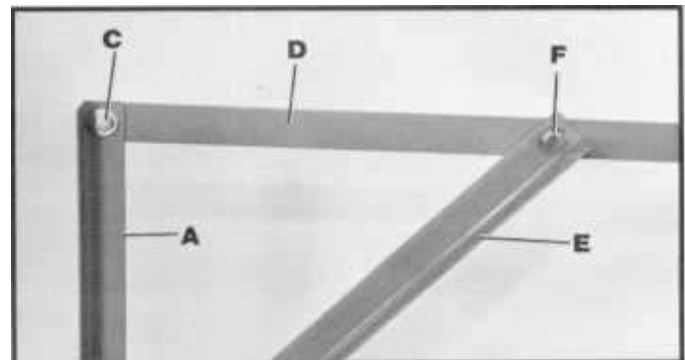

Fig. 20

4. Assemble the remaining 45 degree end of support bar (E) Fig. 21, to vertical support bar (A) with 1-1/4 inch-long screw (G), two flat washers, lockwasher and hex nut. Position horizontal angle support (D) Fig. 22, parallel to the floor and securely tighten all hardware mentioned in this section.

5. Assemble one end of remaining support brace (H) Fig. 22, to underside of horizontal angle support (D), as shown and fasten with 1-1/4 inch-long screw (J), two flat washers, lockwasher and hex nut. **NOTE:** Do not completely tighten hardware at this time.

6. Assemble remaining end of flat support brace (H) Fig. 23, to lug (K) of fan housing and fasten with 1-1/4 inch-long screw, two flat washers, lockwasher and hex nut (L) as shown. Securely tighten hardware at both ends of flat support brace (H).

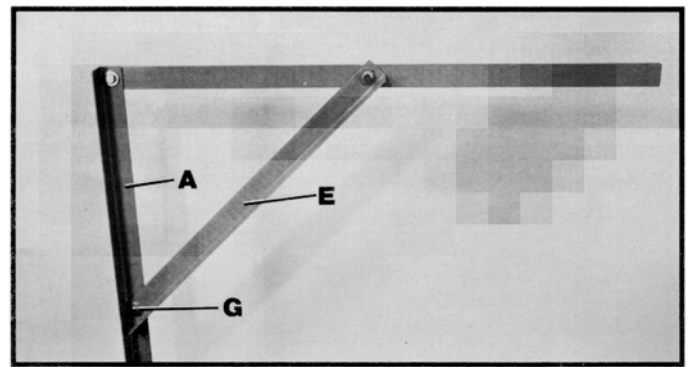

Fig. 21

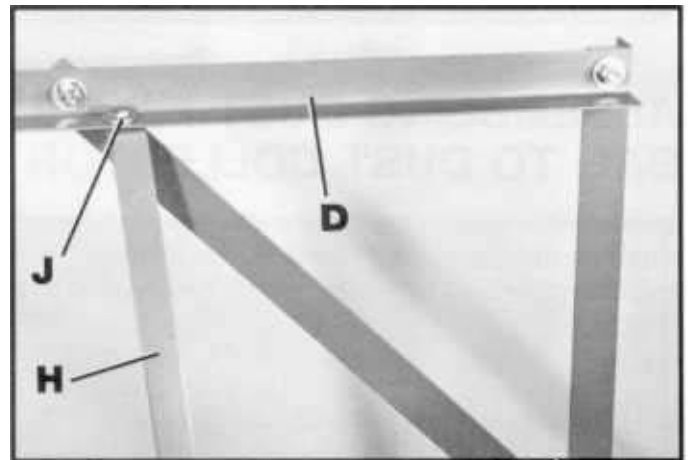

Fig. 22

ASSEMBLING HOSE TO DUST COLLECTOR

1. Slide clamp (A) Fig. 24, supplied, over one end of 7 inch diameter hose (B).

2. Assemble hose (B) Fig. 24, over bottom outlet (C) of cyclone separator and tighten clamp (A).

3. Apply 1-1/4" gasket material (D) Fig. 25, supplied, to underside of fiberglass drum lid (E) as shown, adjacent to lip (H) of drum lid. **NOTE:** Do not apply gasket material (D) to lip (H) of lid. Gasket (D) will provide an airtight seal between drum lid and standard 55 gallon drum (not supplied).



Fig. 23

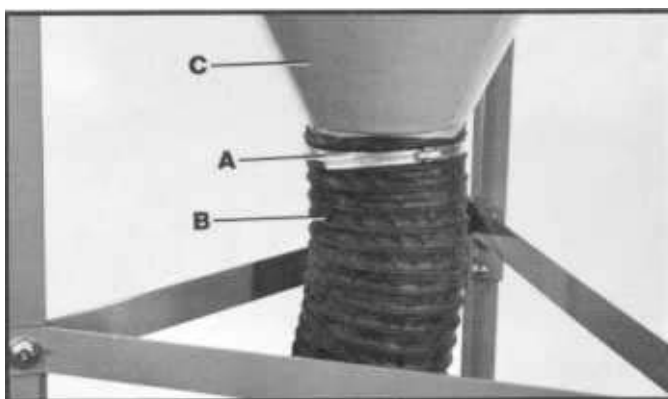

Fig. 24

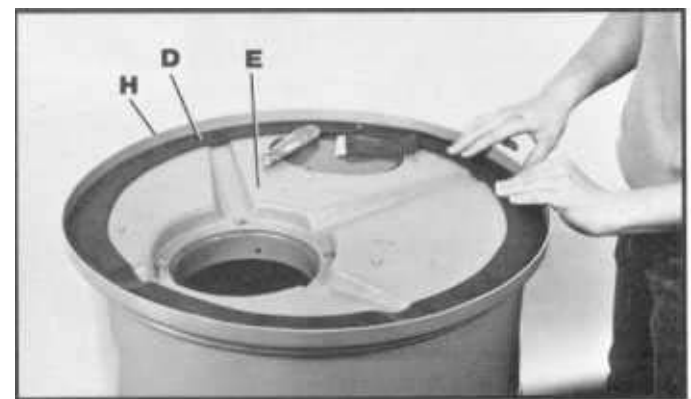

Fig. 25

4. Turn drum lid (E) Fig. 26, over and set on 55 gallon drum (not supplied).

5. Slide clamp (F) Fig. 26, over free end of hose (B). Assemble hose (B) over flange of drum lid (E), slide clamp (F) downward over flange and tighten screw (G).

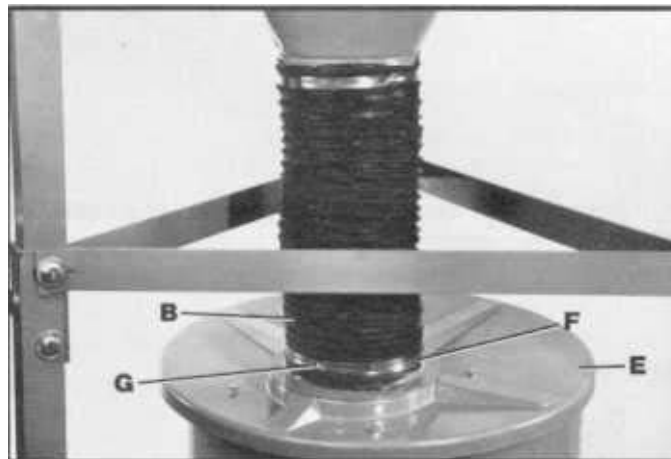

Fig. 26

ASSEMBLING DUST FILTER BAG TO DUST COLLECTOR

1. Assemble rope (A) Fig. 27, to end of overhead support assembly (B) and attach free end of rope to eyelet (C) of bag assembly. **NOTE:** Use temporary knot to hold dust filter bag in place.

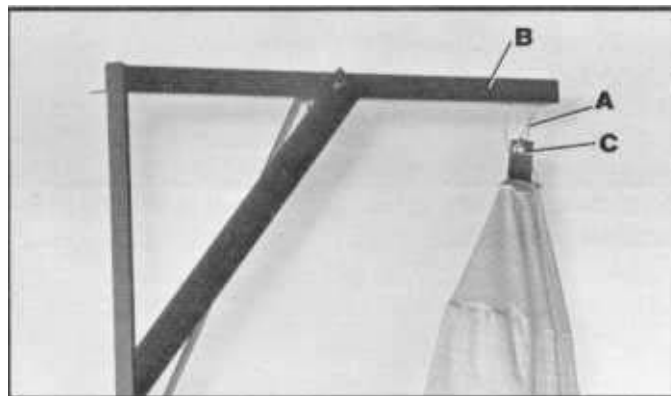

Fig. 27

2. FOR ALL MODELS EXCEPT 50-904

Slide clamp (D) Fig. 28, over outlet connector (E). Slide small diameter bag opening (F) over sleeve of outlet connector (E), then slide clamp (D) over bag (F) and tighten screw (G).

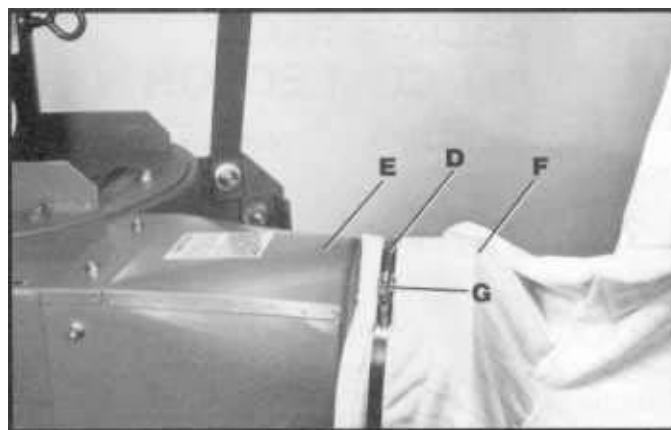

Fig. 28

3. FOR MODEL 50-904 ONLY

Slide clamp (D) Fig. 29, over outlet connector (E). Assemble air flow diverter (H) Fig. 29, supplied with the dust collector, over sleeve of outlet connector (E) with the openings facing up and down as shown. Align the four holes in the diverter (H), with the four pre-drilled holes in the outlet connector (E) and fasten with four 1/2 inch-long sheet metal screws, one of which is shown at (J) Fig. 29. Carefully slide small diameter bag opening (F) Fig. 30, over diverter (H) as shown, then slide clamp (D) over bag (F) and onto sleeve of outlet connector (E), as shown in Fig. 28, and tighten screw (G).

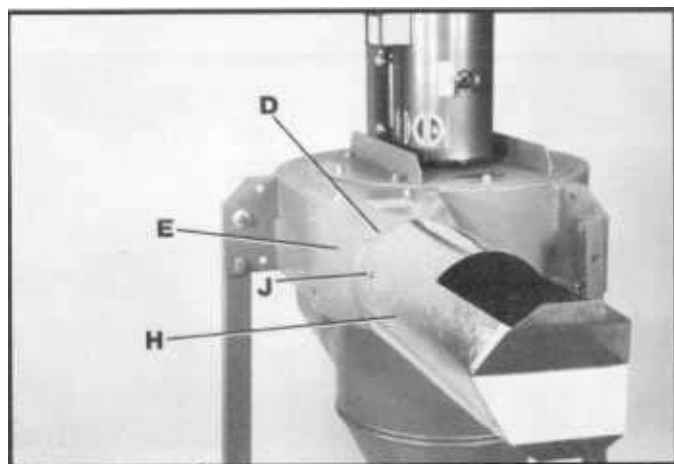

Fig. 29

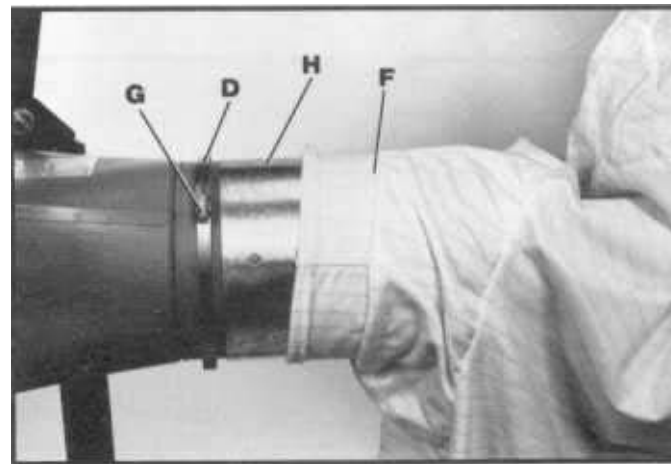

Fig. 30

4. FOR ALL MODELS

Assemble large diameter opening of dust filter bag (F) Fig. 31, over lip of standard 55 gallon drum (not supplied) and fasten belt clamp (H) to hold filter bag (F) to drum.

5. Adjust the rope which was temporarily tied in **STEP 1**, so the dust filter bag does not droop or sag and retie knot in rope.



Fig. 31

CONNECTING DUST COLLECTOR TO POWER SOURCE

Your dust collector is supplied with a motor; however, it is not supplied with controls such as switches, starters, power cords or plugs for supplying power to the dust collector.

Wiring power to the dust collector must be completed by a competent electrician. The electrical wiring must be in accordance with local and national electric codes, safety standards and in accordance to the electrical ratings shown in the table below:

MOTOR RATINGS

<u>DUST COLLECTOR</u>	<u>HP</u>	<u>PHASE</u>	<u>RPM</u>	<u>FREQ</u>	<u>VOLTS</u>	<u>AMPS</u>	<u>ENCLOSURE</u>	<u>FRAME</u>
50-900	3	3	3450	60	208-230/460	10.6-9.6/4.8	TEFC	56 WITH EXT. SHAFT
50-901	3	1	3450	60	230	17	TEFC	56 WITH EXT. SHAFT
50-902	5	3	3450	60	208-230/460	16.8-15.2/7.6	TEFC	56 WITH EXT. SHAFT
50-903	5	1	3450	60	230	19.5	TEFC	184T
50-904	7½	3	3450	60	208-230/460	19.0-17.2/8.6	TEFC	184T

50-900 SERIES DUST COLLECTOR SPECIFICATIONS

<u>CATALOG NUMBER</u>	<u>MOTOR SIZE</u>	<u>PH</u>	<u>MOTOR VOLTAGE</u>	<u>HERTZ & RPM</u>	<u>MAX CFM</u>	<u>MAX SP</u>	<u>FILTER AREA</u>	<u>INLET SIZE</u>
50-900	3 HP	3	208-230/460	60-3450	1780	9.0	50 SQ. FT.	8"
50-901	3 HP	1	230 ONLY	60-3450	1780	9.0	50 SQ. FT.	8"
50-902	5 HP	3	208-230/460	60-3450	2080	11.0	50 SQ. FT.	8"
50-903	5 HP	1	230 ONLY	60-3450	2080	11.0	50 SQ. FT.	8"
50-904	7.5 HP	3	208-230/460	60-3450	2400	14.8	50 SQ. FT.	8"

CENTRAL SYSTEM DESIGN

Because of the complexities involved in designing a dust collection system for each individual installation, we recommend that you refer to the "Air Handling Systems" brochure enclosed in the owners packet shipped with the Delta 50-900 Series Dust Collector.

This "Air Handling Systems" brochure lists technical information, component parts and other data relating to the proper installation of the dust collector accessories for your particular application.

CALL TOLL FREE: 1-800-FOR-DUCT or FAX: 1-203-389-8340 FOR INFORMATION.

MAINTENANCE

NOTE: Before any maintenance or service is performed, be sure that unit is disconnected from power source to prevent accidental starting.

CAST ALUMINUM & SHEET METAL FITTINGS:

The cast aluminum blower impeller, as well as all sheet metal fittings are maintenance free and should not require any maintenance during the life of the unit; however, periodically inspect the impeller for possible cracks or excessive wear, which can cause unbalance.

DO NOT USE AN IMPELLER THAT IS CRACKED OR EXCESSIVELY WORN; REPLACE IT WITH A NEW IMPELLER.

MOTOR MAINTENANCE:

Removing dust and dirt: Blow off motor with low pressure air to remove dust or dirt. Air pressure above 50 P.S.I. should not be used as high pressure may damage insulation and blow dirt under loosened tape. The operator performing this cleaning function should always wear appropriate eye protective goggles. Built-up dust can cause excessive insulation temperatures, thereby affecting motor life.



PARTS, SERVICE OR WARRANTY ASSISTANCE

All Delta Machines and accessories are manufactured to high quality standards and are serviced by a network of factory service centers and authorized service stations listed in your owner's manual. To obtain additional infor-

mation regarding your Delta quality product or to obtain parts, service or warranty assistance, please call or fax Delta's toll-free 'hotline' number.

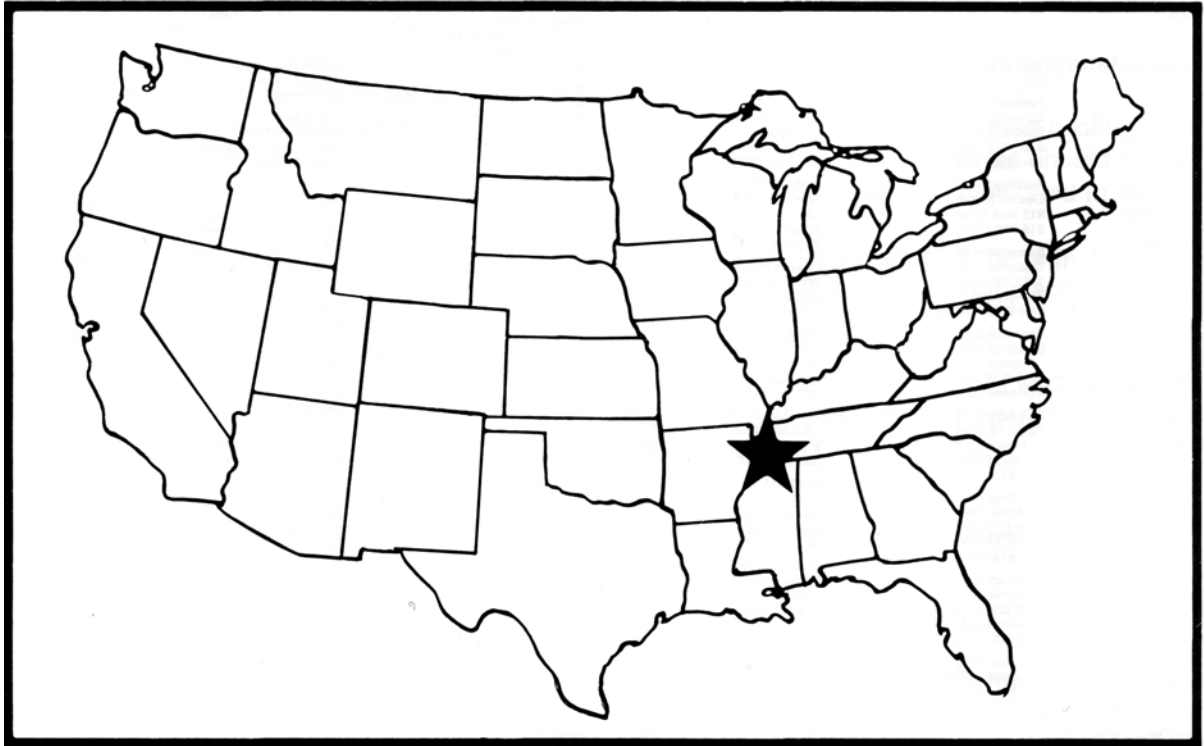

Delta maintains a modern, efficient Parts Distribution Center, maintaining an inventory of over 15,000 parts located in Memphis, Tennessee.

Highly qualified and experienced Customer Service Representatives are standing by to assist you on weekdays from 8:00 A.M. to 5:00 P.M. Memphis time.

MEMPHIS, TN 38118
4290 Raines Road
Phone: (901) 363-8800

~~HOTLINE~~

800-223-PART
FAX: 800-535-6488

AUTHORIZED SERVICE STATIONS

In order to promote tool safety, Delta International Machinery Corp. strictly enforces the policy of repairing or replacing any damaged or missing standard safety equipment on machines presented to Delta Authorized Service Centers for service/repairs. Any product which is presented to a Delta Authorized Service Center for repairs which contains missing or damaged standard safety equipment will have that equipment repaired or replaced and the customer will be charged for any such service/repairs. Customers can avoid such charges only if the missing safety component is supplied to the service center at the time of repair.

ALABAMA
Hueytown 35023
Owens Power Tool Service, Inc.
700 Brooklane
205-942-6325
Montgomery 36121
Nor Wood Industries, Inc.
581-A George Todd Drive
205-260-9663
Mobile 36693
Southern Power Tool
3956 Government Blvd.
205-666-3623
ALASKA
Anchorage 99503
Alaska Tool & Equip. Service
3207 Arctic Boulevard
907-562-6151
Fairbanks 99706
Fairbanks Aero Services, Inc.
Box 60590
907-479-6666
ARIZONA
Glendale 83501
Banner Tool Service
6741 N. 57th Avenue
602-842-0800
Mesa 85204
East Valley Tool & Equipment
Service
835 East Southern Avenue, #4
602-892-6163
Peoria 85345
Banner Tool Service
8240 W. Jefferson Street
602-486-1629
Phoenix 85014
Glenn's Tool Service
4036 North 13th Way
602-264-6203
Tucson 85719
Western Tool Inc.
702 So. Campbell
602-684-0504
ARKANSAS
Fl. Smith 72901
Tool Service Co.
4420 Wheeler Avenue
501-648-3125
Little Rock 72202
Electric Tool Service
1419 West 10th Street
501-374-8180
CALIFORNIA
City of Industry 91745
Porter-Cable Corporation
1305 John Reed Court
818-333-3566
Concord 94520-5679
California Electric Service
1170-G Burnett Avenue
415-827-1011
Fax: 415-827-5409
Covina 91723-3536
California Electric Service
612 S. Shoppers Lane
918-915-4935
Fax: 918-339-6505
Dublin 94568-2611
California Electric Service
6759 Sierra Court, Suite B
415-551-3390
Fax: 415-551-3392
Eureka 95501
Electric Tool Co.
2810 Park St.
707-442-4267
Fontana 92335
California Electric Service
9744 Sierra Avenue
909-355-2500
Fresno 93703
R & R Machinery & Electric Inc.
1919 E. Home Avenue
209-233-1213
Fullerton 92631
California Electric Service Center
1208 E. Ash Avenue
714-870-0900
Huntington Beach 92649
Modern Tool Service
15561 Product Lane Unit D-6
714-898-3425
Los Alamitos 90720-3958
California Electric Service
11294 Los Alamitos Blvd.
213-430-2668
Fax: 213-598-8726
Los Angeles 92203
Minit Tool Company
3026 E. Olympic
213-264-7006
Mission Viejo 92691-3128
California Electric Service
23725 Via Fabricante, Unit B
714-586-9440
Fax: 714-586-9514
Modesto 95351
Stanislaus Electric Mtr. Works
504 River Road
209-523-8269
National City 92050
Natl. Tool & Machy. Repair, Inc.
241 W. 35th St. STE D
619-422-8665
North Hollywood 91605
Bucknall Power Tool Service
11910 Vosa Street
818-765-0228
Oakland 94606
California Electric Service, Inc.
1143 E. 12th Street
415-834-1050
Fax: 415-836-1125
Oceanside 92054
Power Source
1555 S. Hill Street
619-433-6600
Pasadena 91107-3785
California Electric Service
2594 E. Colorado Blvd.
818-792-3194
Fax: 818-792-0511
Redding 96002
Electric Tool and Motor
915 Wall Street #1
916-222-1131
Sacramento 95814-6784
California Electric Service
1821 "Q" Street
916-443-5711
Fax: 916-443-4092
Sacramento 95814
Construction Industry Service
Company
1211 C Street
916-444-2525
San Carlos 94070-4168
California Electric Service
990 Industrial Road, Suite 102
415-593-6696
Fax: 415-593-6698
San Diego 92104-1593
California Electric Service
3430 El Cajon Blvd.
619-283-6488
Fax: 619-281-3479
San Francisco 94103-4488
California Electric Service
1090 Bryant Street
415-431-8494
Fax: 415-431-9207
San Jose 95126-3154
California Electric Service
783 The Alameda
408-295-1722
Fax: 408-295-8451
San Leandro 94577
Porter-Cable Corporation
3039 Teagarden Street
P.O. Box 1913
415-357-9762
San Marcos 92069
Pro-Tek Tool Repair
215 Pacific Street, #111
619-471-4800
Santa Ana 92707-2850
California Electric Service
2025 S. Main Street
714-641-0529
Fax: 714-641-2947
Santa Barbara 93101
Buena Tool Co.
433 Laguna Street
805-963-3885
Santa Rosa 95401
Acme Electric Tool Repair
742 Wilson Street
707-546-5862
Santa Rosa 95403
H & V Tool Repair
1808 Empire Industrial Court #D
707-528-1111
Simi Valley 93065
Simi Tool Repair
1236 Los Angeles Avenue,
Unit D
805-584-8138
Temecula 92390-5623
California Electric Service
41715 Enterprise Circle North
909-695-5445
Torrance 90502
Universal Tool Service
21804 S. Vermont Avenue
213-328-6472
Van Nuys 91411-1018
California Electric Service
14753 Oxnard Street
818-997-8855
Fax: 818-997-3047
Whittier 90602
Bathels Hardware & Tool Co.
13238 E. Whittier Blvd.
213-698-3714
W. Los Angeles 90064-2110
California Electric Service
2314 S. Westwood Blvd.
213-475-2532
Fax: 213-475-2844
COLORADO
Avon 81620
Tool Clinic
41000 Highway 6
303-949-6282
Colorado Springs 80219
Schlosser Tool and Machinery
3960 Sinton Road
719-636-1311
Denver 80204
Porter-Cable Corporation
2561 West 8th Ave.
303-692-6113
Denver 80219
"Schlosser Tool & Machinery
301 Bryant Street
303-922-8244
Grand Junction 81501
Professional Tool Service, Inc.
2420 E. Main
303-245-3158
CONNECTICUT
Hartford 06106
Utility Electric Service, Inc.
53 Main Street
203-246-7271
Oakville 06779
Watertown Tool Supply
28 Main Street
203-596-1344
DELAWARE
New Castle 19804
Holloway Bros.
19 E. Commons Blvd.
302-322-5441
Wilmington 19804
"Holloway Bros.
P.O. Box 3055
302-322-5441
FLORIDA
Fl. Lauderdale 33334
Master Repair Inc.
4107 N.E. 8th Avenue
305-566-5833
Fl. Myers 33905
Power Tool Repair of Ft. Myers
9950 Orange River Blvd.
813-694-6058
Gainesville 32609
Florida Fastener and Tool Co., Inc.
2826 N. Waldo Road
904-377-4587
Hialeah 33014
Porter-Cable Corporation
16373-75 NW 57th Ave.
305-624-2523
Jacksonville 32205
North Florida Machinery
& Tool Repair
230-B Edgewood Ave. South
904-387-4455
Orlando 32803
Finch's Machinery & Tool
Service Inc.
1807-1/2 Winter Park Road
407-644-8100
Pensacola 32505
L.C. Electric Motor Service
117 Industrial Blvd.
904-476-7655
Riviera Beach 33404
3706 E. Industrial Way
407-848-4320
Tampa 33609
Porter-Cable Corporation
4538 W. Kennedy Blvd.
813-877-9585
West Palm Beach 33409
Rogers Engines Inc.
2532 Old Okesehobee Road
407-689-8300
GEORGIA
Augusta 30901
Tool Service Center
Box No. 1488
302 Walton Way
404-742-4803
Morrow 30260
Porter-Cable Corporation
1286C Citizens Parkway
404-961-9090
Savannah 31402
Morgan's
110 Ann Street
912-234-2271
HAWAII
Hilo 96720
Hawaii Planing Mill Ltd.
380 Kaneohehewa Avenue
808-935-0875
Honolulu 96819
A.L. Kilgo Co., Inc.
180 Sand Island Road
808-832-2200
Honolulu 96819
Slim's Power Tools, Inc.
1626 Republican Street
808-841-0902
Honolulu 96817
John Grinnon Co., Inc.
345 N. Nimitz Hwy.
808-538-7333
Kahului 96732
Maui Power Tool Service
251-H2 Lalo Street
808-877-3440
Wailuku 96793
Slim's Power Tools, Inc.
864 Alua Street
808-242-7878
IDAHO
Boise 83705
Air Equipment Company
2350 South Orchard Street
208-375-1313
Boise 83706
K.C. Supply Co.
5103 Irving Street
208-375-1313
Coeur d'Alene 83814
Coeur d'Alene Tool
451 Cherry Lane & Hwy 95
208-667-1158
Idaho Falls 83403
Rossiter's Electric Motor
1501 South Capital Avenue
208-529-3665
Twin Falls 83301
Elis Repair
2380 Kimberly Road
208-734-4400
ILLINOIS
Addison (Chicago) 60101
Porter-Cable Corporation
311 Laura Drive
708-628-6100
Mt. Vernon 62864
Holz Tool Supply
1306 Salem Road
618-242-4676
North Pekin 61554
Central Tool & Equipment
Div. A & I Supply
97 Highway Blvd.
309-382-2400
Springfield 62702
James Machinery
223 N. MacArthur
212-622-9115
INDIANA
Elkhart 46516
Thunander Corporation
21861 Protecta Dr.
219-295-4131
Evansville 47710
Brown & Hubert
306 N. 7th Avenue
812-425-9049
Evansville 47711
Tri State Repair Service
1327 N. Fares
812-464-9341
607-729-5287
Fort Wayne 46808
Merrick Evans Inc.
2116 W. Coliseum Blvd.
219-482-4822
Goshen 46526
C & L Electric Motor Repair
1402 Chicago Avenue
219-533-2643
Indianapolis 46241
Macco Equip. Co., Inc.
3129 Kentucky Avenue
317-248-1444
Topeka 66571
Tools Unlimited
8035 W. 400 South
219-593-2319
IOWA
Cedar Rapids 52404
Puckett Tool & Fastener
410 1st Avenue NW
319-363-2211
Davenport 52803
Industrial Engineering Equipment
Company
1958 River Street
319-323-9721
Des Moines 50309
Puckett Electric Tools, Inc.
841 11th Street
515-244-4189
Hiawatha 52233
Jandha's Tool Center
754 N. Center Point Road
319-393-4740
KANSAS
Salina 67401
Mid Kansas Tool Repair
314 W. Cloud
913-825-6287
Wichita 67213
Richmond Electric Co.
911 Maple
316-264-2344
KENTUCKY
Lexington 40505
Kwik-Set Fasteners, Inc.
1151 Commercial Drive
606-252-7518
Louisville 40206
Bargain Supply Company
844 E. Jefferson Street
502-582-6651
Louisville 40217
Tool Repair Service
1200 Goss Avenue
502-635-6888
LOUISIANA
Alexandria 71301
John W. Ward Hardware
1743 Lee Street
318-442-7702
Baton Rouge 70806
Baton Rouge Rental Service
5101 Government Street
504-924-2959
Metairie 70011
R.J. Marchand Contr. Spec., Inc.
P.O. Box 8148
3515 Division Street
504-888-2922
New Orleans 70153-3432
Beeman Precision, Inc.
P.O. Box 53432
4206 Howard Avenue
504-886-9391
Shreveport 71101
McCiamroch Machinery
939 Louisiana Avenue
318-222-9249
MAINE
Bangor 04401
N.H. Bragg & Son
Box 927, 92 Perry Rd.
207-947-8611
Portland 04104
M and W Tool Service
38 Portland Street
207-772-2057
MARYLAND
Baltimore 21201
Porter-Cable Corporation
7397 Washington Blvd.
Suite #102
410-799-9394
Fax: 410-799-9398
Baltimore 21201
"Skarie, Inc.
707 N. Howard St.
410-728-6000
Cumberland 21502
Allegheny Motor & Pump Service
150 Winewood Street
301-777-0340
MASSACHUSETTS
Fall River 02721
Burns, Inc.
350 M.S. Bishop Blvd.
617-675-0381
Franklin 02038
Porter-Cable Corporation
101-E Constitution Blvd.
508-520-8802
Fax: 508-528-8089
Springfield 01105
Saw Center
472 Main Street
413-734-2045
MICHIGAN
Charlotte 48813
Johnson's Workbench
563 E. Cochran
517-543-2727
Gladwin 48624
"Tool Haus
630 N. Silver Leaf
517-426-4549
Grand Rapids 49504-3458
1184 Wilson Ave., N.W.
616-791-4760
Kingsford 49801
Northern Tool & Supply, Inc.
1021 Pyla Drive
906-774-3991
Petoskey 49770
Ed's Electric Appliance Service
3924 Charlevoix Rd.
616-347-9599
Southfield (Detroit) 48075
Porter-Cable Corporation
18650 W. Eight Mile Road
313-569-4333
Traverse City 49684
Davis Electric Inc.
111 Hastings Street
616-947-9660
MINNESOTA
Minneapolis 55429
Porter-Cable Corporation
4315 68th Avenue North
612-561-9080
MISSISSIPPI
Hattiesburg 39404
Mitchell Power Tool Service
2000 Byron Street
601-264-3308
Jackson 39202
Flannigan Electric Co., Inc.
1820 S. West Street Ext.
601-354-2756
MISSOURI
Joplin 64802
Electric Motor Supply Inc.
P.O. Box 1925
2301 West 20th Street
417-623-4544
North Kansas City 64116
Porter-Cable Corporation
1141 Swift Avenue
P.O. Box 12393
816-221-2070
St. Louis 63119
Porter-Cable Corporation
314-968-8950
Springfield 65802
Middle Earth Tool Repair, Inc.
306 No. National
417-831-0954
MONTANA
Billings 59101
Allen's Electric Tool Repair
431 St. John's Avenue
406-248-3865
Black Eagle 59414
Masch Electric Motors
2513 17th Street North East
406-453-2481
Bozeman 59715
"Owenhouse Hardware
36 E. Main
406-587-5401
Missoula 59801
City Electric
Electro Service Center Div.
101 S. Catlin Street
406-549-4115
Missoula 59801
Montana Tool Co.
1908 North Ave. West
406-721-6425
Whitefish 59937
Northwest Tool Repair
6466 Highway 93 South
406-862-6275
NEBRASKA
Lincoln 68504
Lincoln Tool Service Center
3535 North 40
402-464-1157
Omaha 68127
Thacker Electric
8507 I Street
402-592-9433
NAT WATS 800-678-7604
Omaha 68127
Tool Hospital
4630 So. 85 Street
492-592-5220
NEVADA
Las Vegas 89103
E & M Industrial Hardware
3725 West Russell Rd.
702-736-6102
Las Vegas 89118
All Tools Repair
5720 S. Valley View #5
702-736-6102
Las Vegas 89109
Tool Service, Inc.
3229 Industrial Road
702-734-9161
NEW HAMPSHIRE
Brentwood 03833
Brentwood Machine Sales Inc.
Building #313 - Rte #125
603-679-8452
Keene 03431
Hanshaw Lumber
3 Braddock Street
603-352-6506
Nashua 03061
Hammar Industrial
175 Amherst St.
P.O. Box 1209
603-882-5161

*IND. MACHINERY SERVICE

(continued)

AUTHORIZED SERVICE STATIONS (continued)

NEW JERSEY
Somerville 08876
Butensky Services Co.
10 County Line Road, Suite 7
908-707-0912

NEW MEXICO
Albuquerque 87107
Martin Saw and Tool
3421 Vassar N.C.
505-888-1675

NEW YORK
Albany 12206
Albany Burner Control, Inc.
20 Colvin Avenue
518-459-8856

Amherst 14226
"Phillips Bros. Supply Inc.
2525 Kensington Avenue
716-839-4800

Buffalo 14210
SS Electric Repair Shop Inc.
2470 Seneca Street
716-823-1232

Comrack 11725
"County Power Tool Service, Inc.
237 Comrack Rd.
516-499-5666

Flushing 11365
Porter-Cable Corporation
175-25 Horace Harding Expwy.
718-225-2040

Glens Falls 12801
J.E. Sawyer
64-90 Glen Street
518-793-4104

Hunter 12442
Windham Equipment
Rt. 296 & 23 C
Beaches Corners
518-263-4577

Kingston 12401
Miron Bldg. Products, Inc.
C.P.O. Box 1598
Rt. #9W North
914-336-6000

Peekskill 10566
Peekskill Electric Motor
13 South Broad St.
914-737-4141

Port Chester 10573
Pelham Tool Co.
21 Abendrough Avenue
914-937-1771

Rensselaer 12144
F. Wing
83 Sacoe Avenue
518-463-4161

Rochester 14608
Jackson Saw & Knife Co.
517 State Street
716-546-7485

Rochester 14609
O.G. Schwarz
430 Atlantic Avenue
716-482-9282

Southampton 11968
Richards Tool and Motor Repair
County Road 39 & N. Main Street
516-283-5130

Syracuse 13220
Mid-State Contractors
1811 LeMoine Avenue, Box 2189
315-455-5903

Syracuse 13210
Syracuse Industrial Sales
713 E. Fayette Street
315-478-5751

Uniondale 11553
"Enterprise Machinery Co., Inc.
825 Nassau Road
516-485-2804

Utica 13502
McQuade and Bannigan
1300 Stark Street
315-724-7119

Vestal 13850
Cascade Electric Inc.
416 Commerce Rd.
607-729-5278

Watertown 13601
McQuade & Bannigan
124 Murroch Circle
315-788-2612

NORTH CAROLINA
Burlington 27215
Fayres Power Tool
2550 S. Mebane Street
919-227-1031

Charlotte 28209
Porter-Cable Corporation
4303B South Boulevard
704-525-4410

Greensboro 27405
Tool & Equipment Supply, Inc.
807 Huffman Street
919-275-6124

Raleigh 27604
Specialty Tool Service of
Raleigh Inc.
2420 Atlantic Ave.
919-833-5903

Wilmington 28401
Coastal Power Tool and
Equipment Repair
1913 Carolina Beach Road
919-762-0777

Wilmington 28401
Knight's Industrial Tools
708 S. 17th Street
919-251-5006

Wilmington 28405
M.F. McLean Enterprises
Rt. 6, Box 97
Old Wrightsville Road
919-343-1775

Winston Salem 27106
Piedmont Power Mach. Srv. Inc.
4305J Enterprise Drive
919-759-2022

NORTH DAKOTA
Bismark 58501
Bismark Electric Motor, Inc.
1009 Basin Avenue
701-258-1267

Fargo 58103
Acme Electric Motor, Inc.
3401 Interstate Blvd.
701-235-8060

Grand Forks 58201
Acme Electric Motor, Inc.
1705 13th Avenue North
701-746-6481

Minot 58701
Acme Electric Motor, Inc.
525 20th Avenue S.E.
701-839-2263

OHIO
Barberton 44203
Viking Akron Tool & Supply Co.
2915 New Park Drive
1-800-362-0585
216-753-1063

Cincinnati 45210
Cincinnati Electric Repair
2023 Elm St.
513-621-2183

Cincinnati 45245
Pro Tool Service
747 Ohio Pike
513-753-4349

Cincinnati 45215
Pro Tool Service Inc.
1125 Glendale-Milford Road
513-772-1490

Columbus 43212
"Columbus Hardware
944 W. 5th Avenue
614-294-8665

Columbus 43214
Porter-Cable A Corporation
4560 Indiana Avenue
614-263-0929

Alpha (Dayton) 45301
Authorized Tool Service Co.
676 Orchard Lane
P.O. Box 5
513-429-5593

Hartsville 44632
Hartville True Value
940 W. Maple Street
216-877-3631

North Canton 44720
N. Canton Repair Shop
1555 No. Main
216-499-3529

Toledo 43606
Power Tool Sales & Service
2934 Douglas Road
419-473-0962

Toledo 43613
Electric Tool & Equipment
3156 Upton Avenue
419-474-7537

Valley View 44125
Porter-Cable Corporation
Sweet Valley Business Park
Unit #18
216-447-9030

West Milton 45383
Conken Equipment Co.
4950 Frederick Garland Road
513-698-3363

OKLAHOMA
Oklahoma City 73109
Steve's Wholesale
2423 S. Walker
405-631-0352

Oklahoma City 73126
Whitton Supply Co.
1419 W. Reno
405-236-5561

Tulsa 74101
Wesche Company
P.O. Box 217
2005 East 7th Place
918-583-7551

Tulsa 74115
Steve's Wholesale Dist., Inc.
5342 E. Admiral Place
918-634-0991

OREGON
Eugene 97402
Jim's Tool Service
515 Wilson Street
503-344-1243
Fax: 503-344-1513
Toll Free: 1-800-327-2033

Grants Pass 97526
Machine Masters
508 N.E. "F" Street
503-479-8876

Klamath Falls 97601
Quality Tool Repair
836 Richmond Street
503-863-5870

Jamestown 97505
Medford 97501
Precision Power Tool Repair Inc.
2919 N. Pacific Highway
503-770-5541

Portland 97202
Professional Power Tool
Repair Inc.
2506 S.E. 8th Ave.
503-234-3734

Portland 97212
Continental Machine & Tool Inc.
51 N.E. Hancock
503-288-6888

Redmond 97756
Dave's Tool Repair
2392-S S. Highway 97
503-548-0510

PENNSYLVANIA
Allentown 18103
Cuno Electric Repair
825 South 5th
215-432-9923

Bellefonte 16823
"Triangle Bldg. Supply & Services
1076 E. Bishop St.
814-355-5885

Nashville 37210
Allied Tool Repair
1005 Second Ave. S.
615-242-8026

Nashville 37210
Power Tool Service of
Nashville, Inc.
1106 Elm Hill Pike
Suite #130
615-255-8227

TEXAS
Arlene 79604
Abilene Lumber Co., Inc.
2025 Industrial Blvd.

Amarillo 79101
Tascosa Tool Service
706 S. Grant
806-373-3474

Austin 78722
Hamilton Electric Works Inc.
3800 Airport Blvd.
512-472-2428

Austin 78758-5498
The Gray Box
9906A Gray Boulevard
512-836-5483

Corpus Christi 78405
Corpus Christi Power Tool &
Repair
3701 Agnes
512-883-1117

Corpus Christi 78405
Otto Dukes Machinery Co.
2588 Morgan Street
512-883-0921

Dallas 75220
Porter-Cable Corporation
10714 N. Stemmons Freeway
214-353-2996

El Paso 79902
Schlosser Tool & Machinery
1505 Wyoming
915-544-8665

El Paso 79905
C.L. North Co.
123 Chelsea Street
914-772-1469

Fl. Worth 76110
Air & Electric Tool Co., Inc.
3301 South Grove
817-921-0231

Houston 77008
"Circle Saw Builders Supply
2510 Ella Boulevard
713-864-8444

Houston 77092
Porter-Cable Corporation
5201 Mitchelldale
Suite B-9
713-682-0334

Longview 75606
Eastex Welding
Box 3223
1232 W. Marshall
214-758-7327

Lubbock 79405
Lubbock Electric Co.
1108 34th Street
806-744-2336

Midland 79701
Midland Tool Specialty
918 S. Main Street
915-682-4647

TENNESSEE
Chattanooga 37412
F & D Tool Service and Supply
4121 Ringgold Road
615-698-6454

Clarksville 37043-5153
Triple S Industries
1511A Vista Lane
615-648-8665
615-648-9288

Jackson 38301
Smith Tool Service
908 S. Highland Avenue
901-427-4012

Jamestown 38556
Kirby's Fix-It
P.O. Box 147
120 N. Norris
615-879-7414

Knoxville 37914
Adrian Machine Tools
2900 Thom Grove Pike
615-522-9991

Knoxville 37918
Shop Equipment Service Co.
4821 N. Broadway
615-688-3574

Memphis 38106
Power Tools, Inc.
1200 S. Bellevue
901-774-1212

Memphis 38115
Bird Fasteners, Inc.
6920 Winchester Rd., #102
901-366-1748

Nashville 37210
Allied Tool Repair
1005 Second Ave. S.
615-242-8026

Nashville 37210
Power Tool Service of
Nashville, Inc.
1106 Elm Hill Pike
Suite #130
615-255-8227

UTAH
Logan 84321
Tool Liquidator
839 N. Main
801-753-4256

Salt Lake City 84115
A.C. Tool and Service, Inc.
2920 South West Temple
801-487-4953

VERMONT
S. Burlington 05403
Burlington Tool Repair
23 San Remo Drive
802-658-4131

VIRGINIA
Charlottesville 22901
Hamilton Electric Repair Service
P.O. Box 1612
1132 E. Market Street
804-293-7913

Fredericksburg 22404
Fredericksburg Hardware Co., Inc.
513 William Street
703-373-8383

Hamisburg 22801
Rocking R Hardware
1030 S. High Street
703-434-9967

Newport News 23606
National Tool Supplies
806 Middle Ground Blvd.
804-873-1115

Norfolk 23517
Bryan Electric Co., Inc.
424 West 25th Street
804-625-0378

Norfolk 23502
"Henry Walke Co.
1161 Ingle Side Road
804-855-0502

Richmond 23230
Southland Power Tool Srv.
1705 Dabney Road
804-257-7348

Roanoke 24013
Roanoke Armature Co.
1108-1/2 Street S.E.
703-345-8741

WASHINGTON
Bellevue 98005
"Eastside Saw & Sales
12880 Bal Red Road
206-454-7627

Bellingham 98225
Pro Tool of Bellingham
300 Ohio Street
206-733-7343

Port Angeles 98362
L & L Tool Specialties, Inc.
1927 East First Street
206-457-1116

Renton 98055
Porter-Cable Corporation
268 Southwest 43rd Street
206-251-6680

Spokane 99202
Spokane Power Tool
E. 801 Trent Avenue
509-489-4202

San Angelo 76903
Frank's Electric
2621 Martin Luther King
915-655-8928

San Antonio 78205
Electric Motor Service
1514 E. Commerce
512-226-3462

San Antonio 78212
"Otto Dukes Machinery
600 San Pedro
512-224-5576

Sherman 75090
Texoma Tool Repair Co.
309 E. Houston Street
214-892-1510

Texarkana 75501
Ray's Electric Motor Repair
922 Bowie Street
214-792-7031

Tyler 75702
Mason Machinery
1908 W. Erwin Street
214-592-6581

Waco 76710
Gross Yowell
3720 Franklin Drive
817-754-5425

Weslaco 78596
Weslaco Tool Co.
316 E. 4th Street
512-968-9156

Wichita Falls 76301
Hornby Heavy Hardware
615 Ohio Street
817-322-8696

UTAH
Logan 84321
Tool Liquidator
839 N. Main
801-753-4256

Salt Lake City 84115
A.C. Tool and Service, Inc.
2920 South West Temple
801-487-4953

Salt Lake City 84115
"M & M Tool and Machinery
1773 S. 300 W (Rear)
801-485-8200

WASHINGTON, D.C.
Advanced Tool & Machine Service
(ATMS)
1933 Montana Avenue, N.E.
206-636-8670

PUERTO RICO
Sierra Bayamon 00961
B & M Electric Tool Repair Center
Calle 49, Bloque 51
Casa 27 Avenue West Main
809-787-2287

CANADA
Alberta
Calgary T2H 2L7
#10 6320 11th St. S.E.
403-255-3530

British Columbia
Burnaby V5A 4T8
8520 Baxter Place
604-420-0102

Manitoba
Winnipeg R3H 0H2
1699 Dublin Avenue
204-633-9259

Ontario
Mississauga L4V 1J2
6463 Northam Drive
416-677-5330

Guelph N1H 6M7
644 Imperial Road
519-836-2840

Ottawa K2A 3X2
851 Richmond Road
613-728-1124

Quebec
St. Laurent
(Montreal) H4N 1W2
523 Rue Deslauniers
514-336-8772

Ste. Foy G1N 4L5
Suite 202
2202 Rue Lavoisier
418-681-7305



Delta Building Trades and Home Shop Machinery Two Year Limited Warranty

Delta will repair or replace, at its expense and at its option, any Delta machine, machine part, or machine accessory which in normal use has proven to be defective in workmanship or material, provided that the customer returns the product prepaid to a Delta factory service center or authorized service station with proof of purchase of the product within two years and provides Delta with reasonable opportunity to verify the alleged defect by inspection. Delta may require that electric motors be returned prepaid to a motor manufacturer's authorized station for inspection and repair or replacement. Delta will not be responsible for any asserted defect which has resulted from normal wear, misuse, abuse or repair or alteration made or specifically authorized by anyone other than an authorized Delta service facility or representative. Under no circumstances will Delta be liable for incidental or consequential damages resulting from defective products. This warranty is Delta's sole warranty and sets forth the customer's exclusive remedy, with respect to defective products; all other warranties, express or implied, whether of merchantability, fitness for purpose, or otherwise, are expressly disclaimed by Delta.

Free Manuals Download Website

<http://myh66.com>

<http://usermanuals.us>

<http://www.somanuals.com>

<http://www.4manuals.cc>

<http://www.manual-lib.com>

<http://www.404manual.com>

<http://www.luxmanual.com>

<http://aubethermostatmanual.com>

Golf course search by state

<http://golfingnear.com>

Email search by domain

<http://emailbydomain.com>

Auto manuals search

<http://auto.somanuals.com>

TV manuals search

<http://tv.somanuals.com>