

# DVP01PU-H Position Control Module

## Instruction Sheet

### Warning

- ✓ This Instruction Sheet only provides descriptions for installation, wiring and trial run. For further information, please refer to special module of PLC Application Manual.
- ✓ Do NOT touch terminals when power on. Please turn off the power before wiring.
- ✓ This is an OPEN TYPE PLC. The PLC should be kept in an enclosure away from airborne dust, humidity, electric shock risk and vibration. Also, it is equipped with protective methods such as some special tools or keys to open the enclosure, in order to prevent hazard to users or damage the PLC.
- ✓ Do NOT connect the AC input power to any of the input/output terminals, or it may damage the PLC. Check all the wiring prior to power up.

## 1 Introduction

### 1.1 Model Explanation and Peripherals

01PU (position control unit) is mainly applied to the speed/position control of step/servo driven system. The maximum output pulse can be up to 200 KPPS, and built-in various route control modes. The DVP-PLC EH series can read/write 01PU via FROM/TO instructions. There are 54 CRs(Controlled Register) in 01PU and 16 bits for each register. The 32-bits data is composed of 2 continuous CR number.

#### Nameplate

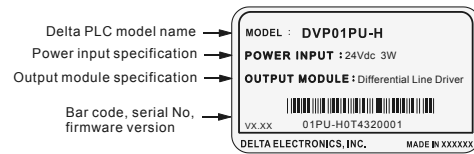

### Model & Serial Number

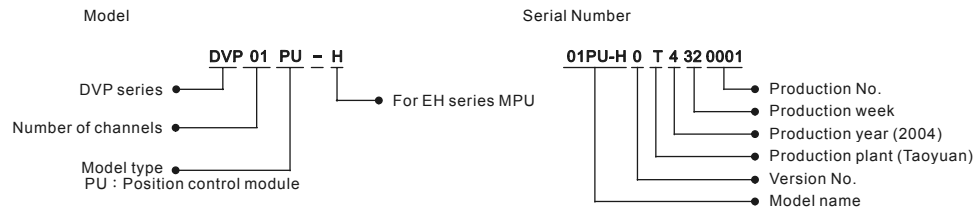

### 1.2 Product Profile and Outline (LED Indicator and Terminal Block)

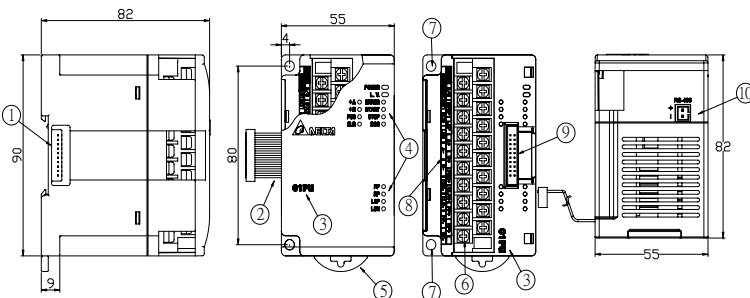

- DIN rail track (35mm)
- Mounting wire to connect extension module/extension unit
- Model name
- Status Indicator (Power, Run and ERROR)
- DIN rail clip
- Terminal
- Mounting hole
- Terminal layout
- Extension port to connect extension module/unit
- RS-485 communication port

#### LED Display

POWER : Power indicator, +5V internal power	START : Start input
LV : Low voltage indicator (lit when external input power is lower than 19.5V)	STOP : Stop input
ERROR : Error occurred indicator. It will blink when CR#44 is not 0.	DOG : DOG (near point signal) input
	FP : CW pulse output
	RP : CCW pulse output

LSP : Right limit input indicator	ΦA : A-phase input of manual pulse generator
LSN : Left limit input indicator	ΦB : B-phase input of manual pulse generator
PG0 : Zero signal input indicator	CLR : Output clear signal

#### Input/Output Terminal

Description	Terminal name	Explanation	Response character
Power supply	+24V, 0V	Power input/DC24V (-15~+20%) Current consumption 100mA	-
	START	Start input terminal	15ms/50ms
Input	STOP	Stop input terminal	15ms
	LSP / LSN	Input right/left limit	1ms
	ΦA+, ΦA-	A-phase terminal (+, -) of manual pulse generator input (line driver input)	200KHz
	ΦB+, ΦB-	B-phase terminal (+, -) of manual pulse generator input (line driver input)	200KHz
	PG0+, PG0-	Zero signal input terminal +, - (line driver input)	1ms
	DOG	Offers two different functions depending on operation mode. (1) It is near-point signal in zero return mode. (2) It is start signal on interrupt 1st or interrupt 2nd speed mode.	1ms
	S/S	Signal common terminal of these inputs (START, STOP, DOG, LSP, LSN)	-
Output	CLR+, CLR-	Clear signal (clear signal of internal error counter for Servo drive)	130ms
	FP+, FP-	FP/RP mode: CW pulse output I/O mode: Output pulse	200KHz
	RP+, RP-	FP/RP mode: CCW pulse output I/O mode: direction output	200KHz

### 1.3 Wiring

- Please wire I/O by O-type or Y-type terminals as the specification shown at left. The torque of PLC terminal screw should be 5-8 kg-cm (4.3~6.9 in-lbs).
- I/O signal wires or power supply should not run through the same multi-wire cable or conduit.
- Use copper conductors only, 60/75°C.

#### Input/Output Circuit

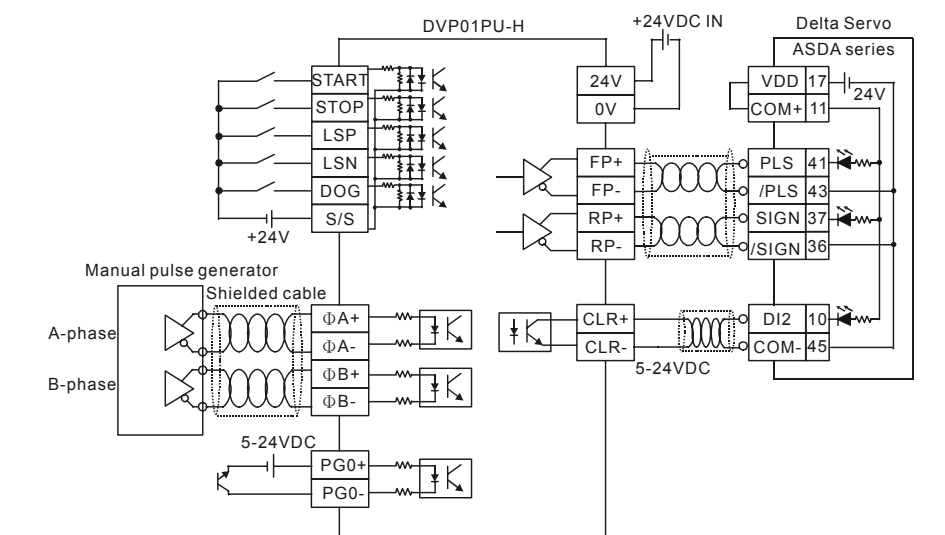

## 2 Specifications

### 2.1 Function Specifications

Item	Description
Power supply	DC24V(-15% ~ +20%), Current consumption 140±30mA Power is supplied from EH series or external power supply.
Max. number of connected axes	8 units (axes); (All I/O points are not occupied. There are 8 special extension units at most to connect to EH series.)
Distance instruction	Distance value is set by CR. 1. Setting value: -2, 147,483,648~+2,147,483,647; 2. Selectable unit: um, mdeg, 10 <sup>-4</sup> inch, Pulse; 3. Selectable rate: 10 <sup>0</sup> , 10 <sup>1</sup> , 10 <sup>2</sup> , 10 <sup>3</sup> ; 4. Selectable position: absolute and relative position instruction
Speed instruction	Speed value is set by CR. 1. Setting value: -2,147,483,648~+2,147,483,647 (conversion value of 10~200KPPS pulse); 2. Unit selectable: pulse/s, cm/min, 10deg/min, inch/min
External output	Photo coupler is for insulation and there are LED indications for all output/input signals. Outputs: FP and RP (line driver output 5V) Output: CLR is the type of NPN open collector transistor output (5~24VDC, less than 20mA)
External input	Photo coupler is for insulation and there are LED indications for all output/input signals. Input point: START, STOP, LSP, LSN, DOG(contact or open collector transistor, 24VDC±10%, 5±1mA) Inputs: ΦA, ΦB(line driver or open collector transistor, 5~24VDC, 6~15mA) Input: PG0 (line driver or open collector transistor, 5~24VDC, 6~15mA)
Pulse output format	Three selectable modes: Pulse/Dir, FP(CW)/RP(CCW), A/B (all modes are line driver output)
Position program & data transmission	The DVP-PLC EH series can read/write data in CR via FROM/TO instructions. The 32-bits data is composed of 2 continuous CR number. The range of 16-bits CR is CR#0~CR#53.

Item	Description
Connect to DVP-PLC in series	When DVP-01PU modules are connected to an MPU, the modules are numbered from 0 to 7. 0 is the closest and 7 is the farthest to the MPU. 8 modules is the max and they do not occupy any digital I/O points of the MPU.

### 2.2 Other Specification

Environmental specifications	
Operation/Storage	1. Operation: 0°C~55°C (Temperature), 50~95%(Humidity), pollution degree 2 2. Storage: -25°C~70°C (Temperature), 5~95% (Humidity)
Vibration/Shock immunity	Standard: IEC1131-2, IEC 68-2-6 (TEST Fc)/ IEC1131-2 & IEC 68-2-27 (TEST Ea)
Antistatic spec.	All places between terminals and ground comply with the spec.

## 3 Control Register

CR No.		DVP-01PU Position Control Unit		Setting Range	
HW	LW	Address	Latched	Attribute	Content
#0	H'4190	✓	R		Model No.
#2	H'4191	✓	R/W		Pulse required to rotate motor for 1 revolution (A)
#4	H'4193	✓	R/W		Machine travel range while motor rotate for 1 revolution (B)
#5	H'4195	✓	R/W		Parameter setting Factory setting: H'0000

bit #	Unit	Motor unit	Combined unit	Machine unit	Position rate setting	Pulse output format
b1 b0	Motor	um			0 0 10 <sup>0</sup>	0 0 FP + RP
0 1	Machine	m deg			0 1 10 <sup>1</sup>	0 1 Pulse + direction
1 0	Combined	10 <sup>-4</sup> inch			1 0 10 <sup>2</sup>	1 0 A/B Phase pulse
1 1		cm/min			1 1 10 <sup>3</sup>	1 1

bit #	Description
6	When b[6]=0: positive logic, LSP input signal is ON, LPS signal is given. When b[6]=1: negative logic, LSP input signal is OFF, LPS signal is given.
7	When b[7]=0: positive logic, LSN input signal is ON, LSN signal is given. When b[7]=1: negative logic, LSN input signal is OFF, LSN signal is given.
8	When b[8]=0: zero return is executed to the direction of CP's decreasing value. When b[8]=1, zero return is executed to the direction of CP's increasing value.
9	When CW running is executed: if b[9]=0, CP value is increasing. If b[9]=1, CP value is decreasing.
10	When b[10]=0: DOG rising-edge is triggered. When b[10]=1,DOG falling-edge is triggered. (Interrupt 1st and interrupt 2nd speed position modes are enabled.)
11	When b[11]=0: positive logic, DOG input signal is ON, DOG near point signal is given. When b[11]=1: negative logic, DOG input signal is OFF, DOG near point signal is given. When in zero return mode, interrupt 1st and interrupt 2nd speed position modes are enabled.
12	When b[12]=0: trapezoid acceleration line is chosen. When b[12]=1, S acceleration line is chosen.
13	When b[13]=0: 15ms; when b[13]=1: 50ms(for noise filter).
14	When b[14]=0: positive logic, START input signal is ON, START input. When b[14]=1: negative logic, START input signal is OFF, START input.
15	When b[15]=0: positive logic, STOP input signal is ON, STOP input. When b[15]=1: negative logic, STOP input signal is OFF, STOP input.

#7	#6	H'4196	✓	R/W	Maximum speed V <sub>max</sub>	Range: 0 ~ +2,147,483,647 unit*1 (10 ~ 200K PPS) *2 Factory setting: 200,000 unit*1
#9	#8	H'4198	✓	R/W	Bias speed V <sub>bias</sub>	Range: 0 ~ +2,147,483,647 unit*1 (0 ~ 200K PPS pulse transfer value) *2Factory setting: 0 unit*1
#11	#10	H'419A	✓	R/W	JOG speed V <sub>JOG</sub>	Range: 0 ~ +2,147,483,647 unit*1 (10 ~ 200K PPS pulse transfer value) *2Factory setting: 5,000 unit*1
#13	#12	H'419C	✓	R/W	Zero return speed V <sub>RT</sub>	Range: 0 ~ +2,147,483,647 unit*1 (10 ~ 200K PPS pulse transfer value) *2Factory setting: 50,000 unit*1
#15	#14	H'419E	✓	R/W	Zero return deceleration speed V <sub>CR</sub>	Range: 0 ~ +2,147,483,647 unit*1 (10 ~ 200K PPS pulse transfer value) *2, factory setting: 1,000 unit*1
#16	H'41A0	✓	R/W		The number of PG0 in zero return mode N	Range: 0~+32,767 PLS, factory setting: 0 PLS
#17	H'41A1	✓	R/W		The number of pulse in zero return mode P	Range: -32,768 ~+32,767 PLS, factory setting: 0 PLS
#18	H'41A2	✓	R/W		Zero return mode	b0: Zero return mode, b1: detect DOG falling-edge in zero return mode

bit #	Description
0	b[0]=0: normal mode, b[0]=1: override mode
1	b[1]=0: DOG falling-edge detecting is on in zero return mode. b[1]=1: DOG falling-edge detecting is off in zero return mode.

#20	#19	H41A3	✓	R/W	Zero point setting (HP)	Range: 0 ~ ±999,999 unit*1, factory setting: 0 unit*1
#21	H41A5	✓	R/W	Acceleration time T <sub>acc</sub>	Range: 10 ~ +32,767 ms, factory setting: 100 ms	
#22	H41A6	✓	R/W	Deceleration time T <sub>dec</sub>	Range: 10 ~ +32,767 ms, factory setting: 100 ms	
#24	#23	H41A7	×	R/W	Target position (I) P(I)	Range: -2,147,483,648 ~ +2,147,483,647 unit*1 (-2,147,483,648 ~ +2,147,483,647 pulse transfer value) *2, factory setting: 0 unit*1
#26	#25	H41A9	×	R/W	Running speed (I) V(I)	Range: -2,147,483,648 ~ +2,147,483,647 unit*1 (10 ~ 200K PPS pulse transfer value) *2, factory setting: 1,000 unit*1
#28	#27	H41AB	×	R/W	Target position (II)P(II)	Range: -2,147,483,648 ~ +2,147,483,647 unit*1 (-2,147,483,648 ~ +2,147,483,647 pulse transfer value) *2, factory setting: 0 unit*1
#30	#29	H41AD	×	R/W	Running speed (II) V(II)	Range: 0 ~ +2,147,483,647 unit*1 (10 ~ 200K PPS pulse transfer value) *2, factory setting: 2,000 unit*1
#31	H41AF	×	R/W	Running instruction factory setting: H'0000	b15 b14 b13 b12 b11 b10 b9 b8 b7 b6 b5 b4 b3 b2 b1 b0 CLR output (On/Off) CLR signal output mode Current position = 0 (CP=0) Software START ABS/REL Coordinate Zero return start JOG- JOG+ CCW pulse STOP CW pulse STOP Software STOP Error reset	

bit #	Description	Timing
0	When b[0]=1, Error reset. Error indicator is off and FLAG in CR (CR#43.b[5]) is cleared to 0.	0→1
1	When b[1]=0→1, this is the same function as external input signal that forces to stop. When external signal that forces to stop is inputted or when b[1]=0→1, PU will decelerate to stop.	0→1
2	When b[2]=1, CW running is forbidden, CW running instruction is disabled.	1
3	When b[3]=1, CCW running is forbidden, CCW running instruction is disabled.	1
4	When b[4]=0→1, CW pulse is generated in JOG+ mode.	1
5	When b[5]=0→1, CCW pulse is generated in JOG- mode.	1
6	When b[6]=0→1, zero return is performed. Zero return is performed differently by the different current position (CP) as the four following conditions: Position(1): Start position (as the right picture below [1]) is at the right of zero point and DOG(near point signal), DOG=Off. Position(2): Start position (as the right picture below [2]) is at the right of zero point, DOG=On. Position(3): Start position (as the right picture below [3]) is at the left of zero point and DOG(near point signal), DOG=Off and LSN (hardware limit switch) signal=Off. Position(4): Start position (as the left picture below [4]) is at the left of zero point and DOG(near point signal), DOG=Off and LSN (hardware limit switch) signal=On.	0→1

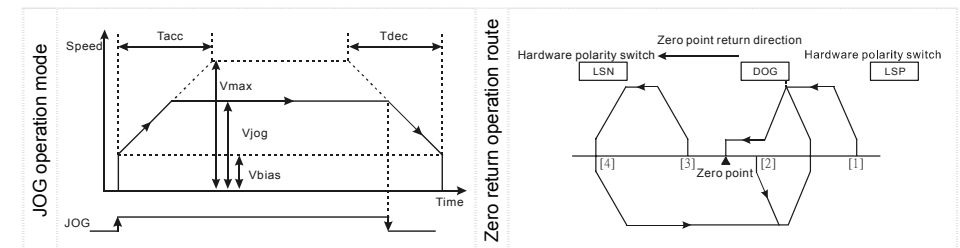

bit #	Description	Timing
7	When b[7]=0, it is absolute position. When b[7]=1, it is relative position.	0/1
8	When b[8]=0→1, start running by the work mode of CR#32.	0→1
10	When b[10]=0→1, current position (CP) is cleared to 0.	0→1
12	When b[12]=0, CLR outputs 130ms to Servo when zero return is completed. It is for the clear signal of servo internal error counter. When b[12]=1, CLR is common output point and the status(On/Off) is controlled by b[13].	0/1
13	When b[13]=0, CLR output point is Off. When b[13]=1, CLR output point is On.	0/1

#32	H41B0	×	R/W	Work mode factory setting: H'0001	b15 b14 b13 b12 b11 b10 b9 b8 b7 b6 b5 b4 b3 b2 b1 b0 Return to factory setting MASK setting LSP/LSN stop mode Manual pulse generator range setting STOP mode Manual pulse generator input operation Variable speed operation mode start Interrupt 2nd-speed position mode start 2nd-speed position mode start Interrupt 1st-speed position mode start 1st-speed position mode start
-----	-------	---	-----	-----------------------------------	---

bit #	Description
0	When b[0] is triggered and START ON, it starts to execute 1st-speed position program. Step number and speed are decided by P(I)& V(I).
1	When b[1] is triggered, START ON, and DOG external near point signal is performed, it starts to reload the value of the target position (I) P(I).

The content of this instruction sheet may be revised without prior notice. Please consult our distributors or download the most updated version at <http://www.delta.com.tw/industrialautomation>

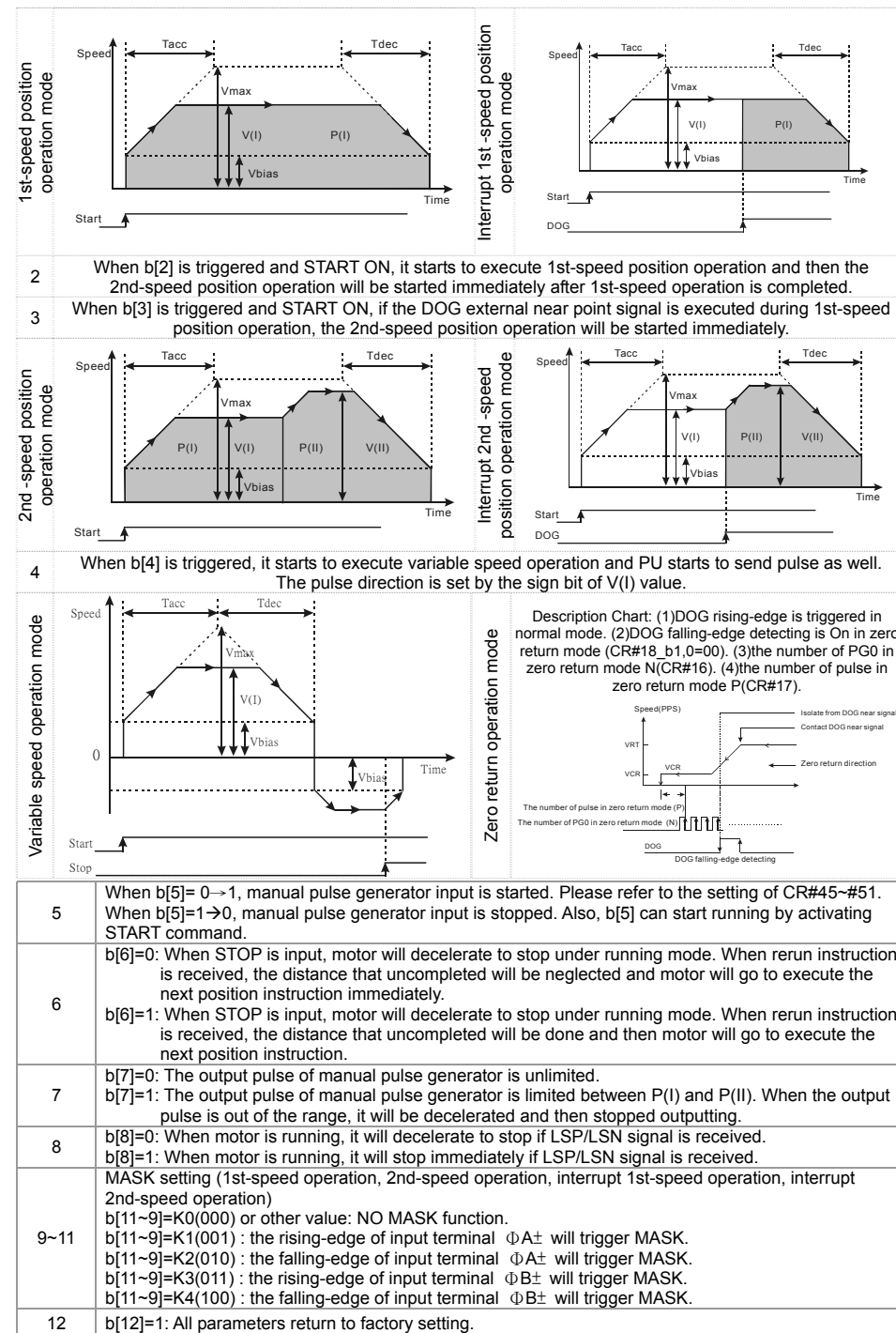

#34	#33	H41B1	×	R/W	Current position CP(PLS)	Range display: -2,147,483,648~+2,147,483,647 PLS, factory setting: 0 PLS
#36	#35	H41B3	×	R/W	Current speed CS (PPS)	Range display: 0 ~ +2,147,483,647 PPS, factory setting: 0 PPS
#38	#37	H41B5	×	R/W	Current position (unit*1)	Range display: -2,147,483,648~+2,147,483,647 unit*1, factory setting: 0 unit*1
#40	#39	H41B7	×	R/W	Current speed (unit*1)	Range display: 0 ~ +2,147,483,647 unit*1, factory setting: 0 unit*1
#41	H41B9	✓	R/W	Communication address	RS-485 communication address, range: 01~255, factory setting: K1	
#42	H41BA	✓	R/W	Baud Rate Setting	Baud rate setting: 4800, 9600, 19200bps, 38400 bps, 57600 bps, 115200 bps. ASCII mode data format is 7Bit, even bit and 1 stop bit (7 E 1). RTU mode data format is 8Bit, even bit and 1 stop bit (8, E, 1) b0: 4800 bps(bit/sec.), b1: 9600 bps(bit/sec.) (factory setting) b2: 19200 bps(bit/sec.), b3: 38400 bps(bit/sec.) b4: 57600 bps(bit/sec.), b5: 115200 bps(bit/sec.) b6~b14: reserved, b15: 0/1: RTU/ASCII mode(1: factory setting)	
#43	H41BB	×	R/W	Execution status factory setting: H'XXXX	b15 b14 b13 b12 b11 b10 b9 b8 b7 b6 b5 b4 b3 b2 b1 b0 MPG input downward MPG input upward Route paused indication Position completed indication Error occurred flag CP value overflow Zero return is done CCW pulse is outputting CW pulse is outputting Status indication	

bit #	Description
0	When b[0]=0, system is ready. When b[0]=1, PU is executing position control mode (Pulse is outputting).
1	When b[1]=1, CW pulse is outputting.
2	When b[2]=1, CCW pulse is outputting.
3	When b[3]=1, zero return is completed. b[3] is cleared to 0 by user program. When PU is power on again, b[3] will be cleared to 0 automatically.
4	When b[4]=1, "Current position CP(PLS)"(CR#34, #33), that is 32 bit, is overflow. When PU is power on again or complete zero return, b[4] will be cleared to 0 automatically.
5	When b[5]=1, PU error occurred. Error code is stored in CR#44.
6	When PU starts to execute zero return or error reset (only when error occurred), it will clear b[6] to 0. When zero return or position control is completed, it will set b[6] to 1.
7	When PU is running, STOP status is on. PU will stop output, and b[7] will be set to 1 at this time. It means that PU is pause and it will execute the uncompleted route and b[7] will be cleared to 0 after STOP status is off.
9	When b[9]=1, it means manual pulse generator inputs with counting upward.
10	When b[10]=1, it means manual pulse generator inputs with counting downward.

#44	H41BC	×	R	Error code	Please refer to "Error Code & Troubleshooting" for detail. Factory setting: H'0000
#45	H41BD	×	R/W	Electronic gearing numerator of MPG input	Please refer to the following description. Factory setting: H'1
#46	H41BE	×	R/W	Electronic gearing denominator of MPG input	Please refer to the following description. Factory setting: H'1

- Input operation of manual pulse generator:
  - Manual pulse generator input operation is ON when b5 of CR#32 is set to 1.
  - 2-phase(A phase/B phase) can be input from the manual pulse generator to ΦA and ΦB. FP/RP I/O pulse is as follows:

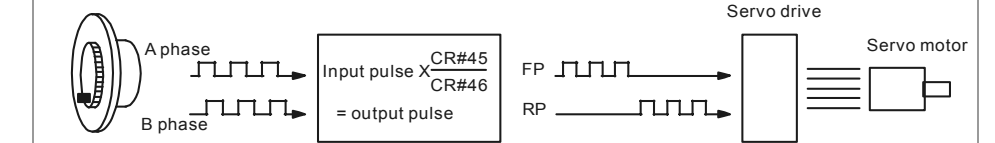

- When it arrives the (LSP/LSN) limit, output will stop immediately. When LSP is ON, CCW is allowed. When LSN is ON, CW is allowed. The position complete flag is not turned ON.
- Position complete indication (CR#43, b6=Off). When position is done, the actual operation is expressed: (CR#43 b6=On).
- The PU output pulse, pulse frequency of manual pulse generator, and the electronic gearing (CR#45, CR#46) are proportional to each other.

#48	#47	H41BF	×	R/W	Input frequency of manual pulse generator	The input frequency of manual pulse generator, factory setting: 0
#50	#49	H41C1	×	R/W	Accumulated pulse number of manual pulse generator	The count value of CW manual pulse input is "+" symbol, on the contrary, the CCW manual pulse input is "-" symbol. And the count value is nothing to do with the ratio setting of manual electronic gearing (CR#45, #46). Factory setting: 0.

Value	Response speed	Description
≥ 5	4ms (factory setting)	When response speed setting is faster, the commands of pulse output and manual pulse generator input will be more synchronous. When response speed setting is slower, the command of pulse output is slower than the command of manual pulse generator input. Factory setting: 5
4	32ms	
3	108ms	
2	256ms	
1 or 0	500ms	

bit #	Status	Description
b0	START input	When START input is On, b0 is On
b1	STOP input	When STOP input is On, b1 is On
b2	DOG input	When DOG input is On, b2 is On
b3	PG0 input	When PG0 input is On, b3 is On
b4	LSP input	When LSP input is On, b4 is On
b5	LSN input	When LSN input is On, b5 is On
b6	A phase input	When A phase input is On, b6 is On
b7	B phase input	When B phase input is On, b7 is On
b8	CLR output	When CLR output is On, b8 is On

#53	H41C5	✓	R	System version	System version: in hexadecimal system. Ex.: H'0100, the software version is V1.00.
-----	-------	---	---	----------------	--

\*1: Unit setting is according to the varying of "b0, b1" unit setting of CR#5.

\*2: Convert setting value to pulse unit: (1) output the maximum pulse if it exceeds the maximum range. (2) output the minimum pulse if it's lower than the minimum range.

## 4 Error Code & Troubleshooting

It indicates 01PU hardware malfunction or error parameter setting when error LED flashes. ERR code is recorded in CR#44.

Error code	Description	Error code	Description
H'0000	No error	H'0013	Zero return deceleration (V <sub>RT</sub> ) setting error
H'0001	Target address (I) setting error	H'0014	JOG speed (V <sub>JOG</sub> ) setting error
H'0002	Target address (II) setting error	H'0020	CCW pulse is forbidden
H'0010	Running speed (I) setting error	H'0021	CCW pulse is forbidden
H'0011	Running speed (II) setting error	H'0080	Hardware error in internal memory
H'0012	Zero return deceleration (V <sub>CR</sub> ) setting error	H'0081	Data write in error in internal memory

## Free Manuals Download Website

<http://myh66.com>

<http://usermanuals.us>

<http://www.somanuals.com>

<http://www.4manuals.cc>

<http://www.manual-lib.com>

<http://www.404manual.com>

<http://www.luxmanual.com>

<http://aubethermostatmanual.com>

Golf course search by state

<http://golfingnear.com>

Email search by domain

<http://emailbydomain.com>

Auto manuals search

<http://auto.somanuals.com>

TV manuals search

<http://tv.somanuals.com>