

DENON

CD RECORDER

DN-C550R

OPERATING INSTRUCTIONS

MODE D'EMPLOI

INSTRUCCIONES DE OPERACION

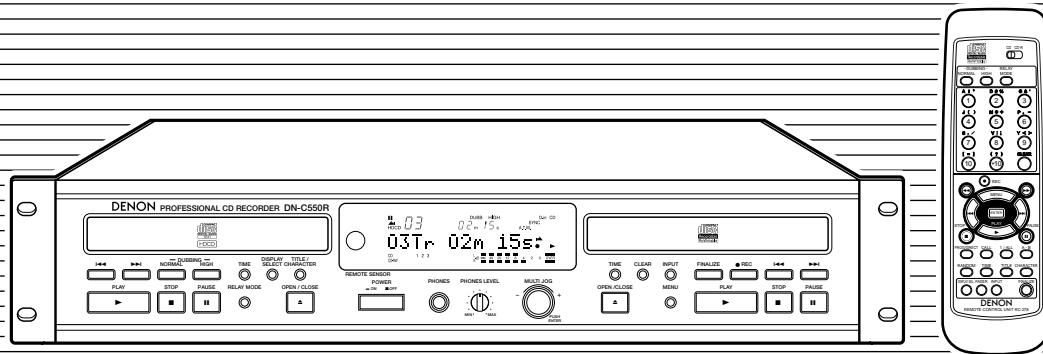

FOR ENGLISH READERS PAGE 5 ~ PAGE 35
POUR LES LECTEURS FRANCAIS PAGE 36 ~ PAGE 66
PARA LECTORES DE ESPAÑOL PAGINA 67 ~ PAGINA 97



CAUTION
RISK OF ELECTRIC SHOCK
DO NOT OPEN



CAUTION: TO REDUCE THE RISK OF ELECTRIC SHOCK, DO NOT REMOVE COVER (OR BACK). NO USER SERVICEABLE PARTS INSIDE. REFER SERVICING TO QUALIFIED SERVICE PERSONNEL.



The lightning flash with arrowhead symbol, within an equilateral triangle, is intended to alert the user to the presence of uninsulated "dangerous voltage" within the product's enclosure that may be of sufficient magnitude to constitute a risk of electric shock to persons.



The exclamation point within an equilateral triangle is intended to alert the user to the presence of important operating and maintenance (servicing) instructions in the literature accompanying the appliance.

WARNING: TO REDUCE THE RISK OF FIRE OR ELECTRIC SHOCK, DO NOT EXPOSE THIS APPLIANCE TO RAIN OR MOISTURE.

LABELS (for U.S.A. model only)

CERTIFICATION

THIS PRODUCT COMPLIES WITH DHHS RULES 21 CFR SUBCHAPTER J APPLICABLE AT DATE OF MANUFACTURE.

CAUTION:

USE OF CONTROLS OR ADJUSTMENTS OR PERFORMANCE OF PROCEDURES OTHER THAN THOSE SPECIFIED HEREIN MAY RESULT IN HAZARDOUS RADIATION EXPOSURE.

THE COMPACT DISC PLAYER SHOULD NOT BE ADJUSTED OR REPAIRED BY ANYONE EXCEPT PROPERLY QUALIFIED SERVICE PERSONNEL.

This device complies with Part 15 of the FCC Rules. Operation is subject to the following two conditions : (1) This device may not cause harmful interference, and (2) this device must accept any interference received, including interference that may cause undesired operation.

This Class B digital apparatus meets all requirements of the Canadian Interference-Causing Equipment Regulations.

Cet appareil numérique de la classe B respecte toutes les exigences du Règlement sur le matériel brouilleur du Canada.

• **FOR CANADA MODEL ONLY**

CAUTION

TO PREVENT ELECTRIC SHOCK, MATCH WIDE BLADE OF PLUG TO WIDE SLOT, FULLY INSERT.

• **POUR LES MODELES CANADIENS UNIQUEMENT**

ATTENTION

POUR ÉVITER LES CHOCS ÉLECTRIQUES, INTRODUIRE LA LAME LA PLUS LARGE DE LA FICHE DANS LA BORNE CORRESPONDANTE DE LA PRISE ET POUSSER JUSQU' AU FOND.

SAFETY INSTRUCTIONS

1. Read Instructions – All the safety and operating instructions should be read before the appliance is operated.
2. Retain Instructions – The safety and operating instructions should be retained for future reference.
3. Heed Warning – All warnings on the appliance and in the operating instructions should be adhered to.
4. Following Instructions – All operating and use instructions should be followed.
5. Water and Moisture – The appliance should not be used near water – for example, near a bathtub, washbowl, kitchen sink, laundry tub, in a wet basement, or near a swimming pool, and the like.
6. Carts and Stands – The appliance should be used only with a cart or stand that is recommended by the manufacturer.
- 6A. An appliance and cart combination should be moved with care. Quick stops, excessive force, and uneven surfaces may cause the appliance and cart combination to overturn.
7. Wall or Ceiling Mounting – The appliance should be mounted to a wall or ceiling only as recommended by the manufacturer.
8. Ventilation – The appliance should be situated so that its location or position does not interfere with its proper ventilation. For example, the appliance should not be situated on a bed, sofa, rug, or similar surface that may block the ventilation openings; or, placed in a built-in installation, such as a bookcase or cabinet that may impede the flow of air through the ventilation openings.
9. Heat – The appliance should be situated away from heat sources such as radiators, heat registers, stoves, or other appliances (including amplifiers) that produce heat.
10. Power Sources – The appliance should be connected to a power supply only of the type described in the operating instructions or as marked on the appliance.
11. Grounding or Polarization – Precautions should be taken so that the grounding or polarization means of an appliance is not defeated.
12. Power-Cord Protection – Power-supply cords should be routed so that they are not likely to be walked on or pinched by items placed upon or against them, paying particular attention to cords at plugs, convenience receptacles, and the point where they exit from the appliance.
14. Cleaning – The appliance should be cleaned only as recommended by the manufacturer.
15. Power Lines – An outdoor antenna should be located away from power lines.
16. Outdoor Antenna Grounding – If an outside antenna is connected to the receiver, be sure the antenna system is grounded so as to provide some protection against voltage surges and built-up static charges. Article 810 of the National Electrical Code, ANSI/NFPA 70, provides information with regard to proper grounding of the mast and supporting structure, grounding of the lead-in wire to an antenna-discharge unit, size of grounding conductors, location of antenna-discharge unit, connection to grounding electrodes, and requirements for the grounding electrode. See Figure A.
17. Nonuse Periods – The power cord of the appliance should be unplugged from the outlet when left unused for a long period of time.
18. Object and Liquid Entry – Care should be taken so that objects do not fall and liquids are not spilled into the enclosure through openings.
19. Damage Requiring Service – The appliance should be serviced by qualified service personnel when:
 - A. The power-supply cord or the plug has been damaged; or
 - B. Objects have fallen, or liquid has been spilled into the appliance; or
 - C. The appliance has been exposed to rain; or
 - D. The appliance does not appear to operate normally or exhibits a marked change in performance; or
 - E. The appliance has been dropped, or the enclosure damaged.
20. Servicing – The user should not attempt to service the appliance beyond that described in the operating instructions. All other servicing should be referred to qualified service personnel.

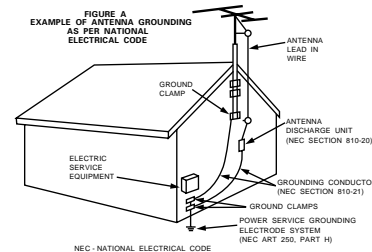

FRONT PANEL
PANNEAU AVANT
PANEL FRONTAL

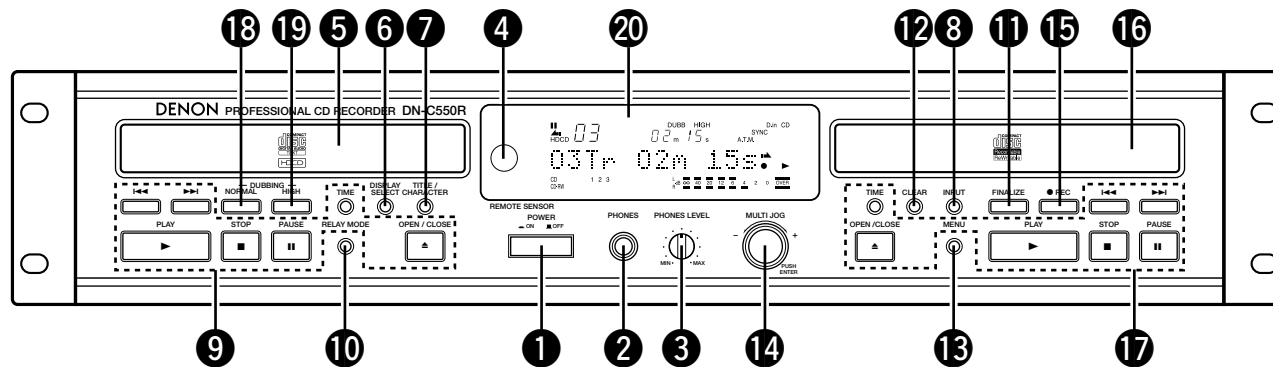



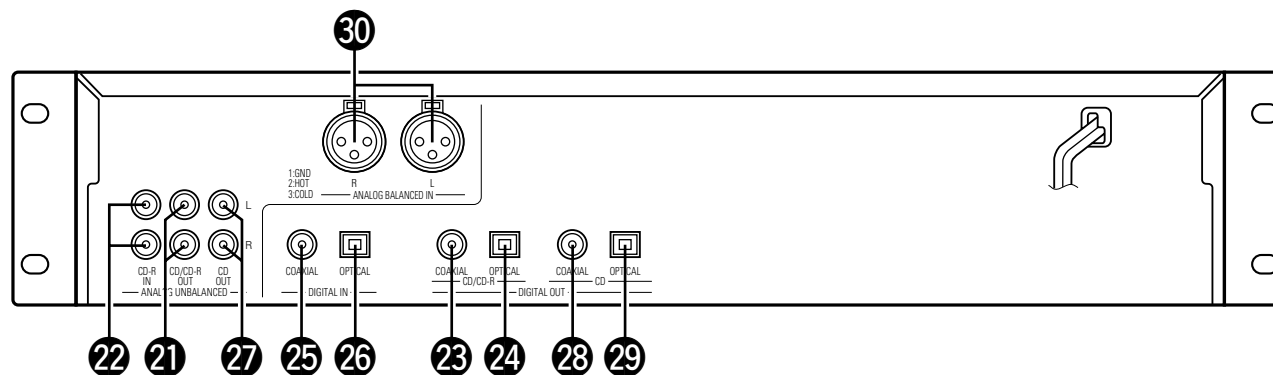



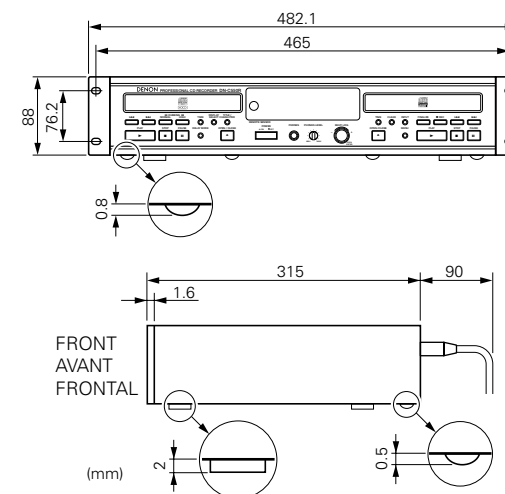
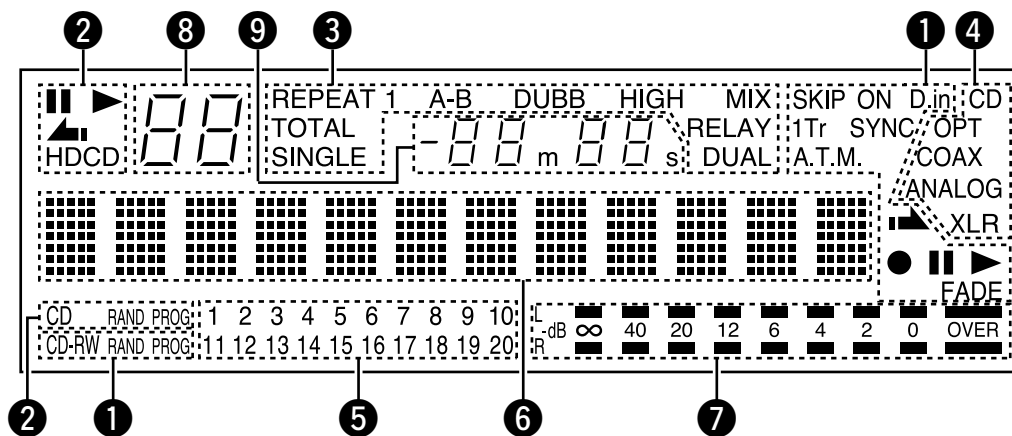

REAR PANEL
PANNEAU ARRIERE
PANEL TRASERO

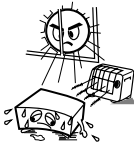

DISPLAY
AFFICHAGE
VISUALIZADOR



NOTE ON USE / OBSERVATIONS RELATIVES A L'UTILISATION / NOTAS SOBRE EL USO

 <ul style="list-style-type: none"> • Avoid high temperatures. Allow for sufficient heat dispersion when installed on a rack. • Éviter des températures élevées. Tenir compte d'une dispersion de chaleur suffisante lors de l'installation sur une étagère. • Evite altas temperaturas. Permite la suficiente dispersión del calor cuando está instalado en la consola. 	 <ul style="list-style-type: none"> • Keep the set free from moisture, water, and dust. • Protéger l'appareil contre l'humidité, l'eau et la poussière. • Mantenga el equipo libre de humedad, agua y polvo. 	 <ul style="list-style-type: none"> • Do not let foreign objects in the set. • Ne pas laisser des objets étrangers dans l'appareil. • No deje objetos extraños dentro del equipo.
 <ul style="list-style-type: none"> • Handle the power cord carefully. Hold the plug when unplugging the cord. • Manipuler le cordon d'alimentation avec précaution. Tenir la prise lors du débranchement du cordon. • Maneje el cordón de energía con cuidado. Sostenga el enchufe cuando desconecte el cordón de energía. 	 <ul style="list-style-type: none"> • Unplug the power cord when not using the set for long periods of time. • Débrancher le cordon d'alimentation lorsque l'appareil n'est pas utilisé pendant de longues périodes. • Desconecte el cordón de energía cuando no utilice el equipo por mucho tiempo. 	 <ul style="list-style-type: none"> • Do not let insecticides, benzene, and thinner come in contact with the set. • Ne pas mettre en contact des insecticides, du benzène et un diluant avec l'appareil. • No permita el contacto de insecticidas, gasolina y diluyentes con el equipo.
<ul style="list-style-type: none"> • Never disassemble or modify the set in any way. • Ne jamais démonter ou modifier l'appareil d'une manière ou d'une autre. • Nunca desarme o modifique el equipo de ninguna manera. 	 <p>* (For sets with ventilation holes)</p> <ul style="list-style-type: none"> • Do not obstruct the ventilation holes. • Ne pas obstruer les trous d'aération. • No obstruya los orificios de ventilación. 	

Installing the Units

Mount the units onto your console or rack with 19" EIA rack rails.

CAUTION:

This DN-C550R will work normally when the player unit is mounted with the front panel within 10 degrees of the vertical plane. If the unit is tilted excessively, discs may not load or unload properly.

Installation du lecteur

Monter ce lecteur sur votre console ou meuble à l'aide des rails de 19" EIA.

ATTENTION:

Le DN-C550R fonctionne normalement lorsque le lecteur de CD est monté avec le panneau avant faisant un angle de 10 degrés par rapport au plan vertical. Si le lecteur est trop incliné, les disques risquent de ne pas être chargés correctement.

Instalación de la unidad

Monte la unidad sobre su mesa de mezclas o en el rack con entradas de rack EIA de 19 pulgadas.

PRECAUCIÓN:

DN-C550R funciona con normalidad cuando la unidad reproductora se monta con el panel frontal dentro de los 10 grados del plano vertical. Si la unidad es inclinada excesivamente, puede ocurrir que los discos no se carguen o descarguen correctamente en la unidad.

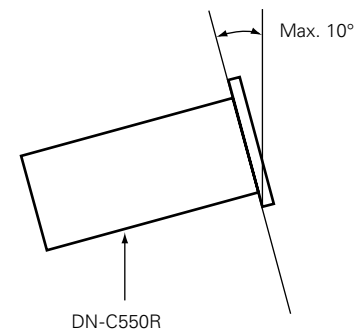

IMPORTANT TO SAFETY

WARNING:
TO PREVENT FIRE OR SHOCK HAZARD, DO NOT EXPOSE THIS APPLIANCE TO RAIN OR MOISTURE.

CAUTION:

1. Handle the power supply cord carefully

Do not damage or deform the power supply cord. If it is damaged or deformed, it may cause electric shock or malfunction when used. When removing from wall outlet, be sure to remove by holding the plug attachment and not by pulling the cord.

2. Do not open the top cover

In order to prevent electric shock, do not open the top cover. If problems occur, contact your DENON DEALER.

3. Do not place anything inside

Do not place metal objects or spill liquid inside the CD recorder. Electric shock or malfunction may result.

Please, record and retain the Model name and serial number of your set shown on the rating label.

Model No. DN-C550R Serial No. _____

Thank you for purchasing this DENON CD recorder. Please read the operating instructions thoroughly in order to acquaint yourself with the CD recorder and achieve maximum satisfaction from it.

Be sure to keep this manual for future reference, should any questions or problems arise.

Please check to make sure the following items are included with the main unit in the carton:

- (1) Main unit1
- (2) Remote control unit RC-2781
- (3) R6P/AA Dry cell battery2
- (4) Connection cord2
- (5) Operating instructions.....1
- (6) Service station list1

TABLE OF CONTENTS

- 1** FEATURES5
- 2** CAUTIONS DURING USE5
- 3** ABOUT CD-R/RW DISCS5, 6
- 4** DISC HANDLING AND PRECAUTIONS6, 7
- 5** RESTRICTIONS RELATED TO THE CD-R/RW STANDARDS7
- 6** PART NAMES AND FUNCTIONS.....7, 8
- 7** REMOTE CONTROL UNIT9, 10
- 8** SETUP METHOD10 ~ 13
- 9** COPYING PROCEDURE13 ~ 15
- 10** RECORDING FROM EXTERNAL DEVICES15 ~ 19
- 11** NORMAL PLAYBACK19
- 12** VARIOUS PLAYBACK FUNCTIONS.....20 ~ 24
- 13** RELAY MODE.....24 ~ 27
- 14** FINALIZING CD-R/RW DISC27
- 15** EDITING28 ~ 33
- 16** MENU MODE33
- 17** MESSAGES.....34
- 18** TROUBLESHOOTING35
- 19** MAIN SPECIFICATIONS35

NOTE:

This CD recorder uses the semiconductor laser. To allow you to enjoy music at a stable operation, it is recommended to use this in a room of 10 °C (50 °F) ~ 30 °C (86 °F).

• Place of installation

To ensure sufficient ventilation, leave a space of at least 10 cm between the front, sides and back of the unit and walls or other objects which may obstruct ventilation.

1 FEATURES

1. Various copying functions

- This set is equipped with a number of convenient copying modes: "Disc dubbing" for copying entire discs, "Make CD dubbing" for copying an entire disc then automatically finalizing, "1-track dubbing" for copying single tracks, and "Scan record dubbing" for selecting the tracks you want to record while scanning CDs and copying the selected tracks.
- One of two copying speeds can be selected: normal speed and double speed.

2. Recording from external devices

- This set is equipped with three convenient synchronized recording functions: "Disc synchro recording" for recording an album on the source side, "Make CD recording" for automatically finalizing after synchronized recording of a disc, and "Track synchro recording" for recording track at a time. It is also possible to record manually.

3. An abundance of playback functions

- Thanks to the combination of the CD and CD-R units, this set is equipped with three different play modes: "Relay play" for relay playback between the disc in the CD unit and the disc in the CD-R unit, "Mix play" for programmed or random playback of the disc in the CD unit and the disc in the CD-R unit as if they were a single disc, and "Dual play" with which the CD and CD-R units can be operated independently.
- This set is equipped with the programmed play, random play, and all-track, 1-track and A-B repeat play modes.

4. Rich Variety of Digital Input Jacks

- In addition to two analog input jacks, this unit is equipped with a total of two digital input jacks. There is one optical digital input jack for use with digital sources such as CD, MD and satellite broadcasts, and there is one digital coaxial input jack.

5. Equipped with Sampling Rate Converter

- This converter permits direct digital input recording from DAT or satellite broadcasts (32 kHz, 48 kHz) which have sampling frequencies that differ from that of the 44.1 kHz used with CD.

6. Text Entry and Display Function

- The album title and the track title for individual tracks can be entered and displayed for recorded CD-R/RW discs.

7. Equipped with , HDCD® (High Definition Compatible Digital®) decoder (CD unit)

, HDCD®, High Definition Compatible Digital® and Microsoft Corporation™ are either registered trademarks or trademarks of Microsoft Corporation in the United States and/or other countries. HDCD system manufactured under license from Microsoft Corporation. This product is covered by one or more of the following: In the USA: Patents 5,479,168, 5,638,074, 5,640,161, 5,808,574, 5,838,274, 5,854,600, 5,864,311, 5,872,531, and in Australia: Patent 669114, and in Europe: Patent 586586. Other patents pending.

2 CAUTIONS DURING USE

- During track selection, during search and when the recorder sustains a strong impact, the disc's rotational speed changes greatly, causing a small noise to be emitted. This is not a malfunction of the recorder.
- If the CD recorder is operated while an FM or AM broadcast is being received, there may be noise in the FM or AM reception. Please switch the power to the CD recorder off at such times.
- The DN-C550R has a broad dynamic range. Please exercise caution when turning up the volume on the amplifier in cases when the playback volume is low. If the volume is turned up too high, it could damage the speakers.
- Placing this recorder or its connection cords near a TV or other audio device could cause a humming sound to be emitted. If this occurs, relocate the recorder or reroute the connection cords.
- Be sure to remove the disc from the recorder before moving it. The disc could be damaged if left in the recorder while it is being moved.
- Do not place any object in the tray in the position where the disc is loaded, or open and close the tray with anything inside. Foreign objects in the tray could damage the play mechanism.
- Do not move the recorder from a cold place to a warm place suddenly. If the recorder is cold when brought into a warm room, condensation could form, preventing proper operation of the recorder. If condensation does form on the recorder when it is brought into a warm room, wait at least 30 minutes before use.

CD Discs

This unit uses CDs (optical digital audio discs) which bear the mark located at the right. Note that specially shaped CDs, for example, heart shaped or hexagonal cannot be played. Do not attempt to use such CDs since doing so may cause breakdown of this unit.



CD Text Discs

This unit can display text information on the display when playing CD text discs which contain text information in English category. The CD text disc includes the mark shown at the right.



NOTE:

- This unit can provide a text display of the following types of characters. Other types of characters will result in " _ " being displayed.
 - Alphabet
 ABCDEFGHIJKLMNOPQRSTUVWXYZ
 abcdefghijklmnopqrstuvwxyz
 - Numbers
 0123456789
 - Symbols
 ! " # \$ % & ' () * + , - . / : ; < = > ? @ [\] ^ _ ` { | } ~ SPACE

3 ABOUT CD-R/RW DISCS

Discs that Can Be Used with this Unit

CD-R Discs and CD-RW Discs

Be sure to use discs that bear either of the following marks when recording with this unit.



For non-professionals or non-professional purposes

* Recording will not be possible with discs that do not bear the aforementioned marks.

Methods of Recording to Disc

- **CD-R Discs**
 - CD-R discs incorporate a pigment layer for recording. When exposed to the recording laser, a change in form occurs at the boundary of this layer and the plastic layer resulting in the recording of the signal. The recorded information is maintained until the end of the life of the disc.
 - After recording, finalized discs can be played on ordinary CD players.
- **CD-RW Discs**
 - CD-RW discs incorporate a phase change layer. The recording process causes this layer to change from a crystal (reflective) condition to an amorphous (non-crystal) condition.
 - Recorded information can be erased from CD-RW discs. Deletion can take the form of deleting all of the disc tracks or only the specified tracks working back from the last track of the disc.
 - Finalized CD-RW discs can be played on CD players designed for use with CD-RW discs as well as on CD recorders.

Digital Copies (SCMS)

A CD-R/RW disc onto which has been recorded using the digital input cannot be further digitally recorded (i.e., copied) onto a separate CD-R/RW disc or MD, etc.. This is a standard established by the SCMS (Serial Copy Management System).

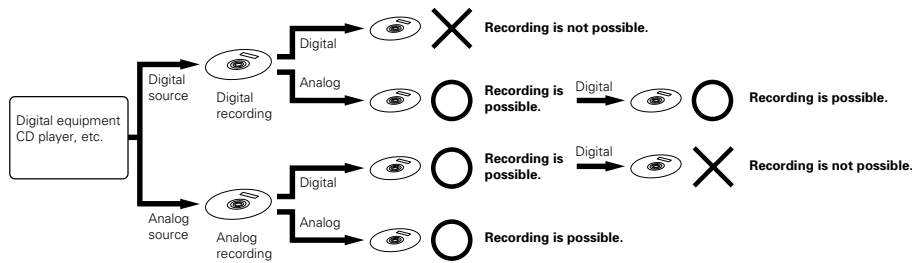

★ Recording is possible without reception of the copy defect restriction. (See "Copy management" on page 13.)

Track Numbers: Auto Track Function

★ Recording in the Synchro-recording mode (e.g., disc Synchro-recording, track Synchro-recording, and auto finalization recording) results in the track numbers being automatically associated. The manner in which the track numbers are associated will differ as follows for digital recording and for analog recording depending on the conditions.

Recording from a digital input

- When performing digital recording of a CD, track numbers are updated when the first sound is detected after the track switches.
- When making a digital recording from a MD, a track number that is the same as the original track number will automatically be associated.
- When recording from a DAT, track numbers are given when track switching is detected using the start IDs.
- When recording from a satellite broadcasts or other digital equipment, the detection of a blank portion of about 3 seconds or longer, the same as when making recordings with an analog input, will result in the operation of the auto track function and the automatic association of the track number.
- The track number might not switch correctly when there is a lot of noise in the blank portion between tracks.
- The track number might change when the signal level is very low within the track.

• CD digital (Internal/External)

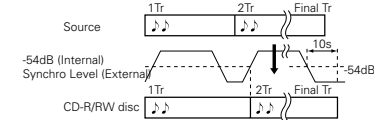

• MD digital (External), DAT digital (External)

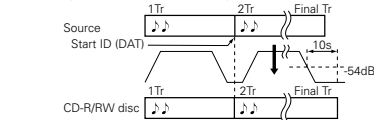

• BS/CS digital (External), Analog (External)

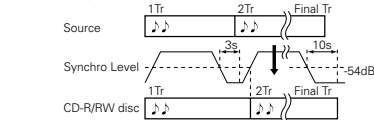

Recording from an analog input

- Track numbers will automatically be associated when a blank portion of about 3 seconds or longer is detected.
- When the input signal is affected by noise or there is some other interference, the track number might not change at the correct position.
- The track number might change when the signal level is very low within the track.

* The on/off setting of the auto track function is possible in manual recording. (See "Setting of the Auto Track Mark" on Page 11.)

NOTES:

- When recording an analog source that contains a very low level signal within the track, or a digital source other than CD/MD/DAT, switch off the auto track function then make a manual recording and associate the track numbers manually.
- When the recording level is set too low while recording an analog source or a digital source other than CD/MD/DAT, the track numbers might not be associated at the correct position. Please set a suitable recording level.

Finalization Processing of CD-R Discs

After the recording of a CD-R disc is completed, finalization processing is required to enable it to be played on an ordinary CD player.

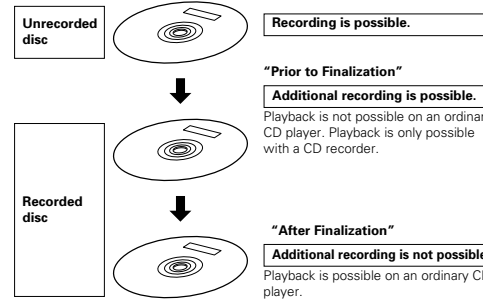

NOTES:

- Once a CD-R disc has been finalized, additional recording will no longer be possible.
- The information that has been recorded to a CD-R disc cannot be erased.

Finalization Processing of CD-RW Discs

CD-RW discs cannot be played on an ordinary CD player, even with finalization processing. Playback is possible only on CD recorders or players suited for use with CD-RW discs. They can only be played on a player that is suited for use with CD-RW discs. Also note that CD-RW discs can be erased after being finalized.

4 DISC HANDLING AND PRECAUTIONS

Disc Handling

Avoid touching the surface of the disc when inserting or removing it.

Be careful not to get fingerprints on the signal recording surface.



Disc Cleaning

- When the disc has become marked with fingerprints or dirt, wipe it clean before use. The dirt will not affect the signal of the disc, but the sound quality may drop and there may be breaks in the sound. Note that when the surface of a CD-R/RW disc is dirty, it may not record properly.
- To wipe the disc clean, use one of the disc cleaning sets available on the market or a soft cloth.

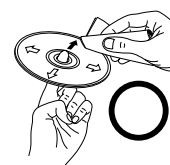

Lightly wipe in the direction from centre to outside.

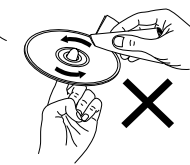

Do not wipe in a circular manner.

NOTES:

- Do not attach commercially available disc labels or other seals on the disc. Doing so may make it impossible to record or play the disc properly.

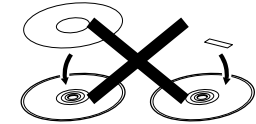

- Do not use record spray or static electricity prevention products. Do not use benzene, thinner, or other volatile chemicals.



Handling Precautions

- Do not allow fingerprints, oil, or dirt to adhere.
- Be careful not to scratch the surface, especially when removing or returning the disc to the case.
- Do not bend the disc.
- Do not heat the disc.
- Do not enlarge the center hole.
- Do not write on the label surface (i.e., printed side) with a ballpoint pen or pencil.
- Water droplets may form on the surface of the disc when it is suddenly brought from a cold place such as outdoors to a warm place. If this happens, do not dry the disc with a hair dryer.

Storage Precautions

- Be sure to eject the disc after playing.
- Always return the disc to its case to avoid dust, scratches, and misshaping.
- Do not leave the disc in the following places:
 1. Where it will be exposed to direct sunlight for long periods.
 2. Where there is a lot of dampness and dust.
 3. Where it will be exposed to heat such as from a heater.

Precautions When Loading Discs

- Only load one disc. Loading two or more discs in a layer will cause breakdown and may also scratch the discs.
- Discs of the 8 cm size should be carefully aligned with the recessed disc guide area and loaded without the use of an adapter. If not properly loaded, the disc may fall out or the disc holder may cease to open.
- Be careful not to get your finger caught when the disc holder is closing.
- Do not place anything other than a disc on the disc tray.
- Do not use discs that are cracked, misshapen, or have been repaired with an adhesive, etc.
- Do not use discs that have adhesive coming out from cellophane tape or the label of a rental disc, or adhesive remaining after removal of the label. Use of a disc in this condition may result in the disc not being ejected or in breakdown.

5 RESTRICTIONS RELATED TO THE CD-R/RW STANDARDS

★ Standards concerned with CD recorder playback have been established based on the existing standards of CD players; however, for recording, the method differs from that used with existing cassette decks and MD recorders, etc. In view of this, please gain a good understanding of the following restrictions associated with CD-R/RW discs and enjoy the medium.

Restrictions of CD-R/RW Discs

- CD-R discs can be recorded to only once. The recorded information cannot be erased.
- The recorded information of CD-RW discs can be erased.
- Recording mistakes made with CD-R discs cannot be erased; therefore, it is recommended that a CD-RW disc be used until you are accustomed to the recording operation.

Restrictions in Recording with this Unit

- The recording operation procedure is the same for CD-R discs and CD-RW discs.
- When making additional recording to a previously recorded disc, the end of the last track is detected and recording is started from there.
- The record standby mode cannot be set for CD-R/RW discs with less than about 8 seconds of recordable time remaining. If you attempt to do so, "Disc Full" is displayed.
- Songs with a recording time of less than 4 seconds cannot be recorded.
- A maximum of 99 tracks can be recorded to one CD-R/RW disc. If you attempt to record a 100th track, "Disc Full" is displayed, the track number cannot be changed and recording is not possible.
- It is not possible to conduct digital input recording from digitally recorded CD-R/RW discs, MDs or DATs if "SCMS ENA." is set at "Copy management" in the setup mode. In this case, either switch to analog input recording or set "SCMS INH." in the setup mode.
- This unit cannot record CD-ROM and other non-audio signal sources. When an attempt is made to record from such sources, "Copy Prohibit" is displayed.
- When a recording is made from a disc that includes data other than audio signals such as CD graphics, only the audio signal is recorded; other data is not recorded.
- DVD (Dolby Digital, DTS, and other compressed audio signals) cannot be recorded.

Compatibility with Other CD Players and Discs

- Finalization processing on a CD-R disc that has been recorded with this unit will permit that disc to be played on ordinary CD player. (See "Finalizing CD-R/RW Disc" on Page 27.)
- Finalization processing on a CD-RW disc that has been recorded with this unit will permit that disc to be played only on a CD player designed to be used with CD-RW discs or on another CD recorder. (See "Finalization Processing of CD-RW Discs" on Page 6.)

NOTES:

- To assure accurate recording, record with an ambient temperature of 30 °C or less.
- Do not obstruct the ventilation holes on the top.
- Recording may stop if the unit is subject to shocks during recording. If recording stops, it may no longer be possible to use the disc normally.

6 PART NAMES AND FUNCTIONS

Front Panel

- 1 Power button (POWER)**
 - Turns the CD recorder ON and OFF.
- 2 Phones jack (PHONES)**
 - Jack for headphones.
- 3 Phones level control (PHONES LEVEL)**
 - Adjust the headphone volume.
- 4 Remote control sensor (REMOTE SENSOR)**
 - Receives signals from the remote control.
- 5 Disc tray (CD)**
 - Store-bought CDs and finalized CD-R/RW discs can be played.
- 6 Display select button (DISPLAY SELECT)**
 - The display switches each time the button is pressed.

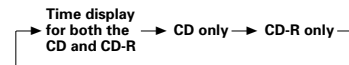

- 7 Title/Character button (TITLE/CHARACTER)**
 - When pressed while the display mode is set to CD or CD-R, the text information is displayed.
 - When text is being input, the characters change.
- 8 Input button (INPUT)**
 - Selects input source.
 - Switching will be as follows each time the button is pressed.

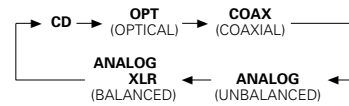

* Switching is not permitted during recording.

- 9 CD unit operating buttons**
 - ▶ : Use this to start playback.
 - : Use this to stop playback.
 - ⏸ : Use this to pause playback.
 - ⏮, ⏭ : Use this to move to the beginning of tracks.
 - ▲ : Use this to open and close the disc holder.
 - TIME : Use this to switch between the elapsed time, remaining track time and total remaining time.

- 10 Relay mode button (RELAY MODE)**
 - The mode switches each time the button is pressed.

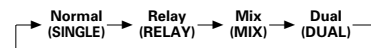

- 11 Finalize button (FINALIZE)**
 - Press this button to finalize.
- 12 Clear button (CLEAR)**
 - Use this to delete programmed tracks or text input characters.
 - When pressed in the menu mode, the set returns to the previous mode.

- 13 Menu button (MENU)**

- This button is used when inputting disc and track titles and for such editing operations as CD-RW Disc erasing.

- 14 Multi Jog dial (MULTI JOG)**

- Recording level control (Recording).
- Selects settings (Menu mode).

- 15 Record button (● REC)**

- Press this button to record.
- The recording standby mode is set when the record button (● REC) is pressed alone.
- Press the play button (▶ PLAY) while in the recording standby mode to start recording.
- To stop recording or to cancel the recording standby mode, press the stop button (■ STOP).

- 16 Disc tray (CD-R)**

- 17 CD-R operating buttons**

- ▶ : Use this to start playback or recording.
- : Use this to stop playback or recording.
- ⏸ : Use this to pause playback or recording.
- ⏮, ⏭ : Use this to move to the beginning of tracks.
- ▲ : Use this to open and close the disc holder.
- * If the text information input operation has performed but not finalized, the disc holder cannot be opened until all the test information has been deleted. (See Page 10.)

TIME : During playback, use this to switch between the elapsed time, remaining track time and total remaining time. During recording, use this to switch between the elapsed time per track and the total remaining recording time.

- 18 Normal speed copy mode button (DUBBING NORMAL)**

- The copy dubbing mode switches each time this button is pressed.

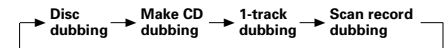

- 19 Double-speed copy mode button (DUBBING HIGH)**

- The double-speed dubbing mode switches each time this button is pressed.

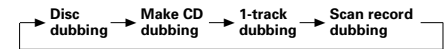

- 20 Display**

- Information screen.

Rear Panel

- 21 **Analog CD/CD-R output (UNBALANCED) jacks (ANALOG OUT CD/CD-R)**
 - These are unbalanced outputs using RCA type jacks.
 - Connects to the unbalanced analog input of an amplifier (left and right).
 - In the dual mode, only the CD-R side sound is output.
- 22 **Analog input (UNBALANCED) jacks (ANALOG IN CD-R)**
 - These are unbalanced inputs using RCA type jacks.
 - Connects to the unbalanced analog output of an amplifier (left and right).
- 23 **Digital CD/CD-R output jack (DIGITAL OUT CD/CD-R COAXIAL)**
 - Connects to the digital coaxial input of e.g. amplifier or recording device.
 - In the dual mode, only the CD-R side digital data is output.
- 24 **Digital CD/CD-R output jack (DIGITAL OUT CD/CD-R OPTICAL)**
 - Connects to the digital optical input of e.g. amplifier or recording device.
 - In the dual mode, only the CD-R side digital data is output.
- 25 **Digital input jack (DIGITAL IN COAXIAL)**
 - Connects to the digital coaxial output of an external digital sources.
- 26 **Digital input jack (DIGITAL IN OPTICAL)**
 - Connects to the digital optical output of an external digital source.
- 27 **Analog CD-only output (UNBALANCED) jacks (ANALOG OUT CD)**
 - In all modes, only the CD side sound is output.
- 28 **Digital CD-only output jack (DIGITAL OUT COAXIAL)**
 - In all modes, only the CD side digital data is output.
- 29 **Digital CD-only output jack (DIGITAL OUT OPTICAL)**
 - In all modes, only the CD side digital data is output.
- 30 **Analog input (BALANCED) jacks (ANALOG IN CD-R)**
 - These are active balanced inputs using XLR type connectors.
 - Connects to the balanced analog output of an amplifier (left and right).

Pin layout: 1. GND 2. HOT 3. COLD

Display indications

- 1 **Mode display (CD-R)**
 - **CD:**
CD (a pre-recorded CD or finalized CD-R or CD-RW disc) is loaded.
 - **CD-R:**
An unfinalized CD-R disc is loaded.
 - **CD-RW:**
An unfinalized CD-RW disc is loaded.
 - **●:**
Lights during recording.
 - **▶:**
Lights during play/recording.
 - **II:**
Pause function active.
 - **PROG:**
Lights in program mode.
 - **1 Tr, SYNC:**
Synchronized recording active.
 - **RAND:**
Plays tracks in random order.
 - **A.T.M.:**
Auto track mark indicator.
 - **D.in:**
This indicator lights when one of the digital inputs (digital) is selected.
If this flashes after performing the recording operation, check the connections of the digital input jacks.
 - **FADE:**
This flashes during the fade-in and fade-out recording operation.
 - **▶▲:**
This lights when the CD-R unit's time is displayed.
 - **SKIP:**
This lights when a track is set to be skipped.
 - **ON:**
This lights when the skip play mode is turned on.
- 2 **Mode display (CD)**
 - **CD:**
This lights when a disc is loaded.
 - **RAND:**
Random indicator.
 - **PROG:**
Program indicator.
 - **II:**
Pause indicator.
 - **▶:**
Play indicator.
 - **▶▲:**
This lights when the CD unit's time is displayed.
 - **HD CD:**
This lights when playing discs recorded in HD CD format.
- 3 **Shared mode displays**
 - **REPEAT, 1:**
Lights up when a track/complete disc (or program) is repeated.
* Off when both the CD and CD-R units' times are displayed.
 - **REPEAT A-B:**
This lights when in the A-B repeat play mode.
* Off when both the CD and CD-R units' times are displayed.

- **SINGLE, TOTAL:**
Time mode indicator.
* Off when both the CD and CD-R units' times are displayed.
- **DUBB:**
This lights when in the normal speed dubbing mode.
- **DUBB HIGH:**
This lights when in the double-speed dubbing (copying) mode.
- **MIX:**
This lights when in the mixed (CD and CD-R units) mode.
- **RELAY:**
This lights when in the relay play mode between the CD and CD-R units.
- **DUAL:**
This lights when in the CD and CD-R unit dual mode.

4 **Input source display**

- Each press of the input switching button (INPUT) causes the indicators to light as described below.

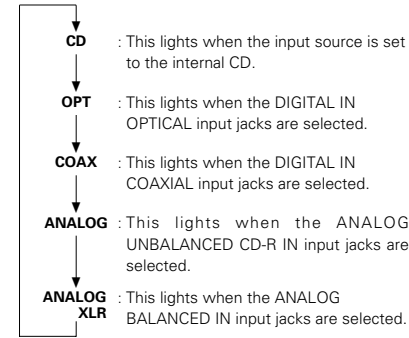

- 5 **Music calendar display**
 - Tracks on a disc or in a program.
 - Track in play/recording.
 - * Off when both the CD and CD-R times are displayed.
- 6 **Multiple display**
 - This display indicates the number of tracks, track number, play time, recording time, various operational information, text messages, etc.
 - When both the CD and CD-R times are displayed, the CD-R time is displayed.
- 7 **Level meter**
 - Record level bar, indicates the audio signal level.
 - When the CD-R unit is set to the recording mode, the input level is displayed.
- 8 **Track No. display**
 - When there is text information, the track number is displayed.
 - When both the CD and CD-R times are displayed, the CD track number is displayed.
- 9 **Time display**
 - When there is text information, the time is displayed.
 - When both the CD and CD-R times are displayed, the CD time is displayed.

7 REMOTE CONTROL UNIT

■ The included remote control unit (RC-278) can be used to operate the DN-C550R from a distance.

Inserting the batteries

① Remove the remote control unit's back lid.

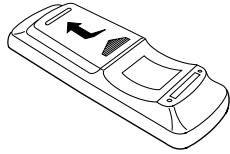

② Insert the two R6P (AA) batteries in the battery compartment, in the direction indicated by the marks inside the compartment.

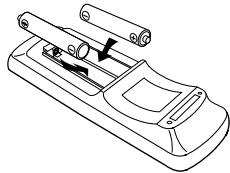

③ Put the back lid back on.

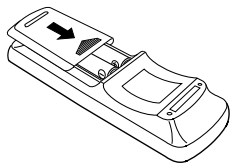

Cautions on batteries

- Use R6P (AA) batteries in the remote control unit.
- The batteries should be replaced with new ones after approximately one year, though this depends on the frequency with which the remote control unit is used.
- Even if the batteries are less than a year old, replace them with new ones if the remote control unit no longer operates even from a short distance from the main unit.
- The included battery is only for verifying operation. Replace it with a new battery as soon as possible.
- When inserting new batteries, wait about two minutes after removing the old batteries before inserting the new ones.
- Be sure to set the batteries in the proper "⊕" and "⊖" directions, as indicated by the marks in the remote control unit's battery compartment.
- Remove the batteries when not using the remote control unit for long periods of time.
- To avoid explosions and fluid leakage:
 - Do not use one new battery with one old one.
 - Do not use two different types of batteries.
 - Do not short-circuit, disassemble, heat or dispose of batteries in flames.
- If the battery fluid should leak, wipe all the fluid off the battery compartment, then insert new batteries.

Using the remote control unit

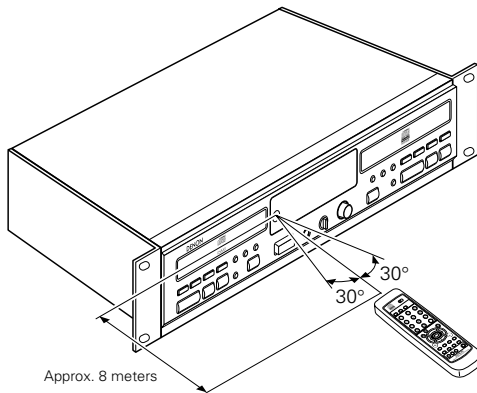

- When operating the remote control unit, point it at the main unit as shown in the diagram.
- The remote control unit can be operated from a direct distance of approximately 8 meters from the main unit. This distance will be shortened, however, if there are obstacles or when operated from an angle. (The remote control unit will operate from a horizontal angle of up to about 30°.)

NOTES:

- The remote control unit may not operate if the remote sensor is exposed to direct sunlight or strong artificial light, or if there is an obstacle between it and the remote sensor.
- Do not press buttons on the main unit and on the remote control unit at the same time. Doing so will result in malfunction.

Names and Functions of Remote Control Unit Buttons

- Buttons not explained here function in the same way as the corresponding buttons on the main unit.
- Buttons marked "*" function regardless of the function selector switch.

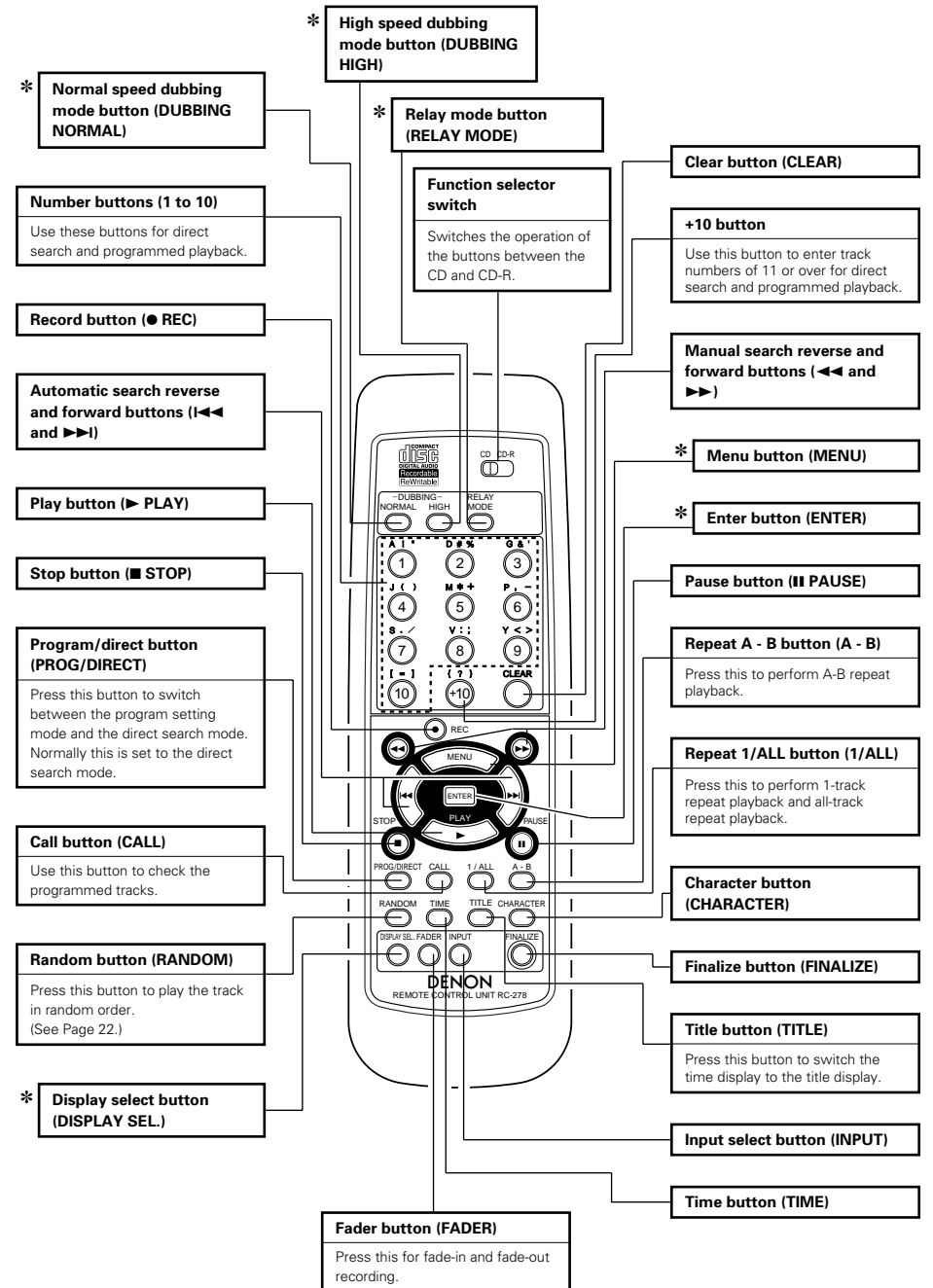

■ Inserting Disc

- ① Press the OPEN/CLOSE button (▲) to open the disc tray.
- ② Insert a disc in the appropriate recess in the tray, label side up.
- ③ Press the OPEN/CLOSE button (▲) to close the tray.
 - "Close" lights up, followed by "TOC Reading" and the display will show the type of disc you inserted.
 - If you insert a blank or partly-recorded CD-R or unfinalized CD-RW, the CD recorder will calibrate the disc for optimum recording. During this process the display will first show "Now OPC" and then the number of audio tracks. Calibration can take up to 60 seconds. (CD-R/RW)
 - If a CD-R/RW is finalized it will show "CD" on the display.

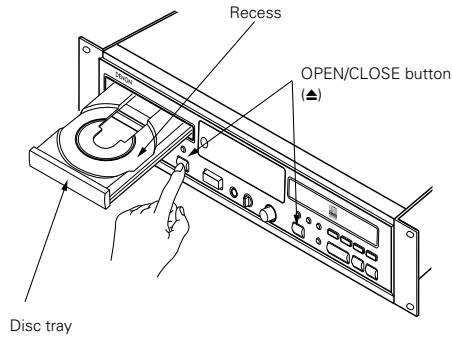

NOTES:

- If your finger should get caught in the disc tray when it closes, press the OPEN/CLOSE button (▲).
- For recording it is important that the blank disc is completely free from dust particles or scratches. See "Disc cleaning" on Page 6.
- When text information is entered but not finalized, the disc holder will not open until all of the text information has been deleted. "Text Erase OK?" will be displayed for 2 seconds. When the enter button is pressed during this interval, the text information will be deleted and the disc holder can be opened.

8 SETUP METHOD

- ★ The 10 items listed below can be set with the setup menu. The following messages will be displayed for the various setting items.
- Close the disc trays and set the stop mode for both the CD and CD-R sections.
- The contents of the set menu are stored, but this data might be lost if the unit is disconnected from the power source for 2 to 3 days.

- ① "Sync. Rec?"..... Synchro recording mode.
- ② "Sync. Level?"..... Synchro recording level.
- ③ "A.T. Mark?"..... Auto track mark.
- ④ "FadeIn Time?"..... Fade-in recording time.
- ⑤ "FadeOutTime?"..... Fade-out recording time.
- ⑥ "Intro Time?"..... Scan recording intro time.
- ⑦ "Custom Index"..... Custom index.
- ⑧ "Skip Play?"..... Skip play.
- ⑨ "Timer Play?"..... Timer playback.
- ⑩ "SCMS Set?"..... Copy management.

(1) Setup Method

(Main unit)

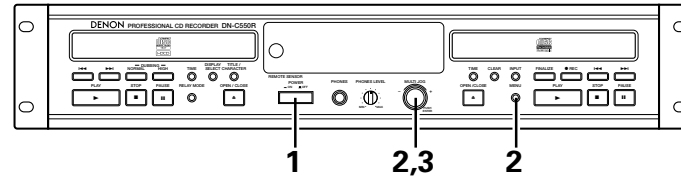

(Remote control unit)

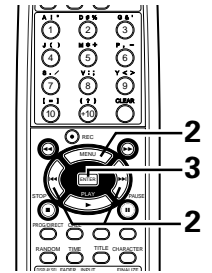

1	Switch on the power.
2	Press the menu button and turn the jog dial on the main unit or use the automatic search buttons on the remote control unit to display "Setup Menu?".
3	Press the enter button and enter the setup mode.

(2) Setting the Synchro Recording Mode

★ Perform the synchro recording mode settings. (See Page 18.)

(Main unit)

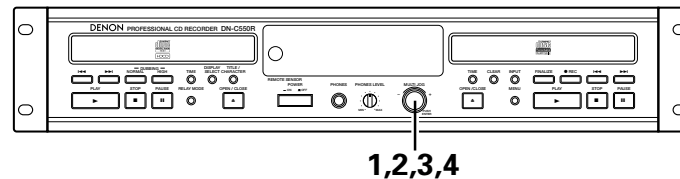

(Remote control unit)

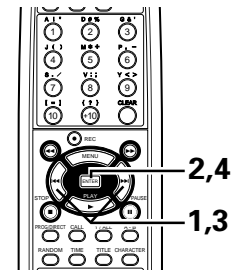

1	Set the unit to the setup mode, then turn the jog dial of the main unit or press the automatic search button of the remote control to display "Sync. Rec?".
2	Press the enter button and set the synchro recording selection mode.
3	Turn the jog dial of the main unit or press the automatic search button of the remote control, then select the synchro recording mode. "Sync. Off?". "Disc Sync.?". "Make CD?". "1Tr Sync.?".
4	Press the enter button and set the synchro recording mode. "Synchro Off". "Disc Synchro". "Make CD". "1Tr Synchro".

(3) Setting the Synchro Recording Level

- ★ This sets the synchro recording start level when synchro recording is used. (See Page 18.)
- ★ When using synchro recording, recording will start when the level of the input signal exceeds a set value. Recording will stop when the signal continues to be at level that is lower than the set value for 10 seconds or longer.

(Main unit)

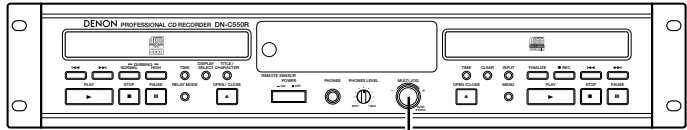

(Remote control unit)

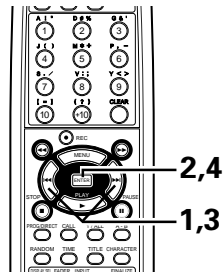

1	Set the unit to the setup mode, then turn the jog dial of the main unit or press the automatic search button of the remote control to display "Sync. Level?".
2	Press the enter button and set the synchro recording selection mode.
3	Turn the jog dial of the main unit or press the automatic search button of the remote control, then set the synchro recording level. <ul style="list-style-type: none"> • The setup value is displayed in the multiple display area. "Sync. -**dB" * The setting range is from -54 dB to -30 dB, variable in 6 dB steps.
4	Press the enter button and set the synchro recording level. <ul style="list-style-type: none"> • "Complete" will be displayed.

(4) Setting of the Auto Track Mark (ATM)

- ★ Refer to page 6 for a description of the Auto Track function.

(Main unit)

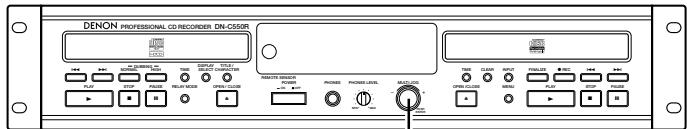

(Remote control unit)

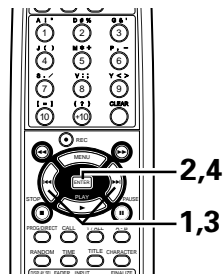

1	Set the unit to the setup mode, then turn the jog dial of the main unit or press the automatic search button of the remote control to display "A. T. Mark?".
2	Press the enter button and set the auto track mark selection mode.
3	Turn the jog dial of the main unit or press the automatic search button of the remote control to select auto track mark on or off. <ul style="list-style-type: none"> • The selected mode indication will flash. "On/Off"
4	Press the enter button and set the auto track mark on or off. <ul style="list-style-type: none"> • "A. T. Mark On" or "A. T. Mark Off" will be displayed.

(5) Fade-in time setting

- ★ To perform fade-in recording, set the fade-in time. (See Page 19.)

(Main unit)

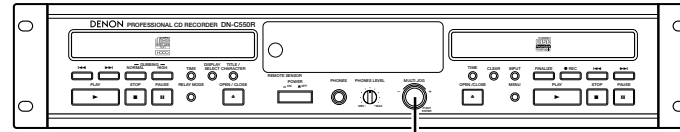

(Remote control unit)

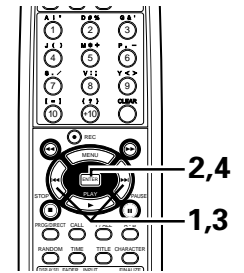

1	Set the unit to the setup mode, then turn the jog dial of the main unit or press the automatic search button of the remote control to display "FadeIn Time?".
2	Press the enter button to set the fade-in time setting mode.
3	Turn the jog dial on the main unit or use the automatic search buttons on the remote control unit to set the fade-in time. <ul style="list-style-type: none"> • The setting is displayed on the multi-display section. "FadeIn **sec" * The setting can be set between 1 and 15 seconds in steps of 1 second.
4	Press the enter button to set the fade-in recording time. <ul style="list-style-type: none"> • "Complete" will be displayed.

(6) Fade-out time setting

- ★ To perform fade-out recording, set the fade-out time. (See Page 19.)

(Main unit)

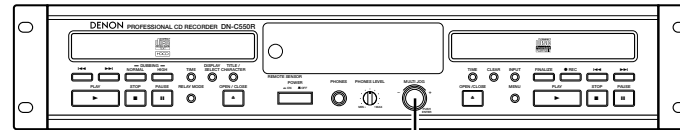

(Remote control unit)

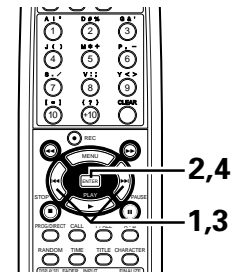

1	Set the unit to the setup mode, then turn the jog dial of the main unit or press the automatic search button of the remote control to display "FadeOutTime?".
2	Press the enter button to set the fade-out time setting mode.
3	Turn the jog dial on the main unit or use the automatic search buttons on the remote control unit to set the fade-out time. <ul style="list-style-type: none"> • The setting is displayed on the multi-display section. "FadeOut**sec" * The setting can be set between 1 and 15 seconds in steps of 1 second.
4	Press the enter button to set the fade-out recording time. <ul style="list-style-type: none"> • "Complete" will be displayed.

(7) Setting of the intro play time for scan recording

★ To perform scan recording, set the intro scan play time.
(See Page 15.)

(Main unit)

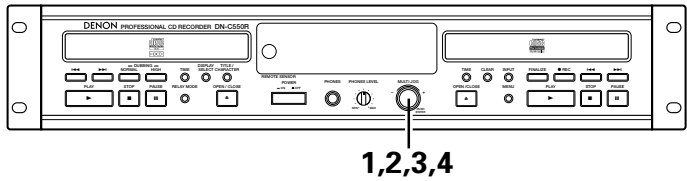

(Remote control unit)

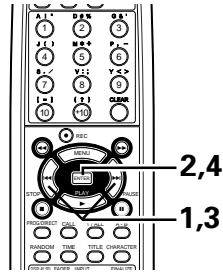

1	Set the unit to the setup mode, then turn the jog dial of the main unit or press the automatic search button of the remote control to display "Intro Time?".
2	Press the enter button to set the intro scan play time setting mode.
3	Turn the jog dial on the main unit or use the automatic search buttons on the remote control unit to set the intro scan play time. <ul style="list-style-type: none"> The setting is displayed on the multi-display section. "ScanTime **s" * The setting can be set between 5 and 30 seconds in steps of 5 seconds.
4	Press the enter button to set the intro scan play time. <ul style="list-style-type: none"> "Complete" will be displayed.

(8) Setting of the Custom Index

★ A desired name can be associated with the input jacks.
★ This is convenient for checking which equipment is connected with the input jacks.

(Main unit)

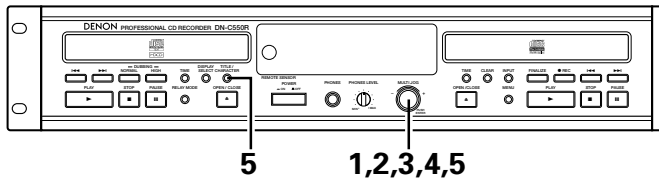

(Remote control unit)

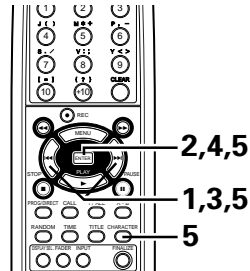

1	Set the unit to the setup mode, then turn the jog dial of the main unit or press the automatic search button of the remote control to display "Custom Index".
2	Press the enter button and set the custom index entry mode.
3	Turn the jog dial of the main unit or press the automatic search button of the remote control to select the jacks for which a name will be associated. <ul style="list-style-type: none"> The selected jacks indication will flash. "Of/Co/An/XLR"
4	Press the enter button and set the jacks for which a name will be associated. This will set the name entry mode.
5	Select the entry mode with the character button, then turn the jog dial of the main unit or press the automatic search button of the remote control to select the characters. Enter one character at a time with the enter button. <ul style="list-style-type: none"> See "Text editings" on Page 30, 31 for details of the character entry method, then perform operations 7 and 8.

(9) Setting the Skip Play Mode

★ This allows playback that skips over tracks to which you do not want to listen.
(See "Registration of the tracks to which you do not wish to listen" on Page 29 for information on the setting of such tracks.)

(Main unit)

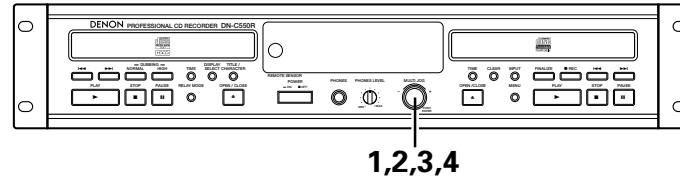

(Remote control unit)

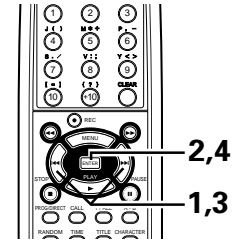

1	Set the unit to the setup mode, then turn the jog dial of the main unit or press the automatic search button of the remote control to display "Skip Play?".
2	Press the enter button and set the skip play selection mode.
3	Turn the jog dial of the main unit or press the automatic search button of the remote control to select skip play on or off. <ul style="list-style-type: none"> The selected mode indication will flash. "On/Off"
4	Press the enter button and set the skip play to on or off. <ul style="list-style-type: none"> "S.Play On" or "S.Play Off" will be displayed.

NOTES:

- Finalizing the disc when tracks to which you do not want to listen have been registered, results in the skip play mode automatically being switched on.
- Skip play is not possible on CD players that lack a skip play function.
- Program play and random play are not possible when there has been registration of tracks to which you do not want to listen.

(10) Timer play mode setting

★ Timer playback is possible. (See Page 24.)

(Main unit)

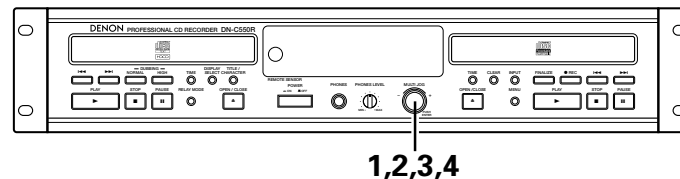

(Remote control unit)

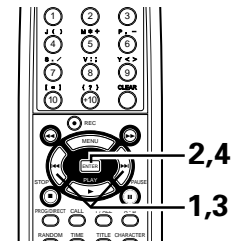

1	Set the unit to the setup mode, then turn the jog dial of the main unit or press the automatic search button of the remote control to display "Timer Play?".
2	Press the enter button and set the timer play selection mode.
3	Turn the jog dial on the main unit or use the automatic search buttons on the remote control unit to turn the timer play mode on or off. <ul style="list-style-type: none"> The selected mode indication will flash. "On/Off"
4	Press the enter button to set the timer play mode on or off. <ul style="list-style-type: none"> "TimerPlayOn" or "TimerPlayOff" will be displayed.

(11) Copy management

★ Serial copy management on/off selection. (See page 6 for a description of SCMS.)

(Main unit)

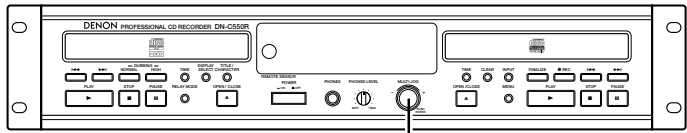

(Remote control unit)

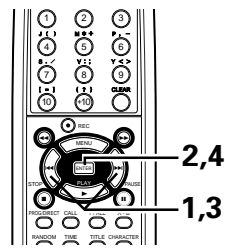

- | | |
|----------|---|
| 1 | Set the unit to the setup mode, then turn the jog dial of the main unit or press the automatic search button of the remote control to display "SCMS Set?". |
| 2 | Press the enter button and set the copy management. |
| 3 | Turn the jog dial on the main unit or use the automatic search buttons on the remote control unit to turn the copy management. <ul style="list-style-type: none"> The selected mode indication will flash. "ENA./INH." |
| 4 | Press the enter button to set the copy management. <ul style="list-style-type: none"> "SCMS ENA." or "SCMS INH." will be displayed. |

NOTES:

- SCMS INH: Digital recording is possible without this restriction even if the recording source contains a copy prohibit code, but in this case the copy prohibit code is written on the recorded disc. In addition, a copy prohibit code is written on the recorded disc even if the recording source does not have a copy prohibit code.
- SCMC ENA: In keeping with SCMS, digital recording is not possible if the recording source contains a copy prohibit code.

9 COPYING PROCEDURE

About copying

- ★ Copying can be performed easily from the set's CD unit onto the CD-R unit.
- ★ There are two copying speeds (normal and high) and four copying modes.
 - The mode switches as described below each time the normal speed copying button (NORMAL) or the high speed copying button (HIGH) is pressed.

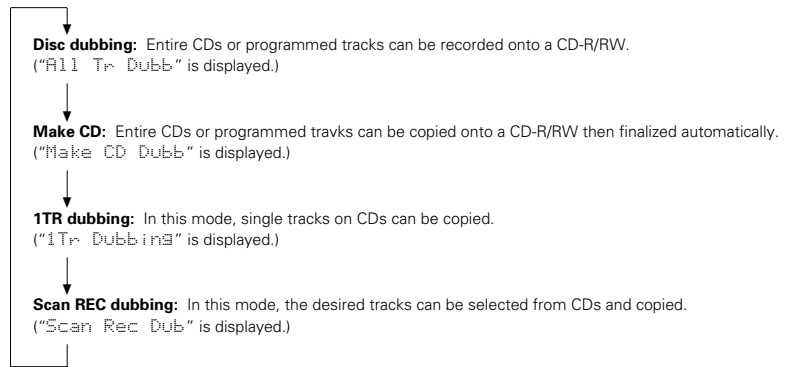

- The recording level is automatically set to the default value (0.0 dB).
- The repeat and random play modes are canceled when the copy mode is set.
- During normal speed copying you can listen to the sound as you copy.
- During high speed copying no sound is produced.
- No signals are output from the digital outputs during high speed copying.
- During copying, buttons other than the CD or CD-R stop buttons do not function.
- When CD TEXT compatible CDs are copied, the disc names and track names are also copied.
- ★ When copying, switch the relay mode to the normal or dual mode. Copying is not possible in the relay or mix mode.

Relay mode	Relay	Mix	Dual	Normal
Copying	X	X	○	○

- ★ For optimum recording, make sure there are no fingerprints, scratches or dust on the signal surface of the source side CD or the CD-R/W.
- ★ The auto track function is always activated in the copying mode. It is not possible to assign track numbers manually. (See page 6.)

• Digital dubbing

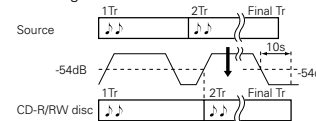

• Analog signal dubbing

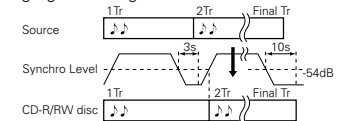

NOTES:

- Digital copying may not be possible due to SCMS restrictions if "SCMS ENA" is set at "Copy management" in the setup mode. In this case, copying is automatically performed at normal speed and using analog signals. (See page 6.)
- Analog signal copying is always performed in the normal speed mode.
- If when the copying mode is set the recordable time on the CD-R/W is shorter than the time of the CD source you are trying to copy, "CD-R Short" is displayed and both the CD and CD-R units are set to the stop mode. If this happens, check the disc's recordable time. (However, when recording track numbers 21 or higher from a source CD containing over 20 tracks, "CD-R Short" may not be displayed even if the source time you want to record is longer than the recordable time on the CD-R/W.)
- If the disc name has already been input on the disc on which you are recording, only the track names are copied.
- For some CDs, the text cannot be copied because of copyright protection. In this case "Text Protect" is displayed.
- Do not turn off the power or unplug the power cord while "How FM Rec" is displayed after recording is completed. Doing so may render the disc unusable.

(1) Copying entire discs

★ If the program modes are set for the CD unit beforehand, copying is performed accordingly.

(Main unit)

(Remote control unit)

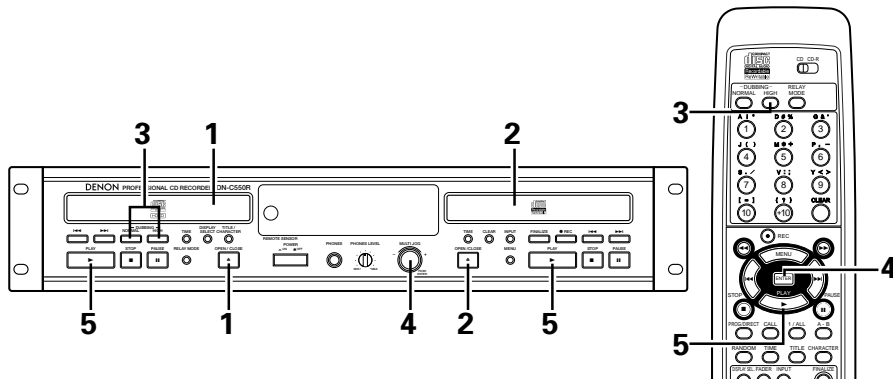

(2) Copying one track at a time

(Main unit)

(Remote control unit)

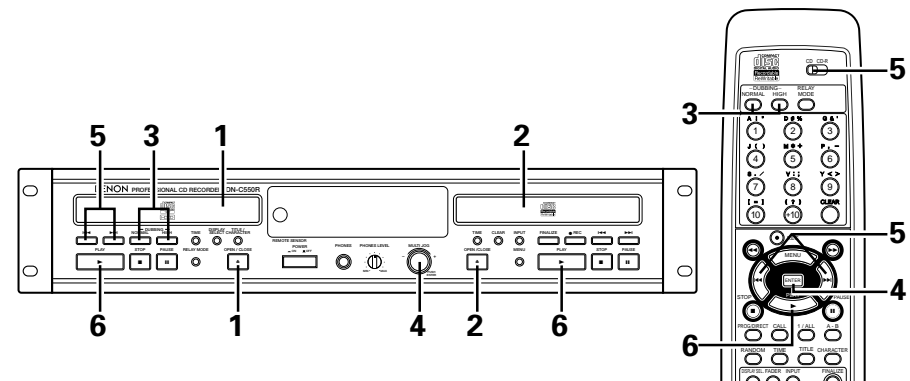

1	Load the CD you want to copy into the CD unit.
2	Load the CD-R/RW onto which you want to record into the CD-R unit.
3	Press the normal or high speed copying button (NORMAL or HIGH) to display "All Tr. Dubb" or "Make CD Dubb".
4	Press the enter button to set the copying mode. <ul style="list-style-type: none"> The CD unit is set to the pause mode, the CD-R unit to the recording standby mode.
5	Press the CD or CD-R unit's play button. <ul style="list-style-type: none"> Copying starts. If the "Make CD" mode has been selected, finalization starts automatically after copying is completed. (See Page 27.) Once finalization is completed the stop mode is set automatically. To stop in the middle of copying, press the stop button on the CD or CD-R unit.

1	Load the CD you want to copy into the CD unit.
2	Load the CD-R/RW onto which you want to record into the CD-R unit.
3	Press the normal or high speed copying button (NORMAL or HIGH) to display "1 Tr. Dubbing".
4	Press the enter button to set the copying mode. <ul style="list-style-type: none"> The CD unit is set to the pause mode.
5	Use the CD unit's automatic search buttons to select the track you want to record.
6	Press the CD or CD-R unit's play button. <ul style="list-style-type: none"> Copying starts. When copying is completed, the CD-R unit is stopped. To stop in the middle of copying, press the stop button on the CD or CD-R unit.

NOTE:

- If you wish to input text data, select the "All Tr. Dubb" mode. With CD-R discs, text data cannot be input after the disc has been finalized.

(3) Selecting tracks to be copied while scanning CDs and copying the selected tracks

★ The intro scan playing time can be set at the setup menu (Page 12).

(Main unit)

(Remote control unit)

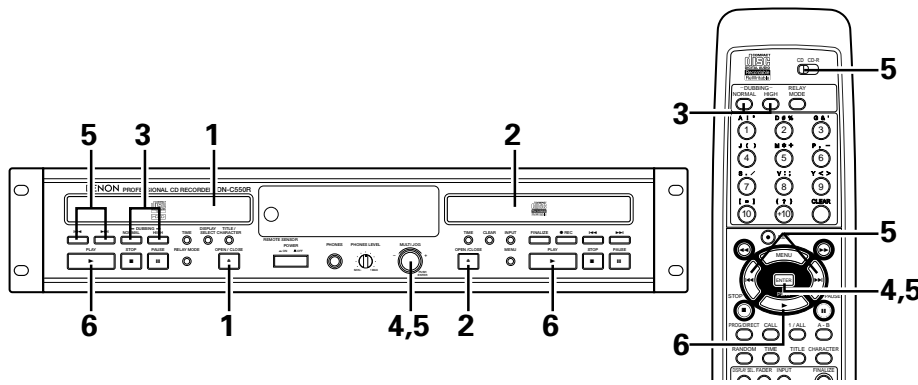

1	Load the CD you want to copy into the CD unit.
2	Load the CD-R/RW onto which you want to record into the CD-R unit.
3	Press the normal or high speed copying button (NORMAL or HIGH) to display "Scan Rec Dub".
4	Press the enter button to set the copying mode. <ul style="list-style-type: none"> Intro scan playback starts on the CD unit. The "PROG" indicator lights.
5	Set the tracks you want to record. <ul style="list-style-type: none"> For tracks you want to record, press the enter button. For tracks you do not want to record, press the automatic search forward button. Once all the tracks have been scanned, the CD unit is set to the pause mode, "Choice OK?" is displayed. Check the settings on the music calendar, and if they are OK press the enter button. If the settings are wrong, press the stop button then repeat steps 1 to 5. "No Entry" is displayed if no tracks have been selected.
6	Press the CD or CD-R unit's play button. <ul style="list-style-type: none"> Copying starts. When copying is completed, the CD-R unit is stopped. To stop in the middle of copying, press the stop button on the CD or CD-R unit.

NOTE:

- A maximum of 30 tracks can be set to be recorded. After setting 30 tracks, "Choice OK?" is displayed and more tracks can not be set.

10 RECORDING FROM EXTERNAL DEVICES

- When recording on an already recorded disc, recording automatically starts from the end of the section last recorded. When doing so, pay attention to the remaining time.
- To clear the entire content of the disc and record from the beginning, first erase the entire disc. ("2) Erasing the tracks" Page 28.
- To assure accurate recording, record with an ambient temperature of 30 °C or less.
- Recording may stop if the unit is subject to shocks during recording. If recording stops, it may no longer be possible to use the disc normally. ("Disc Error")
- Switch to the normal or dual mode when recording. Operation is not possible in the relay or mix mode.

Relay mode	Relay	Mix	Dual	Normal
Copying	X	X	○	○

Recording Modes

- Your recorder offers several recording modes.
- Setting is possible using the method of "Setup Method" on Page 10.

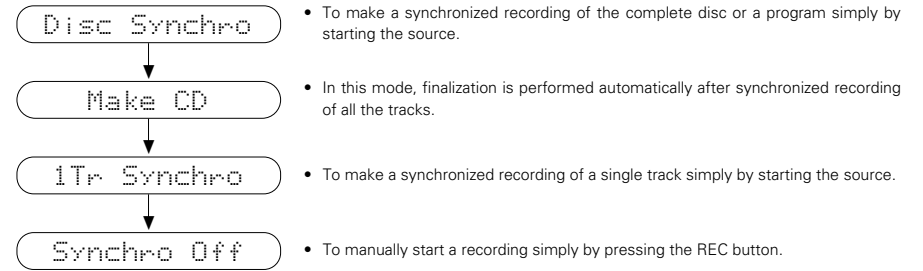

NOTES:

- Analog recording is not possible in the Make CD mode.
- Use the copy mode to record HDCDs. Such discs may not be recorded properly when recording from the exterior.
- Do not turn off the power or unplug the power cord while "Now PMR Rec" is displayed after recording is completed. Doing so may render the disc unusable.

Some remarks on recording:

- When Auto track is ON (default setting), track numbers will automatically be increased during recording.
- By programming the source first, a compilation can be recorded.

1. Manual recording

(1) Starting analog recording

(Main unit)

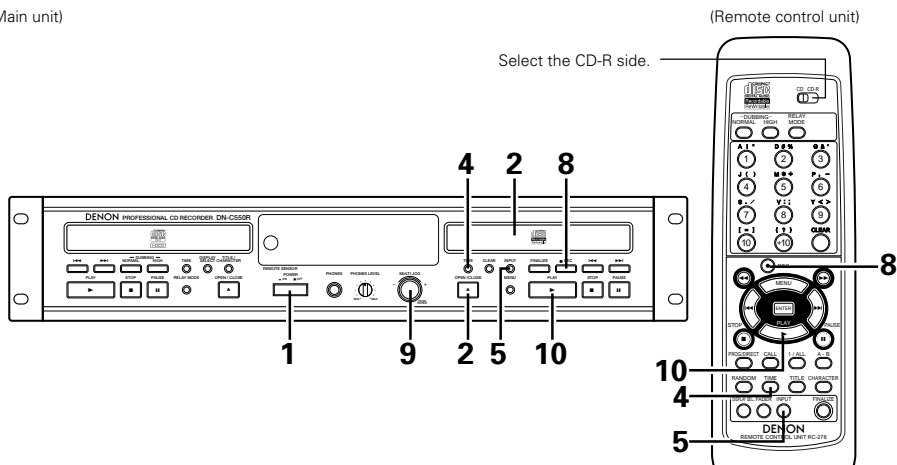

1	Turn on the power.
2	Load the CD-R/RW disc that is to be recorded.
3	Perform the operation of "Setup Method (2) Setting the Synchro Recording Mode " on Page 10 and select the Synchro off mode.
4	When using an already recorded Disc, press the TIME button to check the recordable time. • The time display switches between the total recorded time and the recordable time each time the TIME button is pressed.
5	Press the input switching button (INPUT) and select the analog source. • The "ANALOG" or "ANALOG XLR" display will light.
6	Perform the operation of "Setup Method" on Page 10 and select on/off of the ATM function.
7	Start playing the selection you want to record on the CD player, cassette deck, etc.
8	Press the record button (● REC). • The recording standby mode is set.
9	Adjust the recording level with the jog dial and press the enter button. • Adjust the input level adjustment control (INPUT LEVEL) so that the "OVER" indicator does not light even when the volume is loudest. After adjusting, set the source to be recorded to the standby mode. * The recording level can be set in advance using the menu mode. • The set recording level will be stored in memory, but this data might be lost if the unit is not connected to a power source for 2 to 3 days.
10	Press the play button (▶ PLAY). • Recording starts.
11	Start playing the selection you want to record on the CD player, cassette deck, etc.

(2) Starting digital recording

- This set includes a sampling rate converter.

When recording DATs or satellite broadcasts (32 kHz or 48 kHz) whose digital input signal sampling frequency is different from that of CD (44.1 kHz), the sampling frequency is automatically converted to 44.1 kHz.

(Main unit)

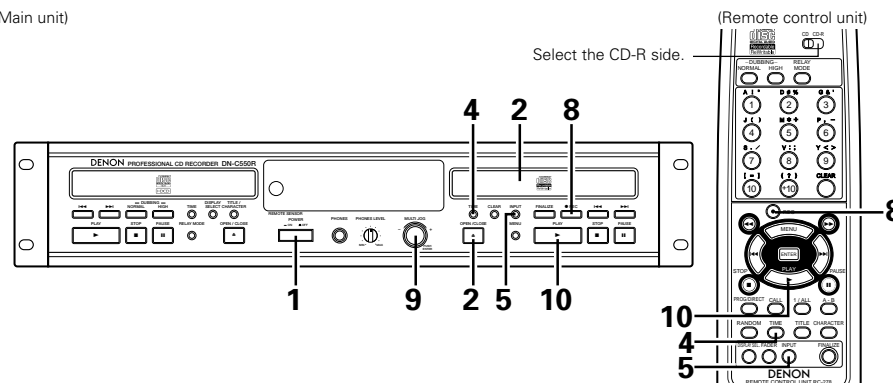

1	Turn on the power.
2	Load the CD-R/RW disc that is to be recorded.
3	Perform the operation of "Setup Method (2) Setting the Synchro Recording Mode " on Page 10 and select the Synchro off mode.
4	When using an already recorded Disc, press the TIME button to check the recordable time. • The time display switches between the total recorded time and the recordable time each time the TIME button is pressed.
5	Press the input switching button (INPUT) and select the digital source (Optical or Coaxial). • The indicator for the selected input source ("OPT" or "COAX") lights.
6	Perform the operation of "Setup Method" on Page 10 and select on/off of the ATM function.
7	Start playing the selection you want to record on the CD player, MD recorder, etc.
8	Press the record button (● REC). • The recording standby mode is set. • If the "D. in" indicator is flashing, check the connections to the digital input jacks.
9	Adjust the recording level with the jog dial and press the enter button. • Adjust the input level adjustment control (INPUT LEVEL) so that the "OVER" indicator does not light even when the volume is loudest. After adjusting, set the source to be recorded to the standby mode. * The recording level can be set in advance using the menu mode. • The set recording level will be stored in memory, but this data might be lost if the unit is not connected to a power source for 2 to 3 days.
10	Press the play button (▶ PLAY). • Recording starts.
11	Play the selection to be recorded on the CD player, etc.

NOTES:

- "CD" can be selected by pressing the input selector button, but manual recording from the set's CD unit is only possible in the dual mode. (Refer to "Dual mode" on Page 26, 27).
- When you do not wish to change the digital recording level, set the jog dial so that "Level 00.0dB" is displayed. The recording will be made without changing the input signal level.
- The recording level can be adjusted over a range of -∞ to +12 dB for analog and digital input recording. Note that the displayed setting values may include a degree of error in terms of calculation processing.
- When the recording level is -∞, "Level ---. -dB" is displayed and audio is not output.

(3) Stopping recording

(Main unit)

(Remote control unit)

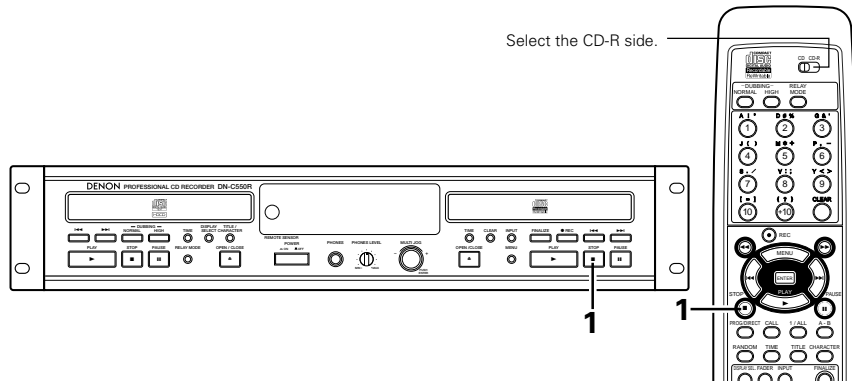

(4) Adding track numbers during recording

(Main unit)

(Remote control unit)

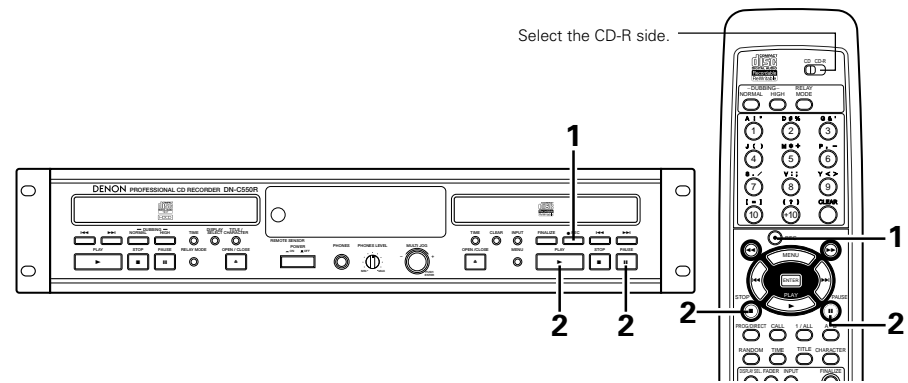

- Track numbers can be added during recording regardless of the recording mode.

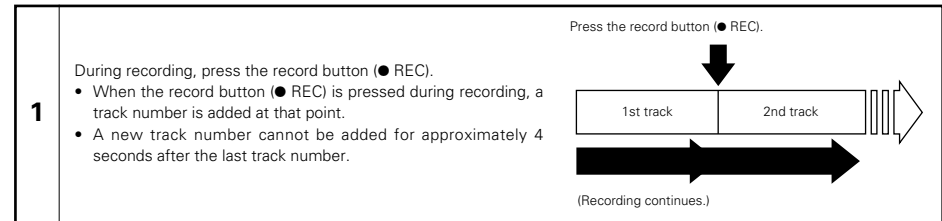

(5) Stopping recording temporarily

- Recording can be stopped temporarily then resumed from the same point.

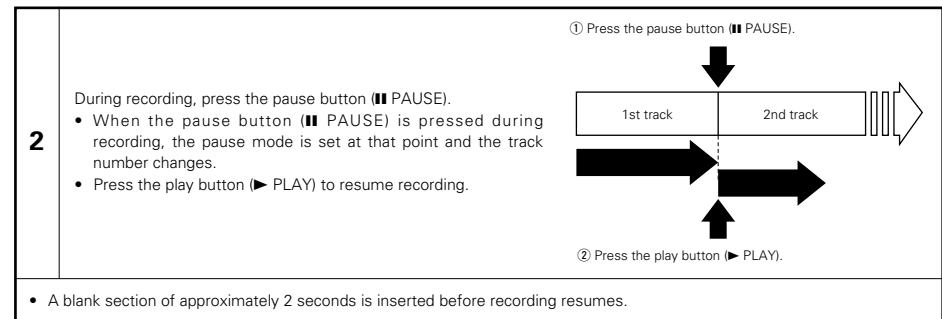

- 1**
- During recording, press the stop button (■ STOP).
- The stop mode is set automatically once the end of the recordable time is reached.

NOTES:

- When performing digital recording of CD or MD, the track numbers are recorded automatically. (See Page 6.)
- When recording digital sources other than CD or MD, track numbers are automatically added when blank sections are detected. (See Page 6.)
- During digital recording from CD or MD, the track number may not change if the same track is programmed twice in a row or if the single track repeat mode is set.
- It is not possible to conduct digital input recording from digitally recorded CD-R/RW discs, MDs or DATs if "SCMS ENA." is set at "Copy management" in the setup mode. In this case, either switch to analog input recording or set "SCMS INH." in the setup mode.
- To eject the Disc if the "Copy Prohibit" or "Dig.Unlock" message is displayed during digital recording and the recording pause mode is set, first press the stop button (■ STOP), then press the open/close button (▲ OPEN/CLOSE) to eject the Disc.

2. Synchronized recording of the Disc (DISC SYNCHRO)

- ★ This mode is used when recording all the tracks of the CD or MD on the playback side.
- ★ Please also see "Setup Method (3) Setting the Synchro Recording Level" on Page 11.

(Main unit)

(Remote control unit)

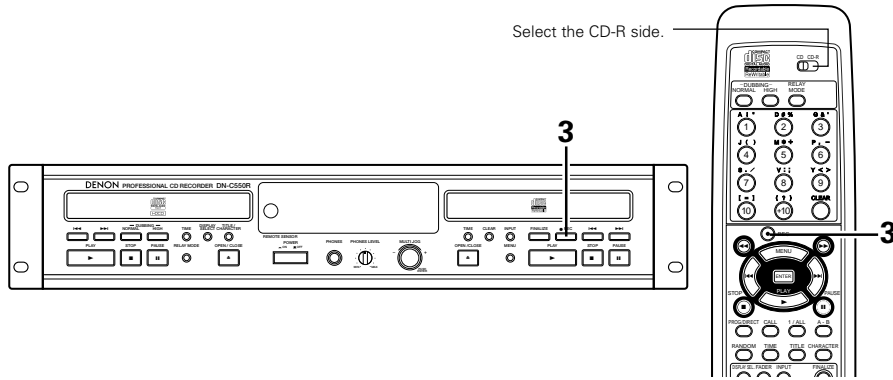

1	Perform the operation of "Manual recording" on Page 16, perform the settings of the input jacks and the recording level, and set the stop mode.
2	Perform the procedure at "Setup Method (2) Setting the Synchro Recording Mode" on Page 10 and select the disc synchro mode or the make CD mode. <ul style="list-style-type: none"> • The "SYNC" indication will light.
3	Press the record button (● REC). <ul style="list-style-type: none"> • The recording pause mode is set and "Disc Synchro" or "Make CD" is displayed.
4	Use a CD player, cassette deck or other source to play the tracks that you wish to record. <ul style="list-style-type: none"> • Recording will start automatically. • In the make CD mode, finalization is performed automatically after recording stops. * Please also see "Setup Method (3) Setting the Synchro Recording Level" on Page 11.
<ul style="list-style-type: none"> • To stop synchro recording, press the stop button. 	

NOTE:

- If you wish to input text data, select the "Disc Synchro" mode. With CD-R discs, text data cannot be input after the disc has been finalized.

3. Synchronized recording of the single track (1Tr SYNCHRO)

- ★ This mode is used to record only one track.
- ★ Please also see "Setup Method (3) Setting the Synchro Recording Level" on Page 11.

(Main unit)

(Remote control unit)

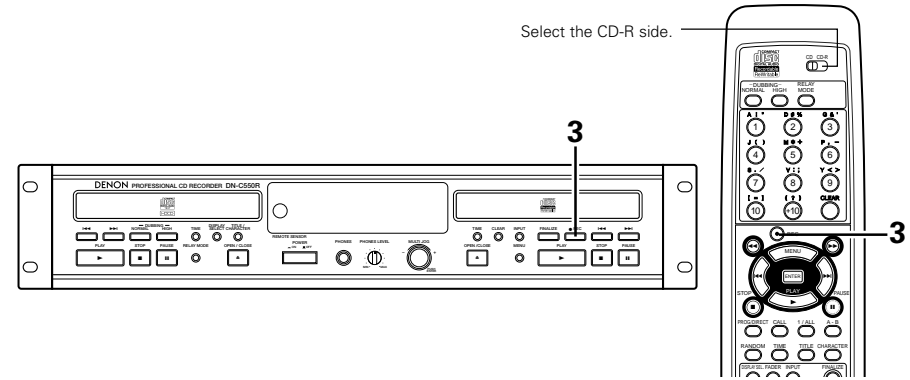

1	Perform the operation of "Manual recording" on Page 16, set the input jacks and the recording level, and set the stop mode.
2	Perform the operation of "Setup Method (2) Setting the Synchro Recording Mode" on Page 10 and select the track synchro mode. <ul style="list-style-type: none"> • The "1Tr SYNC" indication lights.
3	Press the record button (● REC). <ul style="list-style-type: none"> • This sets the record-pause mode and displays "1Tr Synchro".
4	Use a CD player, cassette deck or other source to play the tracks that you wish to record. <ul style="list-style-type: none"> • Recording will start automatically. * Please also see "Setup Method (3) Setting the Synchro Recording Level" on Page 11.
<ul style="list-style-type: none"> • To stop synchro recording, press the stop button. • If there is a soundless section of 3 seconds or more, recording stops when the next track starts. • Recording stops if there is a soundless section of 10 seconds or more. 	

4. Fade-in and fade-out recording

★ It is possible to record by gradually increasing the volume (fade-in) or decreasing it (fade-out).

(1) Fade-in recording

* Also refer to "Setup Method (5) Fade-in time setting" (Page 11).

1	Perform the procedure at "Manual recording" step 1 to 8 (Page 16).
2	Start playing the selection you want to record on the CD player, cassette deck, etc.
3	Press the fader button on the remote control unit. <ul style="list-style-type: none"> • "Fade In" is displayed, and "FADE" flashes during the fade in operation. • The recorded sound is gradually increased from a recording level of $-\infty$ to the set recording level in the set time.

(2) Fade-out recording

* Also refer to "Setup Method (6) Fade-out time setting" (Page 11).

1	During recording, press the fader button on the remote control unit. <ul style="list-style-type: none"> • "Fade Out" is displayed, and "FADE" flashes during the fade out operation. • The recorded sound is gradually decreased from the set recording level to a recording level of $-\infty$ in the set time.
----------	---

NOTE:

- The fade in/out recording function does not work in the synchro or copy recording modes. Record manually if you want to use the fade in/out function.

11 NORMAL PLAYBACK

1. Starting playback

First try playing the tracks in order.

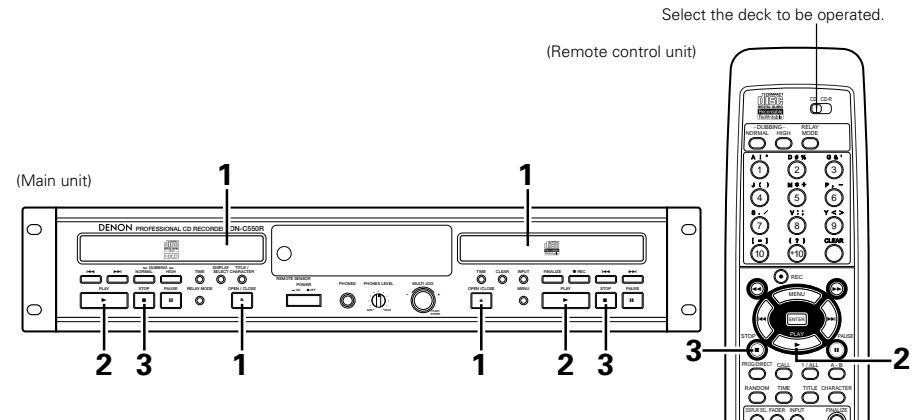

1	Load the disc to be played.
2	<ul style="list-style-type: none"> • Press the PLAY button (▶) to start CD play. • "▶" lights up and the track number and track time of the track in play appear on the display. • Press the TIME button once, twice or three times to see: Remaining track time, total remaining time, elapsed track time.

NOTE:

- "No Disc" will be displayed at such times as when a disc is not loaded, the disc cannot be read properly due to scratches or dirt, or the disc is loaded upside down.

2. Stopping playback

3	Press the stop button (■ STOP). <ul style="list-style-type: none"> • Playback stops. • The stop mode is set automatically once all the tracks on the disc have been played.
----------	---

12 VARIOUS PLAYBACK FUNCTIONS

In addition to normal playback, the DN-C550R also offers the playback functions described below.

1. Playing a certain track (remote control unit only) Direct Search

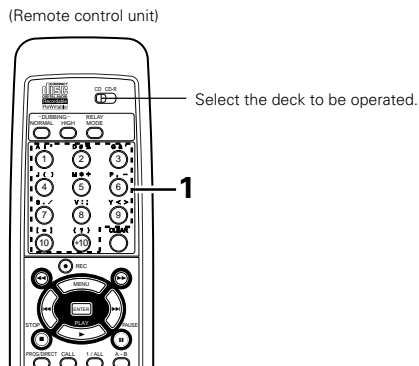

- 1**
- Use the number buttons (1 to 10) and the +10 button to input the number of the desired track.
- For example:
Press button **4** to listen to the 4th track, buttons **+10** and **2** to listen to the 12th track, **+10**, **+10** and **10** to listen to the 30th track. Playback begins from that track.

2. Finding the desired position while listening to the sound Manual Search

- Use this function to skip rapidly through the disc while listening to the sound. This function comes in handy when you want to find a certain section within a long track.

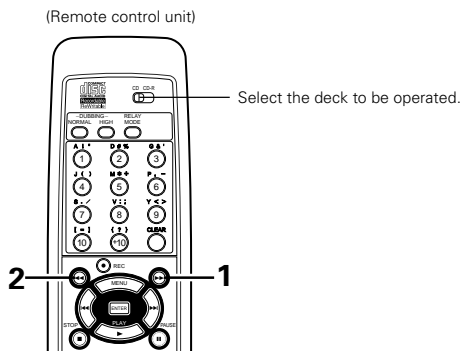

(1) Searching forward

1

During playback, press and hold in the manual search forward button (▶▶).

- Normal playback resumes from the point at which the button is released.
- Playback stops if the end of the last track on the disc is reached while pressing the manual search forward button (▶▶).
- For high-speed forward search without hearing the sound, press the manual search forward button (▶▶) while in the pause mode.

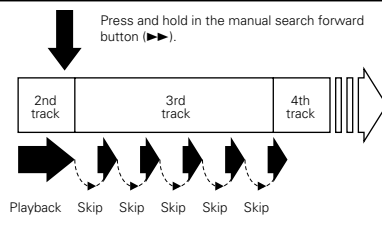

(2) Searching backward

2

During playback, press and hold in the manual search reverse button (◀◀).

- Normal playback resumes from the point at which the button is released.
- Manual search stops and playback starts if the beginning of the first track on the disc is reached while pressing the manual search reverse button (◀◀).
- For high-speed backward search without hearing the sound, press the manual search reverse button (◀◀) while in the pause mode.

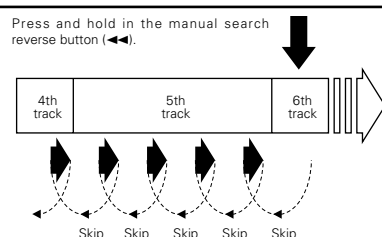

NOTE:

- There may be a slight break in the sound when returning to normal playback from the manual search mode.

3. Finding the beginnings of tracks during playback Automatic Search

(1) Moving ahead to the beginning of the next track

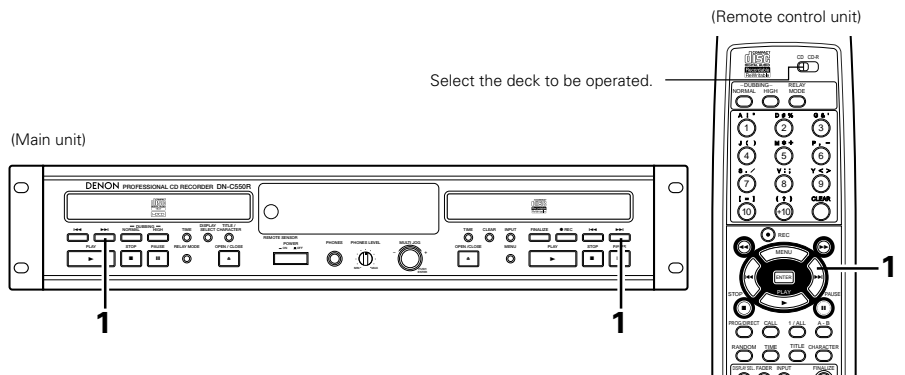

1

Press the automatic search forward button (▶▶|).

- During the search operation, press the automatic search forward button (▶▶|) again to move further on to the beginning of the following track.

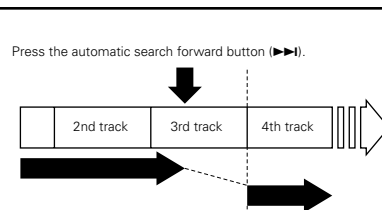

(2) Moving back to the beginning of the current track

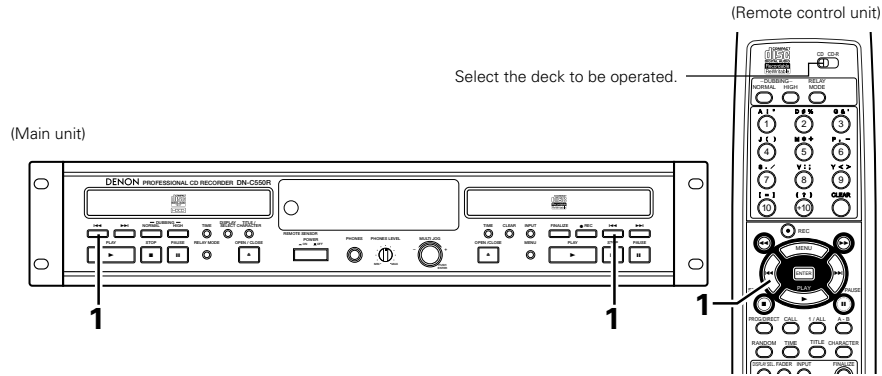

1 Press the automatic search reverse button (◀◀).
 • During the search operation, press the automatic search reverse button (◀◀) again to move further back to the beginning of previous track.

Press the automatic search reverse button (◀◀).

4. Stopping playback temporarily

Pause

- Use this function to stop playback temporarily then resume from the same point.

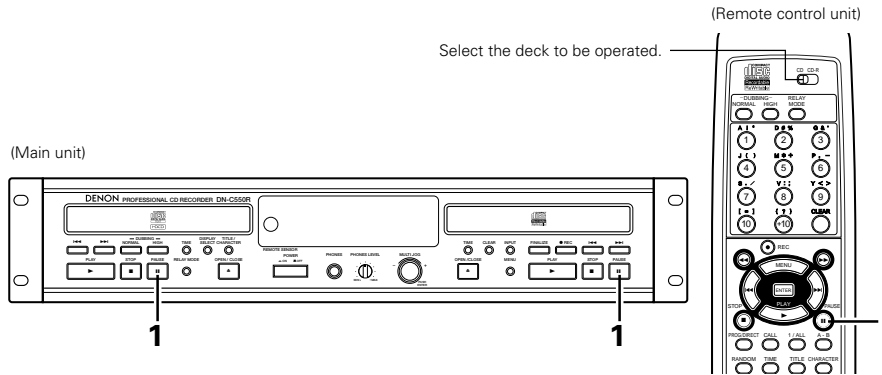

1 During playback, press the pause button (⏸ PAUSE).
 • The pause mode is set.
 • Press the play button (▶ PLAY) to resume playback from the point at which the pause mode was set.

① Press the pause button (⏸ PAUSE).

② Press the play button (▶ PLAY).

5. Playing tracks in a certain order

Programmed Playback

- Use this function to select certain tracks from the disc and program them to play in a certain order.
- Up to 30 tracks can be programmed.

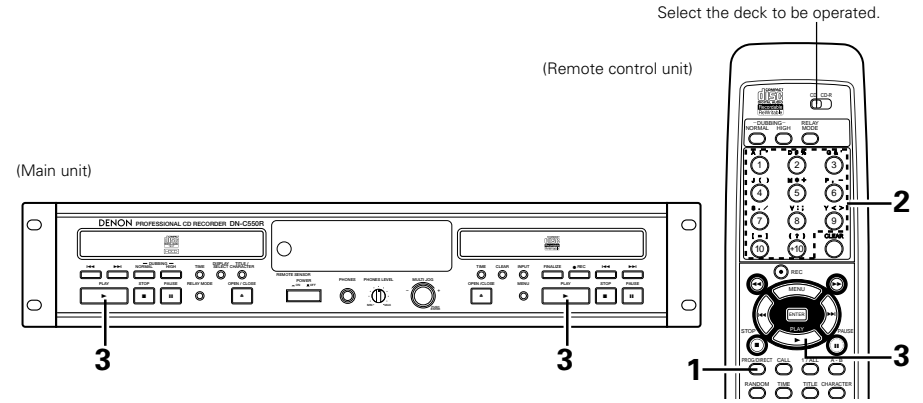

1 In the stop mode, press the PROG/DIRECT button.
 • The "PROG" indicator lights.

2 Use the number buttons and the +10 button to select the tracks for programmed playback.
 • For example, to program the 3rd, 12th and 7th tracks, press [PROG/DIRECT], [3], [+10], [2] and [7].

3 Press the play button (▶ PLAY).
 • The tracks are played in the programmed order.

- To check the contents of the program, press the CALL button. The programmed tracks appear in the programmed order on the display each time the CALL button is pressed.
- To change the program, press the CLEAR button while in the stop mode, then program the desired track. The last programmed track is replaced with the newly input track.
- To clear the entire program, press the PROG/DIRECT or open/close (▲ OPEN/CLOSE) button while in the stop mode.

NOTES:

- The single track repeat mode and A-B repeat mode cannot be set during programmed playback.
- Programs with total playing times of over 99 minutes can be set, but the time will not be displayed properly.
- Programmed playback is not possible with non-finalized discs.
- The direct search operation is not possible during programmed playback.
- Track numbers of 21 or greater can be programmed for discs containing over 20 tracks, but when this is done the time is not displayed properly.

6. Playing in random order

Random Playback

- Use this function to play all the tracks on the disc once in random order.

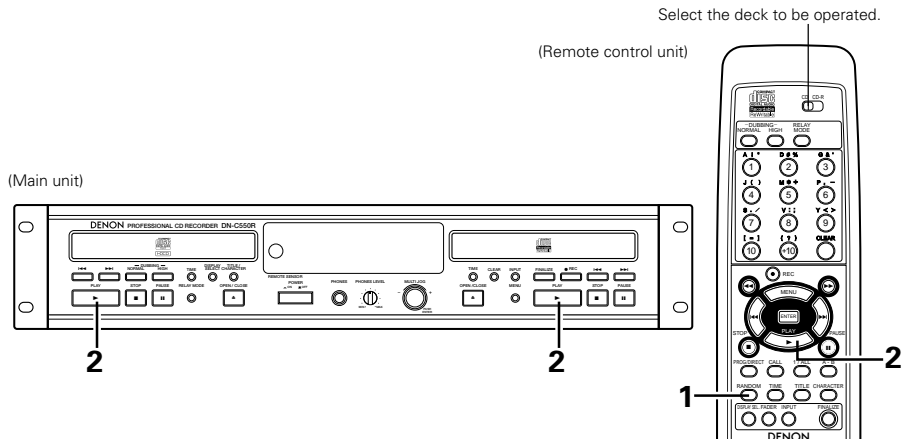

- | | |
|----------|---|
| 1 | <p>In the stop mode, press the RANDOM button.</p> <ul style="list-style-type: none"> The "RAND" indicator lights. |
| 2 | <p>Press the play button (▶ PLAY).</p> <ul style="list-style-type: none"> During normal playback: Tracks are automatically played in random order. During the all-track repeat mode: All tracks are played once in random order, then repeated in another random order. To cancel the random play mode, press the RANDOM button after stopping playback. |

NOTES:

- The single track repeat mode and A-B repeat mode cannot be set during random playback.
- Random playback is not possible with non-finalized discs.

7. Playing repeatedly

Repeat Playback

(1) Playing a single track repeatedly [Single Track Repeat]

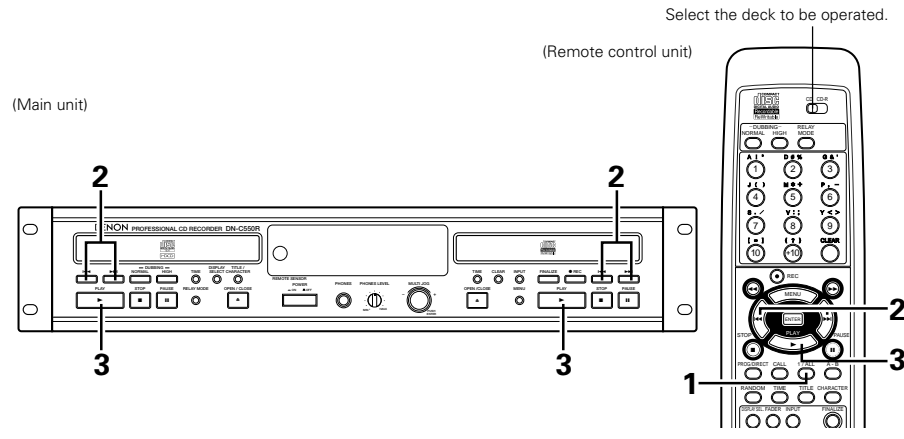

- | | |
|----------|--|
| 1 | <p>Press the repeat 1/ALL button once.</p> <ul style="list-style-type: none"> The "REPEAT 1" indicators light on the display and the single track repeat mode is set. |
| 2 | <p>Use the automatic search buttons (◀◀ and ▶▶) to select the track to be played repeatedly.</p> |
| 3 | <p>Press the play button (▶ PLAY).</p> <ul style="list-style-type: none"> Playback starts. Once the selected track ends, it is played again from the beginning. The single track repeat mode can also be set by pressing the repeat 1/ALL button during playback. The current track is played repeatedly. To cancel the single track repeat mode, press the repeat 1/ALL button repeatedly until the "REPEAT" indicator turns off. |

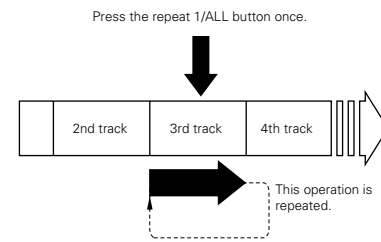

(2) Playing all tracks repeatedly [All Track Repeat]

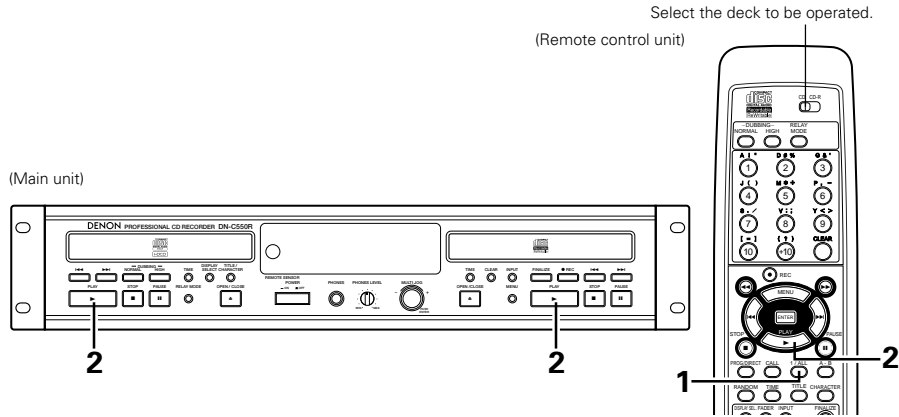

- | | |
|----------|---|
| 1 | <p>Press the repeat 1/ALL button twice.</p> <ul style="list-style-type: none"> The "REPEAT" indicators light on the display and the all track repeat mode is set. |
| 2 | <p>Press the play button (▶) PLAY.</p> <ul style="list-style-type: none"> The disc is played repeatedly. The all track repeat mode can also be set by pressing the repeat 1/ALL button twice during playback. If the repeat 1/ALL button is pressed during programmed playback, the tracks are played repeatedly in the programmed order. To cancel the all track repeat mode, press the repeat 1/ALL button repeatedly until the "REPEAT" indicator turns off. |

NOTES:

- The single track repeat mode cannot be set during programmed playback or random playback.
- Repeat playback is not possible with non-finalized discs.

(3) Playing a section between any two points repeatedly [A-B Repeat]

★ This function allows you to play a certain section within a track repeatedly.

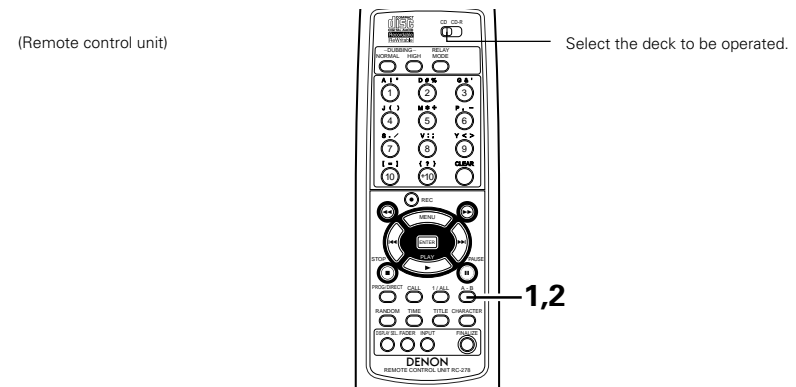

- | | |
|----------|--|
| 1 | <p>During playback, press the repeat A-B button at the position at which you want to start repeating (point A).</p> <ul style="list-style-type: none"> The "REPEAT A-" indicator lights. |
| 2 | <p>Press the repeat A-B button again at the position at which you want to stop repeating (point B).</p> <ul style="list-style-type: none"> The "REPEAT A-B" indicator lights, the pickup returns to point A, and the section is played repeatedly. <div style="text-align: center;"> <p>(1) Press the repeat A-B button during playback. (2) Press the repeat A-B button again.</p> <p>(Point A) (Point B)</p> <p>2nd track 3rd track 4th track</p> <p>This operation is repeated.</p> </div> |

- To stop A-B repeat playback, press the repeat A-B button on the remote control unit until the "REPEAT" indicator turns off. The A-B repeat mode is canceled and normal playback starts from the beginning of the current track.
- If the stop button (■) STOP is pressed, the A-B repeat mode is canceled and the stop mode is set.

NOTES:

- A-B repeat playback is not possible during programmed playback or random playback.
- The automatic and manual search functions cannot be used during A-B repeat playback or when setting point B.
- When A-B repeat playback is canceled when point B is set on a different track from point A, playback resumes from the beginning of the track that is playing when the A-B repeat mode is canceled.
- A-B repeat playback is not possible with non-finalized discs.

8. Timer playback

- A separately sold audio timer can be used to start playback or recording at a specific time.
- Also refer to the operating instructions for the audio timer and amplifier.
- The program and relay modes can also be used.

Timer playback

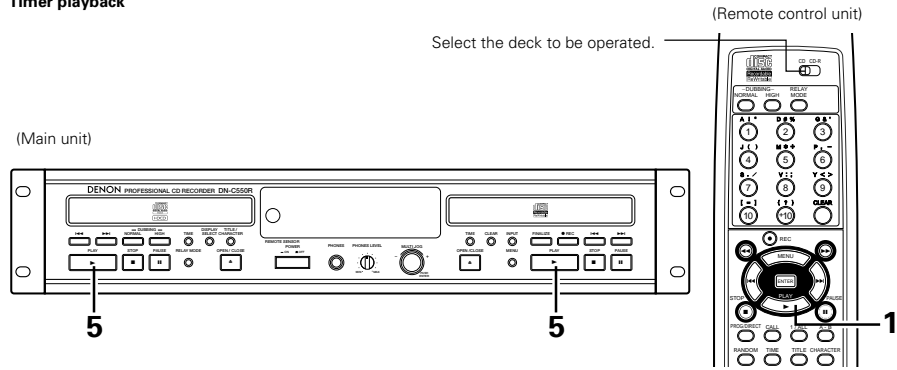

1	Turn on the power of the DN-C550R and the connected components.
2	Perform the procedure at "Setup Method (10) Timer play mode setting" (Page 13) and make the timer playback on setting.
3	Load the Disc for timer playback into the DN-C550R.
4	Set the amplifier's input selector to "CD".
5	Press the play button (▶ PLAY). • Play the disc to check the volume.
6	Set the audio timer for the desired time. • The power of the components connected to the audio timer turns off. • When the set time is reached, the power of the various components turns on automatically and playback begins from track one.
<ul style="list-style-type: none"> • The settings for the program mode, random mode, relay mode, etc., are stored in the memory before the power is turned off. • If there is no disc in the CD side and a disc is loaded in the CD-R side: Timer playback does not function when the relay mode is set to normal or dual. Timer playback functions for the CD-R side when the relay mode is set to relay or mix. 	

13 RELAY MODE

Relay mode

- ★ Various types of playback and recording can be performed through relay operation between the set's CD and CD-R units.
- ★ There are three relay modes.
- ★ The set mode is stored in the memory, but the data may be cleared if the power is not turned on for 2 or 3 days.
- The mode switches as shown below each time the RELAY MODE button is pressed.

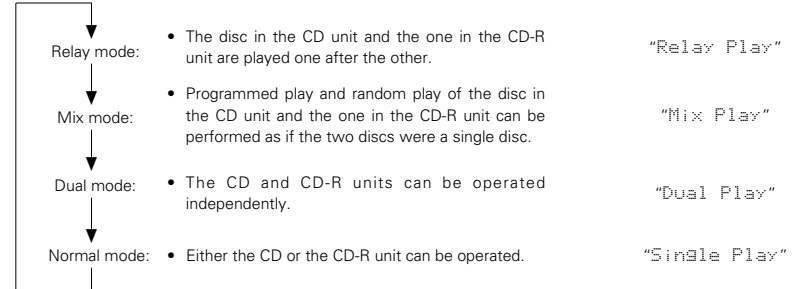

NOTE:

- Recording, finalizing and editing are not possible in the relay or mix mode.

1. Relay play

- ★ With the relay play mode it is possible to play the disc in the CD side and the one in the CD-R side, relaying between them.
- ★ The programmed play and random play modes can be preset for the discs in the CD and CD-R units.

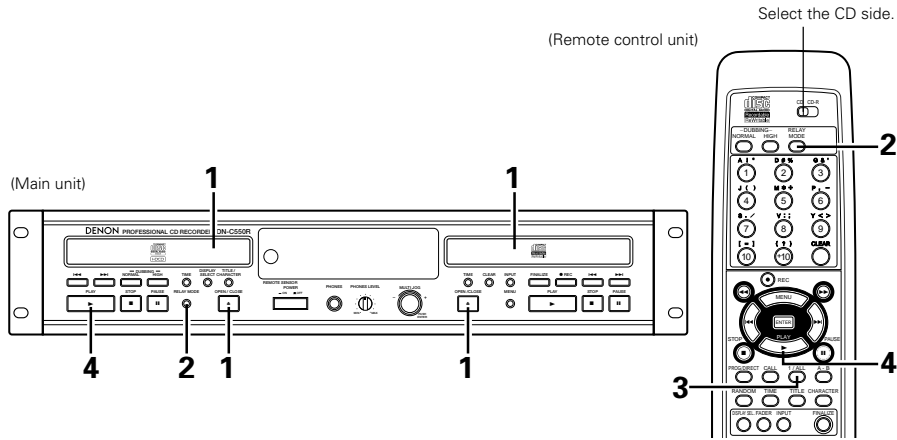

2. Mix mode

- ★ In the mix mode, programmed play and random play of the disc in the CD unit and the one in the CD-R unit can be performed as if the two discs were a single disc.

(1) Mix programmed playback

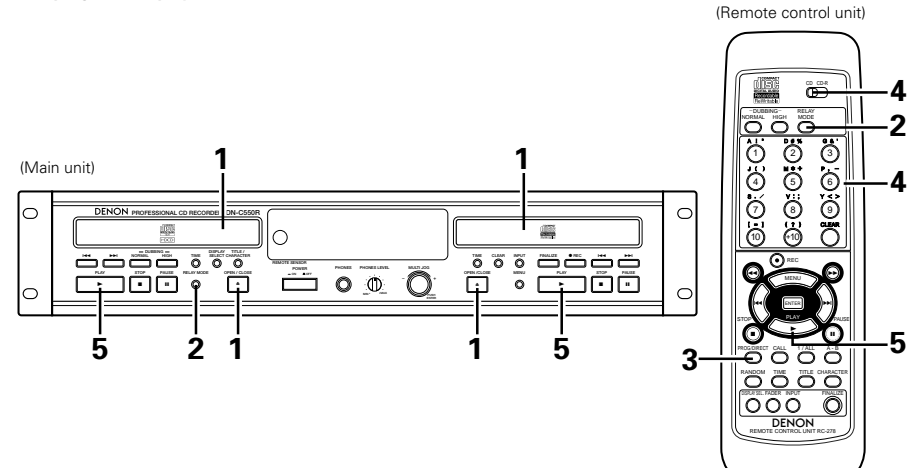

1	Load the discs you want to play in the CD and CD-R units.						
2	Press the RELAY MODE button and select "Relay Play". • The "RELAY" indicator lights.						
3	Use the CD or CD-R section repeat 1/ALL button on the remote control unit to turn the repeat mode on or off. • The 1-track repeat mode cannot be set in the relay mode. • The relay operation is performed as shown below according to the combination of the relay and repeat modes: <table border="1" style="margin: 10px auto;"> <thead> <tr> <th>Repeat mode</th> <th>Relay operation</th> </tr> </thead> <tbody> <tr> <td>Repeat on: "REPEAT" indicator lit</td> <td style="text-align: center;"> </td> </tr> <tr> <td>Repeat off</td> <td style="text-align: center;"> </td> </tr> </tbody> </table>	Repeat mode	Relay operation	Repeat on: "REPEAT" indicator lit		Repeat off	
Repeat mode	Relay operation						
Repeat on: "REPEAT" indicator lit							
Repeat off							
4	Relay play starts when the CD unit's play button is pressed. • The sound is output from the CD/CD-R output jacks. • To quit the relay mode, press the relay mode button and select "Single Play". • The disc in the side that is not operating can be replaced during relay playback.						

1	Load the discs you want to play in the CD and CD-R units.
2	Press the RELAY MODE button and select "Mix Play". • The "MIX" indicator lights.
3	Press the CD or CD-R unit's PROG/DIRECT button on the remote control unit to set the program mode. • The "PROG" indicator lights.
4	Follow the procedure at "Programmed playback" on Page 21 to program the tracks in the order in which you want to play them. • You can program tracks for both the CD and CD-R units by using the CD/CD-R selector switch on the remote control unit to switch between them. • Up to 30 tracks can be programmed.
5	Mix programmed playback starts when the CD or CD-R unit's play button is pressed. • The sound is output from the CD/CD-R output jacks. • To quit the mix mode, press the relay mode button and select "Single Play".

NOTE:

- When relaying between a CD and CD-R, the digital data from the CD/CD-R digital output terminal is interrupted momentarily. The digital input of the connected external device is temporarily unlocked at this time.

NOTE:

- When relaying between a CD and CD-R, the digital data from the CD/CD-R digital output terminal is interrupted momentarily. The digital input of the connected external device is temporarily unlocked at this time.

(2) Mix random playback

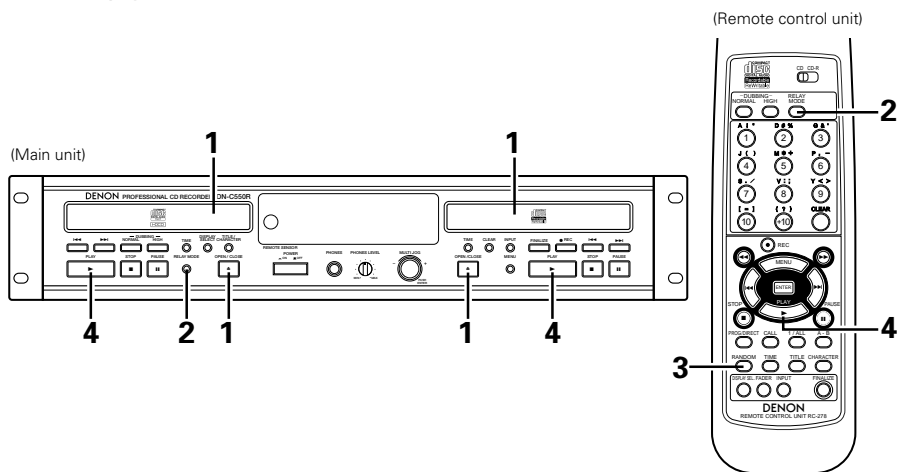

1	Load the discs you want to play in the CD and CD-R units.
2	Press the RELAY MODE button and select "Mix Play". • The "MIX" indicator lights.
3	Press the CD or CD-R unit's RANDOM button on the remote control unit to set the random mode. • The "RAND" indicator lights.
4	Mix random playback starts when the CD or CD-R unit's play button is pressed. • The sound is output from the CD/CD-R output jacks. • To quit the mix mode, press the relay mode button and select "Single Play".

NOTES:

- If the program and random mode is not set in the mix mode, the operation is the same as in the relay mode (with the repeat mode off).
- When relaying between a CD and CD-R, the digital data from the CD/CD-R digital output terminal is interrupted momentarily. The digital input of the connected external device is temporarily unlocked at this time.

3. Dual mode

- ★ In the dual mode, the CD unit and CD-R unit can be operated independently.
- ★ Manual recording from the main unit's CD section can be performed.
- ★ It is possible to record from an external unit on the CD-R unit while playing a disc in the CD unit.

(1) Dual playback

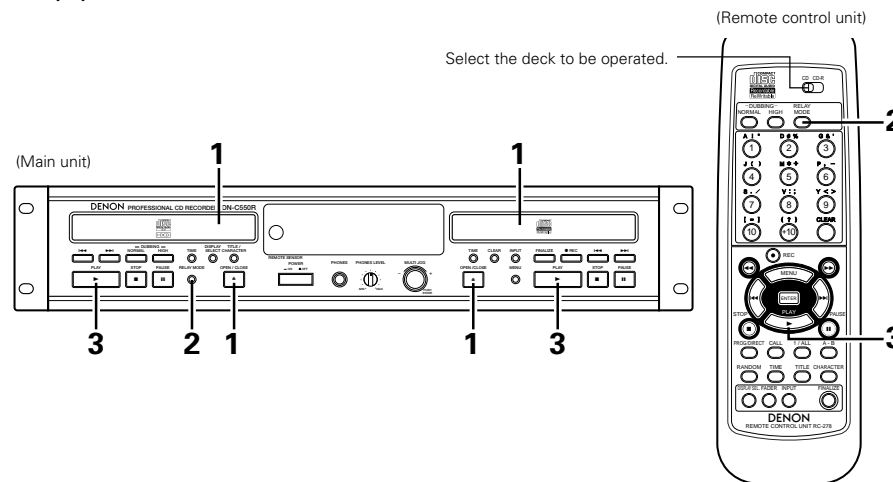

1	Load the discs you want to play in the CD and CD-R units.
2	Press the RELAY MODE button and select "Dual Play". • The "DUAL" indicator lights.
3	Dual playback starts when the CD or CD-R unit's play button is pressed. • The sound of the CD is output from the CD-only output jacks and the sound of the CD-R is output from the CD/CD-R output jacks. • Only the sound of the CD-R is output from the headphones jack. • The display can be switched with the DISPLAY SELECT button so that you can check the time information, etc., for the CD and CD-R. • To quit the dual mode, press the relay mode button and select "Single Play".

(2) Manual recording from the CD section

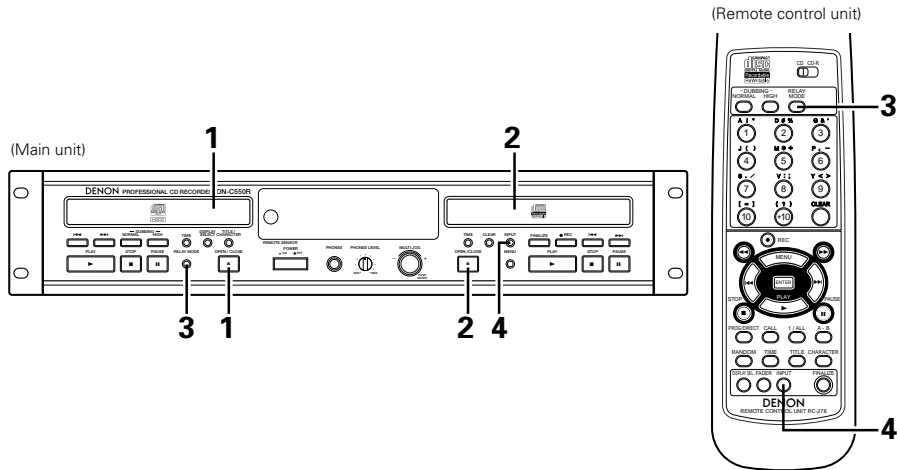

1	Load the CD you want to copy into the CD unit.
2	Load the CD-R/RW onto which you want to record into the CD-R unit.
3	Press the RELAY MODE button and select "Dual Play". • The "DUAL" indicator lights.
4	Press the input selector button and set "CD".
5	Follow the procedure at "Recording From External Devices" on Page 15 - 19 to record. • The display can be switched with the DISPLAY SELECT button so that you can check the time information, etc., for the CD and CD-R. • To quit the dual mode, press the relay mode button and select "Single Play".

NOTE:
• Only digital signals can be recorded from the CD unit manually.

14 FINALIZING CD-R/RW DISC

- ★ Finalizing is a simple procedure, necessary to:
 - Be able to play recordings on a CD player,
 - Avoid further unwanted recordings on a disc,
 - Avoid erasure of tracks on a CD-RW.
- ★ This operation is not possible in the relay or mix mode. Switch to the normal or dual mode to perform this operation.
- ★ Close the disc tray and set the stop mode for the CD section.

(1) Auto finalizing
Auto finalizing is possible when using the Make CD recording function. See "Copying Procedure" and "Synchronized recording of the Disc" on Page 13, 18.

(2) Manual finalizing

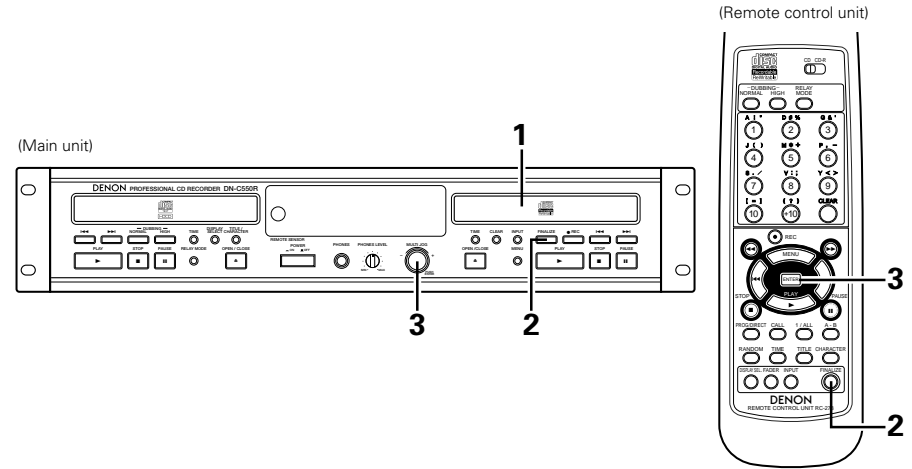

1	Load the CD-R/RW disc that is to be finalized.
2	With the recorder stopped press the FINALIZE button. • "Finalize OK?" is displayed.
3	Press the ENTER button. • The display counts down through the finalization. • On completion, the total number of tracks and the total time recorded appears on the display. • The disc indication of the display will become "CD".

NOTES:

- Make sure the disc is absolutely free of scratches and dust particles.
- Finalizing will take at least 2 - 4 minutes.
- During finalization, the CD recorder accepts no operating commands.
- Text data is written to the disc when the disc is finalized. If you want to enter text, this must be done prior to finalizing.
- For information about cancelling CD-RW finalizing, see "Cancellation of CD-RW Disc Finalizing (i.e., Unfinalizing)" on Page 28.
- Never turn off the power or unplug the power cord during finalization. Doing so may render the disc unusable.

15 EDITING

- ★ This operation is not possible in the relay or mix mode. Switch to the normal or dual mode to perform this operation.
- ★ Close the disc tray and set the stop mode for the CD section.

1. CD-R/RW editing

(1) Cancellation of CD-RW disc finalizing (i.e., Unfinalizing)

- ★ This operation is valid only for CD-RW discs. Finalizing cannot be cancelled from CD-R discs.
- ★ Use this operation to cancel finalizing when adding further recording to a finalized CD-RW disc.
- ★ Erasing is completed in several minutes.

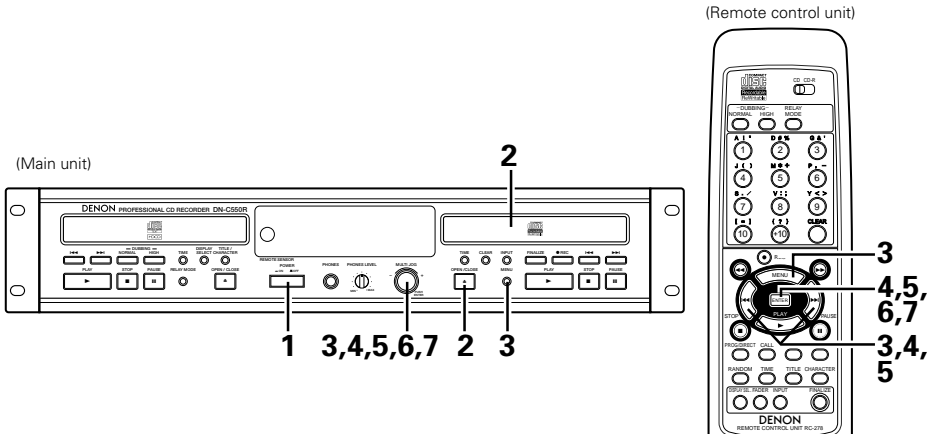

1	Switch on the power.
2	Load the CD-RW disc for which finalizing is to be cancelled.
3	Press the MENU button, turn the jog dial of the main unit or press the automatic search button of the remote control, and select the CD-R/RW edit mode. • "CD-R/RW Edit?" is displayed.
4	Press the enter button, turn the jog dial of the main unit or press the automatic search button of the remote control, and select the unfinalize mode. • "CD-RW Erase?" is displayed.
5	Now, press the enter button, turn the jog dial of the main unit or press the automatic search button of the remote control, and select the unfinalize mode. • "TOC Erase?" is displayed.
6	Press the enter button. • "Erase OK?" is displayed.
7	Press the enter button again. • "TOC Erase" display is flashing. • When unfinalizing is completed, the disc type display will be "CD-RW".

(2) Erasing the tracks

- ★ This operation is valid only for CD-RW discs.
- ★ Use this operation to cancel finalizing when adding further recording to a finalized CD-RW disc and when erasing recorded tracks.
- ★ Erasing is completed in several minutes.

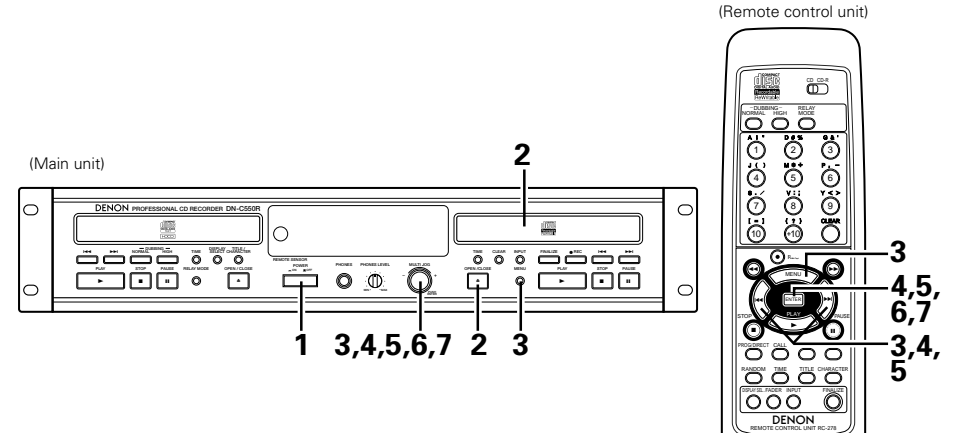

1	Switch on the power.
2	Load the CD-RW disc that is to be erased.
3	Press the MENU button, turn the jog dial of the main unit or press the automatic search button of the remote control, and select the CD-R/RW edit mode. • "CD-R/RW Edit?" is displayed.
4	Press the enter button, turn the jog dial of the main unit or press the automatic search button of the remote control, and select the all tracks erase mode. • "CD-RW Erase?" is displayed.
5	Now, press the enter button, turn the jog dial of the main unit or press the automatic search button of the remote control, and select the all tracks erase mode. • "All Erase?" is displayed.
6	Press the enter button. • "Erase OK?" is displayed.
7	Press the enter button again. • "All Erase" display is flashing. • When erasing is completed, the time display will be "Blank Disc".

(3) Erasing one or more tracks away from the last track

★ When erasing a finalized CD-RW disc, first unfinalize the disc.

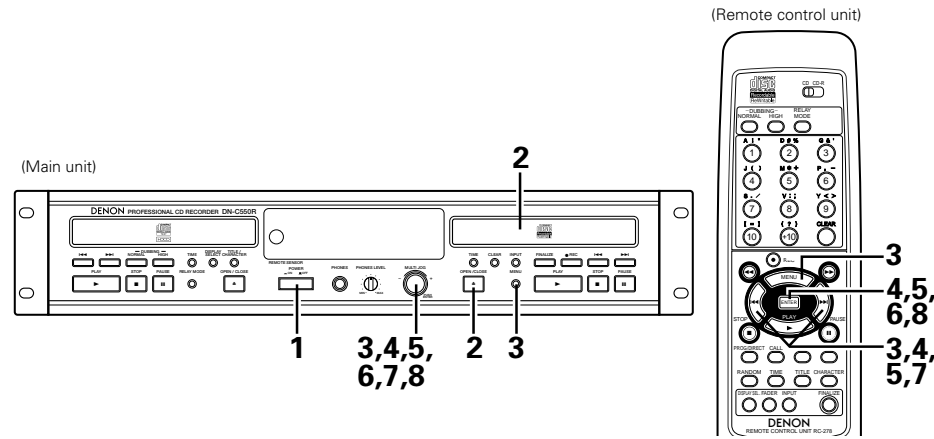

1	Switch on the power.
2	Load the CD-RW disc that is to be erased.
3	Press the MENU button, turn the jog dial of the main unit or press the automatic search button of the remote control, and select the CD-R/W edit mode. • "CD-R/W Edit?" is displayed.
4	Press the enter button, turn the jog dial of the main unit or press the automatic search button of the remote control, and select the one-track erase mode. • "CD-RW Erase?" is displayed.
5	Now, press the enter button, turn the jog dial of the main unit or press the automatic search button of the remote control, and select the one-track erase mode. • "1Tr Erase?" is displayed.
6	Press the enter button. • "**-**-1Tr Erase" is displayed.
7	Either turn the main unit's jog dial counterclockwise or press the automatic search REV button on the remote control and select the first of the tracks you want to erase from the last track.
8	Press the enter button again. • "1Tr Erase" display is flashing. • When erasing is completed, the number of tracks that remain following the erasure are displayed in a portion of the music calendar.

(4) Registration of the tracks to which you do not wish to listen

★ Tracks to which you do not wish to listen, such as those containing recording errors, can be set so that they will be skipped over during play.

★ When erasing a finalized CD-RW disc, first unfinalize the disc.

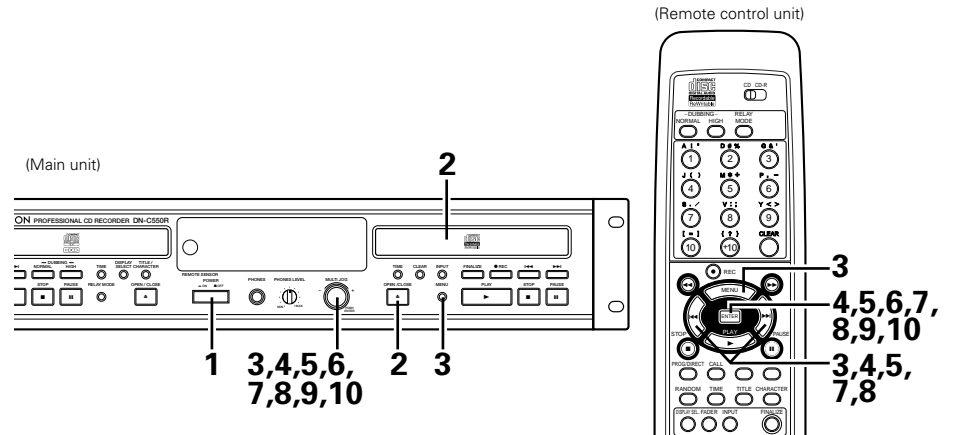

1	Switch on the power.
2	Load the CD-R/RW disc that contains tracks that you would like to skip in playback.
3	Press the MENU button, turn the jog dial of the main unit or press the automatic search button of the remote control, and select the CD-R/RW edit mode. • "CD-R/W Edit?" is displayed.
4	Press the enter button, turn the jog dial of the main unit or press the automatic search button of the remote control, and select the skip track setting mode. • "Skip Track?" is displayed.
5	Now, press the enter button, turn the jog dial of the main unit or press the automatic search button of the remote control, and select the skip track setting mode. • "Skip Set?" is displayed.
6	Press the enter button. • "Skip Set --Tr" is displayed.
7	Turn the jog dial of the main unit or press the automatic search button of the remote control, and select the tracks you want to skip. Press the enter button and set. • The music calendar display of the selected track number will flash.
8	Repeat Step 7 to add another track.
9	Press the enter button during the "Skip Set --Tr" display. • "Skip Set OK?" is displayed.
10	Press the enter button. • "Now PMA Rec" is displayed and the registration is completed. • The music calendar display of the selected track number is switched off.

• The total track number and total time displays do not change even if tracks are set to be skipped.

(5) Cancelling the registration of tracks to which you do not wish to listen

★ When erasing a finalized CD-RW disc, first unfinalize the disc.

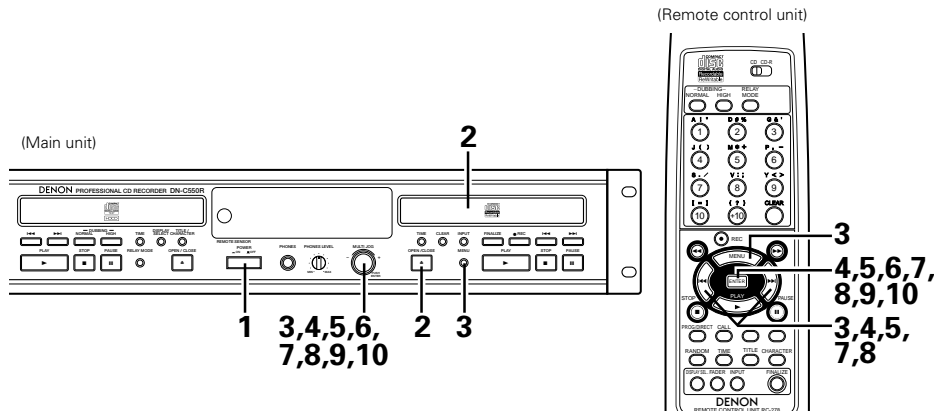

1	Switch on the power.
2	Load the CD-R/RW disc for which you want to cancel the settings of undesired tracks.
3	Press the MENU button, turn the jog dial of the main unit or press the automatic search button of the remote control, and select the CD-R/RW edit mode. • "CD-R/RW Edit?" is displayed.
4	Press the enter button, turn the jog dial of the main unit or press the automatic search button of the remote control, and select the skip track setting mode. • "Skip Track?" is displayed.
5	Now, press the enter button, turn the jog dial of the main unit or press the automatic search button of the remote control, and select the skip track setting cancellation mode. • "Skip Clear?" is displayed.
6	Press the enter button. • "S.Clear --Tr" is displayed.
7	Turn the jog dial of the main unit or press the automatic search button of the remote control, and select the track you want to cancel. Press the enter button and set. • The music calendar display of the selected track number will flash.
8	Repeat Step 7 to add another cancellation.
9	Press the enter button during the "S.Clear --Tr" display. • "SkipClearOK?" is displayed.
10	Press the enter button. • "Now PMA Rec" is displayed and the registration is completed.

NOTES:

- Finalizing the disc when tracks to which you do not want to listen have been registered, results in the skip play mode automatically being switched on.
- Skip play is not possible on CD players that lack a skip play function.
- Tracks to which you do not want to listen can be registered/cancelled 21 times.
- Program play and random play are not possible when there has been registration of tracks to which you do not want to listen. (Programmed and random playback are possible once finalization is performed.)
- It is not possible to register or cancel tracks you do not want to hear with store-bought CDs or CD-R/RW discs that have been finalized.

2. Text editings

■ Up to 23 characters can be input for the track and disc titles.

(1) Adding disc titles

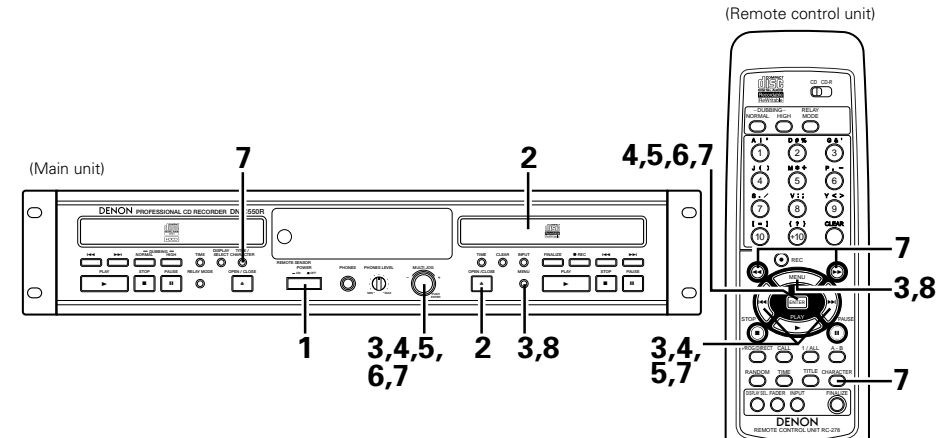

1	Switch on the power.
2	Load the CD-R/RW disc to which the disc name will be affixed.
3	Press the MENU button, turn the jog dial of the main unit or press the automatic search button of the remote control, and select the TEXT edit mode. • "Text Edit?" is displayed.
4	Press the enter button, turn the jog dial of the main unit or press the automatic search button of the remote control to display "Text In?".
5	Now, press the enter button, turn the jog dial of the main unit or press the automatic search button of the remote control to display "Disc Title?".
6	Press the ENTER button. • The cursor flashes, indicating the title input standby mode.

Input the title.



- Either turn the jog dial on the main unit or use the automatic search buttons (◀◀ and ▶▶) on the remote control unit to select the desired character.
- Some characters that can be input on the DN-C550R cannot be displayed on other models.



- The shape of the cursor changes each time the CHARACTER button is pressed.



[Explanation of cursor:]

Capital letter/number input mode
 Special character input mode

Small letter/number input mode

[Available characters and numbers]

Capital letter/number input mode:
 ABCDEFGHIJKLMNOPQRSTUVWXYZ0123456789

Small letter/number input mode:
 abcdefghijklmnopqrstuvwxyz0123456789

Special character input mode:
 SPACE _ ! " # \$ % & ' () * + , - . / : ; < = > ? @ [\] ^ _ ` { | } ~

- When the manual search forward button (▶▶) or the ENTER button is pressed, the selected character is set, and the unit is set to the input standby mode for the next character.
- The cursor can be moved back by pressing the manual search reverse button (◀◀). Use this to correct input characters.

7 Press the MENU button to enter the input title.

- To erase a character, move the cursor to that character then press the CLEAR button.
- To correct a character, first erase it, then input the correct character.

* Turn the jog dial to input numbers or special characters not on the number keys or the +10 key.

[Example:]
 To input “%” using the number keys on the remote control unit, press button 2 twice in the special character input mode.

Button	Capital letter input mode	Small letter input mode	Special character input mode
1	ABC	abc	! " ' () * + , - . / : ; < = > ? @ [\] ^ _ ` { } ~
2	DEF	def	# %
3	GHI	ghi	& ' () * + , - . / : ; < = > ? @ [\] ^ _ ` { } ~
4	JKL	jkl	() * + , - . / : ; < = > ? @ [\] ^ _ ` { } ~
5	MNO	mno	* +
6	PQR	pqr	, -
7	STU	stu	. /
8	VWX	vwx	: ;
9	YZ	yz	< >
10	-	-	[=]
+10	-	-	{ ? }

(2) Adding track titles

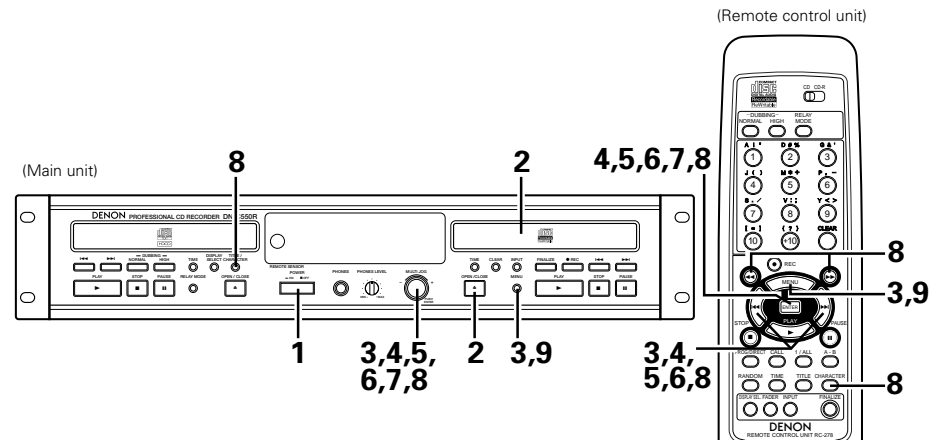

1	Switch on the power.
2	Load the CD-R/RW disc to which the track name will be affixed.
3	Press the MENU button, turn the jog dial of the main unit or press the automatic search button of the remote control, and select the TEXT edit mode. • “Text Edit?” is displayed.
4	Press the enter button, turn the jog dial of the main unit or press the automatic search button of the remote control to display “Text In?”.
5	Now, press the enter button, turn the jog dial of the main unit or press the automatic search button of the remote control to display “Track Title?”.
6	Press the enter button again, turn the jog dial of the main unit or press the automatic search button of the remote control, and select the track to which you would like to affix a track name. • “**Tr Title?” is displayed.
7	Press the ENTER button. • The cursor flashes, indicating the title input standby mode.
8	Input the title. • For instructions on inputting titles, see step 7 under “(1) Adding disc titles” on Page 31.
9	Press the MENU button to enter the input track title.

NOTES:

- Text editing is not possible with commercial audio CDs or with finalized CD-R/RW discs.
- A maximum of 23 characters can be stored per item. Approximately 900 characters can be input per disc.
- Entered text information is not written to the disc until the disc is finalized.
- Even when the power source is disconnected, the text information is stored for 2 to 3 days after being entered when the disc has not been finalized. This text information might be lost if the unit is disconnected from the power source for a long time.

(3) Erasing disc titles

★ For finalized CD-RW discs, first unfinalize.

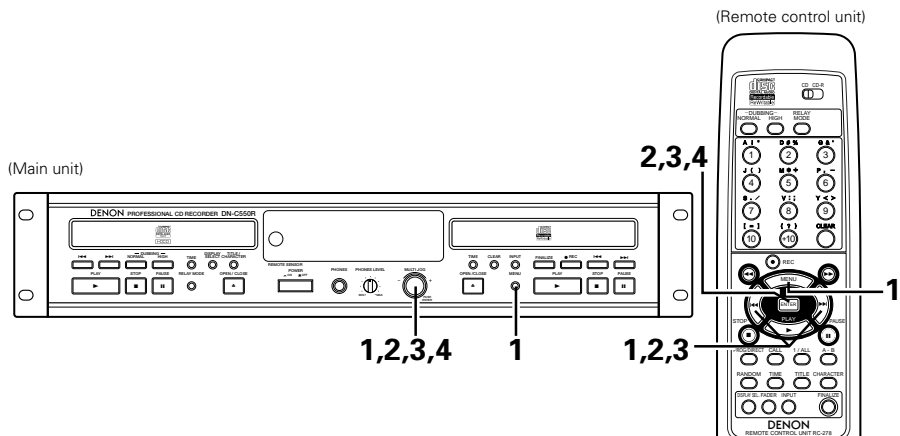

1	Press the MENU button, turn the jog dial of the main unit or press the automatic search button of the remote control, and select the TEXT edit mode. • "Text Edit?" is displayed.
2	Press the enter button, turn the jog dial of the main unit or press the automatic search button of the remote control to display "Text Erase?".
3	Now, press the enter button, turn the jog dial of the main unit or press the automatic search button of the remote control to display "Disc Title?".
4	Press the enter button to define the erasure of the disc name. • "Complete" is displayed.

(4) Erasing track titles

★ For finalized CD-RW discs, first unfinalize.

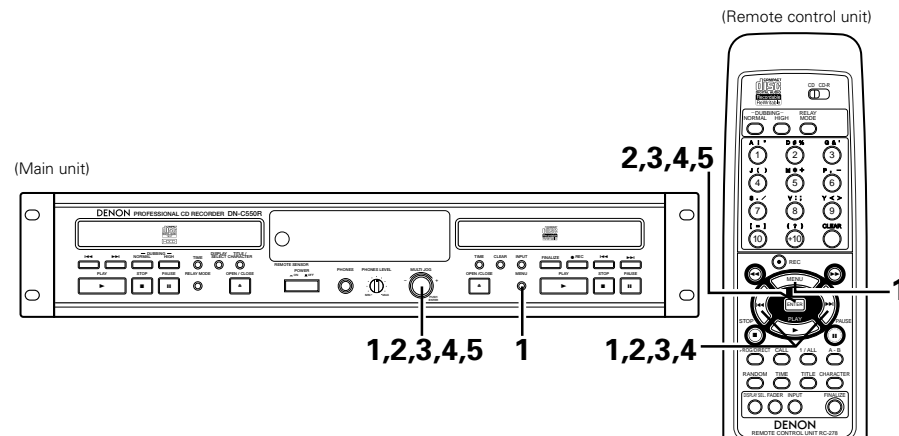

1	Press the MENU button, turn the jog dial of the main unit or press the automatic search button of the remote control, and select the TEXT edit mode. • "Text Edit?" is displayed.
2	Press the enter button, turn the jog dial of the main unit or press the automatic search button of the remote control to display "Text Erase?".
3	Now, press the enter button, turn the jog dial of the main unit or press the automatic search button of the remote control to display "Track Title?".
4	Press the enter button again, turn the jog dial of the main unit or press the automatic search button of the remote control, and select the track for which the track name will be erased. • "**Tr Title?" is displayed.
5	Press the enter button to define the erasure of the disc name. • "Complete" is displayed.

(5) Erasing all the track titles and the disc title

★ For finalized CD-RW discs, first unfinalize.

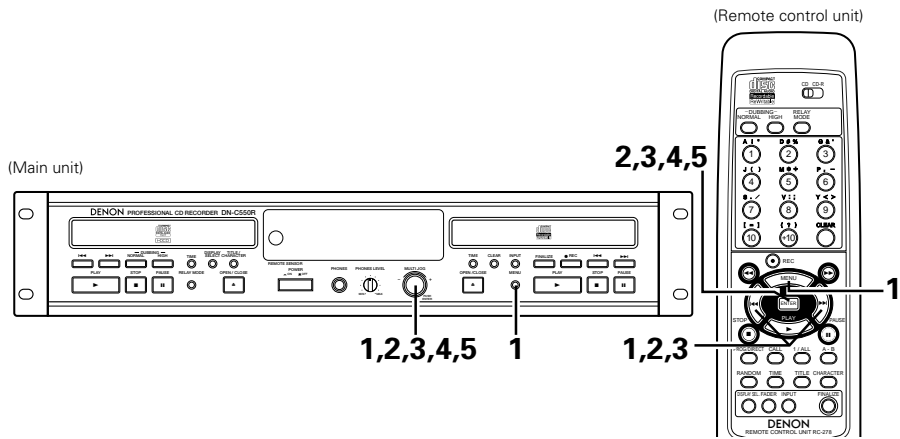

1	Press the MENU button, turn the jog dial of the main unit or press the automatic search button of the remote control, and select the TEXT edit mode. • "Text Edit?" is displayed.
2	Press the enter button, turn the jog dial of the main unit or press the automatic search button of the remote control to display "Text Erase?".
3	Now, press the enter button, turn the jog dial of the main unit or press the automatic search button of the remote control to display "All Erase?".
4	Press the enter button. • "Erase OK?" is displayed.
5	Press the enter button to define the one erasure. • "Complete" is displayed.
NOTE: • Erasure of text is not possible with commercial audio CDs or with finalized CD-R/RW discs.	

16 MENU MODE

- When the MENU button is pressed, the menu mode is set and the set can be operated as shown on the diagram below.
- Close the disc trays and set the stop mode for both the CD and CD-R sections.
- "*" indicates default values.
- Turn the jog dial clockwise to proceed to the "↓" display indicator. Press the ENTER button to proceed to the "→" display indicator.

MENU MODE

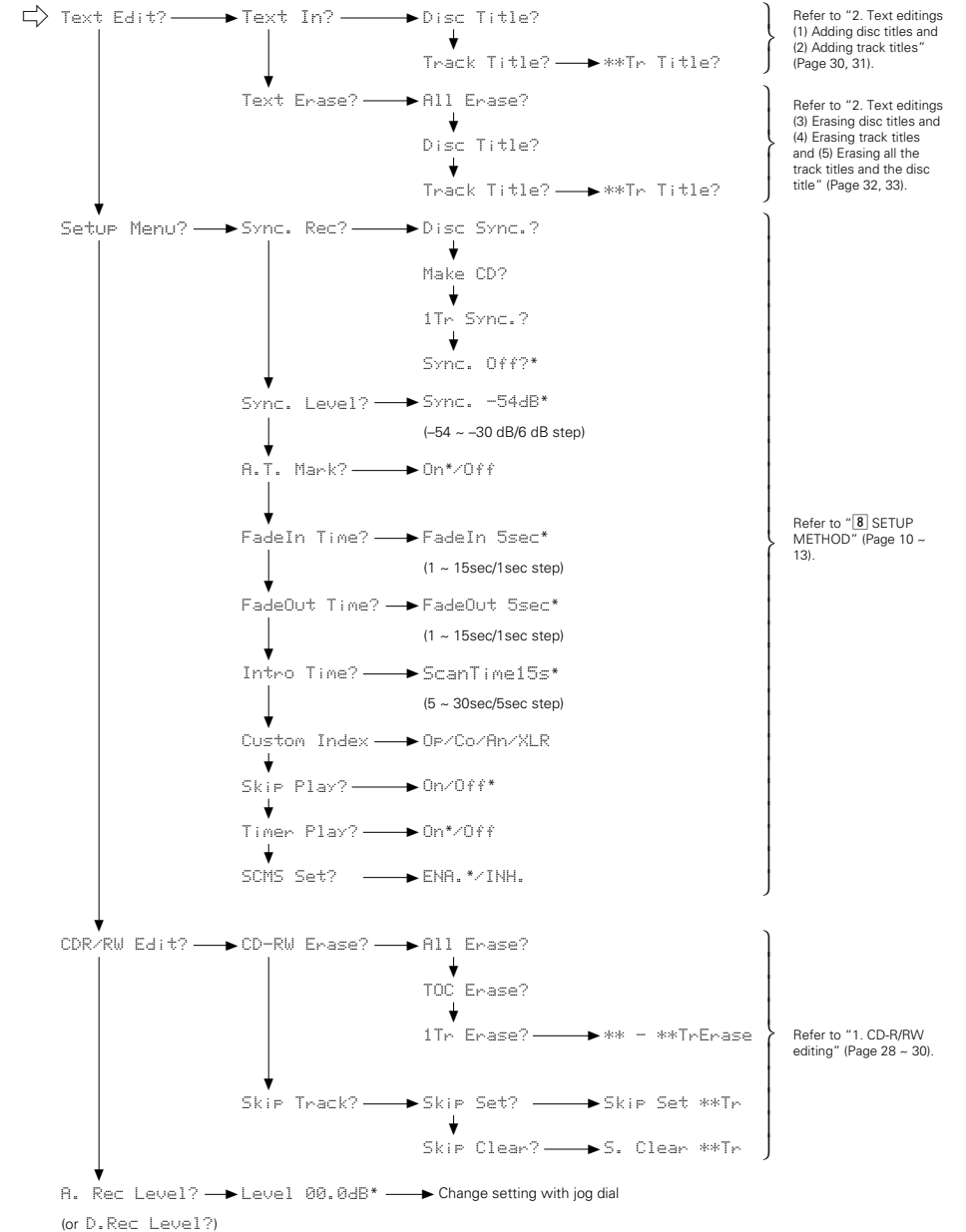

17 MESSAGES

Messages may appear on the display while using the DN-C550R. The meanings of these messages are explained below.

Message	Meaning
TOC Reading	Reading disc information.
Open	During tray opening.
Close	During tray closing.
No Disc	No disc inserted, disc unreadable or disc inserted upside down.
Now PMA Rec	Updating disc contents.
Disc Full	No more recording possible.
Copy Prohibit	No digital recording can be made of the connected source. See "Digital Copies (SCMS)" on Page 6. Data signals other than audio signals have been input. These signals are not recorded.
Finalize *,**	Time countdown when finalizing a disc.
PlaybackOnly	When trying to record on a finalized CD-R or a prerecorded CD.
Now OPC	During laser power calibration for unfinalized discs.
OPC Error	OPC failure during OPC procedure (OPC = Optimum Power Calibration)
Rec Error	An error has occurred during recording.
Disc Error	Recording or finalization is not possible due to a disc fault.
Blank Disc	When attempting to edit text for a disc which has no tracks.
No Name	No text stored for disc.
Sync. -**dB	Setting value of the synchro recording starting level.
Dig.Unlock	There is an incomplete connection of the digital input jack during digital input recording, or the input signal is not being input properly due to some other factor.

Message	Meaning
Name Full	23 text characters have already been input or a total of 900 characters have already been input.
Mecha Error	Disc is not operating properly.
All Skip Tr	Skip is set for all tracks.
Complete	Mode reception has been completed.
TextEraseOK?	If the disc is removed, all the text information is cleared.
CD-R Short	The recordable time on the disc is shorter than the time of the recording source you are trying to copy.
Text Protect	The text information is copy-protected so the text cannot be copied in the copy mode.
Now Tr Check	The CD side track information is being checked.
REC Standby	During REC standby.
UseAudioDisc	Recording is not possible because the recording source or the disc you have attempted to record contains non-audio signals.

("**" indicates a letter or character.)

18 TROUBLESHOOTING

Check Again Before Assuming The Player is Malfunctioning

- Are all the connections correct ?
- Are you following the instructions in the manual ?
- Are the amplifier and speakers operating properly ?

If the DN-C550R does not seem to be functioning properly, check the table below. If this does not solve the problem, the DN-C550R may be damaged. Turn off the power, unplug the power cord from the power outlet, and contact your store of purchase or nearest DENON sales office.

Symptom	Check	Page
No power.	<ul style="list-style-type: none"> • Ensure that the POWER button is on. • Ensure that the mains cable is plugged in correctly. 	7 -
Auto track does not work.	<ul style="list-style-type: none"> • Check if auto track is selected. • Check if there are 3 seconds silence in between the tracks. • Check if the source is a consumer source with the digital output according to the IEC audio standard. 	11 6 -
No sound.	<ul style="list-style-type: none"> • Check the audio connections. • If using an amplifier, try using a different source. 	- -
Amplifier sound is distorted.	<ul style="list-style-type: none"> • Check that the CD recorder analog output is not connected to the amplifier Phono input. 	-
Play will not start.	<ul style="list-style-type: none"> • Ensure that the label of the CD is facing up. • Clean the disc. 	10 6
Remote control does not work.	<ul style="list-style-type: none"> • Point the remote control directly at the CD recorder. • Check the batteries and replace if necessary. 	9 9
Will not record.	<ul style="list-style-type: none"> • Clean the disc. • Check if CD-R is an unfinalized disc. • Check that the disc is recordable and replace if necessary. • Check whether there is time remaining on the disc. ("D i s c F u l l" is displayed.) • Check whether there is an attempt to digitally record a digitally recorded source. ("C o p y P r o h i b i t" is displayed.) • Check whether the recording level adjustment is suitable. • Wrong input source chosen. 	6 - 5 7 6 16 8
Recording is distorted.	<ul style="list-style-type: none"> • Make sure the recording level is correct. 	16
10 second pause between recordings.	<ul style="list-style-type: none"> • See setting the synchro recording level. 	11
"D i s c E r r o r" on the display.	<ul style="list-style-type: none"> • If then appears on the display, the disc cannot be recorded further, and cannot be finalized. But it can still be played on the CD recorder or another CD recorder. "D i s c E r r o r" 	-
A recorded CD-R disc cannot be played on another player or CD unit.	<ul style="list-style-type: none"> • Finalize the disc. • Is playback possible on another CD player? If so, clean the pickup of the player on which the disc could not be played. • CD-R discs cannot be played on some CD players. 	6, 27 - -
Copying, recording, finalize and editing of CD-R/RW is not possible.	<ul style="list-style-type: none"> • Is the relay mode set to "RELAY" or "MIX"? Switch to "SINGLE" or "DUAL". 	24
Menu mode cannot be set. Finalizing is not possible.	<ul style="list-style-type: none"> • Is the disc tray for the CD or CD-R section open? Close the disc trays for both the CD and CD-R sections. • Is the CD or CD-R section operating? Set the stop mode for both the CD and CD-R sections. 	27, 33 27, 33

19 MAIN SPECIFICATIONS

■ Audio:	CD unit: CD-R unit (for digital editing)
Frequency response:	2 Hz to 20 kHz: 2 Hz to 20 kHz
Dynamic range:	98 dB: 88 dB
S/N ratio:	105 dB: 100 dB
Harmonic distortion:	0.003 % (1 kHz): 0.01 % (1 kHz)
Wow & flutter:	Below measurable limits (±0.001 % W. peak)
Analog output (UNBALANCED)	
Transfer and connector:	Unbalanced, RCA jack
Output level:	1.7 Vrms, 10 kΩ/kohms
Headphone output:	0.3 mW (32 Ω/ohms)
Analog input (UNBALANCED)	
Transfer and connector:	Unbalanced, RCA jack
Input level:	1.7 Vrms, 47 kΩ/kohms
Analog input (BALANCED)	
Transfer and connector:	Balanced active, XLR connector (1. Common 2. Hot 3. Cold)
Input level:	+18 dBs, 10 kΩ/kohms
Digital output (COAXIAL)	
Transfer and connector:	Unbalanced, RCA jack
Signal format:	SPDIF or IEC-958 Type II
Digital output (OPTICAL)	
Signal format:	SPDIF or IEC-958 Type II
Digital input (COAXIAL)	
Transfer and connector:	Unbalanced, RCA jack
Signal format:	SPDIF or IEC-958 Type II
Digital input (OPTICAL)	
Signal format:	SPDIF or IEC-958 Type II
■ Usable discs:	CDs (12 cm/8 cm) CD-R/RW Discs (CD-R unit)
■ General:	
Power supply:	AC 120 V, 60 Hz
Power consumption:	29 W
Maximum external dimensions:	482 (width) x 88 (height) x 315 (depth) mm (Not including feet, knobs and terminals)
Mass:	6.3 kg
■ Remote control unit:	RC-278
Remote control system:	Infrared pulse
Power supply:	DC 3 V, using two R6P (AA) batteries

* Design and specifications are subject to change without notice in the course of product improvement.

Free Manuals Download Website

<http://myh66.com>

<http://usermanuals.us>

<http://www.somanuals.com>

<http://www.4manuals.cc>

<http://www.manual-lib.com>

<http://www.404manual.com>

<http://www.luxmanual.com>

<http://aubethermostatmanual.com>

Golf course search by state

<http://golfingnear.com>

Email search by domain

<http://emailbydomain.com>

Auto manuals search

<http://auto.somanuals.com>

TV manuals search

<http://tv.somanuals.com>