

DENON

HOME THEATER SYSTEM DHT-M330DV

OPERATING INSTRUCTIONS BEDIENUNGSANLEITUNG MODE D'EMPLOI ISTRUZIONI PER L'USO INSTRUCCIONES DE OPERACION GEBRUIKSAANWIJZING BRUKSANVISNING

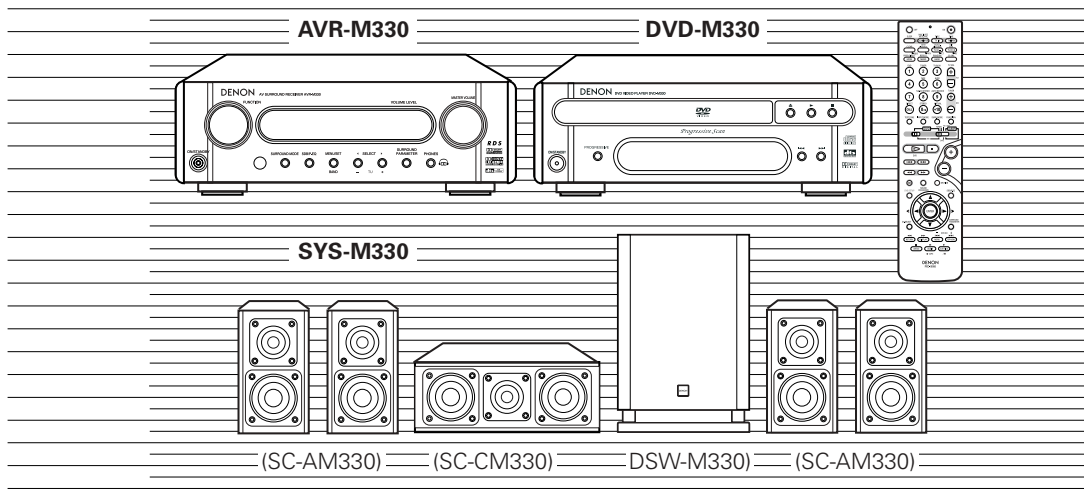

- DVD-M330(DVD PLAYER): Please refer to the operating Instructions of the DVD-M330.
- DVD-M330 (DVD-PLAYER): Bitte beziehen Sie sich auf die Bedienungsanleitung des DVD-M330.
- DVD-M330 (LECTEUR DVD): Veuillez vous référer au mode d'emploi du DVD-M330.
- DVD-M330 (LETTORE DVD): Fare riferimento al manuale delle istruzioni del modello DVD-M330.
- DVD-M330 (REPRODUCATOR DVD): Consulte las instrucciones de funcionamiento del DVD-M330.
- DVD-M330 (DVD-SPELER): Zie de gebruiksaanwijzing van de DVD-M330.
- DVD-M330 (DVD-SPELARE): Läs bruksanvisningen till DVD-M330.

FOR ENGLISH READERS
FÜR DEUTSCHE LESER
POUR LES LECTEURS FRANCAIS
PER IL LETTORE ITALIANO
PARA LECTORES DE ESPAÑOL
VOOR NEDERLANDSTALIGE LEZERS
FOR SVENSKA LÄSARE

PAGE 4 ~ PAGE 57
SEITE 58 ~ SEITE 111
PAGE 112 ~ PAGE 165
PAGINA 166 ~ PAGINA 219
PAGINA 220 ~ PAGINA 273
PAGINA 274 ~ PAGINA 327
SIDA 328 ~ SIDA 381



CAUTION
RISK OF ELECTRIC SHOCK
DO NOT OPEN



CAUTION: TO REDUCE THE RISK OF ELECTRIC SHOCK, DO NOT REMOVE COVER (OR BACK). NO USER SERVICEABLE PARTS INSIDE. REFER SERVICING TO QUALIFIED SERVICE PERSONNEL.



The lightning flash with arrowhead symbol, within an equilateral triangle, is intended to alert the user to the presence of uninsulated "dangerous voltage" within the product's enclosure that may be of sufficient magnitude to constitute a risk of electric shock to persons.



The exclamation point within an equilateral triangle is intended to alert the user to the presence of important operating and maintenance (servicing) instructions in the literature accompanying the appliance.

WARNING: TO REDUCE THE RISK OF FIRE OR ELECTRIC SHOCK, DO NOT EXPOSE THIS APPLIANCE TO RAIN OR MOISTURE.

• DECLARATION OF CONFORMITY

We declare under our sole responsibility that this product, to which this declaration relates, is in conformity with the following standards: EN60065, EN55013, EN55020, EN61000-3-2 and EN61000-3-3. Following the provisions of 73/23/EEC, 89/336/EEC and 93/68/EEC Directive.

• ÜBEREINSTIMMUNGSERKLÄRUNG

Wir erklären unter unserer Verantwortung, daß dieses Produkt, auf das sich diese Erklärung bezieht, den folgenden Standards entspricht: EN60065, EN55013, EN55020, EN61000-3-2 und EN61000-3-3. Entspricht den Verordnungen der Direktive 73/23/EEC, 89/336/EEC und 93/68/EEC.

• DECLARATION DE CONFORMITE

Nous déclarons sous notre seule responsabilité que l'appareil, auquel se réfère cette déclaration, est conforme aux standards suivants: EN60065, EN55013, EN55020, EN61000-3-2 et EN61000-3-3. D'après les dispositions de la Directive 73/23/EEC, 89/336/EEC et 93/68/EEC.

• DICHIARAZIONE DI CONFORMITÀ

Dichiariamo con piena responsabilità che questo prodotto, al quale la nostra dichiarazione si riferisce, è conforme alle seguenti normative: EN60065, EN55013, EN55020, EN61000-3-2 e EN61000-3-3. In conformità con le condizioni delle direttive 73/23/EEC, 89/336/EEC e 93/68/EEC. QUESTO PRODOTTO E' CONFORME AL D.M. 28/08/95 N. 548

• DECLARACIÓN DE CONFORMIDAD

Declaramos bajo nuestra exclusiva responsabilidad que este producto al que hace referencia esta declaración, está conforme con los siguientes estándares: EN60065, EN55013, EN55020, EN61000-3-2 y EN61000-3-3. Siguiendo las provisiones de las Directivas 73/23/EEC, 89/336/EEC y 93/68/EEC.

• EENVORMIGHEIDSVKLAARING







Wij verklaren uitsluitend op onze verantwoordelijkheid dat dit product, waarop deze verklaring betrekking heeft, in overeenstemming is met de volgende normen: EN60065, EN55013, EN55020, EN61000-3-2 en EN61000-3-3. Volgens de bepalingen van de Richtlijnen 73/23/EEC, 89/336/EEC en 93/68/EEC.

• ÖVERENSSTÄMMELSESINTYG

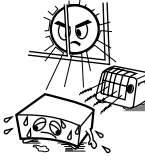
Härmed intygas helt på eget ansvar att denna produkt, vilken detta intyg avser, uppfyller följande standarder: EN60065, EN55013, EN55020, EN61000-3-2 och EN61000-3-3. Enligt stadgarna i direktiv 73/23/EEC, 89/336/EEC och 93/68/EEC.

ATTENZIONE: QUESTO APPARECCHIO E' DOTATO DI DISPOSITIVO OTTICO CON RAGGIO LASER. L'USO IMPROPRIO DELL'APPARECCHIO PUO' CAUSARE PERICOLOSE ESPOSIZIONI A RADIAZIONI!!

NOTE ON USE / HINWEISE ZUM GEBRAUCH / OBSERVATIONS RELATIVES A L'UTILISATION / NOTE SULL'USO / NOTAS SOBRE EL USO / ALVORENS TE GEBRUIKEN / OBSERVERA

 <ul style="list-style-type: none"> • Avoid high temperatures. Allow for sufficient heat dispersion when installed on a rack. • Vermeiden Sie hohe Temperaturen. Beachten Sie, daß eine ausreichend Luftzirkulation gewährleistet wird, wenn das Gerät auf ein Regal gestellt wird. • Éviter des températures élevées. Zорг compte d'une dispersion de chaleur suffisante lors de l'installation sur une étagère. • Evitate di esporre l'unità a temperature alte. Assicuratevi che ci sia un'adeguata dispersione del calore quando installate l'unità in un mobile per componenti audio. • Evite altas temperaturas. Permite la suficiente dispersión del calor cuando está instalado en la consola. • Vermijd hoge temperaturen. • Zorg voor een degelijk hitteafvoer indien het apparaat op een rek wordt geplaatst. • Undvik höga temperaturer. Se till att det finns möjlighet till god värmeavledning vid montering i ett rack. 	 <ul style="list-style-type: none"> • Keep the set free from moisture, water, and dust. • Halten Sie das Gerät von Feuchtigkeit, Wasser und Staub fern. • Protéger l'appareil contre l'humidité, l'eau et la poussière. • Tenete l'unità lontana dall'umidità, dall'acqua e dalla polvere. • Mantenga el equipo libre de humedad, agua y polvo. • Laat geen vochtigheid, water of stof in het apparaat binnendingen. • Utsätt inte apparaten för fukt, vatten och damm. 	 <ul style="list-style-type: none"> • Do not let foreign objects in the set. • Keine fremden Gegenstände in das Gerät kommen lassen. • Ne pas laisser des objets étrangers dans l'appareil. • E' importante che nessun oggetto è inserito all'interno dell'unità. • No deje objetos extraños dentro del equipo. • Laat geen vreemde voorwerpen in dit apparaat vallen. • Se till att främmande föremål inte tränger in i apparaten.
 <ul style="list-style-type: none"> • Handle the power cord carefully. Hold the plug when unplugging the cord. • Gehen Sie vorsichtig mit dem Netzkabel um. Halten Sie das Kabel am Stecker, wenn Sie den Stecker herausziehen. • Manipuler le cordon d'alimentation avec précaution. Tenir la prise lors du débranchement du cordon. • Maneggiate il filo di alimentazione con cura. Agite per la spina quando scollegate il cavo dalla presa. • Maneje el cordón de energía con cuidado. Sostenga el enchufe cuando desconecte el cordón de energía. • Hanteer het netsnoer voorzichtig. Houd het snoer bij de stekker vast wanneer deze moet worden aan- of losgekoppeld. • Hantera nätkabeln varsamt. Håll i kabeln när den kopplas från el-uttaget. 	 <ul style="list-style-type: none"> • Unplug the power cord when not using the set for long periods of time. • Wenn das Gerät eine längere Zeit nicht verwendet werden soll, trennen Sie das Netzkabel vom Netzstecker. • Débrancher le cordon d'alimentation lorsque l'appareil n'est pas utilisé pendant de longues périodes. • Disinnestate il filo di alimentazione quando avete l'intenzione di non usare il filo di alimentazione per un lungo periodo di tempo. • Desconecte el cordón de energía cuando no utilice el equipo por mucho tiempo. • Neem altijd het netsnoer uit het stopcontact wanneer het apparaat gedurende een lange periode niet wordt gebruikt. • Koppla ur nätkabeln om apparaten inte kommer att användas i lång tid. 	 <ul style="list-style-type: none"> • Do not let insecticides, benzene, and thinner come in contact with the set. • Lassen Sie das Gerät nicht mit Insektiziden, Benzin oder Verdünnungsmitteln in Berührung kommen. • Ne pas mettre en contact des insecticides, du benzène et un diluant avec l'appareil. • Assicuratevi che l'unità non venga in contatto con insetticidi, benzolo o solventi. • No permita el contacto de insecticidas, gasolina y diluyentes con el equipo. • Laat geen insektenverdelgende middelen, benzine of ververdunner met dit apparaat in contact komen. • Se till att inte insektsmedel på spraybruk, bensen och thinner kommer i kontakt med apparatens hölje.
 <ul style="list-style-type: none"> • Handle the power cord carefully. Hold the plug when unplugging the cord. • Gehen Sie vorsichtig mit dem Netzkabel um. Halten Sie das Kabel am Stecker, wenn Sie den Stecker herausziehen. • Manipuler le cordon d'alimentation avec précaution. Tenir la prise lors du débranchement du cordon. • Maneggiate il filo di alimentazione con cura. Agite per la spina quando scollegate il cavo dalla presa. • Maneje el cordón de energía con cuidado. Sostenga el enchufe cuando desconecte el cordón de energía. • Hanteer het netsnoer voorzichtig. Houd het snoer bij de stekker vast wanneer deze moet worden aan- of losgekoppeld. • Hantera nätkabeln varsamt. Håll i kabeln när den kopplas från el-uttaget. 	 <ul style="list-style-type: none"> • (For sets with ventilation holes) • Do not obstruct the ventilation holes. • Die Belüftungsöffnungen dürfen nicht verdeckt werden. • Ne pas obstruer les trous d'aération. • Non coprite i fori di ventilazione. • No obstruya los orificios de ventilación. • De ventilatieopeningen mogen niet worden geblokkeerd. • Täpp inte till ventilationsöppningarna. 	 <ul style="list-style-type: none"> • Never disassemble or modify the set in any way. • Versuchen Sie niemals das Gerät auseinander zu nehmen oder auf jegliche Art zu verändern. • Ne jamais démonter ou modifier l'appareil d'une manière ou d'une autre. • Non smontate mai, nè modificate l'unità in nessun modo. • Nunca desarme o modifique el equipo de ninguna manera. • Nooit dit apparaat demonteren of op andere wijze modifieren. • Ta inte isär apparaten och försök inte bygga om den.

CAUTION

- The ventilation should not be impeded by covering the ventilation openings with items, such as newspapers, table-cloths, curtains, etc.
- No naked flame sources, such as lighted candles, should be placed on the apparatus.
- Please be care the environmental aspects of battery disposal.
- The apparatus shall not be exposed to dripping or splashing for use.
- No objects filled with liquids, such as vases, shall be placed on the apparatus.

■ INTRODUCTION

Thank you for choosing the DENON DHT-M330DV HOME THEATER SYSTEM. This remarkable component has been engineered to provide superb surround sound listening with home theater sources such as DVD, as well as providing outstanding high fidelity reproduction of your favourite music sources.

As this product is provided with an immense array of features, we recommend that before you begin hookup and operation that you review the contents of this manual before proceeding.

■ We greatly appreciate your purchase of this unit.
■ To be sure you take maximum advantage of all the features this unit has to offer, read these instructions carefully and use the set properly. Be sure to keep this manual for future reference should any questions or problems arise.

“SERIAL NO. _____

PLEASE RECORD UNIT SERIAL NUMBER ATTACHED TO THE REAR OF THE CABINET FOR FUTURE REFERENCE”

TABLE OF CONTENTS

1 BEFORE USING5	11 LISTENING TO THE RADIO.....42~46
2 CAUTIONS ON INSTALLATION5, 6	12 EXPANDING TO A 6.1- OR 7.1-CHANNEL SYSTEM47, 48
3 CAUTIONS ON HANDLING6	13 DOLBY / DTS SURROUND.....49~52
4 FEATURES.....6	14 USING THE SLEEP TIMER53
5 CONNECTIONS7~14	15 SYSTEM FUNCTIONS.....54
6 PART NAMES AND FUNCTIONS15~18	16 LAST FUNCTION MEMORY55
7 REMOTE CONTROL UNIT.....19~26	17 INITIALIZATION OF THE MICROPROCESSOR55
8 SETTING UP THE SYSTEM27~28	18 TROUBLESHOOTING56
9 OPERATING THE SURROUND FUNCTIONS.....29~32	19 SPECIFICATIONS57
10 SURROUND PLAYBACK.....33~41	

■ ACCESSORIES

Check that the following parts are included in addition to the main unit:

- | | | |
|---------------------------------|-------------------------------|---------------------------------------|
| ① Operating instructions1 | ② Service station list1 | ③ Remote control unit (RC-996)1 |
| ④ R6P/AA batteries2 | ⑤ AM loop antenna1 | ⑥ FM indoor antenna1 |
| ⑦ Optical cable1 | | |



- | | |
|---|---|
| 8 Cord A2
(Used to connect the Speakers)
(Length: Approx. 10 meters) | 9 Cord B.....1
(Used to connect the Speakers)
(Length: Approx. 3 meters) |
|---|---|



1 BEFORE USING

Pay attention to the following before using this unit:

- **Moving the set**
To prevent short circuits or damaged wires in the connection cords, always unplug the power cord and disconnect the connection cords between all other audio components when moving the set.
- **Before turning the power switch on**
Check once again that all connections are proper and that there are not problems with the connection cords. Always set the power switch to the standby position before connecting and disconnecting connection cords.

- **Store this instructions in a safe place.**
After reading, store this instructions along with the warranty in a safe place.
- **Note that the illustrations in this instructions may differ from the actual set for explanation purposes.**

For heat dispersal, leave at least 10 cm/4 inch of space between the top, back and sides of this unit and the wall or other components.

2 CAUTIONS ON INSTALLATION

(1) AV SURROUND RECEIVER (AVR-M330)

Noise or disturbance of the picture may be generated if this unit or any other electronic equipment using microprocessors is used near a tuner or TV.

If this happens, take the following steps:

- Install this unit as far as possible from the tuner or TV.
- Set the antenna wires from the tuner or TV away from this unit's power cord and input/output connection cords.
- Noise or disturbance tends to occur particularly when using indoor antennas or 300 Ω/ohms feeder wires. **We recommend using outdoor antennas and 75 Ω/ohms coaxial cables.**

(2) SPEAKER SYSTEM (SYS-M330)

When installing, carefully examine the place and method of installation for safety.

When using a stand, brackets, etc., follow the instructions included with the stand or brackets and check for safety before installing and using. Denon will accept no responsibility for damages or accidents caused by the unit falling.

The quality of the sound produced from the speaker system is affected by the size and type (Japanese or Western) of the room, as well as by the method of installation. Consider the points listed below before installing the speaker system.

- Note that placing the speaker system on the same stand or shelf as a record player may result in howling.
- If there is a wall, glass door, etc., directly in front of or behind the speaker system, cover the wall or door with a thick curtain to prevent resonance and reflection.
- The SYS-M330 speaker systems are of the low-leakage-flux type and can be used near televisions, but depending on the TV there may be color blotching on the picture. If this happens, turn off the TV's power, wait 15 to 30 minutes, then turn the TV's power back on. The TV's automatic degaussing circuit should reduce the blotching on the picture. If blotching persists, move the speaker further away.
- Set the center speaker (SC-CM330) so that its front surface is facing upwards or downwards, according to the place of installation. We recommend setting it so that the front surface is facing downwards when installed at a position above the ears, upwards when installed on the floor. Use the included pedestal to adjust the angle of installation as shown on the diagram at the right.
- When mounting the satellite speaker system (SC-AM330) on a stand or bracket, M5 nuts are inserted into the bottom of the satellite speaker system (SC-AM330) at intervals of 60 mm. When mounting, following the instructions in the manual included with the speaker stand or ceiling mount bracket, and be sure to install properly and securely.

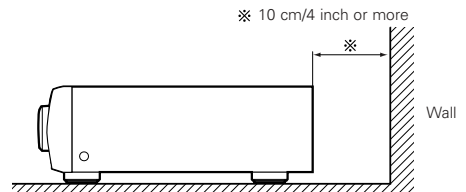
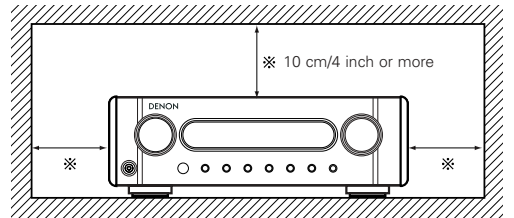

[Example of installation]

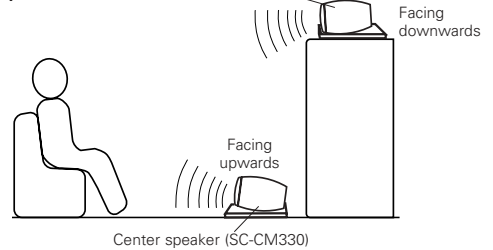

[Rear of front/surround speaker (SC-AM330)]

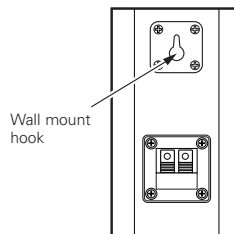

[Bottom of front/surround speaker (SC-AM330)]

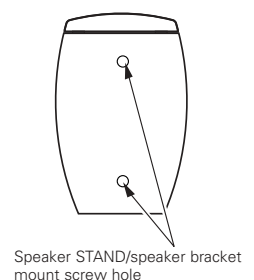

CAUTION:

- To ensure safety, do not place any objects on top or lean objects against the speaker system.
- The speaker may topple down or fall if force is applied to the sides. Be particularly careful to avoid this, as this could cause injury or other serious accidents.

WARNING:

- When installing the speaker systems on the ceiling or wall, to ensure safety, have specialists do the installation work.
- Be sure to fasten the speaker cords to a wall, etc., to prevent people from tripping over them or otherwise pulling on them accidentally, causing the speaker systems to fall.
- Be sure to check for safety after installing the speaker systems. Afterwards, perform safety inspections at regular intervals to be sure there is no danger that the speaker systems will fall. Denon will accept no responsibility for damages or accidents caused by inappropriate choice of the place of installation or improper installation procedures.

3 CAUTIONS ON HANDLING**(1) AV SURROUND RECEIVER (AVR-M330)****• Switching the input function when input jacks are not connected**

A clicking noise may be produced if the input function is switched when nothing is connected to the input jacks. If this happens, either turn down the MASTER VOLUME control or connect components to the input jacks.

• Muting of PRE OUT jacks, HEADPHONE jack and SPEAKER terminals

The PRE OUT jacks, HEADPHONE jacks and SPEAKER terminals include a muting circuit. Because of this, the output signals are greatly reduced for several seconds after the power switch is turned on or input function, surround mode or any other-set-up is changed. If the volume is turned up during this time, the output will be very high after the muting circuit stops functioning. Always wait until the muting circuit turns off before adjusting the volume.

• Whenever the power switch is in the STANDBY state, the apparatus is still connected on AC line voltage.

Please be sure to unplug the cord when you leave home for, say, a vacation.

(2) SPEAKER SYSTEM (SYS-M330)

- Note that color blotching may occur on a TV, etc., due to interaction with the speaker system if there is a magnet or an object generating magnetic force nearby.

Examples: (a) When there are magnets on the door of the rack, stand, etc.

(b) When a health device, etc., equipped with magnets is placed nearby.

(c) When toys or other objects using magnets are placed nearby.

- Note that the illustrations in this instructions may differ from the actual set for explanation purposes.

- Be sure to keep the operating instructions.

After reading these operating instructions, store them in a safe place. We also recommend filling in the necessary items on the back cover.

4 FEATURES**1. Dolby Digital**

Using advanced digital processing algorithms, Dolby Digital provides up to 5.1 channels of wide-range, high fidelity surround sound. Dolby Digital is the default digital audio delivery system for DVD.

2. DTS (Digital Theater Systems) and DTS NEO:6

DTS provides up to 5.1 channels of wide-range, high fidelity surround sound, from sources such as laser disc, DVD and specially-encoded music discs.

The AVR-M330 can be also decoded with DTS Neo:6, a surround mode allowing 5.1 channels playback of regular stereo sources.

3. DOLBY PRO LOGIC II Game mode compatibility

In addition to the previously offered Music and Cinema modes, the AVR-M330 also offers a Game mode optimum for games.

4. Dolby Virtual Speaker compatibility

Dolby Virtual Speaker is a proprietary technology of Dolby Laboratories. A high performance digital signal processor enables playback of Dolby Digital and DTS multi-channel surround signals in the Dolby Virtual Speaker mode. Surround sound can be achieved with the Dolby Virtual Speaker mode for CDs and other 2-channel sources in combination with the Dolby Pro Logic II decoder.

5. Remote control unit with preset memory function

The AVR-M330 comes with a remote control unit equipped with a preset memory function including the remote control operation

codes for DVD-M330 DVD player, MD recorders, cassette decks and DENON remote control compatible components as well as the remote control operation codes of other major brands of TVs and video decks.

6. Convenient system functions

When system connections are made with a DVD-M330 DVD player, such system functions as auto function selection, synchronized recording can be performed easily.

7. Equipped with 6.1- and 7.1-channel playback expansion function (surround back channel pre-out connectors)

When the 6.1- or 7.1-channel mode is set with the Quick Setup function, the unit is compatible with decoding of various types of multi-channel formats.

- Dolby Digital EX
- DTS-ES
- Dolby ProLogic IIx

※ A commercially available amplifier and speaker must be connected to the DHT-M330DV's surround back channel pre-out connector in order to achieve 6.1- and 7.1-channel playback.

5 CONNECTIONS

- Do not plug in the AC cord until all connections have been completed.
- Be sure to connect the left and right channels properly (left with left, right with right).
- Insert the plugs securely. Incomplete connections will result in the generation of noise.
- Note that binding pin plug cords together with AC cords or placing them near a power transformer will result in generating hum or other noise.
- Noise or humming may be generated if a connected audio equipment is used independently without turning the power of this unit on. If this happens, turn on the power of this unit.

(1) Speaker system connections

- When connecting, use connection cords A and B included with the DHT-M330DV. The connection cords are color-coded by different colored plugs and labels. Connect in such a way that the colors are the same as the AV surround receiver's speaker terminals.
- Connect the side of the included connection cord with the colored label to the "+" (plus) side.

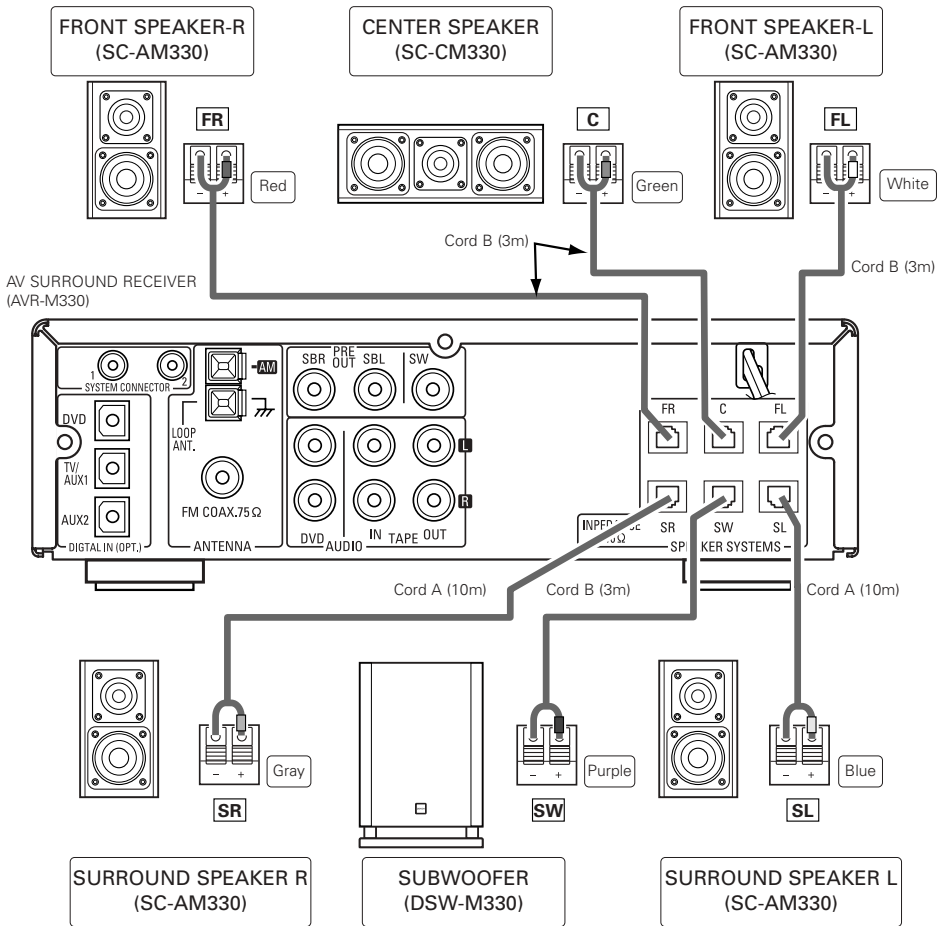

[Description of speaker label]

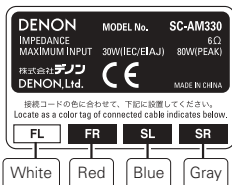

- Use connection cords of the colors corresponding to the position of speaker installation, and connect to the AV surround amplifier.

Precautions when connecting speakers

If a speaker is placed near a TV video monitor, the colors on the screen may be disturbed by the speaker's magnetism. If this should happen, move the speaker away to a position where it does not have this effect.

Be sure to turn the amplifier's power off when connecting the speaker systems.

- Use the included cables to connect the input terminals on the back of the speaker systems (see diagram) to the amplifier's speaker output terminals. Inverting the polarities will result in unnatural sound, with the phase off or no low bass sound.

- Connect the side of the included connection cord with the colored label to the "+" (plus) side.
- Connect connection cords A (10 meters) and B (3 meters) as follows:

To the AVC-M330's speaker terminals To the various speaker terminals

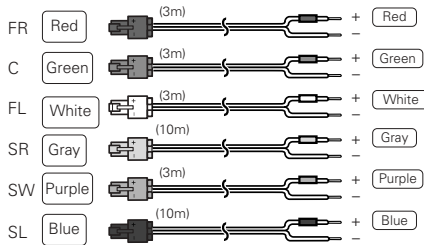

- ① Press the terminal's lever down.
- ② Insert the cord's core wires into the hole.
- ③ Release the lever.

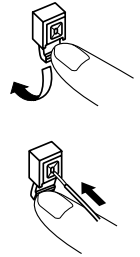

Connecting the speaker cords

Use the included connection cords to connect the input terminals on the backs of the speaker systems (see the diagram) to the AVR-M330's speaker output terminals.

- Insert the connection cords' plugs securely to the back. Incomplete connections will cause noise and malfunction.

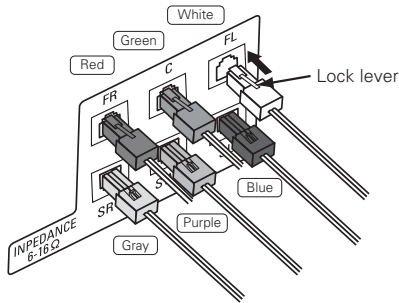

- ① Connect according to the speaker terminals' colors.
- ② Insert the plug securely to the back until a click is heard.
Red, green and white: Raise the lock lever to insert.
Gray, violet and blue: Lower the lock lever to insert.
- ③ To disconnect, press the lock lever and pull out.

Replacing the speaker connection cords

- The speaker connection cords can be replaced, for example when you want to extend the included connection cords.

- Press the release button on the side opposite the lock level to detach the cord from the plug.
- Peel off the sheathing at the tip of the cord you want to replace, and twist firmly so the tip remains tightly wound.
- Pressing the release button, insert the core wires, making sure to match the cord's "+" and "-" polarities with the "+" and "-" sides of the plug.
- Release the release button, then gently pull on the cord to check that it is firmly attached.

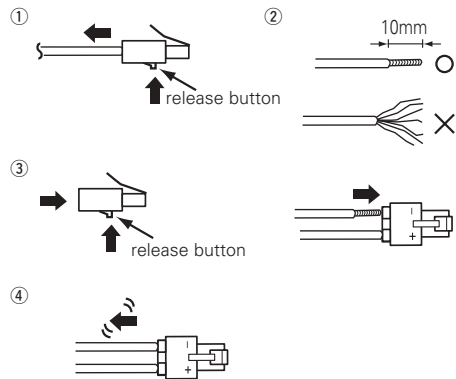

Protector circuit

- The AV surround amplifier (AVC-M330) is equipped with a built-in protection circuit. The purpose of this circuit is to cut off the output to the speakers in order to protect them under circumstances such as when the output of the amplifier is inadvertently short-circuited and a large current flows or when there is an extremely large output. The protection circuit is also activated when the internal temperature is unusually high. (When the protection circuit is activated due to high internal temperature, the volume indicator flashes and the speaker output is restricted. If the internal temperature rises further, the power is set to the standby mode and the power indicator flashes red.) In such cases, be sure to unplug the AV surround amplifier's power cord from the power outlet, check the wiring of the connection cords and input cords for any abnormalities, and if the AV surround amplifier's temperature is extremely high, wait for it to cool down, improve ventilation around the amplifier, then turn the power back on. If the protection circuit is activated even though there are no problems with the wiring or with ventilation around the AV surround amplifier, there may be a problem with the AV surround amplifier. Unplug the AV surround amplifier's power cord from the power outlet, then contact a DENON service or repair center.

Note on speaker impedance

- The protector circuit may be activated if the set is played for long periods of time at high volumes when speakers with an impedance lower than the specified impedance (for example speakers with an impedance of lower than 4 Ω /ohms) are connected. If the protector circuit is activated, the speaker output is cut off. Turn off the set's power, wait for the set to cool down, improve the ventilation around the set, then turn the power back on.

(2) Connecting the DVD Player and TV

- Connect the DVD player's video signals directly to the TV and switch the picture on the TV.
- When making connections, also refer to the operating instructions of the other components.

Connecting the AUDIO Jack

- Connect the video disc player's analog audio output jacks (ANALOG AUDIO OUT) to the DVD IN jacks using pin plug cords.

Connecting the DIGITAL Jack

- Use a commercially available optical transmission cable for connection to the optical transmission terminal (OPTICAL).

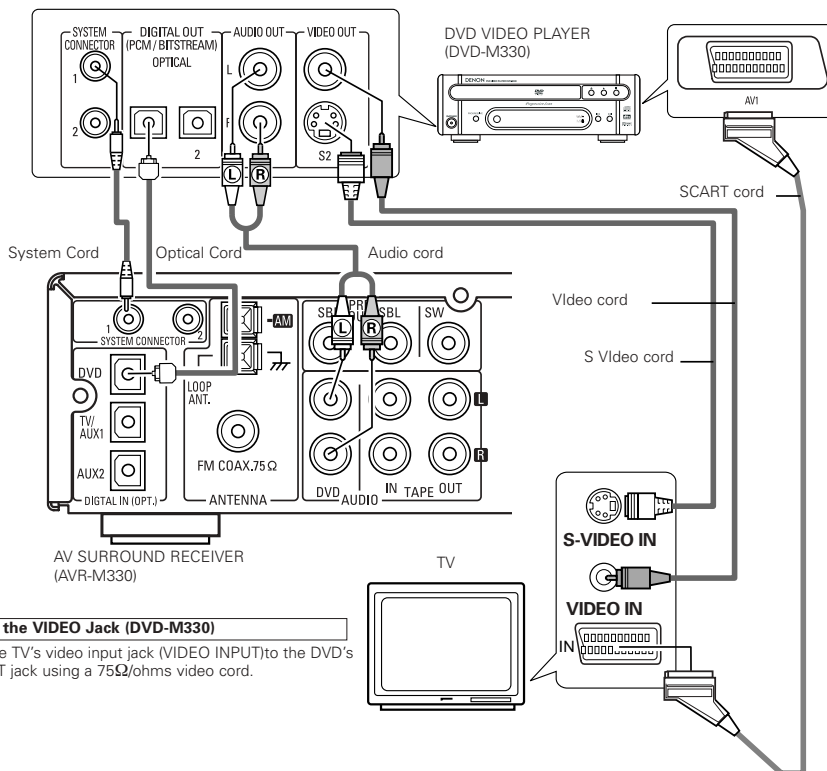

Connecting the VIDEO Jack (DVD-M330)

- Connect the TV's video input jack (VIDEO INPUT) to the DVD's VIDEO OUT jack using a 75Ω/ohms video cord.

(3) Connecting the Audio Signals of a Digital Satellite Tuner and VCR

- Connect the video signals directly to the TV and switch the picture on the TV.
- When making connections, also refer to the operating instructions of the other components.

Connection to the optical digital input terminal

- Only audio signals are input to the optical digital input terminal.
- Use a commercially available optical transmission cable for connection to the optical transmission terminal (OPTICAL).

Digital satellite/cable tuner

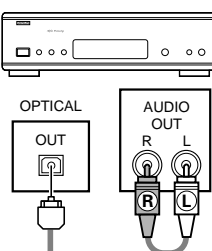

Connection of a digital satellite/cable tuner

- For tuners equipped with an optical digital output terminal, connect the digital output terminal to the DIGITAL TV/AUX1 IN terminal on the AVR-M330 using an optical transmission cable.
- To connect the audio output terminals, use whatever of the AVR-M330's TAPE terminals are open.

AV SURROUND RECEIVER (AVR-M330)

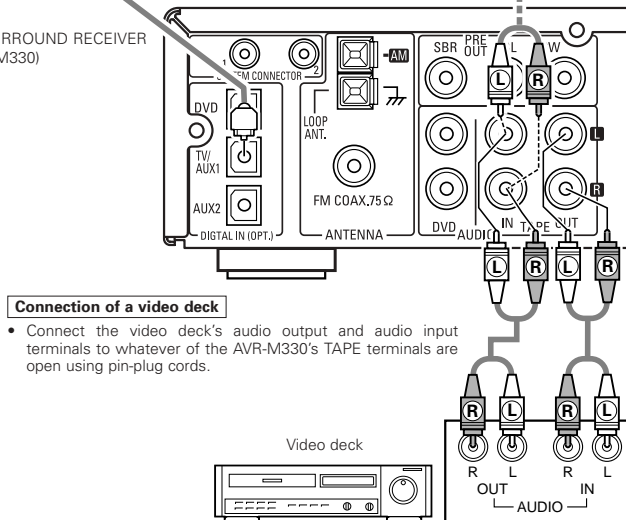

Connection of a video deck

- Connect the video deck's audio output and audio input terminals to whatever of the AVR-M330's TAPE terminals are open using pin-plug cords.

Video deck

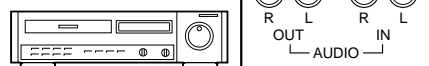

(4) Connecting the antenna terminals

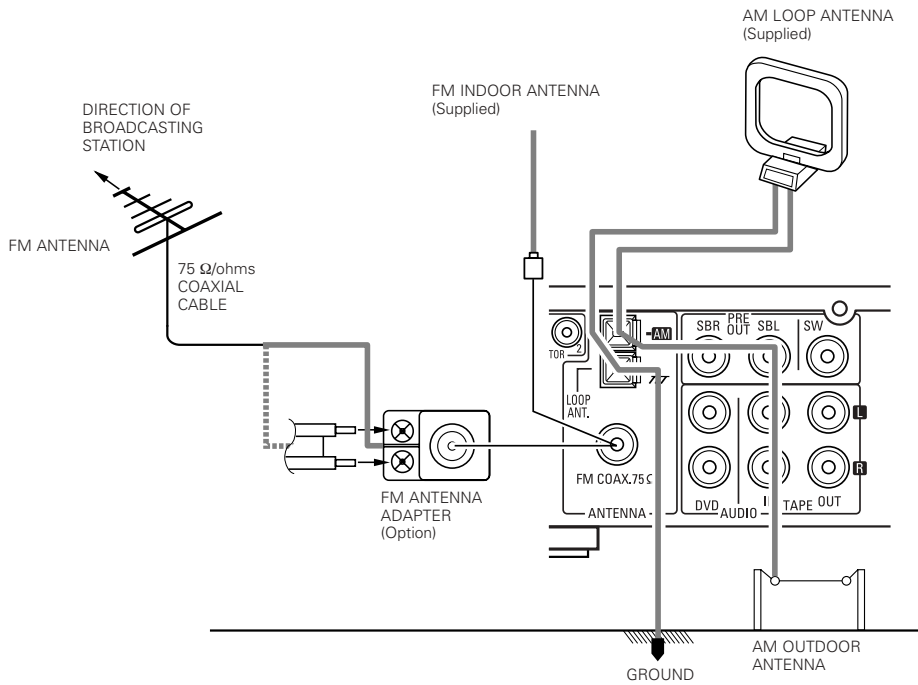

- An PAL-type FM antenna cable plug can be connected directly.
- If the FM antenna cable's plug is not of the PAL-type, connect using the PAL-type antenna adapter (Option).

AM loop antenna assembly

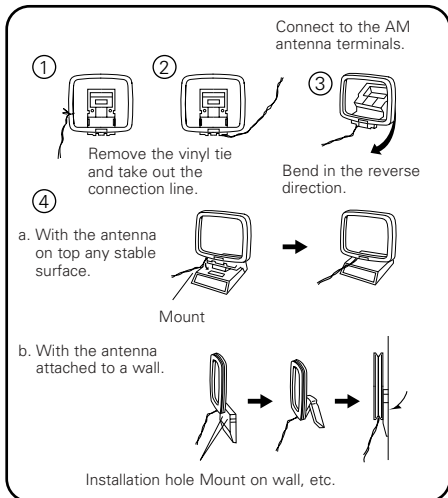

Connection of AM antennas

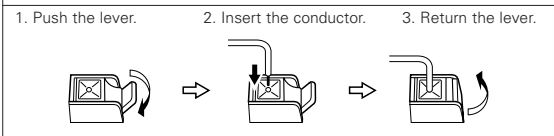

- NOTES:**
- Do not connect two FM antennas simultaneously.
 - Even if an external AM antenna is used, do not disconnect the AM loop antenna.
 - Make sure AM loop antenna lead terminals do not touch metal parts of the panel.

(5) Using the active subwoofer

- Use Subwoofer jack to connect in case you had additional active subwoofer.
- You can connect a larger active subwoofer to the system. Connect the active subwoofer to the SW (Subwoofer) PRE-OUT jack using a shielded audio cable.

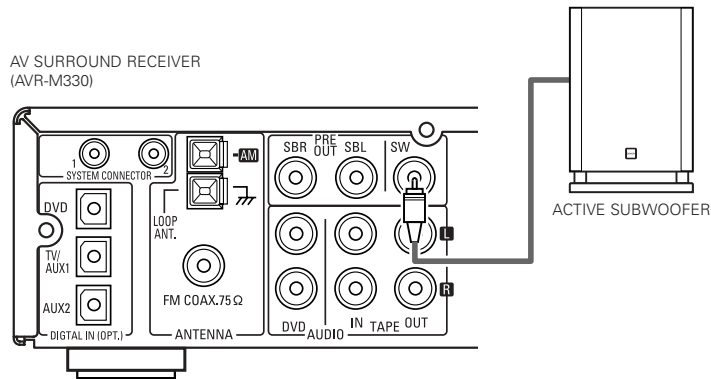

(6) Using SURROUND BACK PRE OUT (SBL/SBR)

- Use SURR. BACK PRE OUT jack to connect additional POWER AMPLIFIER and speaker systems. You can enjoy 6.1CH or 7.1CH surround system.
- When making connections, also refer to the operating instructions of the other components.
- To make the 6.1 or 7.1-channel setting, set the speakers to "6.1CH" or "7.1CH" in the quick setup and select "Room Setup" . (See pages 27 .)

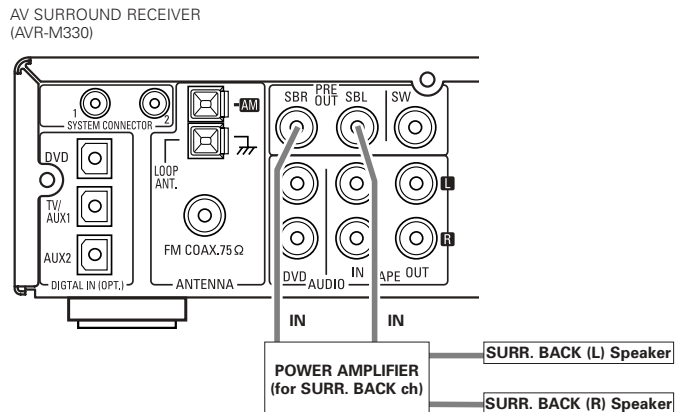

- Connect the power amplifier for SURR. BACK speaker system.

(7) Connecting the audio components (DVD-M330)

- The AVR-M330 can be used connected in a system with the DVD-M330 DVD player.
- For instructions on operating the DVD-M330 DVD player, refer to their respective operating instructions.
- Only the DVD-M330 DVD player can be connected directly to the AVR-M330 using system connections.

NOTES:

- This system includes digital circuitry which may cause interference such as color blotching or changes in the color on TVs. If this happens, move the system and the TV as far apart as possible.
- Do not plug the power cord into the power outlet until all connections are completed. Be sure to interconnect the channels (L to L (white) and R to R (red)) properly, as shown on the diagram.
- Insert the plugs securely. Incomplete connections may result in noise.
- Be sure to connect the speaker cords between the speaker terminals and the speaker systems with the same polarities (+ to +, - to -). If the polarities are switched, the sound at the center will be weak, the position of the different instruments will be unclear, and the stereo effect will be lost.
- After unplugging the power cord, wait about 5 seconds before plugging it back in.
- Note that setting the connection cords (pin-plug cords) next to the power cords may result in humming or other noise.

CAUTION:

- Only one DVD player can be connected to the AVR-M330 using system connections. System operations cannot be performed properly if two DVD players are connected using system connections.
- Whenever the power operation switch is in the STANDBY position, the unit is still connected to AC line voltage.
- Please be sure to unplug the power cord when you leave home for, e.g., a vacation, etc.

System operations

Such system operations as the auto power on functions, as well as remote control operations cannot be performed unless all the RCA pin-plug cords and system connector cords are connected between the units, so be sure to make all the connections properly as shown in the diagram. Also, disconnecting system connectors while the system is operating may result in malfunctions. Be sure to unplug the power cord before changing connections.

Connecting the speaker systems

Connect the speaker system for the left channel (the left side as seen from the front) to the L terminals, the speaker system for the right channel to the R terminals. Refer to the instructions supplied with the speaker system for details. Be sure to use speaker systems with an impedance of 6 Ω/ohms or greater.

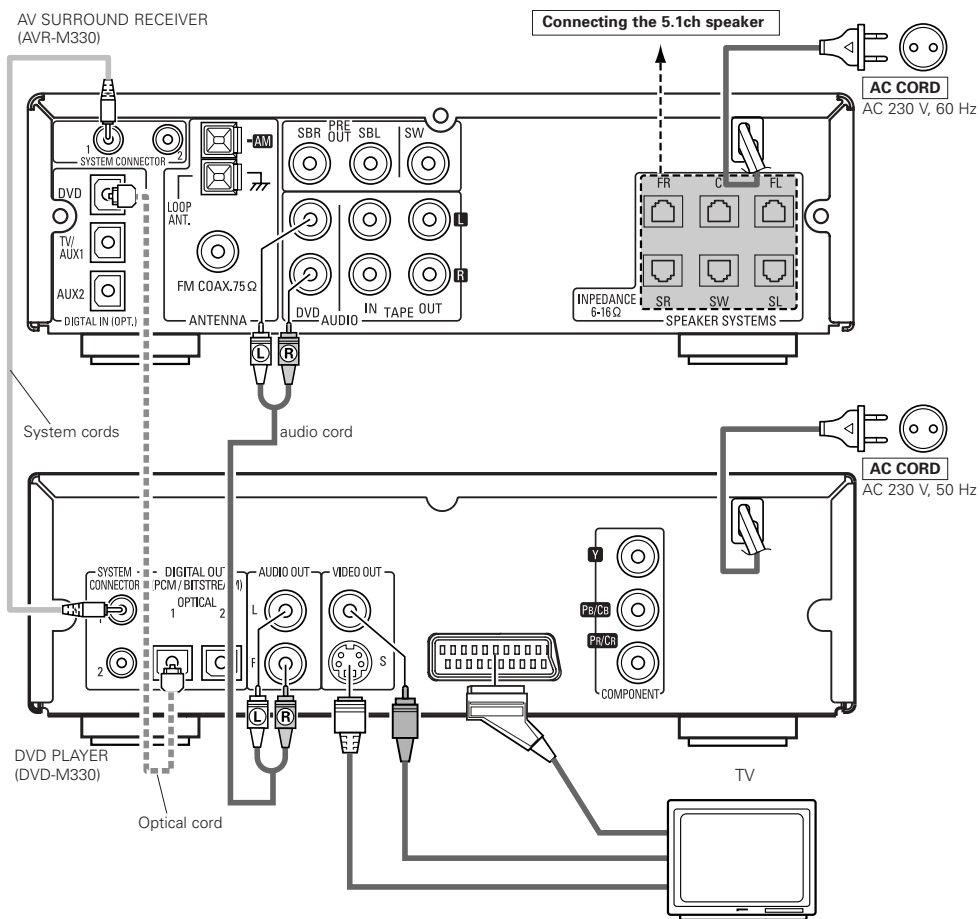

6 PART NAMES AND FUNCTIONS

AV SURROUND RECEIVER (AVR-M330) Front Panel

- For details on the functions of these parts, refer to the pages given in parentheses ().

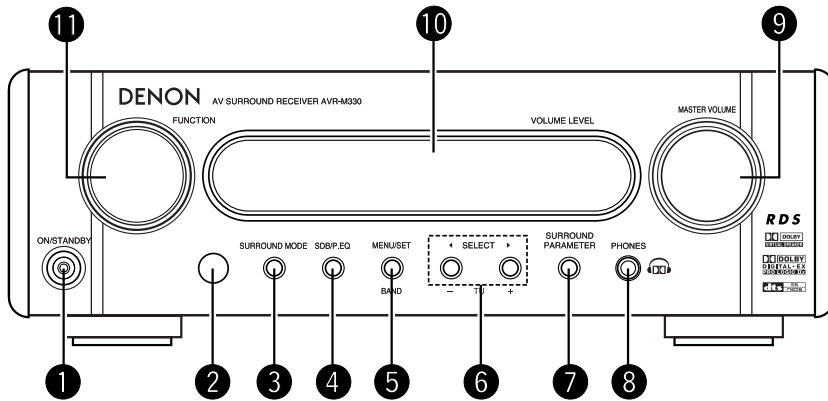

- | | |
|---|--|
| ① Power operation switch (ON/STANDBY).....(29) | ⑦ Surround parameter button (SURROUND PARAMETER)(34) |
| ② Remote control sensor.....(19) | ⑧ Headphones jack (PHONES)(38) |
| ③ Surround mode button (SURROUND MODE).....(30) | ⑨ Volume control (MASTER VOLUME)(29) |
| ④ Super Dynamic Bass/Preset EQ button (SDBP/EQ)(32) | ⑩ Display |
| ⑤ Menu/set button (MENU/SET)(27, 31, 42) | ⑪ Function selector knob (FUNCTION).....(30) |
| ⑥ Select button (SELECT ◀ and ▶).....(31, 37, 38, 42) | |

Remote control unit

- For details on the functions of these parts, refer to the pages given in parentheses ().
- Some of the buttons on the remote control unit have some functions. The functions are switched using the remote control mode selector switches.

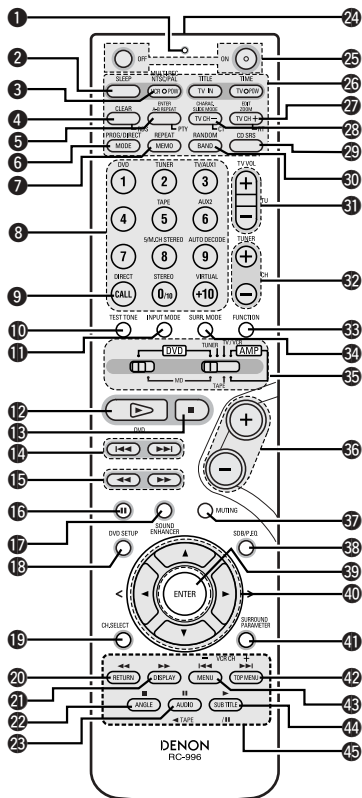

- 1 Transmission indicator
- 2 Sleep timer button(53)
- 3 NTSC/PAL button
- 4 Clear button
- 5 A-B repeat button
- 6 Program/direct
- 7 Repeat button
- 8 Input source/surround mode selector button
- * System buttons.....(18, 20, 21, 26)

- 9 Call button
- 10 Test tone button(33)
- 11 Input mode selector button.....(30)
- 12 DVD play button
- 13 DVD stop button
- 14 DVD skip buttons
- 15 DVD search buttons
- 16 DVD pause button
- 17 Sound enhancer button.....(32)
- 18 DVD Setup button
- 19 Channel select button(33, 39)
- 20 Return button
- 21 Display button
- 22 Angle button
- 23 Audio selector button
- 24 Remote control signal transmission window(19)
- 25 Power button.....(29)
- 26 * System buttons.....(18, 20, 21, 26)
- 27 Zoom button
- 28 Slide mode button
- 29 CD SRS button
- 30 Random button
- 31 Tuner tuning +/- buttons(42)
- 32 Tuner preset +/- buttons.....(43, 44)
- 33 Function selector button(29)
- 34 Surround mode selector button(30)
- 35 Mode selector switches(1 and 2)(17, 18, 20, 21, 26)
- 36 Main volume control buttons(31)
- 37 Muting button.....(32)
- 38 SDB/P.EQ button(32)
- 39 Enter button
- 40 Cursor button
- 41 Surround parameter button(34~36, 38)
- 42 Top menu button
- 43 Menu button
- 44 Subtitle button
- 45 * System buttons.....(18, 20, 26)

- For details on the function and operation of the various parts, refer to the pages indicated in (parentheses).
- Buttons indicated are DVD control buttons and can be operated when the remote control mode selector switch is set to the **DVD** position.
- The functions of the system buttons (*) are switched using the remote control mode selector switch.

Names and functions of remote control unit buttons on the DHT-M330DV

- Buttons in sections ① ~ ③ can be operated regardless of the position of mode switches 1 and 2.
- Consider **AMP** as standard positions, and switch as necessary to operate.

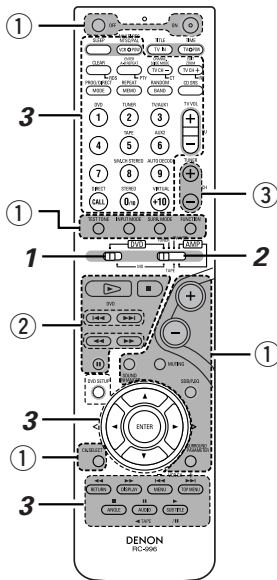

- ① Surround amplifier control buttons
- ON : Turns the AVR-M330's power on.
 - OFF : Turns the AVR-M330's power off.
 - FUNCTION : Function selection (in order)
 - SURROUND : Surround mode selection
 - INPUT MODE : Input mode selection
 - TEST TONE : Test tone on/off
 - + : Main volume up
 - : Main volume down
 - MUTING : Muting on/off
- SOUND ENHANCER: Sound enhancer selection
- SDB/P.EQ : SDB/P.EQ selection and setting
 - SURROUND : Surround parameter selection and setting
 - PARAMETER
 - CH SELECT : Channel level/Delay time selection and setting
- ② DVD control buttons
- : Play (auto power on and auto function selection)
 - : Stop
 - : Skip (cueing)
 - : Search (fast-reverse and fast-forward)
 - : Pause and frame-by-frame
- ③ Tuner control buttons
- CH +/- : Preset channel up/down (auto power on and auto function selection)

- 1** Set mode switch 1 to the "DVD" position.



- 2** Set mode switch 2 to the position of the function you want to operate (DVD, TUNER or AMP).

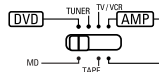

3 Operate the DHT-M330DV.

[1] Surround amplifier system buttons
(Operated with mode switch 2 set to "AMP.")

- These operations are possible with mode switch 1 at any position.

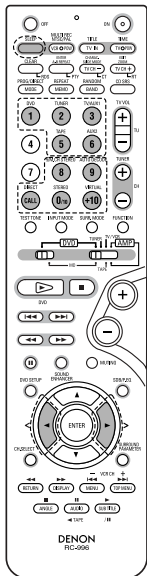

- SLEEP : Sleep on/off
- DVD : Function DVD
- TUNER : Function TUNER
- TV/AUX1 : Function TV/AUX1
- TAPE : Function TAPE
- AUX2 : Function AUX2
- 5CH STEREO : 5ch stereo mode set
- AUTO DECODE : Auto decode mode set
- VIRTUAL : Dolby VS surround mode set or 2.1/3.1/5.1ch mode switching when Dolby VS mode
- STEREO : Stereo mode set
- DIRECT : Direct mode set
- ◀▶ : Selection left and right

[2] DVD system buttons
(Operated with mode switch 2 set to "DVD")

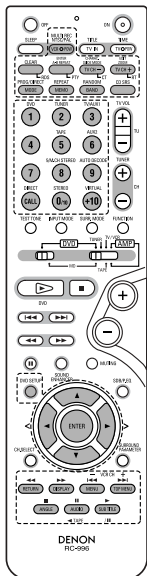

- NTSC/PAL : NTSC/PAL selection
- ZOOM : Zoom on/off
- SLIDE MODE : JPEG image slide mode selection
- A-B REPEAT : A-B repeat playback setting
- CLEAR : Program clear
- SEARCH MODE : Title and chapter search selection
- RANDOM : Random play on/off
- REPEAT : Repeat play setting
- PROG/DIRECT : Program/direct play selection
- CALL : Program call
- 0 ~ 9, +10 : Number buttons
- DVD SETUP : DVD setup mode on/off
- ▲, ▼, ◀, ▶ : Cursor up, down, left, right
- ENTER : Enter setting
- TOP MENU : Top menu call
- MENU : Menu call
- DISPLAY : Display call/selection
- RETURN : Menu return
- SUBTITLE : Subtitle language selection
- AUDIO : Audio language selection
- ANGLE : Angle selection

[3] Tuner system buttons
(Operated with mode switch 2 set to "TUNER")

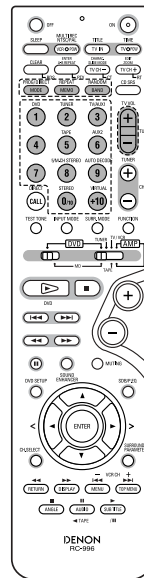

- BAND : FM/AM band selection
- MEMO : Preset memory
- MODE : FM auto/mono mode selection
- TUNER +/- : Tuning up/down
- 0 ~ 9, +10 : Preset channel number buttons

RDS : Use this button to automatically tune to stations using the radio data system.



PTY : Press this button after selecting "PTY" with the RDS button to select one of the 29 program types.

CT : Use this to display the time of the clock on the AVR-M330. Press this button when the time service of an RDS station is being properly received. "TIME" is displayed for 4 seconds. "NO TIME DATA" is displayed if the RDS station does not offer a time service and when the broadcast is not being received properly.

RT : Press this button when receiving RDS stations to select the frequency, PS (or Station name), PTY or RT display. Note that this button will not function if the reception is poor. The display mode changes as follows each time the button is pressed.

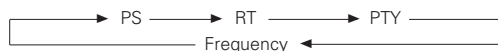

7 REMOTE CONTROL UNIT

- The included remote control unit (RC-996) can be used to operate not only this unit but other remote control compatible DENON components as well. In addition, the memory contains the control signals for other remote control units, so it can be used to operate non-DENON remote control compatible products.

(1) Inserting the batteries

- ① Remove the remote control unit's rear cover.

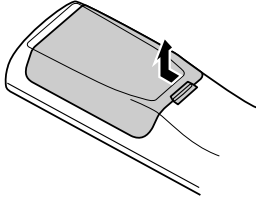

- ② Set three R6P/AA batteries in the battery compartment in the indicated direction.

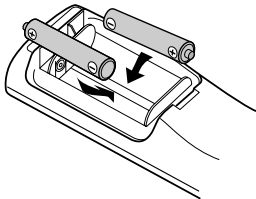

- ③ Put the rear cover back on.

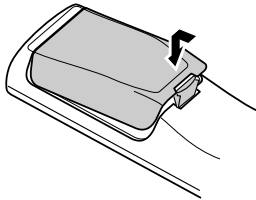

Notes on Batteries

- Use R6P/AA batteries in the remote control unit.
- The batteries should be replaced with new ones approximately once a year, though this depends on the frequency of usage.
- Even if less than a year has passed, replace the batteries with new ones if the set does not operate even when the remote control unit is operated nearby the set. (The included battery is only for verifying operation. Replace it with a new battery as soon as possible.)
- When inserting the batteries, be sure to do so in the proper direction, following the "⊕" and "⊖" marks in the battery compartment.
- To prevent damage or leakage of battery fluid:
 - Do not use a new battery together with an old one.
 - Do not use two different types of batteries.
 - Do not short-circuit, disassemble, heat or dispose of batteries in flames.
- Remove the batteries from the remote control unit when you do not plan to use it for an extended period of time.
- If the battery fluid should leak, carefully wipe the fluid off the inside of the battery compartment and insert new batteries.
- When replacing the batteries, have the new batteries ready and insert them as quickly as possible.

(2) Using the remote control unit

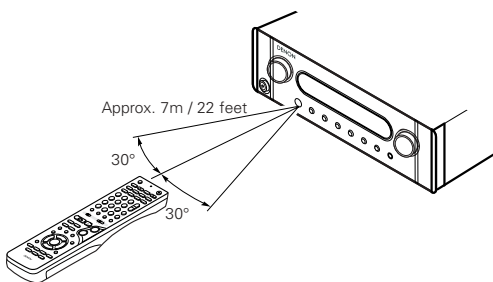

- Point the remote control unit at the remote sensor on the main unit as shown on the diagram.
- The remote control unit can be used from a straight distance of approximately 7 meters/22 feet from the main unit, but this distance will be shorter if there are obstacles in the way or if the remote control unit is not pointed directly at the remote sensor.
- The remote control unit can be operated at a horizontal angle of up to 30 degrees with respect to the remote sensor.

NOTES:

- It may be difficult to operate the remote control unit if the remote sensor is exposed to direct sunlight or strong artificial light.
- Do not press buttons on the main unit and remote control unit simultaneously. Doing so may result in malfunction.
- Neon signs or other devices emitting pulse-type noise nearby may result in malfunction, so keep the set as far away from such devices as possible.

- The included remote control unit (RC-996) can be used to operate not only the DHT-M330DV but also and to operate other remote control compatible DENON products. In addition, the remote control operation codes of other major brands of TVs and video decks are also stored in the remote control unit, so the unit can be used to operate these TVs and video decks as well.

(3) Operating DENON audio components

- Turn on the power of all the components before operating them.
- Depending on the model and year of make of your component, some of the keys may not work.

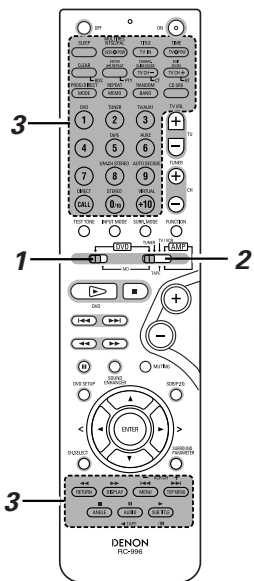

1 Set mode switch 1 to the "MD" position. (Blue print)



2 Set mode switch 2 to the position for the component to be operated (MD or TAPE). (Blue print)

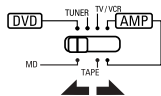

3 Operate the audio component.
 • For details, refer to the component's operating instructions.
 ※ Operation may not be possible for some models.

3 [1] MD recorder system buttons (operated with mode switch 2 set to "MD")

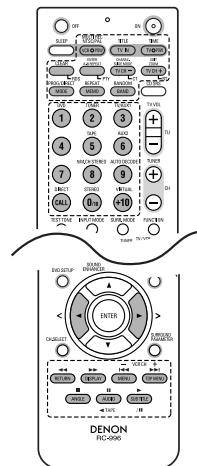

- TIME : Disc time display
- TITLE : Name display
- MULTI REC : Recording
- EDIT : Edit mode selection
- CHARAC : Selection of characters when inputting names
- ENTER : Entering of edited values
- CD SRS : CD synchronized recording
- CLEAR : Program clearing
- RANDOM : Random play on/off
- REPEAT : Repeat play setting
- PROG/DIRECT : Program/direct playback selection
- CALL : Program calling
- 1~10, +10 : Track number selection
- ◀◀, ▶▶ : Auto search (cueing)
- ◀◀, ▶▶ : Manual search (fast-reverse and fast-forward)
- ▶ (/ ||) : Play
- ⏸ : Pause
- : Stop

[2] Tape deck system button (operated with mode switch 2 set to "TAPE")

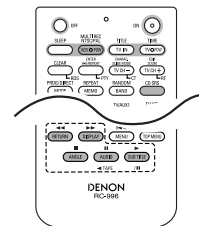

- REC : Recording
- CD SRS : CD synchronized recording
- ◀◀, ▶▶ : Rewind and fast-forward
- ▶ : Forward direction play
- ◀ TAPE : Reverse direction play
- : Stop

(4) TV and video deck preset memories

- Components of other brands can be operated with the included remote control unit by storing their codes in the preset memory. Note that depending on the model some operations may not be possible and some buttons may not operate properly.

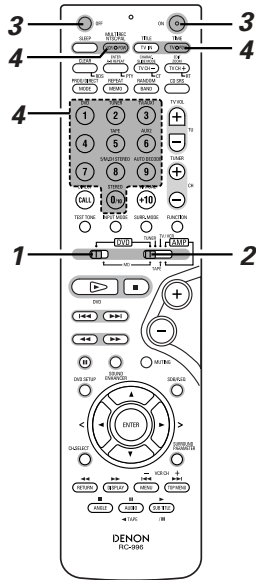

4 Press the TV button to preset a TV, the VCR button to preset a video deck, then input the 3-digit number corresponding to the brand of the component whose signals are to be stored in the preset memory (refer to the tables of remote control codes on pages 22 to 25).

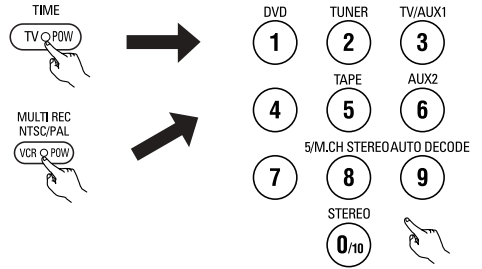

- NOTES:**
- When buttons are pressed while setting the preset memory, their signals are sent from the remote control transmitter, so cover the remote control sensor when setting the preset memory to prevent accidental operation.
 - Depending on the model and year of make, some of the remote control codes for the brands included on the tables may not operate properly.
 - For some brands there are multiple types of remote control codes. If an operation does not work, try changing to one of the other codes.

■ Not set upon shipment from the factory.

1 Set mode switch 1 to the "DVD" position.



2 Set mode switch 2 to the "TV/VCR" position.

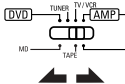

3 Press the power ON button and the OFF button simultaneously.

- The transmission LED (indicator) flashes.

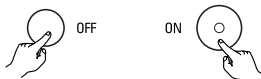

Combinations of preset codes for different brands

TV	
Admiral	045, 121
Adventura	122
Aiko	054
Akai	016, 027, 046
Alleron	062
A-Mark	007
Amtron	061
Anam	006, 007, 036
Anam National	061, 147
AOC	003, 007, 033, 038, 039, 047, 048, 049, 133
Archer	007
Audiovox	007, 061
Bauer	155
Belcor	047
Bell & Howell	045, 118
Bradford	061
Brockwood	003, 047
Candle	003, 030, 031, 032, 038, 047, 049, 050, 122
Capehart	003
Celebrity	046
Circuit City	003
Citizen	029, 030, 031, 032, 034, 038, 047, 049, 050, 054, 061, 095, 122, 123
Concerto	031, 047, 049
Colortyme	003, 047, 049, 135
Contec	013, 051, 052, 061
Cony	051, 052, 061
Craig	004, 061
Crown	029
Curtis Mathes	029, 034, 038, 044, 047, 049, 053, 095, 118
Daewoo	027, 029, 039, 048, 049, 054, 055, 106, 107, 137
Daytron	003, 049
Dimensia	044
Dixi	007, 015, 027
Electroband	046
Electrohome	029, 056, 057, 058, 147
Elta	027
Emerson	029, 051, 059, 060, 061, 062, 118, 123, 124, 139, 148
Envision	038
Etron	027
Fisher	014, 021, 063, 064, 065, 118
Formenti	155
Fortress	012
Fujitsu	004, 062
Funai	004, 062
Futuretech	004
GE	020, 036, 037, 040, 044, 058, 066, 088, 119, 120, 125, 147
Goldstar	015, 029, 031, 039, 048, 051, 056, 057, 067, 068, 069, 116, 165
Grundig	062
Hitachi	029, 031, 051, 052, 070, 111, 112, 113, 124, 134
Hitachi Pay TV	151
Infinity	017, 071
Janeil	122
JBL	017, 071
JC Penny	020, 034, 039, 040, 041, 044, 048, 050, 058, 066, 069, 076, 088, 090, 095, 125, 136, 159
JCB	046
JVC	019, 051, 052, 072, 073, 091, 117, 126
Kawasho	018, 046
Kenwood	038, 056, 057
Kloss	010, 032
Kloss Novabeam	005, 122, 127, 131
KTV	074, 123
Loewe	071
Logik	144
Luxman	031
LXI	008, 014, 017, 024, 040, 044, 063, 071, 075, 076, 077, 118, 125
Magnavox	005, 010, 017, 030, 033, 038, 050, 056, 071, 078, 079, 085, 089, 108, 109, 110, 127, 131, 132, 145
Marantz	015, 017, 071, 080
Matsui	027
Memorex	014, 027, 045, 083, 118, 144
Metz	160, 161, 162, 163, 164
MGA	001, 039, 048, 056, 057, 058, 065, 081, 083
Midland	125
Minutz	066
Mitsubishi	001, 016, 039, 048, 056, 057, 058, 065, 081, 082, 083, 105
Montgomery Ward	011, 020, 144, 145, 146
Motorola	121, 147
MTC	031, 034, 039, 048, 095
NAD	008, 075, 076, 128
National	002, 036, 061, 147

TV

National Quenties	002	Sharp	011, 012, 013, 026, 093, 099, 100, 104, 121
NEC	031, 038, 039, 048, 057, 084, 086, 135, 147	Siemens	013
Nikko	054	Signature	045, 144
NTC	054	Simpson	050
Optimus	128	Sony	043, 046, 138, 146, 150
Optonica	011, 012, 093, 121	Soundesign	030, 050, 062
Orion	004, 139	Spectricon	007, 033
Panasonic	002, 009, 017, 036, 037, 071, 141, 143, 147	Squareview	004
Philco	005, 010, 030, 050, 051, 056, 079, 085, 127, 131, 132, 145, 147	Supre-Macy	032, 122
Philips	005, 015, 017, 050, 051, 056, 078, 087, 088, 089, 131, 132, 147	Supreme	046
Pioneer	124, 128, 142	Sylvania	005, 010, 017, 030, 078, 079, 085, 089, 101, 127, 131, 132, 145, 155
Portland	054	Symphonic	004, 148
Price Club	095	Tandy	012, 121
Proscan	040, 044, 125	Tatung	036, 124
Proton	035, 051, 092, 129	Technics	037
Pulsar	042	Teknika	001, 030, 032, 034, 052, 054, 078, 083, 095, 144, 156, 157
Quasar	036, 037, 074, 141	Tera	035, 129
Radio Shack	011, 044, 063, 093, 118	Toshiba	008, 014, 034, 063, 075, 076, 095, 097, 136, 158, 159
RCA	040, 044, 125, 130, 137, 151, 152	Universal	020, 066, 088
Realistic	014, 063, 093, 118	Victor	019, 073, 126
Saisho	027	Video Concepts	016
Samsung	003, 015, 034, 053, 055, 057, 094, 095, 136, 153	Viking	032, 122
Sansui	139	Wards	005, 045, 066, 078, 085, 088, 089, 093, 102, 103, 131, 132, 148
Sanyo	013, 014, 021, 022, 063, 064, 081, 096	Zenith	042, 114, 115, 140, 144, 149
SBR	015	Zonda	007
Schneider	015		
Scott	062		
Sears	008, 014, 021, 022, 023, 024, 025, 040, 052, 057, 062, 063, 064, 065, 073, 075, 076, 097, 098, 125, 159		

VCR	
Admiral	081
Aiko	095
Aiwa	009
Akai	026, 027, 070, 072, 082, 083, 084
Alba	055
Amstrad	009
ASA	042
Asha	087
Audio Dynamic	005, 085
Audiovox	088
Beaumark	087
Broksonic	086, 093
Calix	088
Candle	006, 087, 088, 089, 090
Canon	049, 057
Capehart	025, 055, 056, 071
Carver	015
CCE	095
Citizen	006, 007, 087, 088, 089, 090, 095
Craig	007, 087, 088, 091, 115
Curtis Mathes	006, 049, 073, 080, 087, 090, 092
Cybernex	087
Daewoo	025, 055, 059, 074, 089, 093, 095, 096
Daytron	025, 055
DBX	005, 085
Dumont	053
Dynatech	009
Electrohome	001, 088, 097
Electroponic	088
Emerson	001, 009, 017, 027, 086, 088, 089, 092, 093, 097, 100, 101, 102, 103, 104, 117
Fisher	009, 028, 031, 053, 054, 091, 098, 099, 115
GE	007, 011, 049, 050, 051, 052, 073, 080, 087
Go Video	047, 048
Goldstar	006, 012, 062, 088, 129
Gradiente	094
Grundig	042
Harley Davidson	094
Harman Kardon	040, 062
Hi-Q	091
Hitachi	009, 013, 023, 026, 058, 108, 109, 110, 111
JC Penny	004, 005, 007, 023, 028, 049, 062, 085, 087, 088
Jensen	013, 026
JVC	004, 005, 006, 026, 029, 043, 044, 045, 046, 085
Kenwood	004, 005, 006, 026, 029, 033, 045, 085, 090
Kodak	088
Lloyd	009, 094
LXI	088
Magnavox	015, 016, 042, 049, 063, 106
Magnin	087
Marantz	004, 005, 006, 015, 042, 049, 085, 090
Marta	088
MEI	049
Memorex	009, 033, 049, 053, 060, 081, 087, 088, 091, 094, 115
Metz	123, 124, 125, 126, 127, 128
MGA	001, 017, 027, 041, 097
MGN Technology	087
Midland	011
Minolta	013, 023
Mitsubishi	001, 003, 008, 013, 014, 017, 027, 029, 039, 040, 041, 045, 097
Motorola	081
Montgomery Ward	001, 002, 007, 009, 049, 063, 081, 115, 117
MTC	009, 087, 094
Multitech	007, 009, 011, 087, 090, 094
NAD	038
NEC	004, 005, 006, 018, 026, 029, 045, 061, 062, 085
Nikko	088
Noblex	087
Optimus	081, 088
Optonica	021
Panasonic	024, 049, 064, 066, 067, 068, 069, 107
Perdio	009
Pentax	006, 013, 023, 058, 090
Philco	015, 016, 049
Philips	015, 021, 042, 049, 105
Pilot	088
Pioneer	005, 013, 029, 036, 037, 038, 045, 085
Portland	025, 055, 090
Proscan	063, 080
Pulsar	060
Quartz	033
Quasar	034, 035, 049
Radio Shack	001, 002, 021, 081, 087, 088, 091, 094, 097, 098, 115
Radix	088

VCR

Randex	088	Symphonic	009, 094
RCA	007, 013, 019, 023, 058, 063, 064, 065, 073, 080, 082, 087	Tandy	009
Realistic	009, 021, 031, 033, 049, 053, 081, 087, 088, 091, 094, 097, 098	Tashiko	009, 088
Ricoh	055	Tatung	004, 026, 030
Salora	033, 041	Teac	004, 009, 026, 094
Samsung	007, 011, 051, 059, 070, 083, 087, 089, 113	Technics	024, 049
Sanky	081	Teknika	009, 010, 022, 049, 088, 094
Sansui	005, 026, 029, 045, 061, 085, 114	TMK	087, 092
Sanyo	032, 033, 053, 087, 091, 115, 116	Toshiba	013, 017, 020, 041, 059, 089, 098, 099, 117
SBR	042	Totevision	007, 087, 088
Scott	017, 020, 086, 089, 093, 117	Unirech	087
Sears	013, 023, 028, 031, 033, 053, 054, 088, 091, 098, 099, 115	Vecrtor Research	005, 062, 085, 089, 090
Sentra	055	Victor	005, 045, 046, 085
Sharp	001, 002, 021, 097	Video Concepts	005, 027, 085, 089, 090
Shogun	087	Videosonic	007, 087
Sony	075, 076, 077, 078, 079, 121, 122	Wards	013, 021, 023, 087, 088, 089, 091, 094, 097, 118, 119, 120
STS	023	XR-1000	094
Sylvania	009, 015, 016, 017, 041, 049, 094	Yamaha	004, 005, 006, 026, 062, 085
		Zenith	060, 078, 079

(5) Operating the TV/video deck after storing its remote control signals in the preset memory

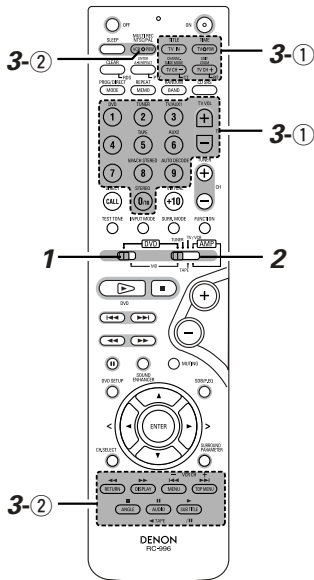

3

Monitor TV (TV) and video deck (VCR) system buttons

① TV system buttons

- TV POW : Power on/off
- 0~9 : Channel numbers
- TV IN : TV input switching
- TV VOL +, - : Volume up/down
- TV CH +, - : Channel switching

② Video deck system buttons

- VCR POW : Power on/off
- VCR CH +, - : Channel switching
- ◀▶ : Manual search (fast-forward and fast-backward)
- ▶ : Play
- ⏸ : Pause
- : Stop

1 Set mode switch 1 to the "DVD" position.



2 Set mode switch 2 to the "TV/VCR" position.

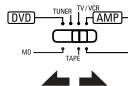

3 Operate the video component.
 • For details, refer to the component's operating instructions.
 ※ It may not be possible to operate some models.

NOTE:

- The TV's "TV (POWER)" and "TV IN" buttons can be operated as long as mode switch 1 is set to the "DVD" position, regardless of the position of mode switch 2.

8 SETTING UP THE SYSTEM

(1) Quick setup procedure

- Generally used system settings have already been made on the DHT-M330DV upon shipment from the factory, so the DHT-M330DV can be used as such if there is no need to make changes to the system.
- In the cases described below, use the Quick Setup function to make the system settings before using the DHT-M330DV.
 - ① When expanding the system configuration to a 6.1- or 7.1-channel system (see page 13, 47, 48)
 - ② When installing the speakers in a large room (select at "ROOM SETUP" below)
 - ③ When setting the TAPE function to the TV/AUX1 function and connecting both the digital and analog inputs (set "FUNC. SETUP" below to "TV/AUX1").

Quick system settings

■ :Factory default

Setup		Settings <>: Display		
		<5.1CH>	<6.1CH>	<7.1CH>
Speaker configuration SPEAKER SETUP	Select the speaker configuration you plan to use.	2 front channels Center channel 2 surround channels Subwoofer channel	2 front channels Center channel 2 surround channels Surround back channel Subwoofer channel	2 front channels Center channel 2 surround channels 2 surround back channels Subwoofer channel
Room settings ROOM SETUP	Select the speaker installation space.	S (3.6X4.5) Equivalent to 3.6 x 4.5 meters	M (4.5X5.4) Equivalent to 4.5 x 5.4 meters	L (6.0X6.0) Equivalent to 6.0 x 6.0 meters
Function settings FUNC. SETUP	Select the TAPE or MD function (analog input/output connectors only) or the TV/AUX1 function (analog input/output connectors and digital input connectors).	<TAPE> Use as analog input/output connector TAPE function.	<MD> Use as analog input/output connector MD function.	<TV/AUX1> Use analog input/output connectors (TAPE) and digital input connector (TV/AUX1) as the TV/AUX1 function.

Quick Setup procedure

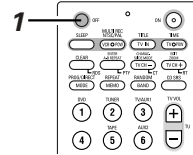
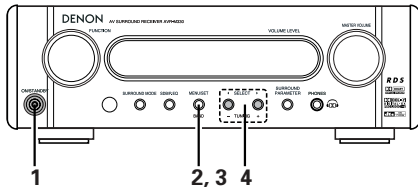

- 1** Turn off the power.
- The standby mode is set and the power indicator turns red.

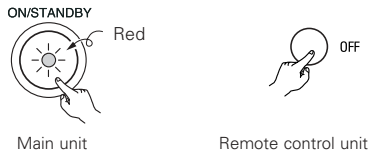

- 2** Press the MENU/SET button for at least 2 seconds.
- The display lights and "QUICK SETUP" is displayed.

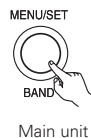

- 3** The items you want to set are displayed each time the MENU/SET button is pressed (for less than 1 second).
- The item changes each time the button is pressed, as follows:

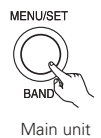

SPEAKER SETUP → ROOM SETUP
→ FUNC. SETUP → (END)

- After one second, the currently set value is displayed.

- 4** Use the select ◀ and ▶ buttons to select the item you want to set.
- If you do not want to change the value, press the MENU/SET button to continue.

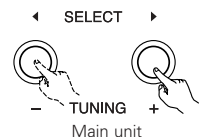

- 5** After going once through pressing the MENU/SET button, the DHT-M330DV is set back to the standby mode.

(2) Speaker system layout

Basic system layout

- The following is an example of the basic layout for a system consisting of eight speaker systems and a television monitor:

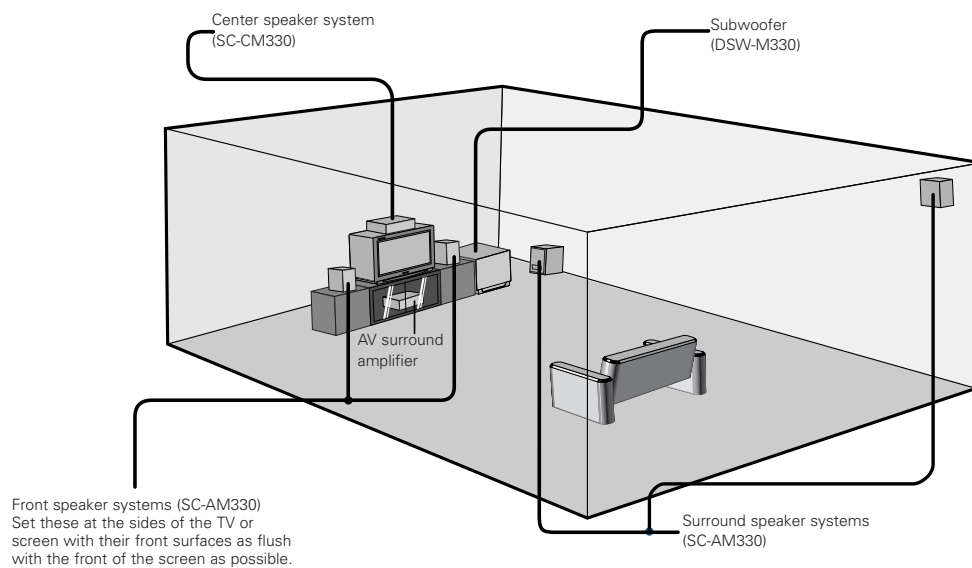

9 OPERATING THE SURROUND FUNCTIONS

Achieving the optimum surround sound

- Surround sound can be achieved using the settings made upon shipment from the factory (the default settings), but to achieve even more optimum surround sound, we recommend using the test tones to adjust the levels of the different channels, set the speaker distances (delay time), etc.
For details, make the settings referring to page 39.

(1) Playing DVDs in the surround mode

- Refer to pages 14 and check that all the connections are correct.
- Operate the remote control unit at the "AMP" position.

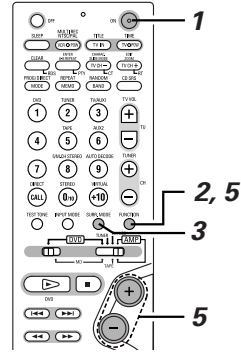
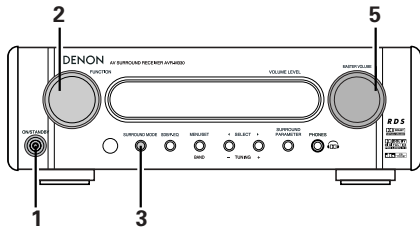

- 1** Turn on the power.
- The display lights.
 - The mute mode is set for several seconds after the power is turned on to prevent noise from being produced.

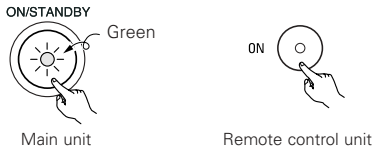

- 2** Select the DVD input source.



- 3** Set the surround mode to "AUTO DECODE".
The display becomes as shown below.

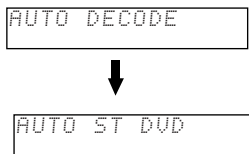
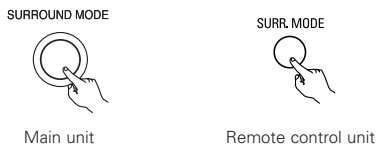

※ If no signal is being input

- 4** Play the DVD. The display changes as shown below, depending on the type of disc.

Example: When playing a pre-recorded () disc.



- Playback in the Dolby Digital Surround mode.

Example: When playing a pre-recorded () disc



- Playback in the DTS Surround mode.

Example: When playing a pre-recorded () disc

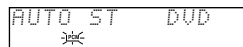

- Auto stereo – stereo playback.

- 5** Adjust the volume.

- When the input mode is set to "AUTO" and the surround mode is set to "AUTO DECODE", depending on the signals of the disc being played, Dolby Digital, DTS or PCM is selected and the signals are automatically decoded and played in the Dolby Digital, DTS or auto stereo mode.
- For details on the surround modes and the surround parameters, see "10 SURROUND PLAYBACK " (pages 33 to 39).

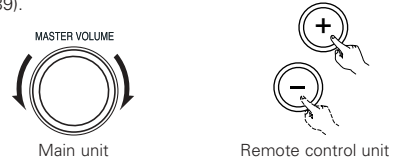

The volume is indicated on the main volume level display.

(2) Input mode setting

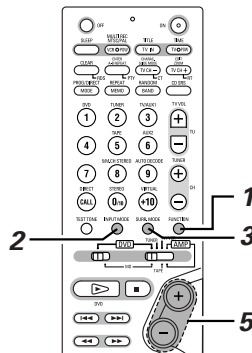
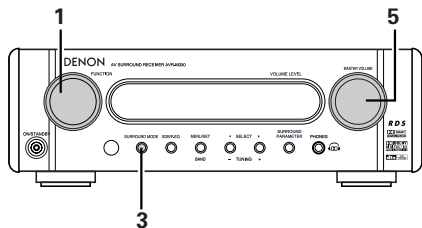

1 Press the **FUNCTION** button to select the input function to be played.



- The function switches as shown below.
- The function only changes in the “→” direction when operated from the remote control unit.
- Factory default (TAPE) = TAPE



2 When DVD, TV/AUX1, AUX2 was selected as the input function, press the remote control unit’s **INPUT MODE** button to select the input mode.

- Consider “AUTO” as standard position.

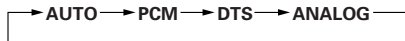
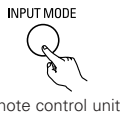

- “ANALOG” cannot be selected when TV/AUX1 or AUX2 was selected as the input function.
- “ANALOG” can be selected when “TAPE” is set to “TV/AUX1” at “FUNCTION SETUP” under “QUICK SETUP” in the detailed settings.

Input mode selection function

- The input mode can be selected when the input function is set to DVD, TV/AUX1, AUX2.
- Different input modes can be selected for each input function. The selected input mode is stored in the memory for the individual input functions.
- When the input function is set to something other than the above, “ANALOG ONLY” is displayed and the input mode cannot be selected.

① **AUTO** (auto mode)

In this mode, the type of signal being input to the digital and analog input terminals is detected and the program in the set’s surround decoder is switched automatically to play the signals for the selected input function.

The presence or absence of digital signals is detected, the signals input to the digital input are identified and decoding and playback are performed automatically in DTS, Dolby Digital or PCM (2 channel stereo) format.

If no digital signal DVD is being input, the analog input jacks are selected.

Use this mode to play Dolby Digital signals.

② **PCM** (exclusive PCM signal playback mode)

Decoding and playback are only performed when PCM signals are being input.

③ **DTS** (exclusive DTS signal playback mode)

Decoding and playback are only performed when DTS signals are being input.

④ **ANALOG** (exclusive analog audio signal playback mode)

The signals input to the analog input jacks are played. (This cannot be selected in the TV/AUX1, AUX2 mode.)

- ※ The input mode automatically switches to “AUTO” if you switch the input function to DVD from anything other than DVD.

3 Press the **SURROUND** button to select the surround mode.

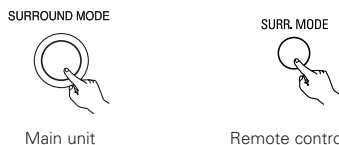

- The function switches as shown below.

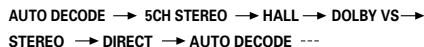

- 4** Start playback on the selected component.
- For operating instructions, refer to the component's manual.

- 5** Either turn the MASTER VOLUME dial on the main unit or use the VOLUME buttons on the remote control unit to adjust the volume.

The volume level is displayed on the display.



- The volume can be adjusted within the range 0 to 60. Note that depending on the input signal, surround mode, speaker settings and channel level setting, it may not be possible to adjust the volume up to 60.

■ **To check the currently playing program source, etc.** Press the MENU/SET button. Display "STATUS" then press the select ◀ and ▶ control.

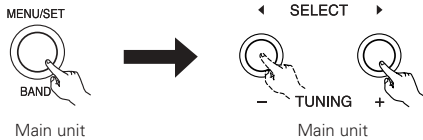

The current program source and surround settings are shown on the display each time the button is pressed or turned.

Input mode display

- In the AUTO mode



- In the DIGITAL PCM mode

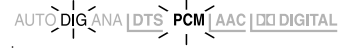

- In the DIGITAL DTS mode



- In the ANALOG mode



Input signal display

- DOLBY DIGITAL



- DTS



- PCM

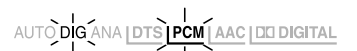

- "DIG" lights when digital signals are input properly. If "DIG" is flashing, check whether the connections are proper and whether the input component's power is on.

Input mode when playing CD sources

- When playing CDs containing recordings of live concerts, etc., in the "AUTO" mode, the sound may be slightly broken at the beginning. If this happens, switch to the "PCM" mode.

Input mode when playing DTS sources

- If DTS-compatible CDs are played in the "PCM" mode, noise is output because DTS playback is not possible. To play a DTS-compatible source, be sure to set the input mode to "AUTO" or "DTS".
- Noise may be generated at the beginning of playback and while searching during DTS playback in the AUTO mode. If so, play in the DTS mode.

(3) After starting playback

[1] Adjusting the sound quality (SDB/P.EQ)

The SDB/P.EQ function will not work in the direct mode.

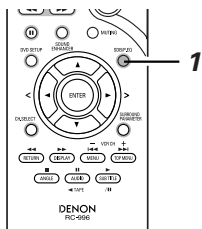
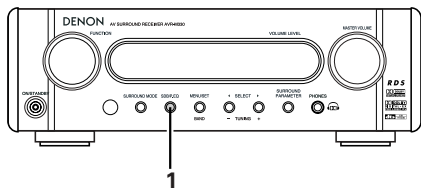

- 1** Press the SDB/P.EQ button.
- The tone switches as follows each time the SDB/P.EQ button is pressed.

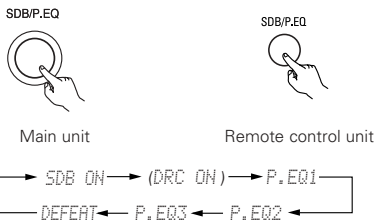

DEFEAT

- The signals do not pass through the SDB, DRC and P.EQ1~3 adjustment circuits, providing higher quality sound.

SDB ON

- SDB (Super Dynamic Bass) is turned on.

DRC ON

- DRC (Dynamic Range Compression) is turned on.
- This parameter adjusts the dynamic range of the Dolby Digital or DTS sound. When listening with the volume turned relatively low, at night for example, set this to the "ON" to lower the peak of the sound and amplify the quieter sounds, narrowing the dynamic range and making the sound easier to listen to.
- With DTS source, only displayed for sources compatible with dynamic range compression.

P.EQ1~3

- Preset Equalizer is turned on
- Three types of bass/treble balances and surround channel delay settings are preset. Select them as desired.
- ※ If no operation is performed within 4 seconds, the display switches back to what was previously displayed.

[2] Adjustment the Sound Enhancer

The SOUND ENHANCER function will not work in the direct mode.

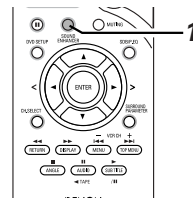

- 1** Press the SOUND ENHANCER button.
- The tone switches as follows each time the SOUND ENHANCER button is pressed.



Remote control unit



ENHANCER OFF

- The SOUND ENHANCER setting is turned off.

VOCAL ENH

- The VOCAL ENHANCER is turned on.
- The center channel is emphasized and DRC is turned on.
- When listening quietly at night, the vocals are easier to hear.

SURR.ENH

- The SURROUND ENHANCER is turned on.
- The surround channel is emphasized for a stronger sense of presence.
- ※ When SURROUND ENHANCER is turned on, SDB/P.EQ is defeated. When SDB/P.EQ is turned on, SURROUND ENHANCER is set to "ENHANCER OFF".

[3] Turning the sound off temporarily (MUTING)

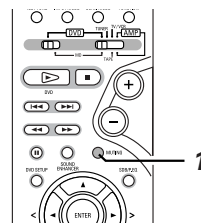

- 1** Use this to turn off the audio output temporarily. Press the MUTING button.
- ※ Cancelling MUTING mode. Press the MUTING button again.



Remote control unit

NOTES:

- The mute mode is cancelled when the main unit's main volume control or one of the main volume control buttons on the remote control unit is operated.
- The setting is cancelled if the set's power is turned off.

10 SURROUND PLAYBACK

(1) Before playing with the surround function

• Adjustments using the test tones can only be performed in the "Auto" mode and are only valid for the AUTO DECODE Surround modes. The adjusted levels are automatically stored in the memory.

• Even after adjusting using the test tones, the various channels can be adjusted using the procedure described below to suit the program source and your preferences.

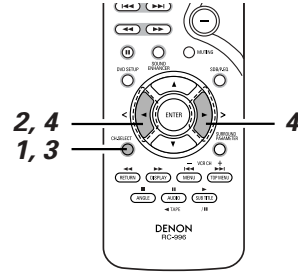
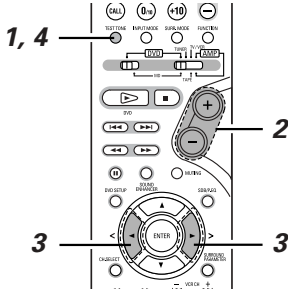

1 Press the TEST TONE button.

TEST TONE



Remote control unit

2 Test tones are output from the different speakers. Either turn the MASTER VOLUME dial on the main unit or use the VOLUME buttons on the remote control unit to adjust the volume.



Main unit

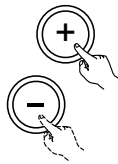

Remote control unit

3 Use the channel volume adjust buttons to adjust so that the volume of the test tones is the same for all the speakers.

- The (< and >) cursor buttons on the remote control unit during the adjustments using the test tones.

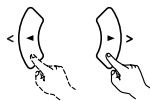

Remote control unit

4 After adjusting using the test tones, adjust the channel levels either according to the playback sources or to suit your tastes, as described below.

TEST TONE



Remote control unit

1 Press the CH.SELECT button on the remote control unit.

- The following is displayed:

LEVEL</>DELAY

CH.SELECT



Remote control unit

2 Use the select < button while the above is displayed to select "LEVEL".

- The level display shown below appears.

FL VOL< 0dB>



Remote control unit

3 Select the speaker whose level you want to adjust.

- The channel switches as shown below each time the button is pressed.

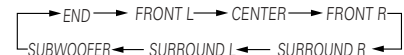

CH.SELECT



Remote control unit

4 Adjust the volume level of the selected speaker while the channel level is displayed.

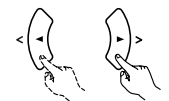

Remote control unit

※ Once the channel level setting is completed, select "END" at step 3. The display returns to normal after several seconds.

(2) Playing in the AUTO DECODE mode

- In the auto decode mode it is possible to play in the Dolby Digital or DTS Surround mode, depending on the format of the input signal.
- It is also possible to play in the Auto Stereo, Dolby Pro-Logic II Cinema/Music/Game or DTS NEO:6 Cinema/Music mode, according to the 2-channel mode setting.

[1] Dolby Digital and DTS surround playback (digital inputs only)

- Applicable sources
 - Digital inputs (DVD, TV/AUX1 and AUX2 functions)
 - Dolby Digital multi-channel sources
 - DTS sources

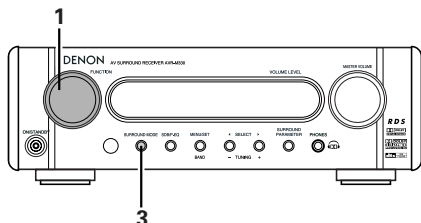

- Operate the remote control unit at the "AMP" position.

Set the remote control selector switches
Switch1 to DVD
Switch2 to AMP

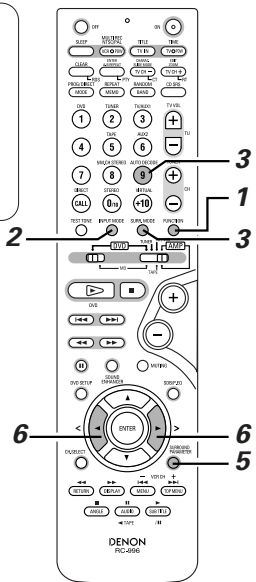

- 1 Select the digital input function. (DVD or TV/AUX1 or AUX2 digital input)

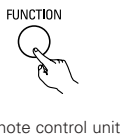
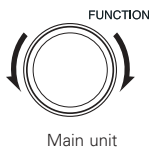

- 2 Set the input mode to "AUTO".
 * DTS sources can also be played in the input mode "DTS".

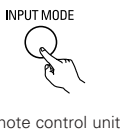

- 3 Set the surround mode to "AUTO DECODE".

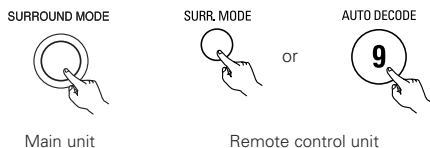

※ If the mode is set to anything other than AUTO DECODE, the AUTO DECODE mode can be set using the AUTO DECODE button on the remote control unit.

- 4 Play a program source containing the **DD DOLBY DIGITAL** or **dts** mark.

- The Dolby Digital indicator lights when playing a Dolby Digital source.
- The DTS indicator lights when playing a DTS source.

※ The mode is selected automatically according to the format of the source being played.

- 5 Display the surround parameters for the source.
 ※ Nothing is displayed if there are no parameters that can be adjusted.

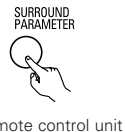

- 6 Select the various surround parameters and set them.
 ※ The display returns to normal if no operation is performed for 4 seconds while the parameters are displayed.

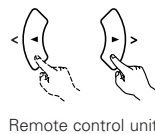

※ Stop operating buttons once the surround parameter settings have been completed. After several seconds the normal display reappears and the settings are automatically set.

NOTES:

- Signals encoded in Dolby Digital can only be played in the Auto decode (Dolby Digital, Dolby Pro Logic II or Auto stereo), Direct, stereo or virtual modes. Other modes do not work when playing Dolby Digital signals.
- DTS signals can only be played in the Auto decode (DTS), Direct, stereo or virtual modes. Other modes do not work when playing DTS signals.

[2] 2-channel mode settings

- In the AUTO DECODE mode, it is possible to automatically conduct multi-channel playback in the Dolby Digital or DTS surround mode or play in the stereo 2-channel mode (AUTO STEREO mode: factory default setting). For 2-channel input signals, one of four play modes can be set with the 2-channel mode setting (Auto Stereo, Dolby Pro Logic II Cinema, Dolby Pro Logic II Music and Dolby Pro Logic II Game). For analog and PCM sources, it is also possible to select DTS NEO:6 Cinema and DTS NEO:6 Music.
- ※ **When the function is set to TAPE or TUNER, the "Auto Stereo" 2-channel mode cannot be selected. To play in stereo, set the surround mode to "STEREO" (page 29).**

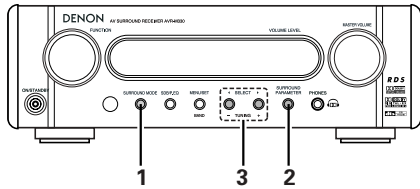

- Operate the remote control unit at the "AMP" position.

Set the remote control selector switches
Switch1 to DVD
Switch2 to AMP

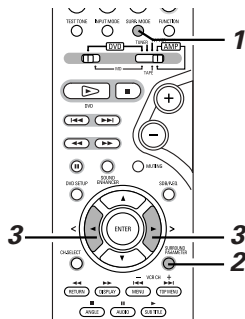

- 1** Set the surround mode to "AUTO DECODE".
 • "AUTO DECODE" is displayed, then the normal display reappears.

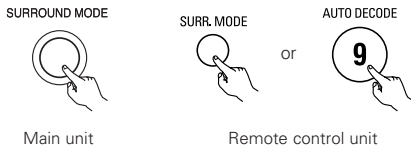

- ※ If the mode is set to anything other than AUTO DECODE, the AUTO DECODE mode can be set using the AUTO DECODE button on the remote control unit.

- 2** Press the SURROUND PARAMETER button on the remote control unit and select the 2-channel decode mode.

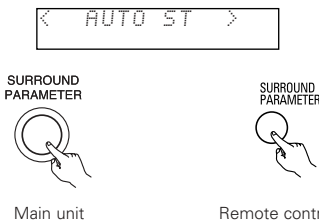

- ※ This can be selected when the digital input consists of no signal, PCM signals, Dolby Digital 2-channel signals, as well as when the analog input is selected.

- 3** Select the desired 2-channel decode mode using the (< and >) SELECT buttons.
- The mode switches as follows each time one of the buttons is pressed:

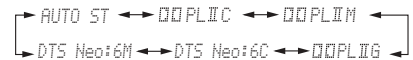
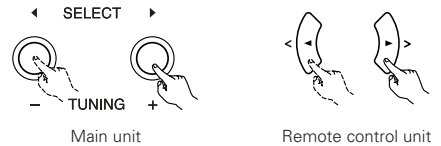

- ※ DTS NEO:6C and DTS NEO:6M can be selected for analog and PCM sources.
- ※ The Auto Stereo mode can be selected when the function is set to DVD, TV/AUX1 or AUX2.

- ※ Once the surround parameters have been set, stop operating buttons. After several seconds the display returns to normal and the settings are automatically validated.

NOTES:

- The 2-channel decode mode cannot be set when Dolby Digital 5.1-channel signals or DTS signals are being input.

Surround parameters (1) (2-channel mode)

AUTO-ST (auto stereo) mode

2-channel sources are played in 2-channel stereo.

When this mode is selected in the auto decode mode, multi-channel sources (DVD, BS digital, etc.) are played in the multi-channel mode, while 2-channel sources (CDs, etc.) are automatically played in stereo.

PLII CINEMA / PLII MUSI / PLII GAME

Even 2-channel sources undergo Dolby Pro Logic II processing and are played in the multi-channel mode.

Dolby Digital Pro-Logic II processing is applied to 2-channel sources as well to play them in the multi-channel mode.

- **PLII CINEMA (Dolby Pro Logic II CINEMA) mode**

The Cinema mode is for use with stereo television shows and all programs encoded in Dolby Surround.

- **PLII MUSIC (Dolby Pro Logic II MUSIC) mode**

The Music mode is recommended as the standard mode for auto sound music systems (no video), and is optional for AV systems.

- **PLII GAME (Dolby Pro Logic II GAME) mode**

The Game mode for playing games. The game mode can only be used with 2-channel audio sources.

DTS NEO:6 CINEMA/NEO : 6 MUSIC mode

- **NEO:6 CINEMA mode**

This mode is optimum for playing movies. Decoding is performed with emphasis on separation performance to achieve the same atmosphere with 2-channel sources as with 5.1 or 6.1-channel sources.

This mode is effective for playing sources recorded in conventional surround formats as well, because the in-phase component is assigned mainly to the center channel (C) and the reversed phase component to the surround (SL and SR channels).

- **NEO:6 MUSIC mode**

This mode is suited mainly for playing music. The front channel (FL and FR) signals bypass the decoder and are played directly so there is no loss of sound quality, and the effect of the surround signals output from the center (C) and surround (SL and SR) channels add a natural sense of expansion to the sound field.

(3) Playing in the Dolby Virtual Speaker mode

- The Dolby Virtual Speaker mode is a mode using 3D sound technology from Dolby Laboratories to achieve multi-channel surround sound using only two speakers for the front channels.
- With two speakers for the front channels, one of two modes can be selected: Reference or Wide.
- The Dolby Virtual Speaker mode can be used not only with Dolby Digital and DTS multi-channel sources but also with 2-channel sources.

[1] Playing Dolby Virtual Speaker

● Applicable sources

- Digital input (DVD, .TV/AUX1, AUX2 functions)
 - Dolby Digital multi-channel sources
 - DTS sources
 - PCM sources (Except-Fs, 96kHz PCM)
- Analog input (DVD, TUNER, TAPE-functions)

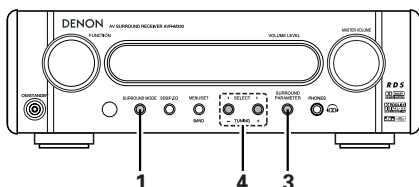

- Operate the remote control unit at the "AMP" position.

Set the remote control selector switches
Switch1 to DVD
Switch2 to AMP

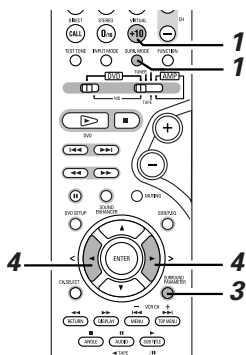

1 Set the surround mode to "DOLBY VIRTUAL SPEAKER".

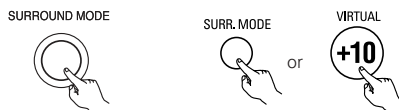

Main unit

Remote control unit

- In the Dolby Virtual Speaker mode, this indicator lights. Lit

2 Play a program source.

- The Dolby Digital indicator lights Lit
- The DTS indicator lights when playing DTS sources. Lit
- The PCM indicator lights when playing PCM sources. Lit

- ※ When 2-channel sources, the PL II indicator lights.
- ※ This switches automatically according to the format of the playback source.

3 Display the surround parameters for that source.



Main unit

Remote control unit

4

Select and set the surround parameters.

(On the remote control unit, use the < , > cursor buttons to set the parameters.)

※ If nothing is done for 4 seconds from when the parameter is displayed, the normal display reappears.

● Setting the DOLBY VS mode

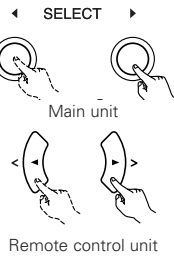

2SP Ref. ↔ 2SP Wide

※ The mode is not displayed if it cannot be selected.

※ Once the surround parameters have been set, stop operating the buttons. After several seconds, the normal display reappears and the settings are automatically entered.

Surround parameters (2)

DOLBY VS (Dolby Virtual Speaker mode)

- REF (Reference mode)
This is the standard mode.
- WIDE (Wide mode)
This mode expands the front channel sound field.

NOTES:

- Press the VIRTUAL button on the remote control unit during playback in the Dolby Virtual Speaker mode to switch between the 2-speaker, 3-speaker and 5-speaker modes.
 - 2- and 3-speaker modes :The reference and wide modes can be selected for the sound field of the front 2-channel speakers. This is convenient when it is difficult to install a surround speaker.
 - 5-speaker mode :The sound is played in the wide mode expanding the 5.1-channel playback and front 2-channel speaker sound field. This is convenient when the front speakers cannot be moved very far apart.
- Switch between the reference and wide modes by selecting the surround parameters in steps 3 and 4.

(4) Playing in the DSP surround modes

- This unit is equipped with a high performance DSP (Digital Signal Processor) which uses digital signal processing to synthetically recreate the sound field. One of 2 preset surround modes can be selected according to the program source. (Analog and PCM sources only. Except 96kHz PCM source.)

1	5CH STEREO (M. CH STEREO)	The Front left channel signals are output to the surround and surround back signal left channels, the front right channel signals are output to the surround and surround back signal right channels, and the in-phase component of the left and right channels is output to the center channel. Use this mode to enjoy stereo sound.
2	HALL	When playing recordings of live music, this mode provides a feeling similar to actually being in a concert hall. When this mode is selected, the normal program source is directed to the main speakers and a reverberated sound is directed to the surround speakers. This mode is suited to program sources which contain a large amount of reverberation.

Personal Memory Plus

This set is equipped with a personal memorize function that automatically memorizes the surround modes and input modes selected for the input different sources. When the input source is switched, the modes set for that source last time it was used are automatically recalled.

- Settings automatically stored in the memory for the individual input functions using the Personal Memory Plus function:
 - ① Surround mode (including 2-channel decode mode and Dolby Pro Logic II mode settings)
 - ② Input mode selection function
- ※ The surround parameters, SDB/P.EQ control settings and playback level balance for the different output channels are memorized for each surround mode.

(5) Playback using the Dolby Headphone mode

- The AVR-M330 is equipped with the Dolby Headphone mode, a technology developed jointly by Dolby Laboratories and Lake Technology for achieving 3D sound over regular headphones.
- The Dolby Headphone mode is set when headphones are connected to the AVR-M330's headphones jack.
- There are actually four Dolby Headphone modes creating different sound field effects: DH1, DH2, DH3 and Bypass (normal stereo playback).
- The Dolby Headphone mode is compatible with Dolby Digital and DTS multi-channel sources. With 2-channel sources, playback in the Cinema and Music modes can be selected with the 2-channel mode setting.

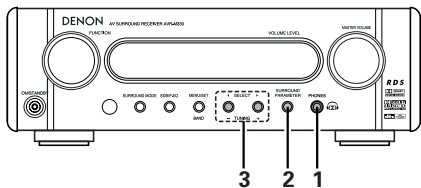

- Operate the remote control unit at the "AMP" position.

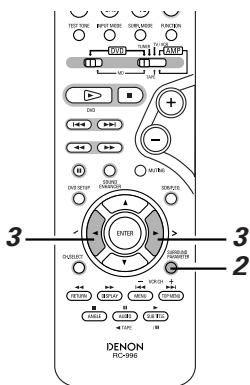
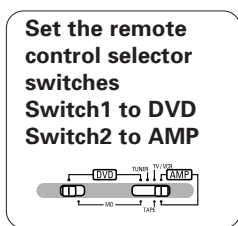

1 Connect headphones (sold separately) to the headphones jack.

- When headphones are plugged in, the output to the speakers is automatically turned off and no sound is produced from the speakers.

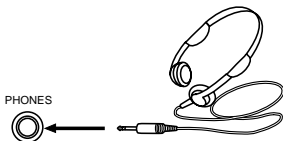

2 Press the surround parameter button and display the surround parameters.



Main unit



Remote control unit

3

- Set the various surround parameters.
- ※ If nothing is done for 6 seconds from when the parameter is displayed, the normal display reappears.

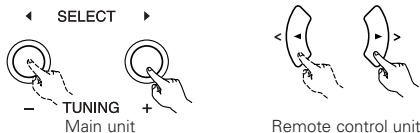

- Dolby H mode setting



- 2-channel mode setting

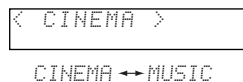

- ※ To play with normal two-channel stereo, select the "STEREO" or "DIRECT" mode using the surround mode switch. When using headphones, the mode switches as follows each time the surround mode button is pressed:

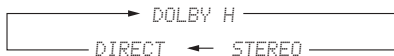

Surround parameters (3)

DOLBY H (Dolby Headphone modes)

- DH1Reference room (small room with little reverberation)
- DH2Live room (room with more reverberation than DH1)
- DH3Large room (Larger room than DH1. Use this mode to achieve a sense of distance and diffusion of the sound.)
- BYPASSStereo playback.

2-channel modes

These can be selected when playing 2-channel sources (analog, PCM, etc.). The signals are processed by one of the following decoders to achieve multiple channels then played in the Dolby Headphone mode.

- In the Bypass mode, these are not displayed.
- CINEMADolby Pro Logic II Cinema mode
- MUSICDolby Pro Logic II Music mode

(6) Setting the speaker distance

- Input the distances from the listening position to the speakers and set the surround delay time.
- The default settings below are set upon shipment from the factory.

Preparations:

Measure the distances from the listening position to the speakers (L1 to L3 on the diagram at the right).

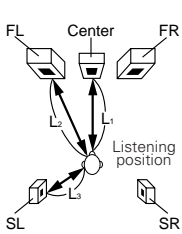

- L1: Distance from center speaker to listening position
- L2: Distance from front speakers to listening position
- L3: Distance from surround speaker to listening position

- Operate the remote control unit at the "AMP" position.

Set the remote control selector switches
Switch1 to DVD
Switch2 to AMP

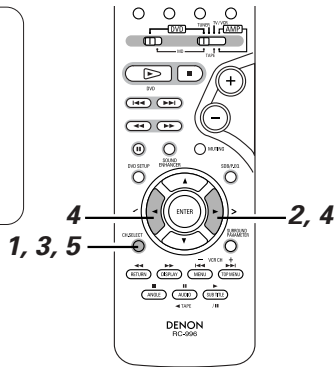
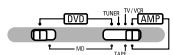

4

While the delay time is displayed, use the select < and > buttons to set the distance between the speaker and listening position.

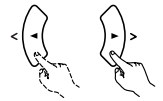

- The value changes in units of 0.3 meters each time the select < or > Remote control unit button is pressed. Select the value closest to the actually measured distance.

※ Make sure the difference of the distances set for the different speakers is no more than 4.5 meters. If an inappropriate distance is set, the distance display will flash. Change the position of the speaker and reset.

5

Once the settings are completed, use the CH.SELECT button to select "END". The settings are completed if no operations are performed for several seconds.

CH.SELECT



- The display returns to normal.

Remote control unit

- 1** Press the CH.SELECT button on the remote control unit.
- The following is displayed:

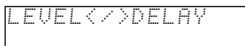

CH.SELECT



Remote control unit

- 2** Use the select ► button while the above is displayed to select "DELAY".
- The level display shown below appears.

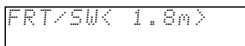

Remote control unit



- 3** Press the CH.SELECT button on the remote control unit to select the speaker whose distance is to be set.

※ The mode switches as follows each time the CH.SELECT button is pressed:

CH.SELECT



Remote control unit

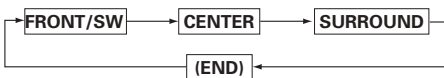

- When the 6.1- or 7.1-channel mode is set, the surround back channel can also be selected and adjusted.

■ Table of Surround Mode Parameters (1)

Surround Mode DVS: Dolby Virtual Speaker DH: Dolby Headphone		Presence/absence of signals and controllability in the various modes				
		SPEAKER			SP/PREOUT	PREOUT
		FRONT L/R	CENTER	SURROUND L/R	SUB-WOOFER	SUB-WOOFER
AUTO DECODE	DOLBY DIGITAL	○	○	○	○	×
	DTS SURROUND	○	○	○	○	×
	DOLBY PLII	○	○	○	○	×
	AUTO STEREO	○	×	×	○	×
	DTS NEO:6	○	○	○	○	△
	DOLBY PLIIx	△	△	△	△	△
	DOLBY DIGITAL EX+PLIIx	△	△	△	△	△
	DTS SURR.+NEO:6	△	△	△	△	△
DTS-ES DISCRETE/MATRIX	△	△	△	△	△	
DVS	2SPEAKER MODE	○	×	×	○	×
	3SPEAKER MODE	○	○	×	○	×
	5SPEAKER MODE	○	○	○	○	×
DH	DH1	○ (H/P ONLY)	×	×	×	×
	DH2	○ (H/P ONLY)	×	×	×	×
	DH3	○ (H/P ONLY)	×	×	×	×
	BYPASS	○ (H/P ONLY)	×	×	×	×
	STEREO	○	×	×	○ (H/P×)	×
	DIRECT	○	×	×	○ (H/P×)	×
	5CH STEREO	○	○	○	○	×
	M.CH STEREO	△	△	△	△	△
	HALL	○	○	○	○	△

■ Table of Surround Mode Parameters (2)

Surround Mode DVS: Dolby Virtual Speaker DH: Dolby Headphone		Presence/absence of signals and controllability in the various modes					
		Playback signals and surround modes for the various input functions					
		DVD,TV/AUX1,AUX2					DVD,TUNER,MD,TAPE
		When playing Dolby Digital signals		When playing DTS signals	When playing PCM signals		When playing analog signals
	2-channel	Multi-channel/EX	Multi-channel/ES	2-channel	Fs:96kHz	2-channel	
AUTO DECODE	DOLBY DIGITAL	×	○	×	×	×	
	DTS SURROUND	×	×	○	×	×	
	DOLBY PLII	●PLII	×	×	●PLII	×	
	AUTO STEREO	●	×	×	●	×	
	DTS NEO:6	×	×	×	●NEO:6	×	
	DOLBY PLIIx	●PLIIx	×	×	●PLIIx	×	
	DOLBY DIGITAL EX+PLIIx	×	●PLIIx	×	×	×	
	DTS SURR.+NEO:6	×	×	●NEO:6	×	×	
DTS-ES DISCRETE/MATRIX	×	×	○ FLAG	×	×		
DVS	2SPEAKER MODE	○	○	○	×	○	
	3SPEAKER MODE	○	○	○	×	○	
	5SPEAKER MODE	○	○	○	×	○	
DH	DH1	●PLII	○	○	●PLII	×	
	DH2	●PLII	○	○	●PLII	×	
	DH3	●PLII	○	○	●PLII	×	
	BYPASS	○	○ D.MIX	○ D.MIX	○	×	
	STEREO	○	○ D.MIX	○ D.MIX	○	○	
	DIRECT	○	○ D.MIX	○ D.MIX	○	○	
	5CH STEREO	×	×	×	×	○	
	M.CH STEREO	×	×	×	×	○	
	HALL	×	×	×	×	○	

■ : Mode only usable when "5.1CH" set with quick setup procedure.

■ : Mode only usable when "6.1CH" or "7.1CH" set with quick setup procedure.

△ : Usable when "6.1CH" or "7.1CH" selected at the Quick Setup procedure. When "6.1CH" selected: SBL/SBR preout used (1 channel) for SB.

When "7.1CH" selected: SBL/SBR preout used (2 channels)

○ : Playback signal present or selectable.

● : Mode selectable according to parameters

For details, see Tables 3 and 4.

× : No signal or not controllable.

D.MIX : Compatible with down-mixing.

PL II : Compatible with PL II processing.

PL IIx : Compatible with PL IIx processing.

FLAG : Selected automatically by "DTS ES DISCRETE FLAG"/"MATRIX FLAG"

NEO:6 : Compatible with DTS NEO:6 processing

NEO:6 : Compatible with DTS NEO:6 processing

■ Table of Surround Mode Parameters (3)

Surround Mode DVS: Dolby Virtual Speaker DH: Dolby Headphone		Presence/absence of signals and controllability in the various modes							
		SDB/PEQ (Default: DEFEAT all OFF)			Surround parameter				
					2ch Mode		DH Mode	DVS Mode	
		SDB ON	DRC ON *1	P.EQ1/2/3	Digital 2-channel	Analog 2-channel	DH1/2/3/BYPASS	Front ch Ref./Wide	
AUTO DECODE	DOLBY DIGITAL	○	○	○	○*2 (AUTO ST)	×	-	-	
	DTS SURROUND	○	○	○		×	-	-	
	DOLBY PLII	○	○	○		○*3 (PLIIC)	-	-	
	AUTO STEREO	○	○	○		×	-	-	
	DTS NEO:6	○	○	○		○*3	-	-	
	DOLBY PLIIx	○	○	○		×	×	-	-
	DOLBY DIGITAL EX+PLIIx	○	○	○		×	×	-	-
	DTS SURR.+NEO:6	○	○	○		×	×	-	-
DTS-ES DISCRETE/MATRIX	○	○	○	×	×	-	-		
DVS	2SPEAKER MODE	○	○	○	CINEMA only	CINEMA only	-	○*6 (Ref.)	
	3SPEAKER MODE	○	○	○			-	○*6 (Ref.)	
	5SPEAKER MODE	○	○	○			-	Wide only	
DH	DH1	○	×	○	○*4 (CINEMA)	○*4 (CINEMA)	○*5 (DH1)	-	
	DH2	○	×	○				-	
	DH3	○	×	○				-	
	BYPASS	○	×	○				×	×
	STEREO	○	○	○	×	×	-	-	
	DIRECT	×	×	×	×	×	-	-	
	5CH STEREO	○	×	○	×	×	-	-	
	M.CH STEREO	○	×	○	×	×	-	-	
	HALL	○	×	○	×	×	-	-	

■ Table of Surround Mode Parameters (4) Details of parameters for "6.1CH"/"7.1CH"

Surround Mode DVS: Dolby Virtual Speaker DH: Dolby Headphone		Presence/absence of signals and controllability in the various modes					
		Various playback sources and surround parameter selection for "6.1CH"/"7.1CH"					
		PCM 6.1/7.1 setting	Analog 6.1/7.1 setting	DOLBY DIGITAL/D.D. EX		DTS/DTS-ES	
				6.1ch setting	7.1ch setting	6.1ch setting	7.1ch setting
2channel source	AUTO STEREO	⊙	⊙	⊙	⊙	-	-
	DTS NEO:6 CINEMA	○	○	×	×	-	-
	DTS NEO:6 MUSIC	○	○	×	×	-	-
	DOLBY PLIIx CINEMA	○	○	○	○	-	-
	DOLBY PLIIx MUSIC	○	○	○	○	-	-
	DOLBY PLIIx GAME	○	○	○	○	-	-
Multichannel source	DOLBY DIGITAL EX	-	-	⊙	○	-	-
	DOLBY DIGITAL+PLIIx C	-	-	×	⊙	-	-
	DOLBY DIGITAL+PLIIx M	-	-	○	○	-	-
	DTS SURROUND	-	-	-	-	⊙	⊙
	DTS SURR. +NEO:6	-	-	-	-	○	○
	DTS-ES DISCRETE	-	-	-	-	○*FLAG	○*FLAG
DTS-ES MATRIX	-	-	-	-	○*FLAG	○*FLAG	

- : Mode only usable when "5.1CH" set with quick setup procedure..
- ⊙ : Mode only usable when "6.1CH" or "7.1CH" set with quick setup procedure.
- : Playback signal present or selectable.
- ×
- ⊙ : Factory defaults when "6.1CH" or "7.1CH" set with quick setup procedure.
- *FLAG: Selected automatically by "DTS ES DISCRETE FLAG"/"MATRIX FLAG"
- : Not applicable.
- () : Factory defaults of parameters.
- *1: Only selectable for Dolby and DTS DRC (dynamic range compression) compatible [discs]
- *2: Auto stereo, DOLBY PLII cinema, PLII music and PLII game selectable.
DTS NEO:6 cinema and NEO:6 music also selectable for PCM sources (other than [those with sampling frequencies of 96 kHz])
- *3: DOLBY PLII cinema, PLII music, PLII game, DTS NEO:6 cinema and NEO:6 music selectable.
- *4: Cinema (DOLBY PLII cinema) and music (PLII music) selectable.
- *5: DH1, DH2, DH3 and "BYPASS" selectable.
- *6: "Reference" and "Wide" selectable.
- *7: "MAIN" (main audio), "SUB" (sub audio) and "MAIN/SUB" selectable.

11 LISTENING TO THE RADIO

(1) Tuning

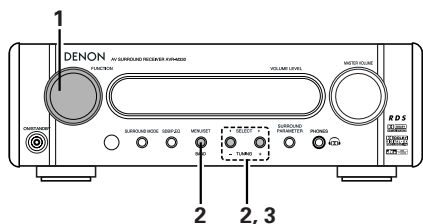

Set the remote control selector switches
Switch1 to DVD
Switch2 to TUNER

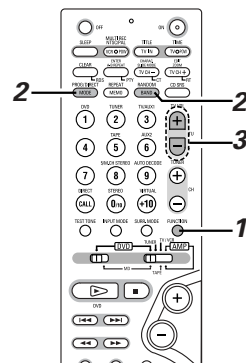

Example: Tuning in FM/AM stations

1 Select the FUNCTION "TUNER".

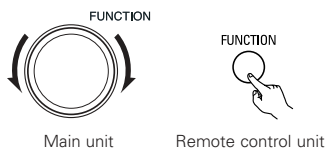

2 Select "FM" or "AM".

- The selected "FM AUTO", "FM MONO" or "AM" is displayed.
- When using the remote control, the mode button is used to select FM AUTO and MONO.

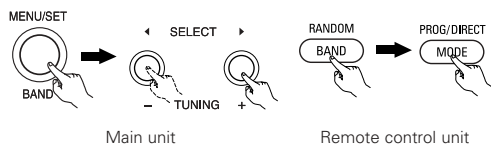

3 Adjust the receiving frequency.

- When a station is received, the "TUNED" indication will light.

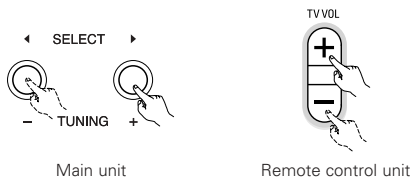

NOTE:

A humming sound may be heard when using a TV nearby while receiving AM programs. If this happens, move the system as far from the TV as possible.

Auto tuning

- When one of the Tuning +/- button is pressed, the frequency changes in steps of 50 kHz in the FM band, 9 kHz in the AM band.
- If one of the Tuning +/- button is held for over 1 second, the frequency continues to change when the button is released (auto tuning) and stops when a station is tuned in. Tuning will not stop at stations whose reception is poor.
- To stop the auto tuning function, press the Tuning +/- button once.

FM Stereo Reception

- When a program being broadcast in "FM AUTO" is received, the "ST" indicator lights and the program is received in stereo.
- If reception is poor and there is much noise in the stereo signals, press the BAND or MODE button to set the FM MONO mode.

(2) Presetting stations (remote control unit only)

- A total of 40 stations (including both FM and AM stations) can be preset.
- Preset stations using the including remote control unit.

Set the remote control selector switches
Switch1 to DVD
Switch2 to TUNER

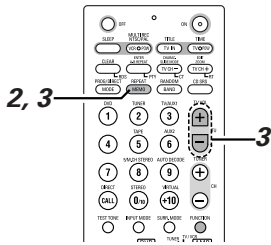
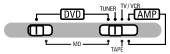

1 Tune in the station you want to preset.

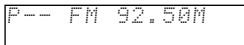

2 Press the MEMO button.

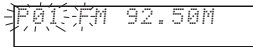

Remote control unit

3

Use the "+" and "-" preset buttons to select the preset number then press the MEMO button again to store that station at the selected number. (The number can also be specified directly using the +10 and 0 to 9 buttons on the numeric keypad.)

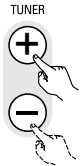
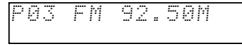
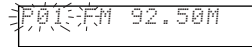

Remote control unit



Remote control unit

(3) Auto tuner presets (remote control unit only)

Use this to automatically search for FM broadcasts and store up to 40 stations at preset channels 1 to 40.

NOTE:

- If an FM station cannot be preset automatically due to poor reception, use the "Manual tuning" operation to tune in the station, then preset it using the manual "Preset memory" operation.

1 Press the MEMORY button for more than 2 second.
 Up to 40 of the best received stations in your area will be stored automatically. Then you can select each stations easily.



Remote control unit

Set the remote control selector switches
Switch1 to DVD
Switch2 to TUNER

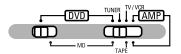

1

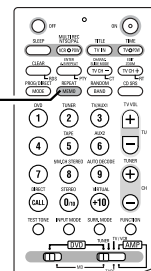

(4) Listening to preset stations (remote control unit only)

Example: Listening to the station preset at number P03 (This operation is only possible from the remote control unit.)

Set the remote control selector switches
Switch1 to DVD
Switch2 to TUNER

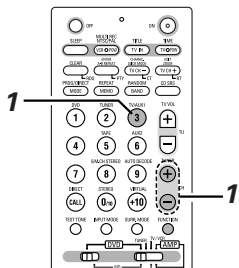

1 Use the "+" and "-" preset buttons to select preset number "3" or press the "3" button on the numeric keypad to display preset number "P03".

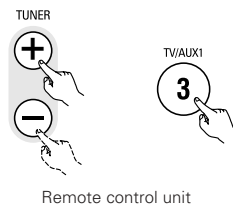

Remote control unit

※ The preset buttons on the remote control unit (TUNER CH "+" and "-") can be used at any time.

(5) RDS (Radio Data System)

RDS (works only on the FM band) is a broadcasting service which allows station to send additional information along with the regular radio program signal.

The following three types of RDS information can be received on this unit:

■ **Program Type (PTY)**

PTY identifies the type of RDS program.

The program types and their displays are as follows:

NEWS	News	ROCK M	Rock Music	PHONE IN	Phone In
AFFAIRS	Affairs	EASY M	Easy Listening	TRAVEL	Travel & Touring
INFO	Information	LIGHT M	Light Classical	LEISURE	Leisure & Hobby
SPORT	Sports	CLASSICS	Serious Classical	JAZZ	Jazz Music
EDUCATE	Education	OTHER M	Other Music	COUNTRY	Country Music
DRAMA	Drama	WEATHER	Weather & Meteorological	NATION M	National Music
CULTURE	Culture	FINANCE	Finance	OLDIES	Oldies Music
SCIENCE	Science	CHILDREN	Children's Progs	FOLK M	Folk Music
VARIED	Varied	SOCIAL	Social Affairs	DOCUMENT	Documentary
POP M	Pop Music	RELIGION	Religion		

■ **Traffic Program (TP)**

TP identifies programs that carry traffic announcements.

This allows you to easily find out the latest traffic conditions in your area before you leaving home.

■ **Radio Text (RT)**

RT allows the RDS station to send text messages that appear on the display.

NOTE: The operations described below using the RDS, PTY and RT buttons will not function in areas in which there are no RDS broadcasts.

(6) RDS search

Use this function to automatically tune to FM stations that provide RDS service.

- 1** Set the band to "FM".



Remote control unit

- 2** Press the RDS button until "RDS" appears on the display.



Remote control unit

- 3** Press the TUNING + (UP) or - (DOWN) button to automatically begin the RDS search operation.



Remote control unit

- 4** When a broadcast station is found, that station's name appears on the display.

- If no RDS station is found when all the frequencies are searched, "NO PROGRAMME" is displayed.

Set the remote control selector switches
Switch1 to DVD
Switch2 to TUNER

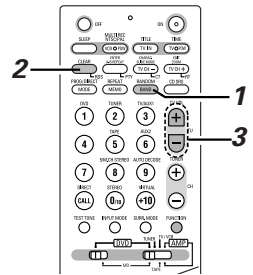

(7) PTY search

Use this function to find RDS stations broadcasting a designated program type (PTY).

For a description of each program type, refer to "Program Type (PTY)".

- 1** Set the band to "FM".



Remote control unit

- 2** Press the RDS button until "PTY" appears on the display.



Remote control unit

- 3** Watching the display, press the PTY button to call out the desired program type.



Remote control unit

- 4** Press the TUNING + (UP) or - (DOWN) button to automatically begin the PTY search operation.



Remote control unit

- 5** The station name is displayed on the display after searching stops.

- If no station broadcasting the designated program type is found when all the frequencies are searched, "NO PROGRAMME" is displayed.

(8) TP search

Use this function to find RDS stations broadcasting traffic program (TP stations).

- 1** Set the band to "FM".



Remote control unit

- 2** Press the RDS button until "TP" appears on the display.



Remote control unit

- 3** Press the TUNING + (UP) or - (DOWN) button TP search begins.



Remote control unit

- 4** The station name is displayed on the display after searching stops.

- If no TP station is found when all the frequencies are searched, "NO PROGRAMME" is displayed.

(9) RT (Radio Text)

"RT" appears on the display when radio text data is received.

- 1** To turn the RT mode on, press the RT button on the remote control unit until the RT indicator is lit.



Remote control unit

- 2** When the station currently tuned in is offering a radio text message service, the message scrolls on the display.

- When the RT mode is turned on while an RDS radio station not offering an RT service is tuned in, "NO TEXT" is displayed on the display, then the mode automatically switches to the PS mode.
- In the same way, the mode automatically switches to the PS mode when the RT service is finished. In this case, the mode automatically switches from the PS mode back to the RT mode when an RT broadcast is resumed.
- The RT mode cannot be set in the AM band or for FM stations not offering RDS broadcasts.
- To turn the RT mode off, press the RT button and switch to the desired display mode. (Refer to page 18.)

12 EXPANDING TO A 6.1- OR 7.1-CHANNEL SYSTEM

- The DHT-M330DV is equipped with a decoder function allowing 6.1- or 7.1-channel playback (Dolby Digital EX, DTS-ES, Dolby Pro-Logic IIx, etc.), as well as PRE OUT connectors for surround back channels (SBL and SBR).
- The DHT-M330DV is also equipped with a pre-out connector for a subwoofer channel, so the system can be improved using a commercially available superwoofer with built-in amplifier. (Signals are constantly output from the subwoofer pre-out connector.)
- A separately sold stereo amplifier and surround back speaker systems can be used in combination with the DHT-M330DV to create a 6.1- or 7.1-channel surround system.

(1) Connections for a 6.1- or 7.1-channel system

When using a commercially available amplifier and speakers

- Use the front left, front right, center, surround left and surround right channels with DHT-M330DV connections.
- For a 6.1-channel system, use the AVR-M330's SBL PRE OUT connector to connect the amplifier and one surround back speaker.
- For a 7.1-channel system, use the AVR-M330's SBL and SBR PRE OUT connectors to connect the amplifier and two surround back speakers.

(2) 6.1- or 7.1-channel speakers system layout

Basic system layout

- This is an example of a basic system layout using eight speaker systems and a TV.

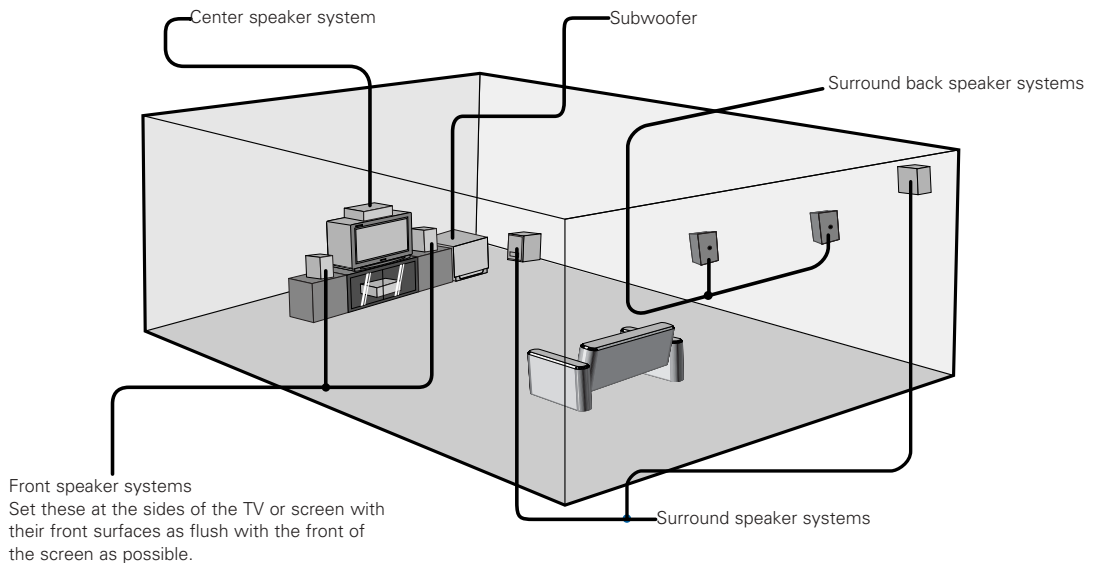

(3) 6.1- or 7.1-channel surround playback

1 Changing the Quick Setup settings

At "SPEAKER SETUP" under "Quick Setup procedure" (page 27), select the configuration to be used, "6.1CH" or "7.1CH".

2 Checking and adjusting the playback level using test tones

Before playing, use test tones to check and adjust the playback level of the different speakers. (Page 33)

- Depending on the 6.1/7.1-channel setting, the surround back channel is also displayed and can be set.

3 Setting the delay time (distance setting)

Set the distance from the different speakers at "(6) Setting the speaker distance" (Page 39) under "10 SURROUND PLAYBACK" (page 33).

- Depending on the 6.1/7.1-channel setting, the surround back channel is also displayed and can be set.

4 Surround playback in the auto decode mode

When set for 6.1- or 7.1-channel playback, the signals can be decoded and played in the Dolby Digital EX, DTS-ES and Dolby Pro Logic IIx modes.

- At "1 Dolby Digital and DTS surround playback" on page 34, Dolby Digital and multi-channel sources are played in 6.1 or 7.1 channels in the Dolby Digital EX or Dolby ProLogic IIx mode.
DTS sources are played in 6.1 or 7.1 channels in the DTS-ES or Neo:6 mode.
- For 2-channel sources: Instead of **PLII** at "2 channel mode setting" on page 35 - **PLIIx** surround parameter.
- When Dolby Digital EX or DTS-ES sources are played, "**EX**" or "DTS-ES" is displayed and the source is played in 6.1 or 7.1 channels.
- For Dolby Pro Logic IIx decoding, "**PLIIx**" is also displayed and the signals are played in 6.1 or 7.1 channels.
- For DTS Neo:6 decoding, "Neo:6" is displayed.
- For playback sources and surround modes, see "Table of Surround Mode Parameters" on pages 40 and 41.

The playing mode for the different sources can be selected using the surround parameters. (See below.)

- Dolby Digital EX
For 6.1 channels: Dolby Digital EX, Dolby Digital + PLL IIx Music
For 7.1 channels: Dolby Digital EX, Dolby Digital + PLL IIx Cinema, Dolby Digital+PLIIx Music
- DTS
For 6.1/7.1 channels: DTS surround, DTS+NEO:6
- DTS-ES
For 6.1/7.1 channels: none (fixed to DTS discrete or DTS-ES matrix depending on plug)
- Analog, digital (PCM, Dolby Digital, AAC) 2-channel sources
For 6.1/7.1 channels: Auto stereo, PLIIx Cinema, PLIIx Music, PLIIx Game
For analog and PCM 2-channel sources, DTS-NEO:6 Cinema and DTS-NEO:6 Music can also be used.

13 DOLBY/DTS SURROUND

Surround

The AVR-M330 is equipped with a digital signal processing circuit that lets you play program sources in the surround mode to achieve the same sense of presence as in a movie theater.

Dolby Surround

(1) Dolby Digital

Dolby Digital is the multi-channel digital signal format developed by Dolby Laboratories.

Dolby Digital consists of up to "5.1" channels - front left, front right, center, surround left, surround right, and an additional channel exclusively reserved for additional deep bass sound effects (the Low Frequency Effects – LFE – channel, also called the ".1" channel, containing bass frequencies of up to 120 Hz).

Unlike the analog Dolby Pro Logic format, Dolby Digital's main channels can all contain full range sound information, from the lowest bass, up to the highest frequencies – 22 kHz. The signals within each channel are distinct from the others, allowing pinpoint sound imaging, and Dolby Digital offers tremendous dynamic range from the most powerful sound effects to the quietest, softest sounds, free from noise and distortion.

■ Dolby Digital and Dolby Pro Logic

Comparison of home surround systems	Dolby Digital	Dolby Pro Logic
No. recorded channels (elements)	5.1 ch	2 ch
No. playback channels	5.1 ch	4 ch
Playback channels (max.)	L, R, C, SL, SR, SW	L, R, C, S (SW - recommended)
Audio processing	Digital discrete processing Dolby Digital encoding/decoding	Analog matrix processing Dolby Surround
High frequency playback limit of surround channel	20 kHz	7 kHz

■ Dolby Digital compatible media and playback methods

Marks indicating Dolby Digital compatibility:  .

The following are general examples. Also refer to the player's operating instructions.

Media	Dolby Digital output jacks	Playback method (reference page)
LD (VDP)	Coaxial Dolby Digital RF output jack *1	Set the input mode to "AUTO". (Page 30)
DVD	Optical or coaxial digital output (same as for PCM) *2	Set the input mode to "AUTO". (Page 30)
Others (satellite broadcasts, CATV, etc.)	Optical or coaxial digital output (same as for PCM)	Set the input mode to "AUTO". (Page 30)

*1 Please use a commercially available adapter when connecting the Dolby Digital RF output jack of the LD player to the digital input jack. Please refer to the instruction manual of the adapter when making connection.

*2 Some DVD digital outputs have the function of switching the Dolby Digital signal output method between "bit stream" and "(convert to) PCM". When playing in Dolby Digital surround on the AVR-M330, switch the DVD player's output mode to "bit stream". In some cases players are equipped with both "bit stream + PCM" and "PCM only" digital outputs. In this case connect the "bit stream + PCM" jacks to the AVR-M330.

(2) Dolby Pro Logic IIx

- Dolby Pro Logic IIx furthers the matrix decoding technology of Dolby Pro Logic II to decode audio signals recorded on two channels into up to 7.1 playback channels, including the surround back channel. Dolby Pro Logic IIx also allows 5.1-channel sources to be played in up to 7.1 channels.

The mode can be selected according to the source. The Music mode is best suited for playing music, the Cinema mode for playing movies, and the Game mode for playing games. The Game mode can only be used with 2-channel audio sources.

(3) Dolby Pro Logic II

- Dolby Pro Logic II is a new multi-channel playback format developed by Dolby Laboratories using feedback logic steering technology and offering improvements over conventional Dolby Pro Logic circuits.
- Dolby Pro Logic II can be used to decode not only sources recorded in Dolby Surround (*) but also regular stereo sources into five channels (front left, front right, center, surround left and surround right) to achieve surround sound.
- Whereas with conventional Dolby Pro Logic the surround channel playback frequency band was limited, Dolby Pro Logic II offers a wider band range (20 Hz to 20 kHz or greater). In addition, the surround channels were monaural (the surround left and right channels were the same) with previous Dolby Pro Logic, but Dolby Pro Logic II they are played as stereo signals.
- Various parameters can be set according to the type of source and the contents, so it is possible to achieve optimum decoding .

※ Sources recorded in Dolby Surround

These are sources in which three or more channels of surround have been recorded as two channels of signals using Dolby Surround encoding technology.

Dolby Surround is used for the sound tracks of movies recorded on DVDs, LDs and Video cassettes to be played on stereo VCRs, as well as for the stereo broadcast signals of FM radio, TV, satellite broadcasts and cable TV.

Decoding these signals with Dolby Pro Logic II makes it possible to achieve multi-channel surround playback. The signals can also be played on ordinary stereo equipment, in which case they provide normal stereo sound.

There are two types of DVD Dolby surround recording signals.

- ① 2-channel PCM stereo signals
- ② 2-channel Dolby Digital signals

When either of these signals is input to the AVR-M330, the surround mode is automatically set to Dolby Pro Logic II when the "AUTO DECODE" mode is selected.

■ Sources recorded in Dolby Surround are indicated with the logo mark shown below.

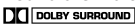
Dolby Surround support mark: 

Manufactured under license from Dolby Laboratories.
 "Dolby", "Pro Logic" and the double-D symbol are trademarks of Dolby Laboratories.

DTS Digital Surround



Digital Theater Surround (also called simply DTS) is a multi-channel digital signal format developed by Digital Theater Systems. DTS offers the same "5.1" playback channels as Dolby Digital (front left, front right and center, surround left and surround right) as well as the stereo 2-channel mode. The signals for the different channels are fully independent, eliminating the risk of deterioration of sound quality due to interference between signals, crosstalk, etc.

DTS features a relatively higher bit rate as compared to Dolby Digital (1234 kbps for CDs and LDs, 1536 kbps for DVDs) so it operates with a relatively low compression rate. Because of this the amount of data is great, and when DTS playback is used in movie theaters, a separate CD-ROM synchronized with the film is played.

With LDs and DVDs, there is of course no need for an extra disc; the pictures and sound can be recorded simultaneously on the same disc, so the discs can be handled in the same way as discs with other formats.

There are also music CDs recorded in DTS. These CDs include 5,1-channel surround signals (compared to two channels on current CDs). They do not include picture data, but they offer surround playback on CD players that are equipped with digital outputs (PCM type digital output required). DTS surround track playback offers the same intricate, grand sound as in a movie theater, right in your own listening room.

■ DTS compatible media and playback methods

Marks indicating DTS compatibility:  and .

The following are general examples. Also refer to the player's operating instructions.

Media	Dolby Digital output jacks	Playback method (reference page)
CD	Optical or coaxial digital output (same as for PCM) ※2	Set the input mode to "AUTO" or "DTS" (page 30). Never set the mode to "ANALOG" or "PCM". ※1
LD (VDP)	Optical or coaxial digital output (same as for PCM) ※2	Set the input mode to "AUTO" or "DTS" (page 30). Never set the mode to "ANALOG" or "PCM". ※1
DVD	Optical or coaxial digital output (same as for PCM) ※3	Set the input mode to "AUTO" or "DTS" (page 30).

※1 DTS signals are recorded in the same way on CDs and LDs as PCM signals. Because of this, the un-decoded DTS signals are output as random "hissy" noise from the CD or LD player's analog outputs. If this noise is played with the amplifier set at a very high volume, it may possibly cause damage to the speakers. To avoid this, be sure to switch the input mode to "AUTO" or "DTS" before playing CDs or LDs recorded in DTS. Also, never switch the input mode to "ANALOG" or "PCM" during playback. The same holds true when playing CDs or LDs on a DVD player or LD/DVD compatible player. For DVDs, the DTS signals are recorded in a special way so this problem does not occur.

※2 The signals provided at the digital outputs of a CD or LD player may undergo some sort of internal signal processing (output level adjustment, sampling frequency conversion, etc.). In this case the DTS-encoded signals may be processed erroneously, in which case they cannot be decoded by the AVR-M330, or may only produce noise. Before playing DTS signals for the first time, turn down the master volume to a low level, start playing the DTS disc, then check whether the DTS indicator on the AVR-M330 (see page 31) lights before turning up the master volume.

※3 A DVD player with DTS-compatible digital output is required to play DTS DVDs. A DTS Digital Output logo is featured on the front panel of compatible DVD players. Recent DENON DVD player models feature DTS-compatible digital output – consult the player's owner's manual for information on configuring the digital output for DTS playback of DTS-encoded DVDs.

MANUFACTURED UNDER LICENSE FROM DIGITAL THEATER SYSTEMS, INC.
 U.S. PAT. NO'S 5,451,942; 5,956,674; 5,974,380; 5,978,762; 6,226,616; 6,487,535 AND OTHER U.S. AND WORLD-WIDE PATENTS ISSUED AND PENDING.
 "DTS", "DTS-ES", AND "Neo:6" ARE TRADEMARKS OF DIGITAL THEATER SYSTEMS, INC. © 1996, 2003 DIGITAL THEATER SYSTEMS, INC. ALL RIGHTS RESERVED.

DTS-ES Extended Surround™

DTS-ES Extended Surround is a new multi-channel digital signal format developed by Digital Theater Systems Inc. While offering high compatibility with the conventional DTS Digital Surround format, DTS-ES Extended Surround greatly improves the 360-degree surround impression and space expression thanks to further expanded surround signals. This format has been used professionally in movie theaters since 1999.

In addition to the 5.1 surround channels (FL, FR, C, SL, SR and LFE), DTS-ES Extended Surround also offers the SB (Surround Back, sometimes also referred to as "surround center") channel for surround playback with a total of 6.1 channels. DTS-ES Extended Surround includes two signal formats with different surround signal recording methods, as described below.

■ DTS-ES™ Discrete 6.1

DTS-ES Discrete 6.1 is the newest recording format. With it, all 6.1 channels (including the SB channel) are recorded independently using a digital discrete system. The main feature of this format is that because the SL, SR and SB channels are fully independent, the sound can be designed with total freedom and it is possible to achieve a sense that the acoustic images are moving about freely among the background sounds surrounding the listener from 360 degrees.

Though maximum performance is achieved when sound tracks recorded with this system are played using a DTS-ES decoder, when played with a conventional DTS decoder the SB channel signals are automatically down-mixed to the SL and SR channels, so none of the signal components are lost.

■ DTS-ES™ Matrix 6.1

With this format, the additional SB channel signals undergo matrix encoding and are input to the SL and SR channels beforehand. Upon playback they are decoded to the SL, SR and SB channels. The performance of the encoder used at the time of recording can be fully matched using a high precision digital matrix decoder developed by DTS, thereby achieving surround sound more faithful to the producer's sound design aims than with conventional 5.1- or 6.1-channel systems.

In addition, the bit stream format is 100% compatible with conventional DTS signals, so the effect of the Matrix 6.1 format can be achieved even with 5.1-channel signal sources. Of course it is also possible to play DTS-ES Matrix 6.1 encoded sources with a DTS 5.1-channel decoder.

When DTS-ES Discrete 6.1 or Matrix 6.1 encoded sources are decoded with a DTS-ES decoder, the format is automatically detected upon decoding and the optimum playing mode is selected. However, some Matrix 6.1 sources may be detected as having a 5.1-channel format, so the DTS-ES Matrix 6.1 mode must be set manually to play these sources.

(For instructions on selecting the surround mode, see page 48.)

The DTS-ES decoder includes another function, the DTS Neo:6 surround mode for 6.1-channel playback of digital PCM and analog signal sources.

■ DTS Neo:6™ surround

This mode applies conventional 2-channel signals to the high precision digital matrix decoder used for DTS-ES Matrix 6.1 to achieve 6.1-channel surround playback. High precision input signal detection and matrix processing enable full band reproduction (frequency response of 20 Hz to 20 kHz or greater) for all 6.1 channels, and separation between the different channels is improved to the same level as that of a digital discrete system.

DTS Neo:6 surround includes two modes for selecting the optimum decoding for the signal source.

• DTS Neo:6 Cinema

This mode is optimum for playing movies. Decoding is performed with emphasis on separation performance to achieve the same atmosphere with 2-channel sources as with 6.1-channel sources.

This mode is effective for playing sources recorded in conventional surround formats as well, because the in-phase component is assigned mainly to the center channel (C) and the reversed phase component to the surround (SL, SR and SB channels).

• DTS Neo:6 Music

This mode is suited mainly for playing music. Changes in the sound quality are reduced by decoding with emphasis on the front channel signals (FL and FR), and a natural sense of expansion is given to the sound field by the effect of the surround signals output from the center (C) and surround (SL, SR and SB) channels.

Dolby Virtual Speaker

Dolby Virtual Speaker technology uses proprietary technology of Dolby Laboratories to create a virtual surround sound field using only two speakers for the front channels, allowing the user to experience sound as if surround speakers were actually being used.

■ Features of Dolby Virtual Speaker sound

- Accurate surround sound field positioning
The virtual surround speakers are positioned at 105° to the left and 105° to the right.
- Multi-channel programs played according to the producer's intentions
The sound of the different channels is played in the position set upon mixing. For example, sound set at the rear left is heard from the rear left.
- Stereo programs played in surround
The Dolby Pro Logic II circuit is used together with the Dolby Virtual Speaker circuitry to create a rich virtual surround sound field with stereo programs as well.
- Selecting the listening mode
Two listening modes are provided: Reference and Wide.



With the AVR-M330, playback in the Dolby Virtual Speaker mode is possible with other speaker configurations as well.

- 3 speakers (2 front channels + center) : Reference/Wide modes
- 5 speakers (2 front channels + center + 2 surround channels) : Wide mode

Dolby Headphone

Dolby Headphone is a 3D sound technology developed jointly by Dolby Laboratories and Lake Technology of Australia achieving surround sound with regular headphones.

Normally when using headphones all the sounds are sounded in the head, making it uncomfortable to listen with headphones for long periods of time. Dolby Headphone simulates speaker playback in a room and positions the sound sources to the front or the sides, outside of the head, achieving a powerful sound similar to that of a movie theater or home theater. This technology is aimed mainly at multi-channel audio or video equipment including Dolby Digital or Dolby Pro Logic Surround decoding functions and operates inside a high performance digital signal processing chip (DSP).

The Dolby Headphone mode can be used not only with multi-channel sources but also with stereo programs.

14 USING THE SLEEP TIMER

(1) Setting the sleep timer (remote control unit only)

- The included remote control unit can be used to turn the power to the standby mode after a maximum of 120 minutes. (Sleep timer)
- Use this function to automatically switch the power to the standby mode after a specific amount of time (minutes).

Example: To set the power to the standby mode in 50 minutes according to the clock. Be sure to correct the current time setting.

- Operate the remote control unit at the "AMP" position.

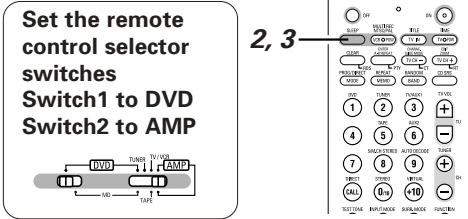

1 Select and play the desired function.

2 Press the SLEEP button.

- "120" is displayed and the "SLEEP" indicator flashes.

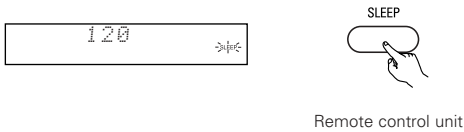

※ The display switches as follows each time the SLEEP button is pressed:

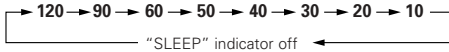

3 When the "SLEEP" indicator is flashing, press the SLEEP button again until "50" is displayed.

- "50" is displayed and the "SLEEP" indicator flashes.



- After 4 seconds, the display returns to as it was before the sleep timer was set, and the "SLEEP" indicator stops flashing, remaining lit. (This completes the sleep timer setting.)

4 The power is set to the standby mode 50 minutes later.

- ※ To turn the sleep timer off, press the SLEEP button repeatedly until the "SLEEP" indicator turns off. The sleep timer can also be turned off by press the power button on the main unit or the remote control unit to turn the entire system's power to the standby mode.

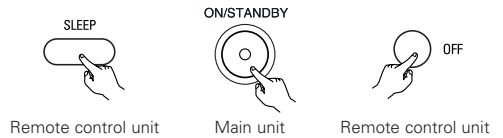

15 SYSTEM FUNCTIONS

- Making system connections between the AVR-M330 and the DVD player (DVD-M330) makes operation even easier. (For instructions on connections, refer to "Connecting the audio components" on pages 14.)
- System functions will not work properly if the input/output function settings are not right for the connected components. Be sure to set the input/output functions for the components being used. (See page 28.) The setting contents are maintained until they are next changed even when the power is switched off.

(1) Auto power on function

- When the play button on the DVD unit (▶) or the DVD play button on the remote control unit (▶) is pressed while the power is in the standby mode, the DVD-M330 and AVR-M330's power turns on automatically, and if a disc is loaded in the DVD-M330 the disc is played.

AVR-M330

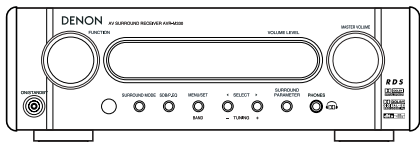

DVD-M330

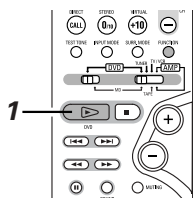
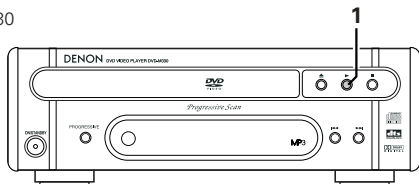

- 1 When the DVD-M330 and AVR-M330 are in the standby mode, the power can be turned on simply by pressing the play button on the DVD unit or the DVD play button on the remote control unit. If a disc is loaded, playback starts.



DVD-M330



Remote control unit

- To listen to a radio program, simply press one of the tuner preset buttons ("+" or "-") on the remote control unit. The power turns on and a station is tuned in.

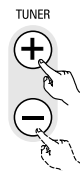

Remote control unit

(2) Auto function selection

- At the touch of a button, the function switches automatically to "DVD" and disc playback begins.

DVD-M330

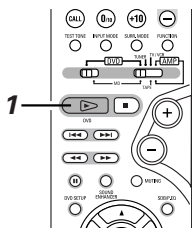
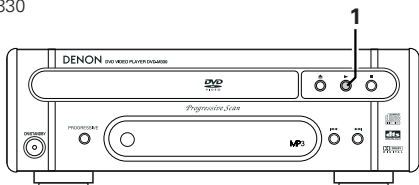

- 1 Press the play button on the DVD-M330 or the DVD play button on the remote control unit.

- The AVR-M330's function switches to "DVD" and if a disc is loaded playback of the disc starts.



DVD-M330



Remote control unit

- To listen to a radio program, simply press one of the tuner preset buttons ("+" or "-") on the remote control unit.
- Auto function selection does not work for components connected using the TV/AUX1 or AUX2 input terminals.

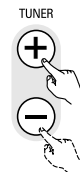

Remote control unit

16 LAST FUNCTION MEMORY

- This unit is equipped with a last function memory which stores the input and output setting conditions as they were immediately before the power is switched off. This function eliminates the need to perform complicated resettings when the power is switched on.
- The unit is also equipped with a back-up memory. This function provides memory storage when the power switch is off and with the power cord disconnected.

17 INITIALIZATION OF THE MICROPROCESSOR

When the indication of the display is not normal or when the operation of the unit does not shows the reasonable result, the initialization of the microprocessor is required by the following procedure.

- 1 Press the power button to set the standby mode, then unplug the set's power cord from the wall power outlet.

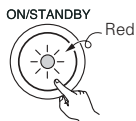

- 2 After at least 10 seconds, press the SURROUND MODE button on the AVR-M330, press the SDB/PEQ equalizer button, then press the surround mode button again for at least 2 seconds.

- 3 After several seconds, "INITIALIZE" appears on the display and the power turns on.
 - The microprocessor is initialized.

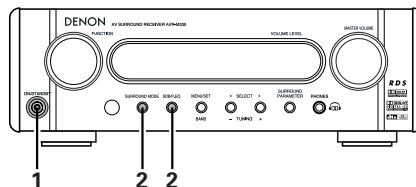

NOTES:

- If step 3 does not work, start over from step 1.
- If the microprocessor is reset, all the buttons and the setup settings are reset to the factory default values.

18 TROUBLESHOOTING

Check again before assuming the player is malfunctioning

- Are all the connections correct ?
- Are you following the instructions in the manual ?
- Are the speakers and other components operating properly ?

If this unit does not seem to be functioning properly, check the table below. If this does not solve the problem, this unit may be damaged. Turn off the power, unplug the power cord from the power outlet, and contact your store of purchase or nearest Denon sales office.

	Symptom	Cause	Measures	Page
Common problems when listening to the discs, tapes and FM broadcasts, etc.	DISPLAY not lit and sound not produced when power switch set to on.	<ul style="list-style-type: none"> • Power cord not plugged in securely. 	<ul style="list-style-type: none"> • Check the insertion of the power cord plug. 	14
	DISPLAY lit but sound not produced.	<ul style="list-style-type: none"> • Speaker cords not securely connected. • Improper position of the audio function button. • Volume control set to minimum. • MUTING is on. • Digital signals not input Digital input selected. 	<ul style="list-style-type: none"> • Connect securely. • Set to a suitable position. • Turn volume up to suitable level. • Switch off MUTING. • Input digital signals or select input jacks to which digital signals are being input. 	7 30 29 32 30
	Volume indicator on display flashing.	<ul style="list-style-type: none"> • The protection circuit has been activated due to abnormally high temperature inside the unit. 	<ul style="list-style-type: none"> • Unplug the power cord, wait for the unit to cool off, improve ventilation around the unit, then turn the power back on. 	9
	Monitor doesn't display an image.	<ul style="list-style-type: none"> • Connections between the video output jack of this unit and the input connector of the monitor are incomplete. • The input setting of the monitor TV is different. 	<ul style="list-style-type: none"> • Check whether the connections are correct. • Set the input switching of the TV to the jack to which the video input is connected. 	10 —
	The program cannot be copied from DVD to the VCR.	<ul style="list-style-type: none"> • Almost all movie software contains a copy prevention signal. 	<ul style="list-style-type: none"> • A copy cannot be made. 	—
	The subwoofer does not produce sound.	<ul style="list-style-type: none"> • Connections are incomplete. 	<ul style="list-style-type: none"> • Check the connections. 	— 7
Remote control unit	This unit does not operate properly when remote control unit is used.	<ul style="list-style-type: none"> • Batteries dead. • Remote control unit too far from this unit. • Obstacle between this unit and remote control unit. • Different button is being pressed. • ⊕ and ⊖ ends of battery inserted in reverse. • The mode selection of the remote control is not properly selected. The DVD mode, AV mode, or audio mode is not properly selected. 	<ul style="list-style-type: none"> • Replace with new batteries. • Move closer. • Remove obstacle. • Press the proper button. • Insert batteries properly. • Press the remote control mode selection button for the item you wish to operate. To operate this unit, use with the DVD mode. 	19 19 19 16 19 17
Tuner	Continuous noise is heard when receiving FM programs	<ul style="list-style-type: none"> • Antenna cable is not properly connected. 	<ul style="list-style-type: none"> • Connect the antenna cable properly. • Connect an outdoor antenna. 	12
	Hissing or continuous noise is heard when receiving AM programs	<ul style="list-style-type: none"> • This may be noise from a TV or interference from a radio station. 	<ul style="list-style-type: none"> • Turn off the TV. • Change the position and direction of the AM loop antenna. 	12
	Humming noise is heard when receiving AM programs	<ul style="list-style-type: none"> • The radio waves transmitted over the power cord are being modulated. 	<ul style="list-style-type: none"> • Unplug the power cord, flip the plug over in the opposite direction, then plug the cord back in. 	12

19 SPECIFICATIONS

■ Audio Section	
• Power Amplifier Section	
Rated output:	Front: 17 W + 17 W (6 Ω/ohm load, 1 kHz, T.H.D. 10 %) Center: 20 W (6 Ω/ohm load, 1 kHz, T.H.D. 10 %) Surround: 17 W + 17 W (6 Ω/ohm load, 1 kHz, T.H.D. 10 %) Subwoofer: 20 W (6 Ω/ohm load, 1 kHz, T.H.D. 10 %) Speaker impedance: 6 to 16 Ω/ohms
Output terminals:	
• Analog Section	
Input sensitivity/Input impedance:	400 mV/47 kΩ/kohms
Frequency response:	10 Hz to 50 kHz: +0, -3 dB (LINE, Direct mode)
Signal-to-noise ratio:	90 dB (LINE, Direct mode)
■ Tuner Section	
Reception frequency range:	FM: 87.5 MHz to 108 MHz AM: 522 kHz to 1611 kHz
Receiving sensitivity:	FM: 1.8 μV/75 Ω/ohms AM: 20 μV
FM stereo separation:	35 dB (1 kHz)
• Digital Section	
Digital input/output:	Format — Digital audio interface
■ Timer Section	
Timer:	Sleep timer: 120 minutes, maximum
■ General	
Power supply:	230 V AC, 50 Hz
Power consumption:	75 W (At standby: Approximately 1 W)
Maximum external dimensions:	210 (W) x 70 (H) x 325 (D) mm (including feet, knobs, and connectors)
Weight:	3.9 kg
■ Remote Control Unit	
Remote control method:	RC-996
Power supply:	IR pulse method 3 V DC, using two AA batteries
■ Speakers SYS-M330	
• Satellite speaker system (SC-AM330)	
Type:	2-way, 2-speakers / Closed box / Low-leakage-flux
Speakers:	5.7 cm cone bass-mid x 1 2.5 cm super-high range x 1
Input impedance:	6 Ω/ohms
Max. input:	30 watts (IEC) 80 watts (PEAK)
Dimensions:	79 (W) x 140 (H) x 123 (D) mm
Mass:	0.7 kg
• Center speaker system (SC-CM330)	
Type:	2-way, 3-speakers / Closed box / Low-leakage-flux
Speaker:	5.7 cm cone bass-mid x 2 2.5 cm super-high range x 1
Input impedance:	6 Ω/ohms
Max. input:	30 watts (IEC) 80 watts (PEAK)
Dimensions:	210 (W) x 79 (H) x 133 (D) mm
Mass:	1.0 kg
• Subwoofer (DSW-3L)	
Type:	1-way, 1-speaker / Reflex box / Low-leakage-flux
Speaker:	16 cm cone woofer x 1
Speaker impedance:	6 Ω/ohms
Frequency range:	30 Hz ~ 240 Hz
Max. input:	60 watts
Dimensions:	210 (W) x 322 (H) x 304 (D) mm (including base)
Mass:	4.9 kg (including base)

* Design and specifications are subject to change without notice in the course of product improvement.

MEMO

DENON, Ltd.

TOKYO, JAPAN
www.denon.com

Printed in China 00D 511 4267 006

Free Manuals Download Website

<http://myh66.com>

<http://usermanuals.us>

<http://www.somanuals.com>

<http://www.4manuals.cc>

<http://www.manual-lib.com>

<http://www.404manual.com>

<http://www.luxmanual.com>

<http://aubethermostatmanual.com>

Golf course search by state

<http://golfingnear.com>

Email search by domain

<http://emailbydomain.com>

Auto manuals search

<http://auto.somanuals.com>

TV manuals search

<http://tv.somanuals.com>