

# DENON

## AV SURROUND RECEIVER RÉCEPTEUR AUDIO-VIDÉO

# AVR-2802/982

## OPERATING INSTRUCTIONS MODE D'EMPLOI

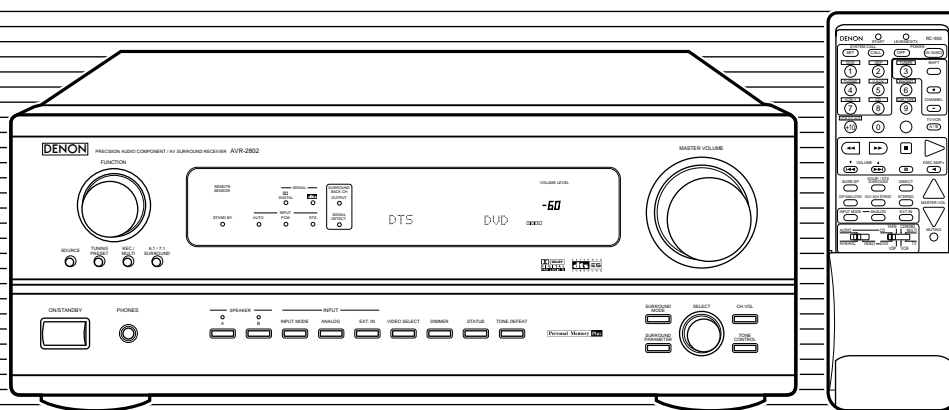

FOR ENGLISH READERS

PAGE 2 ~ PAGE 65

POUR LES LECTEURS FRANCAIS

PAGE 2, 66 ~ PAGE 127

- We greatly appreciate your purchase of the AVR-2802/982.
- To be sure you take maximum advantage of all the features the AVR-2802/982 has to offer, read these instructions carefully and use the set properly. Be sure to keep this manual for future reference should any questions or problems arise.

- Nous vous remercions de l'achat de l'AVR-2802/982.
- Pour être sûr de profiter au maximum de toutes les caractéristiques qu'a à offrir l'AVR-2802/982, lire avec soin ces instructions et bien utiliser l'appareil. Toujours conserver ce mode d'emploi pour s'y référer ultérieurement en cas de question ou de problème.

**SAFETY PRECAUTIONS**

**WARNING:**

**TO PREVENT FIRE OR SHOCK HAZARD, DO NOT EXPOSE THIS APPLIANCE TO RAIN OR MOISTURE.**



**CAUTION  
RISK OF ELECTRIC SHOCK  
DO NOT OPEN**



**CAUTION: TO REDUCE THE RISK OF ELECTRIC SHOCK, DO NOT REMOVE COVER (OR BACK). NO USER-SERVICEABLE PARTS INSIDE. REFER SERVICING TO QUALIFIED SERVICE PERSONNEL.**



The lightning flash with arrowhead symbol, within an equilateral triangle, is intended to alert the user to the presence of uninsulated "dangerous voltage" within the product's enclosure that may be of sufficient magnitude to constitute a risk of electric shock to persons.



The exclamation point within an equilateral triangle is intended to alert the user to the presence of important operating and maintenance (servicing) instructions in the literature accompanying the appliance.

**FOR CANADA MODEL ONLY**

**CAUTION**

TO PREVENT ELECTRIC SHOCK, MATCH WIDE BLADE OF PLUG TO WIDE SLOT, FULLY INSERT.

**POUR LES MODELE CANADIEN UNIQUEMENT**

**ATTENTION**

POUR ÉVITER LES CHOCS ÉLECTRIQUES, INTERODUIRE LA LAME LA PLUS LARGE DE LA FICHE DANS LA BORNE CORRESPONDANTE DE LA PRISE ET POUSSER JUSQU' AU FOND.

This device complies with Part 15 of the FCC Rules. Operation is subject to the following two conditions: (1) This device may not cause harmful interference, and (2) this device must accept any interference received, including interference that may cause undesired operation.

This Class B digital apparatus meets all requirements of the Canadian Interference-Causing Equipment Regulations.

Cet appareil numérique de la classe B respecte toutes les exigences du Règlement sur le matériel brouilleur du Canada.

"SERIAL NO. \_\_\_\_\_"

**PLEASE RECORD UNIT SERIAL NUMBER ATTACHED TO THE REAR OF THE CABINET FOR FUTURE REFERENCE"**

"NO. DE SERIE \_\_\_\_\_"

**PRIERE DE NOTER LE NUMERO DE SERIE DE L'APPAREIL INSCRIT A L'ARRIERE DU COFFRET DE FAÇON A POUVOIR LE CONSULTER EN CAS DE PROBLEME."**

**NOTE ON USE / OBSERVATIONS RELATIVES A L'UTILISATION**

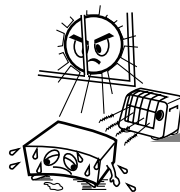

- Avoid high temperatures. Allow for sufficient heat dispersion when installed on a rack.
- Éviter des températures élevées. Tenir compte d'une dispersion de chaleur suffisante lors de l'installation sur une étagère.

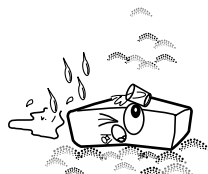

- Keep the set free from moisture, water, and dust.
- Protéger l'appareil contre l'humidité, l'eau et la poussière.

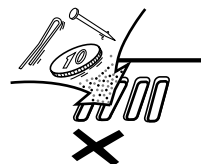

- Do not let foreign objects in the set.
- Ne pas laisser des objets étrangers dans l'appareil.



- Handle the power cord carefully. Hold the plug when unplugging the cord.
- Manipuler le cordon d'alimentation avec précaution. Tenir la prise lors du débranchement du cordon.

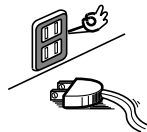

- Unplug the power cord when not using the set for long periods of time.
- Débrancher le cordon d'alimentation lorsque l'appareil n'est pas utilisé pendant de longues périodes.



- Do not let insecticides, benzene, and thinner come in contact with the set.
- Ne pas mettre en contact des insecticides, du benzène et un diluant avec l'appareil.



\* (For sets with ventilation holes)

- Do not obstruct the ventilation holes.
- Ne pas obstruer les trous d'aération.



- Never disassemble or modify the set in any way.
- Ne jamais démonter ou modifier l'appareil d'une manière ou d'une autre.

# SAFETY INSTRUCTIONS

1. Read Instructions – All the safety and operating instructions should be read before the appliance is operated.
2. Retain Instructions – The safety and operating instructions should be retained for future reference.
3. Heed Warnings – All warnings on the appliance and in the operating instructions should be adhered to.
4. Follow Instructions – All operating and use instructions should be followed.
5. Water and Moisture – The appliance should not be used near water – for example, near a bathtub, washbowl, kitchen sink, laundry tub, in a wet basement, or near a swimming pool, and the like.
6. Carts and Stands – The appliance should be used only with a cart or stand that is recommended by the manufacturer.
- 6A. An appliance and cart combination should be moved with care. Quick stops, excessive force, and uneven surfaces may cause the appliance and cart combination to overturn.
7. Wall or Ceiling Mounting – The appliance should be mounted to a wall or ceiling only as recommended by the manufacturer.
8. Ventilation – The appliance should be situated so that its location or position does not interfere with its proper ventilation. For example, the appliance should not be situated on a bed, sofa, rug, or similar surface that may block the ventilation openings; or, placed in a built-in installation, such as a bookcase or cabinet that may impede the flow of air through the ventilation openings.
9. Heat – The appliance should be situated away from heat sources such as radiators, heat registers, stoves, or other appliances (including amplifiers) that produce heat.
10. Power Sources – The appliance should be connected to a power supply only of the type described in the operating instructions or as marked on the appliance.
11. Grounding or Polarization – Precautions should be taken so that the grounding or polarization means of an appliance is not defeated.
12. Power-Cord Protection – Power-supply cords should be routed so that they are not likely to be walked on or pinched by items placed upon or against them, paying particular attention to cords at plugs, convenience receptacles, and the point where they exit from the appliance.
14. Cleaning – The appliance should be cleaned only as recommended by the manufacturer.
15. Power Lines – An outdoor antenna should be located away from power lines.
16. Outdoor Antenna Grounding – If an outside antenna is connected to the receiver, be sure the antenna system is grounded so as to provide some protection against voltage surges and built-up static charges. Article 810 of the National Electrical Code, ANSI/NFPA 70, provides information with regard to proper grounding of the mast and supporting structure, grounding of the lead-in wire to an antenna-discharge unit, size of grounding conductors, location of antenna-discharge unit, connection to grounding electrodes, and requirements for the grounding electrode. See Figure A.
17. Nonuse Periods – The power cord of the appliance should be unplugged from the outlet when left unused for a long period of time.
18. Object and Liquid Entry – Care should be taken so that objects do not fall and liquids are not spilled into the enclosure through openings.
19. Damage Requiring Service – The appliance should be serviced by qualified service personnel when:
  - A. The power-supply cord or the plug has been damaged; or
  - B. Objects have fallen, or liquid has been spilled into the appliance; or
  - C. The appliance has been exposed to rain; or
  - D. The appliance does not appear to operate normally or exhibits a marked change in performance; or
  - E. The appliance has been dropped, or the enclosure damaged.
20. Servicing – The user should not attempt to service the appliance beyond that described in the operating instructions. All other servicing should be referred to qualified service personnel.

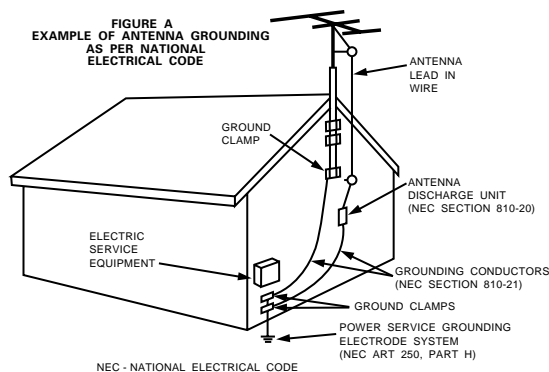

■ INTRODUCTION

Thank you for choosing the DENON AVR-2802/982 Digital Surround A / V receiver. This remarkable component has been engineered to provide superb surround sound listening with AV theater sources such as DVD, as well as providing outstanding high fidelity reproduction of your favorite music sources.

As this product is provided with an immense array of features, we recommend that before you begin hookup and operation that you review the contents of this manual before proceeding.

TABLE OF CONTENTS

1 Before Using .....4	9 Operation .....35~41
2 Cautions on Installation .....4	10 Surround .....42~46
3 Cautions on Handling .....5	11 DSP Surround Simulation.....47~52
4 Features .....5	12 Listening to the Radio .....53~55
5 Connections .....6~13	13 Last Function Memory .....55
6 Part Names and Functions .....14, 15	14 Initialization of the Microprocessor .....55
7 Setting up the system .....16~26	15 Troubleshooting.....56
8 Remote Control Unit.....27~35	16 Additional Information .....57~64
	17 Specifications .....65

■ ACCESSORIES

Check that the following parts are included in addition to the main unit:

① Operating instructions.....1	② Warranty ( for North America model only ).....1	③ Service station list.....1	④ Remote control unit (RC-903).....1
⑤ R6P/AA batteries.....2	⑥ AM loop antenna.....1	⑦ FM indoor antenna...1	

1 BEFORE USING

Pay attention to the following before using this unit:

- **Moving the set**  
To prevent short circuits or damaged wires in the connection cords, always unplug the power cord and disconnect the connection cords between all other audio components when moving the set.
- **Before turning the power switch on**  
Check once again that all connections are proper and that there are not problems with the connection cords. Always set the power switch to the standby position before connecting and disconnecting connection cords.

- **Store this instructions in a safe place.**  
After reading, store this instructions along with the warranty in a safe place.
- **Note that the illustrations in this instructions may differ from the actual set for explanation purposes.**

2 CAUTIONS ON INSTALLATION

Noise or disturbance of the picture may be generated if this unit or any other electronic equipment using microprocessors is used near a tuner or TV.

If this happens, take the following steps:

- Install this unit as far as possible from the tuner or TV.
- Set the antenna wires from the tuner or TV away from this unit's power cord and input/output connection cords.
- Noise or disturbance tends to occur particularly when using indoor antennas or 300 Ω/ohms feeder wires. **We recommend using outdoor antennas and 75 Ω/ohms coaxial cables.**

**For heat dispersal, leave at least 10 cm of space between the top, back and sides of this unit and the wall or other components.**

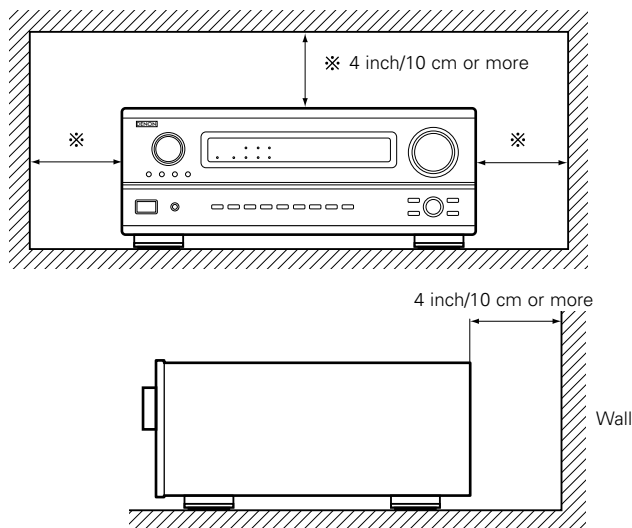

### 3 CAUTIONS ON HANDLING

- **Switching the input function when input jacks are not connected**

A clicking noise may be produced if the input function is switched when nothing is connected to the input jacks. If this happens, either turn down the MASTER VOLUME control or connect components to the input jacks.

- **Muting of PRE OUT jacks, HEADPHONE jack and SPEAKER terminals**

The PRE OUT jacks, HEADPHONE jacks and SPEAKER terminals include a muting circuit. Because of this, the output signals are greatly reduced for several seconds after the power switch is turned on or input function, surround mode or any other-set-up is changed. If the volume is turned up during this time, the output will be very high after the muting circuit stops functioning. Always wait until the muting circuit turns off before adjusting the volume.

- **Whenever the power switch is in the STANDBY state, the apparatus is still connected on AC line voltage. Please be sure to unplug the cord when you leave home for, say, a vacation.**

### 4 FEATURES

#### 1. Multi Room Music Entertainment System

Multi Source Function:

This unit's Multi Source function lets you select different audio or video sources for viewing or listening. Different sources can thus be enjoyed in the main room and the subroom simultaneously.

#### 2. Dolby Pro Logic II decoder

Dolby Pro Logic II is a new format for playing multichannel audio signals that offers improvements over conventional Dolby Pro Logic. It can be used to decode not only sources recorded in Dolby Surround but also regular stereo sources into five channels (front left/right, center and surround left/right). In addition, various parameters can be set according to the type of source and the contents, so you can adjust the sound field with greater precision.

#### 3. Dolby Digital

Using advanced digital processing algorithms, Dolby Digital provides up to 5.1 channels of wide-range, high fidelity surround sound. Dolby Digital is the default digital audio delivery system for North American DVD and DTV.

#### 4. DTS (Digital Theater Systems)

DTS provides up to 5.1 channels of wide-range, high fidelity surround sound, from sources such as laser disc, DVD and specially-encoded music discs.

#### 5. DTS-ES Extended Surround and DTS Neo:6

The AVR-2802/982 is compatible with DTS-ES Extended Surround, a new multi-channel format developed by Digital Theater Systems Inc. The AVR-2802/982 is also compatible with DTS Neo:6, a surround mode allowing 6.1-channel playback of regular stereo sources.

#### 6. Component Video Switching

In addition to composite video and "S" video switching, the AVR-2802/982 provides 2 sets of component video (Y, P<sub>B</sub>/C<sub>B</sub>, P<sub>R</sub>/C<sub>R</sub>) inputs for the DVD and TV/DBS inputs, and one set of component video outputs to the television, for superior picture quality.

#### 7. Video Select Function

Allow you to watch one source (visual) while listening to another source (audio).

## 5 CONNECTIONS

- Do not plug in the AC cord until all connections have been completed.
- Be sure to connect the left and right channels properly (left with left, right with right).
- Insert the plugs securely. Incomplete connections will result in the generation of noise.
- **Use the AC OUTLETS for audio equipment only. Do not use them for hair driers, etc.**

- Note that binding pin plug cords together with AC cords or placing them near a power transformer will result in generating hum or other noise.
- Noise or humming may be generated if a connected audio equipment is used independently without turning the power of this unit on. If this happens, turn on the power of the this unit.

### Connecting the audio components

- When making connections, also refer to the operating instructions of the other components. The power to these outlets is turned on and off when the power is switched between on and standby from the remote control unit or power switch.

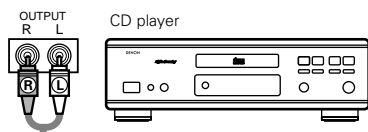

#### Connecting a CD player

Connect the CD player's analog output jacks (ANALOG OUTPUT) to this unit's CD jacks using pin plug cords.

#### Connecting a turntable

Connect the turntable's output cord to the AVR-2802/982's PHONO jacks, the L (left) plug to the L jack, the R (right) plug to the right jack.

#### NOTES:

- This unit cannot be used with MC cartridges directly. Use a separate head amplifier or step-up transformer.
- If humming or other noise is generated when the ground wire is connected, disconnect the ground wire.



Ground wire

#### Connecting the AC OUTLETS

##### AC OUTLETS

- SWITCHED (total capacity - 120 W (1 A.))

The power to these outlets is turned on and off in conjunction with the POWER operation switch on the main unit, and when the power is switched between on and standby from the remote control unit.

No power is supplied from these outlets when this unit's power is at standby. Never connect equipment whose total capacity is above 120 W (1 A.).

##### NOTE:

Only use the AC OUTLETS for audio equipment. Never use them for hair driers, TVs or other electrical appliances.

#### Connecting the pre-out jacks

Use these jacks if you wish to connect external power amplifier(s) to increase the power of the front, center, surround and surround back sound channels, or for connection to powered loudspeakers.

- ※ To use Surround back with one speaker, connect the external power amplifier to SURR. BACK L CH.

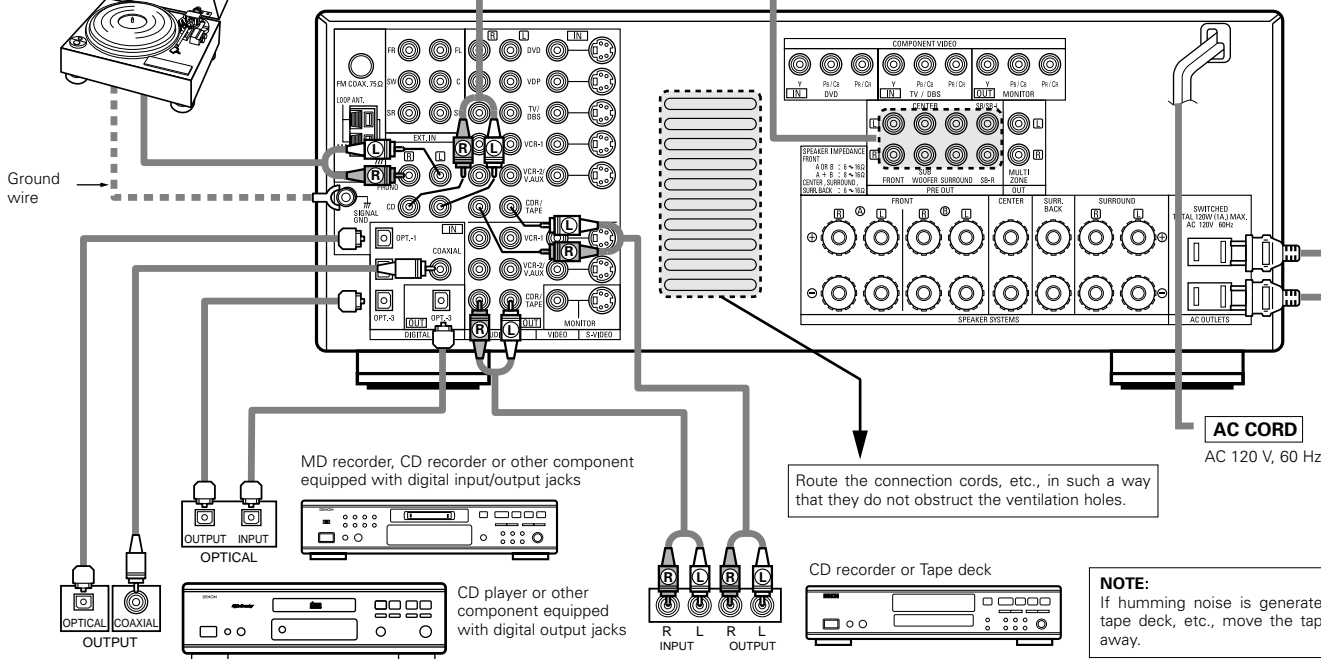

**AC CORD**  
AC 120 V, 60 Hz

Route the connection cords, etc., in such a way that they do not obstruct the ventilation holes.

#### Connecting the DIGITAL jacks

Use these for connections to audio (video) equipment with digital output. Refer to page 24 for instructions on setting this terminal.

#### NOTES:

- Use 75 Ω/ohms cable pin cords for coaxial connections.
- Use optical cables for optical connections, removing the cap before connecting.

#### Connecting a tape deck

##### Connections for recording:

Connect the tape deck's recording input jacks (LINE IN or REC) to this unit's tape recording (CDR/TAPE OUT) jacks using pin plug cords.

##### Connections for playback:

Connect the tape deck's playback output jacks (LINE OUT or PB) to this unit's tape playback (CDR/TAPE IN) jacks using pin plug cords.

#### NOTE:

If humming noise is generated by a tape deck, etc., move the tape deck away.

## Connecting video components

- To connect the video signal, connect using a 75  $\Omega$ /ohms video signal cable cord. Using an improper cable can result in a drop in video quality.
- When making connections, also refer to the operating instructions of the other components.

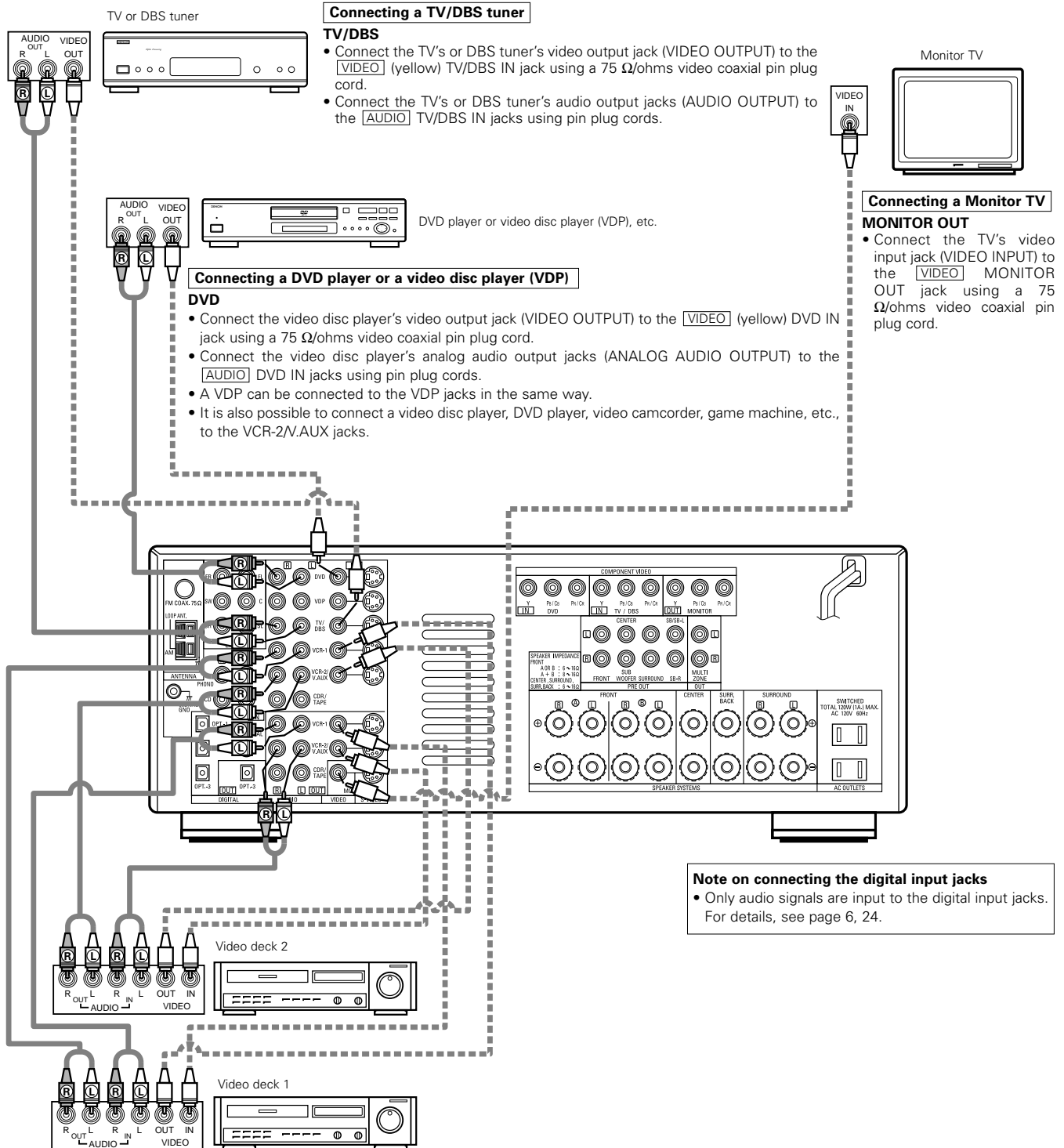

## Connecting a video component equipped with S-Video jacks

• When making connections, also refer to the operating instructions of the other components.

• **A note on the S input jacks**

The input selectors for the S inputs and pin jack inputs work in conjunction with each other.

• **Precaution when using S-jacks**

This unit's S-jacks (input and output) and video pin jacks (input and output) have independent circuit structures, so that video signals input from the S-jacks are only output from the S-jack outputs and video signals input from the pin jacks are only output from the pin jack outputs. When connecting this unit with equipment that is equipped with S-jacks, keep the above point in mind and make connections according to the equipment's instruction manuals.

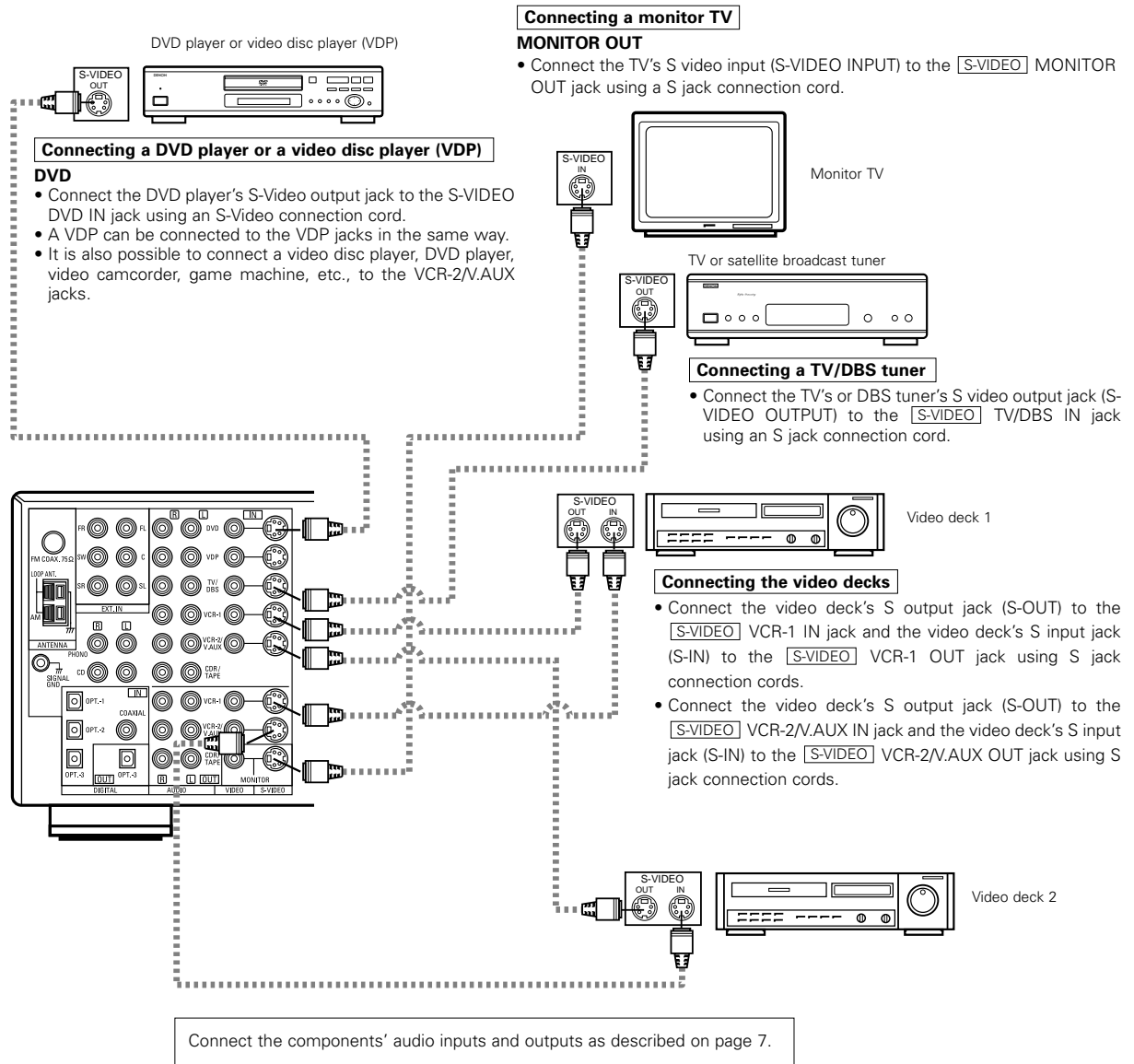



## Connecting a Video Component Equipped with Color Difference (Component - Y, Pr/Cr, Pb/Cb) Video Jacks (DVD Player)

- When making connections, also refer to the operating instructions of the other components.
- The signals input to the color difference (component) video jacks are not output from the VIDEO output jack (yellow) or the S-Video output jack. In addition, the video signals input to the VIDEO input (yellow) and S-Video input jacks are not output to the color difference (component) video jacks.
- The AVR-2802/982's on-screen display signals are not output from the color difference (component) video output jacks (MONITOR OUT).
- Some video sources with component video outputs are labeled Y, Cb, Cr, or Y, Pb, Pr, or Y, R-Y, B-Y. These terms all refer to component video color difference output.

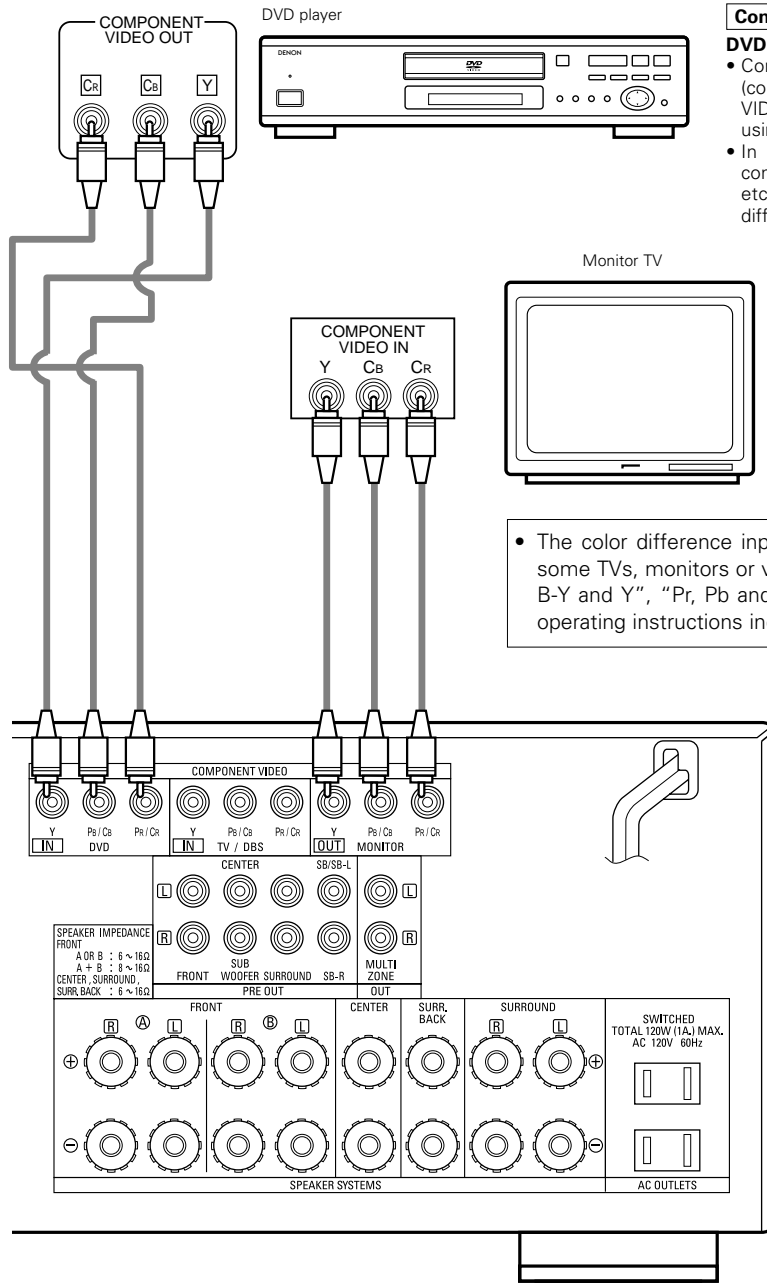

### Connecting a DVD player

#### DVD IN jacks

- Connect the DVD player's color difference (component) video output jacks (COMPONENT VIDEO OUTPUT) to the COMPONENT DVD IN jack using 75  $\Omega$ /ohms coaxial video pin-plug cords.
- In the same way, another video source with component video outputs such as a TV/DBS tuner, etc., can be connected to the TV/DBS color difference (component) video jacks.

### Connecting a monitor TV

#### MONITOR OUT jack

- Connect the TV's color difference (component) video input jacks (COMPONENT VIDEO INPUT) to the COMPONENT MONITOR OUT jack using 75  $\Omega$ /ohms coaxial video pin-plug cords.

- The color difference input jacks may be indicated differently on some TVs, monitors or video components ("Cr, Cb and Y", "R-Y, B-Y and Y", "Pr, Pb and Y", etc.). For details, carefully read the operating instructions included with the TV or other component.

## Connecting the antenna terminals

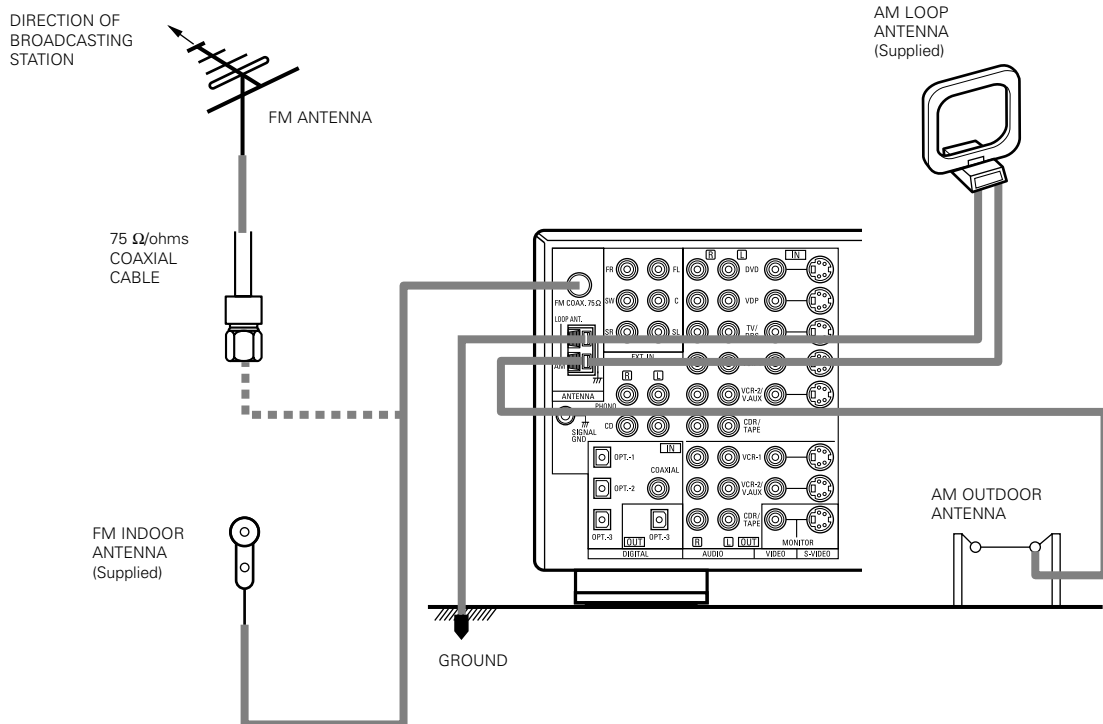

- An F-type FM antenna cable plug can be connected directly.

### AM loop antenna assembly

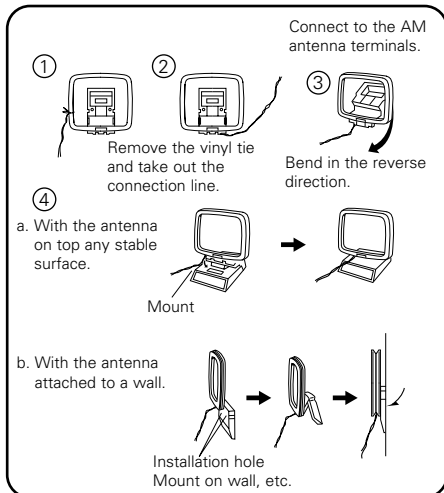

### Connection of AM antennas

1. Push the lever.
2. Insert the conductor.
3. Return the lever.

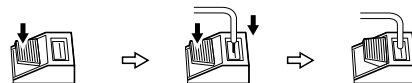

### Note to CATV system installer:

This reminder is provided to call the CATV system installer's attention to Article 820-40 of the NEC which provides guidelines for proper grounding and, in particular, specifies that the cable ground shall be connected to the grounding system of the building, as close to the point of cable entry as practical.

### Notes:

- Do not connect two FM antennas simultaneously.
- Even if an external AM antenna is used, do not disconnect the AM loop antenna.
- Make sure AM loop antenna lead terminals do not touch metal parts of the panel.

## Connecting the external input (EXT. IN) jacks

- These jacks are for inputting multi-channel audio signals from an outboard decoder, or a component with a different type of multi-channel decoder, such as a DVD Audio player, or a multi-channel SACD player, or other future multi-channel sound format decoder.
- When making connections, also refer to the operating instructions of the other components.

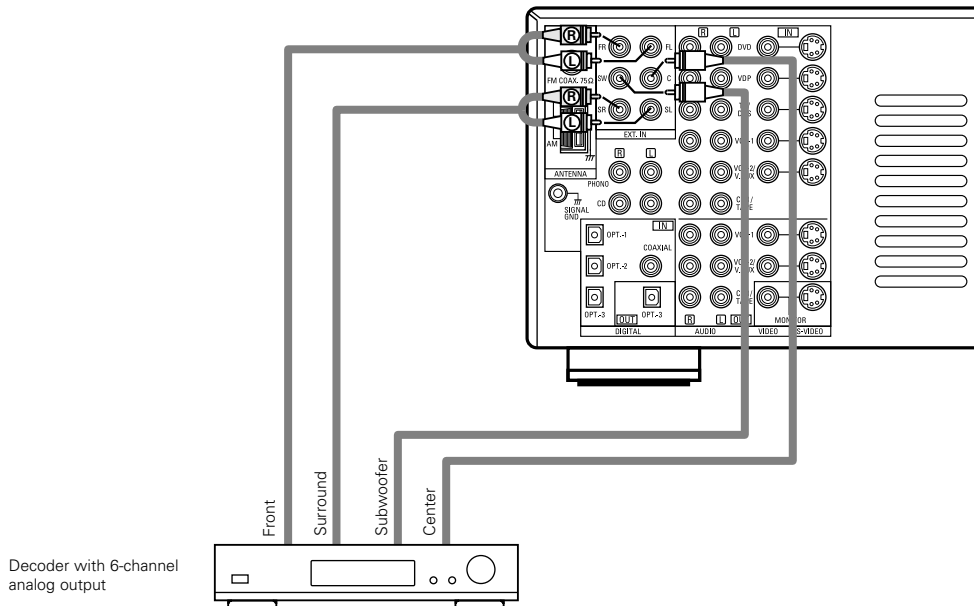

※ For instructions on playback using the external input (EXT. IN) jacks, see page 38.

## Connecting the MULTI ZONE jacks

- If another pre-main (integrated) amplifier is connected, the multi-zone jacks can be used to play a different program source in another room at the same time.

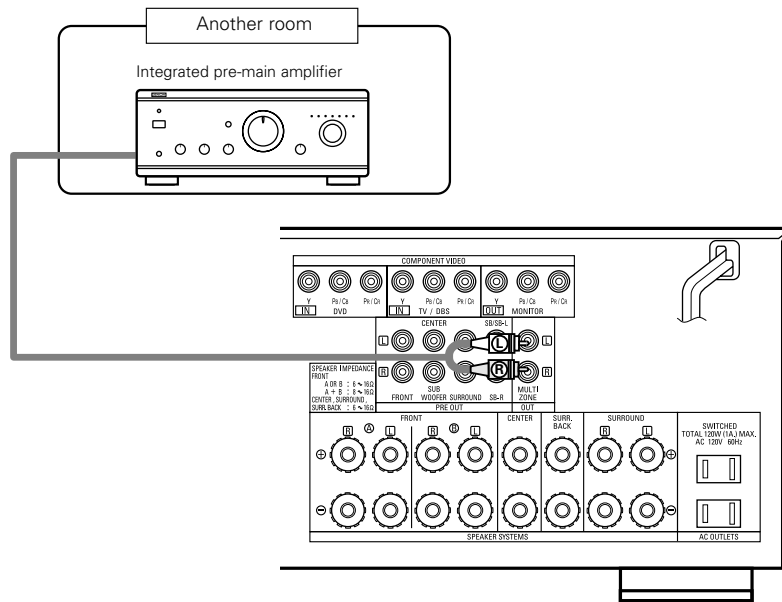

※ For instructions on operations using the MULTI ZONE jacks, see page 40, 41.

## Speaker system connections

- Connect the speaker terminals with the speakers making sure that like polarities are matched ( $\oplus$  with  $\oplus$ ,  $\ominus$  with  $\ominus$ ). Mismatching of polarities will result in weak central sound, unclear orientation of the various instruments, and the sense of direction of the stereo being impaired.
- When making connections, take care that none of the individual conductors of the speaker cord come in contact with adjacent terminals, with other speaker cord conductors, or with the rear panel.

### NOTE:

**NEVER touch the speaker terminals when the power is on. Doing so could result in electric shocks.**

### Speaker Impedance

- Speakers with an impedance of from 6 to 16  $\Omega$ /ohms can be connected for use as front and center speakers.
- Speakers with an impedance of 6 to 16  $\Omega$ /ohms can be connected for use as surround and surround back speakers.
- Be careful when using two pairs of front speakers (A + B) at the same time, since use of speakers with an impedance of less than 8  $\Omega$ /ohms will lead to damage.
- The protector circuit may be activated if the set is played for long periods of time at high volumes when speakers with an impedance lower than the specified impedance are connected.

### Connection the speaker terminals

1. Loosen by turning counterclockwise



2. Insert the cord.



3. Tighten by turning clockwise.



### Connecting banana plugs

banana plug

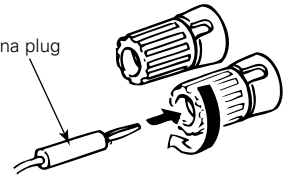

Turn clockwise to tighten, then insert the banana plug.

## Protector circuit

- This unit is equipped with a high-speed protection circuit. The purpose of this circuit is to protect the speakers under circumstances such as when the output of the power amplifier is inadvertently short-circuited and a large current flows, when the temperature surrounding the unit becomes unusually high, or when the unit is used at high output over a long period which results in an extreme temperature rise.

When the protection circuit is activated, the speaker output is cut off and the power supply indicator LED flashes. Should this occur, please follow these steps: be sure to switch off the power of this unit, check whether there are any faults with the wiring of the speaker cables or input cables, and wait for the unit to cool down if it is very hot. Improve the ventilation condition around the unit and switch the power back on.

If the protection circuit is activated again even though there are no problems with the wiring or the ventilation around the unit, switch off the power and contact a DENON service center.

## Note on speaker impedance

- The protector circuit may be activated if the set is played for long periods of time at high volumes when speakers with an impedance lower than the specified impedance (for example speakers with an impedance of lower than 4  $\Omega$ /ohms) are connected. If the protector circuit is activated, the speaker output is cut off. Turn off the set's power, wait for the set to cool down, improve the ventilation around the set, then turn the power back on.

**Connections**

- When making connections, also refer to the operating instructions of the other components.

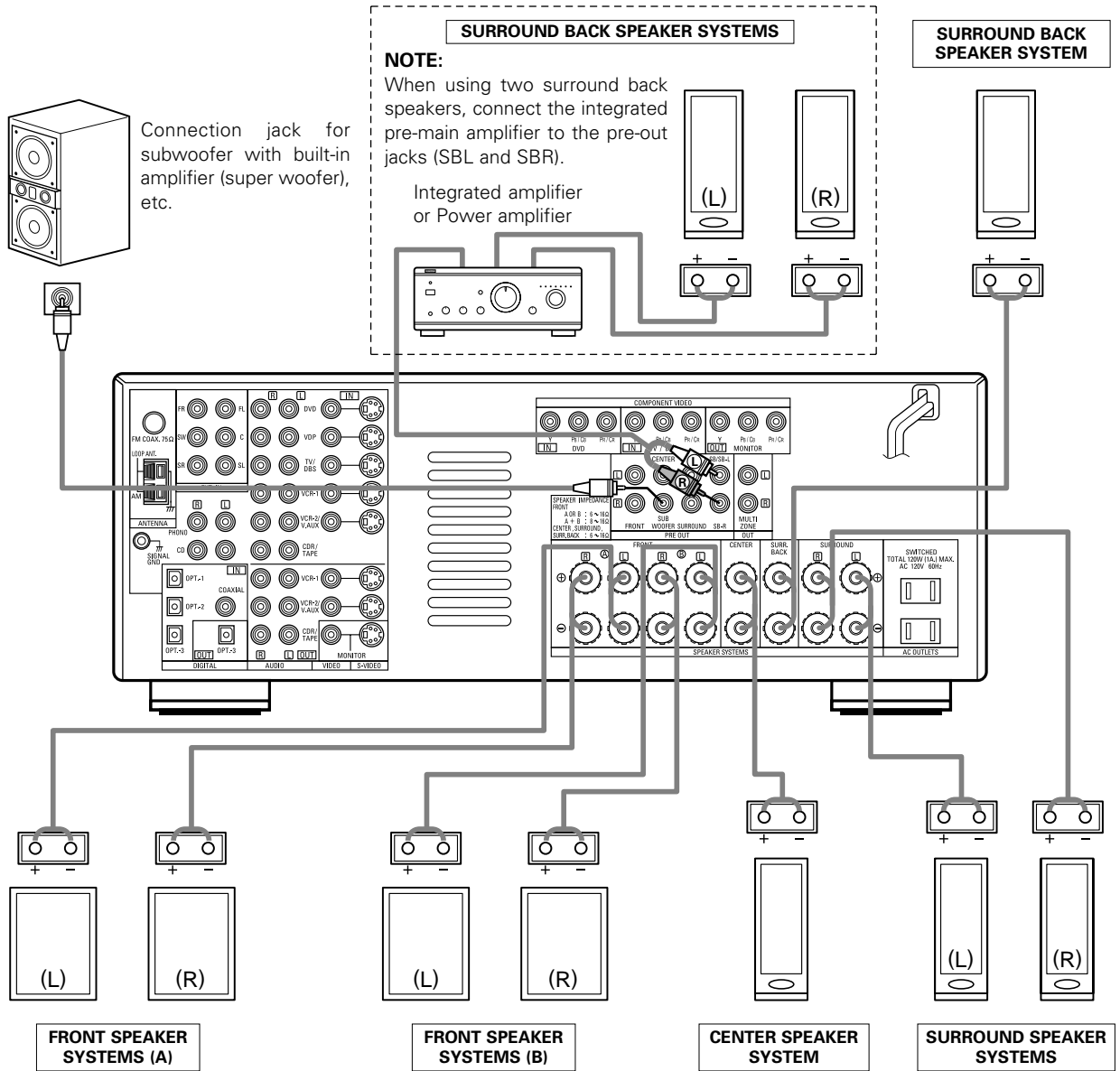

**• Precautions when connecting speakers**

If a speaker is placed near a TV or video monitor, the colors on the screen may be disturbed by the speaker's magnetism. If this should happen, move the speaker away to a position where it does not have this effect.

## 6 PART NAMES AND FUNCTIONS

### Front Panel

- For details on the functions of these parts, refer to the pages given in parentheses ( ).

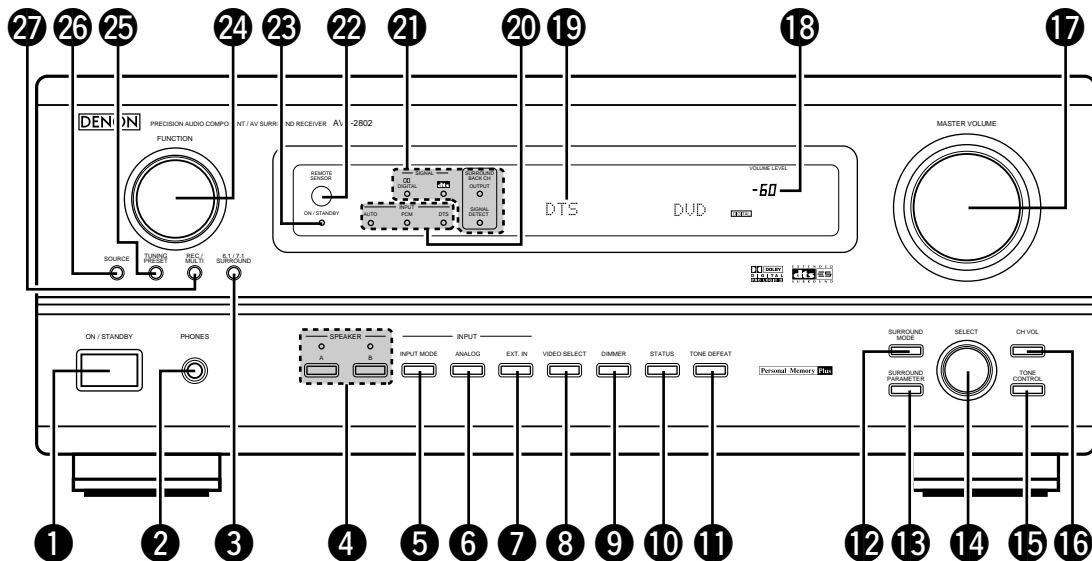

- |   |   |
|---|---|
| 1 Power ON/STANDBY switch.....(35)  | 15 TONE CONTROL button .....(38, 50)                |
| 2 Headphones jack (PHONES) .....(39)                                      | 16 CH VOL button.....(42, 43)                       |
| 3 6.1/7.1 SURROUND button.....(45)  | 17 MASTER VOLUME control .....(37)                  |
| 4 Front speaker system selector buttons<br>(SPEAKER A/B).....(35, 39, 55) | 18 Master volume indicator (VOLUME LEVEL) .....(37) |
| 5 INPUT MODE button .....(36, 38, 45)                                     | 19 Display  |
| 6 ANALOG button .....(36, 38)   | 20 INPUT mode indicators .....(37)                  |
| 7 EXT. IN button .....(36, 38)  | 21 SIGNAL indicators .....(37, 45)                  |
| 8 VIDEO SELECT button .....(39)   | 22 Remote control sensor (REMOTE SENSOR) .....(27)  |
| 9 DIMMER button .....(39)   | 23 Power indicator .....(35)                        |
| 10 STATUS button .....(39)  | 24 FUNCTION knob .....(36, 40, 45, 53, 55)          |
| 11 TONE DEFEAT button .....(38)   | 25 TUNING PRESET button .....(55)                   |
| 12 SURROUND MODE button .....(37, 43, 49)                                 | 26 SOURCE selector button .....(36)                 |
| 13 SURROUND PARAMETER button .....(44, 46, 49)                            | 27 REC/MULTI button .....(40)                       |
| 14 SELECT knob .....(37, 42, 43, 45, 49, 50)                              |   |

# Remote control unit

• For details on the functions of these parts, refer to the pages given in parentheses ( ).

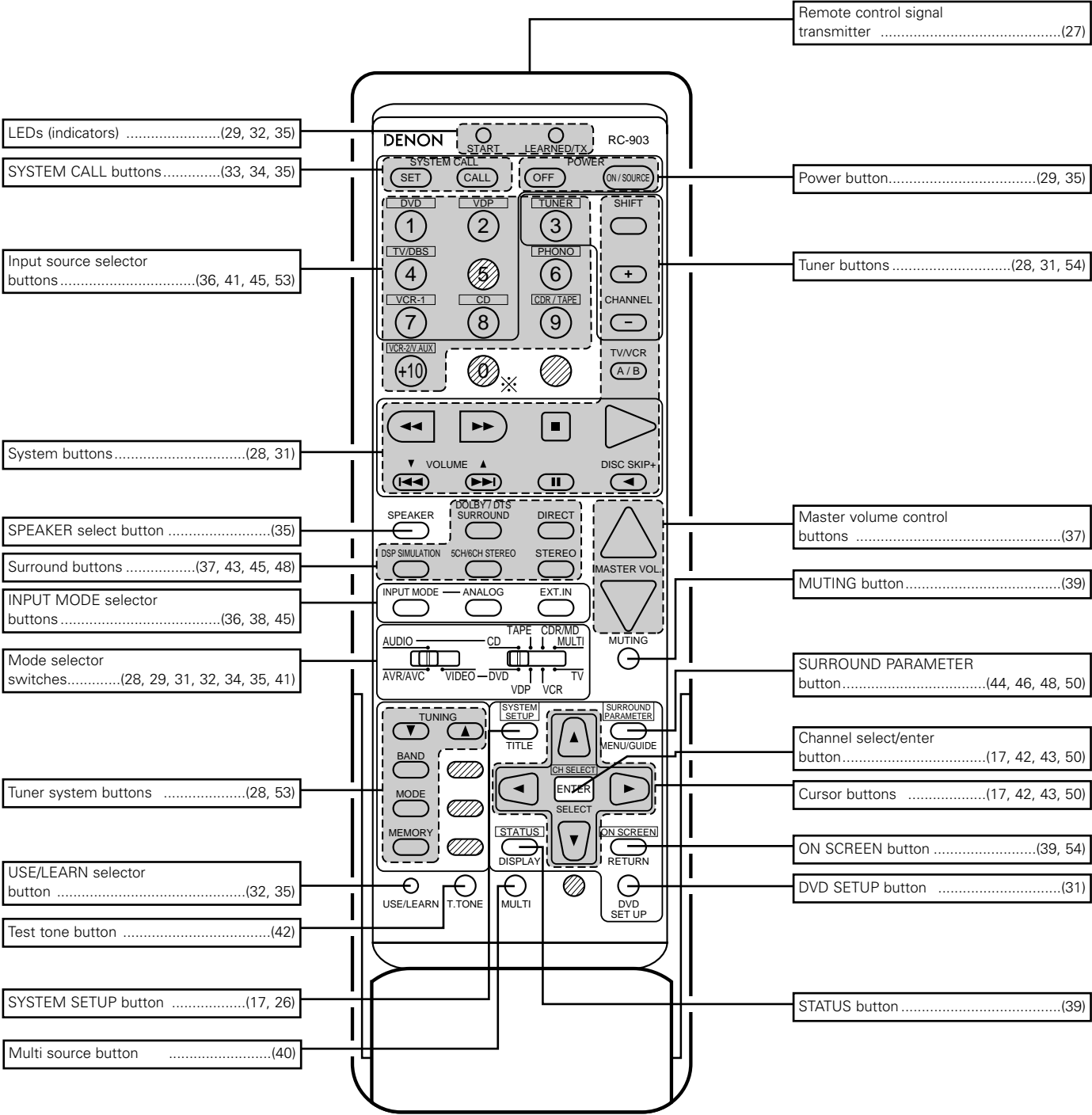

**NOTE**

- The shaded buttons do not function with the AVR-2802/982. (Nothing happens when they are pressed.) The button indicated ※, however, can be used with the learning function.

## 7 SETTING UP THE SYSTEM

- Once all connections with other AV components have been completed as described in "CONNECTIONS" (see pages 6 to 13), make the various settings described below on the monitor screen using the AVR-2802/982's on-screen display function. These settings are required to set up the listening room's AV system centered around the AVR-2802/982.
- Use the following buttons to set up the system:

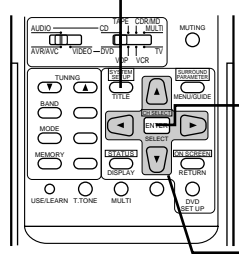

**SYSTEM SETUP button**

Press this to display the system setup menu.

**ENTER button**

Press this to switch the display on the screen. Also use this button to complete the setting on the screen.

**CURSOR buttons**

◀ and ▶ : Use these to move the cursors (◀ and ▶) to the left and right on the screen.

▲ and ▼ : Use these to move the cursors (▲ and ▼) up and down on the screen.

- System setup items and default values (set upon shipment from the factory)

System setup		Default settings										
①	Speaker Configuration	Input the combination of speakers in your system and their corresponding sizes (SMALL for regular speakers, LARGE for full-size, full-range) to automatically set the composition of the signals output from the speakers and the frequency response.	Front Sp.		Center Sp.	Sub Woofer	Surround Sp.	Surround Back Sp.				
	Crossover Frequency	Set the frequency (Hz) below which the bass sound of the various speakers is to be output from the subwoofer.	80 Hz									
	Subwoofer mode	This selects the subwoofer speaker for playing deep bass signals.	LFE									
②	SB CH Auto Flag Detect	Set the method of playing the surround back channel for digital signals.	DTS-ES / 6.1 Source Auto Flag Detect Mode = OFF									
③	Delay Time	This parameter is for optimizing the timing with which the audio signals are produced from the speakers and subwoofer according to the listening position.	Front L & R		Center	Sub Woofer	Surround L & R		Surround Back			
			12 ft (3.6 m)		12 ft (3.6 m)	12 ft (3.6 m)	10 ft (3.0 m)		10 ft (3.0 m)			
④	Channel Level	This adjusts the volume of the signals output from the speakers and subwoofer for the different channels in order to obtain optimum effects.	Front L	Front R	Center	Subwoofer	Surround L	Surround R	Surround Back			
			0 dB	0 dB	0 dB	0 dB	0 dB	0 dB	0 dB			
⑤	Digital In Assignment	This assigns the digital input jacks for the different input sources.	Input source	CD	DVD	TV/DBS	CDR/TAPE	VDP	VCR-1	VCR-2	—	—
			Digital Inputs	COAXIAL	OPTICAL 1	OPTICAL 2	OPTICAL 3	OFF	OFF	OFF	—	—
⑥	On Screen Display	This sets whether or not to display the on-screen display that appears on the monitor screen when the controls on the remote control unit or main unit are operated.	On Screen Display = ON									
⑦	Auto Tuner Presets	FM stations are received automatically and stored in the memory.	A1 ~ A8	87.5/89.1/98.1/107.9/90.1/90.1/90.1/90.1 MHz								
			B1 ~ B8	520/600/1000/1400/1500/1710 kHz, 90.1/90.1 MHz								
			C1 ~ C8	90.1 MHz								
			D1 ~ D8	90.1 MHz								
			E1 ~ E8	90.1 MHz								

**NOTES:**

- The on-screen display signals are not output from the color difference (component) video signal (MONITOR OUT) jacks.
- The on-screen display signals are output with priority to the S-VIDEO MONITOR OUT jack during playback of a video component. For example, if the TV monitor is connected to both the AVR-2802/982's S-Video and video monitor output jacks and signals are input to the AVR-2802/982 from a video source (VDP, etc.) connected to both the S-Video and video input jacks, the on-screen display signals are output with priority to the S-Video monitor output. If you wish to output the signals to the video monitor output jack, do not connect a cord to the S-VIDEO MONITOR OUT jack. (For details, see page 26.)
- The AVR-2802/982's on-screen display function is designed for use with high resolution monitor TVs, so it may be difficult to read small characters on TVs with small screens or low resolutions.
- The setup menu is not displayed when "HEADPHONE ONLY" is selected.



## • Speaker system layout

### Basic system layout

- The following is an example of the basic layout for a system consisting of seven speaker systems and a television monitor:

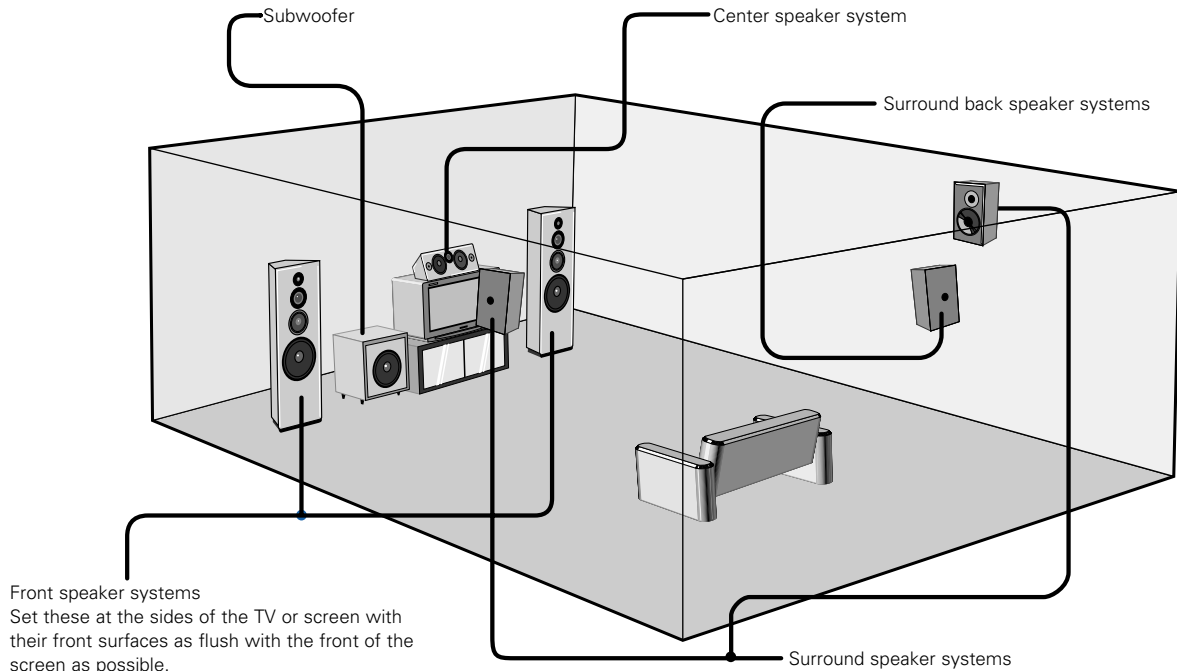

## Before setting up the system

- 1 Check that all the connections are correct, then turn on the main unit's power.

- 2 Display the System Setup Menu.

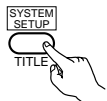

### System Setup Menu

```

Speaker Configuration
SB CH Auto Flag Detect
Delay Time
Channel Level
Digital In Assignment
On Screen Display
Auto Tuner Presets
  
```

## Setting the type of speakers

- The composition of the signals output from the different channels and the frequency response are adjusted automatically according to the combination of speakers actually being used.

- 1 At the System Setup Menu select "Speaker Configuration".

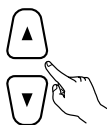

- 2 Switch to the speaker configuration screen.



### 3

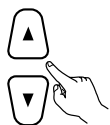

Set whether or not speakers are connected and, if so, their size parameters.

- To select the speaker

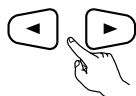
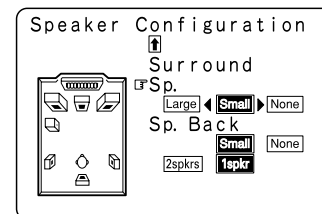
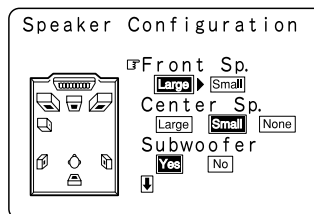

- To select the parameter

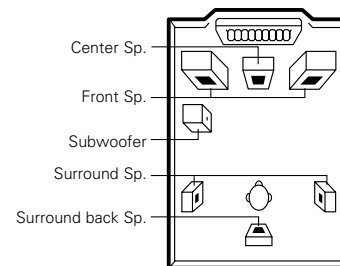

### 4



Press the ENTER button to finalize the setting.

**NOTE:**

- Select "Large" or "Small" not according to the actual size of the speaker but according to the speaker's capacity for playing low frequency (bass sound below frequency set for the Crossover Frequency mode and below) signals. If you do not know, try comparing the sound at both settings (setting the volume to a level low enough so as not to damage the speakers) to determine the proper setting.
- When "2spkr" is selected for the surround back channel, and external integrated pre-main amplifier or power amplifier must be connected to the pre-out jacks (SBL and SBR). (See page 13.)

**Parameters**

- Large.....Select this when using speakers that have sufficient performance for reproducing bass sound below the frequency set for the Crossover Frequency mode.
  - Small.....Select this when using speakers that do not have sufficient performance for reproducing bass sound below the frequency set for the Crossover Frequency mode. When this is set, bass sound with a frequency below the frequency set for the Crossover Frequency mode is sent to the subwoofer.  
When this setting is selected, low frequencies of below the frequency set for the Crossover Frequency mode are assigned to the subwoofer.
  - None.....Select this when no speakers are installed.
  - Yes/No.....Select "Yes" when a subwoofer is installed, "No" when a subwoofer is not installed.
  - 2spkr/1spkr .....Set the number of speakers to be used for the surround back channel.
- ※ If the subwoofer has sufficient low frequency playback capacity, good sound can be achieved even when "Small" is set for the front, center and surround speakers.
- ※ For the majority of speaker system configurations, using the Small setting for all five main speakers and Subwoofer On with a connected subwoofer will yield the best results.

## Setting the Crossover Frequency and Subwoofer mode

This screen is not displayed when not using a subwoofer.

- Set the crossover frequency and subwoofer mode according to the speaker system being used.

**1** Select the "Crossover Frequency" mode.

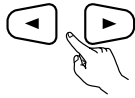
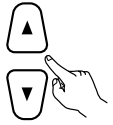

Select the frequency.

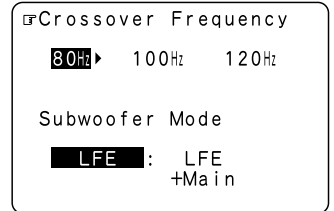

**2** Select the "Subwoofer Mode".

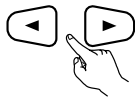
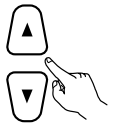

Select the setting.

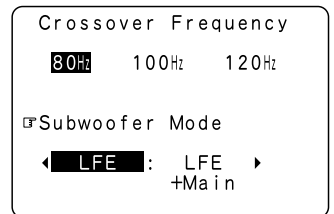

- ※ The subwoofer mode setting is only valid when "Large" is set for the front speakers and "Yes" is set for the subwoofer in the "Speaker Configuration" settings (see page 17).

**3** Enter the setting.  
The System Setup Menu reappears.



### NOTES:

#### — Assignment of low frequency signal range —

- The only signals produced from the subwoofer channel are LFE signals (during playback of Dolby Digital or DTS signals) and the low frequency signal range of channels set to "Small" in the setup menu. The low frequency signal range of channels set to "Large" are produced from those channels.

#### — Crossover Frequency —

- When "Subwoofer" is set to "Yes" at the "Speaker Configuration Setting", set the frequency (Hz) below which the bass sound of the various speakers is to be output from the subwoofer (the crossover frequency).
- For speakers set to "Small", sound with a frequency below the crossover frequency is cut, and the cut bass sound is output from the subwoofer instead.

**NOTE:** For ordinary speaker systems, we recommend setting the crossover frequency to 80 Hz. When using small speakers, however, setting the crossover frequency to a high frequency may improve frequency response for frequencies near the crossover frequency.

#### — Subwoofer mode —

- When the "LFE+MAIN" playback mode is selected, the low frequency signal range of channels set to "Large" are produced simultaneously from those channels and the subwoofer channel.  
In this playback mode, the low frequency range expand more uniformly through the room, but depending on the size and shape of the room, interference may result in a decrease of the actual volume of the low frequency range.
- Selection of the "LFE" play mode will play the low frequency signal range of the channel selected with "Large" from that channel only. Therefore, the low frequency signal range that are played from the subwoofer channel are only the low frequency signal range of LFE (only during Dolby Digital or DTS signal playback) and the channel specified as "Small" in the setup menu.
- Select the play mode that provides bass reproduction with body.
- When the subwoofer is set to "Yes", bass sound is output from the subwoofer regardless of the subwoofer mode setting in surround modes other than Dolby/DTS.

## Setting the SB CH Auto Flag Detect

Set the operation for the digital signals when playing in the 6.1 SURROUND and DTS-ES surround modes.

### 1

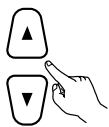

At the System Setup Menu select "SB CH Auto Flag Detect" and press the ENTER button.

System Setup Menu

```

Speaker Configuration
SB CH Auto Flag Detect
Delay Time
Channel Level
Digital In Assignment
On Screen Display
Auto Tuner Presets
  
```

### 2

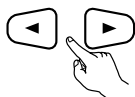

Select the desired setting.

※ We recommend setting this to "OFF".

When set to "ON", then set the operation for software for which no identification signals are recorded (Non-Flag Source).

DTS-ES/6.1 Source  
Auto Flag Detect Mode

ON ◀ : ▶ OFF

DTS-ES/6.1 Source  
Auto Flag Detect Mode

ON ◀ : ▶ OFF

Non-Flag Source  
SBch Output

MTRX ON NON- OFF  
DTS ES MTRX

### Setting

#### ① Auto Flag Detect Mode (AFDM)

ON: This function only works for sources containing DTS-ES or 6.1-channel surround identification signals.

When this function is used, sources that have been recorded in 6.1-channel surround or DTS-ES are automatically played in the 6.1-channel surround mode using the surround back speaker(s). (Refer to ② for the method of playback of the surround back speaker in this case.)

OFF: Set this mode if you wish to play normal 5.1-channel sources or sources not containing the identification signals in the 6.1-channel mode.

#### ② Non-Flag Source SBch Output

MTRX ON: Sources are played using the surround back speaker(s). The surround back channel is played with digital matrix processing.

NON-MTRX: Sources are played using the surround back speaker(s). The same signals as those of the surround channel are output from the surround back speaker(s).

OFF: Sources are played without using the surround back speaker(s).

### 3



Enter the setting.  
The System Setup Menu reappears.

### NOTES:

- The SB CH Auto Flag Detect setting screen is displayed when the surround back speaker(s) is/are set to "Large" or "Small" at the "Speaker Configuration" screen.
- The surround back speaker(s) can also be turned on and off with the 6.1/7.1 SURROUND button on the main unit. (See page 45.)

# Setting the delay time

- Input the distance between the listening position and the different speakers to set the delay time for the surround mode.
- The delay time can be set separately for surround speakers A and B.

**Preparations:**

Measure the distances between the listening position and the speakers (L1 to L5 on the diagram at the right).

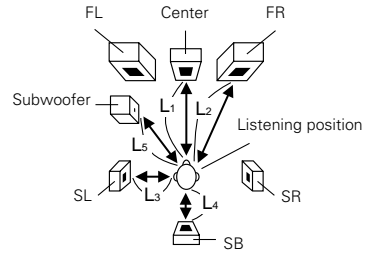

- L1: Distance between center speaker and listening position
- L2: Distance between front speakers and listening position
- L3: Distance between surround speakers and listening position
- L4: Distance between surround back speaker and listening position
- L5: Distance between subwoofer and listening position

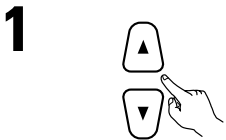

1 At the System Setup Menu select "Delay Time".

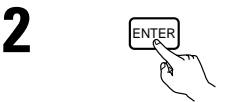
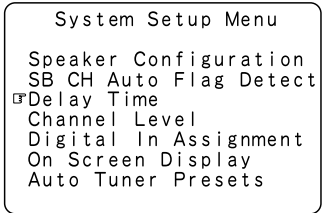

2 Switch to the Delay Time screen.

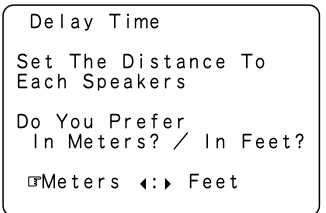

3 Select the desired unit, meters or feet. Select (darken) the desired units, "Meters" or "Feet".

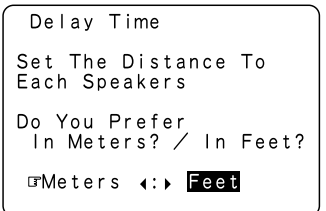

Example: When "Feet" is selected

4 Once "Meters" or "Feet" is selected in step 3, the Delay Time screen appears automatically.

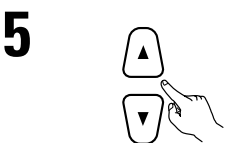
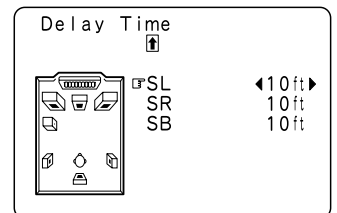
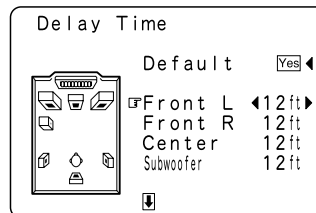

5 Select the speaker to be set.

6

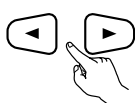

Set the distance between the center speaker and listening position. The distance changes in units of 1 foot (0.1 meters) each time the button is pressed. Select the value closest to the measured distance.

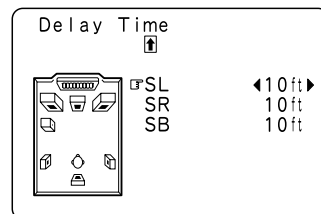
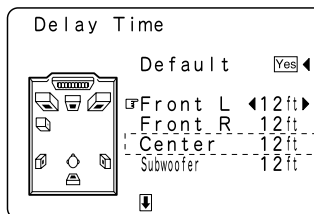

Example: When the distance is set to 12 feet for the center speaker

※ If "Yes" is selected for "Default", the settings are automatically reset to the default values.

Please note that the difference of distance for every speaker should be 15 ft (4.5 m) or less. If you set an invalid distance, a CAUTION notice, such as screen right will appear. In this case, please relocate the blinking speaker(s) so that its distance is no larger than the value shown in highlighted line.

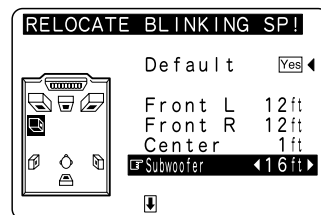

7



Enter the setting. The System Setup Menu reappears. The AVR-2802/982 automatically sets the optimum surround delay time for the listening room.

**NOTE:**

- If the distance unit is changed after the delay time is set, the settings are reset to the factory default values (see page 16).

**Setting the channel level**

- Use this setting to adjust so that the playback level between the different channels is equal.
- From the listening position, listen to the test tones produced from the speakers to adjust the level.
- The level can also be adjusted directly from the remote control unit. (For details, see page 42.)

1

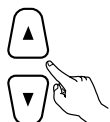

At the System Setup Menu select "Channel Level".

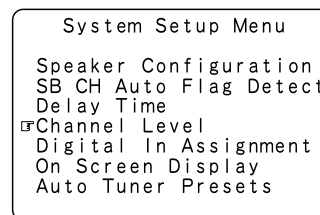

2



Switch to the Channel Level screen.

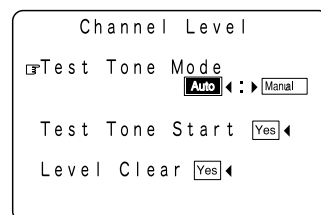

3

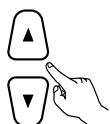

Select "Test Tone Mode".

4

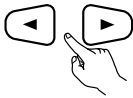

Select the mode.  
Select "Auto" or "Manual".

- Auto:  
Adjust the level while listening to the test tones produced automatically from the different speakers.
- Manual:  
Select the speaker from which you want to produce the test tone to adjust the level.

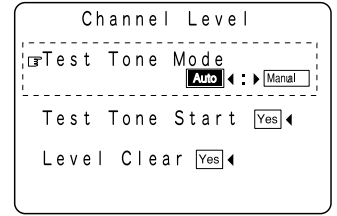

Example: When the "Auto" mode is selected

5

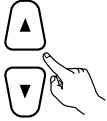

Select "Test Tone Start".

6



Select "Yes".

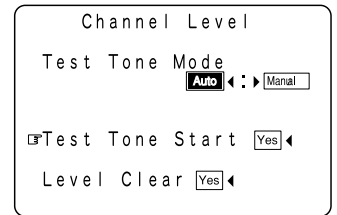

7

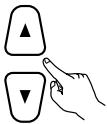

a. If the "Auto" mode is selected:  
Test tones are automatically emitted from the different speakers.  
The test tones are emitted from the different speakers in the following order, at 4-second intervals the first time and second time around, 2-second intervals the third time around and on:

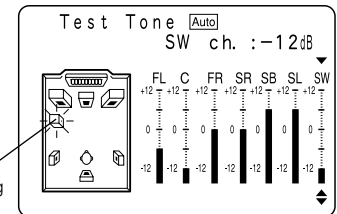
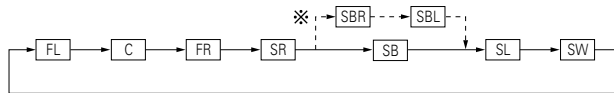

Flashing

Example: When the volume is set to -12 dB while the test tone is being produced from the subwoofer

Use the CURSOR buttons to adjust all the speakers to the same volume.

The volume can be adjusted between -12 dB and +12 dB in units of 1 dB.

\* When the surround back speaker setting is set to "2spkr" for "Speaker Configuration", this is set to "SBR", "SBL".

b. When the "Manual" mode is selected

Use the ◀ and ▶ cursor buttons to select the speaker from which you want to produce the test tone, then use the ▲ and ▼ cursor buttons to adjust so that the volume from the different speakers sounds the same.

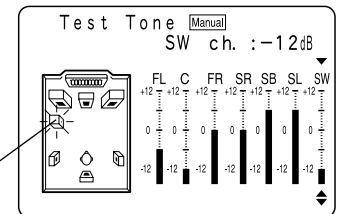
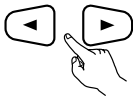

Flashing

Example: When the volume is set to -12 dB while the subwoofer is selected

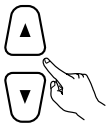

8



After the above settings are completed, press the ENTER button.  
The "Channel Level" screen reappears.  
Press the ENTER button again, the "System Setup Menu" screen reappears.

\* To cancel the settings, select "Level Clear" and "Yes" on the "Channel Level" screen, then make the settings again.

The level of each channel should be adjusted to 75 dB (C-weighted, slow meter mode) on a sound level meter at the listening position. If a sound level meter is not available adjust the channels by ear so the sound levels are the same. Because adjusting the subwoofer level test tone by ear is difficult, use a well known music selection and adjust for natural balance.

**NOTE:** When adjusting the level of an active subwoofer system, you may also need to adjust the subwoofer's own volume control.

- \* When you adjust the channel levels while in the SYSTEM SETUP CHANNEL LEVEL mode, the channel level adjustments made will affect ALL surround modes. Consider this mode a Master Channel Level adjustment mode.
- \* After you have completed the SYSTEM SETUP CHANNEL LEVEL adjustments, you can then activate the individual surround modes and adjust channel levels that will be remembered for each of those modes. Then, whenever you activate a particular surround sound mode, your preferred channel level adjustments for just that mode will be recalled. Check the instructions for adjusting channel levels within each surround mode on Page 42.
- \* You can adjust the channel levels for each of the following surround modes: DIRECT, STEREO, 5CH/6CH STEREO, DOLBY/DTS SURROUND, ROCK ARENA, JAZZ CLUB, VIDEO GAME, MONO MOVIE, and MATRIX.

## Setting the digital in assignment

- This setting assigns the digital input jacks of the AVR-2802/982 for the different input sources.

1

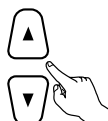

At the System Setup Menu select "Digital In Assignment".

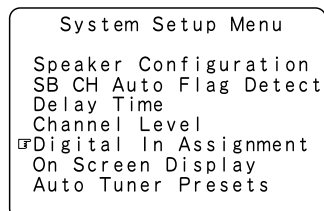

2



Switch to the Digital In Assignment screen.

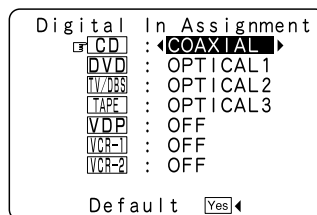

3

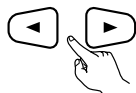
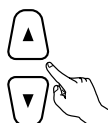

Select the digital input jack to be assigned to the input source.

- To select the input source
- To select the digital input jack

Select "OFF" for input sources for which no digital input jacks are used.

\* If "Yes" is selected for "Default", the settings are automatically reset to the default values.

4



Enter the setting.  
The System Setup Menu reappears.

### NOTES:

- The OPTICAL 3 jacks on the AVR-2802/982's rear panel are equipped with an optical digital output jack for recording digital signals on a CD recorder, MD recorder or other digital recorder. Use this for digital recording between a digital audio source (stereo - 2 channel) and a digital audio recorder.
- Do not connect the output of the component connected to the OPTICAL 3 OUT jack on the AVR-2802/982's rear panel to any jack other than the OPTICAL 3 IN jack.
- "PHONO" and "TUNER" cannot be selected on the Digital In Assignment screen.



## Setting the on-screen display (OSD)

- Use this to turn the on-screen display (messages other than the menu screens) on or off.

- 

At the System Setup Menu select "On Screen Display".

System Setup Menu

Speaker Configuration  
SB CH Auto Flag Detect  
Delay Time  
Channel Level  
Digital In Assignment  
On Screen Display  
Auto Tuner Presets
- 

Switch to the On Screen Display screen.

On Screen Display

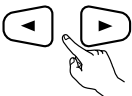
ON ◀ : ▶ OFF
- 

Select "ON" or "OFF".
- 

Enter the setting.  
The System Setup Menu reappears.

## Auto tuner presets

Use this to automatically search for FM broadcasts and store up to 40 stations at preset channels A1 to 8, B1 to 8, C1 to 8, D1 to 8 and E1 to 8.

### NOTE:

- If an FM station cannot be preset automatically due to poor reception, use the "Manual tuning" operation to tune in the station, then preset it using the manual "Preset memory" operation.

- 

Use the CURSOR buttons to specify "Auto Tuner Presets" from the "System Setup Menu" screen.

System Setup Menu

Speaker Configuration  
SB CH Auto Flag Detect  
Delay Time  
Channel Level  
Digital In Assignment  
On Screen Display  
Auto Tuner Presets
- 

Press the ENTER button.  
The "Auto Preset Memory" screen appears.

Auto Preset Memory

Auto Tuning &  
Preset Station Memory  
Storing Preset Memory

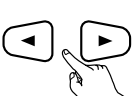
Start Yes ◀
- 

Use the CURSOR button to select "Yes".  
"Search" flashes on the screen and searching begins.  
"Completed" appears once searching is completed.  
The display automatically switches to screen.

※ This completes system setup. Once these settings are made, there is no need to change them unless different AV components are connected or the speakers are repositioned.

## After completing system setup

This button can be pressed at any time during the system setup process to complete the process.

# 1



At the System Setup Menu, press the SYSTEM SETUP button.

※ The changed settings are entered and the on-screen display turns off.

### • On-screen display signals

	Signals input to the AVR-2802/982		On-screen display signal output	
	VIDEO signal input jack (yellow)	S-video signal input jack	VIDEO MONITOR OUT video signal output jack (yellow)	S-video MONITOR OUT video signal output jack
1	×	×	○	○
2	○	×	○	×
3	×	○	×	○
4	○	○	×	○

(○: Signal    ×: No signal)

(○: On-screen signals output    ×: On-screen signals not output)

#### NOTES:

- The on-screen display signals are not output from the color difference (component) video signal MONITOR OUT jacks.
- For 4 above, the on-screen display signals are output to the VIDEO MONITOR OUT video signal output jack (yellow) if the monitor TV is not connected to the S-video MONITOR OUT video signal output jack.

## 8 REMOTE CONTROL UNIT

- The included remote control unit (RC-903) can be used to operate not only the AVR-2802/982 but other remote control compatible DENON components as well. Furthermore, it is equipped with a function for learning the control signals of remote control units of other manufacturers, so it can also be used to operate non-DENON remote control compatible video components.

### Inserting the batteries

- Remove the remote control unit's rear cover.

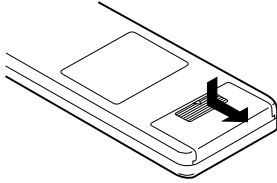

- Set two R6P/AA batteries in the battery compartment in the indicated direction.

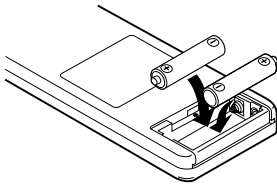

- Put the rear cover back on.

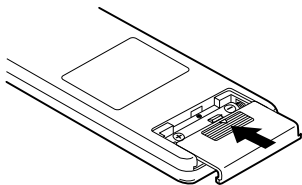

#### Notes on Batteries

- Use R6P/AA batteries in the remote control unit.
- The batteries should be replaced with new ones approximately once a year, though this depends on the frequency of usage.
- Even if less than a year has passed, replace the batteries with new ones if the set does not operate even when the remote control unit is operated nearby the set. (The included battery is only for verifying operation. Replace it with a new battery as soon as possible.)
- When inserting the batteries, be sure to do so in the proper direction, following the "⊕" and "⊖" marks in the battery compartment.
- To prevent damage or leakage of battery fluid:
  - Do not use a new battery together with an old one.
  - Do not use two different types of batteries.
  - Do not short-circuit, disassemble, heat or dispose of batteries in flames.
- Remove the batteries from the remote control unit when you do not plan to use it for an extended period of time.
- If the battery fluid should leak, carefully wipe the fluid off the inside of the battery compartment and insert new batteries.
- When replacing the batteries, have the new batteries ready and insert them as quickly as possible.
- The learned remote control signals may be cleared if no batteries are in the remote control unit for about 5 seconds. The factory-installed codes are in permanent memory, however.

### Using the remote control unit

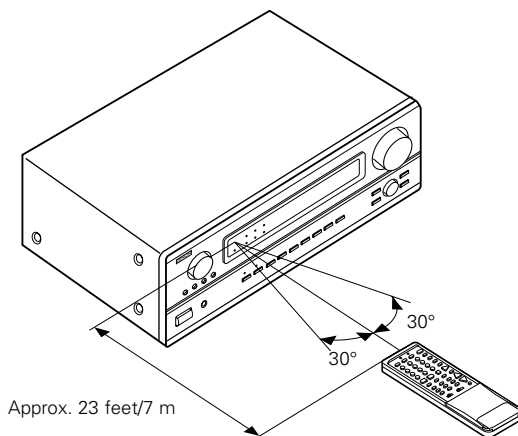

- Point the remote control unit at the remote sensor on the main unit as shown on the diagram.
- The remote control unit can be used from a straight distance of approximately 23 feet/7 meters from the main unit, but this distance will be shorter if there are obstacles in the way or if the remote control unit is not pointed directly at the remote sensor.
- The remote control unit can be operated at a horizontal angle of up to 30 degrees with respect to the remote sensor.

#### NOTES:

- It may be difficult to operate the remote control unit if the remote sensor is exposed to direct sunlight or strong artificial light.
- Do not press buttons on the main unit and remote control unit simultaneously. Doing so may result in malfunction.
- Neon signs or other devices emitting pulse-type noise nearby may result in malfunction, so keep the set as far away from such devices as possible.

## Operating DENON audio components

- Turn on the power of the different components before operating them.

**1** Set mode switch 1 to "AUDIO (AVR/AVC)".

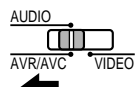

**2** Set mode switch 2 to the position for the component to be operated.

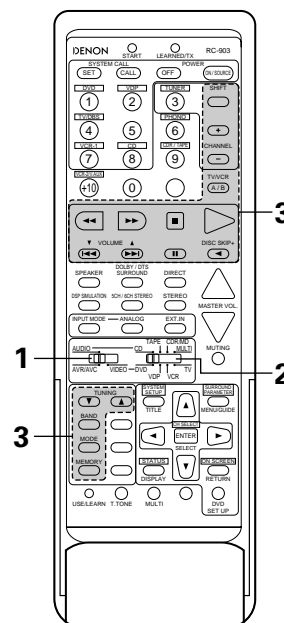
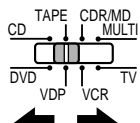

**3** Operate the audio component.

- For details, refer to the component's operating instructions.

※ While this remote control is compatible with a wide range of infrared controlled components, some models of components may not be operated with this remote control.

### 1. CD player (CD) and CD recorder and MD recorder (CDR/MD) system buttons

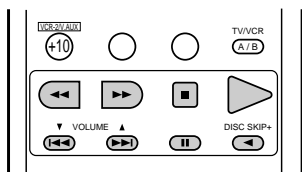

- ◀▶ : Manual search (forward and reverse)
- : Stop
- ▶ : Play
- ◀▶▶▶ : Auto search (cue)
- || : Pause
- DISC : Switch discs
- SKIP+ : (for CD changers only)

### 2. Tape deck (TAPE) system buttons

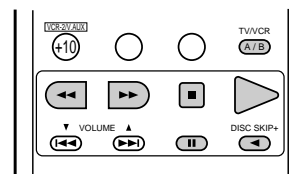

- ◀◀ : Rewind
- ▶▶ : Fast-forward
- : Stop
- ▶ : Forward play
- || : Pause
- ◀ : Reverse play
- A/B : Switch between decks A and B

### 3. Tuner system buttons

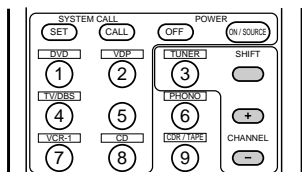

- SHIFT : Switch preset channel range
- CHANNEL : Preset channel
- +, - : up/down

\* For the tuner only, the following buttons can also be operated:

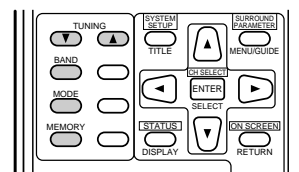

- TUNING : Frequency
- ▲, ▼ : up/down
- BAND : Switch between the AM and FM bands
- MODE : Switch between auto and mono
- MEMORY : Preset memory

## Preset memory (Audio component)

- DENON components can be operated by setting the preset memory for CDR or MD. **Operation is not possible for some models, however. In this case use the learning function (see page 32) to store the remote control signals.**
- For instructions on clearing the presettings stored in the preset memory, see page 35.

- 1** Set the slide switch to "AUDIO".

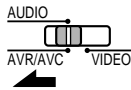

- 2** Set the slide switch to "CDR/MD".

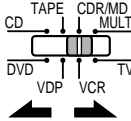

(Keep the POWER button pressed in when performing steps 3 and 4)

- 3** Holding in the POWER button, press the button for the components you want to set.

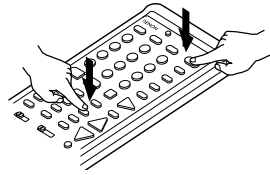

The LEARNED/TX LED flashes.

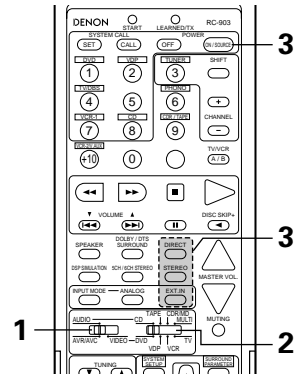

### Combinations of Personal System Codes

"CDR/MD"

	DIRECT (DIRECT)	STEREO (STEREO)	EXT.IN (EXT. IN)
(POWER)	DENON CDR A	DENON CDR B	DENON MD

\* Preset codes set upon shipment from the factory.

## Preset memory (Video component)

- DENON and other makes of components can be operated by setting the preset memory for your make of video component. **Operation is not possible for some models, however. In this case use the learning function (see page 32) to store the remote control signals.**
- For instructions on clearing the presettings stored in the preset memory, see page 35.

- 1** Set the slide switch to "VIDEO".

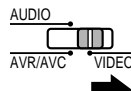

- 2** Set the slide switch to the component to be registered (DVD, VDP, VCR or TV).

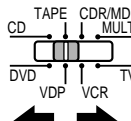

(Keep the POWER button pressed in when performing steps 3 and 4)

- 4** Next, while holding the POWER button, press the button for the code in block B. (Refer to Table 1.) The operation is completed when the button is released and the LEARNED/TX LED lights.

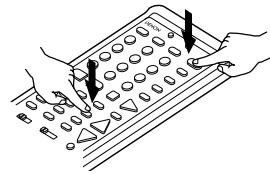

- 5** To continue registering other components, repeat steps 2 to 4.

- 3** Holding in the POWER button, press the button for the corresponding manufacturer in block A. (Refer to Table 1.)

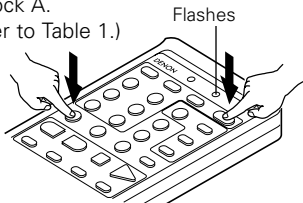



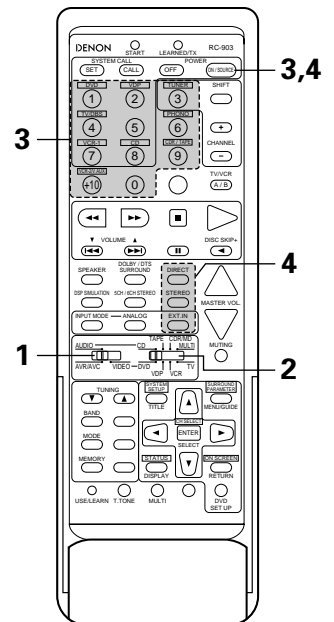



The LEARNED/TX LED flashes.









- This remote control unit can be used to operate components of other manufacturers without using the learning function by registering the manufacturer of the component as shown on Table 1.

**Table 1: Combinations of Personal System Codes for Different Manufacturers**







**“DVD”**

A \ B	 (DIRECT)	 (STEREO)	 (EXT. IN)
① (DVD)	DENON A	DENON B	—
② (VDP)	—	—	—
③ (TUNER)	—	—	—
④ (TV/DBS)	PANASONIC	—	—
⑤	—	—	—
⑥ (PHONO)	SONY	—	—
⑦ (VCR-1)	PIONEER	—	—
⑧ (CD)	TOSHIBA	—	—
⑨ (CDR/TAPE)	—	—	—
⑩ (VCR-2/V.AUX)	—	—	—
⑪	—	—	—
 (SHIFT)	—	—	—
 (CHANNEL +)	—	—	—
 (CHANNEL -)	—	—	—
 (A/B)	—	—	—







**“VDP”**

A \ B	 (DIRECT)	 (STEREO)	 (EXT. IN)
① (DVD)	DENON A	DENON B	DENON C
② (VDP)	—	—	—
③ (TUNER)	MITSUBISHI	—	—
④ (TV/DBS)	PANASONIC	—	—
⑤	—	—	—
⑥ (PHONO)	SONY A	SONY B	SONY C
⑦ (VCR-1)	PIONEER	—	—
⑧ (CD)	—	—	—
⑨ (CDR/TAPE)	—	—	—
⑩ (VCR-2/V.AUX)	—	—	—
⑪	—	—	—
 (SHIFT)	PHILIPS	—	—
 (CHANNEL +)	RCA	—	—
 (CHANNEL -)	—	—	—
 (A/B)	MAGNAVOX	—	—

**“VCR”**

A \ B	 (DIRECT)	 (STEREO)	 (EXT. IN)
① (DVD)	—	—	—
② (VDP)	HITACHI A	HITACHI B	—
③ (TUNER)	MITSUBISHI A	MITSUBISHI B	MITSUBISHI C
④ (TV/DBS)	PANASONIC A	PANASONIC B	PANASONIC C
⑤	JVC (VICTOR) A	JVC (VICTOR) B	JVC (VICTOR) C
⑥ (PHONO)	SONY A	SONY B	SONY C
⑦ (VCR-1)	PIONEER	—	—
⑧ (CD)	TOSHIBA A	TOSHIBA B	—
⑨ (CDR/TAPE)	SANYO A	SANYO B	—
⑩ (VCR-2/V.AUX)	SHARP A	SHARP B	—
⑪	NEC A	NEC B	NEC C
 (SHIFT)	PHILIPS A	PHILIPS B	PHILIPS C
 (CHANNEL +)	RCA A	RCA B	—
 (CHANNEL -)	GENERAL ELECTRIC A	GENERAL ELECTRIC B	—
 (A/B)	MAGNAVOX A	MAGNAVOX B	MAGNAVOX C

**“TV”**

A \ B	 (DIRECT)	 (STEREO)	 (EXT. IN)
① (DVD)	—	—	—
② (VDP)	DENON/HITACHI	—	—
③ (TUNER)	MITSUBISHI A	MITSUBISHI B	—
④ (TV/DBS)	PANASONIC A	PANASONIC B	—
⑤	JVC (VICTOR)	—	—
⑥ (PHONO)	SONY	—	—
⑦ (VCR-1)	PIONEER	—	—
⑧ (CD)	TOSHIBA	—	—
⑨ (CDR/TAPE)	SANYO	—	—
⑩ (VCR-2/V.AUX)	SHARP	—	—
⑪	NEC	—	—
 (SHIFT)	PHILIPS	—	—
 (CHANNEL +)	RCA	—	—
 (CHANNEL -)	GENERAL ELECTRIC A	GENERAL ELECTRIC B	—
 (A/B)	MAGNAVOX	—	—

\*  Preset codes set upon shipment from the factory.

**NOTES:**

- The signals for the pressed buttons are emitted while setting the preset memory. To avoid accidental operation, cover the remote control unit's transmitting window while setting the preset memory.
- Some models and years of manufacture of components of the manufacturers listed on Table 1 cannot be used.
- The signals stored at “learned” buttons have priority over the preset codes. If you wish to clear the “learned” signals, do so as described on page 35.
- Some manufacturers use different types of remote control codes for their products. If the component does not operate when set to remote codeset A, try setting to the B or C codesets.

# Operating a video component stored in the preset memory

**1** Set the slide switch to "VIDEO".

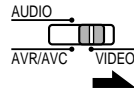

**2** Set the slide switch to the component to be registered (DVD, VDP, VCR or TV).

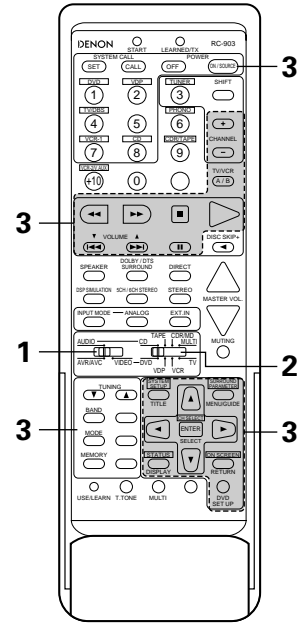
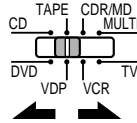

**3** Operate the video component.  
 • For details, refer to the component's operating instructions.  
 ※ Some models cannot be operated with this remote control unit.

**1. DVD player system buttons**

- POWER : Turns power on and off (ON/SOURCE)
- ◀▶ : Manual search (forward and reverse)
- : Stop
- ▶ : Play
- ◀▶▶▶ : Auto search (cue)
- ⏸ : Pause
- SKIP + : (for DVD changers only)
- TITLE : Call out title
- MENU : Call out menu
- DISPLAY : Switch display
- DVD SET UP : DVD setup
- RETURN : Menu return
- ▲▼ : Cursor up/down
- ◀▶ : Cursor left/right
- SELECT : Enter setting

**NOTE:**  
 Some manufacturers use different names for the DVD remote control buttons, so also refer to the instructions on remote control for that component.

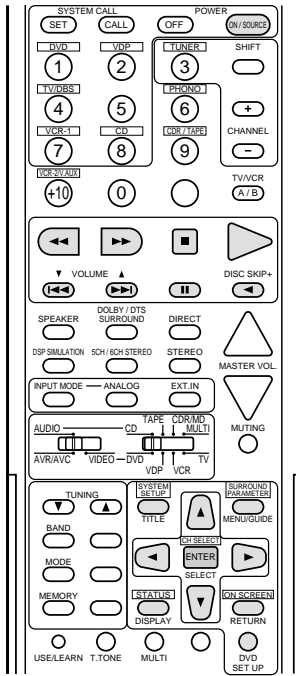

**2. Video disc player (VDP) system buttons    3. Video deck (VCR) system buttons    4. Monitor TV system buttons**

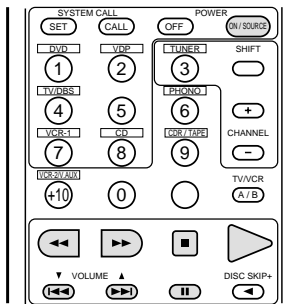

- POWER : Power on/off (ON/SOURCE)
- ◀▶▶▶ : Manual search (forward and reverse)
- : Stop
- ▶ : Play
- ◀▶▶▶ : Auto search (cue)
- ⏸ : Pause

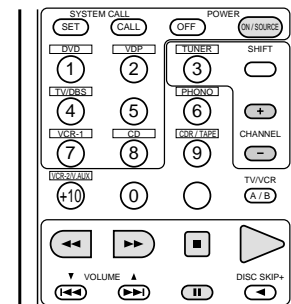

- POWER : Power on/off (ON/SOURCE)
- ◀▶▶▶ : Manual search (forward and reverse)
- : Stop
- ▶ : Play
- ⏸ : Pause
- CHANNEL : Switch channel
- +, -

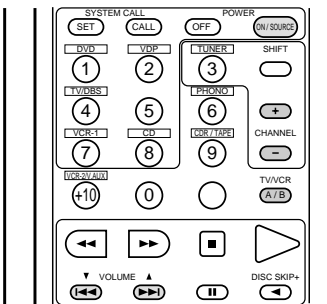

- POWER : Power on/off (ON/SOURCE)
- VOLUME : Volume up/down
- TV/VCR : Switch between TV and VCR
- CHANNEL : Switch channel
- +, -

## Learning function

- If your AV component is not a DENON product or it cannot be operated with the preset memory codesets, you can “teach” the AVR-2802/982’s remote control to “learn” the codes from the component’s original remote control.
- The buttons that can be “learned” are the CD, TAPE and CDR/MD system buttons (see page 28) and the DVD, VDP, VCR and TV system buttons (see page 31). (For the CD, CDR/MD, DVD, VDP and TV, the A block buttons can also be “learned”, and for the DVD and TV, the B block buttons can also be “learned”.)

- 1** Press the USE/LEARN selector button with the tip of a pen etc., to set the learn mode. Both the START and LEARNED/TX indicators flash.

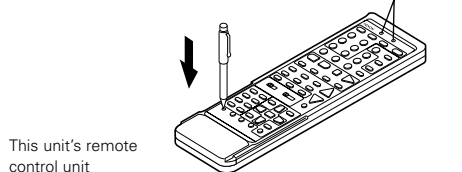

- 2** Set the program switch to the side to be learned. Set to the AUDIO side for the CD, tape deck or CDR/MD position, to the VIDEO side for the DVD, VDP, VCR or TV position.

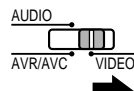

- 3** Set the program switch to the position to be learned.

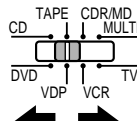

- 4** Set the remote control units so they are facing each other, then press the button to be learned on this unit's remote control unit.

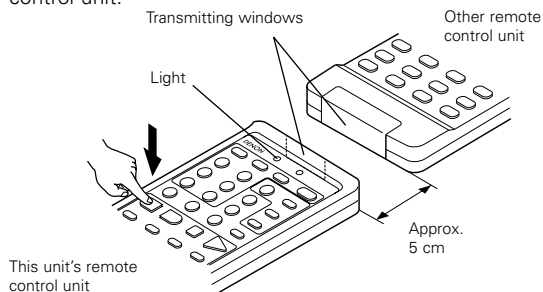

The indicator stops flashing and the START LED lights. The learnable buttons are the buttons which can be operated with the DENON system codes for the CD player, tape deck, CD recorder, MD recorder, the buttons which can be operated with the preset memory for the DVD, VCR, VDP and TV. For the TV only, however, the buttons in the section indicated “A” on the diagram above can also be “learned”. Use these to “learn” TV channels.

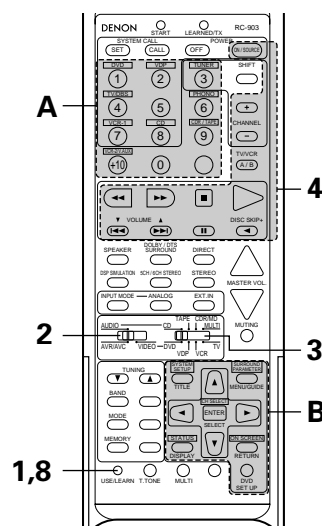

- 5** Check that the START LED is lit, then press the button to be “learned” on the other remote control unit.

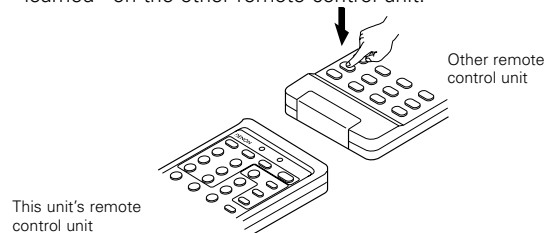

- 6** Once the START LED turns off and the LEARNED/TX LED lights, release the button on the other remote control unit.

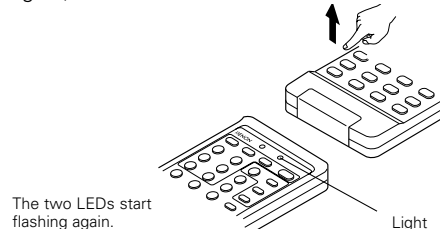

- 7** To “learn” other buttons, repeat steps 2 to 6.

- 8** Once the learning operation is completed, press the USE/LEARN selector button again. The two LEDs stop flashing and the learning mode is cancelled.

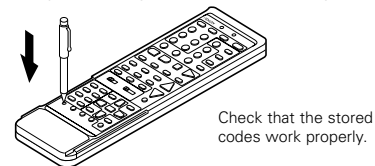

**NOTES:**

- Up to 26 codes can be “learned”, but this number may be lower if the codes are long.
- If a non-learnable button is pressed or two or more buttons are pressed at once, the two LEDs will once again light when the button(s) is released.
- If the codes could not be stored, the LEARNED/TX LED does not light after the START LED turns off. For limited number of models, codes cannot be stored in RC-903.
- If the two LEDs start flashing rapidly after the START LED lights, this means that the memory is already full, and the code you have just attempted to store was not stored. To “learn” that code, first perform the resetting operation. (See page 35.)



## System call function

- The included remote control unit is equipped with a system call function for transmitting multiple remote control signals when a single button is pressed (this is often referred to as a "macro" function). This function can be used to turn on the amplifier's power, select the input source, turn on the monitor TV's power, turn on a source component's power and start playback, etc., all at the touch of a button.

### (1) System call buttons

The buttons that can be used for the system call function are shown on the table below.

A series of up to 10 operations can be performed with the POWER ON and OFF buttons, and a series of up to 5 operations can be performed with other buttons.

System call signals are already preset at the buttons indicated in the shaded section. System call signals can also be stored at any button on the remote control unit, including the buttons in this section. (See page 34.)

Button	No. transmissions	Stored operation 1	Stored operation 2	Stored operation 3	Stored operation 4	Stored operation 5	Stored operation 6	Stored operation 7	Stored operation 8	Stored operation 9	Stored operation 10
POWER OFF	10										
POWER ON	10										
DVD	5	Receiver power on	DVD player (DVD) power on	Receiver input source switched to DVD	TV power on	DVD player (DVD) playback					
VDP	5	Receiver power on	LD player (VDP) power on	Receiver input source switched to VDP	TV power on	LD player (VDP) playback					
TV/DBS	5	Receiver power on	TV power on	Receiver input source switched to TV/DBS							
VCR-1	5	Receiver power on	Video (VCR) power on	Receiver input source switched to VCR-1	TV power on	Video (VCR) playback					
CD	5	Receiver power on	Receiver input source switched to CD								

The system call signals for the POWER OFF and POWER ON buttons are transmitted from the remote control unit approximately once every second. The signals for the other buttons (DVD, VDP, TV / DBS, VCR-1 and CD) are transmitted approximately once every 1.5 seconds.

### (2) Using the system call function

- Press the system call button.
  - The LEARNED/TX LED flashes for 5 seconds.



- Press the button at which the desired system call signals are stored while the LEARNED/TX LED is flashing.
  - The preset signals or the signals you have stored at that button are transmitted in succession.

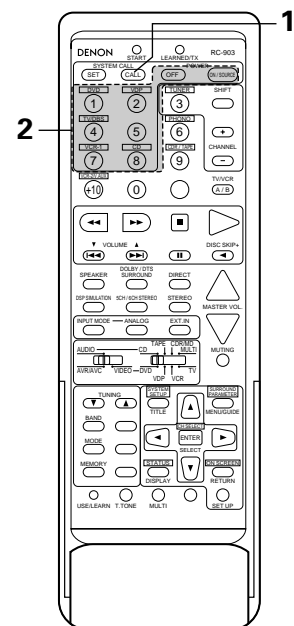

**(3) Storing signals**

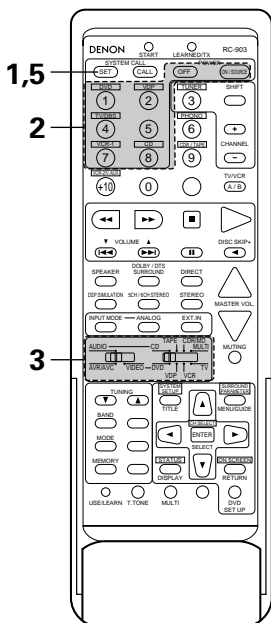

- 1** Press the SET button.
- The START LED and LEARNED/TX LED both flash.



- 2** Press the button at which you want to store the system call signals.
- The START LED flashes.

- 3** Set the mode switch to the position for the component whose remote control signals you want to store.

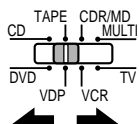
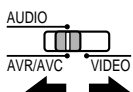

- 4** Press the buttons whose remote control signals you want to store one by one.

- 5** Press the SET button.

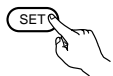

**NOTES:**

- The remote control signals for the buttons pressed while storing the system call signals are transmitted when the buttons are pressed, so cover the remote sensor or take other measures so that the components do not operate while the signals are being stored.
- The LEARNED/TX LED does not light if system call signals cannot be stored at the button that you have pressed or if you have already stored the maximum number of signals.

**(4) Clearing system call settings**

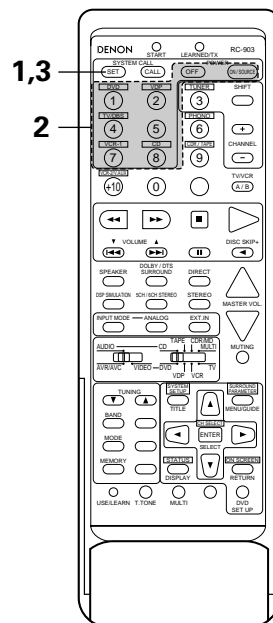

- 1** Press the SET button.



- 2** Press the button whose settings you want to clear.

- 3** Press the SET button.
- The button is reset to the settings shown on the table on page 33.

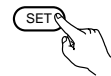

## Clearing "learned" remote control signals

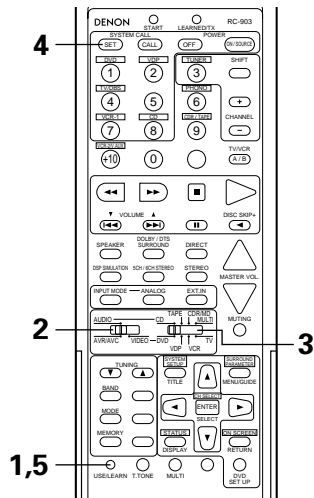

- 1** Press the USE/LEARN selector button with the tip of a pen, etc., to set the learn mode.

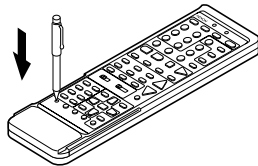

- 2** To clear "learned" remote control signals, set the slide switch to the position at which the signals were "learned".

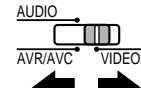

- 3** Set the slide switch to the position at which the signals were "learned".

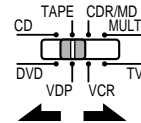

- 4** Press the SYSTEM CALL SET button, and hold it in for at least four seconds.
  - When both the START and LEARNED/TX LEDs light simultaneously, all the stored codes are cleared.

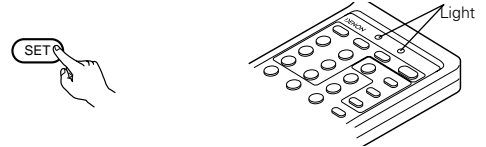

- 5** Press the USE/LEARN selector button.

## 9 OPERATION

### Before operating

- 1** Refer to "CONNECTIONS" (pages 6 to 13) and check that all connections are correct.

- 2** Set the remote control unit's slide switch to the AUDIO position. (only when operating with the remote control unit)

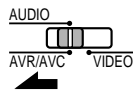

- 3** Turn on the power. Press the POWER switch (button).

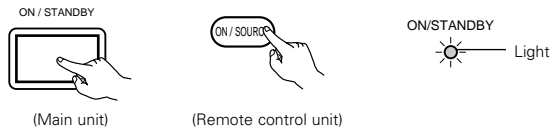

When pressed, the power turns on and the display lights. The sound is muted for several seconds, after which the unit operates normally. When pressed again, the power turns off, the standby mode is set and the display turns off. Whenever the ON/STANDBY button is in the STANDBY state, the apparatus is still connected on AC line voltage. Please be sure to unplug the cord when you leave home for, say, a vacation.

- 4** Select the front speakers. Press SPEAKER A or B turn the speaker on.

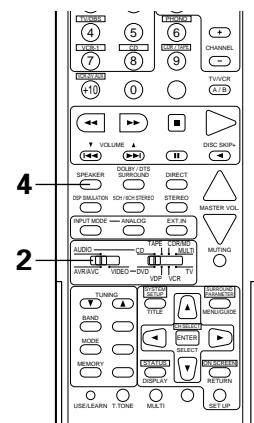
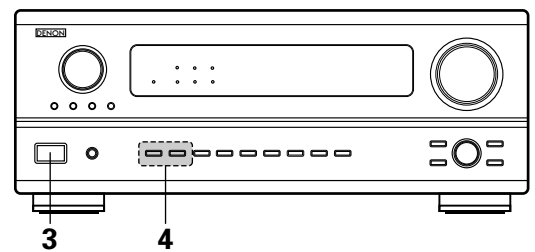
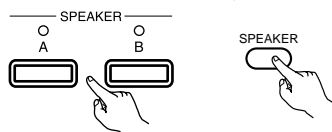

## Playing the input source

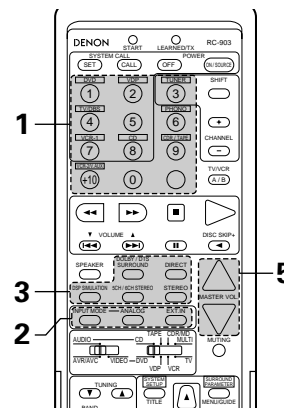
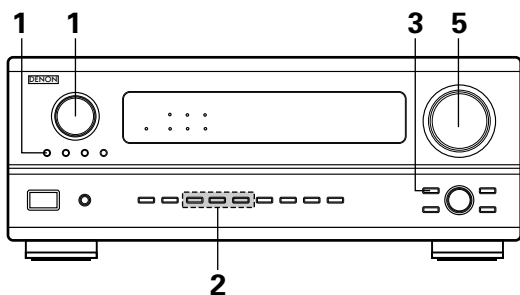

**1** Select the input source to be played.

**Example: CD**

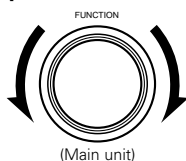

(Main unit)

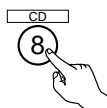

(Remote control unit)

※ To select the input source when REC /MULTI OUT or TUNING PRESET is selected, press the SOURCE button then operate the input function selector.



(Main unit)

**2** Select the input mode.

- Selecting the analog mode  
Press the ANALOG button to switch to the analog input.



(Main unit)



(Remote control unit)

- Selecting the external input (EXT. IN) mode  
Press the EXT. IN to switch the external input.



(Main unit)



(Remote control unit)

- Selecting the AUTO, PCM and DTS modes  
The mode switches as shown below each time the INPUT MODE button is pressed.

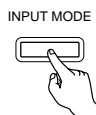
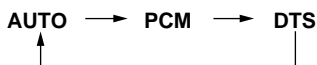

(Main unit)

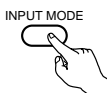

(Remote control unit)

### Input mode selection function

Different input modes can be selected for the different input sources. The selected input modes for the separate input sources are stored in the memory.

① AUTO (auto mode)

In this mode, the types of signals being input to the digital and analog input jacks for the selected input source are detected and the program in the AVR-2802/982's surround decoder is selected automatically upon playback. This mode can be selected for all input sources other than PHONO and TUNER.

The presence or absence of digital signals is detected, the signals input to the digital input jacks are identified and decoding and playback are performed automatically in DTS, Dolby Digital or PCM (2 channel stereo) format. If no digital signal is being input, the analog input jacks are selected.

Use this mode to play Dolby Digital signals.

② PCM (exclusive PCM signal playback mode)

Decoding and playback are only performed when PCM signals are being input.

Note that noise may be generated when using this mode to play signals other than PCM signals.

③ DTS (exclusive DTS signal playback mode)

Decoding and playback are only performed when DTS signals are being input.

④ ANALOG (exclusive analog audio signal playback mode)

The signals input to the analog input jacks are decoded and played.

⑤ EXT. IN (external decoder input jack selection mode)

The signals being input to the external decoder input jacks are played without passing through the surround circuitry.

### NOTE:

- Note that noise will be output when CDs or LDs recorded in DTS format are played in the "PCM" (exclusive PCM signal playback) or "ANALOG" (exclusive PCM signal playback) mode. Select the AUTO or DTS mode when playing signals recorded in DTS from a laser disc player or CD player.

### Note on playing a source encoded with DTS

- Noise may be generated at the beginning of playback and while searching during DTS playback in the AUTO mode. If so, play in the DTS mode.

- 3** Select the play mode.  
Press the SURROUND MODE button, then turn the SELECT knob.

**Example: Stereo**

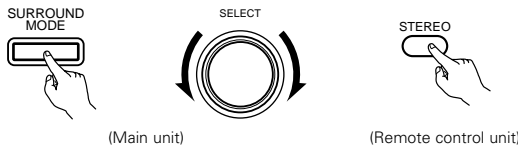

- ※ To select the surround mode while adjusting the surround parameters, channel volume or tone control, press the surround mode button then operate the selector.

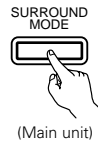

- 4** Start playback on the selected component.  
• For operating instructions, refer to the component's manual.

- 5** Adjust the volume.

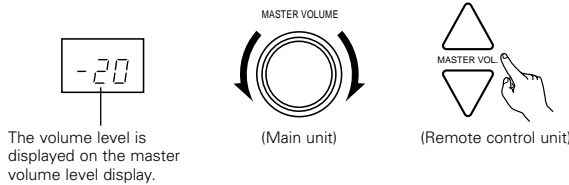

The volume level is displayed on the master volume level display.

- ※ The volume can be adjusted within the range of -70 to 0 to 18 dB, in steps of 1 dB. However, when the channel level is set as described on page 22 or pages 42 and 43, if the volume for any channel is set at +1 dB or greater, the volume cannot be adjusted up to 18 dB. (In this case the maximum volume adjustment range is "18 dB — (Maximum value of channel level)".)

Input mode when playing DTS sources

- Noise will be output if DTS-compatible CDs or LDs are played in the "ANALOG" or "PCM" mode.  
When playing DTS-compatible sources, be sure to connect the source component to the digital input jacks (OPTICAL/COAXIAL) and set the input mode to "DTS".

Input mode display

- In the AUTO mode

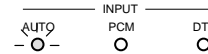

- In the DIGITAL PCM mode

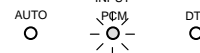

- In the DIGITAL DTS mode

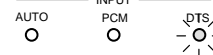

- In the ANALOG mode

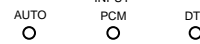

One of these lights, depending on the input signal.

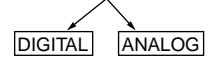

DIGITAL

DIGITAL

ANALOG

Input signal display

- DOLBY DIGITAL

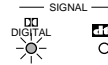

- DTS

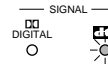

- PCM



- ※ The **DIGITAL** indicator lights when digital signals are being input properly. If the **DIGITAL** indicator does not light, check whether the digital input component setup (page 24) and connections are correct and whether the component's power is turned on.

**NOTE:**

- The **DIGITAL** indicator will light when playing CD-ROMs containing data other than audio signals, but no sound will be heard.

## Playback using the external input (EXT. IN) jacks

- 1** Set the external input (EXT. IN) mode.  
Press the EXT. IN to switch the external input.

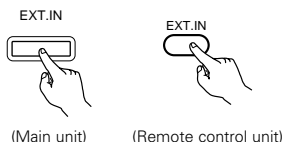

Once this is selected, the input signals connected to the FL (front left), FR (front right) and C (center) channels of the EXT. IN jacks are output directly to the front (left and right) and center speaker systems as well as the pre-out jacks without passing through the surround circuitry. In addition, the signal input to the SW (subwoofer) jack is output to the PRE OUT SUBWOOFER jack.

- 2** Cancelling the external input mode  
To cancel the external input (EXT. IN) setting, press the INPUT MODE (AUTO, PCM, DTS) or ANALOG button to switch to the desired input mode. (See page 36.)

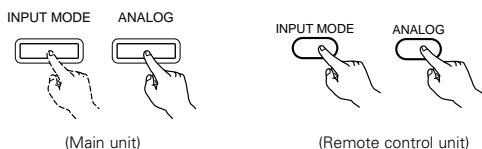

- When the input mode is set to the external input (EXT. IN), the play mode (DIRECT, STEREO, DOLBY/DTS SURROUND, 5CH/6CH STEREO or DSP SIMULATION) cannot be set.

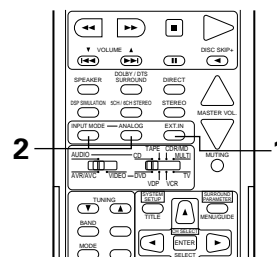
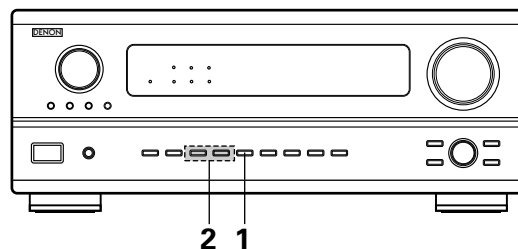

**NOTES:**

- In play modes other than the external input mode, the signals connected to these jacks cannot be played. In addition, signals cannot be output from channels not connected to the input jacks.
- The external input mode can be set for any input source. To watch video while listening to sound, select the input source to which the video signal is connected, then set this mode.

## After starting playback

### [1] Adjusting the sound quality (tone)

The tone control function will not work in the direct mode.

- 1** The tone switches as follows each time the TONE CONTROL button is pressed.

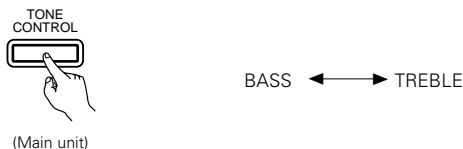

- 2** With the name of the volume to be adjusted selected, turn the SELECT knob to adjust the level.

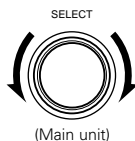

- To increase the bass or treble: Turn the control clockwise. (The bass or treble sound can be increased to up to +12 dB in steps of 2 dB.)
- To decrease the bass or treble: Turn the control clockwise. (The bass or treble sound can be decreased to up to -12 dB in steps of 2 dB.)

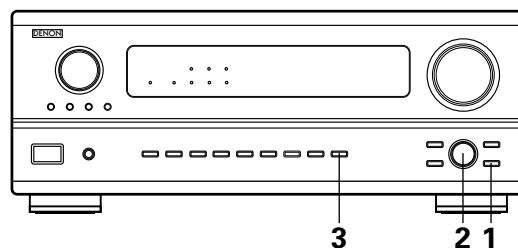

- 3** If you do not want the bass and treble to be adjusted, turn on the tone defeat mode.



※ The signals do not pass through the bass and treble adjustment circuits, providing higher quality sound.

**[2] Listening over headphones**

- 1** Connect the headphones to the PHONES jack of the front panel.

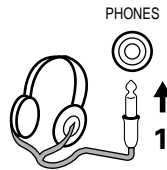

- 2** Press the SPEAKER A or B to turn the speaker off.

- The output to the speaker and pre-out jacks is turned off and no sound is produced from the speakers.

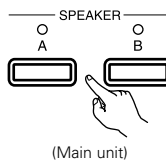

**NOTE:**

To prevent hearing loss, do not raise the volume level excessively when using headphones.

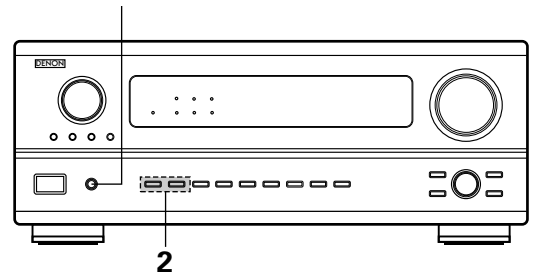

**[3] Turning the sound off temporarily (muting)**

- 1** Use this to turn off the audio output temporarily. Press the MUTING button.

※ Cancelling MUTING mode.

- Press the MUTING button again.

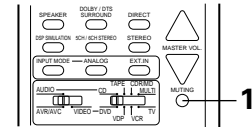
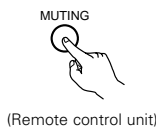

**[4] Combining the currently playing sound with the desired image**

- 1** Simulcast playback Use this switch to monitor a video source other than the audio source. Press the VIDEO SELECT button repeatedly until the desired source appears on the display.

※ Cancelling simulcast playback.

- Select "SOURCE" using the video select button.
- Switch the program source to the component connected to the video input.

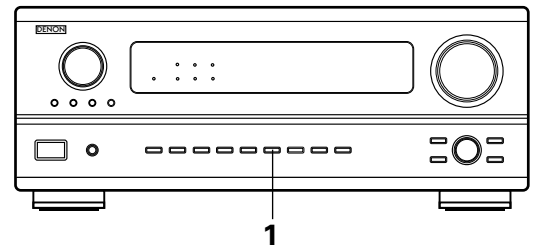
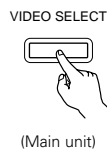

**[5] Checking the currently playing program source, etc.**

- 1** On screen display
- Each time an operation is performed, a description of that operation appears on the display connected to the unit's VIDEO MONITOR OUT jack. Also, the unit's operating status can be checked during playback by pressing the remote control unit's ON SCREEN button.
- Such information as the position of the input selector and the surround parameter settings is output in sequence.

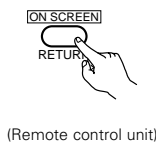

Front panel display

- Descriptions of the unit's operations are also displayed on the front panel display. In addition, the display can be switched to check the unit's operating status while playing a source by pressing the STATUS button.

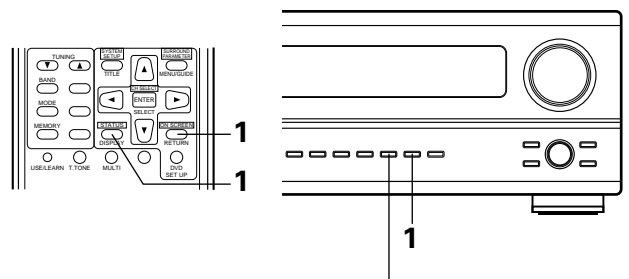
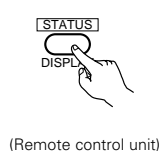
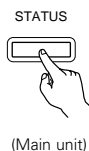

Using the dimmer function

- Use this to change the brightness of the display. The display brightness changes in four steps (bright, medium, dim and off) by pressing the remote control unit's DIMMER button repeatedly.
- ※ The brightness changes in 3 steps each time the button is pressed, and finally the display turns off.

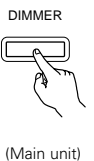

## Multi-source recording/playback

### [1] Playing one source while recording another (REC OUT mode)

**1** Press the REC/MULTI button.



(Main unit)

**2** With "RECOUT SOURCE" displayed, turn the FUNCTION knob to select the source you wish to record.

- The "REC" indicator and the indicator of the selected source light.

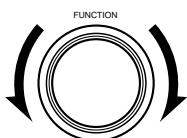

(Main unit)

**3** Set the recording mode.

- For operating instructions, refer to the manual of the component on which you want to record.

**4** To cancel, turn the function knob and select "SOURCE".

- When "SOURCE" is selected, the "REC" indicator turns off.

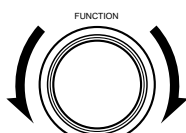

(Main unit)

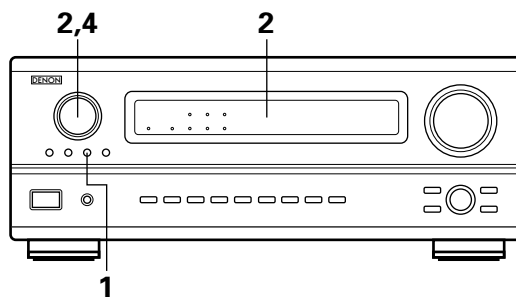

Display

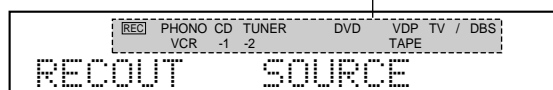

#### NOTES:

- Recording sources other than digital inputs selected in the REC OUT mode are also output to the multi source audio output jacks.
- Digital signals are not output from the REC SOURCE or audio output jacks.

### [2] Outputting a program source to an amplifier, etc., in a different room (MULTI mode)

**1** Press the REC/MULTI button. The display switches as follows each time the button is pressed.



(Main unit)

**2** With "M-SOURCE SOURCE" displayed, turn the FUNCTION knob and select the source you wish to output.

- The "MULTI" indicator and the indicator of the selected source light.

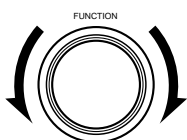

(Main unit)

- When the AVR-2802/982 is the REC OUT mode, the source cannot be output using the MULTI button on the remote control unit.



(Remote control unit)

**3** Start playing the source to be output.

- For operating instructions, refer to the manuals of the respective components.

**4** To cancel, turn the function knob and select "SOURCE".

- When "SOURCE" is selected, the "MULTI" indicator turns off.

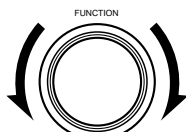

(Main unit)

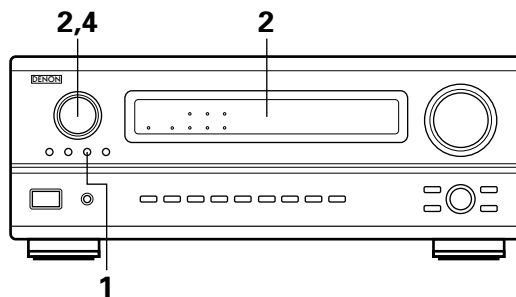

Display

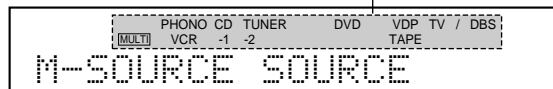

#### NOTES:

- The signals of the source selected in the MULTI mode are also output from the VCR-1, VCR-2/AUX and CDR/TAPE recording output terminals.
- Digital signals are not output from the multi source audio output jacks.



**[3] Remote control unit operations during multi-source playback (selecting the source)**

**1** Set the slide switch to "AUDIO" and "MULTI".

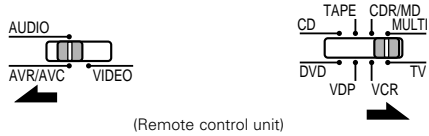

(Remote control unit)

**2** Press the input source button. **Example: CD**  
The multi source switches directly.

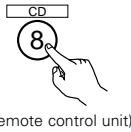

(Remote control unit)

The remote control unit's MULTI button can be operated at positions other than "MULTI".



(Remote control unit)

The multi source switches in order each time the multi button is pressed.

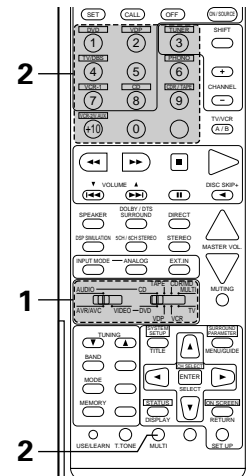

**Multi-zone playback with multi-source**

**MULTI ZONE MUSIC ENTERTAINMENT SYSTEM**

- When the outputs of the MULTI ZONE OUT terminals are wired and connected to integrated amplifiers installed in other rooms, different sources can be played in rooms other than the main room in which this unit and the playback devices are installed. (Refer to ANOTHER ROOM on the diagram below.)
- When a sold separately room-to-room remote control unit (DENON RC-616, 617 or 618) is wired and connected between the main room and another room, the remote-controllable devices in the main room can be controlled from another room using the remote control unit.
- ※ To control playback devices other than the ones above, either use that device's remote control unit or preset a separately sold programmable remote control unit.

**NOTES:**

- For the AUDIO output, use high quality pin-plug cords and wire in such a way that there is no humming or noise.
- For instructions on installation and operation of separately sold devices, refer to the devices' operating instructions.

**■ MULTI ZONE MUSIC ENTERTAINMENT SYSTEM (When using MULTI ZONE OUT)**

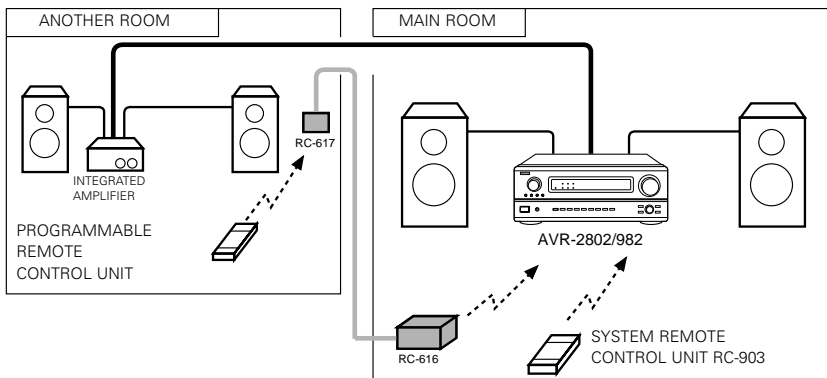

— ROOM-TO-ROOM REMOTE CONTROL SYSTEM (separately sold) control line  
 — MULTI SOURCE AUDIO signal cable  
 — SPEAKER cable

\* Refer to CONNECTIONS on pages 6 to 13.

# 10 SURROUND

## Before playing with the surround function

- Before playing with the surround function, be sure to use the test tones to adjust the playback level from the different speakers. This adjustment can be performed with the system setup (see page 22) or from the remote control unit, as described below.
- Adjusting with the remote control unit using the test tones is only possible in the "Auto" mode and only effective in the DOLBY/DTS SURROUND modes. The adjusted levels for the different modes are automatically stored in the memory.

**1** Press the T. TONE button.



(Remote control unit)

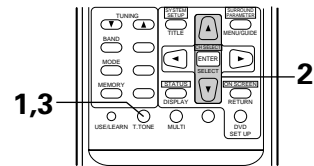

**2** Test tones are output from the different speakers. Use the channel volume adjust buttons to adjust so that the volume of the test tones is the same for all the speakers.

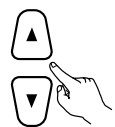

(Remote control unit)

**3** After completing the adjustment, press the T. TONE button again.



(Remote control unit)

- After adjusting using the test tones, adjust the channel levels either according to the playback sources or to suit your tastes, as described below.

**1** Select the speaker whose level you want to adjust.



(Main unit)



(Remote control unit)

The channel switches as shown below each time the button is pressed.

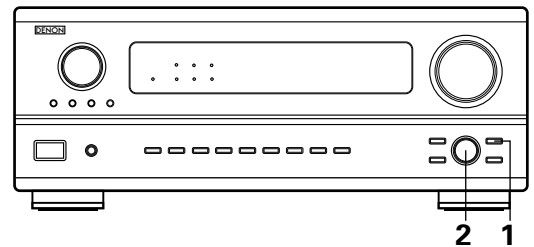
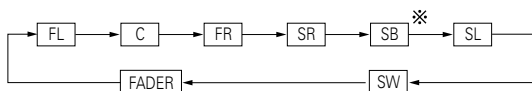

**2** Adjust the level of the selected speaker.

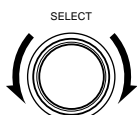

(Main unit)



(Remote control unit)

Only adjustable when the channel is selected with the CH VOL buttons on the main unit.

**NOTES:**

- The adjustment range for the different channels is +12 dB to -12 dB.
- When using the DIRECT mode, the sound from the subwoofer can be cut by lowering the SW (subwoofer) setting one step from -12 dB (setting it to "OFF").

※ When the surround back speaker setting is set to "2spkr" for "Speaker Configuration", this is set to "SBR", "SBL".

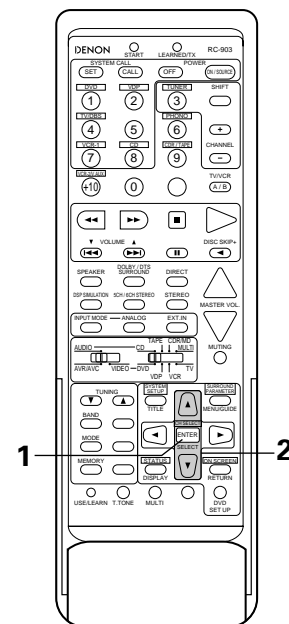

## Fader function

- This function makes it possible to lower the volume of the front channels (FL, C and FR) or the rear channels (SL and SR) together. Use it for example to adjust the balance of the sound from the different positions when playing multi-channel music sources.

**1** Select "FADER".

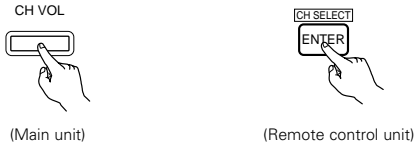

The channel switches in the order shown below each time this button is pressed.

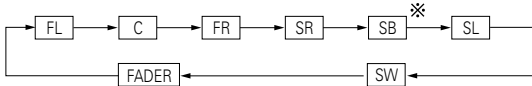

\* When the surround back speaker setting is set to "2spkrs" for "Speaker Configuration", this is set to "SBR", "SBL".

**2** Press the  $\nabla$  button to reduce the volume of the front channels, the  $\Delta$  button to reduce the volume of the rear channels.



- The channel whose channel level is adjusted lowest can be faded to -12 dB using the fader function.
- If the channel levels are adjusted separately after adjusting the fader, the fader adjustment values are cleared, so adjust the fader again.

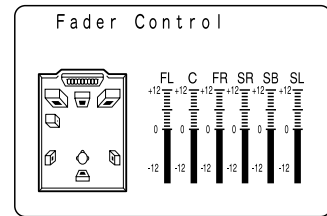
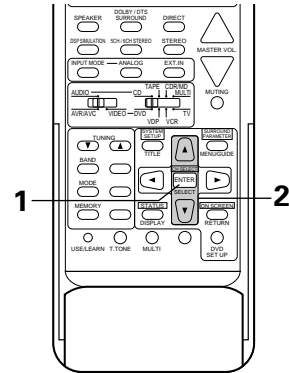
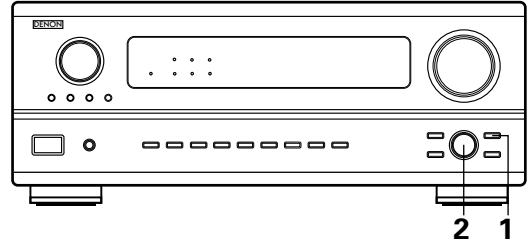

This is only displayed when setting the fader control.

## Dolby Surround Pro Logic II mode

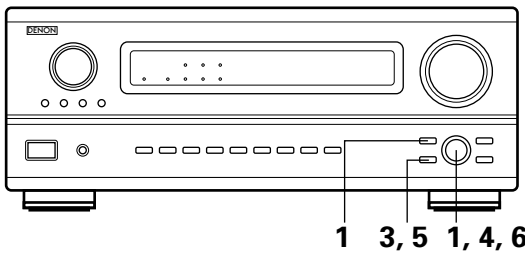

**1** Select the Dolby Surround Pro Logic II mode.

- The Dolby Pro Logic indicator lights.

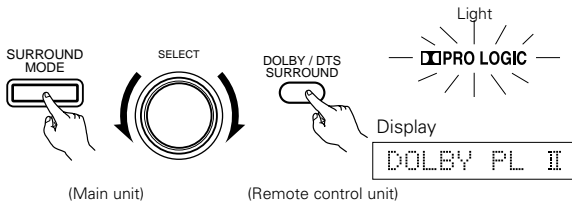

**2** Play a program source with the **PRO LOGIC** mark.

- For operating instructions, refer to the manuals of the respective components.

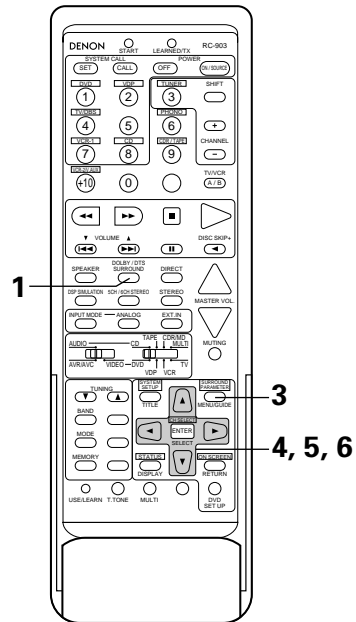

### 3 Set the surround parameter mode.

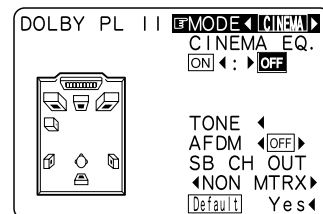
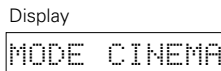
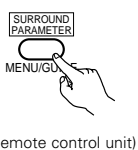
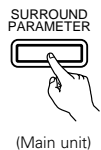

※ The on-screen display differs according to whether the operation is performed from the main unit or the remote control unit.

### 4 Select the play mode.

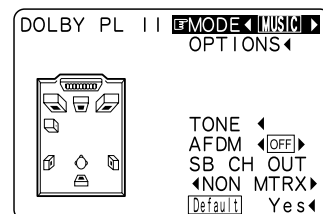
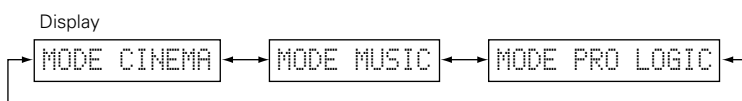
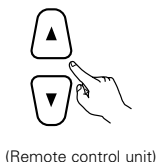
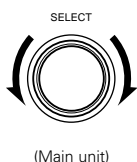

### 5 Select the various parameters. (See "Surround parameters ①" for a description of the various parameters.)

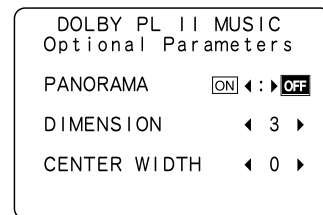
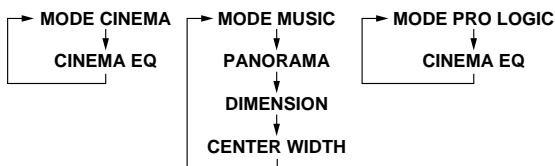
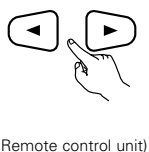

※ When set with the on-screen display using the remote control unit while in the MUSIC mode, set the " " mark to "OPTION ◀" using the Δ and ▽ cursor buttons, then press the ◀ cursor button. Press the ENTER button to return to the previous screen.

### 6 Set the various surround parameters.

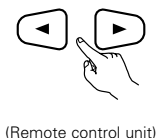
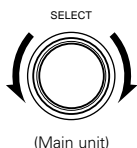

7 When the surround parameters are set using the buttons on the main unit, stop operating buttons after completing the settings. The settings are automatically finalized and the normal display reappears after several seconds.

When the settings are made using the buttons on the remote control unit, press the SURR. PARA. button to finish.

**NOTE:**

- There are four Dolby Surround Pro Logic modes (NORMAL, PHANTOM, WIDE and 3 STEREO). The AVR-2802/982 sets the mode automatically according to the types of speakers set during the system setup process (page 17).

**Surround parameters ①**

**Pro Logic II Mode:**

The Cinema mode is for use with stereo television shows and all programs encoded in Dolby Surround.

The Music mode is recommended as the standard mode for autosound music systems (no video), and is optional for A/V systems.

The Pro Logic mode offers the same robust surround processing as original Pro Logic in case the source contents is not of optimum quality.

Select one of the modes ("Cinema", "Music" or "Pro Logic").

**Panorama Control:**

This mode extends the front stereo image to include the surround speakers for an exciting "wraparound" effect with side wall imaging.

Select "OFF" or "ON".

**Dimension Control:**

This control gradually adjust the soundfield either towards the front or towards the rear.

The control can be set in 7 steps from 0 to 6.

**Center Width Control:**

This control adjust the center image so it may be heard only from the center speaker; only from the left/right speakers as a phantom image; or from all three front speakers to varying degrees.

The control can be set in 8 steps from 0 to 7.

## Dolby Digital mode (only with digital input) and DTS Surround mode (only with digital input)

### 1 Select the input source.

Playback with a digital input

- ① Select an input source set to digital (COAXIAL/OPTICAL).  
(see page 24).

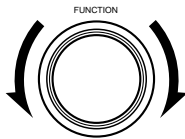

(Main unit)



(Remote control unit)

- ② Set the input mode to "AUTO" or "DTS".

INPUT MODE



(Main unit)

INPUT MODE



(Remote control unit)

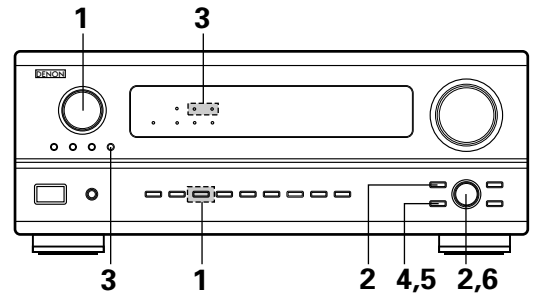

### 2 Select the Dolby/DTS Surround mode.



(Remote control unit)

When performing this operation from the main unit's panel, press the SURROUND MODE button, then turn the SELECT knob and select Dolby Pro Logic or DTS NEO:6.

SURROUND MODE



(Main unit)

SELECT



(Main unit)

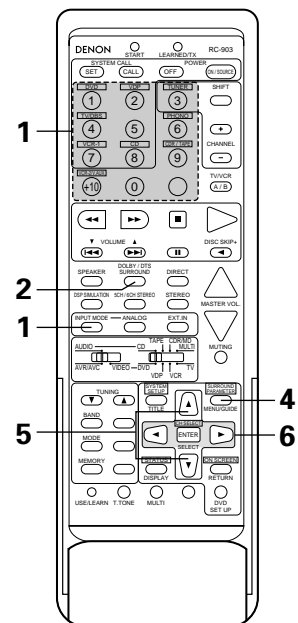

### 3 Play a program source with the , mark.



Light

- The Dolby Digital indicator lights when playing Dolby Digital sources.

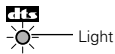

Light

- The DTS indicator lights when playing DTS sources.

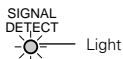

Light

- The SIGNAL DETECT LED lights when playing DTS-ES/6.1-channel surround sources containing the identification signal.

※ When the SIGNAL DETECT LED is lit, we recommend turning the surround back channel using the 6.1/7.1 Surround button on the remote control unit and main unit during playback.

Operate the 6.1/7.1 Surround button to switch Surround Back CH ON/OFF.

6.1/7.1 SURROUND



(Main unit)

SURROUND BACK CH OUTPUT

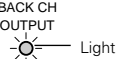

Light

- Lights when the 6.1/7.1 Surround mode is on.

4

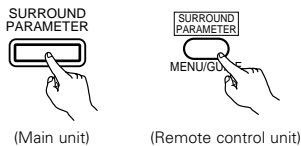

Display the surround parameter menu.

**NOTE:** The display on the screen differs depending on whether you are performing the operation from the main unit or the remote control unit.

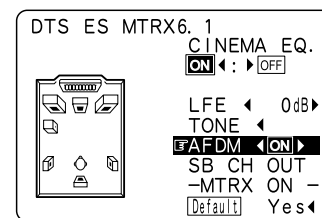
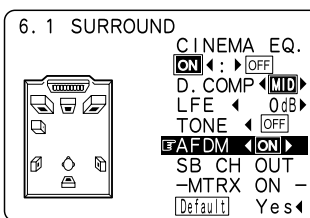

5

Select the various parameters.

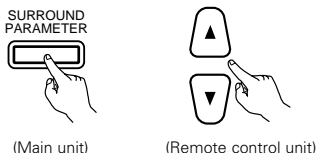

6

Adjust the parameter settings.

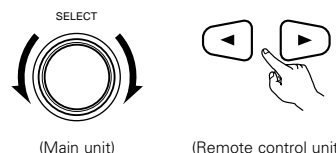

■ Dialogue Normalization

The dialogue normalization function is activated automatically when playing Dolby Digital program sources. Dialogue normalization is a basic function of Dolby Digital which automatically normalizes the dialog level (standard level) of the signals which are recorded at different levels for different program sources, such as DVD, DTV and other future formats that will use Dolby Digital. These contents can be verified with the STATUS button.

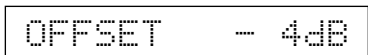

The number indicates the normalization level when the currently playing program is normalized to the standard level.

**NOTE:**

- When "Default" is selected and the cursor button is pressed, "CINEMA EQ." and "D.COMP." are automatically turned off, "LFE" is reset, and the tone is set to the default value.

**Surround parameters ②**

**CINEMA EQ. (Cinema Equalizer):**

The Cinema EQ function gently decreases the level of the extreme high frequencies, compensating for overly-bright sounding motion picture soundtracks. Select this function if the sound from the front speakers is too bright.

This function only works in the Dolby Pro Logic, Dolby Digital and DTS Surround modes. (The same contents are set for all operating modes.)

**D.COMP. (Dynamic Range Compression):**

Motion picture soundtracks have tremendous dynamic range (the contrast between very soft and very loud sounds). For listening late at night, or whenever the maximum sound level is lower than usual, the Dynamic Range Compression allows you to hear all of the sounds in the soundtrack (but with reduced dynamic range). (This only works when playing program sources recorded in Dolby Digital.) Select one of the four parameters ("OFF", "LOW", "MID" (middle) or "HI" (high)). Set to OFF for normal listening.

**LFE (Low Frequency Effect):**

This sets the level of the LFE (Low Frequency Effect) sounds included in the source when playing program sources recorded in Dolby Digital or DTS. If the sound produced from the subwoofer sounds distorted due to the LFE signals when playing Dolby Digital or DTS sources when the peak limiter is turned off with the subwoofer peak limit level setting (system setup menu), adjust the level as necessary.

Program source and adjustment range:

1. Dolby Digital: -10 dB to 0 dB
2. DTS Surround: -10 dB to 0 dB

※ When DTS encoded movie software is played, it is recommended that the LFE LEVEL be set to 0 dB for correct DTS playback.

※ When DTS encoded music software is played, it is recommended that the LFE LEVEL be set to -10 dB for correct DTS playback.

**TONE:**

This adjusts the tone control. (See "Surround parameters ③" on page 51.)

**AFDM (Auto Flag Detect Mode):**

Turns the auto flag detect mode on and off. (See page 20.)

For 5-channel Dolby Digital/DTS sources:

The surround back channel play mode can be selected when the AFDM (Auto Flag Detect Mode) is set to "OFF". The parameters that can be selected are the same as the "Non-Flag Source SBch Output" settings.

When the AFDM (Auto Flag Detect Mode) is set to "ON", the setting selected at "Non-Flag Source SBch Output" are displayed. (See page 20.)

If you wish to change the setting, set the AFDM (Auto Flag Detect Mode) to "OFF".

**SB CH OUT (6.1/7.1 Surround):**

(1) Dolby Digital/DTS source

- "OFF" .....Playback is conducted without using the surround back speaker.
- "NON MTRX" .....Playback is conducted using the surround back speaker.  
The same signals those of the surround channels are output from the surround back channels.
- "MTRX ON" .....Playback is conducted using the surround back speaker.  
Surround back channel is reproduced using digital matrix processing.

(2) Other source

- "OFF" .....Playback is conducted without using the surround back speaker.
- "ON" .....Playback is conducted using the surround back speaker.

**NOTE:** This operation can be performed directly using the "6.1/7.1 Surround" button on the main unit's panel.

## 11 DSP SURROUND SIMULATION

- The AVR-2802/982 is equipped with a high performance DSP (Digital Signal Processor) which uses digital signal processing to synthetically recreate the sound field. One of six preset surround modes can be selected according to the program source and the parameters can be adjusted according to the conditions in the listening room to achieve a more realistic, powerful sound. These surround modes can also be used for program sources not recorded in Dolby Surround Pro Logic or Dolby Digital and DTS surround.

### Surround modes and their features

1	ROCK ARENA	Use this mode to achieve the feeling of a live concert in an arena with reflected sounds coming from all directions.
2	JAZZ CLUB	This mode creates the sound field of a live house with a low ceiling and hard walls. This mode gives jazz a very vivid realism.
3	VIDEO GAME	Use this to enjoy video game sources.
4	MATRIX	Select this to emphasize the sense of expansion for music sources recorded in stereo. Signals consisting of the difference component of the input signals (the component that provides the sense of expansion) processed for delay are output from the surround channel.
5	5CH/6CH STEREO	In this mode, the signals of the front left channel are output from the left surround channel, the signals of the front right channel are output from the right surround channel, and the same (in-phase) component of the left and right channels is output from the center channel. This mode provides all speaker surround sound, but without directional steering effects, and works with any stereo program source.
6	MONO MOVIE (NOTE 1)	Select this when watching monaural movies for a greater sense of expansion.

- ※ Depending on the program source being played, the effect may not be very noticeable.  
In this case, try other surround modes, without worrying about their names, to create a sound field suited to your tastes.

NOTE 1: When playing sources recorded in monaural, the sound will be one-sided if signals are only input to one channel (left or right), so input signals to both channels. If you have a source component with only one audio output (monophonic camcorder, etc.) obtain a "Y" adaptor cable to split the mono output to two outputs, and connect to the L and R inputs.

#### NOTE:

Only the DIRECT mode can be used when playing PCM signals with a sampling frequency of 96 kHz (such as from DVD-Video discs that contain 24 bit, 96 kHz audio). If such signals are input during playback in one of the other surround modes, the mode automatically switches to DIRECT.

#### Personal Memory Plus

This set is equipped with a personal memorize function that automatically memorizes the surround modes and input modes selected for the input different sources. When the input source is switched, the modes set for that source last time it was used are automatically recalled.

- ※ The surround parameters, tone control settings and playback level balance for the different output channels are memorized for each surround mode.

## DSP surround simulation

- To operate the surround mode and surround parameters from the remote control unit.

**1** Select the surround mode for the input channel.

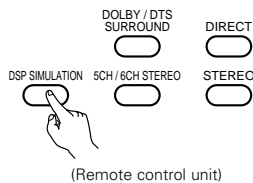

(Remote control unit)

The surround mode switches in the following order each time the DSP SIMULATION button is pressed:

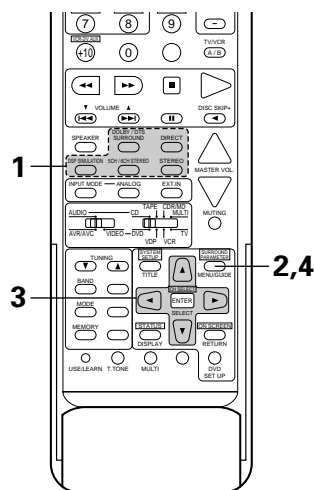

**2** Display the surround parameter screen on the monitor.  
 ※ The screen for the selected surround mode appears.

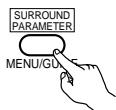

(Remote control unit)

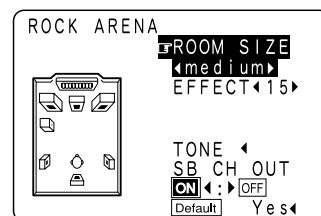

**3** Set the parameters.



(Remote control unit)

**4** To end the setting mode, press the surround parameter button again.

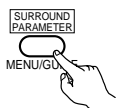

(Remote control unit)

**NOTES:**

- When "Default" is selected, "CINEMA EQ." and "D.COMP." are automatically turned off, "ROOM SIZE" is set to "medium", "EFFECT LEVEL" to "10", "DELAY TIME" to "30ms" and "LFE" to "0dB".
- The "ROOM SIZE" expresses the expansion effect for the different surround modes in terms of the size of the sound field, not the actual size of the listening room.



- Operating the surround mode and surround parameters from the main unit's panel.

**1** Turn the SELECT knob to select the surround mode.

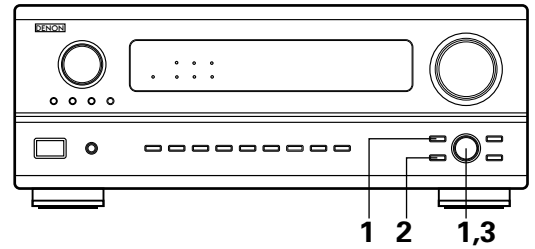
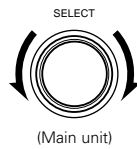

- When turned clockwise

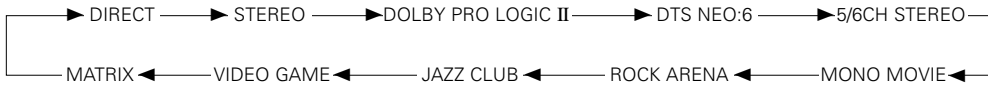

- When turned counterclockwise

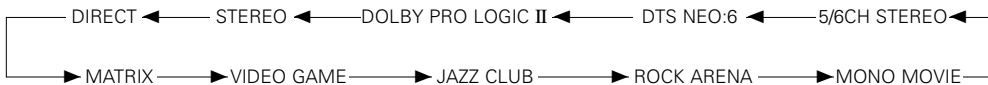

- ※ To select the surround mode while adjusting the surround parameters, channel volume or tone control, press the surround mode button then operate the selector.

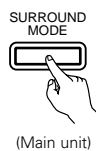

**2** Press the SURROUND PARAMETER button.

Press and hold in the surround parameter button to select the parameter you want to set.

- The parameters which can be set differ for the different surround modes. (Refer to "Surround Modes and Parameters" on page 52.)

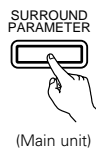

**3** Display the parameter you want to adjust, then turn the SELECT knob to set it.

**NOTE:**

- When playing PCM digital signals or analog signals in the DOLBY PRO LOGIC, DTS NEO:6 modes and the input signal switches to a digital signal encoded in Dolby Digital, the Dolby surround mode switches automatically. When the input signal switches to a DTS signal, the mode automatically switches to DTS surround.
- When the "5CH/6CH STEREO" mode is selected, the display differs according to the SB CH OUT setting.  
Surround Back CH ON : 6CH STEREO  
Surround Back CH OFF : 5CH STEREO

## Tone control setting

- Use the tone control setting to adjust the bass and treble as desired.
- To operate the tone control from the remote control unit.

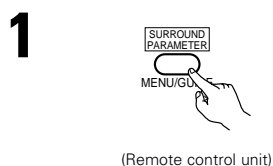

Display the surround parameter screen on the monitor.  
 ※ The screen for the selected surround mode appears.  
 "TONE" cannot be selected in the Direct mode.

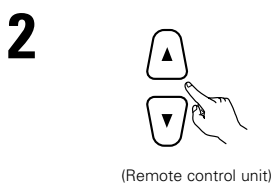
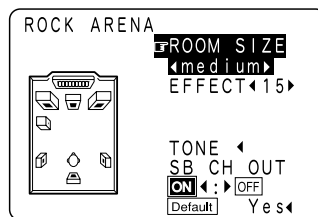

Select "TONE".

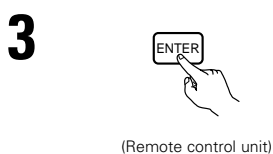
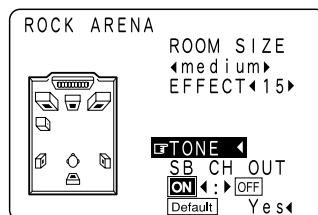

Switch to the Tone Control screen.

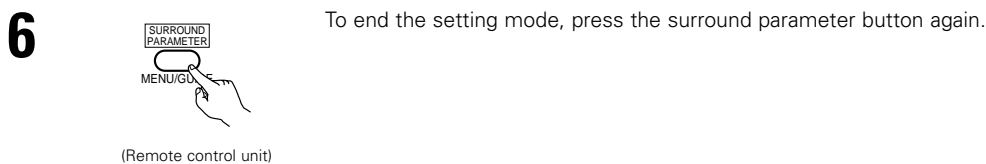
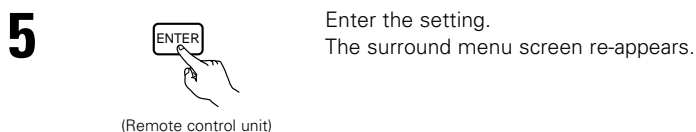
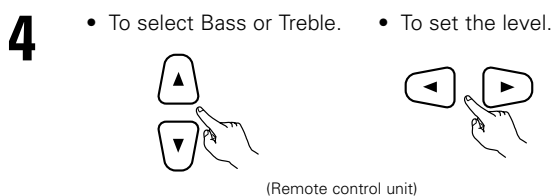
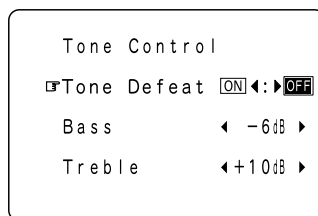

- To operate the tone control from the main unit.

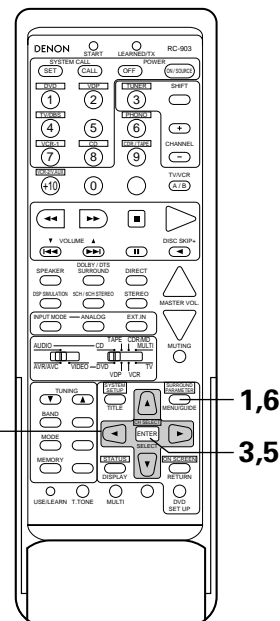
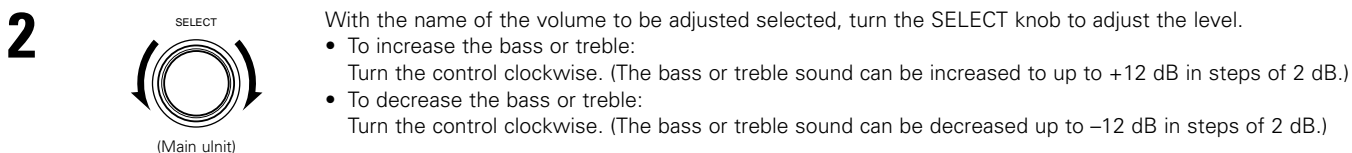
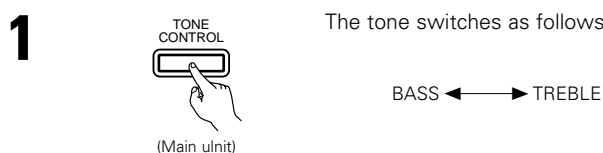

**Surround parameters** ③**MODE: (DTS NEO:6)****• Cinema**

This mode is optimum for playing movies. Decoding is performed with emphasis on separation performance to achieve the same atmosphere with 2-channel sources as with 6.1-channel sources.

This mode is effective for playing sources recorded in conventional surround formats as well, because the in-phase component is assigned mainly to the center channel (C) and the reversed phase component to the surround (SL, SR and SB channels).

**• Music**

This mode is suited mainly for playing music. The front channel (FL and FR) signals bypass the decoder and are played directly so there is no loss of sound quality, and the effect of the surround signals output from the center (C) and surround (SL, SR and SB) channels add a natural sense of expansion to the sound field.

**ROOM SIZE:**

This sets the size of the sound field.

There are five settings: "small", "med.s" (medium-small), "medium", "med.l" (medium-large) and "large". "small" recreates a small sound field, "large" a large sound field.

**EFFECT LEVEL:**

This sets the strength of the surround effect.

The level can be set in 15 steps from 1 to 15. Lower the level if the sound seems distorted.

**DELAY TIME:**

In the matrix mode only, the delay time can be set within the range of 0 to 110 ms.

**tone CONTROL:**

This can be set individually for the separate surround modes other than Direct.

However, the same contents are set for DOLBY/DTS modes.

■ Surround modes and parameters

Mode	Channel output					When playing Dolby Digital signals	When playing DTS signals	When playing PCM signals	When playing ANALOG signals
	FRONT L/R	CENTER	SURROUND L/R	SUB-WOOFER	SURROUND BACK L/R				
DIRECT	○	×	×	⊗	×	○	○	○	○
STEREO	○	×	×	⊗	×	○	○	○	○
EXTERNAL INPUT	○	⊗	⊗	⊗	⊗	×	×	×	○
DOLBY PRO LOGIC II	○	⊗	⊗	⊗	⊗	○ *	×	○	○
DTS NEO:6	○	⊗	⊗	⊗	⊗	×	×	○	○
DOLBY DIGITAL (6.1 SURROUND)	○	⊗	⊗	⊗	⊗	○	×	×	×
DTS SURROUND (DTS ES MTRX 6.1)	○	⊗	⊗	⊗	⊗	×	○	×	×
5/6CH STEREO	○	⊗	⊗	⊗	⊗	×	×	○	○
ROCK ARENA	○	⊗	⊗	⊗	⊗	×	×	○	○
JAZZ CLUB	○	⊗	⊗	⊗	⊗	×	×	○	○
VIDEO GAME	○	⊗	⊗	⊗	⊗	×	×	○	○
MONO MOVIE	○	⊗	⊗	⊗	⊗	×	×	○	○
MATRIX	○	⊗	⊗	⊗	⊗	×	×	○	○

\* Only for 2 ch contents.

○ : Signal  
 × : No signal  
 ⊗ : Turned on or off by speaker configuration setting

○ : Able  
 × : Unable

Mode	Parameter (default values are shown in parentheses)														
	SURROUND PARAMETER										PRO LOGIC II MUSIC MODE ONLY			When playing Dolby Digital/DTS signals	
	TONE CONTROL	MODE	CINEMA EQ.	EFFECT	LEVEL	ROOM SIZE	EFFECT LEVEL	DELAY TIME	SURROUND BACK	PANORAMA	DIMENSION	CENTER WIDTH	D. COMP	LFE	
DIRECT	×	×	×	×	×	×	×	×	×	×	×	×	○ (OFF)	○ (0dB)	
STEREO	○ (0dB)	×	×	×	×	×	×	×	×	×	×	×	○ (OFF)	○ (0dB)	
EXTERNAL INPUT	○ (0dB)	×	×	×	×	×	×	×	×	×	×	×	×	×	
DOLBY PRO LOGIC II	○ (0dB)	○ (CINEMA)	○ (OFF)	×	×	×	×	×	○ (NON MTRX)	○ (OFF)	○ (3)	○ (0)	○ (OFF)	○ (0dB)	
DTS NEO:6	○ (0dB)	○ (CINEMA)	○ (OFF)	×	×	×	×	×	○ (NON MTRX)	×	×	×	×	×	
DOLBY DIGITAL (6.1 SURROUND)	○ (0dB)	×	○ (OFF)	×	×	×	×	×	○ (MTRX ON)	×	×	×	○ (OFF)	○ (0dB)	
DTS SURROUND (DTS ES MTRX 6.1)	○ (0dB)	×	○ (OFF)	×	×	×	×	×	○ (MTRX ON)	×	×	×	×	○ (0dB)	
5/6CH STEREO	○ (0dB)	×	×	×	×	×	×	×	○	×	×	×	×	×	
ROCK ARENA	○ (0dB)	×	×	×	×	○ (Medium)	○ (10)	×	○	×	×	×	×	×	
JAZZ CLUB	○ (0dB)	×	×	×	×	○ (Medium)	○ (10)	×	○	×	×	×	×	×	
VIDEO GAME	○ (0dB)	×	×	×	×	○ (Medium)	○ (10)	×	○	×	×	×	×	×	
MONO MOVIE	○ (0dB)	×	×	×	×	○ (Medium)	○ (10)	×	○	×	×	×	×	×	
MATRIX	○ (0dB)	×	×	×	×	×	×	○ (30msec)	○	×	×	×	×	×	

○ : Adjustable  
 × : Not adjustable

## 12 LISTENING TO THE RADIO

### Auto tuning

- 1** Set the input function to "TUNER".

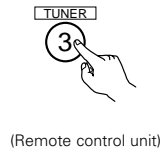
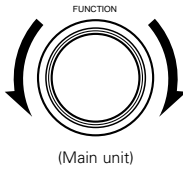

- 2** Watching the display, press the BAND button to select the desired band (AM or FM).

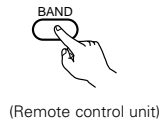

- 3** Press the MODE button to set the auto tuning mode.

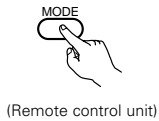

"Auto" appears on the display.

- 4** Press the TUNING UP or DOWN button.

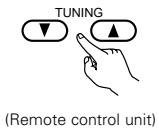

Automatic searching begins, then stops when a station is tuned in.

If tuning does not stop at the desired station, use the "Manual tuning" operation.

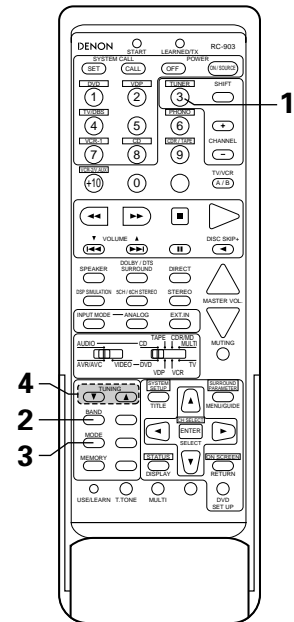
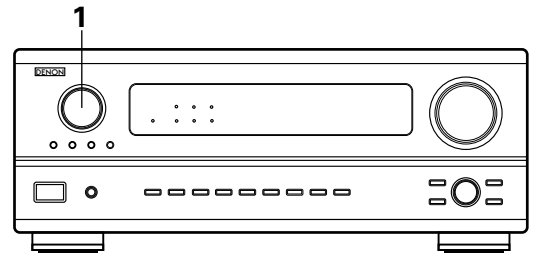

### Manual tuning

- 1** Set the input function to "TUNER".

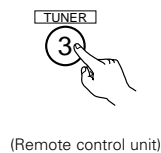
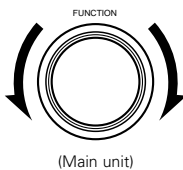

- 2** Watching the display, press the BAND button to select the desired band (AM or FM).

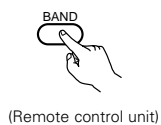

- 3** Press the MODE button to set the manual tuning mode. Check that the display's "AUTO" indicator turns off.

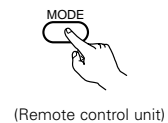

- 4** Press the TUNING UP or DOWN button to tune in the desired station. The frequency changes continuously when the button is held in.

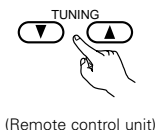

#### NOTES:

- When in the auto tuning mode on the FM band, the "STEREO" indicator lights on the display when a stereo broadcast is tuned in. At open frequencies, the noise is muted and the "TUNED" and "STEREO" indicators turn off.
- When the manual tuning mode is set, FM stereo broadcasts are received in monaural and the "STEREO" indicator turns off.

## Preset memory

**1** Use the "Auto tuning" or "Manual tuning" operation to tune in the station to be preset in the memory.

**2** Press the MEMORY button.



(Remote control unit)

**3** Press the SHIFT button and select the desired memory block (A to E).



(Remote control unit)

**4** Press the CHANNEL + (UP) or - (DOWN) button to select the desired preset channel (1 to 8).

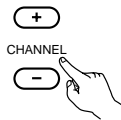

(Remote control unit)

**5** Press the MEMORY button again to store the station in the preset memory.



(Remote control unit)

To preset other channels, repeat steps 2 to 5.  
A total of 40 broadcast stations can be preset — 8 stations (channels 1 to 8) in each of blocks A to E.

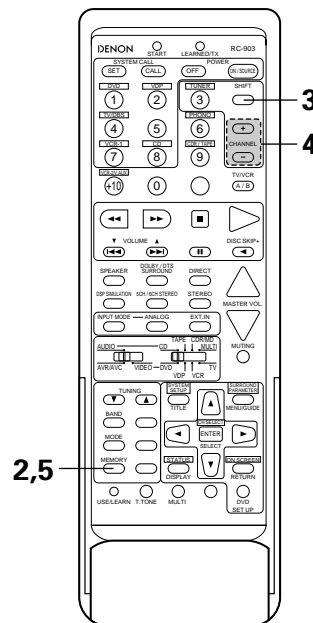

## Checking the preset stations

- The preset broadcast stations can be checked on the on screen display.

**1** Press the ON SCREEN button repeatedly until the "Tuner Preset Stations" screen appears on the on screen display.

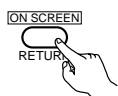

(Remote control unit)

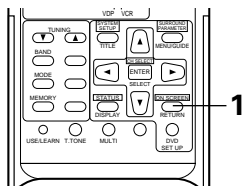

Tuner Preset Stations	
A1 FM	87.50MHz
A2 FM	89.10MHz
A3 FM	98.10MHz
A4 FM	107.90MHz
A5 FM	90.10MHz
A6 FM	90.10MHz
A7 FM	90.10MHz
A8 FM	90.10MHz

## Recalling preset stations

- To call out out preset stations from the remote control unit.

**1**  Watching the display, press the SHIFT button to select the preset memory block.

(Remote control unit)

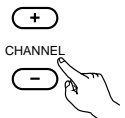
**2**  Watching the display, press the CHANNEL + (UP) or - (DOWN) button to select the desired preset channel.

(Remote control unit)

- Calling out preset stations from the main unit's panel.

**1**  Press the TUNING PRESET button.

(Main unit)

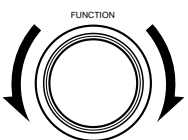
**2**  Turn the FUNCTION knob and select the desired station.

(Main unit)

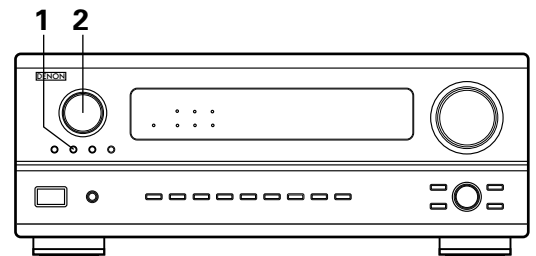
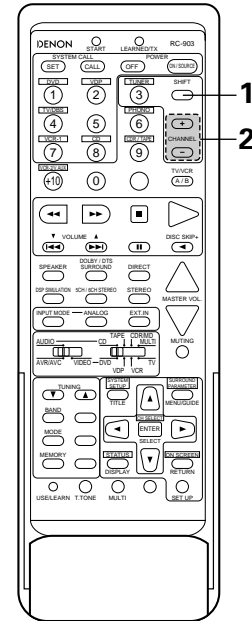

## 13 LAST FUNCTION MEMORY

- This unit is equipped with a last function memory which stores the input and output setting conditions as they were immediately before the power is switched off. This function eliminates the need to perform complicated resettings when the power is switched on.
- The unit is also equipped with a back-up memory. This function provides approximately one week of memory storage when the main unit's power switch is off and with the power cord disconnected.

## 14 INITIALIZATION OF THE MICROPROCESSOR

When the indication of the display is not normal or when the operation of the unit does not shows the reasonable result, the initialization of the microprocessor is required by the following procedure.

**1** Switch off the unit and remove the AC cord from the wall outlet.

**2** Hold the following A button and B button, and plug the AC cord into the outlet.

**3** Check that the entire display is flashing with an interval of about 1 second, and release your fingers from the 2 buttons and the microprocessor will be initialized.

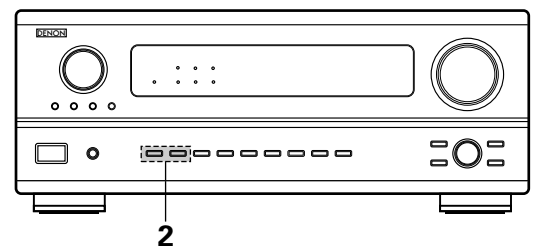

### NOTES:

- If step 3 does not work, start over from step 1.
- If the microprocessor has been reset, all the button settings are reset to the default values (the values set upon shipment from the factory).

# 15 TROUBLESHOOTING

If a problem should arise, first check the following.

1. Are the connections correct ?
2. Have you operated the receiver according to the Operating Instructions ?
3. Are the speakers, turntable and other components operating properly ?

If this unit is not operating properly, check the items listed in the table below. Should the problem persist, there may be a malfunction. Disconnect the power immediately and contact your store of purchase.

	Symptom	Cause	Measures	Page
Common problems when listening to the CD, records, tapes and FM broadcasts, etc.	DISPLAY not lit and sound not produced when power switch set to on.	<ul style="list-style-type: none"> <li>Power cord not plugged in securely.</li> </ul>	<ul style="list-style-type: none"> <li>Check the insertion of the power cord plug.</li> <li>Turn the power on with the remote control unit after turning the POWER switch on.</li> </ul>	6 35
	DISPLAY lit but sound not produced.	<ul style="list-style-type: none"> <li>Speaker cords not securely connected.</li> <li>Improper position of the audio function button.</li> <li>Volume control set to minimum.</li> <li>MUTING is on.</li> <li>Digital signals not input Digital input selected.</li> </ul>	<ul style="list-style-type: none"> <li>Connect securely.</li> <li>Set to a suitable position.</li> <li>Turn volume up to suitable level.</li> <li>Switch off MUTING.</li> <li>Input digital signals or select input jacks to which digital signals are being input.</li> </ul>	12, 13 36 37 39 36
	DISPLAY not lit and power indicator is flashing rapidly.	<ul style="list-style-type: none"> <li>Speaker terminals are short-circuited.</li> <li>Block the ventilation holes of the set.</li> <li>The unit is operating at continuous high power conditions and/or inadequate ventilation.</li> </ul>	<ul style="list-style-type: none"> <li>Switch power off, connect speakers properly, then switch power back on.</li> <li>Turn off the set's power, then ventilate it well to cool it down. Once the set is cooled down, turn the power back on.</li> <li>Turn off the set's power, then ventilate it well to cool it down. Once the set is cooled down, turn the power back on.</li> </ul>	12, 13 4, 12 4, 12
	Sound produced only from one channel.	<ul style="list-style-type: none"> <li>Incomplete connection of speaker cords.</li> <li>Incomplete connection of input/output cords.</li> </ul>	<ul style="list-style-type: none"> <li>Connect securely.</li> <li>Connect securely.</li> </ul>	12, 13 6 ~ 13
	Positions of instruments reversed during stereo playback.	<ul style="list-style-type: none"> <li>Reverse connections of left and right speakers or left and right input/output cords.</li> </ul>	<ul style="list-style-type: none"> <li>Check left and right connections.</li> </ul>	12, 13
	The on screen display is not displayed.	<ul style="list-style-type: none"> <li>"On screen display" is set to off on the system setup menu screen.</li> </ul>	<ul style="list-style-type: none"> <li>Set "on screen display" on the system setup menu screen to on.</li> </ul>	25
When playing records	Humming noise produced when record is playing.	<ul style="list-style-type: none"> <li>Ground wire of turntable not connected properly.</li> <li>Incomplete PHONO jack connection.</li> <li>TV or radio transmission antenna nearby.</li> </ul>	<ul style="list-style-type: none"> <li>Connect securely.</li> <li>Connect securely.</li> <li>Contact your store of purchase.</li> </ul>	6 6 —
	Howling noise produced when volume is high.	<ul style="list-style-type: none"> <li>Turntable and speaker systems too close together.</li> <li>Floor is unstable and vibrates easily.</li> </ul>	<ul style="list-style-type: none"> <li>Separate as much as possible.</li> <li>Use cushions to absorb speaker vibrations transmitted by floor. If turntable is not equipped with insulators, use audio insulators (commonly available).</li> </ul>	— —
	Sound is distorted.	<ul style="list-style-type: none"> <li>Stylus pressure too weak.</li> <li>Dust or dirt on stylus.</li> <li>Cartridge defective.</li> </ul>	<ul style="list-style-type: none"> <li>Apply proper stylus pressure.</li> <li>Check stylus.</li> <li>Replace cartridge.</li> </ul>	— — —
	Volume is weak.	<ul style="list-style-type: none"> <li>MC cartridge being used.</li> </ul>	<ul style="list-style-type: none"> <li>Replace with MM cartridge or use a head amplifier or step-up transformer.</li> </ul>	6
Remote control unit	This unit does not operate properly when remote control unit is used.	<ul style="list-style-type: none"> <li>Batteries dead.</li> <li>Remote control unit too far from this unit.</li> <li>Obstacle between this unit and remote control unit.</li> <li>Different button is being pressed.</li> <li>⊕ and ⊖ ends of battery inserted in reverse.</li> </ul>	<ul style="list-style-type: none"> <li>Replace with new batteries.</li> <li>Move closer.</li> <li>Remove obstacle.</li> <li>Press the proper button.</li> <li>Insert batteries properly.</li> </ul>	27 27 27 — 27



## 16 ADDITIONAL INFORMATION

### Optimum surround sound for different sources

There are currently various types of multi-channel signals (signals or formats with more than two channels).

#### ■ Types of multi-channel signals

Dolby Digital, Dolby Pro Logic, DTS, high definition 3-1 signals (Japan MUSE Hi-Vision audio), DVD-Audio, SACD (Super Audio CD), MPEG multi-channel audio, etc.

“Source” here does not refer to the type of signal (format) but the recorded content. Sources can be divided into two major categories.

#### ■ Types of sources

##### • Movie audio

Signals created to be played in movie theaters. In general sound is recorded to be played in movie theaters equipped with multiple surround speakers, regardless of the format (Dolby Digital, DTS, etc.).

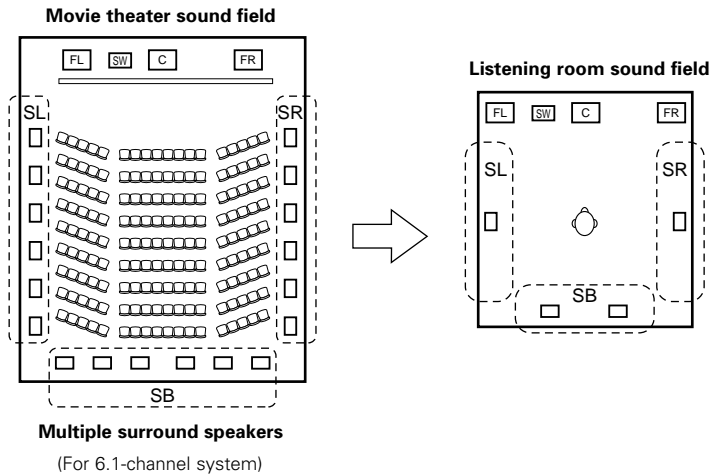

In this case it is important to achieve the same sense of expansion as in a movie theater with the surround channels. To do so, in some cases the number of surround speakers is increased (to four or eight) or speakers with bipolar or dipolar properties are used.

( SL: Surround L channel  
SR: Surround R channel  
SB: Surround back channel (1 spkr or 2 spkrs)

- **Other types of audio** These signals are designed to recreate a 360° sound field using three to five speakers.

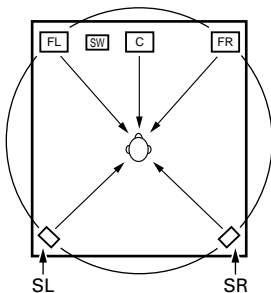

In this case the speakers should surround the listener from all sides to create a uniform sound field from 360°. Ideally the surround speakers should function as “point” sound sources in the same way as the front speakers.

These two types of sources thus have different properties, and different speaker settings, particularly for the surround speakers, are required in order to achieve the ideal sound.

## Surround back speakers

A 6.1-channel system is a conventional 5.1-channel system to which the "surround back" (SB) channel has been added. This makes it easy to achieve sound positioned directly behind the listener, something that was previously difficult with sources designed for conventional multi surround speakers. In addition, the acoustic image extending between the sides and the rear is narrowed, thus greatly improving the expression of the surround signals for sounds moving from the sides to the back and from the front to the point directly behind the listening position.

**Change of positioning and acoustic image with 5.1-channel systems**

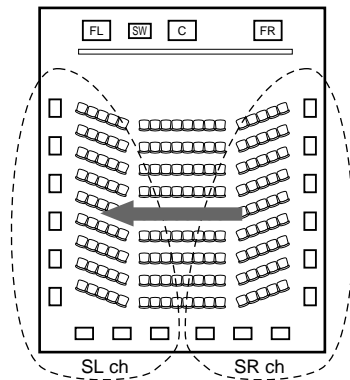

**Movement of acoustic image from SR to SL**

**Change of positioning and acoustic image with 6.1-channel systems**

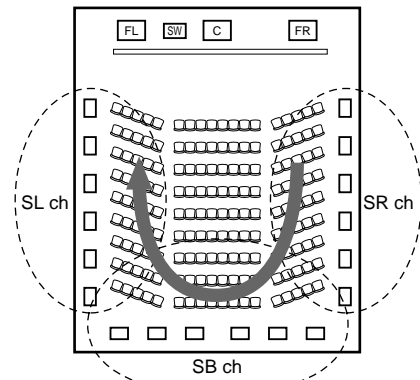

**Movement of acoustic image from SR to SB to SL**

With this set, speaker(s) for 1 or 2 channels are required to achieve a 6.1-channel system (DTS-ES, etc.). Adding these speakers, however, increases the surround effect not only with sources recorded in 6.1 channels but also with conventional 2- to 5.1-channel sources. All the Denon original surround modes (see page 47) are compatible with 7.1-channel playback, so you can enjoy 6.1-channel sound with any signal source.

### ■ Number of surround back speakers

Though the surround back channel only consists of 1 channel of playback signals for 6.1-channel sources (DTS-ES, etc.), we recommend using two speakers. When using speakers with dipolar characteristics in particular, it is essential to use two speakers.

Using two speakers results in a smoother blend with the sound of the surround channels and better sound positioning of the surround back channel when listening from a position other than the center.

### ■ Placement of the surround left and right channels when using surround back speakers

Using surround back speakers greatly improves the positioning of the sound at the rear. Because of this, the surround left and right channels play an important role in achieving a smooth transition of the acoustic image from the front to the back. As shown on the diagram above, in a movie theater the surround signals are also produced from diagonally in front of the listeners, creating an acoustic image as if the sound were floating in space.

To achieve these effects, we recommend placing the speakers for the surround left and right channels slightly more towards the front than with conventional surround systems. Doing so sometimes increases the surround effect when playing conventional 5.1-channel sources in the 6.1 surround or DTS-ES Matrix 6.1 mode. Check the surround effects of the various modes before selecting the surround mode.

## Speaker setting examples

Here we describe a number of speaker settings for different purposes. Use these examples as guides to set up your system according to the type of speakers used and the main usage purpose.

### 1. DTS-ES compatible system (using surround back speakers)

#### (1) Basic setting for primarily watching movies

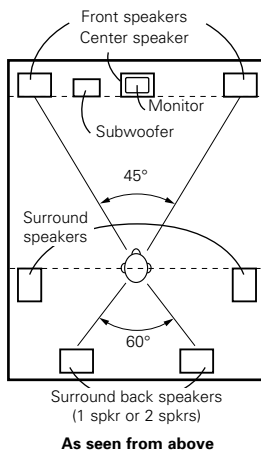

- Set the front speakers with their front surfaces as flush with the TV or monitor screen as possible. Set the center speaker between the front left and right speakers and no further from the listening position than the front speakers.
- Consult the owner's manual for your subwoofer for advice on placing the subwoofer within the listening room.
- If the surround speakers are direct-radiating (monopolar) then place them slightly behind and at an angle to the listening position and parallel to the walls at a position 60 to 90 centimeters (2 to 3 feet) above ear level at the prime listening position.
- When using two surround back speakers, place them at the back facing the front at a narrower distance than the front left and right speakers. When using one surround back speaker, place it at the rear center facing the front at a slightly higher position (0 to 20 cm) than the surround speakers.
- We recommend installing the surround back speaker(s) at a slightly downward facing angle. This effectively prevents the surround back channel signals from reflecting off the monitor or screen at the front center, resulting in interference and making the sense of movement from the front to the back less sharp.

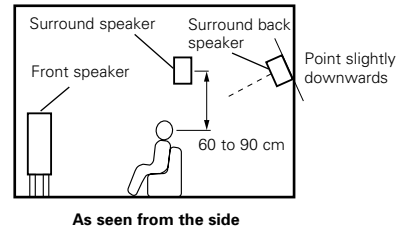

#### (2) Setting for primarily watching movies using diffusion type speakers for the surround speakers

For the greatest sense of surround sound envelopment, diffuse radiation speakers such as bipolar types, or dipolar types, provide a wider dispersion than is possible to obtain from a direct radiating speaker (monopolar). Place these speakers at either side of the prime listening position, mounted above ear level.

##### Path of the surround sound from the speakers to the listening position

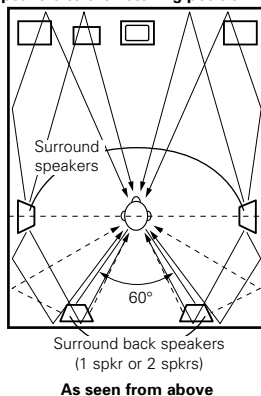

- Set the front speakers, center speaker and subwoofer in the same positions as in example (1).
- It is best to place the surround speakers directly at the side or slightly to the front of the viewing position, and 60 to 90 cm above the ears.
- Same as surround back speaker installation method (1). Using dipolar speakers for the surround back speakers as well is more effective.
- Connect the surround speakers to the surround speaker jacks.
- The signals from the surround channels reflect off the walls as shown on the diagram at the left, creating an enveloping and realistic surround sound presentation.

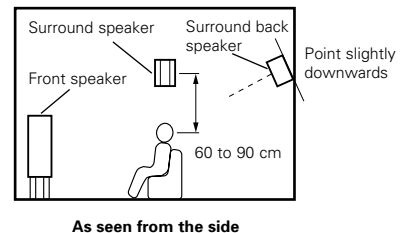

For multi-channel music sources however, the use of bipolar or dipolar speakers mounted at the sides of the listening position may not be satisfactory in order to create a coherent 360 degree surround sound field. Connect another pair of direct radiating speakers as described in example (3) and place them at the rear corners of the room facing towards the prime listening position.

### 2. When not using surround back speakers

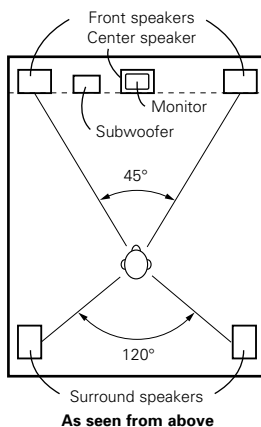

- Set the front speakers with their front surfaces as flush with the TV or monitor screen as possible. Set the center speaker between the front left and right speakers and no further from the listening position than the front speakers.
- Consult the owner's manual for your subwoofer for advice on placing the subwoofer within the listening room.
- If the surround speakers are direct-radiating (monopolar) then place them slightly behind and at an angle to the listening position and parallel to the walls at a position 60 to 90 centimeters (2 to 3 feet) above ear level at the prime listening position.

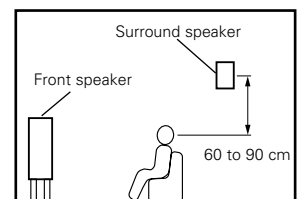

## Surround

The AVR-2802/982 is equipped with a digital signal processing circuit that lets you play program sources in the surround mode to achieve the same sense of presence as in a movie theater.

### Dolby Surround

#### (1) Dolby Digital (Dolby Surround AC-3)

Dolby Digital is the multi-channel digital signal format developed by Dolby Laboratories.

Dolby Digital consists of up to "5.1" channels - front left, front right, center, surround left, surround right, and an additional channel exclusively reserved for additional deep bass sound effects (the Low Frequency Effects – LFE – channel, also called the ".1" channel, containing bass frequencies of up to 120 Hz).

Unlike the analog Dolby Pro Logic format, Dolby Digital's main channels can all contain full range sound information, from the lowest bass, up to the highest frequencies – 22 kHz. The signals within each channel are distinct from the others, allowing pinpoint sound imaging, and Dolby Digital offers tremendous dynamic range from the most powerful sound effects to the quietest, softest sounds, free from noise and distortion.

#### ■ Dolby Digital and Dolby Pro Logic

Comparison of home surround systems	Dolby Digital	Dolby Pro Logic
No. recorded channels (elements)	5.1 ch	2 ch
No. playback channels	5.1 ch	4 ch
Playback channels (max.)	L, R, C, SL, SR, SW	L, R, C, S (SW - recommended)
Audio processing	Digital discrete processing Dolby Digital (AC-3) encoding/decoding	Analog matrix processing Dolby Surround
High frequency playback limit of surround channel	20 kHz	7 kHz

#### ■ Dolby Digital compatible media and playback methods

Marks indicating Dolby Digital compatibility:  and .

The following are general examples. Also refer to the player's operating instructions.

Media	Dolby Digital output jacks	Playback method (reference page)
LD (VDP)	Coaxial Dolby Digital RF output jack ※1	Set the input mode to "AUTO". (Page 36)
DVD	Optical or coaxial digital output (same as for PCM) ※2	Set the input mode to "AUTO". (Page 36)
Others (satellite broadcasts, CATV, etc.)	Optical or coaxial digital output (same as for PCM)	Set the input mode to "AUTO". (Page 36)

※1 Please use a commercially available adapter when connecting the Dolby Digital RF (AC-3RF) output jack of the LD player to the digital input jack.

Please refer to the instruction manual of the adapter when making connection.

※2 Some DVD digital outputs have the function of switching the Dolby Digital signal output method between "bit stream" and "(convert to) PCM". When playing in Dolby Digital surround on the AVR-2802/982, switch the DVD player's output mode to "bit stream". In some cases players are equipped with both "bit stream + PCM" and "PCM only" digital outputs. In this case connect the "bit stream + PCM" jacks to the AVR-2802/982.

#### (2) Dolby Pro Logic II

- Dolby Pro-Logic II is a new multi-channel playback format developed by Dolby Laboratories using feedback logic steering technology and offering improvements over conventional Dolby Pro Logic circuits.
- Dolby Pro Logic II can be used to decode not only sources recorded in Dolby Surround (※) but also regular stereo sources into five channels (front left, front right, center, surround left and surround right) to achieve surround sound.
- Whereas with conventional Dolby Pro Logic the surround channel playback frequency band was limited, Dolby Pro Logic II offers a wider band range (20 Hz to 20 kHz or greater). In addition, the surround channels were monaural (the surround left and right channels were the same) with previous Dolby Pro Logic, but Dolby Pro Logic II they are played as stereo signals.
- Various parameters can be set according to the type of source and the contents, so it is possible to achieve optimum decoding (see page 43).

※ Sources recorded in Dolby Surround

These are sources in which three or more channels of surround have been recorded as two channels of signals using Dolby Surround encoding technology.

Dolby Surround is used for the sound tracks of movies recorded on DVDs, LDs and video cassettes to be played on stereo VCRs, as well as for the stereo broadcast signals of FM radio, TV, satellite broadcasts and cable TV.

Decoding these signals with Dolby Pro Logic makes it possible to achieve multi-channel surround playback. The signals can also be played on ordinary stereo equipment, in which case they provide normal stereo sound.

There are two types of DVD Dolby surround recording signals.

- ① 2-channel PCM stereo signals
- ② 2-channel Dolby Digital signals

When either of these signals is input to the AVR-2802/982, the surround mode is automatically set to Dolby Pro Logic II when the "DOLBY/DTS SURROUND" mode is selected.

■ **Sources recorded in Dolby Surround are indicated with the logo mark shown below.**

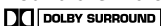
Dolby Surround support mark: 

Manufactured under license from Dolby Laboratories.

"Dolby", "Pro Logic" and the double-D symbol are trademarks of Dolby Laboratories.

Confidential Unpublished Works, ©1992-1999 Dolby Laboratories. All rights reserved.

## DTS Digital Surround

Digital Theater Surround (also called simply DTS) is a multi-channel digital signal format developed by Digital Theater Systems.



DTS offers the same "5.1" playback channels as Dolby Digital (front left, front right and center, surround left and surround right) as well as the stereo 2-channel mode. The signals for the different channels are fully independent, eliminating the risk of deterioration of sound quality due to interference between signals, crosstalk, etc.

DTS features a relatively higher bit rate as compared to Dolby Digital (1234 kbps for CDs and LDs, 1536 kbps for DVDs) so it operates with a relatively low compression rate. Because of this the amount of data is great, and when DTS playback is used in movie theaters, a separate CD-ROM synchronized with the film is played.

With LDs and DVDs, there is of course no need for an extra disc; the pictures and sound can be recorded simultaneously on the same disc, so the discs can be handled in the same way as discs with other formats.

There are also music CDs recorded in DTS. These CDs include 5.1-channel surround signals (compared to two channels on current CDs). They do not include picture data, but they offer surround playback on CD players that are equipped with digital outputs (PCM type digital output required). DTS surround track playback offers the same intricate, grand sound as in a movie theater, right in your own listening room.

■ **DTS compatible media and playback methods**

Marks indicating DTS compatibility:  and .

The following are general examples. Also refer to the player's operating instructions.

Media	Dolby Digital output jacks	Playback method (reference page)
CD	Optical or coaxial digital output (same as for PCM) ※2	Set the input mode to "AUTO" or "DTS" (page 36). Never set the mode to "ANALOG" or "PCM". ※1
LD (VDP)	Optical or coaxial digital output (same as for PCM) ※2	Set the input mode to "AUTO" or "DTS" (page 36). Never set the mode to "ANALOG" or "PCM". ※1
DVD	Optical or coaxial digital output (same as for PCM) ※3	Set the input mode to "AUTO" or "DTS" (page 36).

- ※1 DTS signals are recorded in the same way on CDs and LDs as PCM signals. Because of this, the un-decoded DTS signals are output as random "hissy" noise from the CD or LD player's analog outputs. If this noise is played with the amplifier set at a very high volume, it may possibly cause damage to the speakers. To avoid this, be sure to switch the input mode to "AUTO" or "DTS" before playing CDs or LDs recorded in DTS. Also, never switch the input mode to "ANALOG" or "PCM" during playback. The same holds true when playing CDs or LDs on a DVD player or LD/DVD compatible player. For DVDs, the DTS signals are recorded in a special way so this problem does not occur.
- ※2 The signals provided at the digital outputs of a CD or LD player may undergo some sort of internal signal processing (output level adjustment, sampling frequency conversion, etc.). In this case the DTS-encoded signals may be processed erroneously, in which case they cannot be decoded by the AVR-2802/982, or may only produce noise. Before playing DTS signals for the first time, turn down the master volume to a low level, start playing the DTS disc, then check whether the DTS indicator on the AVR-2802/982 (see page 45) lights before turning up the master volume.
- ※3 A DVD player with DTS-compatible digital output is required to play DTS DVDs. A DTS Digital Output logo is featured on the front panel of compatible DVD players. Recent DENON DVD player models feature DTS-compatible digital output – consult the player's owner's manual for information on configuring the digital output for DTS playback of DTS-encoded DVDs.

Manufactured under license from Digital Theater Systems, Inc. US Pat. No. 5,451,942, 5,956,674, 5,974,380, 5,978,762 and other world-wide patents issued and pending.

"DTS", "DTS-ES Extended Surround" and "Neo:6" are trademarks of Digital Theater Systems, Inc. ©1996, 2000 Digital Theater Systems, Inc. All Rights Reserved.

## DTS-ES Extended Surround™

DTS-ES Extended Surround is a new multi-channel digital signal format developed by Digital Theater Systems Inc. While offering high compatibility with the conventional DTS Digital Surround format, DTS-ES Extended Surround greatly improves the 360-degree surround impression and space expression thanks to further expanded surround signals. This format has been used professionally in movie theaters since 1999.

In addition to the 5.1 surround channels (FL, FR, C, SL, SR and LFE), DTS-ES Extended Surround also offers the SB (Surround Back, sometimes also referred to as "surround center") channel for surround playback with a total of 6.1 channels. DTS-ES Extended Surround includes two signal formats with different surround signal recording methods, as described below.

### ■ DTS-ES™ Discrete 6.1

DTS-ES Discrete 6.1 is the newest recording format. With it, all 6.1 channels (including the SB channel) are recorded independently using a digital discrete system. The main feature of this format is that because the SL, SR and SB channels are fully independent, the sound can be designed with total freedom and it is possible to achieve a sense that the acoustic images are moving about freely among the background sounds surrounding the listener from 360 degrees.

Though maximum performance is achieved when sound tracks recorded with this system are played using a DTS-ES decoder, when played with a conventional DTS decoder the SB channel signals are automatically down-mixed to the SL and SR channels, so none of the signal components are lost.

### ■ DTS-ES™ Matrix 6.1

With this format, the additional SB channel signals undergo matrix encoding and are input to the SL and SR channels beforehand. Upon playback they are decoded to the SL, SR and SB channels. The performance of the encoder used at the time of recording can be fully matched using a high precision digital matrix decoder developed by DTS, thereby achieving surround sound more faithful to the producer's sound design aims than with conventional 5.1- or 6.1-channel systems.

In addition, the bit stream format is 100% compatible with conventional DTS signals, so the effect of the Matrix 6.1 format can be achieved even with 5.1-channel signal sources. Of course it is also possible to play DTS-ES Matrix 6.1 encoded sources with a DTS 5.1-channel decoder.

When DTS-ES Discrete 6.1 or Matrix 6.1 encoded sources are decoded with a DTS-ES decoder, the format is automatically detected upon decoding and the optimum playing mode is selected. However, some Matrix 6.1 sources may be detected as having a 5.1-channel format, so the DTS-ES Matrix 6.1 mode must be set manually to play these sources.

(For instructions on selecting the surround mode, see page 45.)

The DTS-ES decoder includes another function, the DTS Neo:6 surround mode for 6.1-channel playback of digital PCM and analog signal sources.

### ■ DTS Neo:6™ surround

This mode applies conventional 2-channel signals to the high precision digital matrix decoder used for DTS-ES Matrix 6.1 to achieve 6.1-channel surround playback. High precision input signal detection and matrix processing enable full band reproduction (frequency response of 20 Hz to 20 kHz or greater) for all 6.1 channels, and separation between the different channels is improved to the same level as that of a digital discrete system.

DTS Neo:6 surround includes two modes for selecting the optimum decoding for the signal source.

#### • DTS Neo:6 Cinema

This mode is optimum for playing movies. Decoding is performed with emphasis on separation performance to achieve the same atmosphere with 2-channel sources as with 6.1-channel sources.

This mode is effective for playing sources recorded in conventional surround formats as well, because the in-phase component is assigned mainly to the center channel (C) and the reversed phase component to the surround (SL, SR and SB channels).

#### • DTS Neo:6 Music

This mode is suited mainly for playing music. The front channel (FL and FR) signals bypass the decoder and are played directly so there is no loss of sound quality, and the effect of the surround signals output from the center (C) and surround (SL, SR and SB) channels add a natural sense of expansion to the sound field.

## System setup items and default values (set upon shipment from the factory)

System setup			Default settings									
①	Speaker Configuration	Input the combination of speakers in your system and their corresponding sizes (SMALL for regular speakers, LARGE for full-size, full-range) to automatically set the composition of the signals output from the speakers and the frequency response.	Front Sp.	Center Sp.	Sub Woofer	Surround Sp.	Surround Back Sp.					
	Crossover Frequency	Set the frequency (Hz) below which the bass sound of the various speakers is to be output from the subwoofer.	80 Hz									
	Subwoofer mode	This selects the subwoofer speaker for playing deep bass signals.	LFE									
②	SB CH Auto Flag Detect	Set the method of playing the surround back channel for digital signals.	DTS-ES / 6.1 Source Auto Flag Detect Mode = OFF									
③	Delay Time	This parameter is for optimizing the timing with which the audio signals are produced from the speakers and subwoofer according to the listening position.	Front L & R	Center	Sub Woofer	Surround L & R	Surround Back					
			12 ft (3.6 m)	12 ft (3.6 m)	12 ft (3.6 m)	10 ft (3.0 m)	10 ft (3.0 m)					
④	Channel Level	This adjusts the volume of the signals output from the speakers and subwoofer for the different channels in order to obtain optimum effects.	Front L	Front R	Center	Subwoofer	Surround L	Surround R	Surround Back			
			0 dB	0 dB	0 dB	0 dB	0 dB	0 dB	0 dB			
⑤	Digital In Assignment	This assigns the digital input jacks for the different input sources.	Input source	CD	DVD	TV/DBS	CDR/TAPE	VDP	VCR-1	VCR-2	—	—
			Digital Inputs	COAXIAL	OPTICAL 1	OPTICAL 2	OPTICAL 3	OFF	OFF	OFF	—	—
⑥	On Screen Display	This sets whether or not to display the on-screen display that appears on the monitor screen when the controls on the remote control unit or main unit are operated.	On Screen Display = ON									
⑦	Auto Tuner Presets	FM stations are received automatically and stored in the memory.	A1 ~ A8	87.5/89.1/98.1/107.9/90.1/90.1/90.1/90.1 MHz								
			B1 ~ B8	520/600/1000/1400/1500/1710 kHz, 90.1/90.1 MHz								
			C1 ~ C8	90.1 MHz								
			D1 ~ D8	90.1 MHz								
			E1 ~ E8	90.1 MHz								

## Surround modes and parameters

Mode	Channel output					When playing Dolby Digital signals	When playing DTS signals	When playing PCM signals	When playing ANALOG signals
	FRONT L/R	CENTER	SURROUND L/R	SUB-WOOFER	SURROUND BACK L/R				
DIRECT	○	×	×	⊗	×	○	○	○	○
STEREO	○	×	×	⊗	×	○	○	○	○
EXTERNAL INPUT	○	⊗	⊗	⊗	⊗	×	×	×	○
DOLBY PRO LOGIC II	○	⊗	⊗	⊗	⊗	○ *	×	○	○
DTS NEO:6	○	⊗	⊗	⊗	⊗	×	×	○	○
DOLBY DIGITAL (6.1 SURROUND)	○	⊗	⊗	⊗	⊗	○	×	×	×
DTS SURROUND (DTS ES MTRX 6.1)	○	⊗	⊗	⊗	⊗	×	○	×	×
5/6CH STEREO	○	⊗	⊗	⊗	⊗	×	×	○	○
ROCK ARENA	○	⊗	⊗	⊗	⊗	×	×	○	○
JAZZ CLUB	○	⊗	⊗	⊗	⊗	×	×	○	○
VIDEO GAME	○	⊗	⊗	⊗	⊗	×	×	○	○
MONO MOVIE	○	⊗	⊗	⊗	⊗	×	×	○	○
MATRIX	○	⊗	⊗	⊗	⊗	×	×	○	○

\* Only for 2 ch contents.

○ : Signal  
 × : No signal  
 ⊗ : Turned on or off by speaker configuration setting

○ : Able  
 × : Unable

Mode	Parameter (default values are shown in parentheses)														
	SURROUND PARAMETER										PRO LOGIC II MUSIC MODE ONLY			When playing Dolby Digital/DTS signals	
	TO NE CONTROL	MODE	CINEMA EQ.	EFFECT	LEVEL	ROOM SIZE	EFFECT LEVEL	DELAY TIME	SURROUND BACK	PANORAMA	DIMENSION	CENTER WIDTH	D. COMP	LFE	
DIRECT	×	×	×	×	×	×	×	×	×	×	×	×	○ (OFF)	○ (0dB)	
STEREO	○ (0dB)	×	×	×	×	×	×	×	×	×	×	×	○ (OFF)	○ (0dB)	
EXTERNAL INPUT	○ (0dB)	×	×	×	×	×	×	×	×	×	×	×	×	×	
DOLBY PRO LOGIC II	○ (0dB)	○ (CINEMA)	○ (OFF)	×	×	×	×	×	○ (NON MTRX)	○ (OFF)	○ (3)	○ (0)	○ (OFF)	○ (0dB)	
DTS NEO:6	○ (0dB)	○ (CINEMA)	○ (OFF)	×	×	×	×	×	○ (NON MTRX)	×	×	×	×	×	
DOLBY DIGITAL (6.1 SURROUND)	○ (0dB)	×	○ (OFF)	×	×	×	×	×	○ (MTRX ON)	×	×	×	○ (OFF)	○ (0dB)	
DTS SURROUND (DTS ES MTRX 6.1)	○ (0dB)	×	○ (OFF)	×	×	×	×	×	○ (MTRX ON)	×	×	×	×	○ (0dB)	
5/6CH STEREO	○ (0dB)	×	×	×	×	×	×	×	○	×	×	×	×	×	
ROCK ARENA	○ (0dB)	×	×	×	×	○ (Medium)	○ (10)	×	○	×	×	×	×	×	
JAZZ CLUB	○ (0dB)	×	×	×	×	○ (Medium)	○ (10)	×	○	×	×	×	×	×	
VIDEO GAME	○ (0dB)	×	×	×	×	○ (Medium)	○ (10)	×	○	×	×	×	×	×	
MONO MOVIE	○ (0dB)	×	×	×	×	○ (Medium)	○ (10)	×	○	×	×	×	×	×	
MATRIX	○ (0dB)	×	×	×	×	×	×	○ (30msec)	○	×	×	×	×	×	

○ : Adjustable  
 × : Not adjustable



## 17 SPECIFICATIONS

<ul style="list-style-type: none"> <li>■ <b>Audio section</b></li> <li>• <b>Power amplifier</b></li> </ul>		
Rated output:	Front:	90 W + 90 W (8 Ω/ohms, 20 Hz ~ 20 kHz with 0.05% T.H.D.) 135 W + 135 W (6 Ω/ohms, 1 kHz with 0.7% T.H.D.)
	Center:	90 W (8 Ω/ohms, 20 Hz ~ 20 kHz with 0.05% T.H.D.) 135 W (6 Ω/ohms, 1 kHz with 0.7% T.H.D.)
	Surround:	90 W + 90 W (8 Ω/ohms, 20 Hz ~ 20 kHz with 0.05% T.H.D.) 135 W + 135 W (6 Ω/ohms, 1 kHz with 0.7% T.H.D.)
	Surround Back:	90 W (8 Ω/ohms, 20 Hz ~ 20 kHz with 0.05% T.H.D.) 135 W (6 Ω/ohms, 1 kHz with 0.7% T.H.D.)
Dynamic power:	120 W x 2 ch	(8 Ω/ohms)
	170 W x 2 ch	(4 Ω/ohms)
	200 W x 2 ch	(2 Ω/ohms)
Output terminals:	Front:	A or B 6 ~ 16 Ω/ohms A + B 8 ~ 16 Ω/ohms
	Center, Surround, Surr. Back:	6 ~ 16 Ω/ohms
<ul style="list-style-type: none"> <li>• <b>Analog</b></li> </ul>		
Input sensitivity / input impedance:	200 mV / 47 kΩ/kohms	
Frequency response:	10 Hz ~ 100 kHz: +0, -3 dB (DIRECT mode)	
S/N:	102 dB (DIRECT mode)	
Distortion:	0.005% (20 Hz ~ 20 kHz) (DIRECT mode)	
Rated output:	1.2 V	
<ul style="list-style-type: none"> <li>• <b>Digital</b></li> </ul>		
D/A output:	Rated output — 2 V (at 0 dB playback) Total harmonic distortion — 0.008% (1 kHz, at 0 dB) S/N ratio — 102 dB Dynamic range — 96 dB Format — Digital audio interface	
<ul style="list-style-type: none"> <li>• <b>Digital input:</b></li> </ul>		
<ul style="list-style-type: none"> <li>• <b>Phono equalizer (PHONO input — REC OUT)</b></li> </ul>		
Input sensitivity:	2.5 mV	
RIAA deviation:	±1 dB (20 Hz to 20 kHz)	
Signal-to-noise ratio:	74 dB (A weighting, with 5 mV input)	
Rated output / Maximum output:	150 mV / 7 V	
Distortion factor:	0.03% (1 kHz, 3 V)	
<ul style="list-style-type: none"> <li>■ <b>Video section</b></li> </ul>		
<ul style="list-style-type: none"> <li>• <b>Standard video jacks</b></li> </ul>		
Input / output level and impedance:	1 Vp-p, 75 Ω/ohms	
Frequency response:	5 Hz ~ 10 MHz — +0, -3 dB	
<ul style="list-style-type: none"> <li>• <b>S-video jacks</b></li> </ul>		
Input / output level and impedance:	Y (brightness) signal — 1 Vp-p, 75 Ω/ohms C (color) signal — 0.286 Vp-p, 75 Ω/ohms	
Frequency response:	5 Hz ~ 10 MHz — +0, -3 dB	
<ul style="list-style-type: none"> <li>• <b>Color component video jacks</b></li> </ul>		
Input / output level and impedance:	Y (brightness) signal — 1 Vp-p, 75 Ω/ohms P <sub>B</sub> /C <sub>B</sub> (blue) signal — 0.7 Vp-p, 75 Ω/ohms P <sub>R</sub> /C <sub>R</sub> (red) signal — 0.7 Vp-p, 75 Ω/ohms	
Frequency response:	5 Hz ~ 27 MHz — +0, -3 dB	
<ul style="list-style-type: none"> <li>■ <b>Tuner section</b></li> </ul>		
Receiving Range:	[FM] (note: μV at 75 Ω/ohms, 0 dBf=1 x 10 <sup>-16</sup> W)	[AM] 520 kHz ~ 1710 kHz
Usable Sensitivity:	87.50 MHz ~ 107.90 MHz	18 μV
50 dB Quieting Sensitivity:	1.0 μV (11.2 dBf)	
	MONO 1.6 μV (15.3 dBf)	
	STEREO 23 μV (38.5 dBf)	
S/N (IHF-A):	MONO 77 dB	
	STEREO 72 dB	
Total Harmonic Distortion (at 1 kHz):	MONO 0.15%	
	STEREO 0.3%	
<ul style="list-style-type: none"> <li>■ <b>General</b></li> </ul>		
Power supply:	AC 120 V, 60 Hz	
Power consumption:	5.0 A 2 W Max (Standby)	
Maximum external dimensions:	434 (W) x 171 (H) x 416 (D) mm (17-3/32" x 6-11/32" x 16-3/8")	
Weight:	11.5 kg (25 lbs 6 oz)	
<ul style="list-style-type: none"> <li>■ <b>Remote control unit (RC-903)</b></li> </ul>		
Batteries:	R6P/AA Type (three batteries)	
External dimensions:	70 (W) x 215 (H) x 24 (D) mm (2-3/4" x 8-15/32" x 15/16")	
Weight:	200 g (Approx. 7 oz) (including batteries)	

\* For purposes of improvement, specifications and design are subject to change without notice.

**NIPPON COLUMBIA CO., LTD.**

14-14, AKASAKA 4-CHOME, MINATO-KU, TOKYO 107-8011, JAPAN  
Telephone: (03) 3584-8111

Printed in Japan 511 3799 009

## DENON SERVICE NETWORK/ 服務網絡

- Please contact one of our overseas service centers, listed below, for follow-up service consultation.
- Wenden Sie sich für anfallende Wartungs- bzw. Reparaturarbeiten bitte an eine der folgend aufgeführten Kundendienststellen.
- Adressez-vous à nos centres de service d'outre-mer indiqués ci-dessous, pour le service après-vente.
- Per il servizio dopo vendita rivolgete Vi al nostro centro di servizio estero appropriato della lista seguente.
- Para consultas de servicio por favor dirigirse a cualquiera de nuestros centros de servicio en el extranjero, enlistados abajo.
- Neem kontakt op met één van onze reparatie-inrichtingen in het buitenland, waarvan hier een lijst volgt, voor na-service.
- Ta kontakt med nedan angivna servicecentraler för rådfrågning om servicearbeten efter försäljningen.
- Favor contactar um de nossos centros de serviços internacionais, abaixo listados, para consulta de serviços de acompanhamento.
- 請據下表所列本公司海外服務中心查詢售後服務事宜。

<b>Australia</b>	Audio Products Australia Pty Ltd. 67 O'Riordan Street, Alexandria NSW 2015, Australia Tel: (02) 9669-3477 Fax: (02) 9578-0140
<b>Austria</b>	Digital-Professional-Audio Vertriebsges.m.b.H., 1170 Wien, Rupertusplatz 3 Tel: 0222-4501006~9, Fax: 0222-457679
<b>Belgium</b>	Transtel-Sabima P.V.B.A. Harmoniestraat 13, 2018 Antwerpen 1, België Tel: 03-237-3607
<b>Canada</b>	Denon Canada Inc. 17 Denison Street, Markham Ontario, Canada L3R 1B5 Tel: 905-475-4085 Fax: 905-475-4159
<b>China</b>	中國遠望機電技術發展中心 (北京天龍特約維修中心) 北京東直門內大街92號 郵編: 100007 電話: (10) 64015151/64023798 傳真: (10) 64034229 天龍音響上海特約技術維修服務中心 上海金沙江路253號 郵編: 200062 電話: 86-21-6257-9958 傳真: 86-21-6260-5645
<b>Czecho</b>	EUROSTAR OSTORAVA s.r.o. areal Vodni stavby Praha a.s., budova A2 Dobronicka 635,148 00 Praha 4 Czech Rep. Tel: 02-611142901 Fax: 02-6111-2904
<b>Denmark</b>	Hifi Klubben A/S Dali Alle 1, 96110 Noerager, Denmark Tel: 45-96 72 10 00 Fax: 45-96 72 10 14
<b>Finland</b>	Suomen Hi-Fi Klubi OY Nylandsgatan 4-6, Helsingfors Tel: 0644401
<b>France</b>	Denon France S.A. 3 Boulevard Ney, 75018 Paris Tel: 44-89-68-69
<b>F.R. Germany</b>	Denon Electronic GmbH An der Landwehr 19, 41334 Nettetal Tel: +49 2157 12 08 78 Fax: +49 2157 12 08 13
<b>Greece</b>	KINOTECHNIKI LTD. 14, PYRGOU STR. 166 75, GLYFADA ATHENS Tel: (01)960-1071 Fax: (01)960-1072
<b>Hong Kong</b>	DENON ASIA COMPANY LTD. 18/F No.79 Chatham Road South, Tsimshatsui Kowloon, Hong Kong Tel: 852-2516-6862, Fax: 852-2516-5940 天龍音響(亞洲)有限公司 香港九龍尖沙咀漆咸道南七十九號十八樓 電話: 852-2516-6862 傳真: 852-2516-5940
<b>Hungary</b>	InfoVox Ltd. Terez krt. 31, 1067 Budapest Hungary Tel / Fax: 01-302-2515
<b>Iceland</b>	Japis Ltd. Brautarholt 2, P.O.Box 396, 121 Reykjavik, Iceland Tel: 354-58009-800 Fax: 354-5800-888
<b>Israel</b>	Newpan Ltd. 14 Rosansky st. Rishon Lezion 75706. Tel: 03-9535900 Fax: 03-9616193
<b>Indonesia</b>	PT Autoaccindo Jaya. Cideng Barat No. 7 Jakarta, Indonesia Tel: 633-2730
<b>Italy</b>	Audiodelta S.r.l.19 Via Pietro Calvi 20129 Milan Italy Tel: 39-02-5411-6008 / 39-02-5412-8253 Fax: 39-02-5518-1961
<b>Korea</b>	SAM WON KOREA Co., Ltd. 1F, SANG-ROCK BLDG, #1629-3 SEOCHO-DONG, SEOCHO-KU, SEOUL 137-070, KOREA Tel: 02-521-1404 Fax: 02-3486-2135
<b>Malaysia</b>	HWEE SENG (ELECTRONICS) SDN BHD. 13-1, Jalan Raja Laut, 50350 Kuala Lumpur Malaysia Tel: 60-3-4041-8422 Fax: 60-3-4041-0563
<b>Mexico</b>	Labrador, S.A. de C.V. Zamora No. 154 Col. Condesa 06140 Mexico, D.F. Tel: 286 55 09 Fax: 286 34 62
<b>Netherlands</b>	Penhold B.V. Poppenbouwing 58, NL-4191 NZ Geldermalsen, Netherland Tel: 31-345-588 080 Fax: 31-345-588 085
<b>New Zealand</b>	Avalon Audio Corpn. Limited 630B Great South Road Ellerslie Auckland, New Zealand Tel: 64-9-579-1280 Fax: 64-9-579-3350
<b>Norway</b>	Hi-Fi Klubben AS Sandakerveien 64 0483 Oslo Tel: 47 22 79 66 66 Fax: 47 22 79 66 67
<b>Poland</b>	HORN DISTRIBUTION S.A. Ulica Kurantow 34, 02-873 Warszawa Poland Tel: +48 22 649 30 71 Fax: +48 22 649 31 99
<b>Portugal</b>	Videoacustica Qta. Do Paizinho-Armazém 5-Estrada De Circunvalação-Apart. 3127 1303 Lisboa Codex Tel: (01)417-00-04/00-96 Fax: (01)418-80-93
<b>Singapore</b>	Hwee Seng (Electronics) Pte Ltd. 81 Genting Lane #02-02, Everich Industrial Building Singapore 349566 Tel: 65-746-3355 Fax: 65-743-1704
<b>South Africa</b>	Mandarin Distributors S.A. 10 Thora Crescent, Wynberg Ext.3 Sandton, P.O.Box 5137, Johannesburg Republic of South Africa Tel: 27-11-444-8445 Fax: 27-11-444-8363
<b>Spain</b>	Gaplasa S.A.AV. Ing. Conde de Torroja, 25, 28022 Madrid Tel: 91-329-29-60 Fax: 91-329-16-75
<b>Sweden</b>	Sveriges Hi-Fi Klubb Box 5116, S-402 23 Göteborg Tel: 031-200040
<b>Switzerland</b>	Diethelm & Co., AG. Grindelstrasse 5, 8303 Bassersdorf Tel: 01-306-1611 Fax: 01-306-1690
<b>Taiwan R.O.C.</b>	KOLIN-DENON ENTERTAINEMENTY INC. 5th FL.,NO.63, Po-Ai Road, Taipei, Taiwan, R.O.C. Tel: (02)2381-5876 Fax: (02)2381-5811
<b>進口廠商</b>	歌林天龍音樂事業股份有限公司 台北市博愛市路63號10樓 電話: (02)2381-5876 傳真: (02)2381-5811
<b>Thailand</b>	Mahajak Development Co., Ltd. 46 Mahajak Building, Sukhumvit Soi 3 (Nana-Nua) Klongtoey, Bangkok Thailand. 10110 Tel: 66-2-256-0020 Fax: 66-2-253-1696
<b>United Kingdom &amp; Eire</b>	Hayden Laboratories Ltd. Hayden House, Chiltern Hill, Chalfont St Peter, Gerrards Cross, Bucks, SL9 9UG Tel: 01753-888447 Fax: 01753-880109
<b>U.S.A.</b>	DENON ELECTRONICS, a Division of Denon Corporation (U.S.A.) 19 Chapin Road, Pine Brook, NJ 07058-9777 Tel: 973-396-7499, Fax: 888-544-8434

- \* If there is no service center in your local area, consult the outlet where the equipment was purchased.
- \* Falls sich in Ihrer Nähe keine Kundendienststelle befindet, wenden Sie sich an das Geschäft, wo das Gerät gekauft wurde.
- \* S'il n'y a aucun centre de service dans votre région, consultez votre revendeur.
- \* Se nella Vostra zona non c'è il centro di servizio, rivolgete Vi al negozio dove avete acquistato l'apparecchio.
- \* Si no hay centros de servicio en su área local, consulte en donde haya comprado su equipo.
- \* Als er in uw streek geen reparatie-inrichting is, neemt u contact op met de vestiging waar u de apparatuur gekocht heeft.
- \* Saknas servicecentral i närheten där du bor, bör kontakt tas med återförsäljaren för apparaten.
- \* Se não existir um centro de serviços em sua área local, consulte o estabelecimento onde o equipamento foi adquirido.
- \* 若當地無服務中心, 可向你購入本機的商號查詢。

H01004

## NIPPON COLUMBIA CO., LTD.

14-14, AKASAKA 4-CHOME, MINATO-KU, TOKYO 107-8011, JAPAN

Telephone: (03) 3584-8111

This warranty will be honored only in the U.S.A.

# DENON®

## LIMITED WARRANTY

### Length of Warranty

This warranty on your DENON audio product which is distributed and warranted by DENON ELECTRONICS, a Division of DENON Corporation (U.S.A.) remains in effect for the following periods from the date of the original consumer purchase from an AUTHORIZED DENON ELECTRONICS, a Division of DENON Corporation (U.S.A.) DEALER.

#### Product Category

Turntables	(1) Autolift	(DP-L)	4 years
	(2) Full Automatic	(DP-F)	2 years
Tuners, Integrated Amplifiers		(TU, PMA)	3 years
Preamps, Digital Preamps, Poweramps, Head Amplifiers		(PRA, AVP, DAP, POA, HA)	3 years
Digital Surround Decoder		(AVD)	3 years
A/V Controllers, A/V Receivers, AM/FM Receivers		(AVC, AVR, DRA)	2 years
Compact Disc Players, Laser Disc Players, DVD Players		(DCD, DCM, DP, DA, LA, DVD)	1 year
Tape Recorders, Digital Audio Tape Recorders, Minidisc Recorders		(DRM, DRR, DRS, DRW, DTR, DMD)	1 year
Karaoke Systems		(DCG, HMA)	1 year
Cartridges, Accessories		(DL, AU)	90 days

### What is Covered

Except as specified below, this Warranty covers all defects in material and workmanship in this product. The following are not covered by the Warranty: (1) Any product which is not distributed in the U.S.A. by DENON ELECTRONICS (2) Any product which is not purchased in the U.S.A. from an authorized DENON dealer, unless the product is purchased through the U.S.A. Military Exchange Service where the Warranty will be One (1) year for all products listed above except in the case of Cartridges which will remain at 90 days. (Note: AUTHORIZED DENON DEALERS can be identified by DENON AUTHORIZED DEALER sticker displayed in the stores. If you are uncertain as to whether a dealer is a DENON AUTHORIZED DEALER, please contact DENON as listed below.) (3) Any product on which the serial number has been defaced, modified or removed. (4) Damaged deterioration or malfunction resulting from: a) Accident, act of nature, abuse, misuse, neglect, unauthorized product repair or modification or failure to follow instructions supplied with the product. b) Repair or attempted repair by anyone not authorized by DENON. c) Any shipment of the product (claim must be presented to carrier). (5) Items subject to wear from normal usage (tape heads, cartridges, stylus, battery, etc.). (6) Periodic check-ups which do not disclose any defect. (7) Use of the product outside the U.S.A. (8) Damaged magnetic tape or CD discs. (9) Use in industrial, commercial, and/or professional applications.

### What We Will Pay For

If during the applicable warranty period from date of original consumer purchase your DENON audio product is found to be defective by DENON, DENON will repair, or at its option, replace with new, used or equivalent model, such defective product without charge for parts or labor.

### How to Obtain Warranty Performance

If your unit ever needs service, it may be taken or shipped to any authorized DENON service station or DENON ELECTRONICS (if you are uncertain as to whether a service station is DENON authorized, please contact DENON as listed below.). In all other cases, the following procedures apply whenever your unit must be transported for warranty service;

- a. You are responsible for transporting your unit or arranging for its transportation.
- b. If shipment of your unit is required; You must pay the initial shipping charges, but we will pay the return shipping charges if the repairs are covered by the Warranty.
- c. **WHEN RETURNING YOUR UNIT FOR WARRANTY SERVICE, A COPY OF THE ORIGINAL SALES SLIP MUST BE ATTACHED.**
- d. You should include the following: your name, address, daytime telephone number, model and serial number of the product and a description of the problem. In the case of a Compact Disc Player, please enclose ONE (1) disc that the unit has failed with for test reasons. It will be returned with the unit.

### THIS WARRANTY IS VALID IN THE U.S.A. ONLY.

If your product does not require service, but you have questions regarding its operation, please contact our Technical Services Department as listed below.

**THIS WARRANTY IS EXPRESSLY MADE IN LIEU OF ALL OTHER WARRANTIES, EXPRESSED OR IMPLIED, INCLUDING WITHOUT LIMITATION, WARRANTIES OF MERCHANTABILITY AND FITNESS FOR A PARTICULAR PURPOSE.**

**OUR LIABILITY IS LIMITED TO THE REPAIR OR REPLACEMENT, AT OUR OPTION, OF ANY DEFECTIVE PRODUCT AND SHALL IN NO EVENT INCLUDE INCIDENTAL OR CONSEQUENTIAL COMMERCIAL OR PROPERTY DAMAGES OF ANY KIND.**

**SOME STATES DO NOT ALLOW LIMITATIONS ON HOW LONG AN IMPLIED WARRANTY LASTS AND/OR DO NOT ALLOW THE EXCLUSION OF INCIDENTAL OR CONSEQUENTIAL DAMAGES, SO THE ABOVE LIMITATIONS AND EXCLUSIONS MAY NOT APPLY TO YOU.**

This Warranty gives you specific legal rights, but you may also have other rights which vary from state to state.

# DENON<sup>®</sup> ELECTRONICS, a Division of DENON Corporation (U.S.A.)

Mailing address only: DENON ELECTRONICS,  
P.O. Box 5370  
Parsippany, N.J. 07054-5370

## DENON

### **DENON ELECTRONICS,**

222 New Road  
Parsippany, N.J. 07054  
(973) 396-7499  
(888) 544-8434 FAX

### **DENON ELECTRONICS,**

13825 Cerritos Corporate Dr., Suite B,  
Cerritos, CA 90703-2456  
(562) 565-1730  
(562) 565-1740 FAX

## DENON REGIONAL SUPER SERVICE CENTERS (Repair only — No parts orders please)

### **PYRAMID AUDIO**

8711 Burnett Rd.  
Building F, Suite 65  
Austin, TX. 78758  
(512) 458-8292  
(512) 453-4542 FAX

### **UNITED RADIO**

2949 Erie Boulevard East  
Syracuse, N.Y. 13224  
(315) 446-8700  
(315) 446-8505 FAX

### **AUDIO SERVICES**

544 Central Dr., Suite 101  
Virginia Beach, VA 23454  
(757) 498-8277  
(757) 498-9554 FAX

### **ELECTRO SERVICES**

2144 Columbia Avenue  
Lancaster, PA 17603  
(717) 397-0509  
(717) 397-9565 FAX

### **INNER SOUND**

1818 S.E. Division St.  
Portland, OR 97202  
(503) 238-1955  
(503) 238-1787 FAX

# DENON

*The first name in digital audio.*

## AVR-2802 System Setup Guide & Recommendations

**Be sure all components are properly connected, and that the Speakers are placed and wired correctly to the AVR-2802 (and amplifier if setup for Surround EX/dts ES) before starting the System Setup. (Speaker and Amplifier Hook-up diagrams are attached at the end of this document)**

**Be sure the AVR-2802's Monitor 1 Video Output (S-video or composite) is connected to the appropriate video input on the TV/Monitor/PTV.**

- The AVR-2802's On Screen Display does not function with the Component Video Outputs.

**Access the AVR-2802's System Setup Menu by depressing the System Setup button on the remote (under the flip open door) – Be sure the Main remote switch is in the AVR/AVC position.**

- We suggest doing the System Setup with the menu superimposed over a blank screen; no video image behind the menu will make it easier to read and adjust the settings.
- For maneuvering around the menu, the four directional arrow keys and the "Enter" button are all that are needed. They are directly next to the System Setup button.
- Perform all settings in the order they appear on the screen, do not jump around during the initial setup. To the left of the individual setup items you will see a "Finger Pointer", you can move the "Pointer" using the "Up/Down" arrow keys. To access a particular setting, simply press the "Enter" key.
- When you have completed adjustments in each individual setup item, simply press the "Enter" key, which will take you back to the System Setup Screen, or to a specific sub-menu attached to the setup item you were adjusting, with the "Finger Pointer" ready to enter the next individual setup item.
- All settings performed in the System Setup will automatically be stored into Personal Memory Plus, which has a memory backup should AC power be lost or disconnected.

## SPEAKER CONFIGURATION

- These settings are extremely crucial to the overall sound quality and performance of the AVR-2802. Use the “Left/Right” arrow keys to select size and the “Up/Down” arrow keys to select the speaker channel to adjust.
- Your options for speaker sizes are ‘Large’, ‘Small’, or ‘None’. These settings are not based on the physical size of your speakers, but they do tell the AVR-2802 about the overall frequency response of the speakers you are connecting to it. The overall frequency response of a loudspeaker not only includes its frequency range, but also its ability to accurately handle low frequency information (80 Hz and down) at any volume level.
  - Should there be a subwoofer in the system, Denon recommends that no matter what the physical size of the loudspeakers are, select ‘Small’ for the Fronts, Center, and Surrounds.
  - When ‘Small’ is selected the subwoofer is automatically set to ‘Yes’ (if no subwoofer is in the system do not set the fronts to ‘Small’ as you will get no bass response from your speakers).
  - The ‘Small’ speaker setting, for front, center, or surrounds, allows the one speaker in the system, the subwoofer, to accurately handle the low frequency information. It also allows the AVR-2802’s amplifiers to deliver more power, dynamics and clarity from 80 Hz and up.
- After adjusting the settings for the Front, Center and Subwoofer, pressing the “Down” arrow key will take you to the ‘Surrounds’ screen..
- ❖ Should you feel that your Front Left and Right Loudspeakers can handle **all low bass frequency information accurately at any volume level or are using loudspeakers with built-in amplified subs**, you can select ‘Large’ for the front speakers. When ‘Large’ is selected, the ‘Large’ setting option for the center and surrounds appears on screen; we still recommend that you select ‘Small’ for those speakers.
  - ◆ Once ‘Large’ has been selected and you are satisfied with the other speaker settings, press the “Enter” key on the remote, this takes you to the “Subwoofer Mode” screen.
  - ◆ For speakers with built-in subs, we suggest you select ‘LFE+Main’. This setting will prevent the subwoofer from going ‘to sleep’ when there is no LFE information for an extended period of time (which happens, as there is often very little information in the LFE channel).
  - ◆ We recommend for those users of speakers with built-in powered subs to connect RCA cables from the AVR-2802 subwoofer output (using a Y-adapter) into each speakers’ LINE INPUT, not LFE. Using this input will yield excellent bass response and never allow the subwoofer to go into a ‘sleep’ mode. Set the front speaker size to ‘Small’ and subwoofer to ‘Yes’.

## **DELAY TIME**

- This menu allows you to easily configure the delay times for all the speakers, including the subwoofer, in the system. We suggest you use a tape measure to help you be as accurate as possible. This is a performance advantage over other receivers that allow only center channel (front and/or rear) delay time adjustment.
  - Upon entering the setup item, you will need to choose which unit of measurement you prefer, meters or feet. Select using the “Left/Right” arrow keys.
  - Once you’ve selected the units of measurement, you will be taken to the screen where you will need to adjust the distances from the ‘Best Seat’ in the room to each speaker. Only the speakers you selected in the “Speaker Configuration” screen will be shown for adjustment. Use the “Left/Right” arrow keys to make adjustments, and the “Up/Down” arrows to select the individual Speakers.
  - When complete, press the “Enter” key.

## **Channel Level**

- Use this setting to adjust the playback levels from the different channels so that they are equal in sound level. We feel this setting is another critical step in getting the very best performance from the AVR-2802, so we highly recommend you use a Sound Pressure Level (SPL) meter when doing these adjustments.
- An SPL meter is an objective measurement device that will give the most accurate reading for this setting. Our ears are subjective and not precise in measuring levels from Speakers that are mounted in different locations. Radio Shack sells a very good \$30 Analog (not Digital) SPL meter, be sure it’s the Analog one, as it provides greater ease of use, especially with the Subwoofer Levels.
- Any level adjustments should be done at the ‘Best Seat’ location. Do not attempt to get a room average by making adjustments while moving around the room!
- Your first selection will be to choose how the Test Tones will be output from the AVR-2802, either in an automatic sequence or manually. Using the ‘Left/Right’ arrows, select ‘Manual’, as this setting will allow you control which speaker the tone comes out of and for how long. The ‘Auto’ setting is cyclical and quick and should only be used by someone who is very comfortable setting up Channel Levels.
- The next adjustment is to select the Surround Speaker(s) to be on during the Test Tones.
  - Your choices are based on your settings from the “Speaker Configuration” screen you completed earlier.
- Finally it’s time to start the Test Tones and adjust the levels. Select ‘Yes’ to start the Test Tone generator in the AVR-2802. You will see a room diagram showing you which speaker was selected to be adjusted for this setting, each speaker will flash when they are playing the Test Tone. You will also notice individual level bars for each speaker.



Use the “Up/Down” arrows to raise/lower the level from each channel, and use the “Left/Right” arrows to select the channel to adjust. Take your time!

- We recommend that once you have completed adjusting the levels, to write down and secure, the levels for every channel. This will help you to reset the system quickly to reference if someone changes the levels, which you know will happen.
- Once finished press the “Enter” key. If you have the system exemplified above, go back into Channel Level and reconfigure the speakers for further level adjustments.

### **Digital In Assignment**

- This setting assigns the digital input jacks of the AVR-2802 to the different input sources you have connected to it; i.e. DVD, CD, SAT, MD, CDR etc.
- Use the “Up/Down” arrow keys to select the input source you wish to adjust, then using the “Left/Right” keys to select to digital input you have used for that source.
- Make note that no two sources can share the same digital input.
- For those input sources that have no digital inputs assigned, select ‘off’.
- When complete, press the “Enter” key.

### **On Screen Display**

- This setting toggles the Display ‘On’ or ‘off’. For convenience sake, leave in the ‘On’ position.

### **Auto Tuner Presets**

- This setting, when activated, will allow the AVR-2802 to automatically find and store into memory, up to 40 FM radio stations. If a station with poor reception is not stored automatically, you can manually store it into memory.
- Be sure an antenna is attached properly!
- When the AVR-2802 has finished searching and locking in stations into memory, the Setup is complete. Simple press the System Setup button to exit out. Enjoy.

## Free Manuals Download Website

<http://myh66.com>

<http://usermanuals.us>

<http://www.somanuals.com>

<http://www.4manuals.cc>

<http://www.manual-lib.com>

<http://www.404manual.com>

<http://www.luxmanual.com>

<http://aubethermostatmanual.com>

Golf course search by state

<http://golfingnear.com>

Email search by domain

<http://emailbydomain.com>

Auto manuals search

<http://auto.somanuals.com>

TV manuals search

<http://tv.somanuals.com>