



OPERATOR'S MANUAL ***WEED & GRASS*** ***TRIMMERS***



GT-1100
GT-2101

999222-01804

 **CAUTION**

READ RULES FOR SAFE OPERATION
AND INSTRUCTIONS CAREFULLY

INTRODUCTION

ECHO Weed and Grass Trimmers, Model G.T.-1100 and Model G.T.-2101, are lightweight, high performance, gasoline powered units designed to trim weeds and grass in areas that are difficult to manage by any other means.

This manual provides the information necessary for assembly, operation and maintenance.

CONTENTS

Safety	2
Description	5
Operation	6
Troubleshooting	12
Service	13
• Care	13-14
• Replacing Line	15
• Replacing Head	16
Assembly	18
Storage	20
Specifications	21

SAFETY

UNDERSTAND SAFETY WARNINGS

⚠ DANGER: This symbol is used to call attention to procedures that must be followed to avoid the risk of serious immediate and irreversible human injury or death.

⚠ CAUTION: This symbol is used to call attention to procedures that must be followed to avoid serious, although not necessarily always immediate, risk of human injury or death.

FOLLOW SAFETY INSTRUCTIONS

Follow all danger and caution warnings in this manual and on safety decals on the trimmer.

FOLLOW SAFETY DECALS

Safety decals are placed on your trimmer for your protection. Make sure decals are legible and that you understand and follow the instructions on them.

USE TRIMMER AS INTENDED

⚠ DANGER: Do not use steel blades on this unit.

These units are not designed for use with steel blades. Steel blades may cause serious injury.

ALWAYS obey local ordinances regulating the use of internal combustion engines.

ALWAYS use cutting attachments approved and supplied by ECHO INC. to avoid possible injury.

NEVER operate the unit without the shield in the correct position.

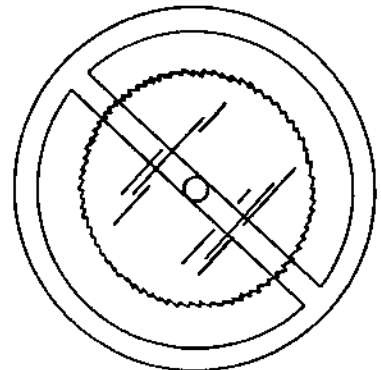

SAFETY

HANDLE FUEL SAFELY

ALWAYS store gasoline in an approved container.
DO NOT smoke while handling gasoline.
ALWAYS stop the engine before refueling.
DO NOT refuel a hot engine. Wait until engine cools.
ALWAYS remove the fuel cap slowly in order to relieve any pressure built up in tank.
DO NOT overfill the tank and always wipe up spilled fuel.
ALWAYS restart the engine at least 10 feet away from refueling point.

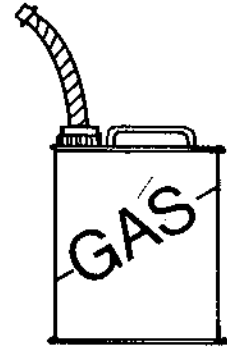

AVOID CARBON MONOXIDE

DO NOT operate in a confined area.

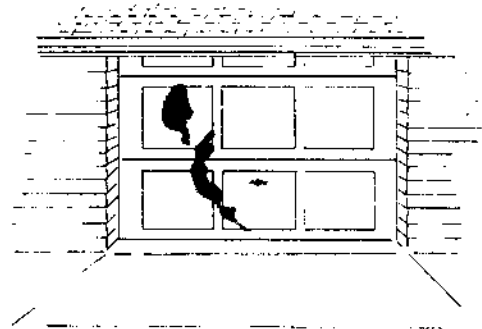

KEEP PEOPLE AND ANIMALS AWAY

DO NOT operate if people or animals are in work area.

CLEAR WORK AREA

Before starting, inspect work area and remove stones or any other foreign objects such as cans, bottles and wire.



SAFETY

WEAR PROTECTIVE CLOTHING AND EQUIPMENT

ALWAYS wear safety protection that meets A.N.S.I. Z87 standards, while operating the unit.

- Always wear gloves and non-skid footwear.
- Dress properly with snug fitting, durable clothing and avoid loose clothing.

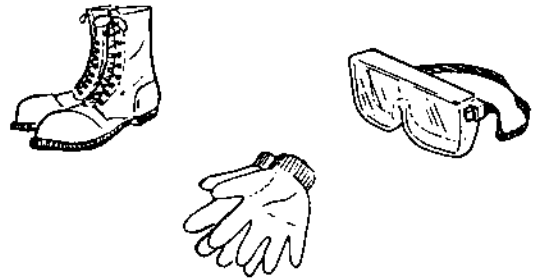

OPERATE SAFELY

DO NOT operate the unit when you are fatigued.

ALWAYS remain alert when operating the unit to avoid possible injury to yourself and other people.

DO NOT operate the unit while under the influence of drugs or alcohol.



USE CORRECT TECHNIQUE

ALWAYS hold the unit firmly with both hands and with fingers and thumbs encircling the handles.

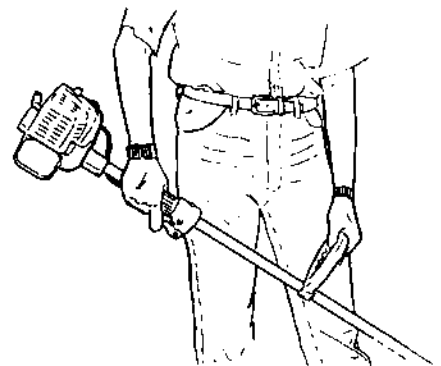

DESCRIPTION

CONTROLS

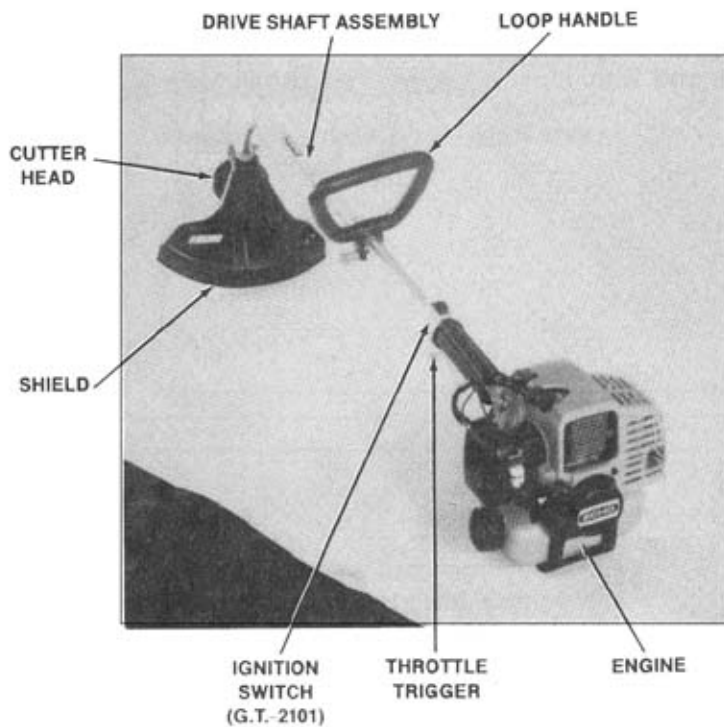
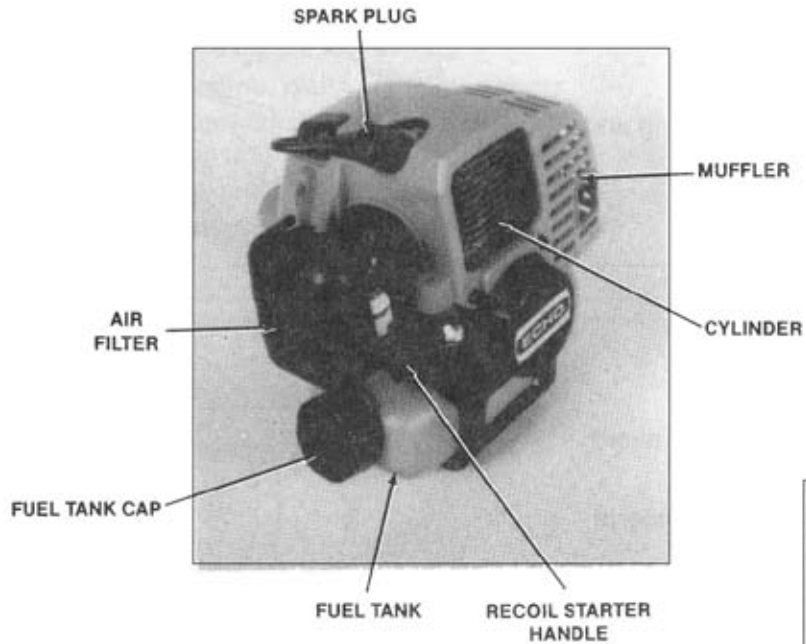

OPERATION

2-CYCLE FUEL (32:1, ECHO OIL)

Use a mixture of 32 parts leaded or unleaded regular grade gasoline (min. Octane 87) and one part 32:1 ECHO 2-stroke oil.

NOTE: Do not use gasohol or alcohol blended fuels in this engine.

2-CYCLE FUEL (50:1, ECHO Approved Oil)

Use a mixture of 50 parts leaded or unleaded regular grade gasoline (min. Octane 87) and one part 50:1 ECHO 2-stroke oil.

NOTE: Do not use gasohol or alcohol blended fuels in this engine.

MIX FUEL

NOTE: Use only oils recommended above.

NOTE: Do not mix fuel in engine fuel tank.

- Pour 1/2 of the gasoline into a safe container.
- Add oil to gas and mix.
- Add remaining gasoline and remix.
- Install fuel tank cap and wipe spilled fuel from container and area.

CHECK TRIMMER CONDITION

1. Check for loose nuts, bolts and screws before using unit.

OPERATION

SAFE STARTING TECHNIQUES

NOTE: Always clear work area of debris before starting operation.

NOTE: Always hold the unit firmly.

NOTE: When pulling starting rope, use short pulls, 1/2 to 2/3 of rope length.

NOTE: Do not allow the starter handle to snap back against the housing.

NOTE: Always hold the unit firmly.

STARTING COLD ENGINE

⚠ DANGER: When engine starts, cutter head may rotate, even with trigger in low speed position.

1. Turn ignition switch to START/RUN.

NOTE: The ignition switch on the G.T.-1100 is located next to the carburetor.



2. Turn choke lever to COLD START (closed) position.

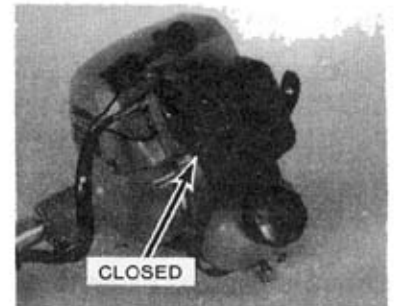

3. Depress throttle trigger fully.
4. Pull starter handle several times until engine fires once.



OPERATION

5. Turn choke lever to RUN (open) position.
6. Start engine.
7. Release throttle trigger and allow engine to warm up.
8. Squeeze throttle trigger gradually.

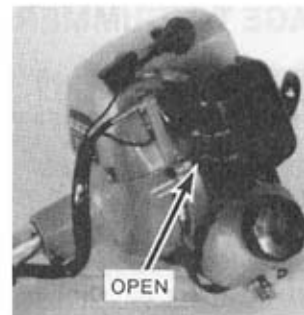

WARM ENGINE STARTING

1. Turn ignition switch to START/RUN position.
2. Place the choke lever in the RUN (open) position.
3. Pull starter handle.

NOTE: If engine does not start after 4 pulls, use cold start procedure.



STOPPING ENGINE

1. Release throttle trigger and allow engine to idle.
2. Turn ignition switch to STOP.

⚠ CAUTION: If engine does not stop, close choke lever to stop engine. Check and repair stop switch before starting engine again.

NOTE: The ignition switch on the G.T.-1100 is located next to the carburetor.

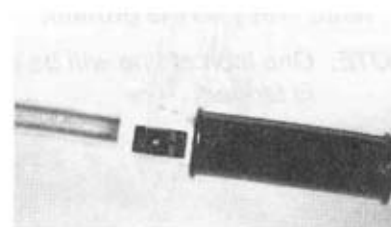

OPERATION

OPERATE SAFELY AND AVOID DAMAGE TO TRIMMER

- Keep both hands on handles when engine is running.
- If cutter becomes clogged, stop engine and clean cutter.
- Do not overreach or stand on unstable surfaces.
- If the cutter head strikes an obstruction or is prevented from turning freely, stop engine and inspect cutter head for damage.
- If the trimmer is operated for extended periods in high temperatures, the driveshaft housing may become very hot (too hot to touch). Allow unit to cool, check lubrication as outlined in service section before continuing.
- To avoid engine damage, do not run at full throttle without load.

ADJUSTING LINE LENGTH

RECOMMENDED LINE LENGTH: 5 inches (measured from edge of cutting head to tip of line).

NOTE: Trimming is done with the tip of the line. Cutting with entire length of the line will result in the line snapping or fraying.

If line is too long, cut-off knife will cut line to length during operation.

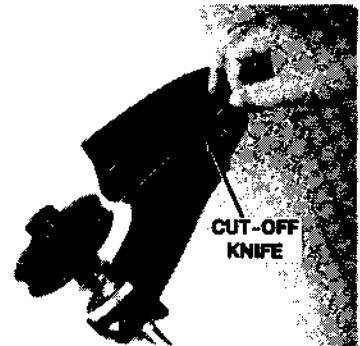

ADJUSTMENT (G.T.-2101, Echomatic Head)

1. With engine running at normal operating speed, tap head firmly on the ground.

NOTE: One inch of line will be released each time head is tapped.

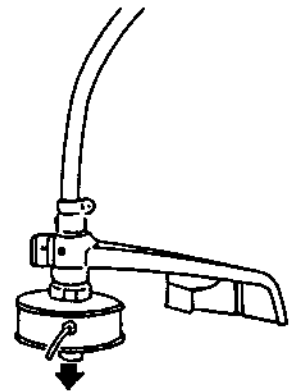

ADJUSTMENT (G.T.-1100, GT Head)

1. With engine stopped, unwind line from spool until proper length is achieved.

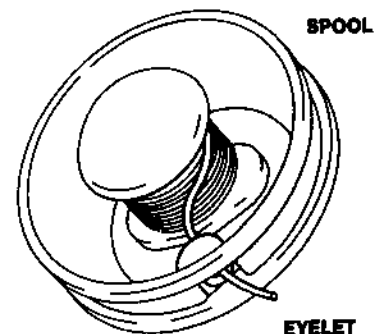

OPERATION

TRIMMING

1. Place trimmer so cutter is facing straight ahead.

⚠ CAUTION: Cutting with the head tilted to the right will result in debris being thrown towards operator.

2. Trim from right to left tilting the unit slightly to the left allowing the debris to be thrown away from the operator.

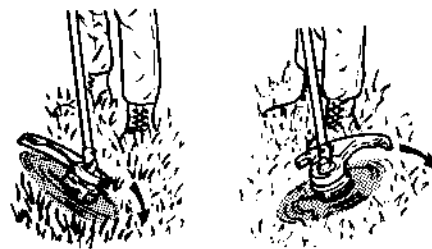

SCALPING

NOTE: Scalping is the removal of all vegetation down to the ground.

1. Tilt the cutter head about 30 degrees to the left.

NOTE: Scalping is very effective around trees and shrubs, but care should be taken not to bruise bark and young sensitive growth.

NOTE: When trimming around flowers, keep in mind that line cuts in a full circle around the head.



EDGING

1. Tilt cutter head at right angles to the ground.
2. Adjust handle bracket to fit edging position.
3. Allow line to skim along edge of the concrete or other hard surface when edging.

⚠ CAUTION: Never use ECHO units with blades for edging.

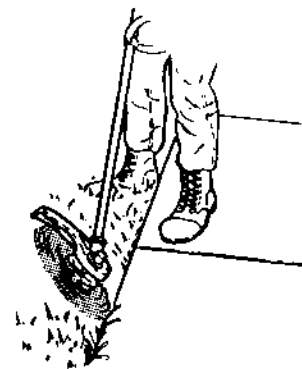

SWEEPING

1. Tilt cutter head slightly to the left.
2. Swing cutter head side to side.



OPERATION

MOWING

⚠ DANGER: During this operation, debris may be thrown in any direction. Always wear eye protection when using trimmer.

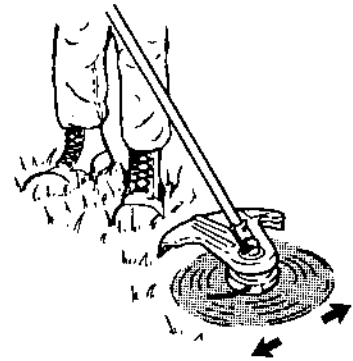

TROUBLESHOOTING

TROUBLE	CAUSE	WHAT TO DO
1. Engine fails to start.	<p>No fuel in tank. Strainer clogged. Fuel line clogged. Spark plug shorted or fouled. Spark plug broken (cracked porcelain or electrodes broken). Ignition lead wire shorted, broken or disconnected from spark plug. Ignition inoperative (no spark from lead wire).</p>	<p>Fill tank. Clean strainer. Clean fuel line. Install new spark plug. Replace spark plug. Replace lead wire or attach to spark plug. Contact your nearest authorized dealer.</p>
2. Engine hard to start.	<p>Water in gasoline or stale fuel mixture. Too much oil in fuel mixture. Engine over or under choked. Carburetor out of adjustment. Gasket leaks (carburetor or cyl. base gasket). Weak spark at lead wire.</p>	<p>Drain entire system and refill with fresh fuel. Drain and refill with correct mixture. If flooded by over choking, proceed according to instructions in previous section. If under choked, move choke lever to closed position and crank two or three times. See "Carburetor Adjustment." Replace gaskets. Contact your nearest authorized dealer.</p>
3. Engine misses.	<p>Dirt in fuel line or carburetor. Carburetor improperly adjusted. Spark plug fouled, broken or incorrect gap setting. Weak or intermittent spark at lead wire.</p>	<p>Remove and clean. See "Carburetor Adjustment" in service section. Clean or replace spark plug – set gap to 0.6–0.7 mm (0.024–0.028). Contact your nearest authorized dealer.</p>
4. Engine lacks power.	<p>Air cleaner clogged. Carburetor out of adjustment. Muffler clogged. Clogged exhaust ports. Poor compression.</p>	<p>Clean air cleaner. See "Carburetor Adjustment." Clean carbon from muffler. Remove muffler, rotate engine until the piston is at bottom of cylinder. With a wooden scraper or blunt tool, remove all carbon from exhaust ports. Be careful not to scratch or damage piston or cylinder walls. Blow out loose carbon with compressed air. Start engine and run briefly to remove all carbon, then install muffler and gasket. Contact your nearest authorized dealer.</p>
5. Engine overheats.	<p>Insufficient oil in fuel mixture. Air flow obstructed.</p>	<p>Mix fuel as shown in starting instructions. Clean flywheel and cylinder fins and screen.</p>
6. Engine noisy or knocking.	<p>Loose flywheel. Spark plugs incorrect heat range. Worn bearings, piston rings or cylinder walls.</p>	<p>Tighten flywheel nut. Replace with plugs specified for engine. Contact your nearest authorized dealer.</p>
7. Engine "stalls" under load.	<p>Carburetor main adjustment too "lean." Engine overheats.</p>	<p>See "Carburetor Adjustment." See "Carburetor Adjustment."</p>

SERVICE

CLEANING AIR FILTER (Before Each Use)

1. Remove air filter cover.
2. Remove air filter from cover.
3. Brush dirt from filter or wash it in suitable cleaner.

NOTE: Allow all parts to air dry.

4. Reinstall filter and cover.

*NOTE: Insure filter is undamaged and is properly fitted
– replace if necessary.*



CLEANING FUEL STRAINER (Check Periodically)

1. Pick up fuel strainer through fuel inlet port with a piece of steel wire.
2. Clean strainer in suitable cleaner or replace it.
3. Reinstall strainer.

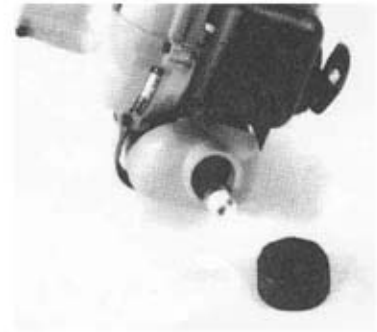

CHECKING SPARK PLUG (Check Periodically)

1. Check for proper gap of 0.6–0.7 mm (0.024–0.028).
2. Inspect electrode for wear.
3. Inspect insulator for oil or other deposits.
4. Replace plug, if needed, and torque to 145–155 kg-cm (125–135 in. lb).

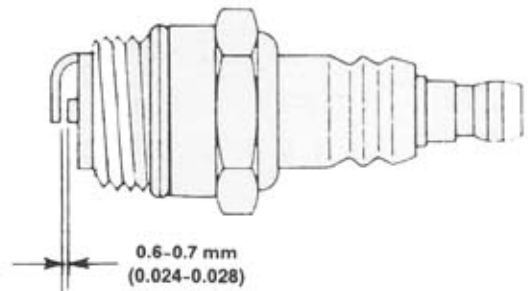

LUBRICATING DRIVESHAFT (Flexible Shaft)

1. Loosen screw and bolt and remove bearing housing.
2. Pull the flexible shaft from the drive shaft tube.
3. Wipe shaft clean and recoat it with a thin coating (.352–.705 oz.) of lithium base grease.
4. Reverse the above procedure for installation.

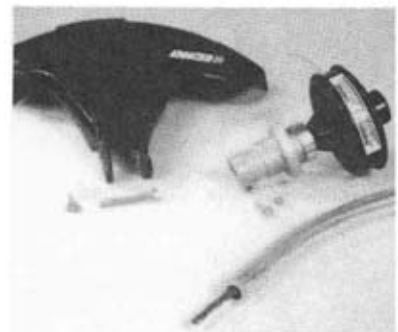

SERVICE

CARBURETOR ADJUSTMENT (As Needed)

The idle speed adjustment screw controls the throttle opening at idle position.

If the idling adjustment is too low or too high, use the following procedure.

ADJUSTING IDLE SPEED SCREW

1. Start engine and allow it to warm up.
2. Turn screw clockwise until cutting head begins to rotate.
3. Turn screw counterclockwise one turn or until head stops rotating.

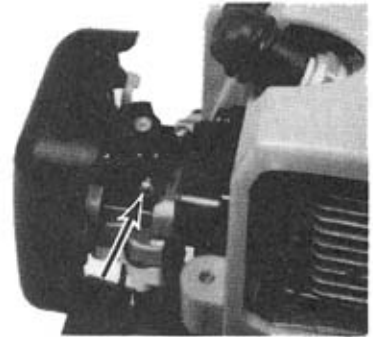

CLEANING MUFFLER AND EXHAUST PORT (SAM) (Clean as Necessary)

1. Remove muffler cover and muffler.

NOTE: Be careful not to scratch the cylinder or piston when cleaning the cylinder exhaust port.

2. Clean deposits from cylinder exhaust port.
3. Replace spark arrester screen if clogged.
4. Install muffler and muffler cover.

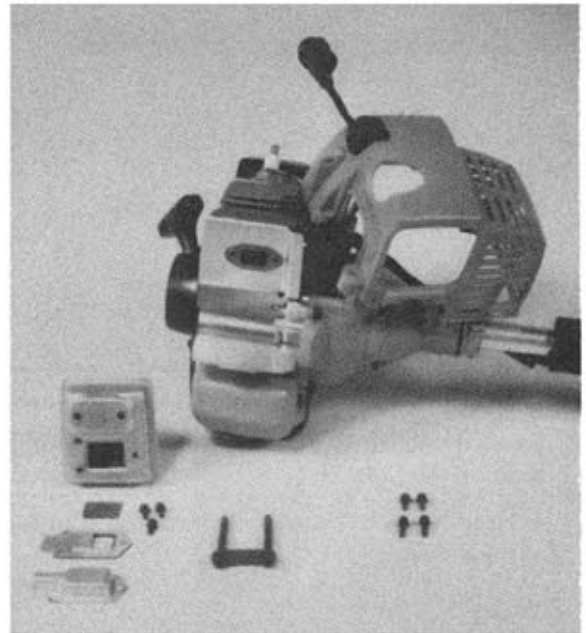

SERVICE

CLEANING CYLINDER FINS (Check Periodically)

1. Remove cover.
2. Remove dust and dirt from between fins.
3. Reinstall cover.
4. Clean air intake grids on crankcase.

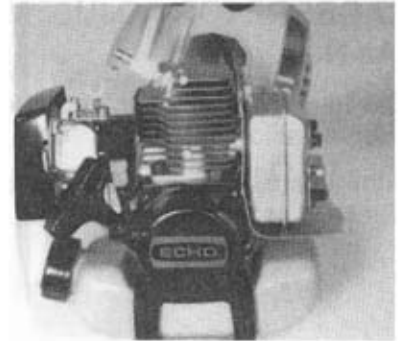

REPLACING NYLON LINE (GT-2101, Echomatic Head)

1. Turn cutting head clockwise, using locking tool, until head comes free of shaft.



2. Depress button on head and remove cover.
 - Remove hub and spring from head.



3. Secure one end of the replacement nylon line to the loop on the hub.
 - Hold the line tight while winding it in a clockwise direction.

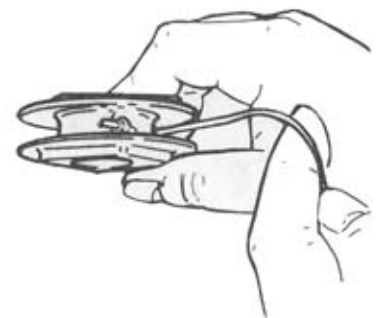

SERVICE

4. Feed the nylon line through the eyelet in the hub and press the reel into position against the spring.
5. Align pegs on cover with holes in head and press cover into place.

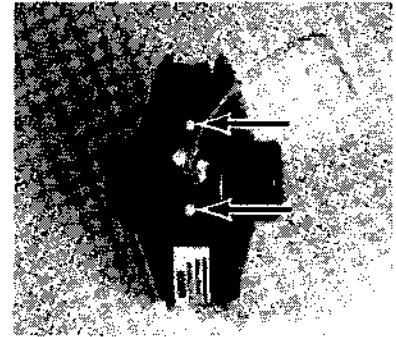

REPLACING NYLON LINE (GT-1100 Head)

NOTE: Use 3.65 m (12 ft.) of line.

1. Loop one end of line through the retainer slots in spool holder.
2. Wind the line evenly and tightly onto the spool in a clockwise direction (note arrow on spool) as viewed from outer end of head.

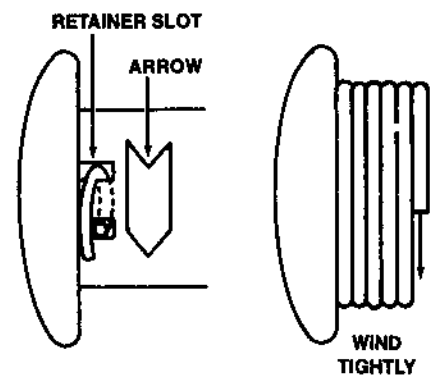

3. Thread end of line through eyelet in housing.

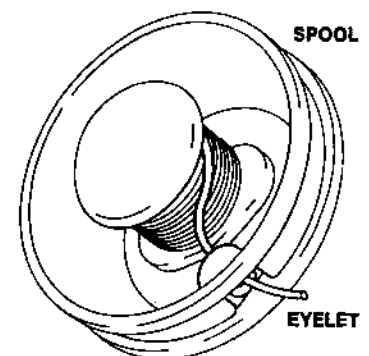

INSTALLING NYLON CUTTER HEAD

1. Rotate the driveshaft until the holes in the upper adapter plate and bearing housing are aligned.
2. Insert the locking tool in holes.
3. Screw the cutter head onto the driveshaft. (Rotate the head **CLOCKWISE** to tighten.)
4. Remove locking bar.



SERVICE

INSTALLING MAXICUT HEAD

1. Align hole in adapter plate with hole in bearing housing and install locking tool.
2. Rotate nylon line cutter head counterclockwise until it comes free of shaft.
3. Tighten blade attaching screws and nuts (A) until blades are snug.
4. Loosen screws and nuts (A) until blades swing freely.
5. Install Maxicut Head (B) on shaft.
6. Install flat washer (C).
7. Install and tighten lock nut (D).

NOTE: This is an interference thread nut. It must be tightened until the Maxicut Head will not rotate on the shaft.

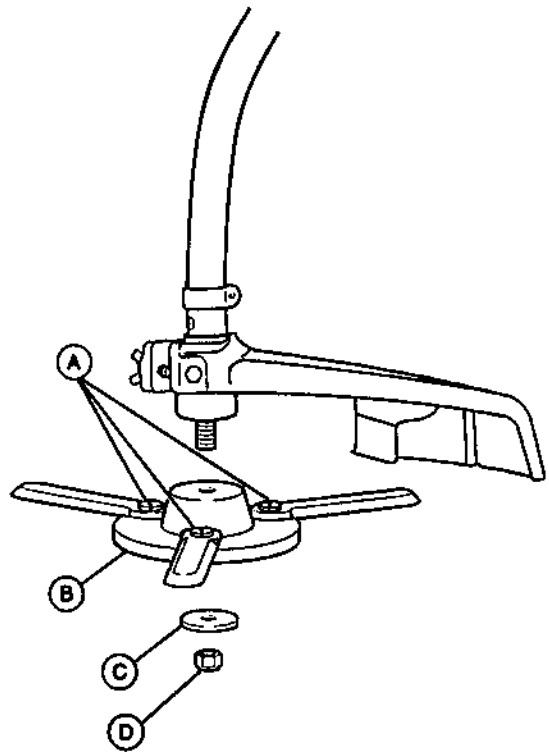

ASSEMBLY

ASSEMBLING DRIVESHAFT

1. Stand engine upright on a level surface.
2. Loosen the two bolts at driveshaft end of engine.
3. Carefully fit driveshaft assembly to engine making sure the shaft is correctly engaged.

NOTE: The line on the driveshaft housing must be in contact with the engine (arrow ▲ on driveshaft indicates line).

4. Rotate the driveshaft housing until gear housing is in line with the engine.
5. Tighten bolts.



ASSEMBLING THROTTLE CABLE

NOTE: The engine is delivered separated from shaft. The throttle cable is attached to the shaft.

1. Remove nut from throttle cable.
2. Insert throttle cable through hole in fan cover.
3. Reinstall nut. Finger tighten nut and attach the inner cable to the swivel on the throttle lever.

NOTE: It is important that the nipple of the throttle cable fits into one side of slot.

4. Tighten nut.
5. Check throttle for freedom of movement and make sure it returns to idle position.
6. Attach ground wire under screw head of fan housing screw.

NOTE: On Model G.T. 1100, ground wire is already attached to rear of stop switch.



ASSEMBLY

INSTALLING LOOP HANDLE

1. Remove the wing nut, washer and bolt from the loop handle.
2. Push the handle over the driveshaft so that it is 152.4 mm-203.2 mm (6-8 in.).
3. Place handle in comfortable operating position and secure position with bolt, washer and wing nut.

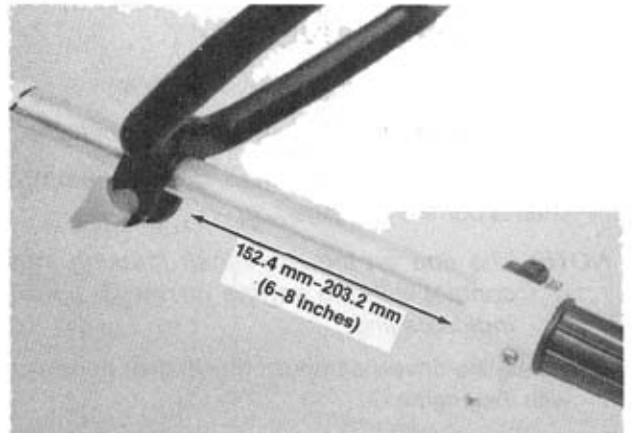

INSTALLING SHIELD (With Cut-Off Knife)

1. Remove wing nut, washer and bolt from the shield.
2. Install the shield on the bearing housing.
3. Install bolt, washer and wing nut.

NOTE: The location of the cut-off knife should be adjusted depending on the model. (Remove both nuts and cut-off knife and set as required.)

⚠ CAUTION: Do not operate trimmer without shield in correct position.

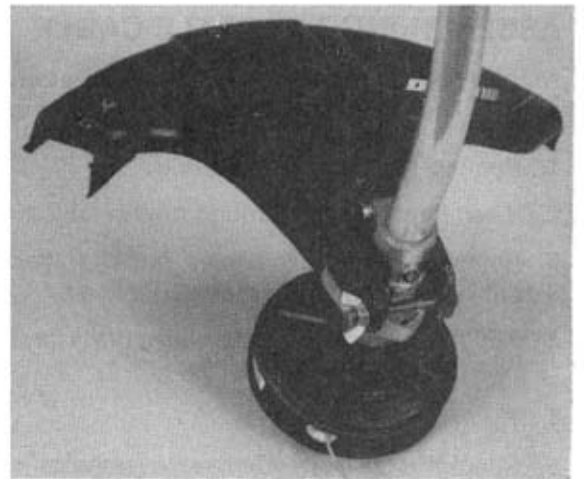

STORAGE

LONG TERM STORAGE

1. Clean each part and replace or repair damaged or worn parts.
2. Apply a thin coating of oil to all metal parts to prevent rust.
3. Drain fuel from fuel tank. Start engine and let run to remove fuel from carburetor and fuel lines.
4. Remove cutter head, apply a generous coating of oil and store in plastic.
5. Pour a small amount of clean motor oil into spark plug hole and pull starter handle until motor reaches top dead center.
6. Store in a dry area, free from dust.

PARTS BOOKS

To obtain a replacement Parts Book, complete this order form and enclose a check or money order for \$2.00. Make payable to ECHO, INCORPORATED and mail to:

ECHO, INCORPORATED
P.O. Box 67
Lake Zurich, IL 60047

ATTN: Technical Publications

Purchaser's Name

Address (Street)

(City)

(State)

(Zip Code)

ECHO Model No. G.T.-1100

ECHO Model No. G.T.-2101

Parts Book No. 898-696-44330

Parts Book No. 898-696-44430

SPECIFICATIONS

MODEL G.T.-1100, G.T.-2101

Length	1.400 m (55 in.)
Width	330 mm (13 in.)
Height	360 mm (14 in.)
Weight (Dry Weight)	(without cutter) GT.-1100: 8.4 lbs. G.T.-2101: 8.8 lbs.
Type of Engine	Air-cooled, two-stroke, single-cylinder, gasoline engine
Bore	32.2 mm (1.268 in.)
Stroke	26.0 mm (1.024 in.)
Displacement	21.2 cc (1.29 cu. in.)
Exhaust System	Spark arrester muffler
Carburetor	WALBRO diaphragm model WYL type
Ignition System	Flywheel magneto, capacitor discharge ignition type
Spark Plug	NGK BPM7A, CHAMPION CJ-7Y
Fuel	Mixed fuel
Fuel Oil Ratio	32:1 ratio with ECHO oil or 50:1 ratio with ECHO oil
Gasoline	Regular
Oil	Designated, two-stroke, air-cooled engine oil
Fuel Tank Capacity	0.4 lit. (13.5 oz.)
Starter System	Automatic rewind system
Clutch	Centrifugal type
Drive Shaft	1/4" flexible shaft
Rotating Direction	Clockwise viewed from top
Cutter Head	Nylon line head G.T.-1100: Manual G.T.-2101: Echomatic
Handle	Left-D-loop, Right-grip

Free Manuals Download Website

<http://myh66.com>

<http://usermanuals.us>

<http://www.somanuals.com>

<http://www.4manuals.cc>

<http://www.manual-lib.com>

<http://www.404manual.com>

<http://www.luxmanual.com>

<http://aubethermostatmanual.com>

Golf course search by state

<http://golfingnear.com>

Email search by domain

<http://emailbydomain.com>

Auto manuals search

<http://auto.somanuals.com>

TV manuals search

<http://tv.somanuals.com>