



Grass Trimmer

Operator's Manual

MODELS

GT-2000

Serial Number 001001 & Up Occasional Use

GT-2000 Type 1E

Serial Number 001001 & Up Occasional Use

GT-2400

Serial Number 001001 & Up Commercial Use

GT-2400 Type 1E

Serial Number 001001 & Up Commercial Use

WARNING DANGER



The muffler or catalytic muffler and surrounding cover may become extremely hot.

Always keep clear of exhaust and muffler area, otherwise serious personal injury may occur.

WARNING

The engine exhaust from this product contains chemicals known to the State of California to cause cancer, birth defects or other reproductive harm.



WARNING DANGER

Read rules for safe operation and instructions carefully. ECHO provides an Operator's Manual and a Safety Manual. Both must be read and understood for proper and safe operation.

X7532271503

89869547933
02/01

INTRODUCTION

Welcome to the ECHO family. This ECHO product was designed and manufactured to provide long life and on-the-job-dependability. Read and understand this manual and the SAFETY MANUAL you found in the same package. You will find both easy to use and full of helpful operations tips and SAFETY messages.

WARNING DANGER

Read rules for safe operation and instructions carefully. ECHO provides an Operator's Manual and a Safety Manual. Both must be read and understood for proper and safe operation.

THE OPERATOR'S MANUAL

contains specifications and information for operation, starting, stopping, maintenance, storage and assembly specific to this product.

THE SAFETY MANUAL

explains possible hazards involved with the use of Grass Trimmers and Brush cutters and what measures you should take to make their use safer.

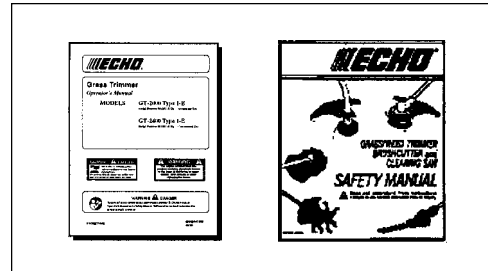

TABLE OF CONTENTS

Introduction	2	- Starting Warm Engine	17
- The Operator's Manual	2	- Stopping Engine	17
- The Safety Manual	2	Maintenance	18
Manual Safety Symbols and Important Information ..	3	- Skill Level	18
Safety	3	- Maintenance Intervals	18
- Decals	3	- Air Filter	19
- International Symbols	4	- Fuel Filter	19
- Equipment	4	- Spark plug	20
- Fuel	5	- Cooling System	20
- Personal Conditions and Safety Equipment	6	- Exhaust System	21
- Safe Operation	7	- Carburetor Adjustment Emission Models	22
- Extended Operation/Extreme Conditions	8	- Carburetor Adjustment Non Emission Models ..	23
Description	9	- Lubrication	24
- Emission Control	9	- Nylon Line Replacement (GT-2000)	24
- Contents List	9	- Nylon Line Replacement (GT-2400)	25
Specifications	11	Troubleshooting	27
Assembly	12	Storage	28
- Plastic Shield Installation	12	Servicing Information	32
- Nylon Head Installation	12	- Parts	32
- Front (Loop) Handle	12	- Service	32
Pre-Operation	13	- ECHO Consumer Product Support	32
- Fuel	13	- Warranty Card	32
- Equipment Check	14	- Additional or Replacement Manuals	32
- Determine Operation Area	15		
Operation	15		
- Starting Cold Engine	16		

Specifications, descriptions and illustrative material in this literature are as accurate as known at the time of publication, but are subject to change without notice. Illustrations may include optional equipment and accessories, and may not include all standard equipment.

MANUAL SAFETY SYMBOLS AND IMPORTANT INFORMATION

Throughout this manual and on the product itself, you will find safety alerts and helpful, information messages preceded by symbols or key words. The following is an explanation of those symbols and key words and what they mean to you.



This symbol accompanied by the words **WARNING** and **DANGER** calls attention to an act or condition that can lead to serious personal injury to operator and bystanders.



The circle with the slash symbol means whatever is shown within the circle is prohibited.



IMPORTANT



NOTE

IMPORTANT The enclosed message provides information necessary for the protection of the unit.

NOTE This enclosed message provides tips for use, care and maintenance of the unit.

SAFETY

DECALS

Locate these safety decals on your unit. The complete unit illustration found in the "DESCRIPTION" section, will help you locate them. Make sure the decals are legible and that you understand and follow the instructions on them. If a decal cannot be read, a new one can be ordered from your ECHO dealer. See PARTS ORDERING instructions for specific information.

A. SHAFT DECAL



WARNING DANGER

•This unit can be dangerous and cause serious injury if improperly used. • Operators, helpers and bystanders can be severely injured by thrown objects and must wear specified ANSI Z87.1 eye protection. Blindness or loss of eye can occur. Do not rely on cutter head shield to protect eyes. Ricochet can occur. •to avoid accidental contact, keep everyone beyond operating area. •To reduce the risk of injury to operator, helpers & bystanders, read and understand your operator's and safety manuals. For a free copy of the safety Manual, write to ECHO, INCORPORATED, 400 Oakwood Road, Lake Zurich, IL 60047. •Keep shield and other components in place and in good condition. Do not use attachments or other parts not approved by ECHO. GT style (non-blade capable) units must not be converted to blade use except Maxi-Cuts or similar ECHO approved attachments.



B. SPANISH DECAL



890228-09560

ADVERTENCIA PELIGRO

Esta unidad puede ser peligrosa y producir lesiones personales graves si no se usa en forma adecuada. Para reducir el riesgo de lesionarse, los operadores, los ayudantes y los espectadores deben leer y comprender el Manual Del Operador y los Manuales De Seguridad que se entregan escritos en español.

ENGLISH TRANSLATION



WARNING DANGER

This unit can be dangerous and cause serious injury if improperly used. To reduce injury risk to operator, helpers and bystanders, read and understand the Operator's and Safety Manuals, which are provided in Spanish.

C. SHIELD DECAL



INTERNATIONAL SYMBOLS

SYMBOL FORM/ SHAPE	SYMBOL DESCRIPTION/APPLICATION	SYMBOL FORM/ SHAPE	SYMBOL DESCRIPTION/APPLICATION
	Read and understand Operator's Manual.		FUEL AND OIL MIXTURE
	WEAR EYES, EARS AND HEAD PROTECTION		FINGER SEVERING
	HOT SURFACE		WEAR SLIP RESISTANT FOOT WEAR.
	WEAR HAND AND FOOT PROTECTION		DO NOT SMOKE NEAR FUEL.
	SAFETY/ALERT		
			KEEP BYSTANDERS AND HELPERS AWAY 15 M (50 FT.).

SYMBOL FORM/ SHAPE	SYMBOL DESCRIPTION/APPLICATION	SYMBOL FORM/ SHAPE	SYMBOL DESCRIPTION/APPLICATION
	DO NOT ALLOW FLAMES OR SPARKS NEAR FUEL.		EMERGENCY STOP
	Engine choke control.		IGNITION ON/OFF
	PRIMER BULB		CARBURETOR ADJUSTMENT - HIGH SPEED MIXTURE
	DO NOT EXCEED 10,000 RPM.		CARBURETOR ADJUSTMENT - LOW SPEED MIXTURE
	DO NOT OPERATE WITHOUT GUARDS AND SHIELDS IN PLACE.		CARBURETOR ADJUSTMENT - IDLE SPEED
	DO NOT USE BLADES. STRING LINE ONLY		BEWARE - THROWN, RICOCHET OBJECTS

EQUIPMENT

Before operation a complete check of the unit must be performed;

- Check unit for loose/missing nuts, bolts and screws. Tighten and/or replace as needed.
- Inspect fuel lines, tank and area around carburetor for fuel leaks. DO NOT operate unit if leaks are found.
- Inspect shield for damage and ensure that the cut-off knife is securely in place. Replace if either is damaged or missing.
- Check that the cutting attachment is firmly attached and in safe operating condition.
- Check that front (loop) handle and optional shoulder/waist harness are adjusted for safe, comfortable operation. See Assembly for proper adjustment.
- Have repairs done only by an authorized ECHO Service Dealer.
- Do not use any attachment, accessory or replacement part unless it is recommended in the Operator's Manual.

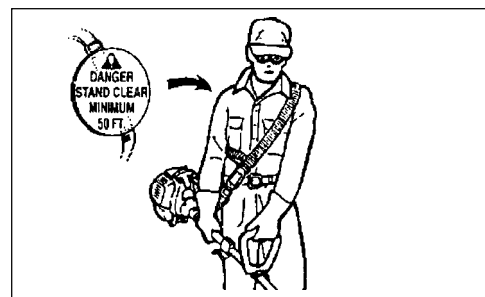
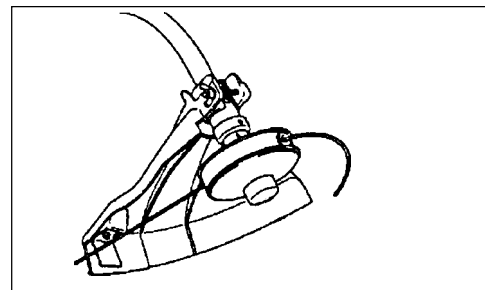
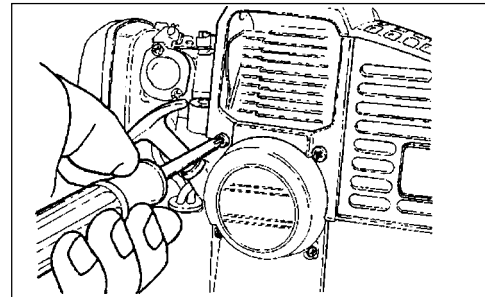

Spark Arrestor - Catalytic Muffler/Muffler

- The muffler or catalytic muffler controls the exhaust noise and emissions. The spark arrestor screen prevents hot, glowing particles of carbon from leaving the muffler. Make sure the spark arrestor screen is in good repair and properly seated in the muffler. Keep exhaust area clear of flammable debris. Avoid contact during and immediately after operation.

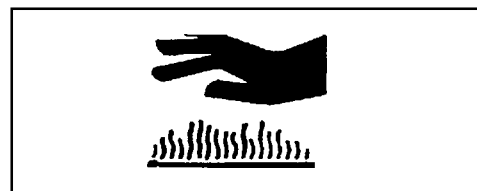
**FUEL****WARNING**  **DANGER**

Fuel is **VERY** flammable. Use extreme care when mixing, storing or handling, otherwise serious personal injury may result.

- Use an approved fuel container.
- **DO NOT** smoke near fuel.
- **DO NOT** allow flames or sparks near fuel.
- Fuel tanks/cans may be under pressure. Always loosen fuel caps slowly allowing pressure to equalize.
- **NEVER** refuel a unit when the engine is **HOT!**
- **NEVER** refuel a unit with the engine running.
- **DO NOT** fill fuel tanks indoors. **ALWAYS** fill fuel tanks outdoors over bare ground.
- Securely tighten fuel cap after refueling.
- Inspect for fuel leakage. If fuel leakage is found, do not start or operate unit until leakage is repaired.

IMPORTANT

Spilled fuel is a leading cause of hydrocarbon emissions. Some states may require the use of automatic fuel shut-off containers to reduce fuel spillage. Contact your ECHO dealer for ordering information.

**After Refueling;**

- Wipe any spilled fuel from the unit.
- Move at least 3 m (10 ft.) from refueling location before starting.

After Use;

- **DO NOT** store a unit with fuel in its tank. Leaks can occur. Return unused fuel to an approved fuel storage container.

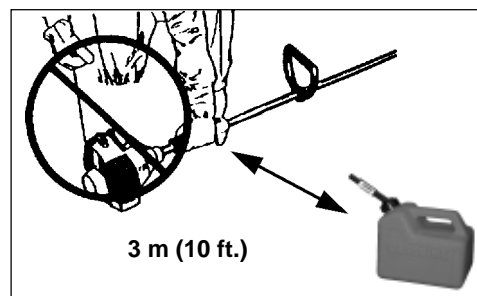

PERSONAL CONDITION AND SAFETY EQUIPMENT

WARNING DANGER

Trimmer/Brush Cutter users risk injury to themselves and others if the trimmer/brush cutter is used improperly and or safety precautions are not followed. Proper clothing and safety gear must be worn when operating a trimmer.

Physical Condition --

Your judgment and physical dexterity may not be good:

- if you are tired or sick,
- if you are taking medication,
- if you have taken alcohol or drugs.

Operate unit only if you are physically and mentally well.



Eye Protection --

Wear eye protection that meets ANSI Z87.1 or CE requirements whenever you operate the trimmer.

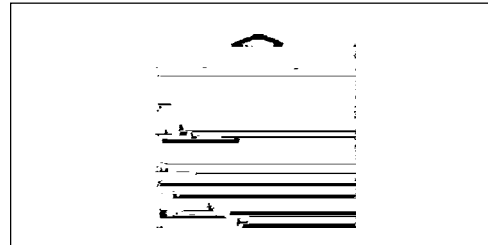

Hand Protection --

Wear no-slip, heavy duty work gloves to improve your grip on the Trimmer/Brush Cutter handles. Gloves also reduce the transmission of machine vibration to your hands.

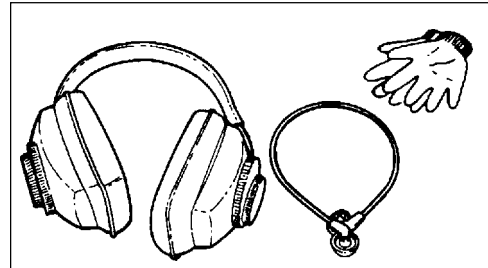

Hearing Protection --

ECHO recommends wearing hearing protection whenever unit is used.



Proper Clothing --

Wear snug fitting, durable clothing;

- Pants should have long legs, shirts with long sleeves.
- **DO NOT WEAR SHORTS,**
- **DO NOT WEAR TIES, SCARVES, JEWELRY.**

Wear sturdy work shoes with non-skid soles;

- **DO NOT WEAR OPEN TOED SHOES,**
- **DO NOT OPERATE UNIT BAREFOOTED.**

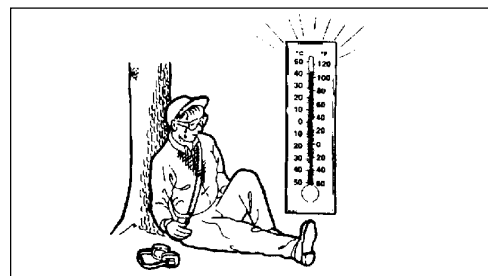

Hot Humid Weather --

Heavy protective clothing can increase operator fatigue which may lead to heat stroke. Schedule heavy work for early morning or late afternoon hours when temperatures are cooler.

SAFE OPERATION

Determine Operation Area

- Provide all operators of this equipment with the Operator's Manual and instructions for safe operation.
- Review the area to be trimmed. Look for hazards that could contribute to unsafe conditions.
- Spectators and fellow workers must be warned, and children and animals prevented from coming nearer than 15 m (50 ft.) while the trimmer is in use.

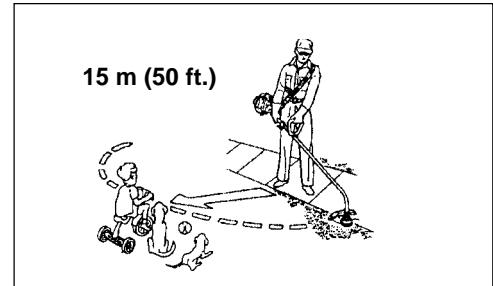

Operation

Use Proper Clothing & Equipment

- Before starting the unit, equip yourself and any other person working within the 15 m (50 ft.) Safety Zone with the required Protective Equipment and clothing.

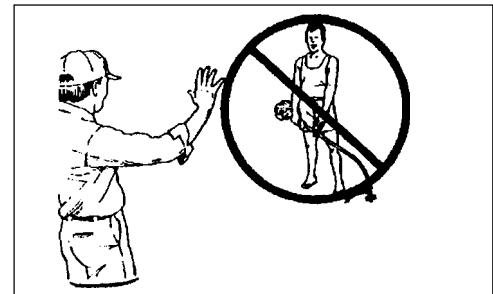

WARNING  DANGER

Do not operate this product indoors or in inadequately ventilated areas. Engine exhaust contains poisonous emissions and can cause serious injury or death.



Avoid Hot Surfaces

- During operation, the complete unit, especially the drive shaft housing and the bearing housing may become very hot, too hot to touch. Avoid contact during and immediately after operation.

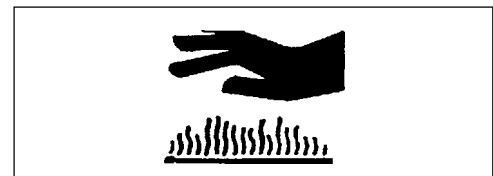

Keep A Firm Grip

- Hold the front and rear handles with both hands with thumbs and fingers encircling the handles



Keep A Solid Stance

- Maintain footing and balance at all times. Do not stand on slippery, uneven or unstable surfaces. Do not work in odd positions or on ladders. Do not over reach.

EXTENDED OPERATION/EXTREME CONDITIONS

Vibration and Cold --

It is believed that a condition called Raynaud's Phenomenon, which affects the fingers of certain individuals may be brought about by exposure to vibration and cold. Exposure to vibration and cold may cause tingling and burning sensations followed by loss of color and numbness in the fingers. The following precautions are strongly recommended because the minimum exposure which might trigger the ailment is unknown.

- Keep your body warm, especially the head, neck, feet, ankles, hands and wrists.
- Maintain good blood circulation by performing vigorous arm exercises during frequent work breaks and also by not smoking.
- Limit the hours of operation. Try to fill each day with jobs where operating the trimmer or other hand-held power equipment is not required.
- If you experience discomfort, redness and swelling of the fingers followed by whitening and loss of feeling, consult your physician before further exposing yourself to cold and vibration.

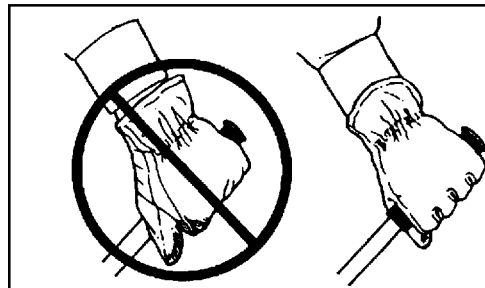
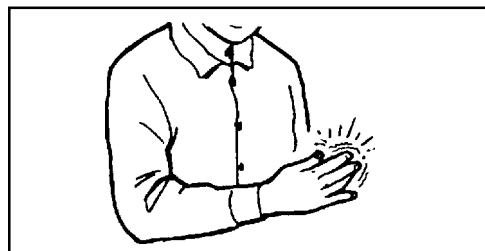
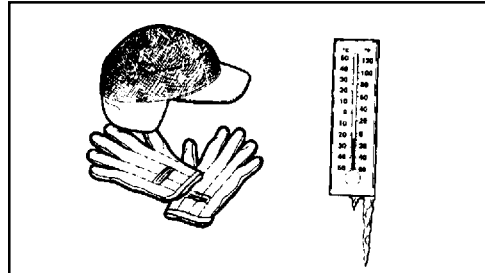

Repetitive Stress Injuries --

It is believed that overusing the muscles and tendons of the fingers, hands, arms and shoulders may cause soreness, swelling, numbness, weakness and extreme pain in those areas. Certain repetitive hand activities may put you at a high risk for developing a Repetitive Stress Injury (RSI). An extreme RSI condition is Carpal Tunnel Syndrome (CTS), which could occur when your wrist swells and squeezes a vital nerve that runs through the area. Some believe that prolonged exposure to vibration may contribute to CTS. CTS can cause severe pain for months or even years. To reduce the risk of RSI/CTS, do the following:

- Avoid using your wrist in a bent, extended or twisted position. Instead try to maintain a straight wrist position. Also, when grasping, use your whole hand, not just the thumb and index finger.
- Take periodic breaks to minimize repetition and rest your hands.
- Reduce the speed & force in which you do the repetitive movement.
- Do exercises to strengthen the hand and arm muscles.
- Immediately stop using all power equipment and consult a doctor if you feel tingling, numbness or pain in the fingers, hands, wrists or arms. The sooner RSI/CTS is diagnosed, the more likely permanent nerve and muscle damage can be prevented.

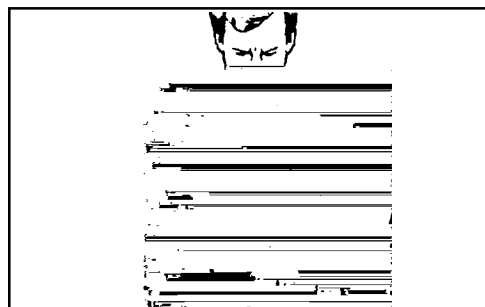

DESCRIPTION

The ECHO product you purchased has been factory pre-assembled for your convenience. Due to packaging restrictions, shield installation and positioning of the front handle are necessary.

After opening the carton, check for damage. Immediately notify your retailer or ECHO Dealer of damaged or missing parts. Use the contents list to check for missing parts.

EMISSION CONTROL --

The emission control system for this engine is EM (Engine Modification).

Emission Control Label located on Engine

(EXAMPLE ONLY, information on label varies by FAMILY).

IMPORTANT ENGINE INFORMATION
ENGINE FAMILY : TEH021UB24RA
DISPLACEMENT : 21.2cc
THIS ENGINE MEETS U.S. EPA PHI AND 1995 -
1999 CALIFORNIA EMISSION REGULATIONS
FOR ULGE ENGINES. REFER TO OWNER'S
MANUAL FOR MAINTENANCE SPECIFICA-
TIONS AND ADJUSTMENTS.

E KIORITZ CORP.

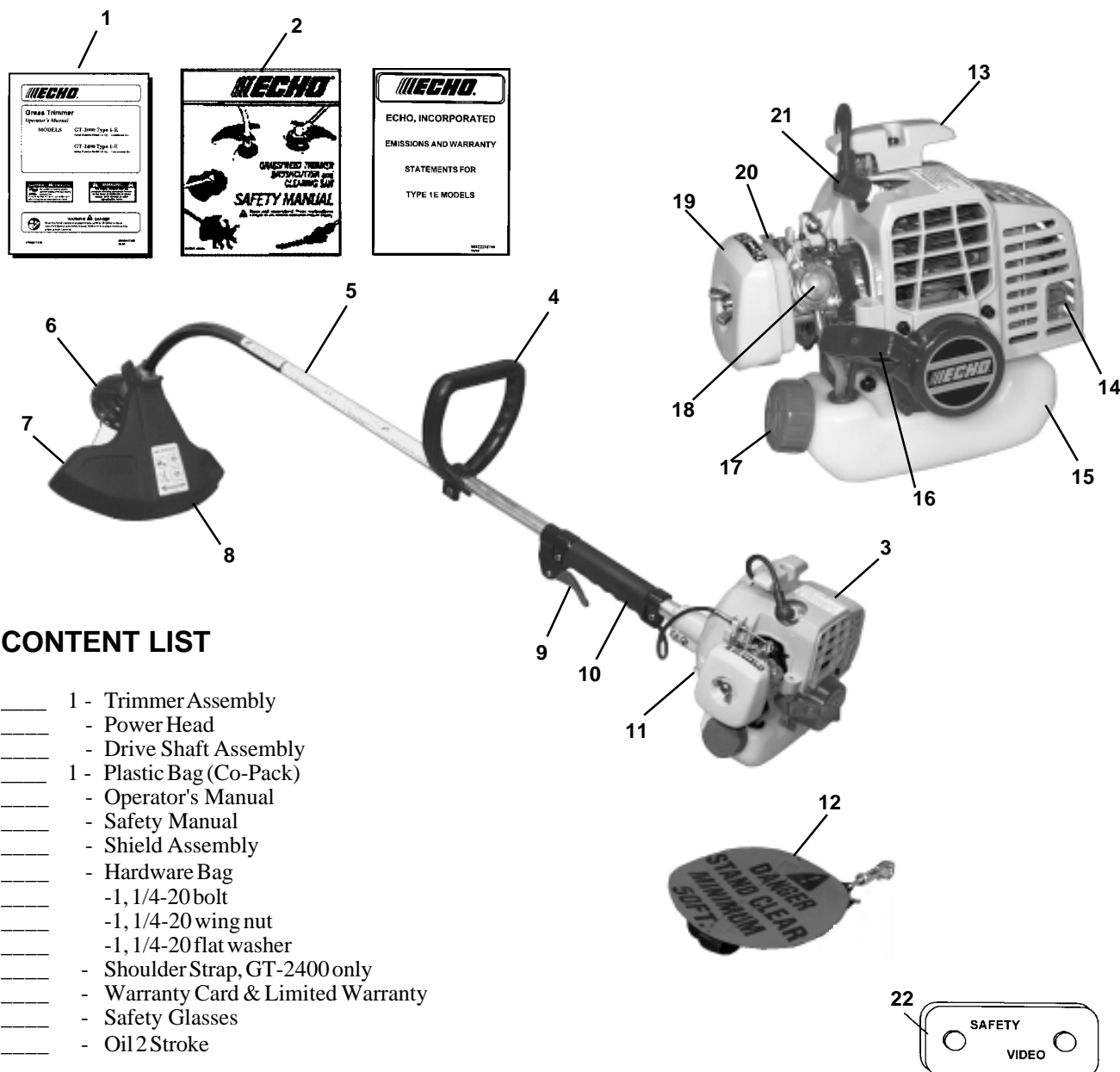

CONTENT LIST

- ___ 1 - Trimmer Assembly
- ___ - Power Head
- ___ - Drive Shaft Assembly
- ___ 1 - Plastic Bag (Co-Pack)
- ___ - Operator's Manual
- ___ - Safety Manual
- ___ - Shield Assembly
- ___ - Hardware Bag
- ___ -1, 1/4-20 bolt
- ___ -1, 1/4-20 wing nut
- ___ -1, 1/4-20 flat washer
- ___ - Shoulder Strap, GT-2400 only
- ___ - Warranty Card & Limited Warranty
- ___ - Safety Glasses
- ___ - Oil Stroke

1. **OPERATOR'S MANUAL** - Included in plastic bag (co-pack). Read before operation and keep in a safe place for future reference, i.e., operation, maintenance, storage and specifications.
2. **SAFETY MANUAL** - Included in plastic bag (co-pack). Read before operation and keep in a safe place for future reference to learn proper, safe operating techniques.
3. **POWER HEAD** - Factory Assembled to the Driveshaft assembly. Includes the Engine, Clutch, Fuel System, Ignition System and Recoil Starter.
4. **FRONT HANDLE** - The Front (loop) handle is factory assembled to the Drive Shaft assembly but must be re-positioned for proper cutting attitude and operator comfort.
5. **DRIVESHAFT ASSEMBLY** - Factory Assembled to the Power Head. Includes the Rear (right hand) Handle Assembly, Bearing Housing Assembly, Throttle Trigger, Front (loop, left hand) Handle Assembly, Flexible Drive Cable and Safety Decals.
6. **NYLON CUTTER HEAD** - Contains replaceable nylon trimming line that advances when the trimmer head is tapped against the ground while the head is turning at normal operating speed.
7. **CUT-OFF KNIFE** - Trims line to the correct length (5"). If trimmer is operated without a cut-off knife the line will become too long - more than (5") - the operating speed will slow, the engine overheat and performance will suffer.
8. **DEBRIS SHIELD ASSEMBLY** - Included in plastic bag (co-pack). **MUST** be installed on unit before use, see Assembly Instructions. Shield assembly includes the Cut-Off Knife and Safety Decal. Mounts on the Bearing Housing Assembly just above the cutting attachment. Helps protect the operator by deflecting debris produced during the trimming operation.
9. **THROTTLE TRIGGER** - Spring loaded to return to idle when released. During acceleration, press trigger gradually for best operating technique.
10. **GRIP** - Rear (right hand) handle.
11. **STOPSWITCH**-
GT-2000 - "TOGGLE SWITCH" mounted on the engine. Move switch UP to RUN, DOWN to STOP.
GT-2400 - "SLIDE SWITCH" mounted on top of the Throttle Trigger Housing. Move switch FORWARD to RUN, BACK to STOP.
12. **SHOULDER HARNESS**- Standard, GT-2400, optional, GT-2000. An adjustable strap that suspends the unit from the operator.
13. **ARM REST** - Provides arm rest during operation and protects arm from hot engine.
14. **MUFFLER SPARK ARRESTOR** - The muffler controls the exhaust noise while the spark arrestor prevents hot particles of carbon from leaving leaving the muffler where they could possibly start a fire.
15. **FUEL TANK** - Contains fuel and fuel filter.
16. **RECOIL STARTER HANDLE** - Pull handle slowly until recoil starter engages, then quickly and firmly. When engine starts, return handle slowly. **DO NOT** let handle snap back or damage to unit will occur.
17. **FUEL TANK CAP** - Cover and seals fuel tank opening.
18. **PRIMER BULB** - Pumping primer bulb before starting engine draws fresh fuel from the fuel tank priming the carburetor for starting. Pump primer bulb until fuel is visible and flows freely in the clear fuel tank return line. Pump bulb an additional 4 or 5 times.
19. **AIR CLEANER** - Contains replaceable filter element.
20. **CHOKE** - Located above the air cleaner housing. Controls operation of choke. Move choke to starting position (Close Choke) and back to run position (Open Choke).
21. **SPARK PLUG** - Provides spark to ignite fuel mixture.
22. **SAFETY VIDEO** - (Not included with unit) P/N 99922202540 English version only is available at a cost of \$5.00 from ECHO, INC. or any authorized ECHO dealer. The video overviews safety precautions and proper operating techniques and is supplemental to the Safety Manual. Read and understand the Safety Manual for complete information on safe operation.

SPECIFICATIONS

MODEL	GT-2000	GT-2400
Length	1400 mm (55.1 in.)	1500 mm (59.1 in.)
Width	330 mm (13.0 in.)	
Height	360 mm (14.2 in.)	
Weight (dry) w/Cutter Head	4.2 kg (9.3 lb.)	4.5 kg (9.9 lb.)
Engine Type	Air cooled, two-stroke, single cylinder gasoline engine	
Bore	32.2 mm (1.268 in.)	34.0 mm (1.34 in.)
Stroke	26.0 mm (1.04 in.)	
Displacement	21.2 cc (1.29 cu. in.)	23.6 cc (1.44 cu. in.)
Exhaust System	Spark Arrestor Muffler	
Carburetor	Zama diaphragm model C1U w/primer	Walbro WT model w/primer
Ignition System	Flywheel magneto, capacitor discharge	
Spark Plug	NGK BPM-7 Gap 0.65 mm (0.026 in.)	NGK BPM-7Y Gap 0.65 mm (0.026 in.)
Fuel	Mixed (Gasoline and Two-stroke Oil)	
Fuel/Oil Ratio	50:1 ECHO High Performance, two-stroke air cooled engine oil	
Gasoline	89 Octane unleaded. DO NOT use fuel containing methyl alcohol, more than 10% ethyl alcohol or 15% MTBE.	
Oil	50:1 ECHO High Performance, two-stroke air cooled engine oil	
Fuel Tank Capacity	0.4 lit. (13.5 US fl. oz.)	
Starter System	Automatic Rewind Starter	
Clutch	Centrifugal Type	
Drive Shaft	1/4" Flex Shaft	
Rotating Direction	Clockwise viewed from top	
Cutter Head	Nylon line head (2-line) with .080 Line capacity 6.5m (20 ft.)	
Handle	Left - D-Loop, Right - Grip	
Shoulder Harness	Optional P/N 99944200201	Standard
Idle Speed (RPM)	2400 - 3200 RPM	
Wide Open Throttle Speed (W.O.T.) with Nylon Line Head (RPM)	6800 - 7500 RPM	

ASSEMBLY

Tools Required: Locking Tool

PLASTIC SHIELD

1. Snap the shield over the bearing housing.
2. Install bolt (A), washer (B) and wing nut (C).

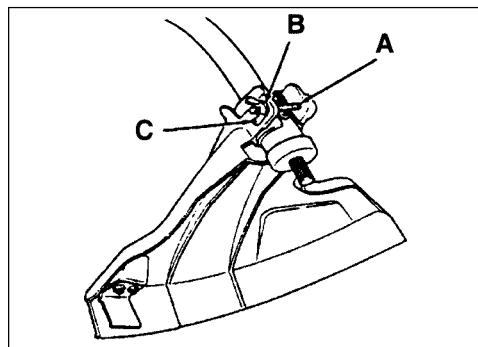

NYLON LINE HEAD

1. Align locating hole in locating plate with hole in bearing housing.
2. Insert 1/8" dia. locking tool (D) (not included with unit) and thread cutting attachment onto shaft clockwise until head is tight.

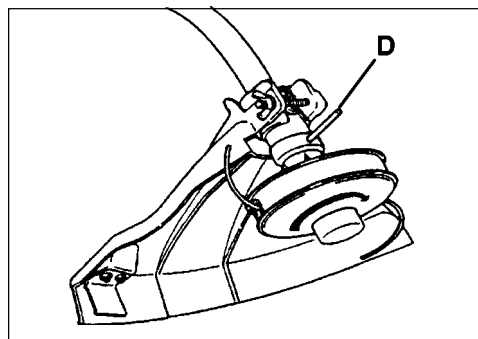

IMPORTANT

Remember to remove the locking tool.

FRONT (LOOP) HANDLE

NOTE

Front handle is pre-installed. Re-positioning and tightening is all that is required.

1. Position front handle (E) in comfortable operating position and tighten wing nut (F). The cutting attachment should be 5-7.5 cm (2-3 in.) above the ground and as level as possible.

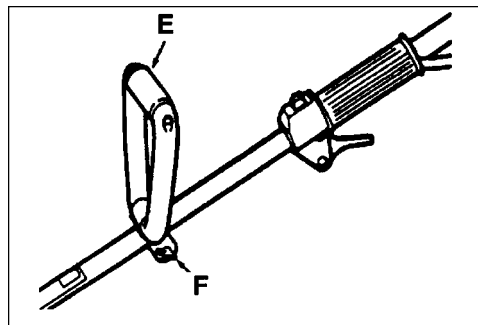

PRE - OPERATION

FUEL

Fuel Requirements

Gasoline - Use 89 Octane $\left[\frac{R+M}{2}\right]$ (mid grade or higher) gasoline known to be good quality. Gasoline may contain up to 15% MTBE (methyl tertiary-butyl ether). Gasohol containing methyl (wood) alcohol is **NOT** approved.

Two Stroke Oil - A two-stroke engine oil meeting ISO-L-EGD Standard (ISO/CD 13738), must be used. Echo brand Premium 50:1 oil meets this standard. Engine problems due to inadequate lubrication caused by failure to use an ISO-L-EGD approved oil, such as Echo Premium 50:1 Two-stroke Oil, will void the two-stroke engine warranty. (Emission related parts only are covered for two years, regardless of two-stroke oil used, per the statement listed in the EPA Phase I/California Emission Defect Warranty Explanation.)

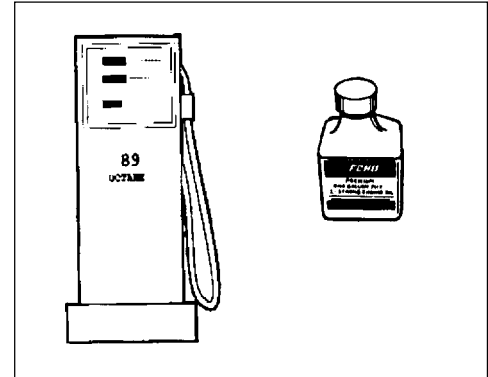

IMPORTANT

Echo Premium 2-Stroke Oil may be mixed at 50:1 ratio for application in all Echo engines sold in the past regardless of ratio specified in those manuals.

Mixing Instructions

1. Fill an approved fuel container with half of the required amount of gasoline.
2. Add 2-stroke oil to gasoline.
3. Close container and shake to mix oil with gasoline.
4. Add remaining gasoline and remix.
5. Install fuel container cap and wipe any spilled fuel from container and surrounding area.

Handling Fuel

WARNING **DANGER**

Fuel is **VERY** flammable. Use extreme care when mixing, storing or handling, or serious personal injury may result.

- Use an approved fuel container.
- **DO NOT** smoke near fuel.
- **DO NOT** allow flames or sparks near fuel.
- Fuel tanks/cans may be under pressure. Always loosen fuel caps slowly allowing pressure to equalize.
- **NEVER** refuel a unit when the engine is **HOT!**
- **NEVER** refuel a unit with the engine running.
- **DO NOT** fill fuel tanks indoors. **ALWAYS** fill fuel tanks outdoors over bare ground.
- Securely tighten fuel cap after refueling.
- Inspect for fuel leakage. If fuel leakage is found, do not start or operate unit until leakage is repaired.



IMPORTANT

Spilled fuel is a leading cause of hydrocarbon emissions. Some states may require the use of automatic fuel shut-off containers to reduce fuel spillage. Contact your ECHO dealer for ordering information.

After refueling;

- Wipe any spilled fuel from the unit.
- Move at least 3 m (10 ft.) from refueling location before starting the engine.

After use;

- DO NOT store a unit with fuel in its tank. Leaks can occur. Return unused fuel to an approved fuel storage container.

Storage -

Fuel storage laws vary by locality. Contact your local government for the laws affecting your area. As a precaution, store fuel in an approved, air tight container. Store in a well ventilated, unoccupied building, away from sparks and flames. Do not store fuel longer than 30 days.

IMPORTANT

Stored fuel ages. Do not mix more fuel than you expect to use in thirty (30) days, ninety (90) days when a fuel stabilizer is added.

IMPORTANT

Stored two-stroke fuel may separate. ALWAYS shake fuel container thoroughly before each use.

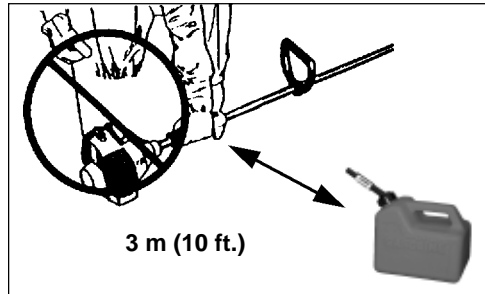

S	M	T	W	T	F	S
1	2	3	4	5	6	7
8	9	10	11	12	13	14
15	16	17	18	19	20	21
22	23	24	25	26	27	28
29	30	31				

EQUIPMENT CHECK

Before operation a complete check of the unit must be performed;

- Check unit for loose/missing nuts, bolts and screws. Tighten and/or replace as needed.
- Inspect fuel lines, tank and area around carburetor for fuel leaks. DO NOT operate unit if leaks are found.
- Inspect shield for damage and **ensure** that the cut-off knife is **securely** in place. Replace if either is damaged or missing.
- Check that the cutting attachment is firmly attached and in safe operating condition.

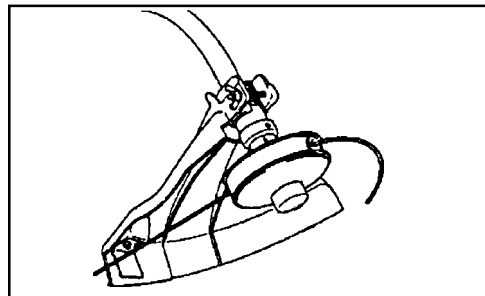
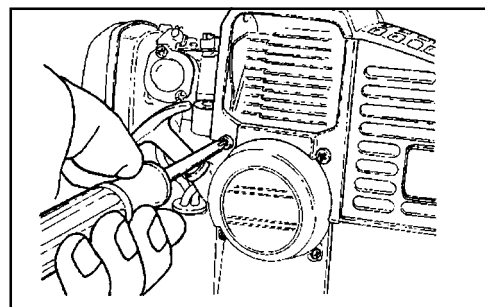

- Check that front (loop) handle and shoulder strap/ or shoulder/waist harness are adjusted for safe, comfortable operation. See Assembly for proper adjustment.
- Have repairs done only by an authorized ECHO Service Dealer.
- Do not use any attachment, accessory or replacement part unless it is recommended in the Operator's Manual.

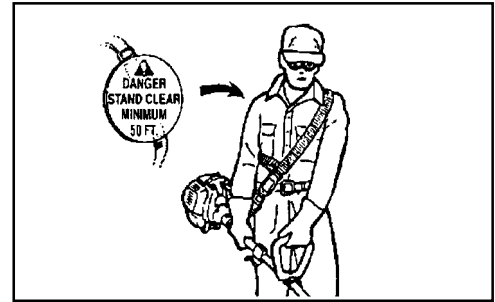

DETERMINE OPERATION AREA

- Review the area to be trimmed. Look for hazards that could contribute to unsafe conditions.
- Spectators and fellow workers must be warned, and children and animals prevented from coming nearer than 15 m (50 ft.) while the trimmer is in use.

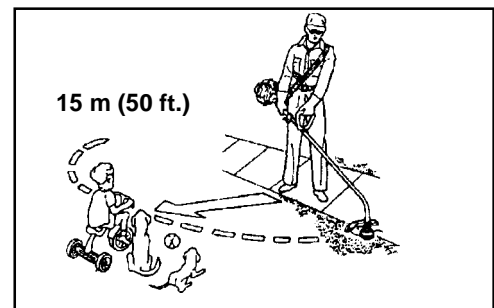

OPERATION

- Provide all operators of this equipment with the Operator's Manual and Instructions for safe use.
- Before starting the unit, equip yourself and any other person working within the 15 m (50 ft.) Safety Zone with the required Protective Equipment and clothing.
- During operation, the complete unit, especially the drive shaft housing and the bearing housing may become very hot, too hot to touch. Avoid contact during and immediately after operation.

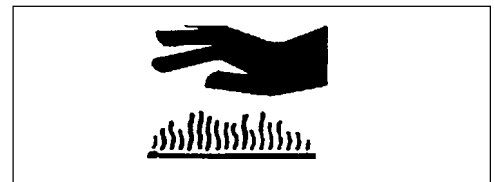
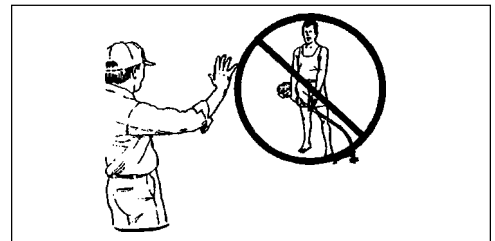

STARTING COLD ENGINE

WARNING DANGER

The cutting attachment should not rotate at idle. If attachment rotates, readjust carburetor according to "Carburetor Adjustment" instructions in this manual or see your ECHO Dealer, otherwise serious personal injury may result.

1. Stop Switch - Start/Run.
Move stop switch button (A) away from the STOP position.
2. Choke Lever - Cold Start.
Move choke (B) to "Cold Start" Position.
3. Primer - Pump Bulb
Pump primer bulb (C) until fuel will be visible and flows freely in the clear fuel tank return line. Pump bulb an additional 4 or 5 times.

WARNING DANGER

Inspect starting area for hazards such as rocks, glass, debris etc. which could be thrown by the cutting attachment when starting. Keep helpers and bystanders at least 15m (50 feet) from starting area, otherwise serious personal injury may result.

4. Lay the trimmer on a flat clear area. Firmly grasp throttle grip with left hand and fully depress throttle trigger to wide open position. Rapidly pull starter handle/rope (D) until engine fires (maximum five [5] pulls).
5. After engine fires or five (5) pulls, move choke lever back to "Run" position. Hold throttle trigger fully depressed and pull starter handle/rope until engine starts and runs. Release throttle trigger and allow unit to warm up at idle for several minutes.

NOTE

If engine does not start with choke in "Run" position after 5 pulls, repeat instructions.

6. After engine warm up, gradually depress throttle trigger to increase engine RPM to operating speed.

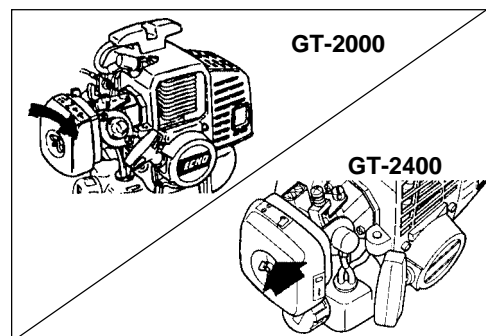
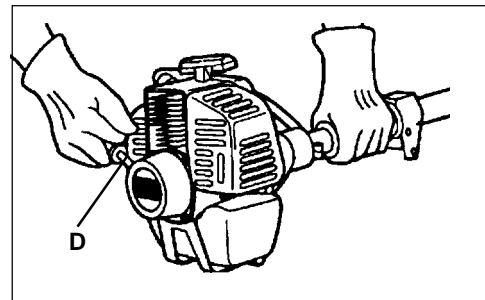
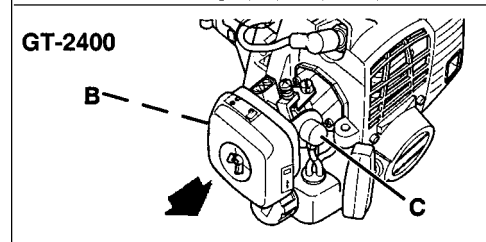
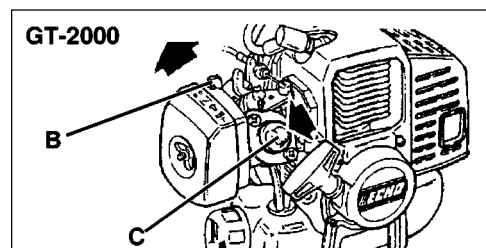
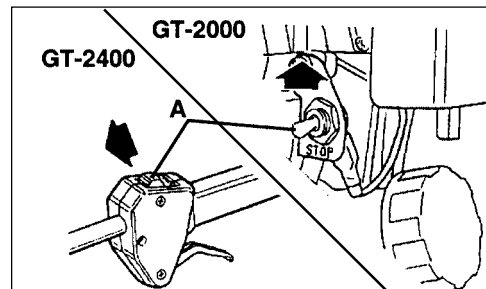

STARTING WARM ENGINE

WARNING DANGER

The cutting attachment should not rotate at idle. If attachment rotates, readjust carburetor according to "Carburetor Adjustment" instructions in this manual or see your ECHO Dealer, otherwise serious personal injury may result.

1. Stop Switch - Start/Run. Move stop switch button (A) away from the STOP position.
2. Start - Pull Rope. Lay the trimmer on a flat clear area and pull the starter handle (D) until the engine fires.

NOTE

If engine does not start after 5 pulls, use Cold Start Procedure.

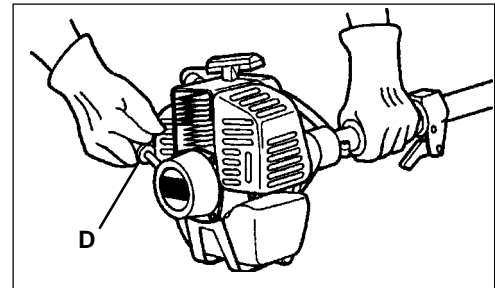
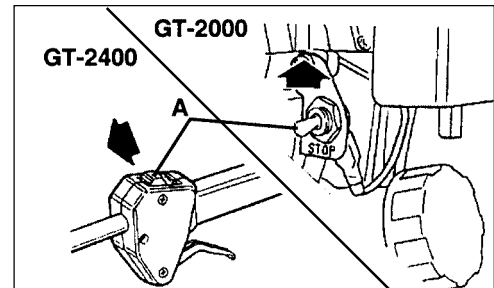

STOPPING ENGINE

1. Release Throttle. Allow engine to idle for a minute.
2. Stop Switch - Stop. Move stop switch button (A) backward to STOP position.

WARNING DANGER

If engine does not stop when stop switch is moved to STOP position, close choke - COLD START position - to stall engine. Have your ECHO dealer repair stop switch before using trimmer again.

NOTE

Refer to the Grass Trimmer / Brush Cutter Safety Manual for proper and safe trimming techniques.

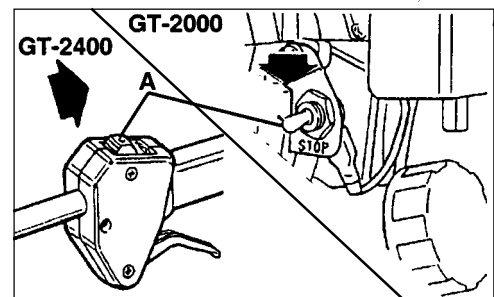

MAINTENANCE

WARNING DANGER

Do not perform maintenance on engine or muffler until engine and muffler are completely cool, otherwise serious personal injury may result.

Your ECHO trimmer is designed to provide many hours of trouble free service. Regular scheduled maintenance will help your trimmer achieve that goal. If you are unsure or are not equipped with the necessary tools, you may want to take your unit to an ECHO Service Dealer for maintenance. To help you decide whether you want to DO-IT-YOURSELF or have the ECHO Dealer do it, each maintenance task has been graded. If the task is not listed see your Echo dealer for repairs.

SKILL LEVEL

- Level 1** = Easy to do. Most required tools come with unit.
- Level 2** = Moderate difficulty. Some specialized tools may be required.
- Level 3** = Experience required. Specialized tools are required. ECHO recommends that the unit be returned to your ECHO dealer for servicing.

ECHO offers **REPOWER™** Maintenance Kits and Parts to make your maintenance job easier. Just below each task heading are listed the various part numbers required for that task. See your ECHO dealer for these parts.

MAINTENANCE INTERVALS

Component/System	Maintenance Procedure	Daily or Before Use	Every Refuel	3 Months or 90 Hours	6 Months or 270 Hours	Yearly
Air Filter	Inspect / Replace	I / C		R *		
Fuel Strainer	Inspect / Replace			I		R
Fuel Line	Inspect / Replace	I	I			
Carburetor	Inspect / Clean / Replace				I / C	R (1)
Choke System	Inspect / Clean / Replace	I / C				
Cooling System	Inspect / Clean	I / C				
Muffler Spark Arrestor	Inspect / Clean			I / C		
Drive Shaft (Flex Cable Models)	Grease			I (2)		
Gear Housing	Grease			I		
Starter Rope	Inspect / Clean	I				
Fuel Leaks	Inspect / Repair	I	I			
Spark Plug	Clean / Replace			I / C	R *	
Screws/Nuts/Bolts	Inspect / Tighten / Replace	I				

I = Inspect / R = Replace / C = Clean

IMPORTANT

Time intervals shown are maximum. Actual use and your experience will determine the frequency of required maintenance.

(1) Replacement will be required for commercial use yearly. For Consumer use, cleaning every 6 months is required. Cleaning includes Rebuild Kits.

(2) Apply ECHO® LUBE™ every 25 hours of use.

*All recommendations to replace are based on the finding of damage or wear during inspection.

AIR FILTER

Level 1.

Tools required: Cleaning brush, 25 or 50 mm (1 or 2 in.) medium bristle paint brush.

Parts required: 90008 REPOWER™ AIR & FUEL FILTER KIT.

1. Close choke (Cold Start Position). This prevents dirt from entering the carburetor throat when the air filter is removed. Brush accumulated dirt from the air cleaner area.
2. Remove the air cleaner cover. Clean and inspect the element for damage. If element is fuel soaked and very dirty, replace.
3. If element can be cleaned and reused, be certain it:
 - still fits the cavity in the air cleaner cover.
 - is installed with the original side out.

NOTE

Carburetor adjustment may be needed after air filter cleaning/replacement. See Carburetor Adjustment Section.

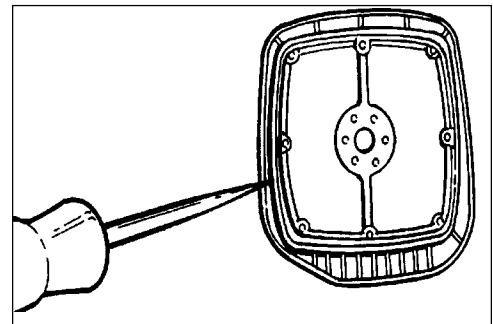
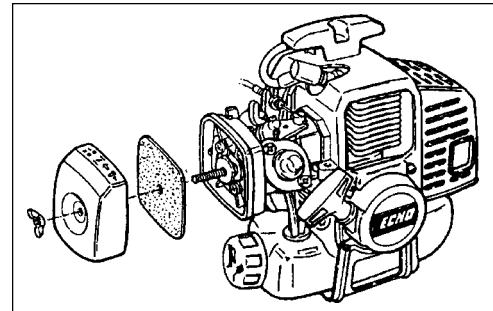
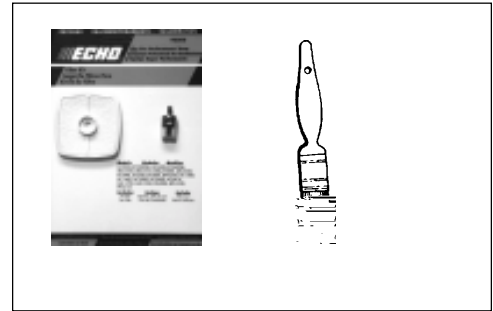

FUEL FILTER

Level 1.

Tools required: Fuel line hook, 203-254 mm (8-10 in.) length of wire with one end bent into a hook. Clean rag, funnel, and an approved fuel container.

Parts required: 90008 REPOWER™ AIR & FUEL FILTER KIT

WARNING DANGER

Fuel is **VERY** flammable. Use extreme care when mixing, storing or handling.

1. Use a clean rag to remove loose dirt from around fuel cap and empty fuel tank.
2. Use the “fuel line hook” to pull the fuel line and filter from the tank.
3. Remove the filter from the line and install the new filter.

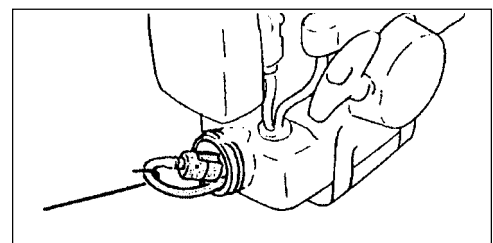

SPARK PLUG

Level 2.

Tools Required: Spark Plug socket wrench and screw driver, Feeler gauge, preferably a wire gauge.

Parts Required: 90064REPOWER™ TUNE-UP KIT

1. Remove spark plug and check for fouling, worn and rounded center electrode.
2. Clean the plug or replace with a new one. DO NOT sand blast to clean. Remaining sand will damage engine.
3. Adjust spark plug gap by bending outer electrode.
4. Tighten spark plug to 145-155 kg/cm (125-135 in. lb.).

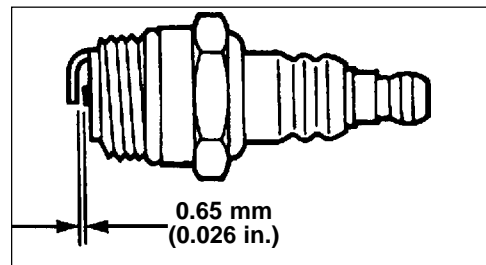
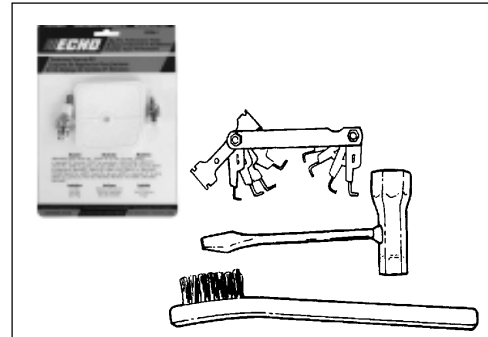

COOLING SYSTEMS CLEANING

Level 2.

Tools required: Cross Head Screwdriver, 3 mm Hexagon wrench, Pointed Wood Stick, Cleaning Brush, 25-50 mm (1-2 in.) medium bristle paint brush.

Parts Required: None.

IMPORTANT

To maintain proper engine operating temperatures, cooling air must pass freely through the cylinder fin area. This flow of air carries combustion heat away from the engine.

Overheating and engine seizure can occur when:

- Air intakes are blocked, preventing cooling air from reaching the cylinder.
- Dust and grass build up on the outside of the cylinder. This build up insulates the engine and prevents the heat from leaving.

Removal of cooling passage blockages or cleaning of cooling fins is considered "Normal Maintenance". Any failure attributed to lack of maintenance is not warranted.

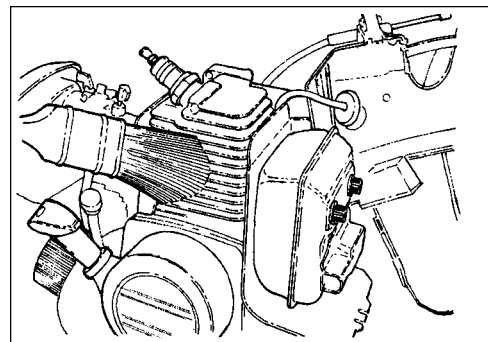
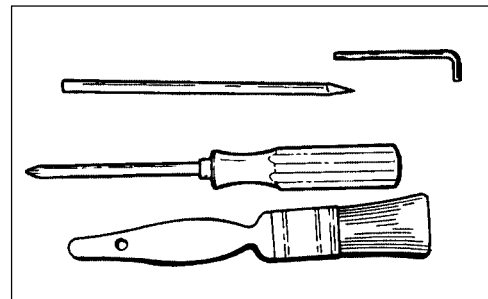

1. Remove spark plug lead and throttle linkage end from the carburetor swivel.
2. Remove the four screws that retain the cover. Two at the top of the Recoil Starter, two on either side of the front. Lift the cover from the

CARBURETOR ADJUSTMENT

Emission Models (with limiter caps)

Level 2.

Tools required: Screwdriver, Tachometer (ECHO P/N 99051130017).

Parts required: None.

NOTE

Every unit is run at the factory and the carburetor is set in compliance with EPA Phase 1 and California Emission Regulations. In addition, the carburetor is equipped with HI and LO needle adjustment limiters that prevent settings outside acceptable limits.

1. Before adjusting the carburetor, clean or replace the air filter and spark arrester screen.
2. The trimmer line should be extended to the cut-off knife.
3. Start engine and run for several minutes to reach operating temperature.
4. Stop engine. Turn HI speed needle (A) CCW (counter clockwise) to stop. Turn LO speed needle (B) midway between full CCW and CW (clockwise) stops.
5. Idle Speed Adjustment.
 - Start engine and turn "idle" speed adjustment screw (C) CW until the blades begin to turn, then turn the screw CCW until blades stop turning. Turn screw CCW an additional 1/4 turn.
6. Accelerate to full throttle for 2-3 seconds to clear excess fuel from engine then return to idle. Accelerate to full throttle to check for smooth transition from idle to full throttle. If engine hesitates, turn LO needle (B) CCW an additional 1/8 turn and repeat acceleration. Continue adjusting until smooth acceleration results.
7. Check HI speed RPM at W.O.T. (Wide Open Throttle). HI speed RPM should be set to specifications found on page 11 "Specifications" of this manual.
8. Check idle speed and reset if necessary. If a tachometer is available, idle speed should be set to the specification found on page 11 "Specifications" of this manual.

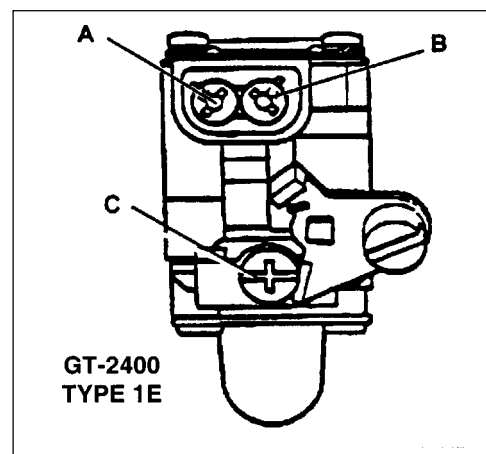
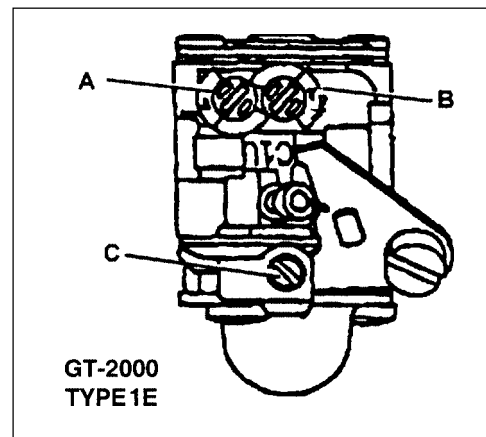
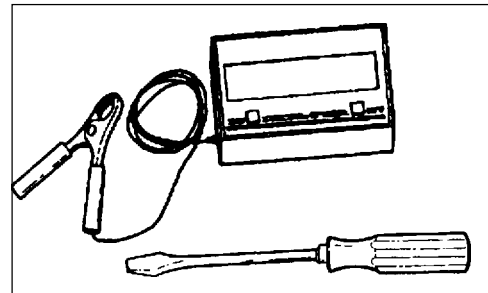

WARNING DANGER

When carburetor adjustment is completed, the cutting attachment should not turn at idle, otherwise serious personal injury may result.



CARBURETOR ADJUSTMENT

Non Emission Models (without limiter caps)

Level 2.

Tools required: Screwdriver, Tachometer (ECHO P/N 99051130017).

NOTE

If carburetor has limiter caps follow "Carburetor Adjustment" procedures for Type 1E models on previous page.

Idle Speed Adjustment

Turn "idle" speed adjustment screw (C) CW (clockwise) until cutting attachment begins to turn, then turn screw out CCW (counter clockwise) until attachment stops turning. Turn screw out, CCW an additional 1/4 turn.

WARNING DANGER

Cutting attachment must not turn when unit is idling, otherwise serious personal injury may result.

Basic Setting

1. Stop engine and turn both LO (B) and HI (A) needles in, CW until they stop and are lightly seated.

IMPORTANT

DO NOT over tighten needles. Forcing them to tighten will damage the carburetor.

2. Turn LO needle (B) out, CCW 1-1/4 turns. Turn HI needle (A) out CCW 2-3/4 turns.

Fine Tuning

(Requires Accurate Tachometer ECHO P/N 99051130017)

1. Start engine and allow to warm to operating temperature (minimum 2-3 minutes) varying engine speed from idle to full throttle.
2. Always begin fine tuning with LO needle.
 - a. Lean drop-off - With engine idling, turn LO (B) needle slowly CW (in) to lean drop-off point. RPM will increase, then abruptly drop-off. (1) Note this position.
 - b. Rich drop-off - With engine idling, slowly turn LO (B) needle CCW (out) to rich drop-off point. RPM will increase then gradually slow and drop-off. (2) Note this position.
 - c. Final setting - Set needle at mid point between lean rich drop-off points. (3)
 - d. Turn 1/8 turn CCW (out) making mixture slightly richer. (4)
3. High speed adjustment.
Adjust HI needle (A) with tachometer to achieve the specifications found on page 11 "Specifications" of this manual.
4. Check idle speed and reset if necessary. Using a tachometer, idle speed should be set to the specification found on page 11 "Specifications" of this manual.

WARNING DANGER

When carburetor adjustment is completed, the cutting attachment should not turn at idle, otherwise serious personal injury may result.

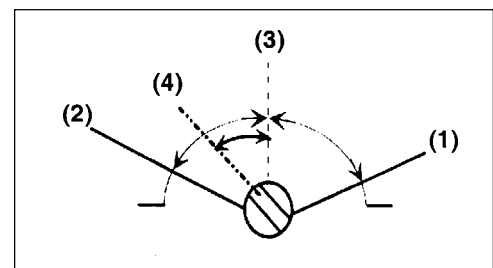
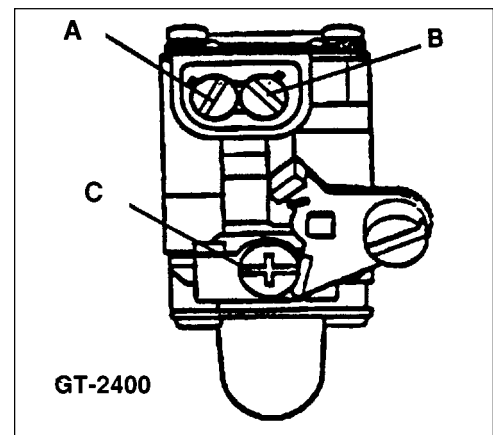
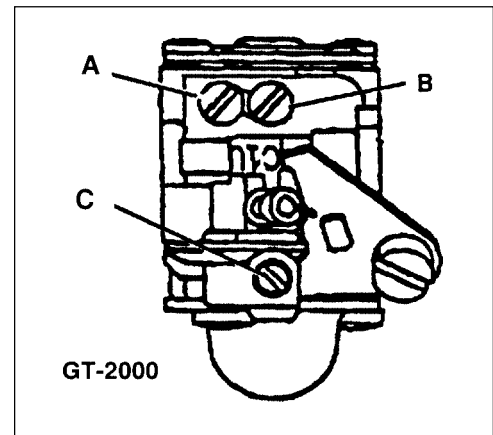

LUBRICATION

Level 1.

Tools Required: 8mm Open End Wrench, Screwdriver, Clean Rag.

Parts Required: ECHO® LUBE™ 8 oz. (P/N 91014) or Lithium Base Grease.

1. Remove plastic shield.
2. Loosen bearing housing locating screw (A), at the top of the housing, remove mounting screw (B).
3. Pull the flexible drive shaft (C) from the housing, wipe clean and recoat with a thin coating [1/2 oz. (15 ml)] of grease.
4. Slide the flexible drive shaft back in the drive housing being careful not to get dirt on the flexible drive shaft.
5. Install the bearing housing and shield.

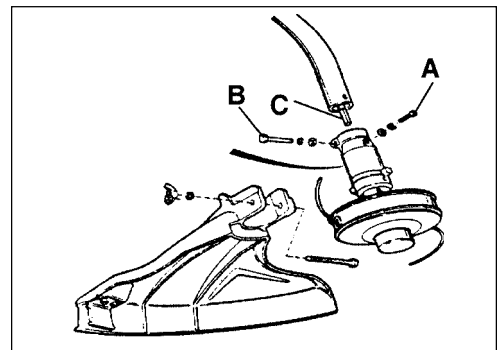
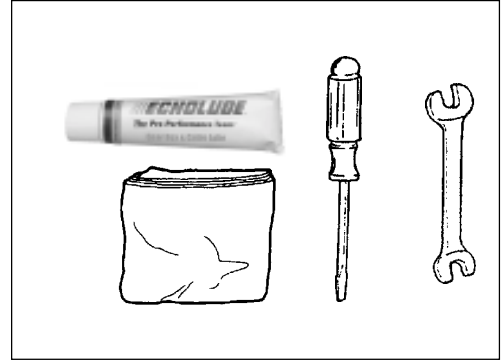

NYLON LINE REPLACEMENT

(GT-2000 Only)

Level 1.

Tools Required: Head locking tool - 1/8" dia. Rod (if head is to be removed)

Parts Required: ECHO 0.080 (2mm) Nylon Trimmer Line 4.6m (15 feet)

1. Shut engine off. Lay unit on the ground with head assembly up.
2. Hold head firmly, push in housing tab and turn cover counter clockwise to remove cover and spool.
3. Cut .080" line to 4.6 m (15 feet) length. Thread line through hole (A) in spool spindle until one end is 4" longer than the other end.
4. Hold spool with words "WIND LINE" and tap knob towards you. Place index finger between the two lines and wind line clockwise tightly and evenly.

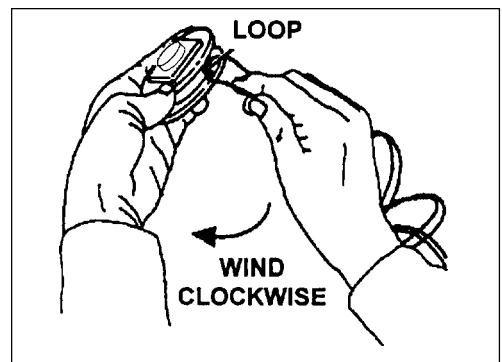
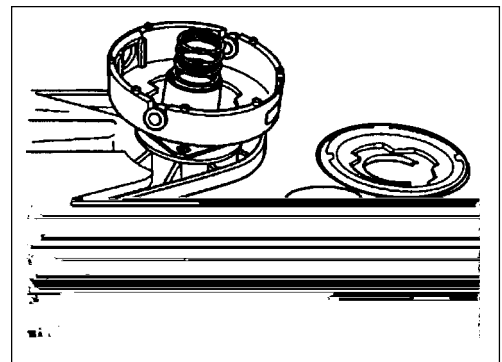

- Place ends of line in the two notches (B) molded in the spool with 12.5 to 15.2 cm (5 to 6 in.) protruding.

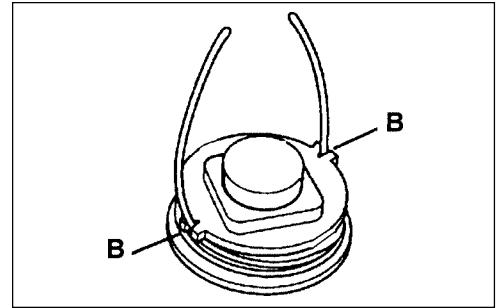

- Place spool in housing against spring; thread line ends through housing eyelets (C)

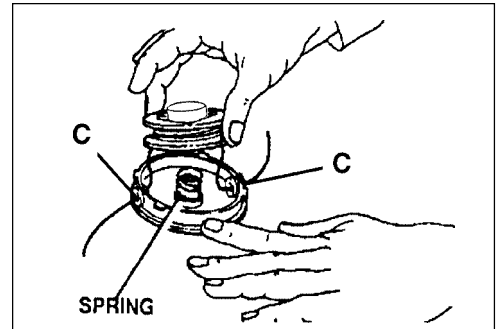

- Align cover arrow with housing tab; push down on cover and twist clockwise until cover locks in place.

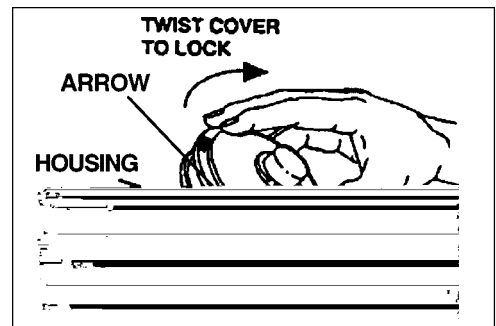

- Pull both lines out and trim to cut-off knife length.

Before installing, test head. Push center button while pulling on both lines. Trimmer line should advance approximately 1 (one) inch.

NYLON LINE REPLACEMENT (GT-2400 Only)

Level 1.

Tools Required: Head locking tool - 1/8 in. dia. Rod (if head is to be removed)

Parts Required: ECHO 2mm (0.080) Nylon Trimmer Line 6m (20 feet)

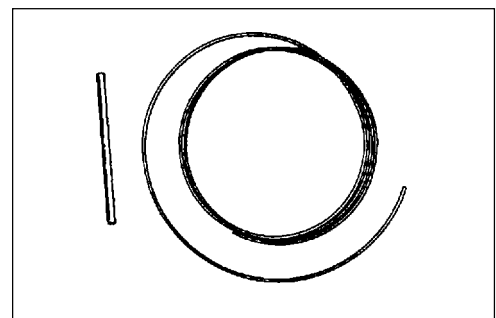

- Press tab and twist cover CCW (counter clockwise) to align arrows and remove cover. Lift spool from housing.

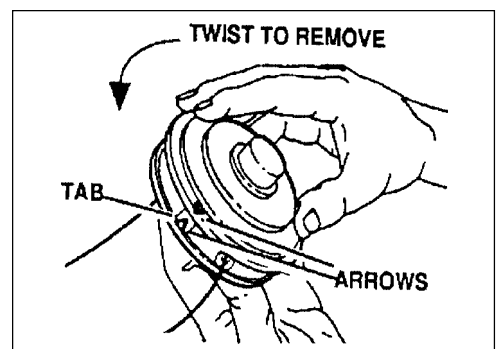

2. Use one piece of new nylon line 6m (20 ft.) long and thread through the molded loop on the spool. Pull line tight and adjust so one end is 15cm (6 in.) longer than the other.
3. Hold spool with words "THIS SIDE UP" facing you. Place index finger between the strands and wind line clockwise (follow direction of arrow molded in spool), tightly and evenly.

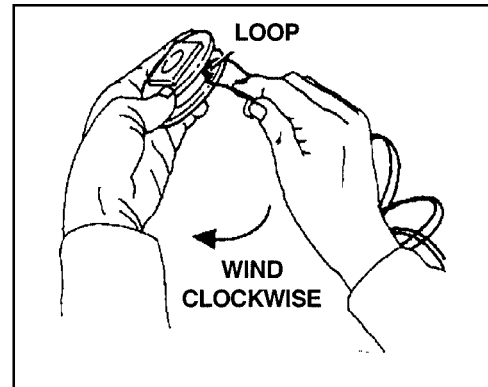

4. Place ends of line in the two notches molded in the spool with 12.5 to 15.2 cm (5 to 6 in.) protruding.
5. Feed ends of line out housing eyelets and place spool over spring.

Be sure spool is installed correctly with the words "THIS SIDE UP."

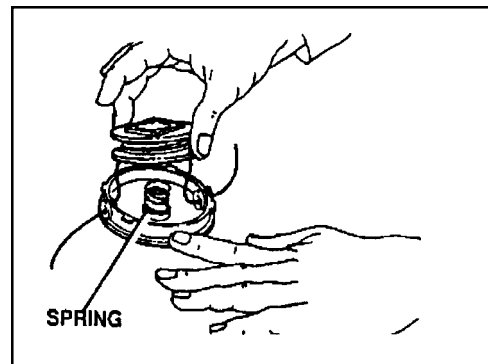

6. Align arrows, and push down on cover and twist cover clockwise until tab locks cover in place.
7. Pull both lines out and trim to cut-off knife length.

Before installing, test head. Push center button while pulling on both lines. Trimmer line should advance approximately 1 (one) inch.

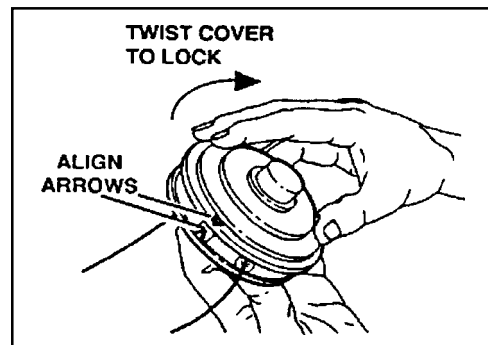

TROUBLESHOOTING

Problem				
Engine -- starts hard				
Engine -- does not start			Cause	Remedy
Engine Cranks	Fuel at carburetor	No fuel at carburetor	Fuel strainer clogged Fuel line clogged Carburetor	Clean Clean See your ECHO dealer
	Fuel at cylinder	No fuel at cylinder	Carburetor	See your ECHO dealer
		Muffler wet with fuel	Fuel Mixture is too rich	Open choke Clean/replace air filter Adjust carburetor See your ECHO dealer
	Spark at end of plug wire	No spark at end of plug wire	Stop switch off Electrical problem	Turn switch on See your ECHO dealer
	Spark at plug	No spark at plug	Spark gap incorrect Covered with carbon Fouled with fuel Spark plug defective	Adjust 0.65mm (0.026in.) Clean or replace Clean or replace Replace plug
Engine does not crank			Internal engine problem	See your ECHO dealer
Engine runs	Dies or accelerates poorly		Air filter dirty Fuel filter dirty Fuel vent plugged Spark plug Carburetor Cooling system plugged Spark arrestor screen plugged	Clean or replace Replace Replace Clean and adjust/replace Adjust Clean Clean

WARNING DANGER

Fuel vapors are **extremely** flammable and may cause fire and/or explosion. **Never** test for ignition spark near an open spark plug opening, otherwise serious personal injury may result.

STORAGE

Long Term Storage (over 30 days)

WARNING DANGER

During operation the muffler or catalytic muffler and surrounding cover become hot. Always keep exhaust area clear of flammable debris during transportation or when storing, otherwise serious property damage or personal injury may result.

Do not store your unit for a prolonged period of time (30 days or longer) without performing protective storage maintenance which includes the following:

1. Store unit in a dry, dust free place, out of the reach of children.

WARNING DANGER

Do not store in enclosure where fuel fumes may accumulate or reach an open flame or spark.

2. Place the stop switch in the "OFF" position.
3. Remove accumulation of grease, oil, dirt and debris from exterior of unit.
4. Perform all periodic lubrication and services that are required.
5. Tighten all the screws and nuts.
6. **Drain** the fuel tank **completely** and pull the recoil starter handle several times to remove fuel from the carburetor.
7. Remove the spark plug and pour 1/4 oz. (1/2 tablespoon) of fresh, clean, two-stroke engine oil into the cylinder through the spark plug hole.
 - A. Place a clean cloth over the spark plug hole.
 - B. Pull the recoil starter handle 2-3 times to distribute the oil inside the engine.
 - C. Observe the piston location through the spark plug hole. Pull the recoil starter handle slowly until the piston reaches the top of it's travel and leave it there.
8. Install the spark plug (do not connect spark plug cable).

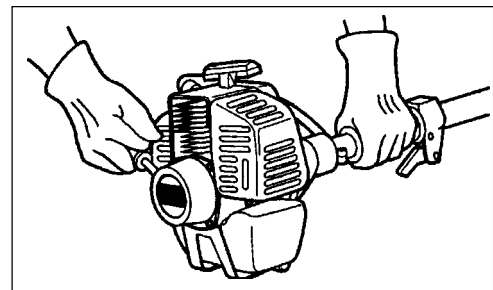
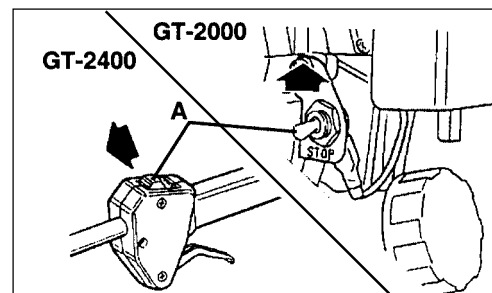

NOTES

NOTES

NOTES

SERVICING INFORMATION

PARTS

Genuine ECHO Parts and ECHO REPOWER™ Parts and Assemblies for your ECHO products are available only from an Authorized ECHO Dealer. When you do need to buy parts **always** have the Model Number, Type and Serial Number of the unit with you. You can find these numbers on the engine housing. For future reference, write them in the space provided below.

Model No. _____ Type _____ SN. _____

SERVICE

Service of this product during the warranty period must be performed by an Authorized ECHO Service Dealer. For the name and address of the Authorized ECHO Service Dealer nearest you, ask your retailer or call: 1-800-432-ECHO (3246). Dealer information is also available on our Web Site. When presenting your unit for Warranty service/repairs, proof of purchase is required.

ECHO CONSUMER PRODUCT SUPPORT

If you require assistance or have questions concerning the application, operation or maintenance of this product you may call the ECHO Consumer Product Support Department at 1-800-673-1558 from 8:00 am to 5:00 pm (Central Standard Time) Monday through Friday. Before calling, please know the model and serial number of your unit to help your Consumer Product Support Representative.

WARRANTY REGISTRATION

You may register your Echo equipment using the warranty registration card or register on-line at www.echo-usa.com. Registering provides a direct link between you and ECHO if we find it necessary to contact you.

ADDITIONAL OR REPLACEMENT MANUALS

Safety Manuals in English/Spanish or English/French are available, free of charge, from your ECHO dealer or at www.echo-usa.com.

Operator's and Parts Manuals are available by:

- Downloading free from www.echo-usa.com
- Purchasing from your Echo Dealer.
- Sending a check or money order for \$2.00 per Parts Catalog or \$1.50 per Operator's Manual made payable to ECHO, INCORPORATED. State on a sheet of paper the model number and serial number of the ECHO unit you have, part number of the manual (if known), your name and address and mail to address below.

Safety Videos are available from your Echo dealer. A \$5.00 shipping charge will be required for each video.

Available Parts Catalog

GT-2000 Type 1E
GT-2400 Type 1E

S/N 001001 UP
S/N 001001 UP

Part Number 99922202768
Part Number 99922202769

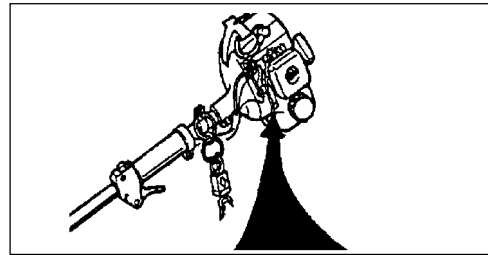

DEALER?

Call
1-800-432-ECHO
or
www.echo-usa.com

CONSUMER PRODUCT SUPPORT

1-800-673-1558
8 - 5 Mon - Fri C.S.T.

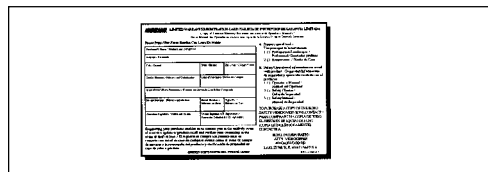

ECHO
ECHO, INCORPORATED
400 OAKWOOD ROAD
LAKE ZURICH, IL 60047-1564
www.echo-usa.com

Free Manuals Download Website

<http://myh66.com>

<http://usermanuals.us>

<http://www.somanuals.com>

<http://www.4manuals.cc>

<http://www.manual-lib.com>

<http://www.404manual.com>

<http://www.luxmanual.com>

<http://aubethermostatmanual.com>

Golf course search by state

<http://golfingnear.com>

Email search by domain

<http://emailbydomain.com>

Auto manuals search

<http://auto.somanuals.com>

TV manuals search

<http://tv.somanuals.com>