



Grass Trimmer

Operator's Manual

MODELS

GT-201

Serial Number 002001001 & Up

WARNING  **DANGER**



The muffler or catalytic muffler and surrounding cover may become extremely hot.

Always keep clear of exhaust and muffler area, otherwise serious personal injury may occur.

 **WARNING** 

The engine exhaust from this product contains chemicals known to the State of California to cause cancer, birth defects or other reproductive harm.



WARNING  **DANGER**

Read rules for safe operation and instructions carefully. ECHO provides an Operator's Manual and a Safety Manual. Both must be read and understood for proper and safe operation.

X7702272300

X770000170
06/00

INTRODUCTION

Welcome to the ECHO family. This ECHO product was designed and manufactured to provide long life and on-the-job-dependability. Read and understand this manual and the SAFETY MANUAL you found in the same package. You will find both easy to use and full of helpful operations tips and SAFETY messages.

WARNING DANGER

Read rules for safe operation and instructions carefully. ECHO provides an Operator's Manual and a Safety Manual. Both must be read and understood for proper and safe operation.

THE OPERATOR'S MANUAL

contains specifications and information for operation, starting, stopping, maintenance, storage and assembly specific to this product.

THE SAFETY MANUAL

explains possible hazards involved with the use of Grass Trimmers and Brush cutters and what measures you should take to make their use safer.



TABLE OF CONTENTS

Introduction	2	- Stopping Engine	18
Manual Safety Symbols and Important Information	3	Maintenance	18
Safety	3	- Skill Level	18
- Decals	3	- Maintenance Intervals	19
- International Symbols	4	- Air filter	20
- Equipment	4	- Fuel filter	20
- Fuel	5	- Spark plug	21
- Personal Conditions and Safety Equipment	6	- Cooling System	21
- Safe Operation	7	- Exhaust System	22
- Extended Operation/Extreme Conditions	8	- Carburetor Adjustment	23
Description	9	- Lubrication	24
- Emission Control	9	- Nylon Line Replacement	24
- Contents List	9	Troubleshooting	26
Specifications	12	Storage	27
Assembly	13	Servicing Information	28
- Plastic Shield	13	- Parts	28
- Nylon Head	13	- Service	28
- Front (Loop) Handle	13	- ECHO Consumer Product Support	28
Pre-Operation	14	- Warranty Card	28
- Fuel	14	- Additional or Replacement Manuals	28
- Equipment Check	15	- Ordering Instructions for Manuals	28
- Determine Operation Area	16		
Operation	16		
- Starting Cold Engine	16		
- Starting Warm Engine	17		

Specifications, descriptions and illustrative material in this literature are as accurate as known at the time of publication, but are subject to change without notice. Illustrations may include optional equipment and accessories, and may not include all standard equipment.

MANUAL SAFETY SYMBOLS AND IMPORTANT INFORMATION

Throughout this manual and on the product itself, you will find safety alerts and helpful, information messages preceded by symbols or key words. The following is an explanation of those symbols and key words and what they mean to you.



This symbol accompanied by the words **WARNING** and **DANGER** calls attention to an act or condition that can lead to serious personal injury to operator and bystanders.



The circle with the slash symbol means whatever is shown within the circle is prohibited.



IMPORTANT The enclosed message provides information necessary for the protection of the unit.

NOTE This enclosed message provides tips for use, care and maintenance of the unit.

SAFETY DECALS

Locate these safety decals on your unit. The complete unit illustration found in the "DESCRIPTION" section, will help you locate them. Make sure the decals are legible and that you understand and follow the instructions on them. If a decal cannot be read, a new one can be ordered from your ECHO dealer. See PARTS ORDERING instructions for specific information.

A. DRIVESHAFT



B. SPANISH DECAL



ENGLISH TRANSLATION

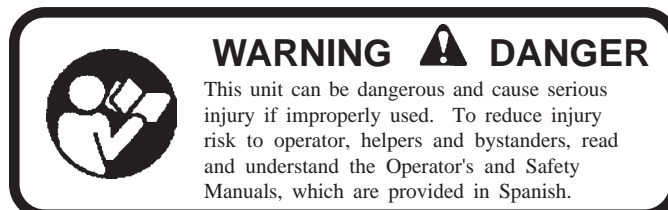

C. SHIELD DECAL



INTERNATIONAL SYMBOLS

SYMBOL FORM/ SHAPE	SYMBOL DESCRIPTION/APPLICATION	SYMBOL FORM/ SHAPE	SYMBOL DESCRIPTION/APPLICATION
	Read and understand Operator's Manual.		FUEL AND OIL MIXTURE
	WEAR EYES, EARS AND HEAD PROTECTION		FINGER SEVERING
	HOT SURFACE		WEAR SLIP RESISTANT FOOT WEAR.
	WEAR HAND AND FOOT PROTECTION		DO NOT SMOKE NEAR FUEL.
	SAFETY/ALERT		
			KEEP BYSTANDERS AND HELPERS AWAY 15 M (50 FT.).

SYMBOL FORM/ SHAPE	SYMBOL DESCRIPTION/APPLICATION	SYMBOL FORM/ SHAPE	SYMBOL DESCRIPTION/APPLICATION
	DO NOT ALLOW FLAMES OR SPARKS NEAR FUEL.		EMERGENCY STOP
	Engine choke control.		IGNITION ON/OFF
	PRIMER BULB		CARBURETOR ADJUSTMENT - HIGH SPEED MIXTURE
	DO NOT EXCEED 10,000 RPM.		CARBURETOR ADJUSTMENT - LOW SPEED MIXTURE
	DO NOT OPERATE WITHOUT GUARDS AND SHIELDS IN PLACE.		CARBURETOR ADJUSTMENT - IDLE SPEED
	DO NOT USE BLADES, STRING LINE ONLY		BEWARE - THROWN, RICOCHET OBJECTS

EQUIPMENT

Before operation a complete check of the unit must be performed;

- Check unit for loose/missing nuts, bolts and screws. Tighten and/or replace as needed.
- Inspect fuel lines, tank and area around carburetor for fuel leaks. DO NOT operate unit if leaks are found.
- Inspect shield for damage and ensure that the cut-off knife is securely in place. Replace if either is damaged or missing.
- Check that the cutting attachment is firmly attached and in safe operating condition.
- Check that front (loop) handle and/or optional shoulder harness are adjusted for safe, comfortable operation. See Assembly for proper adjustment.
- Have repairs done only by an authorized ECHO Service Dealer.
- Do not use any attachment, accessory or replacement part unless it is recommended in the Operator's Manual.

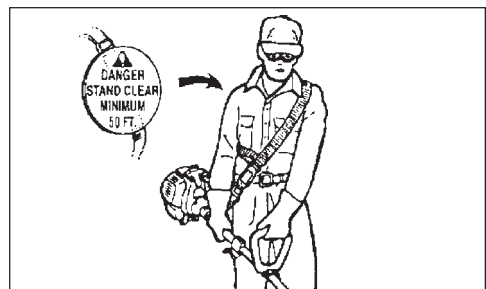
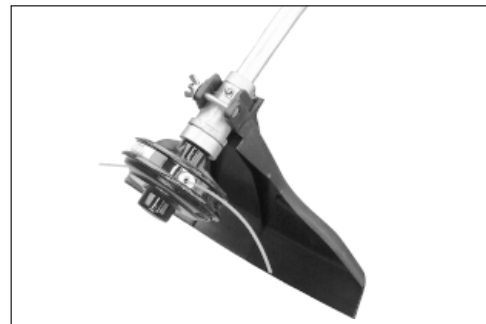

Spark Arrestor - Catalytic Muffler/Muffler

- The muffler or catalytic muffler controls the exhaust noise and emissions. The spark arrestor screen prevents hot, glowing particles of carbon from leaving the muffler. Make sure the spark arrestor screen is in good repair and properly seated in the muffler. Keep exhaust area clear of flammable debris. Avoid contact during and immediately after operation.

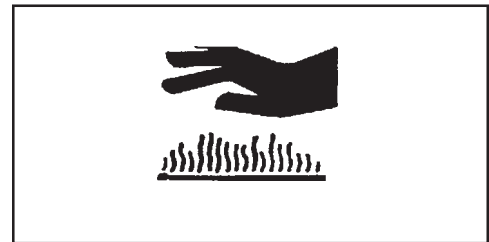

FUEL

WARNING  **DANGER**

Fuel is **VERY** flammable. Use extreme care when mixing, storing or handling, otherwise serious personal injury may result.

- Use an approved fuel container.
- **DO NOT** smoke near fuel.
- **DO NOT** allow flames or sparks near fuel.
- Fuel tanks/cans may be under pressure. Always loosen fuel caps slowly allowing pressure to equalize.
- **NEVER** refuel a unit when the engine is **HOT!**
- **NEVER** refuel a unit with the engine running.
- **DO NOT** fill fuel tanks indoors. **ALWAYS** fill fuel tanks outdoors over bare ground.
- Securely tighten fuel cap after refueling.
- Inspect for fuel leakage. If fuel leakage is found, do not start or operate unit until leakage is repaired.



IMPORTANT

Spilled fuel is a leading cause of hydrocarbon emissions. Some states may require the use of automatic fuel shut-off containers to reduce fuel spillage. Contact your ECHO dealer for ordering information.



After Refueling;

- Wipe any spilled fuel from the unit.
- Move at least 3 M (10 ft.) from refueling location before starting.

After Use;

- **DO NOT** store a unit with fuel in its tank. Leaks can occur. Return unused fuel to an approved fuel storage container.

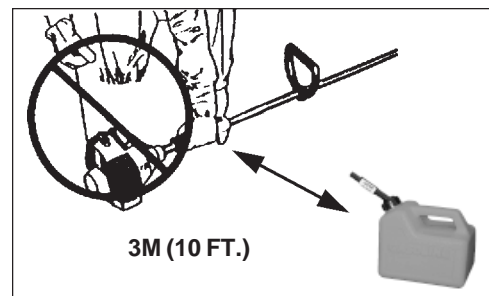

PERSONAL CONDITION AND SAFETY EQUIPMENT

WARNING DANGER

Trimmer/Brush Cutter users risk injury to themselves and others if the trimmer/brush cutter is used improperly and or safety precautions are not followed. Proper clothing and safety gear must be worn when operating a trimmer.

Physical Condition --

Your judgment and physical dexterity may not be good:

- if you are tired or sick,
- if you are taking medication,
- if you have taken alcohol or drugs.

Operate unit only if you are physically and mentally well.

Eye Protection --

Wear eye protection that meets ANSI Z87.1 or CE requirements whenever you operate the trimmer.

Hand Protection --

Wear no-slip, heavy duty work gloves to improve your grip on the Trimmer/Brush Cutter handles. Gloves also reduce the transmission of machine vibration to your hands.

Hearing Protection --

ECHO recommends wearing hearing protection whenever unit is used.

Proper Clothing --

Wear snug fitting, durable clothing;

- Pants should have long legs, shirts with long sleeves.
- DONOT WEAR SHORTS,
- DONOT WEAR TIES, SCARVES, JEWELRY.

Wear sturdy work shoes with non-skid soles;

- DONOT WEAR OPEN TOED SHOES,
- DONOT OPERATE UNIT BAREFOOTED.

Hot Humid Weather --

Heavy protective clothing can increase operator fatigue which may lead to heat stroke. Schedule heavy work for early morning or late afternoon hours when temperatures are cooler.

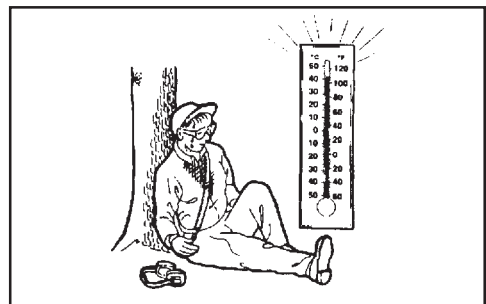
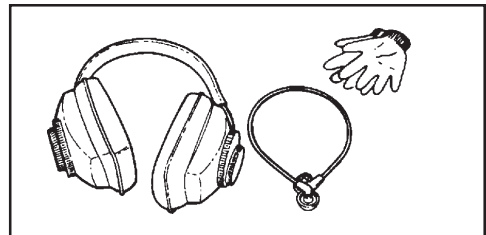
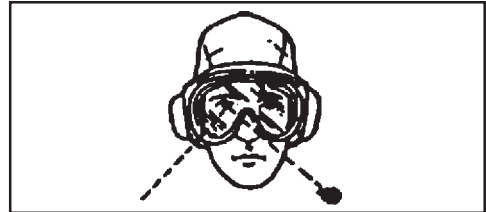

SAFE OPERATION

Determine Operation Area

- Provide all operators of this equipment with the Operator's Manual and instructions for safe operation.
- Review the area to be trimmed. Look for hazards that could contribute to unsafe conditions.
- Spectators and fellow workers must be warned, and children and animals prevented from coming nearer than 15M (50 ft.) while the trimmer is in use.

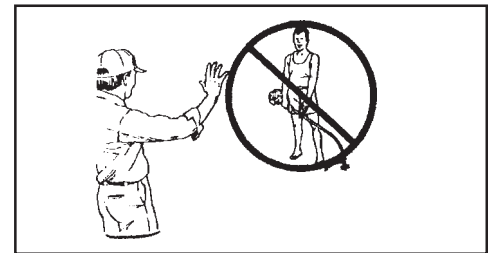
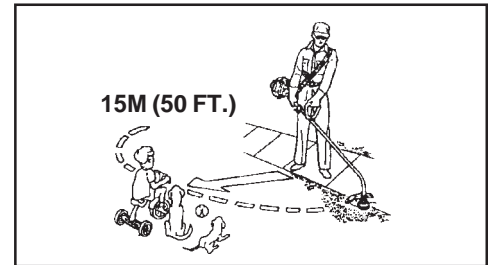

Operation

Use Proper Clothing & Equipment

- Before starting the unit, equip yourself and any other person working within the 15M (50 ft.) Safety Zone with the required Protective Equipment and clothing.

WARNING  DANGER

Do not operate this product indoors or in inadequately ventilated areas. Engine exhaust contains poisonous emissions and can cause serious injury or death.

Avoid Hot Surfaces

- During operation, the complete unit, especially the exhaust area and the bearing housing may become very hot. Avoid contact during and immediately after operation. Always keep exhaust area clear of flammable debris. Allow the engine and muffler to completely cool before performing any maintenance activity.

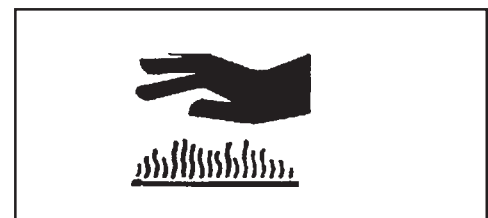

Keep A Firm Grip

- Hold the front and rear handles with both hands with thumbs and fingers encircling the handles



Keep A Solid Stance

- Maintain footing and balance at all times. Do not stand on slippery, uneven or unstable surfaces. Do not work in odd positions or on ladders. Do not over reach.

EXTENDED OPERATION/EXTREME CONDITIONS

Vibration and Cold --

It is believed that a condition called Raynaud's Phenomenon, which affects the fingers of certain individuals may be brought about by exposure to vibration and cold. Exposure to vibration and cold may cause tingling and burning sensations followed by loss of color and numbness in the fingers. The following precautions are strongly recommended because the minimum exposure which might trigger the ailment is unknown.

- Keep your body warm, especially the head, neck, feet, ankles, hands and wrists.
- Maintain good blood circulation by performing vigorous arm exercises during frequent work breaks and also by not smoking.
- Limit the hours of operation. Try to fill each day with jobs where operating the trimmer or other hand-held power equipment is not required.
- If you experience discomfort, redness and swelling of the fingers followed by whitening and loss of feeling, consult your physician before further exposing yourself to cold and vibration.

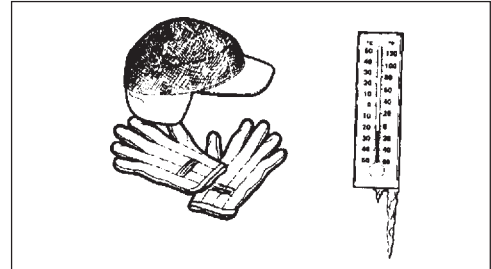

Repetitive Stress Injuries --

It is believed that overusing the muscles and tendons of the fingers, hands, arms and shoulders may cause soreness, swelling, numbness, weakness and extreme pain in those areas. Certain repetitive hand activities may put you at a high risk for developing a Repetitive Stress Injury (RSI). An extreme RSI condition is Carpal Tunnel Syndrome (CTS), which could occur when your wrist swells and squeezes a vital nerve that runs through the area. Some believe that prolonged exposure to vibration may contribute to CTS. CTS can cause severe pain for months or even years. To reduce the risk of RSI/CTS, do the following:

- Avoid using your wrist in a bent, extended or twisted position. Instead try to maintain a straight wrist position. Also, when grasping, use your whole hand, not just the thumb and index finger.
- Take periodic breaks to minimize repetition and rest your hands.
- Reduce the speed and force in which you do the repetitive movement.
- Do exercises to strengthen the hand and arm muscles.
- Immediately stop using all power equipment and consult a doctor if you feel tingling, numbness or pain in the fingers, hands, wrists or arms. The sooner RSI/CTS is diagnosed, the more likely permanent nerve and muscle damage can be prevented.

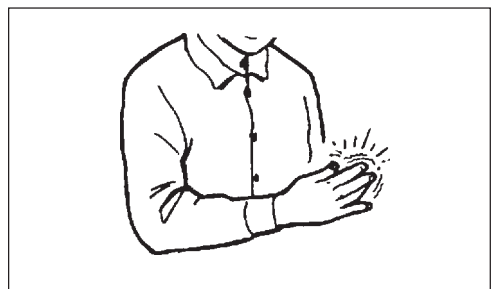
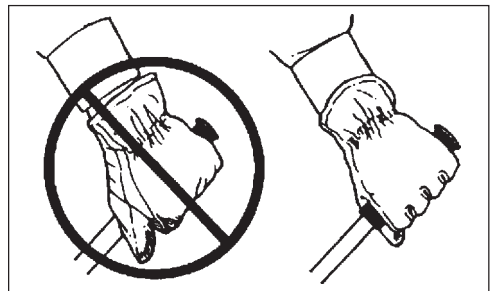

DESCRIPTION

The ECHO product you purchased has been factory pre-assembled for your convenience. Due to packaging restrictions, shield installation and positioning of the front handle are necessary.

After opening the carton, check for damage. Immediately notify your retailer or ECHO Dealer of damaged or missing parts. Use the contents list to check for missing parts.

EMISSION CONTROL

California Tier 2

The emission control system for these engines are EM (Engine Modification).

IMPORTANT ENGINE INFORMATION

ENGINE FAMILY: YEHXS.0214CA
 DISPLACEMENT: 21.2 cc
THIS ENGINE MEETS U.S. EPA PH1 AND 2000 AND LATER CALIFORNIA EMISSION REGULATIONS FOR S.O.R.E. REFER TO OWNER'S MANUAL FOR MAINTENANCE SPECIFICATIONS AND ADJUSTMENTS.

KIORTZ CORP.

AIR INDEX TAG

The Air Index Tag indicates, for purposes of consumer awareness, how this product's emissions compare to the standards enacted by the California Air Resources Board.

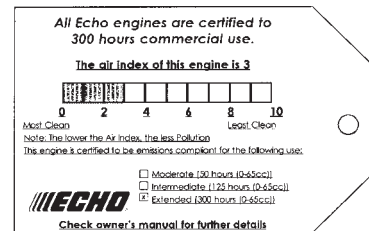

An Emission Control Label is located on the engine. (This is an EXAMPLE ONLY, information on label varies by engine FAMILY).

All Echo engines are certified to 300 hours commercial use.

Light-Duty
Homeowner
Consumer

Larger Property Homeowner
Light-Duty Professional

Heavy-Duty Professional
Commercial-Duty

ECHO

PRODUCT EMISSION DURABILITY

The 300 hour emission durability period is the time span selected by the manufacturer certifying the engine emissions output meets applicable California emissions regulations, provided that approved maintenance procedures are followed as listed in the Maintenance Section of this manual.

CONTENTS

- _____ 1 - Trimmer Assembly
- _____ - Power Head
- _____ - Drive Shaft Assembly
- _____ 1 - Plastic Bag (Co-Pack)
- _____ - Operator's Manual
- _____ - Safety Manual
- _____ - Shield Assembly
- _____ - Nylon Trimmer Head
- _____ - Hardware Bag
- _____ -1, 1/4-20 bolt
- _____ -1, 1/4-20 wing nut
- _____ -1, 1/4-20 flat washer
- _____ - Warranty Card & Limited Warranty
- _____ - Safety Glasses
- _____ - Oil 2 Stroke

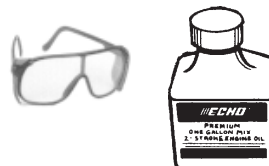
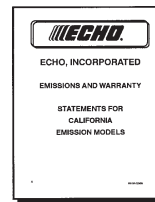

10 ECHO®

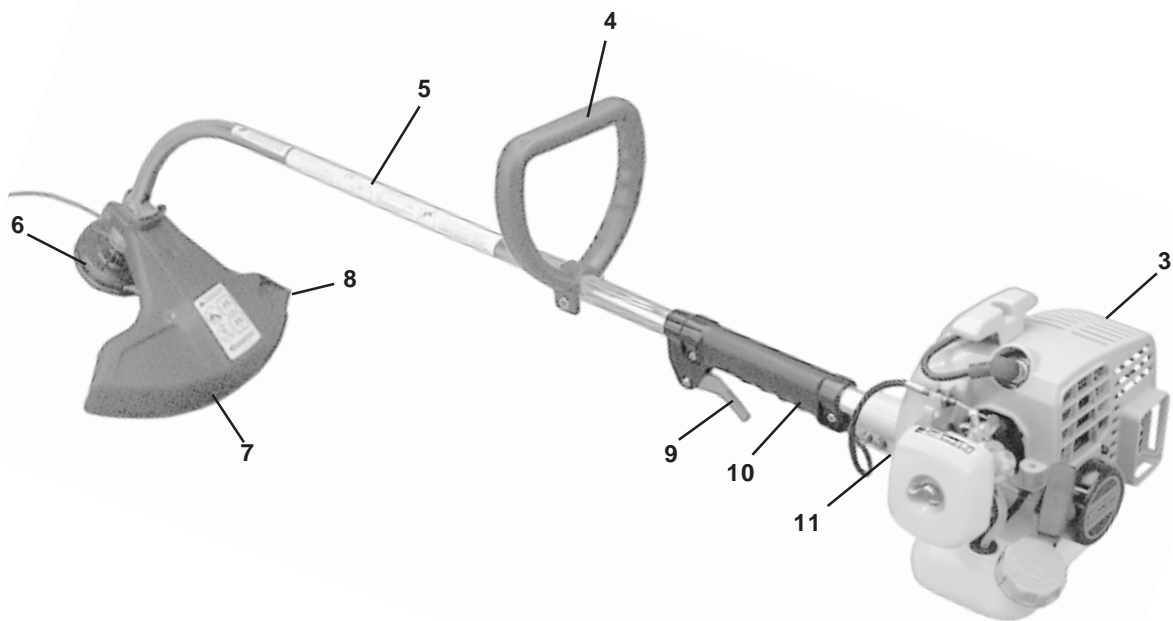
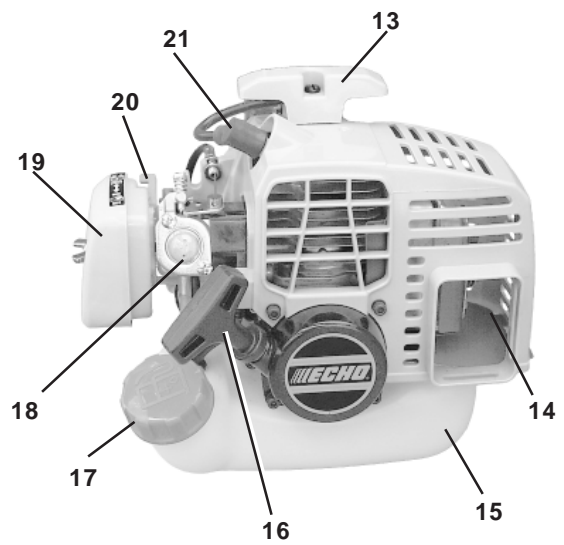

1. **OPERATOR'S MANUAL** - Included in plastic bag (co-pack). Read before operation and keep in a safe place for future reference, i.e., operation, maintenance, storage and specifications.
2. **SAFETY MANUAL** - Included in plastic bag (co-pack). Read before operation and keep in a safe place for future reference to learn proper, safe operating techniques.
3. **POWER HEAD** - Factory Assembled to the Drive Shaft assembly. Includes the Engine, Clutch, Fuel System, Ignition System and Recoil Starter.
4. **FRONT HANDLE** - The Front (loop) handle is factory assembled to the Drive Shaft assembly but must be repositioned for proper cutting attitude and operator comfort.
5. **Drive Shaft ASSEMBLY** - Factory Assembled to the Power Head. Includes the Rear (right hand) Handle Assembly, Bearing Housing Assembly, Throttle Trigger, Front (loop, left hand) Handle Assembly, Flexible Drive Cable and Safety Decals.
6. **NYLON CUTTER HEAD** - Contains replaceable nylon trimming line that advances when the trimmer head is tapped against the ground while the head is turning at normal operating speed.
7. **DEBRIS SHIELD ASSEMBLY** - Included in plastic bag (co-pack). **MUST** be installed on unit before use, see Assembly Instructions. Shield assembly includes the Cut-Off Knife and Safety Decal. Mounts on the Bearing Housing Assembly just above the cutting attachment. Helps protect the operator by deflecting debris produced during the trimming operation.
8. **CUT-OFF KNIFE** - Trims line to the correct length (5"). If trimmer is operated without a cut-off knife the line will become too long - more than (5") - the operating speed will slow, the engine overheat and performance will suffer.
9. **THROTTLE TRIGGER** - Spring loaded to return to idle when released. During acceleration, press trigger gradually for best operating technique.
10. **GRIP** - Rear (right hand) handle.
11. **STOP SWITCH** - "TOGGLE SWITCH" mounted on the engine. Move switch UP to RUN, DOWN to STOP.
12. **SHOULDER HARNESS** - Optional. An adjustable strap that suspends the unit from the operator.
13. **ARM REST** - Provides arm rest during operation and protects arm from hot engine.
14. **SPARK ARRESTOR - CATALYTIC MUFFLER/MUFFLER** - The muffler or catalytic muffler controls exhaust noise and emission. The spark arrestor screen prevents hot, glowing particles of carbon from leaving the muffler. Keep exhaust area clear of flammable debris.
15. **FUEL TANK** - Contains fuel and fuel filter.
16. **RECOIL STARTER HANDLE** - Pull handle slowly until recoil starter engages, then quickly and firmly. When engine starts, return handle slowly. DO NOT let handle snap back or damage to unit will occur.
17. **FUEL TANK CAP** - Cover and seals fuel tank opening.
18. **PRIMER BULB** - Pumping primer bulb before starting engine draws fresh fuel from the fuel tank priming the carburetor for starting. Pump primer bulb until fuel will be visible and flows freely in the clear fuel tank return line. Pump bulb an additional 4 or 5 times.
19. **AIR CLEANER** - Contains replaceable filter element.
20. **CHOKE** - Located above the air cleaner housing. Move lever to "Cold Start" to close choke for cold starting. Move lever to "Run" position to open choke.
21. **SPARK PLUG** - Provides spark to ignite fuel mixture.
22. **SAFETY VIDEO** - (Not included with unit) P/N 99922202540 English version only is available at a cost of \$5.00 from ECHO, INC. or any authorized ECHO dealer. The video overviews safety precautions and proper operating techniques and is supplemental to the Safety Manual. Read and understand the Safety Manual for complete information on safe operation.

SPECIFICATIONS

MODEL	GT-201
Length	1400 mm (55.1 in.)
Width	310 mm (12.2 in.)
Height	385 mm (15.2 in.)
Weight (dry) w/Cutter Head	4.35 kg (9.6 lb.)
Engine Type	Air cooled, two-stroke, single cylinder gasoline engine
Bore	32.2 mm (1.268 in.)
Stroke	26.0 mm (1.02 in.)
Displacement	21.2 cc (1.29 cu. in.)
Exhaust	Spark Arrestor Muffler w/catalyst
Carburetor	Zama diaphragm model w/purge
Ignition System	Flywheel magneto, capacitor discharge
Spark Plug	NGK BPM-7Y (0.65 mm (0.026 in.))
Fuel	Mixed (Gasoline and Two-stroke Oil)
Fuel/Oil Ratio	50:1 ECHO High Performance, two-stroke air cooled engine oil
Gasoline	89 Octane unleaded. DO NOT use fuel containing methyl alcohol, more than 10% ethyl alcohol or 15% MTBE.
Oil	50:1 ECHO High Performance, two-stroke air cooled engine oil
Fuel Tank Capacity	0.45 lit. (15.2 US fl. oz.)
Recoil Starter System	Automatic Recoil Starter
Clutch	Centrifugal Type
Drive Shaft	1/4" Flex Shaft
Rotating Direction	Clockwise viewed from top
Cutter Head	Nylon line head (2-Line) with .080 in. line capacity 6.5 m (20 ft.)
Front Handle	Left - D-Loop, Right - Grip
Shoulder Harness	Optional P/N 99944200201
Idle Speed (RPM)	2400 - 3200
Wide Open Throttle Speed with Trimmer Head	6800 - 7500

ASSEMBLY

Tools Required: Locking Tool (not included). (Use 1/8 in. diameter or less metal bar or small screwdriver.)

PLASTIC SHIELD

1. Snap the shield over the bearing housing.
2. Install bolt (A), washer (B) and wing nut (C).

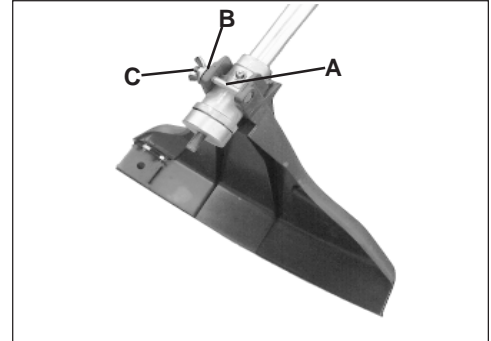

NYLON LINE HEAD

1. Align locking hole in upper plate with hole in bearing housing.
2. Insert 1/8" dia. locking tool (D) (not included with unit) and remove plastic retaining sleeve. Thread cutting attachment onto PTO shaft clockwise until head is tight.

IMPORTANT

Remember to remove the locking tool.

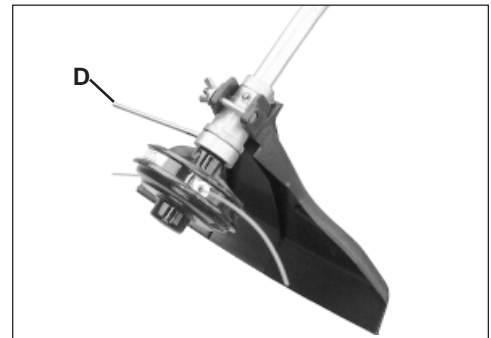

FRONT (LOOP) HANDLE

NOTE

Front handle is pre-installed. Repositioning and tightening is all that is required.

1. Position front handle (E) in comfortable operating position and tighten wing nut (F). The cutting attachment should be 5cm- 7.5cm (2 in. -3 in.) above the ground and as level as possible.

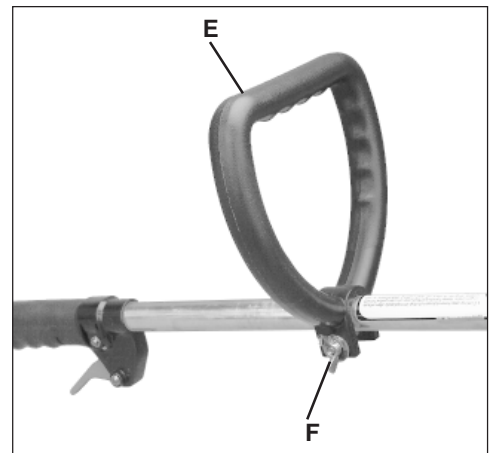

PRE - OPERATION

FUEL

Fuel Requirements

Gasoline - Use 89 Octane [$\frac{R+M}{2}$] (mid grade or higher) gasoline or gasohol known to be good quality. Gasohol may contain up to 10% Ethyl (grain) alcohol or 15% MTBE (methyl tertiary-butyl ether). Gasohol containing methyl (wood) alcohol is **NOT** approved.

Two Stroke Oil - A two-stroke engine oil meeting ISO-L-EGD (ISO/CD 13738) and JASO FC standards, must be used. Echo brand Premium 50:1 oil meets these standards. Engine problems due to inadequate lubrication caused by failure to use an ISO-L-EGD and JASO FC certified oil, such as Echo Premium 50:1 Two-stroke Oil, will void the two-stroke engine warranty. (Emission related parts only are covered for two years, regardless of two-stroke oil used, per the statement listed in the California Emission Defect Warranty Explanation.)

Mixing - Follow directions on the oil container.

Handling Fuel

WARNING DANGER

Fuel is **VERY** flammable. Use extreme care when mixing, storing or handling, otherwise serious personal injury may result.

- Use an approved fuel container.
- DO NOT smoke near fuel.
- DO NOT allow flames or sparks near fuel.
- Fuel tanks/cans may be under pressure. Always loosen fuel caps slowly allowing pressure to equalize.
- NEVER refuel a unit when the engine is HOT!
- NEVER refuel a unit with the engine running.
- DO NOT fill fuel tanks indoors. ALWAYS fill fuel tanks outdoors over bare ground.
- Securely tighten fuel cap after refueling.
- Inspect for fuel leakage. If fuel leakage is found, do not start or operate unit until leakage is repaired.

IMPORTANT

Spilled fuel is a leading cause of hydrocarbon emissions. Some states may require the use of automatic fuel shut-off containers to reduce fuel spillage. Contact your ECHO dealer for ordering information.

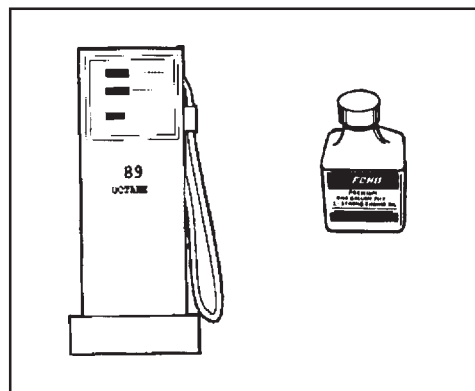

After refueling;

- Wipe any spilled fuel from the unit.
- Move at least 3 M (10 ft.) from refueling location before starting the engine.

After use;

- DO NOT store a unit with fuel in its tank. Leaks can occur. Return unused fuel to an approved fuel storage container.

Storage -

Fuel storage laws vary by locality. Contact your local government for the laws affecting your area. As a precaution, store fuel in an approved, air tight container. Store in a well ventilated, unoccupied building, away from sparks and flames. Do not store fuel longer than 30 days.

IMPORTANT

Stored fuel ages. Do not mix more fuel than you expect to use in thirty (30) days, ninety (90) days when a fuel stabilizer is added.

IMPORTANT

Stored two-stroke fuel may separate. ALWAYS shake fuel container thoroughly before each use.

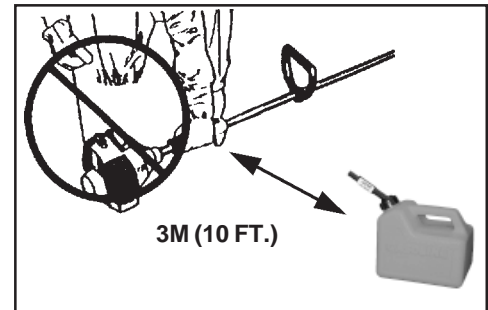

S	M	T	W	T	F	S
1	2	3	4	5	6	7
8	9	10	11	12	13	14
15	16	17	18	19	20	21
22	23	24	25	26	27	28
29	30	31				

EQUIPMENT CHECK

Before operation a complete check of the unit must be performed;

- Check unit for loose/missing nuts, bolts and screws. Tighten and/or replace as needed.
- Inspect fuel lines, tank and area around carburetor for fuel leaks. DO NOT operate unit if leaks are found.
- Inspect shield for damage and ensure that the cut-off knife is securely in place. Replace if either is damaged or missing.
- Check that the cutting attachment is firmly attached and in safe operating condition.
- Check that front (loop) handle and optional shoulder harness are adjusted for safe, comfortable operation. See Assembly for proper adjustment.

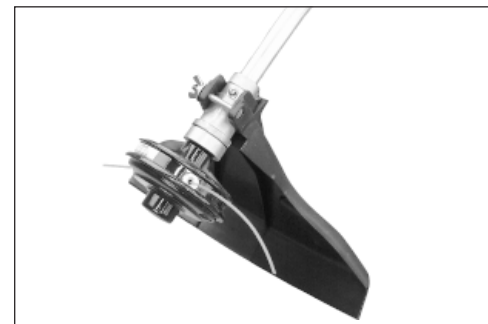

DETERMINE OPERATION AREA

- Review the area to be trimmed. Look for hazards that could contribute to unsafe conditions.
- Spectators and fellow workers must be warned, and children and animals prevented from coming nearer than 15M (50 ft.) while the trimmer is in use.

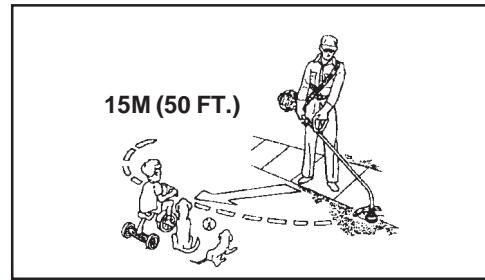

OPERATION

- Provide all operators of this equipment with the Operator's Manual and Instructions for safe use.
- Before starting the unit, equip yourself and any other person working within the 15M (50 ft.) Safety Zone with the required Protective Equipment and clothing.
- During operation, the complete unit, especially the exhaust area and the bearing housing may become very hot, too hot to touch. Avoid contact during and immediately after operation. Always keep exhaust area clear of flammable debris.

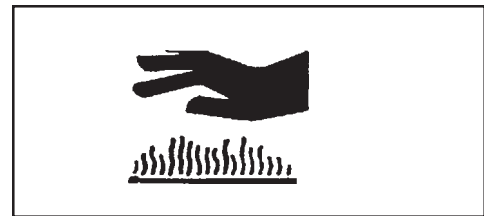
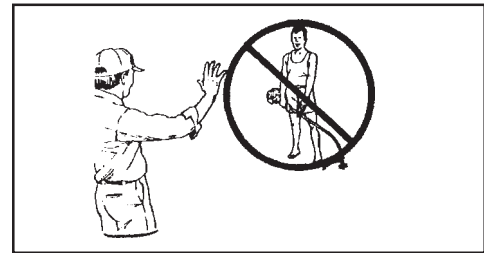

STARTING COLD ENGINE

WARNING DANGER

The cutting attachment should not rotate at idle. If attachment rotates, readjust carburetor according to "Carburetor Adjustment" instructions in this manual or see your ECHO Dealer, otherwise serious personal injury may result.

1. Stop Switch - Start/Run.
Move stop switch button (A) away from the STOP position.
2. Choke Lever - Cold Start.
Move choke (B) to "Cold Start" Position.
3. Primer - Pump Bulb
Pump primer bulb (C) until fuel will be visible and flows freely in the clear fuel tank return line. Pump bulb an additional 4 or 5 times.

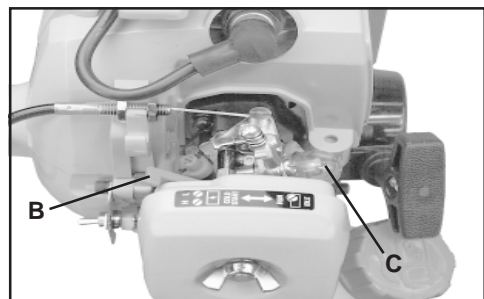
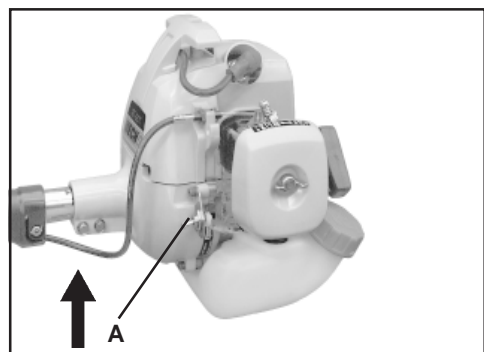

WARNING DANGER

Inspect starting area for hazards such as rocks, glass, debris etc. which could be thrown by the cutting attachment when starting. Keep helpers and bystanders at least 15m (50 feet) from starting area, otherwise serious personal injury may result.

4. Lay the trimmer on a flat clear area. Firmly grasp throttle grip with left hand and fully depress throttle trigger to wide open position. Rapidly pull starter handle/rope (D) until engine fires (maximum five [5] pulls).
5. After engine fires or five (5) pulls, move choke lever back to "Run" position. Hold throttle trigger fully depressed and pull starter handle/rope until engine starts and runs. Release throttle trigger and allow unit to warm up at idle for several minutes.

NOTE

If engine does not start with choke in "Run" position after 5 pulls, repeat instructions.

6. After engine warm up, gradually depress throttle trigger to increase engine RPM to operating speed.

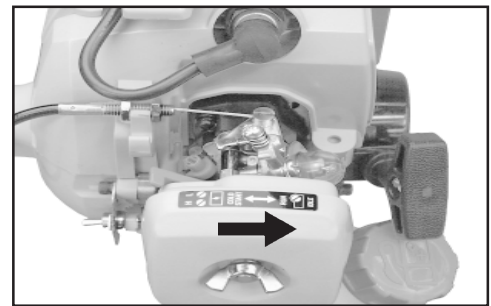
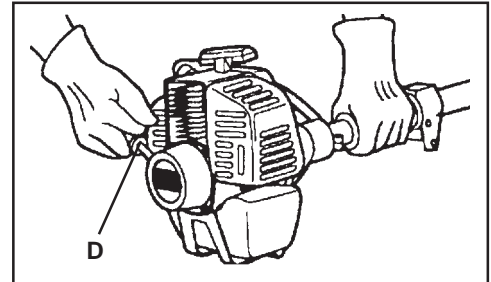

STARTING WARM ENGINE

WARNING DANGER

The cutting attachment should not rotate at idle. If attachment rotates, readjust carburetor according to "Carburetor Adjustment" instructions in this manual or see your ECHO Dealer, otherwise serious personal injury may result.

1. Stop Switch - Start/Run. Move stop switch button (A) away from the STOP position.
2. Start - Pull Rope. Lay the trimmer on a flat clear area and pull the starter handle (D) until the engine fires.

NOTE

If engine does not start after 5 pulls, use Cold Start Procedure.

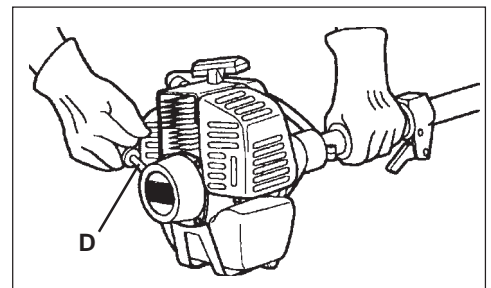
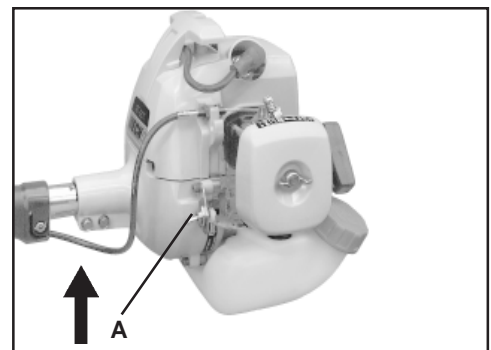

STOPPING ENGINE

1. Release Throttle. Allow engine to idle for a minute.
2. Stop Switch - Stop. Move stop switch button (A) to STOP position.

WARNING DANGER

If engine does not stop when stop switch is moved to STOP position, close choke - COLD START position - to stall engine. Have your ECHO dealer repair stop switch before using trimmer again.

NOTE

Refer to the Grass Trimmer / Brush Cutter Safety Manual for proper and safe trimming techniques.

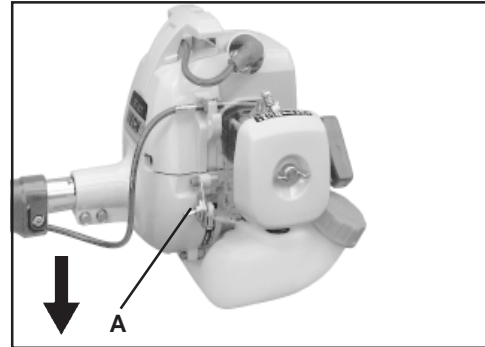

MAINTENANCE

Your ECHO trimmer is designed to provide many hours of trouble free service. Regular scheduled maintenance will help your trimmer achieve that goal. If you are unsure or are not equipped with the necessary tools, you may want to take your unit to an ECHO Service Dealer for maintenance. To help you decide whether you want to DO-IT-YOURSELF or have the ECHO Dealer do it, each maintenance task has been graded. If the task is not listed see your Echo dealer for repairs.

SKILL LEVEL

- Level 1** = Easy to do. Most required tools come with unit.
- Level 2** = Moderate difficulty. Some specialized tools may be required.
- Level 3** = Experience required. Specialized tools are required. ECHO recommends that the unit be returned to your ECHO dealer for servicing.

ECHO offers **REPOWER™** Maintenance Kits and Parts to make your maintenance job easier. Just below each task heading are listed the various part numbers required for that task. See your ECHO dealer for these parts.

MAINTENANCE INTERVALS

Component/System	Maintenance Procedure	Daily or Before Use	Every Refuel	3 Months or 90 Hours	6 Months or 270 Hours	Yearly
Air Filter	Clean / Replace	I / C		R *		
Fuel Strainer	Clean / Replace			I		R
Fuel Line	Inspect	I	I	I		
Carburetor	Inspect / Rebuild / Replace				I / C	R (1)
Choke System	Inspect / Clean / Replace	I / C	I / C			
Cooling System	Inspect / Clean	I / C				
Muffler Spark Arrestor	Inspect / Clean			I / C		
Cylinder Exhaust Port	Inspect / Clean / Decarbon			I / C		
Drive Shaft (Flex Cable Models)	Grease			I (2)		
Gear Housing	Grease			I		
Starter Rope	Inspect / Clean	I				
Fuel Leaks	Inspect / Replace	I	I			
Spark Plug	Clean / Replace			I / C	R	
Ignition System	Clean / Replace	No Maintenance required for coil and flywheel				
Screws/Nuts/Bolts	Inspect / Tighten / Replace	I				

I = Inspect / R = Replace / C = Clean

Time intervals shown are maximum. Actual use and your experience will determine the frequency of required maintenance.

(1) Replacement will be required for commercial use yearly. For Consumer use, cleaning every 6 months is required. Cleaning includes Rebuild Kits.

*** All recommendations to replace are based on the finding of damage or wear during inspection.**

(2) Grease flexible drive cables every 25 hours and/or on a weekly schedule.

AIR FILTER

Level 1.

Tools required: Cleaning brush, 25 or 50 mm (1 or 2 in.) medium bristle paint brush.

Parts required: 90008REPOWER™ AIR & FUEL FILTER KIT.

1. Close choke (Cold Start Position). This prevents dirt from entering the carburetor throat when the air filter is removed. Brush accumulated dirt from the air cleaner area.
2. Remove the air cleaner cover. Clean and inspect the element for damage. If element is fuel soaked and very dirty, replace.
3. If element can be cleaned and reused, be certain it:
 - still fits the cavity in the air cleaner cover.
 - is installed with the original side out.

NOTE

Carburetor adjustment may be needed after air filter cleaning/replacement. See Carburetor Adjustment Section.

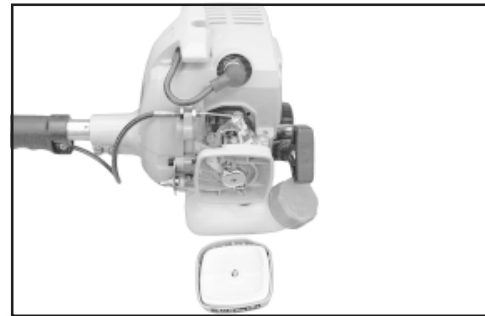
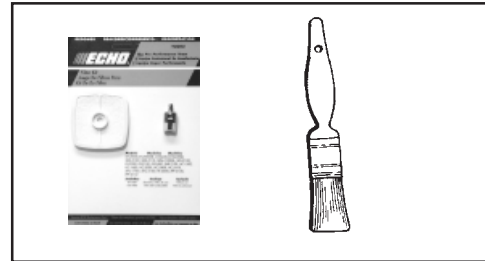

FUEL FILTER

Level 1.

Tools required: Fuel line hook, 203-254 mm (8-10 in.) length of wire with one end bent into a hook. Clean rag, funnel, and an approved fuel container.

Parts required: 90008REPOWER™ AIR & FUEL FILTER KIT

WARNING DANGER

Fuel is **VERY** flammable. Use extreme care when mixing, storing or handling.

1. Use a clean rag to remove loose dirt from around fuel cap and empty fuel tank.
2. Use the "fuel line hook" to pull the fuel line and filter from the tank.
3. Remove the filter from the line and install the new filter.

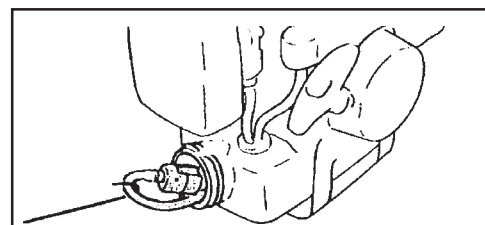

WARNING DANGER

Catalytic mufflers operate at extremely high temperatures. Muffler area must be kept clean. Do not perform maintenance on the muffler until engine and muffler are completely cool, otherwise serious personal injury may occur.

SPARK PLUG

Level 2.

Tools Required: Spark Plug socket wrench and screw driver, Feeler gauge. Preferably a wire gauge.

Parts Required: 90064 REPOWER™ Tune-Up Kit

1. Remove spark plug and check for fouling, worn and rounded center electrode.
2. Clean the plug or replace with a new one. DO NOT sand blast to clean. Remaining sand will damage engine.
3. Adjust spark plug gap by bending outer electrode.
4. Tighten spark plug to 145-155 kg/cm (125-135 in. lb.).

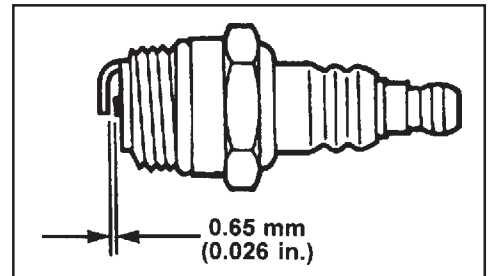
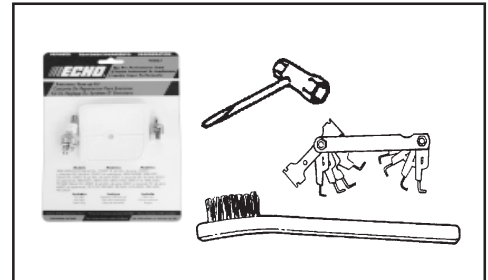

COOLING SYSTEMS CLEANING

Level 2.

Tools required: Cross Head Screwdriver, 3 mm Hexagon wrench, Cleaning Brush, 25-50 mm (1-2 in.) medium bristle paint brush.

Parts Required: None.

IMPORTANT

To maintain proper engine operating temperatures, cooling air must pass freely through the cylinder fin area. This flow of air carries combustion heat away from the engine.

Overheating and engine seizure can occur when:

- Air intakes are blocked, preventing cooling air from reaching the cylinder.
- Dust and grass build up on the outside of the cylinder. This build up insulates the engine and prevents the heat from leaving.

Removal of cooling passage blockages or cleaning of cooling fins is considered "Normal Maintenance". Any failure attributed to lack of maintenance is not warranted.

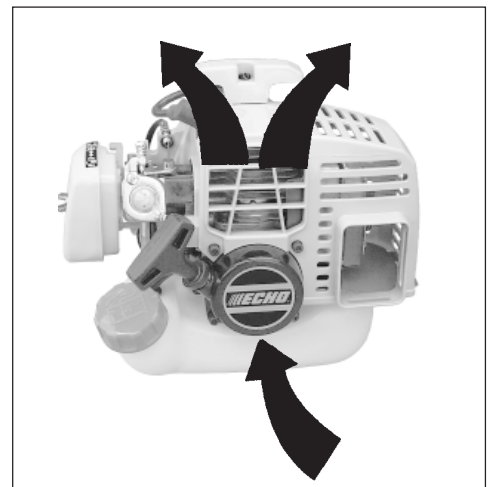
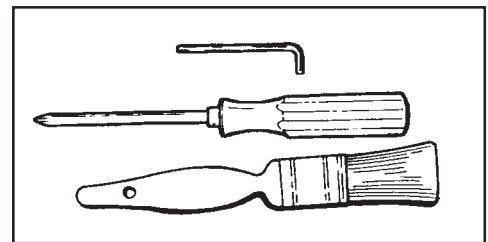

1. Remove spark plug lead and throttle linkage end from the carburetor swivel.
2. Remove the four screws that retain the cover. Two at the top of the Recoil Starter, two on either side of the front. Lift the cover from the engine and lay to the front of the trimmer.

NOTE

The throttle linkage remains assembled to the cover and the spark plug lead and grommet remain installed.

IMPORTANT

DO NOT use a metal scraper to remove dirt from the cylinder fins.

3. Use the brush to remove dirt from the cylinder fins.
4. Remove grass and leaves from the grid between the starter and fuel tank.
5. When installing the cover, be certain the tab of the metal deflector shield is in the slot of the cover.

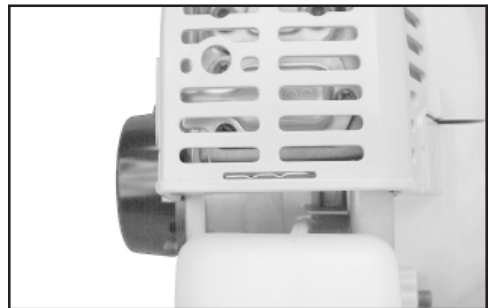
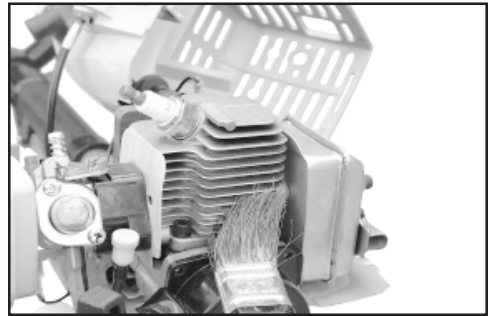

EXHAUST SYSTEM

Spark Arrestor Screen

Level 2.

Tools Required: Cross Head Screwdriver. Soft metal brush.

Parts Required: Screen P/N 14586240630, Gasket Lid P/N 14586642031

1. Remove engine cover, see "Cooling System Cleaning" pages 21 and 22 for step by step instructions.
2. Remove screen cover (A), holder (B) and gasket (C) from muffler body.
3. Clean carbon deposits from screen (D) and muffler components.
4. Replace screen if it is cracked, plugged or has holes burned through.
5. Assemble components in reverse order.

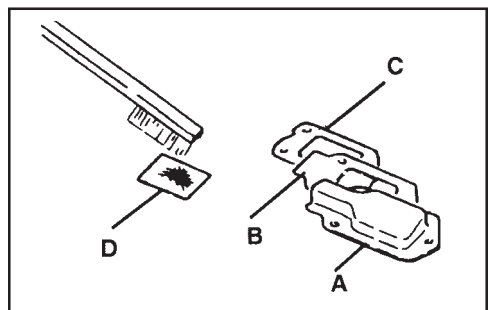
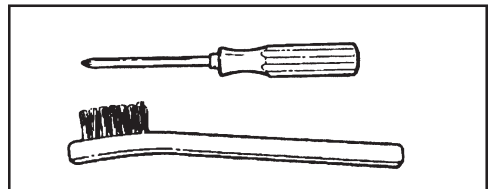

CARBURETOR ADJUSTMENT

Engine Break-In

New engines must be operated a minimum duration of two tanks of fuel break-in before carburetor adjustments can be made. During the break-in period your engine performance will increase and exhaust emissions will stabilize. Idle speed can be adjusted as required.

High Altitude Adjustment

High altitude adjustment is not required for proper operation of this engine.

Level 2.

Tools required: Screwdriver, Tachometer (ECHOP/N99051130017).

Parts required: None.

NOTE

Every unit is run at the factory and the carburetor is set in compliance and California Emission Regulations. In addition, the carburetor is equipped with a HI needle adjustment limiter that prevents settings outside acceptable limits.

1. Before adjusting the carburetor, clean or replace the air filter and spark arrester screen.
2. Trimmer line must be extended to the cut-off knife.
3. Start engine and run for several minutes to reach operating temperature.
4. Stop engine. Turn HI speed needle (A) CCW (counter clockwise) to stop.
5. Idle Speed Adjustment.
 - Start engine and turn "idle" speed adjustment screw (B) CW until the blades begin to turn, then turn the screw CCW until blades stop turning. Turn screw CCW an additional 1/4 turn.
6. Accelerate to full throttle for 2-3 seconds to clear excess fuel from engine then return to idle. Accelerate to full throttle to check for smooth transition from idle to full throttle. If engine stops or stalls after full warm up return the unit to your authorized ECHO dealer for repair.
7. Check HI speed RPM at W.O.T. (Wide Open Throttle). HI speed RPM should be set to specifications found on page 12 "Specifications" of this manual.
8. Check idle speed and reset if necessary. If a tachometer is available, idle speed should be set to the specification found on page 12 "Specifications" of this manual.

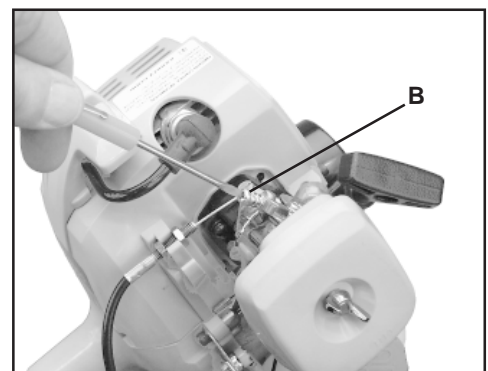
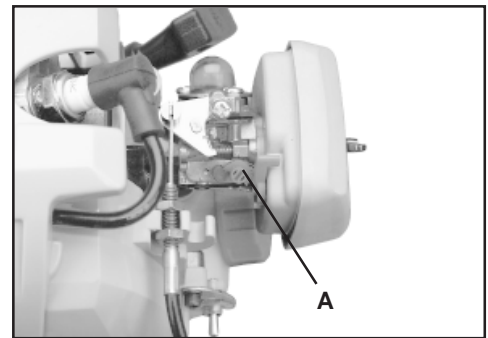
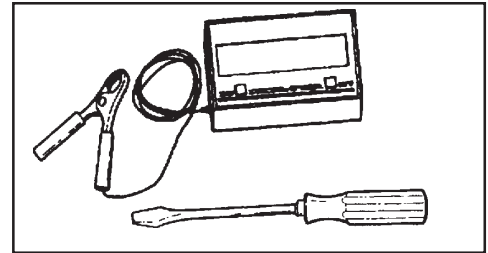

WARNING **DANGER**

When carburetor adjustment is completed, the cutting attachment should not turn at idle, otherwise serious personal injury may result.

LUBRICATION

Level 1.

Tools Required: 8 mm Open End Wrench, Screwdriver, Clean Rag.

Parts Required: Echo Lube™ 8 oz. (P/N 91014) or Lithium Base Grease.

1. Remove plastic shield.
2. Loosen bearing housing locating screw (A), at the top of the housing, remove mounting screw (B).
3. Pull the flexible drive shaft (C) from the housing, wipe clean and re-coat with a thin coating [1/2 oz. (15 ml)] of grease.
4. Slide the flexible drive shaft back in the drive housing being careful not to get dirt on the flexible drive shaft.
5. Install the bearing housing and shield.

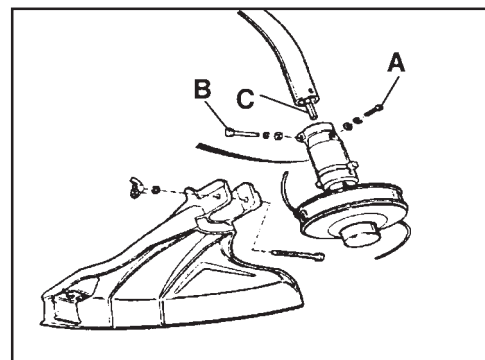
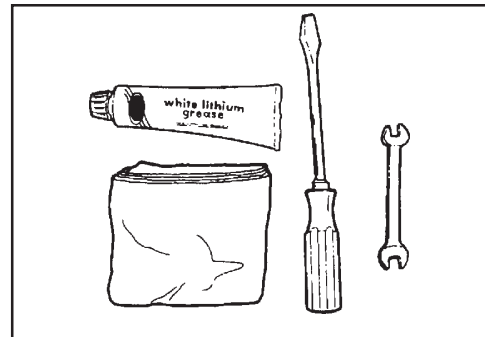

NYLON LINE REPLACEMENT

Level 1.

Tools Required: Head locking tool - 1/8" dia. Rod (if head is to be removed)

Parts Required: ECHO 0.080 (2mm) Nylon Trimmer Line 4.6 m (15 feet)

1. Shut engine off. Lay unit on the ground with head assembly up.
2. Hold head firmly, push in housing tab and turn cover counter clockwise to remove cover and spool.
3. Cut .080" line to 4.6 m (15 feet) length. Thread line through hole (A) in spool spindle until one end is 4" longer than the other end.

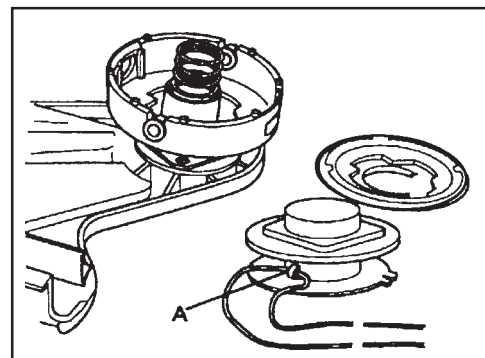
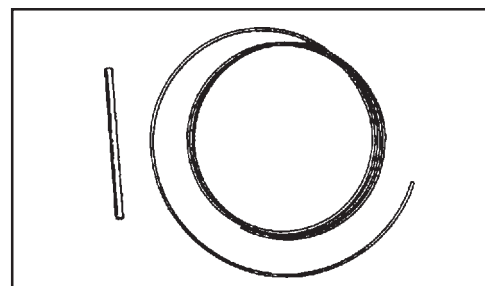

4. Hold spool with words "WIND LINE" and tap knob towards you. Place index finger between the two lines and wind line clockwise tightly and evenly.

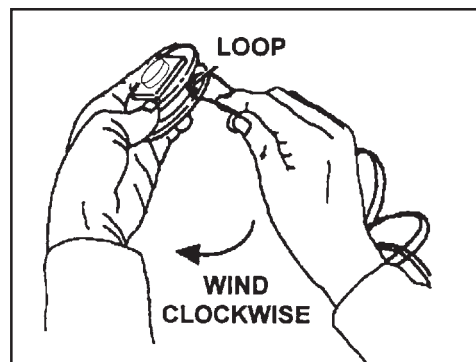

5. Place ends of line in the two notches (B) molded in the spool with 12.5 cm to 15.2 cm (5 in. to 6 in.) protruding.

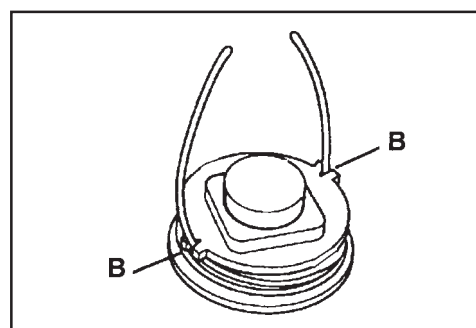

6. Place spool in housing against spring (C); thread line ends through housing eyelets (D)

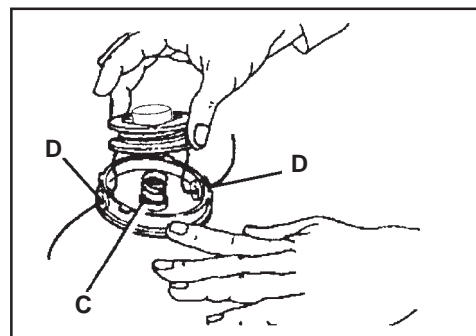

7. Align cover arrow with housing tab; push down on cover and twist clockwise until cover locks in place.
8. Pull both lines out and trim to cut-off knife length.

Before installing, test head. Push center button while pulling on both lines. Trimmer line should advance approximately 1 (one) inch.

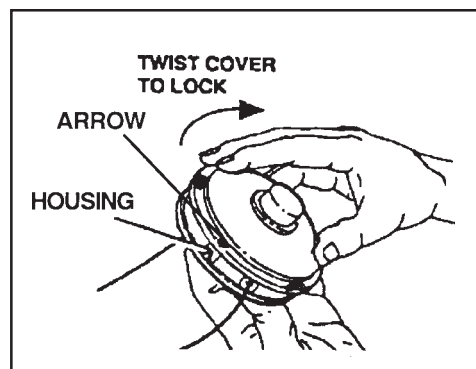

TROUBLESHOOTING

Problem				
Engine -- starts hard				
Engine -- does not start			Cause	Remedy
Engine Cranks	Fuel at carburetor	No fuel at carburetor	Fuel strainer clogged Fuel line clogged Carburetor	Clean Clean See your ECHO dealer
	Fuel at cylinder	No fuel at cylinder	Carburetor	See your ECHO dealer
		Muffler wet with fuel	Fuel Mixture is too rich	Open choke Clean/replace air filter Adjust carburetor See your ECHO dealer
	Spark at end of plug wire	No spark at end of plug wire	Stop switch off Electrical problem	Turn switch on See your ECHO dealer
	Spark at plug	No spark at plug	Spark gap incorrect Covered with carbon Fouled with fuel Spark plug defective	Adjust 0.65mm (0.026in.) Clean or replace Clean or replace Replace plug
Engine does not crank			Internal engine problem	See your ECHO dealer
Engine runs			Air filter dirty Fuel filter dirty Fuel vent plugged Spark plug Carburetor Cooling system plugged Spark arrestor screen plugged	Clean or replace Replace Replace Clean and adjust/replace Adjust Clean Clean

WARNING DANGER

Fuel vapors are **extremely** flammable and may cause fire and/or explosion. **Never** test for ignition spark near an open spark plug opening, otherwise serious personal injury may result.

STORAGE

Long Term Storage (over 30 days)

WARNING  **DANGER**

During operation the muffler or catalytic muffler and surrounding cover become hot. Always keep exhaust area clear of flammable debris during transportation or when storing, otherwise serious property damage or personal injury may result.

Do not store your unit for a prolonged period of time (30 days or longer) without performing protective storage maintenance which includes the following:

1. Store unit in a dry, dust free place, out of the reach of children with drive shaft housing in an upright or horizontal position to prevent grease leakage.

WARNING  **DANGER**

Do not store in enclosure where fuel fumes may accumulate or reach an open flame or spark, otherwise serious injury may result.

2. Place the stop switch (A) in the "OFF" position.
3. Remove accumulation of grease, oil, dirt and debris from exterior of unit.
4. Perform all periodic lubrication and services that are required.
5. Tighten all the screws and nuts.
6. **Drain** the fuel tank **completely** and pull the recoil starter handle several times to remove fuel from the carburetor.
7. Remove the spark plug and pour 7 cc (1/4 oz.; 1/2 tablespoon) of fresh, clean, two-stroke engine oil into the cylinder through the spark plug hole.
 - A. Place a clean cloth over the spark plug hole.
 - B. Pull the recoil starter handle 2-3 times to distribute the oil inside the engine.
 - C. Observe the piston location through the spark plug hole. Pull the recoil starter handle slowly until the piston reaches the top of its travel and leave it there.
8. Install the spark plug (do not connect ignition cable).

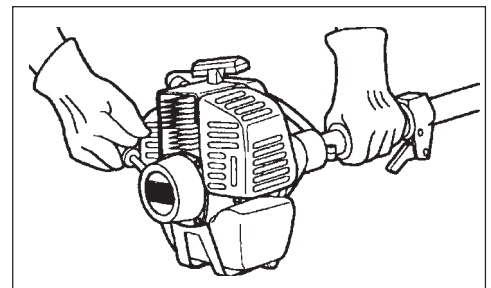
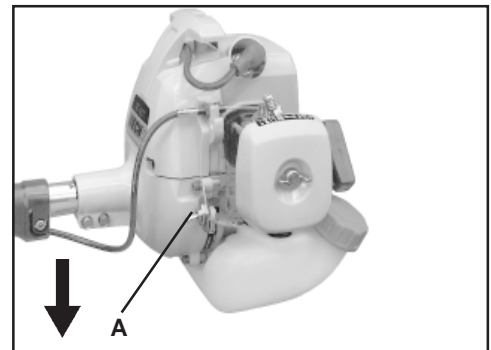

SERVICING INFORMATION

PARTS

Genuine ECHO Parts and ECHO REPOWER™ Parts and Assemblies for your ECHO products are available only from an Authorized ECHO Dealer. When you do need to buy parts **always** have the Model Number and Serial Number of the unit with you. You can find these numbers on the engine housing. For future reference, write them in the space provided below.

Model No. _____ SN. _____

SERVICE

Service of this product during the warranty period must be performed by an Authorized ECHO Service Dealer. For the name and address of the Authorized ECHO Service Dealer nearest you, ask your retailer or call: 1-800-432-ECHO (3246). When presenting your unit for Warranty service/repairs, proof of purchase is required.

ECHO CONSUMER PRODUCT SUPPORT

If you require assistance or have questions concerning the application, operation or maintenance of this product you may call the ECHO Consumer Product Support Department at 1-800-673-1558 from 8:00 am to 5:00 pm (Central Standard Time) Monday through Friday. Before calling, please know the model and serial number of your unit to help your Consumer Product Support Representative.

WARRANTY CARD

This card is our means of registering all original owners of ECHO equipment. The card plus proof of purchase provides you the assurance that authorized warranty work will be done. It also provides a direct link between you and ECHO if we find it necessary to contact you.

ADDITIONAL OR REPLACEMENT MANUALS

Safety Manuals are available, free of charge, from your ECHO dealer or by contacting Echo Incorporated, 400 Oakwood Road, Lake Zurich, IL 60047

Operator's and Parts Manuals are available for purchase from your ECHO dealer or directly from ECHO. [See ordering instructions at the end of this manual.]

Safety Video is available from your dealer. A \$5.00 shipping charge will be required.

ORDERING INSTRUCTIONS

To obtain a Parts Catalog or Operator's Manual send a check or money order for \$2.00 per Parts Catalog or \$1.50 per Operator's Manual made payable to ECHO, INCORPORATED. State on a sheet of paper the model number and serial number of the ECHO unit you have, part number of the manual (if known), your name and address and mail to address above.

Available Parts Catalog

GT-201 Serial Number 002001001

Part Number 99922203164

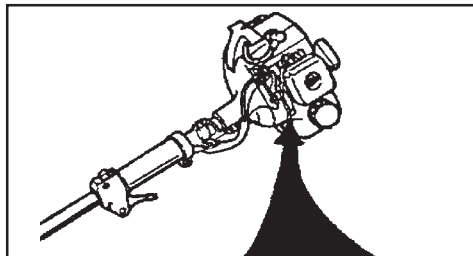

DEALER?

Call

1-800-432-ECHO

1-800-432-3246

CONSUMER PRODUCT SUPPORT

1-800-673-1558

8 - 5 Mon - Fri C.S.T.

A small image of a warranty card form with various fields for registration, including name, address, and contact information. The form is titled 'ECHO' and contains several sections for user input.

ECHO Incorporated

400 Oakwood Road

Lake Zurich, IL 60047

Technical Publications Orders

ECHO
ECHO, INCORPORATED

400 OAKWOOD ROAD
LAKE ZURICH, IL 60047

Free Manuals Download Website

<http://myh66.com>

<http://usermanuals.us>

<http://www.somanuals.com>

<http://www.4manuals.cc>

<http://www.manual-lib.com>

<http://www.404manual.com>

<http://www.luxmanual.com>

<http://aubethermostatmanual.com>

Golf course search by state

<http://golfingnear.com>

Email search by domain

<http://emailbydomain.com>

Auto manuals search

<http://auto.somanuals.com>

TV manuals search

<http://tv.somanuals.com>