



Shaft Hedge Clipper

Operator's Manual

MODEL

SHC-210

Serial Number 07001001 - 07999999

WARNING  **DANGER**



The muffler or catalytic muffler and surrounding cover may become extremely hot.

Always keep clear of exhaust and muffler area, otherwise serious personal injury may occur.



WARNING



The engine exhaust from this product contains chemicals known to the State of California to cause cancer, birth defects or other reproductive harm.



WARNING  **DANGER**

Read rules for safe operation and instructions carefully. ECHO provides an Operator's Manual and a Safety Manual. Both must be read and understood for proper and safe operation. Failure to do so could result in serious injury.

X7502253801

X750005481
03/03

INTRODUCTION

Welcome to the ECHO family. This ECHO product was designed and manufactured to provide long life and on-the-job dependability. Read and understand this manual and the SAFETY MANUAL you found in the same package. You will find both easy to use and full of helpful operating tips and SAFETY messages.

THE OPERATOR'S MANUAL

Read and understand this manual before operation. Keep it in a safe place for future reference. It contains specifications and information for operation, starting, stopping, maintenance, storage, and assembly specific to this product.

THE SAFETY MANUAL

Read and understand this manual before operation. Keep it in a safe place for future reference. It explains possible hazards involved with the use of Hedge Clippers and what measures you should take to make their use safer.

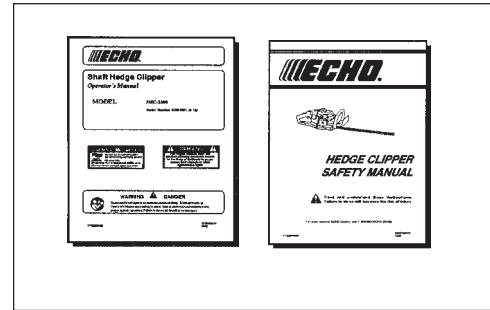



TABLE OF CONTENTS

Introduction	2	- Stopping Engine	13
- The Operator's Manual	2	Maintenance	14
- The Safety manual	2	- Skill Levels	14
Manual Safety Symbols and Important Information ..	3	- Maintenance Intervals	14
Safety	3	- Air Filter	15
- Decals	3	- Fuel Filter	15
- International Symbols	4	- Spark Plug	16
Safety Instructions	4	- Cooling System Cleaning	16
- Personal Conditions and Safety Equipment	4	- Exhaust System	17
- Extended Operation/Extreme Conditions	5	- Carburetor Adjustment	18
- Equipment	5	- Lubrication	19
- Safe Operation	6	- Sharpening Blades	21
Emissions Control	6	Troubleshooting	22
Description	7	Storage	23
- Contents	7	Servicing Information	24
Specifications	9	- Parts	24
Assembly	10	- Service	24
- Gear Housing Assembly / Drive Shaft	10	- ECHO Consumer Product Support	24
Pre-Operation	11	- Warranty Card	24
- Fuel	11	- Additional or Replacement Manuals	24
Operation	12		
- Starting Cold Engine	12		
- Starting Warm Engine	13		

Specifications, descriptions and illustrative material in this literature are as accurate as known at the time of publication, but are subject to change without notice. Illustrations may include optional equipment and accessories, and may not include all standard equipment.

MANUAL SAFETY SYMBOLS AND IMPORTANT INFORMATION

Throughout this manual and on the product itself, you will find safety alerts and helpful, informational messages preceded by symbols or key words. The following is an explanation of those symbols and key words and what they mean to you.

 This symbol accompanied by the words **WARNING** and **DANGER** calls attention to an act or condition that can lead to serious personal injury to operator and bystanders.

 The circle with the slash symbol means whatever is shown within the circle is prohibited.

 **IMPORTANT**  **NOTE**

IMPORTANT The enclosed message provides information necessary for the protection of the unit.

NOTE This enclosed message provides tips for use, care and maintenance of the unit.

SAFETY DECALS

Locate these safety decals on your unit. Make sure the decals are legible and that you understand and follow the instructions on them. If a decal cannot be read, a new one can be ordered from your ECHO dealer. See PARTS ORDERING instructions for specific information.

Hot Surface Decal

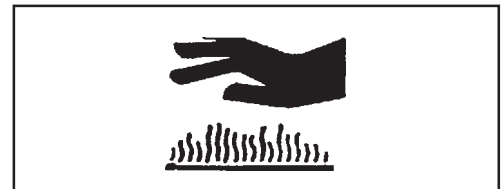



P/N 89016006361

Hand Guard

WARNING  **DANGER**

This unit is not designed to insulate against hazards associated with the contact of wires carrying electrical current. To avoid possible injury/death due to electrical shock or other hazards. **DO NOT** operate unit if any wires (power, telephone, cable, etc.) are closer than 15 feet (4.5 meters) minimum distance, to any part of the unit or operator. • This unit can be dangerous if used improperly. • Falling objects and/or blade contact can cause serious injury to operator, helpers and bystanders. • Keep helpers and bystanders at least 50 feet (15 m) clear of operating area. • To reduce injury risk, READ AND UNDERSTAND the Operator's Manual. Replacement copies are available through any ECHO Dealer.

 • Wear Protective Clothing (head, hearing and eye protection meeting ANSI standards) specified in the Operator's Manual.

 • STOP engine before making repairs or blade adjustments. • Keep hand away from blade.

P/N 89018721560

INTERNATIONAL SYMBOLS

Symbol form/shape	Symbol description/application	Symbol form/shape	Symbol description/application
	Read and understand Operator's Manual.		Fuel and oil mixture
	Wear eyes, ears and head protection		Finger Severing
	Hot Surface		Wear hand protection. Use two handed.
	Safety/Alert		DO NOT smoke near fuel.
	Avoid all power lines. This unit is not insulated against electrical current.		DO NOT allow flames or sparks near fuel.
	Do not operate closer than 15 M (50 ft.) from electrical hazards.		Keep bystanders at least 15 meters (50 feet) away.

Symbol form/shape	Symbol description/application	Symbol form/shape	Symbol description/application
	Emergency stop		Plan retreat path from falling objects.
	Primer bulb		Wear slip resistant foot wear.
H	Carburetor adjustment - High speed mixture		Ignition ON/OFF
L	Carburetor adjustment - Low speed mixture	T	Carburetor adjustment - Idle speed
	Choke Control "Cold Start" Position (Choke Closed)		Choke Control "Run" Position (Choke Open)

SAFETY INSTRUCTIONS

PERSONAL CONDITION AND SAFETY EQUIPMENT

WARNING DANGER

Hedge Clipper users risk injury to themselves and others if the hedge clipper is used improperly and or safety precautions are not followed. Proper clothing and safety gear must be worn when operating a hedge clipper.

Physical Condition

Your judgment and physical dexterity may not be good:

- if you are tired or sick,
- if you are taking medication,
- if you have taken alcohol or drugs.

Operate unit only if you are physically and mentally well.

Eye Protection

Eye protection that meets ANSI Z87.1 or CE requirements must be worn whenever you operate the unit.

Hand Protection

Wear no-slip, heavy duty work gloves to improve your grip on the handles. Gloves also reduce the transmission of machine vibration to your hands.

Hearing Protection

Wear hearing protection. ECHO recommends wearing hearing protection whenever unit is used.

Proper Clothing

Wear snug fitting, durable clothing;

- Pants should have long legs, shirts with long sleeves.
- **DO NOT WEAR SHORTS,**
- **DO NOT WEAR TIES, SCARFS, JEWELRY.**

Wear protective hair covering to contain long hair.

Wear sturdy work shoes with nonskid soles;

- **DO NOT WEAR OPEN TOED SHOES,**
- **DO NOT OPERATE UNIT BAREFOOTED.**

Wear no-slip, heavy duty work gloves.

EXTENDED OPERATION/EXTREME CONDITIONS

Vibration and Cold

It is believed that a condition called Raynaud's Phenomenon, which affects the fingers of certain individuals, may be brought about by exposure to vibration and cold. Exposure to vibration and cold may cause tingling and burning sensations, followed by loss of color and numbness in the fingers. The following precautions are strongly recommended, because the minimum exposure which might trigger the ailment is unknown.

- Keep your body warm, especially the head, neck, feet, ankles, hands, and wrists.
- Maintain good blood circulation by performing vigorous arm exercises during frequent work breaks, and also by not smoking.
- Limit the hours of operation. Try to fill each day with jobs where operating the unit or other hand-held power equipment is not required.
- If you experience discomfort, redness, and swelling of the fingers followed by whitening and loss of feeling, consult your physician before further exposing yourself to cold and vibration.

Repetitive Stress Injuries

It is believed that overusing the muscles and tendons of the fingers, hands, arms, and shoulders may cause soreness, swelling, numbness, weakness, and extreme pain in those areas. Certain repetitive hand activities may put you at a high risk for developing a Repetitive Stress Injury (RSI). An extreme RSI condition is Carpal Tunnel Syndrome (CTS), which could occur when your wrist swells and squeezes a vital nerve that runs through the area. Some believe that prolonged exposure to vibration may contribute to CTS. CTS can cause severe pain for months or even years.

To reduce the risk of RSI/CTS, do the following:

- Avoid using your wrist in a bent, extended, or twisted position. Instead try to maintain a straight wrist position. Also, when grasping, use your whole hand, not just the thumb and index finger.
- Take periodic breaks to minimize repetition and rest your hands.
- Reduce the speed and force with which you do the repetitive movement.
- Do exercises to strengthen the hand and arm muscles.
- Immediately stop using all power equipment and consult a doctor if you feel tingling, numbness, or pain in the fingers, hands, wrists, or arms. The sooner RSI/CTS is diagnosed, the more likely permanent nerve and muscle damage can be prevented.

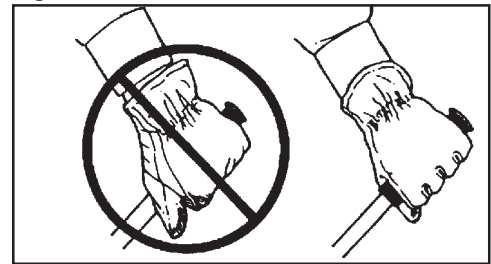

EQUIPMENT

WARNING DANGER

Use only ECHO approved attachments. Serious injury may result from the use of a non-approved attachment combination. ECHO, INC. will not be responsible for the failure of cutting devices, attachments, or accessories which have not been tested and approved by ECHO. Read and comply with all safety instructions listed in this manual and safety manual.

- Check unit for loose/missing nuts, bolts, and screws. Tighten and/or replace as needed.
- Inspect fuel lines, tank and area around carburetor for fuel leaks. DO NOT operate unit if leaks are found.
- Never adjust blades when the engine is operating.
- Inspect hand guard for damage. Replace if damaged or missing.
- Check that the blade assembly is firmly attached and in safe operating condition. Dull, loose or damaged blades should not be used.
- Keep exhaust area clear of flammable debris. Avoid contact during and immediately after operation.

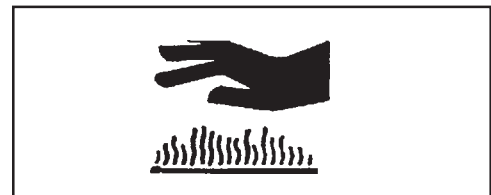

SAFE OPERATION

WARNING DANGER

Do not operate this product indoors or in inadequately ventilated areas. Engine exhaust contains poisonous emissions and can cause serious injury or death.

Read the Manual

- Provide all users of this equipment with the Operator's Manual and Safety Manual for instructions on Safe Operation.

Clear the Work Area

- Spectators and fellow workers must be warned, and children and animals prevented from coming nearer than 15 m (50 ft.) while the unit is in use.

Keep a Firm Grip

- Hold the front and rear handles with both hands, with thumbs and fingers tightly encircling the handles.

Keep a Solid Stance

- Maintain footing and balance at all times. Do not stand on slippery, uneven or unstable surfaces. Do not work in odd positions or on ladders. Do not over reach.

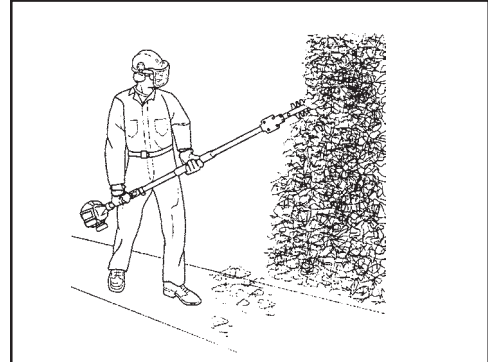

EMISSION CONTROL

EPA Phase 2

The emission control system for this engine is EM (Engine Modification).

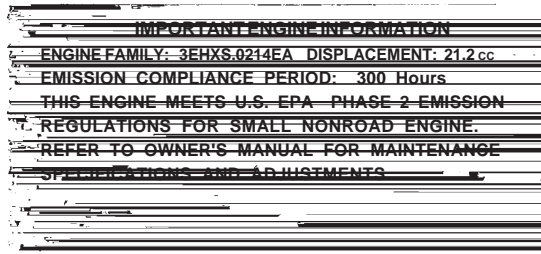

Emission Control Label (located on Engine) (EXAMPLE ONLY, information on label varies by FAMILY).

PRODUCT EMISSION DURABILITY

The 300 hour emission durability compliance period is the time span selected by the manufacturer certifying the engine emissions output meets applicable emissions regulations, provided that approved maintenance procedures are followed as listed in the Maintenance Section of this manual.

DESCRIPTION



The ECHO product you have purchased has been factory pre-assembled for your convenience. Due to packaging restrictions, some assembly of SHC-210 is required.

After opening the carton, check for damage. Immediately notify your retailer or ECHO Dealer of damaged or missing parts. Use the contents list to check for missing parts.

CONTENTS LIST

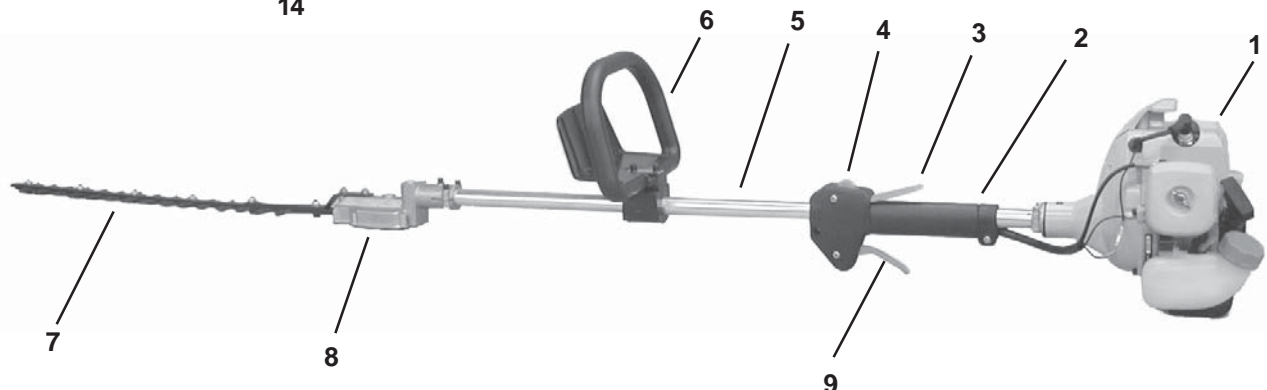
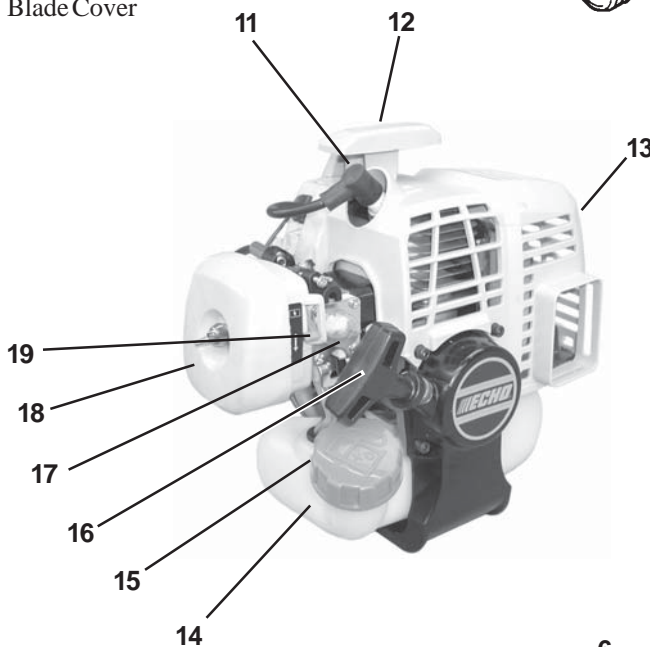
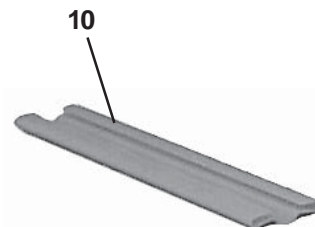
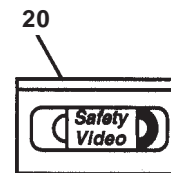
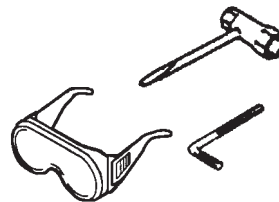
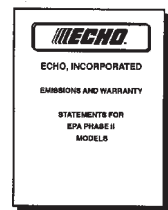
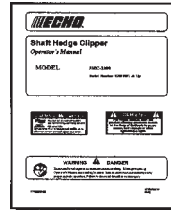
- ___ 1 - Power Head/Driveshaft Assembly
- ___ 1 - Hedge Clipper Assembly
- ___ 1 - Operator's Manual
- ___ 1 - Hedge Clipper Safety Manual
- ___ 1 - Warranty Statement
- ___ 1 - Warranty Registration Card
- ___ 1 - Echo Power Blend™ 2-stroke oil sample
- ___ 1 - T-Wrench
- ___ 1 - 4 mm Hex Wrench
- ___ 1 - Safety Glasses
- ___ 1 - Blade Cover



1. **POWER HEAD** - Includes the Engine, Clutch, Fuel System, Ignition System and Recoil Starter.
2. **GRIP, RIGHT HAND REAR** - Cushioned grip for right hand.
3. **THROTTLE TRIGGER LOCKOUT** - This lever must be held during starting. Operation of the throttle trigger is prevented unless throttle trigger lockout lever is engaged.
4. **STOP SWITCH** - mounted on top of the Throttle Trigger Housing. Move switch FORWARD to RUN, BACK to STOP.
5. **DRIVE SHAFT ASSEMBLY** - Contains the Flexible Drive Cable.
6. **FRONT LEFT HAND LOOP HANDLE** - Adjustable, loop handle for proper cutting attitude and operator comfort.
7. **BLADES** - Double reciprocating blades mounted to a blade support bar. Double sided blades, are capable of cutting on either side.
8. **GEAR HOUSING ASSEMBLY** - Gear housing assembly fixed straight extension.
9. **THROTTLE TRIGGER** - Spring loaded to return to idle when released. During acceleration, depress gradually for best operating technique.
10. **BLADE COVER** - Used to cover blade during transport and storage. Remove blade cover before using unit.
11. **SPARK PLUG** - Provides spark to ignite fuel mixture.
12. **TOP GUARD** - Protects arm from the hot engine.
13. **SPARK ARRESTOR - CATALYTIC MUFFLER / MUFFLER** - The muffler or catalytic muffler controls exhaust noise and emission. The spark arrestor screen prevents hot, glowing particles of carbon from leaving the muffler. Keep exhaust area clear of flammable debris.
14. **FUEL TANK** - Contains fuel and fuel filter.
15. **FUEL TANK CAP** - Covers and seals fuel tank opening.
16. **RECOIL STARTER HANDLE** - Pull handle slowly until starter engages, then quickly and firmly. When engine starts, return handle slowly. DO NOT let handle snap back or damage to unit will occur.
17. **PRIMER BULB** - Pumping primer bulb before starting engine draws fresh fuel from the fuel tank priming the carburetor for starting. Pump primer bulb until fuel is visible and flows freely in the clear fuel tank return line. Pump bulb an additional 4 or 5 times.
18. **AIR CLEANER** - Contains replaceable filter element.
19. **CHOKE CONTROL** - Located on the air cleaner housing. Move the lever to Cold Start () to close the choke for Cold Starting. Move lever to Run () position after engine fires.
20. **SAFETY VIDEO** - (Not included with unit) P/N 99922202800 English version is available at a cost of \$5.00 from ECHO, INC. or any authorized ECHO dealer. The video overviews safety precautions and proper operating techniques and is supplemental to the Safety Manual. Read and understand the Safety Manual for complete information on safe operation.

SPECIFICATIONS

MODEL	SHC-210
Length	1790mm(70.5in.)
Width	250mm(9.84in.)
Height	270mm(10.6in.)
Weight (dry)	5.87kg(12.9lb.)
Engine Type	Air cooled, two-stroke, single cylinder gasoline engine
Bore	32.2mm(1.27in.)
Stroke	26.0mm(1.02in.)
Displacement	21.2 cc (1.29 cu. in.)
Exhaust	Spark Arrestor Muffler
Carburetor	Zama RB Diaphragm w/Purge Pump
Ignition System	Flywheel Magneto, CDI (capacitor discharge ignition) with ESG
Spark Plug	NGK BPMR-8Y (Gap 0.65 mm (0.026 in.))
Fuel	Mixed (Gasoline and Two-stroke Oil)
Fuel/Oil Ratio	50:1 two-stroke air cooled engine oil
Gasoline	89 Octane unleaded. DO NOT use fuel containing methyl alcohol, more than 10% ethyl alcohol or 15% MTBE.
Oil	Power Blend™ Premium Universal 2-Stroke Oil
Fuel Tank Capacity	0.45 lit. (15.2 US fl. oz.)
Recoil Starter System	Automatic Recoil Starter
Clutch	Centrifugal Type
Gear Case Ratio	5.88:1
Cutter	Double Reciprocating Blade - Double Edge
Length	490mm(19.3in.)
Pitch	35mm(1.4in.)
Idle Speed	2,400-3,200RPM
Wide Open Throttle Speed	10,000-12,000RPM

IMPORTANT This spark ignition system complies with Canadian ICES-002

ASSEMBLY

Tools Required: 4 mm hex wrench, screwdriver

Parts Required: Power Head/Drive Shaft Assembly and Gear Housing Assembly

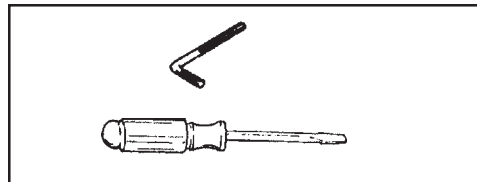

GEAR HOUSING ASSEMBLY/DRIVE SHAFT

WARNING DANGER

Hedge Clipper Blades are very sharp. Wear gloves to protect hands.

1. Remove protective cap from drive shaft end.
2. Remove locating screw (A) and align the locating hole in the gear case with the locating hole (B) in the drive shaft housing.
3. Slide the gear housing assembly on the drive shaft. Be certain the flex drive shaft engages the hole in driver gear and install locating screw (A).
4. Tighten screw (A) and clamping bolts (C).

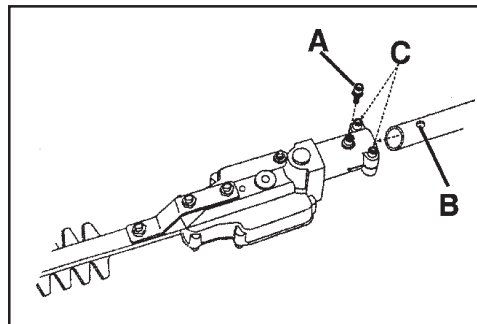

PRE-OPERATION

FUEL

Fuel Requirements

Gasoline - Use 89 Octane [R + M/2] (mid grade or higher) gasoline known to be good quality. Gasoline may contain up to 15% MTBE (methyl tertiary-butyl ether). Gasohol containing methyl (wood) alcohol is **NOT** approved.

Two Stroke Oil - A two-stroke engine oil meeting ISO-L-EGD (ISO/CD 13738) and J.A.S.O. FC Standards must be used. Echo brand premium Power Blend™ Universal 2-Stroke Oil meets these standards. Engine problems due to inadequate lubrication caused by failure to use an ISO-L-EGD and J.A.S.O. FC certified oil, such as Echo premium Power Blend™, will void the two-stroke engine warranty. (Emission related parts only are covered for two years, regardless of two-stroke oil used, per the statement listed in the Emission Defect Warranty Explanation.)

IMPORTANT

Echo premium Power Blend™ Universal 2-Stroke Oil may be mixed at 50:1 ratio for application in all Echo engines sold in the past regardless of ratio specified in those manuals.

Mixing Instructions

1. Fill an approved fuel container with half of the required amount of gasoline.
2. Add the proper amount of 2-stroke oil to gasoline.
3. Close container and shake to mix oil with gasoline.
4. Add remaining gasoline and remix.
5. Install fuel container cap and wipe any spilled fuel from container and surrounding area.

Handling Fuel

WARNING **DANGER**

Fuel is **VERY** flammable. Use extreme care when mixing, storing or handling or serious personal injury may result.

- Use an approved fuel container.
- **DO NOT** smoke near fuel.
- **DO NOT** allow flames or sparks near fuel.
- Fuel tanks/cans may be under pressure. Always loosen fuel caps slowly allowing pressure to equalize.
- **NEVER** refuel a unit when the engine is **HOT!**
- **NEVER** refuel a unit with the engine running.
- **DO NOT** fill fuel tanks indoors. **ALWAYS** fill fuel tanks outdoors over bare ground.
- Securely tighten fuel cap after refueling.
- Inspect for fuel leakage. If fuel leakage is found, do not start or operate unit until leakage is repaired.

IMPORTANT

Spilled fuel is a leading cause of hydrocarbon emissions. Some states may require the use of automatic fuel shut-off containers to reduce fuel spillage. Contact your ECHO dealer for ordering information.

After Refueling

- Wipe any spilled fuel from the unit.
- Move at least 3 m (10 ft.) from refueling location before starting the engine.

After use

- **DO NOT** store a unit with fuel in its tank. Leaks can occur. Return unused fuel to an approved fuel storage container.

Storage - Fuel storage laws vary by locality. Contact your local government for the laws affecting your area. As a precaution, store fuel in an approved, air tight container. Store in a well ventilated, unoccupied building, away from sparks and flames. Do not store fuel longer than 30 days.

IMPORTANT

Stored fuel ages. Do not mix more fuel than you expect to use in thirty (30) days, ninety (90) days when a fuel stabilizer is added.

IMPORTANT

Stored two-stroke fuel may separate. **ALWAYS** shake fuel container thoroughly before each use.

OPERATION

STARTING COLD ENGINE

WARNING DANGER

The attachment will operate immediately when the engine starts and could result in loss of control and possible serious injury. Keep movable parts of the attachment off the ground and away from objects that could become entangled or thrown.

1. *Stop Switch*
Move Stop Switch button away from the STOP position.
2. *Choke*
Move choke (B) to Cold Start  position.
3. *Primer*
Pump primer bulb (C) until fuel is visible and flows freely in the clear fuel tank return line. Pump bulb an additional 4 or 5 times.

4. *Recoil Starter*
Lay the unit on a flat area and keep movable attachment parts clear of all obstacles. Firmly grasp right hand grip and throttle trigger lockout with left hand and fully depress throttle trigger to wide open position. Rapidly pull recoil starter handle/rope (D) until engine fires (or maximum five [5] pulls).
5. *Choke*
After engine fires or five (5) pulls, move choke lever back to Run  position. Hold throttle trigger and throttle trigger lockout fully depressed, and pull starter handle/rope until engine starts and runs. Release throttle trigger and allow unit to warm up at idle for several minutes.

NOTE

If engine does not start with choke in Run position after 5 pulls, repeat instructions 2 -5.

6. *Throttle Trigger*
After engine warm up, gradually depress throttle trigger to increase engine RPM to operating speed.

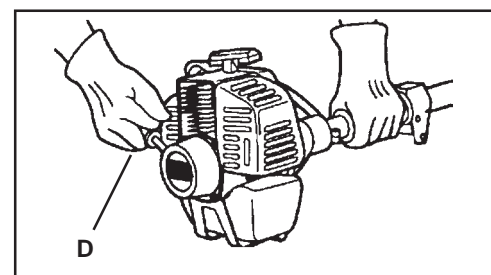
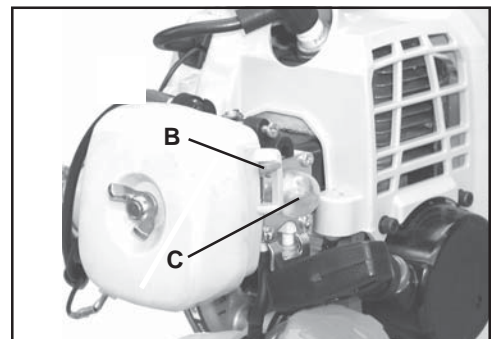
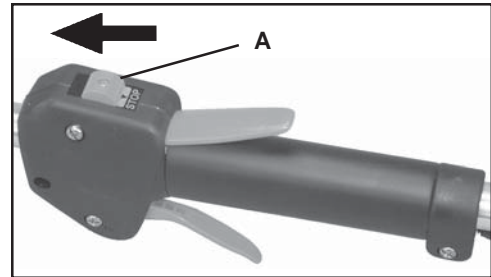

STARTING WARM ENGINE

The starting procedure is the same as Cold Start except DO NOT close the choke, and do not depress throttle trigger to wide open position.

WARNING DANGER

The attachment should not move at idle, otherwise serious personal injury may result.

NOTE

If attachment moves, readjust carburetor according to “Carburetor Adjustment” instructions in this manual or see your ECHO Dealer.

1. *Stop Switch*
Move Stop Switch button (A) away from the STOP position.

2. *Primer*
Pump primer bulb (C) until fuel is visible and flows freely in the clear fuel tank return line. Pump bulb an additional 4 or 5 times.

3. *Recoil Starter*
Lay the unit on a flat area and keep movable attachment parts clear of all obstacles. Rapidly pull recoil starter handle/rope (D) until engine fires.

NOTE

If engine does not start after 5 pulls, use Cold Start Procedure.

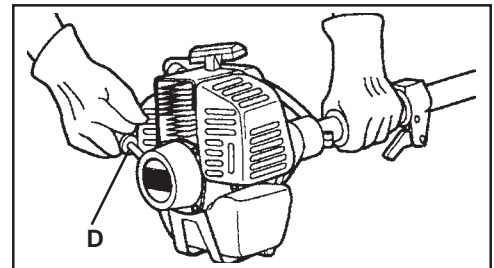
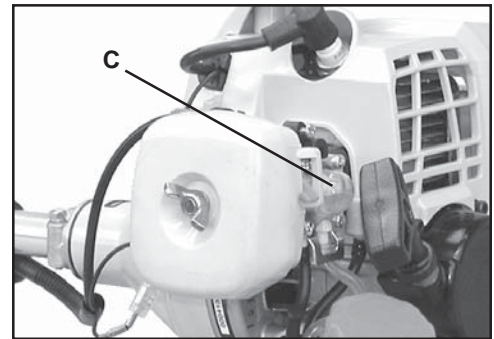
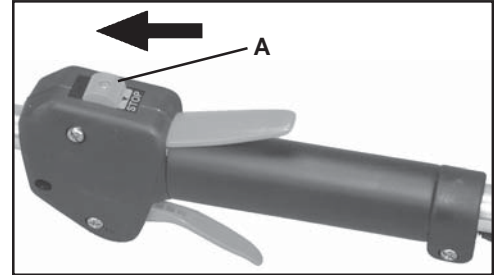

STOPPING ENGINE

1. *Throttle*
Release throttle and allow engine to return to idle before shutting off engine.

2. *Stop Switch*
Move stop switch button (A) backward to STOP position.

WARNING DANGER

If engine does not stop when stop switch is moved to STOP position, close choke - COLD START position - to stall engine. Have your ECHO dealer repair stop switch before using hedge clipper again or serious personal injury may result.

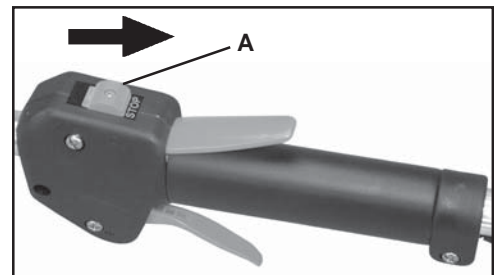

MAINTENANCE

Your ECHO product is designed to provide many hours of trouble free service. Regular scheduled maintenance will help achieve that goal. If you are unsure or are not equipped with the necessary tools, you may want to take your unit to an ECHO Service Dealer for maintenance. To help you decide whether you want to DO-IT-YOURSELF or have the ECHO Dealer do it, each maintenance task has been graded. If the task is not listed, see your ECHO Dealer for repairs.

SKILL LEVELS

- Level 1**= Easy to do. Most required tools come with unit.
- Level 2**= Moderate difficulty. Some specialized tools may be required.
- Level 3**= Experience required. Specialized tools are required. ECHO recommends that the unit be returned to your ECHO dealer for service.

ECHO offers **REPOWER™** Maintenance Kits and Parts to make your maintenance job easier. Just below each task heading are listed the various part numbers required for that task. See your ECHO dealer for these parts.

MAINTENANCE INTERVALS

COMPONENT/ SYSTEM	MAINTENANCE PROCEDURE	REQ'D SKILL LEVEL	DAILY OR BEFORE USE	EVERY REFUEL	3 MONTHS OR 90 HOURS	6 MONTHS OR 270 HOURS	YEARLY 600 HOURS
Recommended Echo Dealer Maintenance Procedures							
Cylinder Exhaust Port	Inspect/Clean/Decarbon	3			I / C		
Sharpen Blades	Inspect/Clean	3	I (3)				
Do-it-Yourself Maintenance Procedures							
Air Filter	Inspect/Clean/Replace	1	I / C		R*		
Choke	Inspect/Clean	2	I / C				
Fuel Filter	Inspect/Replace	1			I		R *
Fuel System, leaks	Inspect/Replace	1	I *	I			
Cooling System	Inspect/Clean	2	I / C				
Muffler Spark Arrestor	Inspect/Replace	2			I / R *		
Drive Shaft	Grease	2	I (1)				
Gear Housing	Grease	2	I (2)				
Blades	Inspect/Clean	1	I / C (3)				
Recoil Starter Rope	Inspect/Clean	1	I / C *				
Spark Plug	Inspect/Clean	2			I / C	R *	
Screws/Nuts/Bolts	Inspect/Tighten/Replace	1	I / R *				

MAINTENANCE PROCEDURE LETTER CODES: I = INSPECT, R = REPLACE, C = CLEAN

IMPORTANT NOTE - Time intervals shown are maximum. Actual use and your experience will determine the frequency of required maintenance.

MAINTENANCE PROCEDURE NOTES:

(1) Apply ECHO® LUBE™ every 25 hours.

(2) Apply ECHO® LUBE™ every 15 - 25 hours

(3) Inspect blade and clean and sharpen as needed. Lubricate blades periodically during use.

* All recommendations to replace are based on the finding of damage or wear during inspection..

AIR FILTER

Level 1.

Tools required: 25 or 50 mm (1 or 2 in.) cleaning brush

Parts required: 90008 REPOWER™ Air & Fuel Filter Kit

1. Close choke (Cold Start Position ). This prevents dirt from entering the carburetor throat when the air filter is removed. Brush accumulated dirt from the air cleaner area.
2. Remove the air cleaner cover. Clean and inspect the element for damage. If element is fuel soaked and very dirty, replace.
3. If element can be cleaned and reused, be certain it:
 - properly fits the cavity in the air cleaner cover.
 - is installed with the original side out.

NOTE

Carburetor adjustment may be needed after air filter cleaning/replacement. See Carburetor Adjustment Section.

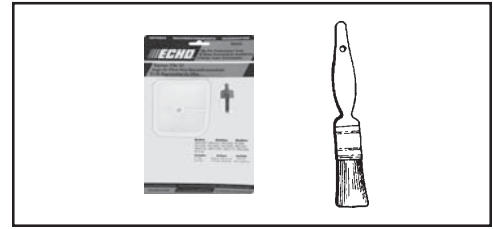

FUEL FILTER

Level 1.

Tools required: 200-250 mm (8-10 in.) length of wire with one end bent into a hook, clean rag, funnel, and an approved fuel container

Parts required: 90008 REPOWER™ Air & Fuel Filter Kit

WARNING DANGER

Fuel is **VERY** flammable. Use extreme care when mixing, storing or handling or serious personal injury may result.

1. Use a clean rag to remove loose dirt from around fuel cap and empty fuel tank.
2. Use the “fuel line hook” to pull the fuel line and filter from the tank.
3. Remove the filter from the line and install the new filter.



SPARK PLUG

Level 2.

Tools Required: T-Wrench, feeler gauge, soft metal brush

Parts Required: Spark Plug, NGK BPMR-8YP/NA425000000

1. Remove spark plug and check for fouling, worn and rounded center electrode.
2. Clean the plug or replace with a new one. DO NOT sand blast to clean. Remaining sand will damage engine.
3. Adjust spark plug gap by bending outer electrode.
4. Tighten spark plug to 145-155 kg/cm (125-135 in. lb.).

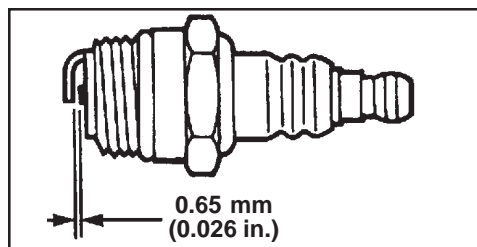
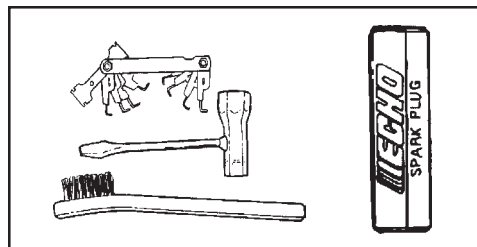

COOLING SYSTEM CLEANING

Level 2.

Tools required: Cross head screwdriver, 3 mm, 4 mm hex wrench, 25 or 50 mm (1 or 2 in.) cleaning brush

Parts Required: None.

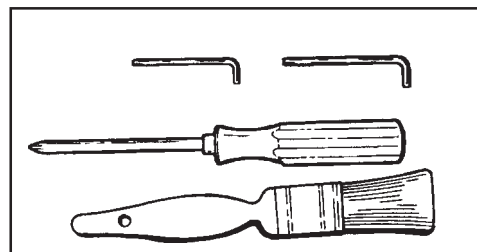

IMPORTANT

To maintain proper engine operating temperatures, cooling air must pass freely through the cylinder fin area. This flow of air carries combustion heat away from the engine.

Overheating and engine seizure can occur when:

- Air intakes are blocked, preventing cooling air from reaching the cylinder.
- Dust and grass build up on the outside of the cylinder. This build-up insulates the engine, and prevents the heat from escaping.

Removal of cooling passage blockages or cleaning of cooling fins is considered "Normal Maintenance." Any failure attributed to lack of maintenance is not warranted.

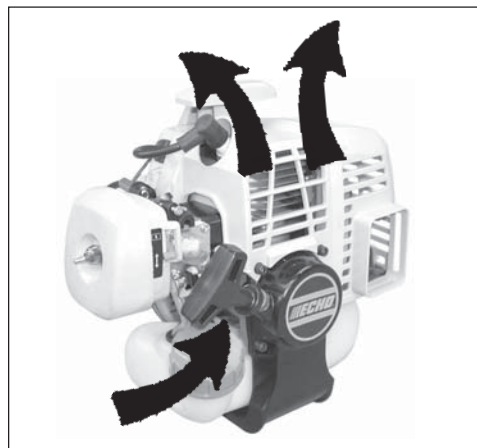

1. Disconnect spark plug lead from spark plug.
2. Remove (1) screw from top guard, and remove guard.
3. Remove (4) screws from engine/muffler cover, and remove cover.
4. Use the brush to remove dirt form cylinder fins.
5. Remove grass and leaves from the grid between the recoil starter and fuel tank.
6. Assemble components in reverse order.

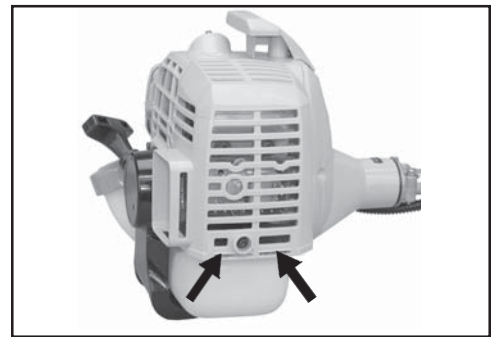
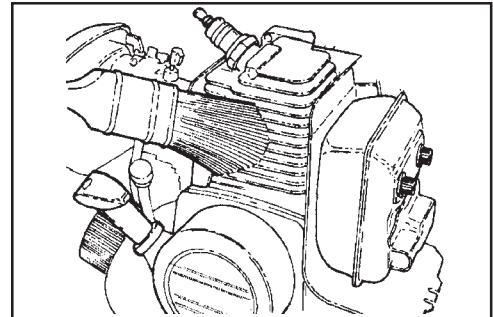
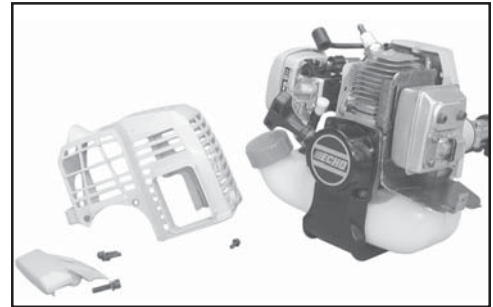

NOTE

When installing the engine/muffler cover, be certain the tabs of the metal deflector shield are in the slots of the cover.

EXHAUST SYSTEM

Spark Arrestor Screen

Level 2.

Tools Required: Cross head screwdriver, soft metal brush.

Parts Required: Spark Arrestor Screen P/N 14586240630,
Gasket P/N 14586642031

1. Remove engine/muffler cover (A). See "Cleaning Cooling System" pages 16 and 17 for step by step instructions.
2. Place piston at Top Dead Center (TDC) to prevent carbon/dirt from entering cylinder.
3. Remove spark arrestor screen cover (B), gasket (C), and screen (D) from muffler body.
4. Clean carbon deposits from muffler components.
5. Replace screen if it is cracked, plugged or has holes burned through.

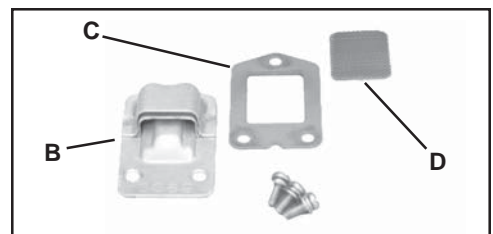
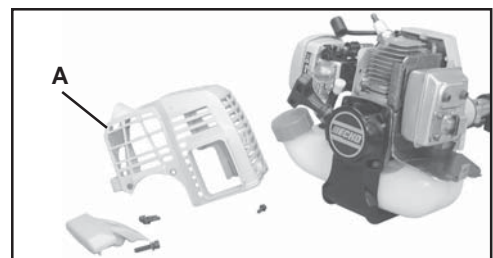
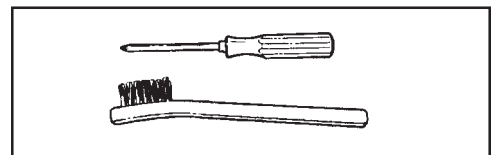

6. Assemble components in reverse order.

NOTE

When installing the engine/muffler cover, be certain the tabs of the metal deflector shield are in the slots of the cover.

Cylinder Exhaust Port

Level 3.

IMPORTANT

The cylinder exhaust port must be inspected and cleaned of excess carbon every 3 months or 90 hours of operation in order to maintain this engine within the emissions durability period. ECHO strongly recommends that you return your unit to your ECHO dealer for this important maintenance service.

CARBURETOR ADJUSTMENT

Engine Break-In

New engines must be operated for a minimum of two tanks of fuel before carburetor adjustments can be made. During the break-in period, your engine performance will increase and exhaust emissions will stabilize. Idle speed can be adjusted as required.

High Altitude Adjustment

High altitude adjustment is not required for proper operation of this engine.

Idle Speed Adjustment

Idle speed adjustment may be required periodically to comply with specifications for this unit. See page 9, "Specifications," for correct idle speed.

Level 2.

Tools required: Screwdriver, tachometer (ECHO P/N 99051130017)

NOTE

Every unit is run at the factory and the carburetor is set in compliance with emission regulations. This carburetor does not have acceleration and high speed adjustment needles.

1. Check idle speed using a tachometer, and reset if necessary. Turn idle screw (A) clockwise to increase idle speed; counter clockwise to decrease idle speed.

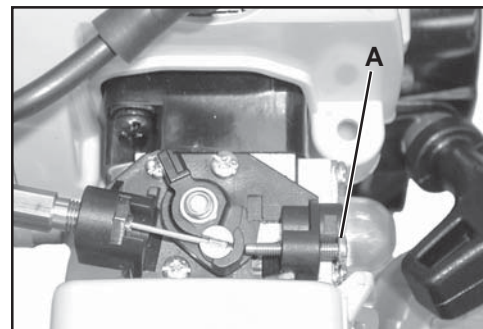
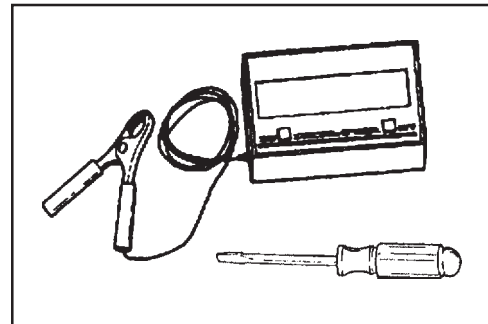

WARNING  **DANGER**

When carburetor adjustment is completed, blades should not move at idle, otherwise serious personal injury may result.

LUBRICATION

Blades

Level 1.

Tools Required: Clean rag, cleaning brush , oil can

Parts Required: 20W Engine Oil (lubrication), 50-50 mixture of kerosene and 20W oil (cleaning)

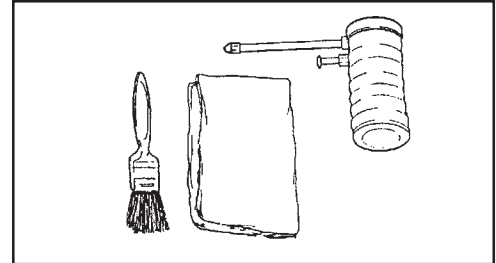

WARNING DANGER

Blades are very sharp. Wear gloves to protect hands, otherwise serious personal injury may result.

1. Brush loose debris from blade and coat both sides of blade with the 50-50 cleaning mixture.
2. Allow cleaning mixture to soften the remaining gummy residue then wipe it from the blade.
3. Apply clean oil to the entire length of the blade. Be certain the blade bolts are lubricated.
4. Wipe excess oil from the blade before putting the unit back in service.

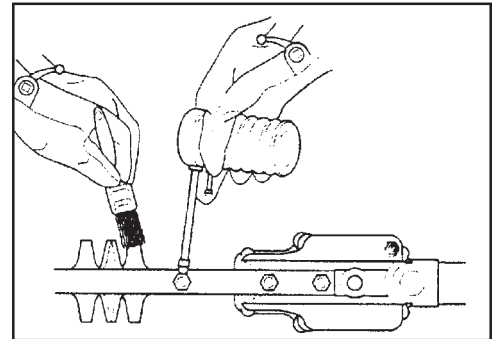

Gear Case

Level 2.

Tools required: Grease gun with Lithium Grease, clean rag

Parts required: ECHO® LUBE™ 14 oz. cartridge P/N91015 or Lithium Based Grease

1. Clean dirt from grease fitting.
2. Carefully pump grease in fitting (A). **DO NOT** force grease. Too much pressure will force grease past seals and cause damage. **Apply 1-2 pumps of grease every 15-25 hours of operation.**

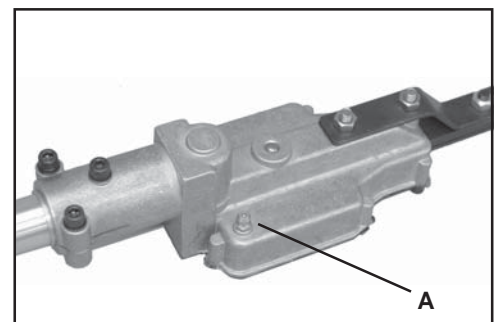

Drive Shaft Assembly

Level 1.

NOTE

Hedge Clipper drive shaft should be greased every 25 hours of operation.

Tools required: 4 mm Hex wrench, screwdriver, clean rag, small brush

Parts required: ECHO® LUBE™ 14 oz. cartridge P/N91015 or Lithium Based Grease

WARNING DANGER

Blades are very sharp. Wear gloves to protect hands, otherwise serious personal injury may result.

1. Loosen gear housing assembly locating screw (A) and mounting screws (C). Remove the gear box from the drive shaft housing.
2. Pull the drive shaft (B) from the housing, wipe clean and re-coat with a thin coating [1/2 oz. (15 ml)] of grease.
3. Slide the drive shaft back in the drive housing being careful not to get dirt on the flex shaft.
4. Install the gear housing assembly.

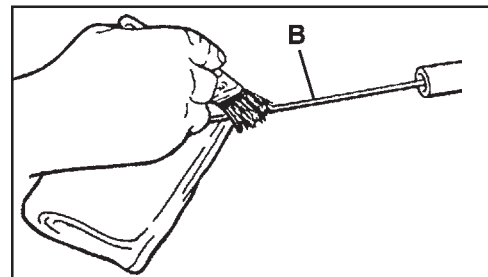
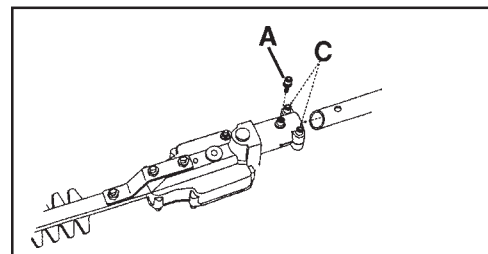
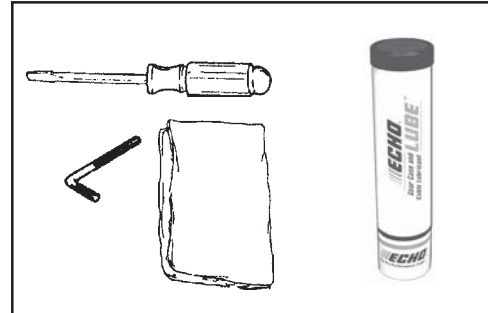

SHARPENING BLADES

Level 3.

Tools required: (2) 10 mm wrenches, flat file, screwdriver

Parts required: None

WARNING DANGER

Hedge Clipper Blades are very sharp. Wear gloves to protect hands.

1. Disconnect spark plug wire from spark plug.
2. Slide blades to midpoint cutting position using slots (A) on bottom of blades. Do not pry against cutting edges.
3. File each edge carefully. Follow the original shape of the blade.

IMPORTANT

If a power grinder is used, **DO NOT** allow blade to over heat.

4. Lubricate blades. See "Lubrication" on page 19.

Blade Adjustment

IMPORTANT

Blades should only be removed and reinstalled by an Authorized ECHO Servicing Dealer, otherwise premature wear or internal damage may occur.

1. Tighten blade bolts until snug, then loosen blade bolts 1/2 turn.
2. Hold blade bolts from turning using 10 mm wrench, and tighten blade lock nuts with other 10 mm wrench.

NOTE

Locking ability of Hedge Clipper blade lock nuts will diminish each time they are removed. Replace if turning resistance is not felt when installing locknuts.

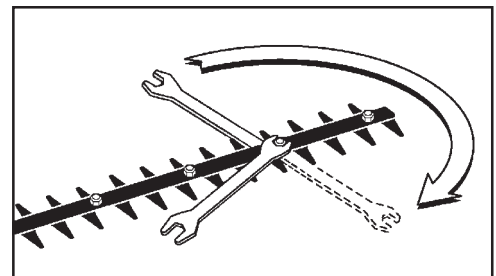
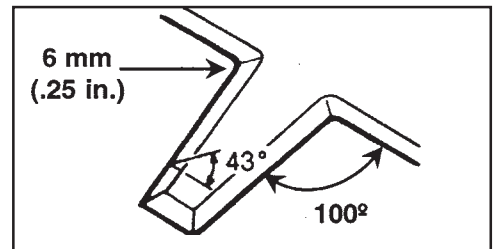
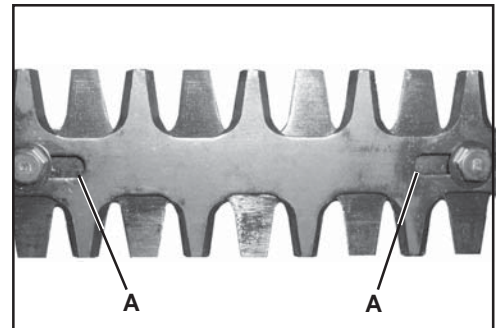
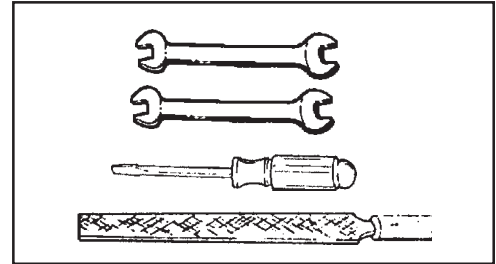

TROUBLESHOOTING

ENGINE PROBLEM TROUBLESHOOTING CHART

Problem	Check	Status	Cause	Remedy
Engine cranks - starts hard/ doesn't start	Fuel at carburetor	No fuel at carburetor	Fuel strainer clogged Fuel line clogged Carburetor	Clean or replace Clean or replace See your Echo dealer
	Fuel at cylinder	No fuel at cylinder	Carburetor	See your Echo dealer
		Muffler wet with fuel	Fuel Mixture too rich	Open choke Clean/replace air filter Adjust carburetor See your Echo dealer
	Spark at end of plug wire	No spark	Stop switch off Electrical problem Interlock switch	Turn switch to ON See your Echo dealer See your Echo dealer
	Spark at plug	No spark	Spark gap incorrect Covered with carbon Fouled with fuel Plug defective	Adjust to .65mm (0.026 in.) Clean or replace Clean or replace Replace plug
	Air filter	Air filter dirty	Normal wear	Clean or replace
	Fuel filter	Fuel filter dirty	Contaminants/residues in fuel	Replace
	Fuel vent	Fuel vent plugged	Contaminants/residues in fuel	Clean or replace
	Spark Plug	Plug dirty/worn	Normal wear	Clean and adjust or replace
	Carburetor	Improper adjustment	Vibration	Adjust
Engine runs, but dies or does not accelerate properly	Cooling System	Cooling system dirty/plugged	Extended operation in dirty/dusty locations	Clean
	Spark Arrestor Screen	Spark arrestor screen plugged	Normal wear	Replace
Engine does not crank	N/A	N/A	Internal engine problem	See your Echo dealer

WARNING DANGER

Fuel vapors are **extremely** flammable and may cause fire and/or explosion. **Never** test for ignition spark near an open spark plug opening, otherwise serious personal injury may result.

STORAGE

WARNING  **DANGER**

During operation the muffler or catalytic muffler and surrounding cover become hot. Always keep exhaust area clear of flammable debris during transportation or when storing, otherwise serious personal injury may result.

Long Term Storage (over 30 days)

Do not store your unit for a prolonged period of time (30 days or longer) without performing protective storage maintenance which includes the following:

1. Store unit in a dry, dust free place, out of the reach of children.

WARNING  **DANGER**

Do not store in enclosure where fuel fumes may accumulate or reach an open flame or spark, otherwise serious personal injury may result.

- | | |
|---|--|
| <ol style="list-style-type: none"> 2. Place the stop switch in the "OFF" position. 3. Remove accumulation of grease, oil, dirt and debris from exterior of unit. 4. Perform all periodic lubrication and services that are required. 5. Apply clean oil to the entire length of the blade. Be certain the blade bolts are lubricated. 6. Install blade cover on blades. 7. Tighten all the screws and nuts. 8. Drain the fuel tank completely and pull the recoil starter handle several times to remove fuel from the carburetor. | <ol style="list-style-type: none"> 9. Remove the spark plug and pour 7cc (1/4 oz.) of fresh, clean, two-stroke engine oil into the cylinder through the spark plug hole. <ol style="list-style-type: none"> A. Place a clean cloth over the spark plug hole. B. Pull the recoil starter handle 2-3 times to distribute the oil inside the engine. C. Observe the piston location through the spark plug hole. Pull the recoil handle slowly until the piston reaches the top of its travel and leave it there. 10. Install the spark plug (do not connect ignition cable). |
|---|--|

IMPORTANT

Always store and transport Shaft Hedge Clipper in a stable, horizontal position. Support gear case and cutting blades to prevent excessive flexing, which may cause damage to the cutting attachment.

SERVICING INFORMATION

PARTS

Genuine ECHO Parts and ECHO REPOWER™ Parts and Assemblies for your ECHO products are available only from an Authorized ECHO Dealer. When you do need to buy parts **always** have the Model Number and Serial Number of the unit with you. You can find these numbers on the engine housing. For future reference, write them in the space provided below.

Model No. _____ SN. _____

SERVICE

Service of this product during the warranty period must be performed by an Authorized ECHO Service Dealer. For the name and address of the Authorized ECHO Service Dealer nearest you, ask your retailer or call: 1-800-432-ECHO (3246). Dealer information is also available on our Web Site. When presenting your unit for Warranty service/repairs, proof of purchase is required.

ECHO CONSUMER PRODUCT SUPPORT

If you require assistance or have questions concerning the application, operation or maintenance of this product you may call the ECHO Consumer Product Support Department at 1-800-673-1558 from 8:30 am to 4:30 pm (Central Standard Time) Monday through Friday. Before calling, please know the model and serial number of your unit to help your Consumer Product Support Representative.

WARRANTY REGISTRATION

You may register your Echo equipment using the warranty registration card or register on-line at www.echo-usa.com. Registering provides a direct link between you and ECHO if we find it necessary to contact you.

ADDITIONAL OR REPLACEMENT MANUALS

Safety Manuals in English/Spanish or English/French are available free of charge from your ECHO dealer, or at www.echo-usa.com.

Operator's and Parts Manuals are available by:

- Downloading free from www.echo-usa.com
- Purchasing from your Echo Dealer.
- Sending a check or money order for \$2.00 per Parts Catalog or \$1.50 per Operator's Manual made payable to ECHO, INCORPORATED. State on a sheet of paper the model number and serial number of the ECHO unit you have, part number of the manual (if known), your name and address and mail to address below.

Safety Videos are available from your Echo dealer. A \$5.00 shipping charge will be required for each video.

Available Parts Catalog

SHC-210

Serial Number 07001001 - 07999999

Part Number 99922203279



ECHO, INCORPORATED

400 OAKWOOD ROAD
LAKE ZURICH, IL 60047

www.echo-usa.com

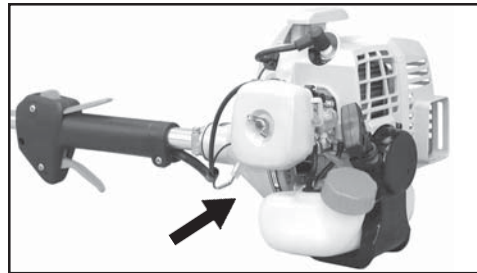

DEALER?

Call

1-800-432-ECHO

or

www.echo-usa.com

**CONSUMER PRODUCT
SUPPORT**

1-800-673-1558

8:30 - 4:30 Mon - Fri C.S.T.

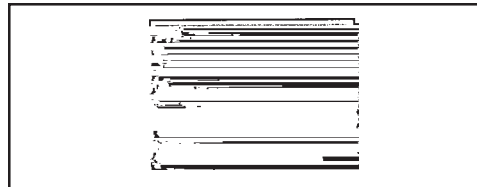

Free Manuals Download Website

<http://myh66.com>

<http://usermanuals.us>

<http://www.somanuals.com>

<http://www.4manuals.cc>

<http://www.manual-lib.com>

<http://www.404manual.com>

<http://www.luxmanual.com>

<http://aubethermostatmanual.com>

Golf course search by state

<http://golfingnear.com>

Email search by domain

<http://emailbydomain.com>

Auto manuals search

<http://auto.somanuals.com>

TV manuals search

<http://tv.somanuals.com>