



# Grass Trimmer/Brush Cutter

## *Operator's Manual*

**MODEL**

**SRM-211**

**SRM-211U**

Serial Number 002001001 - 02999999

**WARNING**  **DANGER**



The muffler or catalytic muffler and surrounding cover may become extremely hot.

Always keep clear of exhaust and muffler area, otherwise serious personal injury may occur.

 **WARNING** 

The engine exhaust from this product contains chemicals known to the State of California to cause cancer, birth defects or other reproductive harm.



**WARNING**  **DANGER**

Read rules for safe operation and instructions carefully. ECHO provides an Operator's Manual and a Safety Manual. Both must be read and understood for proper and safe operation.

X7702272400

X770000180  
06/00

## INTRODUCTION

Welcome to the ECHO family. This ECHO product was designed and manufactured to provide long life and on-the-job-dependability. Read and understand this manual and the SAFETY MANUAL you found in the same package. You will find both easy to use and full of helpful operating tips and SAFETY messages.

### WARNING DANGER

Read rules for safe operation and instructions carefully. ECHO provides an Operator's Manual and a Safety Manual. Both must be read and understood for proper and safe operation.

### THE OPERATOR'S MANUAL --

contains specifications and information for operation, starting, stopping, maintenance, storage and assembly specific to this product.

### THE SAFETY MANUAL --

explains possible hazards involved with the use of Grass Trimmers and Brush Cutters and what measures you should take to make their use safer.

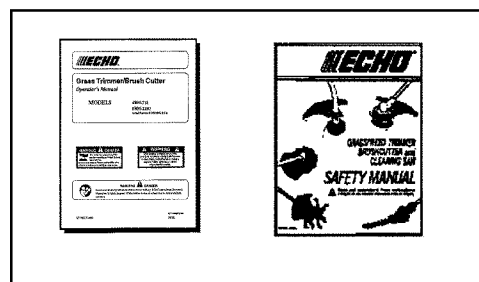

## TABLE OF CONTENTS

Introduction .....	2	Operation .....	24
- The Operator's Manual .....	2	- Starting Cold Engine .....	25
- The Safety manual .....	2	- Starting Warm Engine .....	26
Manual Safety Symbols and Important Information .....	3	- Stopping Engine .....	27
Safety .....	3	Maintenance .....	27
- Decals .....	3	- Skill Levels .....	27
- International Symbols .....	4	- Maintenance Intervals .....	28
- Equipment .....	5	- Air Filter .....	29
- Fuel .....	6	- Fuel Filter .....	29
- Personal Condition and Safety Equipment .....	6	- Spark Plug .....	30
- Safe Operation .....	8	- Cooling System Cleaning .....	30
- Extended Operation/Extreme Conditions .....	9	- Exhaust System .....	32
Description .....	10	- Carburetor Adjustment .....	32
- Contents .....	10*	- Lubrication .....	34
- Blade Terms and Definitions .....	11	- Nylon Line Replacement .....	35
- Emission Control .....	11*	- Sharpening Metal Blades .....	37
Specifications .....	14	Troubleshooting .....	38
Assembly .....	15	Storage .....	39
- Plastic Shield Installation .....	15	Servicing Information .....	40
- Nylon Head Installation .....	15	- Parts .....	40
- Blade Installation .....	16	- ECHO Consumer Product Support .....	40
- Front Handle Installation .....	18	- Service .....	40
- U-Handle Installation .....	18	- Warranty Card .....	40
Pre-Operation .....	20	- Additional or Replacement Manuals .....	40
- Operation with Blades .....	20	- Manual Ordering Instructions .....	40
- Fuel .....	22	*Page 10 Supplement .....	41
- Equipment Check .....	23	*Page 11 Supplement .....	42
- Determine Operation Area .....	24		

Specifications, descriptions and illustrative material in this literature are as accurate as known at the time of publication, but are subject to change without notice. Illustrations may include optional equipment and accessories, and may not include all standard equipment.

## MANUAL SAFETY SYMBOLS AND IMPORTANT INFORMATION

Throughout this manual and on the product itself, you will find safety alerts and helpful, information messages preceded by symbols or key words. The following is an explanation of those symbols and key words and what they mean to you.



This symbol accompanied by the words **WARNING** and **DANGER** calls attention to an act or condition that can lead to serious personal injury to operator and bystanders.



The circle with the slash symbol means whatever is shown within the circle is prohibited.

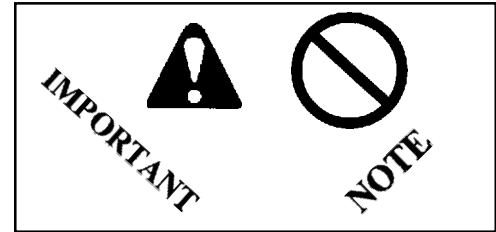

**IMPORTANT** The enclosed message provides information necessary for the protection of the unit.

**NOTE** This enclosed message provides tips for use, care and maintenance of the unit.

## SAFETY

### DECALS

Locate these safety decals on your unit. The complete unit illustration, found in the "DESCRIPTION" section, will help you locate them. Make sure the decals are legible and that you understand and follow the instructions on them. If a decal cannot be read, a new one can be ordered from your ECHO dealer. See PARTS ORDERING instructions for specific information.

#### *Shaft Decal*

#### *Spanish Decal*



89022809560

#### ADVERTENCIA PELIGRO

Esta unidad puede ser peligrosa y producir lesiones personales graves si no se usa en forma adecuada. Para reducir el riesgo de lesionarse, los operadores, los ayudantes y los espectadores deben leer y comprender el Manual Del Operador y los Manuales De Seguridad que se entregan escritos en español.

#### DEBRISSHIELDDECAL P/N 89016841031



Metal Debris  
Shield

#### *English Translation*

#### **WARNING** **DANGER**

This unit can be dangerous and cause serious injury if improperly used. to reduce injury risk to operator, helpers and bystanders, read and understand the Operator's and Safety Manuals, which are provided in Spanish.

## Shaft Decal







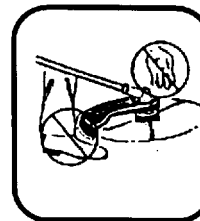
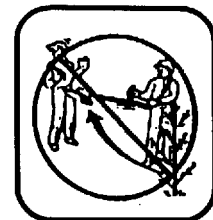

**WARNING**  **DANGER**







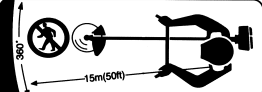

P/N 89016054130

- This unit can be dangerous and cause serious injury if improperly used. To reduce injury risk to operator, helpers and bystanders, read and understand the Operator's and Safety manuals.
- Blindness can occur from objects that are thrown or ricocheted even with shield in place. Operators, helpers and bystanders must wear ANSI Z87.1 approved eye protection.
- Always wear hearing protection when operating unit.
- Prevent accidental contact with unit and any cutting attachment. Maintain a 50 ft. (15M) radius, **DANGER ZONE** surrounding the operator. **ONLY** the operator, dressed in proper protective clothing should be in the **DANGER ZONE**.
- Beware of **KICKOUT (blade thrust)** when using blades. Special precautions are necessary for blade operation, see your Operator's and Safety Manuals. **ONLY** install ECHO approved blades on Brush Cutters (SRM) models equipped with proper blade shield, U-handles, harness, blade collar, nut and cotter pin.
- Blade/Cutting attachment does not stop immediately after releasing throttle. Keep hands and feet clear of blade/cutting attachment unless engine is shut off and cutting attachment is not moving.
- **INSPECT BLADES BEFORE USE.**
- **DO NOT USE DAMAGED, CRACKED, BENT, DULL OR IMPROPERLY SHARPENED BLADES.**
- Do not remove shields, modify the unit or install attachments or parts not approved by ECHO. Approved attachment information and replacement Operator's and Safety Manuals are available from your ECHO dealer or by writing: **ECHO, INCORPORATED, 400 OAKWOOD RD., LAKE ZURICH, IL 60047.**



## INTERNATIONAL SYMBOLS

Symbol form/shape	Symbol description/application	Symbol form/shape	Symbol description/application
	"WARNING, SEE OPERATOR'S MANUAL"		Hot Surface
	Wear eyes, ears and head protection		Finger Severing
	Wear hand and foot protection		DO NOT allow flames or sparks near fuel.
	Safety/Alert		DO NOT smoke near fuel.
			Keep bystanders and helpers away 15 m (50 ft.).

Symbol form/shape	Symbol description/application	Symbol form/shape	Symbol description/application
	Emergency stop		Fuel and oil mixture
	Carburetor adjustment - High speed mixture		Primer Bulb
	Carburetor adjustment - Idle speed		Ignition ON/OFF
	Carburetor adjustment - Low speed mixture		Engine choke control.

## EQUIPMENT

Before operation a complete check of the unit must be performed;

- Check unit for loose/missing nuts, bolts and screws. Tighten and/or replace as needed.
- Inspect fuel lines, tank and area around carburetor for fuel leaks. DO NOT operate unit if leaks are found.
- Inspect shield for damage and ensure that the cut-off knife is securely in place. Replace if either is damaged or missing.
- Check that the cutting attachment is firmly attached and in safe operating condition.
- Check that front (loop) handle and optional shoulder strap/ or shoulder/waist harness are adjusted for safe, comfortable operation. See Assembly for proper adjustment.
- Have repairs done only by an authorized ECHO Service Dealer.
- Do not use any attachment, accessory or replacement part unless it is recommended in the Operator's Manual.

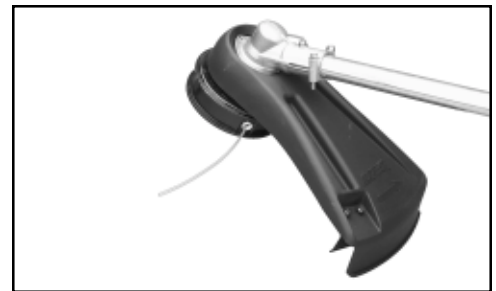

### ***Spark Arrestor - Catalytic Muffler / Muffler***

- The muffler or catalytic muffler controls the exhaust noise and emissions. The spark arrestor screen prevents hot, glowing particles of carbon from leaving the muffler. Make sure the spark arrestor screen is in good repair and properly seated in the muffler. Keep exhaust area clear of flammable debris. Avoid contact during and immediately after operation.

## FUEL

### WARNING DANGER

Fuel is **VERY** flammable. Use extreme care when mixing, storing or handling, or serious personal injury may result

- Use an approved fuel container.
- **DO NOT** smoke near fuel.
- **DO NOT** allow flames or sparks near fuel.
- Fuel tanks/cans may be under pressure. Always loosen fuel caps slowly allowing pressure to equalize.
- **NEVER** refuel a unit when the engine is **HOT!**
- **NEVER** refuel a unit with the engine running.
- **DO NOT** fill fuel tanks indoors. **ALWAYS** fill fuel tanks outdoors over bare ground.
- Securely tighten fuel cap after refueling.
- Inspect for fuel leakage. If fuel leakage is found, do not start or operate unit until leakage is repaired.

### IMPORTANT

Spilled fuel is a leading cause of hydrocarbon emissions. Some states may require the use of automatic fuel shut-off containers to reduce fuel spillage. Contact your ECHO dealer for ordering information.

### After Refueling;

- Wipe any spilled fuel from the unit.
- Move at least 3 m (10 ft.) from refueling location before starting.

### After Use;

- **DO NOT** store a unit with fuel in its tank. Leaks can occur. Return unused fuel to an approved fuel storage container.

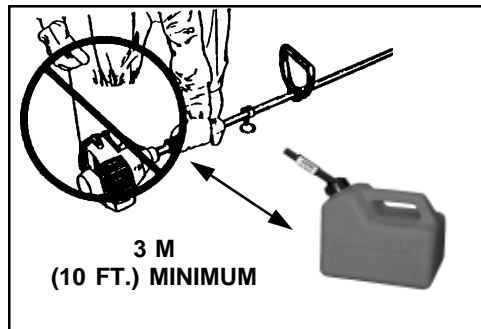

## PERSONAL CONDITION AND SAFETY EQUIPMENT

### WARNING DANGER

Trimmer/Brush Cutter users risk injury to themselves and others if the trimmer/brush cutter is used improperly and or safety precautions are not followed. Proper clothing and safety gear must be worn when operating a trimmer.

### Physical Condition --

Your judgment and physical dexterity may not be good:

- if you are tired or sick,
- if you are taking medication,
- if you have taken alcohol or drugs.

Operate unit only if you are physically and mentally well.



## ***Eye Protection --***

Wear eye protection that meets ANSI Z87.1 or CE requirements whenever you operate the trimmer.



## ***Hand Protection --***

Wear no-slip, heavy duty work gloves to improve your grip on the Trimmer/Brush Cutter handles. Gloves also reduce the transmission of machine vibration to your hands.

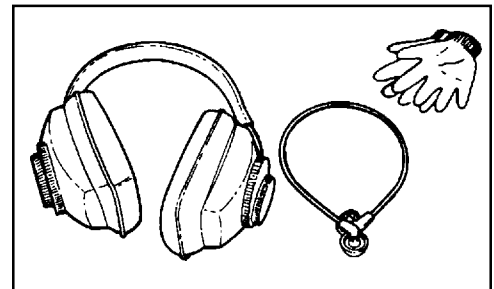

## ***Hearing Protection --***

ECHO recommends wearing hearing protection whenever unit is used.

## ***Proper Clothing --***

Wear snug fitting, durable clothing;

- Pants should have long legs, shirts with long sleeves.
- DO NOT WEAR SHORTS,
- DO NOT WEAR TIES, SCARVES, JEWELRY.

Wear sturdy work shoes with non-skid soles;

- DO NOT WEAR OPEN TOED SHOES,
- DO NOT OPERATE UNIT BAREFOOTED.

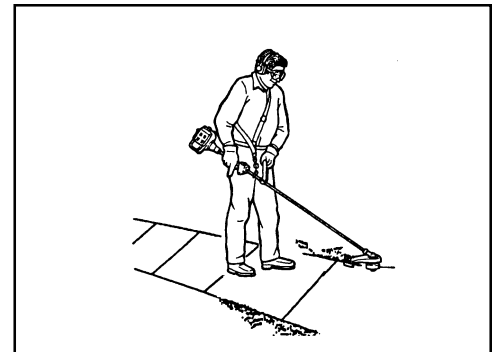

## ***Hot Humid Weather --***

Heavy protective clothing can increase operator fatigue which may lead to heat stroke. Schedule heavy work for early morning or late afternoon hours when temperatures are cooler.

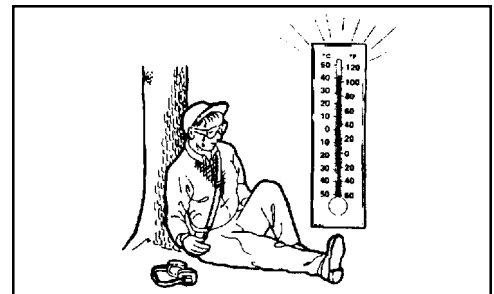

## SAFE OPERATION

### Determine Operation Area

- Provide all operators of this equipment with the operator's manual and instructions for safe operation.
- Review the area to be trimmed. Look for hazards that could contribute to unsafe conditions.
- Spectators and fellow workers must be warned, and children and animals prevented from coming nearer than 15M (50 ft.) while the trimmer is in use.

### Operation

#### Use Proper Clothing & Equipment

- Before starting the unit, equip yourself and any other person working within the 15M (50 ft.) Safety Zone with the required Protective Equipment and clothing.

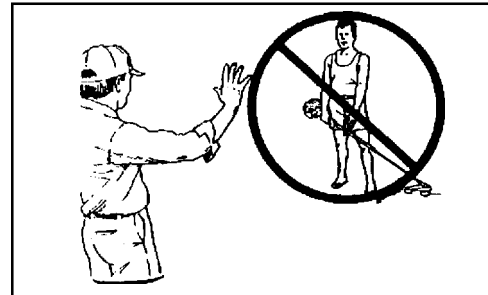
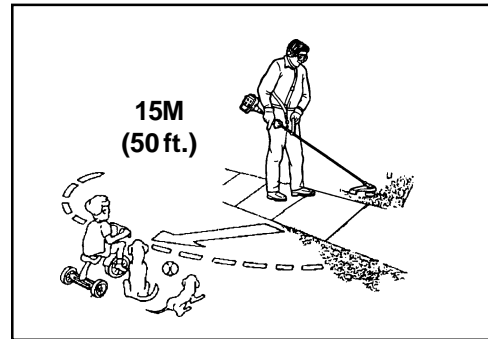

**WARNING  DANGER**

Do not operate this product indoors or in inadequately ventilated areas. Engine exhaust contains poisonous emissions and can cause serious injury or death.

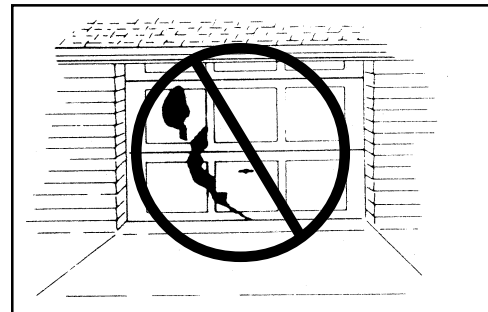

#### Avoid Hot Surfaces

- During operation, the drive shaft housing and the bearing housing, and the muffler or catalytic muffler cover area may become very hot. Avoid contact during and immediately after operation. Always keep exhaust area clear of flammable debris

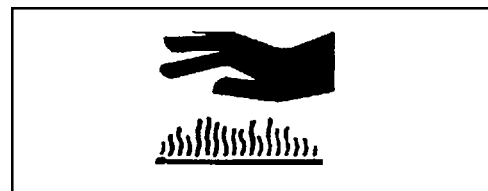

#### Keep A Firm Grip

- Hold the front and rear handles with both hands with thumbs and fingers encircling the handles



#### Keep A Solid Stance

- Maintain footing and balance at all times. Do not stand on slippery, uneven or unstable surfaces. Do not work in odd positions or on ladders. Do not over reach.



## EXTENDED OPERATION/EXTREME CONDITIONS

### Vibration and Cold --

It is believed that a condition called Raynaud's Phenomenon, which affects the fingers of certain individuals may be brought about by exposure to vibration and cold. Exposure to vibration and cold may cause tingling and burning sensations followed by loss of color and numbness in the fingers. The following precautions are strongly recommended because the minimum exposure which might trigger the ailment is unknown.

- Keep your body warm, especially the head, neck, feet, ankles, hands and wrists.
- Maintain good blood circulation by performing vigorous arm exercises during frequent work breaks and also by not smoking.
- Limit the hours of operation. Try to fill each day with jobs where operating the trimmer or other hand-held power equipment is not required.
- If you experience discomfort, redness and swelling of the fingers followed by whitening and loss of feeling, consult your physician before further exposing yourself to cold and vibration.

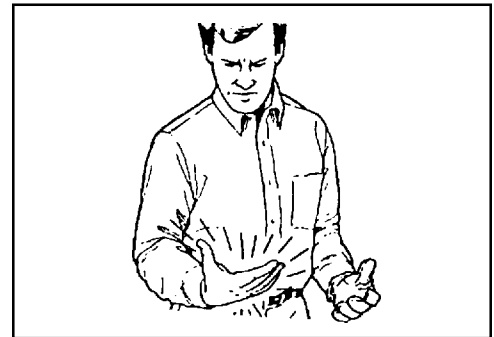
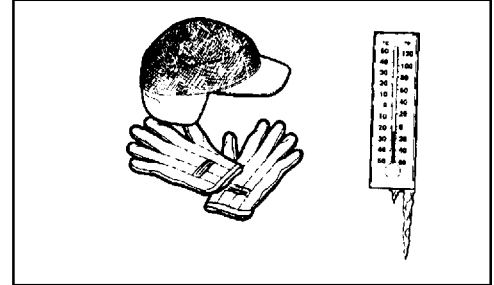

### Repetitive Stress Injuries --

It is believed that overusing the muscles and tendons of the fingers, hands, arms and shoulders may cause soreness, swelling, numbness, weakness and extreme pain in those areas. Certain repetitive hand activities may put you at a high risk for developing a Repetitive Stress Injury (RSI). An extreme RSI condition is Carpal Tunnel Syndrome (CTS), which could occur when your wrist swells and squeezes a vital nerve that runs through the area. Some believe that prolonged exposure to vibration may contribute to CTS. CTS can cause severe pain for months or even years. To reduce the risk of RSI/CTS, do the following:

- Avoid using your wrist in a bent, extended or twisted position. Instead try to maintain a straight wrist position. Also, when grasping, use your whole hand, not just the thumb and index finger.
- Take periodic breaks to minimize repetition and rest your hands.
- Reduce the speed and force with which you do the repetitive movement.
- Do exercises to strengthen the hand and arm muscles.
- Immediately stop using all power equipment and consult a doctor if you feel tingling, numbness or pain in the fingers, hands, wrists or arms. The sooner RSI/CTS is diagnosed, the more likely permanent nerve and muscle damage can be prevented.

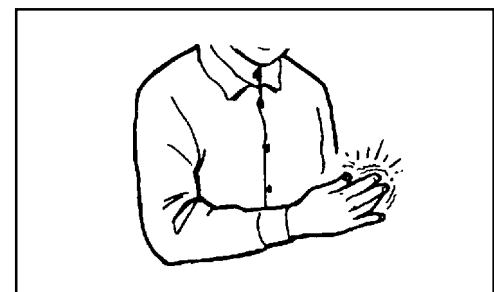
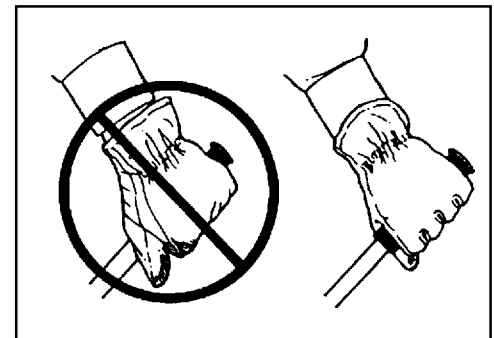

## DESCRIPTION

The ECHO product you purchased has been factory pre-assembled for your convenience. Due to packaging restrictions, shield installation and other assembly may be necessary.

After opening the carton, check for damage. Immediately notify your retailer or ECHO Dealer of damaged or missing parts. Use the contents list to check for missing parts.

## CONTENTS

### SRM-211/211U

- 1 - Power Head / Drive Shaft Assembly
- 1 - Plastic Bag (co-pack)
  - 1, Operator's Manual
  - 1, Safety Manual
  - 1, Warranty Registration Card
  - 1, Limited Warranty Statement
  - 1, Plastic shield
- 1, Plastic Bag
  - 1, shield plate
    - 3, 5mm x 15mm screws (shield mtg.)
- 1, Tool Bag
  - 1, 8mm x 10mm wrench
  - 1, scrench
  - 1, locking tool
- 1, Nylon Trimmer Head
- 1, Safety Glasses
- 1, 2-Stroke Oil Sample, 2.6 oz.

### SRM-211U Additional Co-Pack

- 1, U-Handle w/throttle
- 1, Plastic Bag
  - 1, metal shield
  - 1, shield bracket
  - 1, plastic bag
    - 1, 8mm x 55mm screw (handle mtg.)
    - 1, washer, circular
    - 2, cable clips
- 1, Plastic Bag
  - 3, 5mm x 15mm screws (shield mount)
  - 2, 5mm x 8mm screws (bracket to shield)
  - 4, 5mm nuts
  - 4, 5mm lockwashers
  - 1, 3mm Hex Wrench
- 1, Shoulder Harness w/hip pad
  - 1, harness clamp

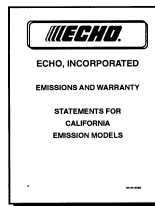

**BLADE TERMS & DEFINITIONS --**

**Blade Convertible**

Model (SRM-211) can be converted to utilize blades. Plastic/nylon blades require a, "Blade Conversion Kit", which includes a shoulder harness, and steel shield with necessary attaching hardware. Steel/metal blades also require the, "Blade Conversion Kit", plus a "U-Handle Kit", or a Combo Kit, must be installed.

**Dedicated Blade Capable**

Model (SRM-211U) include both the "Blade Conversion Kit", and "U-Handle Kit".

**EMISSION CONTROL**

***California Tier 2***

The emission control system for these engines are EM (Engine Modification).

**An Emission Control Label** is located on the engine. (This is an EXAMPLE ONLY, information on label varies by engine FAMILY).

**IMPORTANT ENGINE INFORMATION**

ENGINE FAMILY: YEHXS.0214CA  
 DISPLACEMENT: 21.2 cc  
 THIS ENGINE MEETS U.S. EPA PH1 AND 2000 AND LATER CALIFORNIA EMISSION REGULATIONS FOR S.O.R.E. REFER TO OWNER'S MANUAL FOR MAINTENANCE SPECIFICATIONS AND ADJUSTMENTS.

**E KORTZ CORP.**

**AIR INDEX TAG**

The Air Index Tag indicates, for purposes of consumer awareness, how this product's emissions compare to the standards enacted by the California Air Resources Board.

All Echo engines are certified to 300 hours commercial use.  
 The air index of this engine is 3

Most Clean      0    2    4    6    8    10      Least Clean

Note: The lower the Air Index, the less pollution. The engine is certified to be emissions compliant for the following use:

Moderate (50 hours (0-65cc))  
 Intermediate (125 hours (0-65cc))  
 Extended (300 hours (0-65cc))

**ECHO**  
Check owner's manual for further details

All Echo engines are certified to 300 hours commercial use.

Light-Duty Homeowner Consumer  
 Larger Property Homeowner Light-Duty Professional  
 Heavy-Duty Professional Commercial-Duty

**ECHO**

**PRODUCT EMISSION DURABILITY**

The 300 hour emission durability period is the time span selected by the manufacturer certifying the engine emissions output meets applicable California emissions regulations, provided that approved maintenance procedures are followed as listed in the Maintenance Section of this manual.

# 12 ECHO®

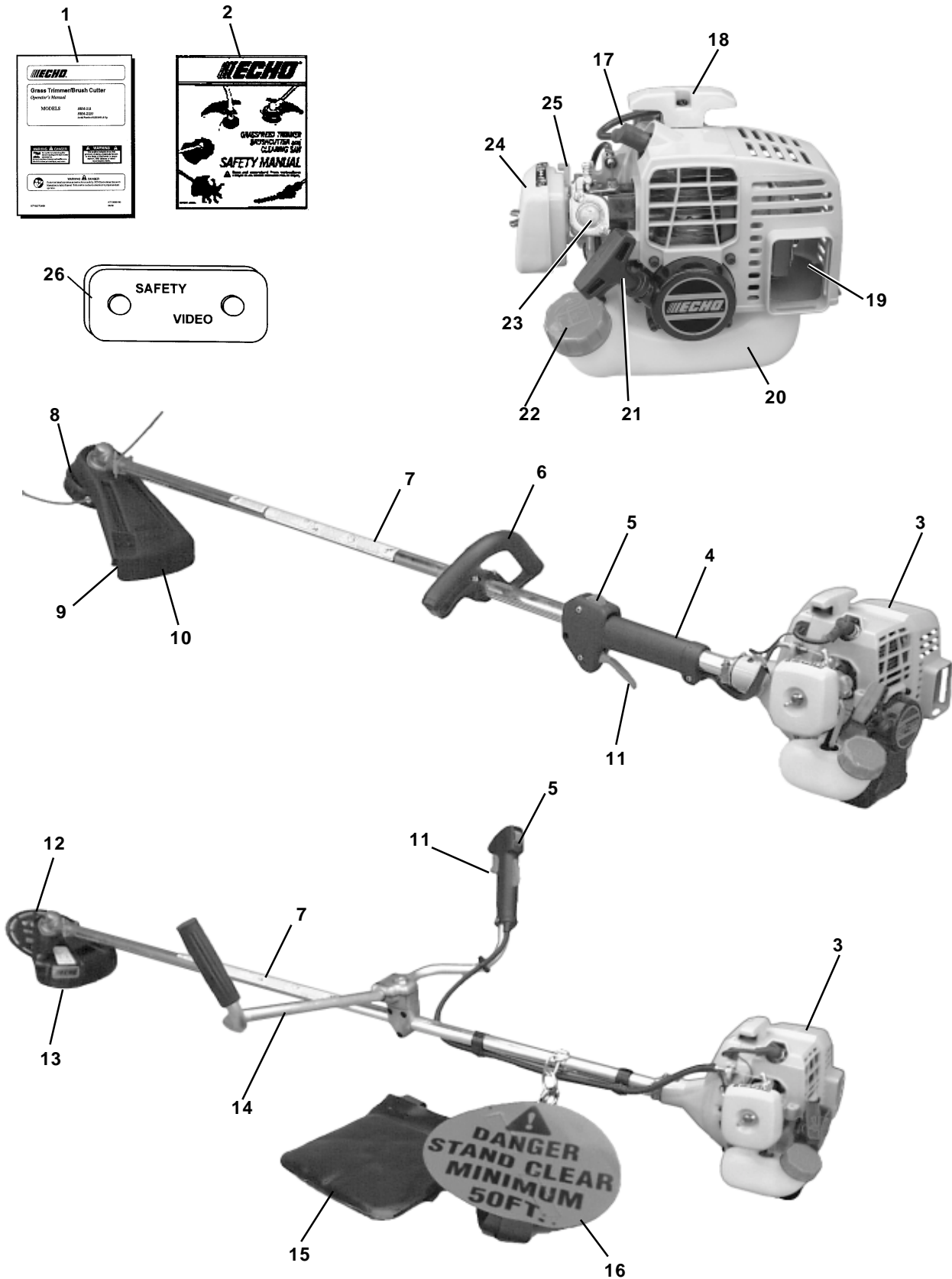

1. **OPERATOR'S MANUAL** - Included in plastic bag (co-pack). Read before operation and keep in a safe place for future reference, i.e., operation, maintenance, storage and specifications.
2. **SAFETY MANUAL** - Included in plastic bag (co-pack). Read before operation and keep in a safe place for future reference to learn proper, safe operating techniques.
3. **POWER HEAD** - Includes the Engine, Clutch, Fuel System, Ignition System and Recoil Starter.
4. **GRIP** - Rear (right hand) handle.
5. **STOP SWITCH** - "SLIDE SWITCH" mounted on top of the Throttle Trigger Housing. Move switch FORWARD to RUN, BACK to STOP.
6. **FRONT HANDLE** - The Front (loop) handle is loosely assembled to the Drive Shaft assembly and must be positioned for proper cutting attitude and operator comfort.
7. **DRIVE SHAFT ASSEMBLY** - Includes the Gear Housing assembly, flex drive cable and Safety Decal.
8. **NYLON CUTTER HEAD** - Contains replaceable nylon trimming line that advances when the trimmer head is tapped against the ground while the head is turning at normal operating speed.
9. **CUT-OFF KNIFE** - Automatically trims line to the correct length: 5" after head is tapped on the ground. If trimmer is operated without a cut-off knife the line will become too long, the engine will overheat and engine damage may occur.
10. **PLASTIC DEBRIS SHIELD ASSEMBLY** - Included in plastic bag (co-pack). **MUST** be installed on unit before use, see Assembly Instructions. Shield assembly includes the Cut-Off Knife. Mounts on the Gear Housing Assembly just above the cutting attachment. Helps protect the operator by deflecting debris produced during the trimming operation. This shield must be replaced with the steel shield for blade use.
11. **THROTTLE TRIGGER** - Spring loaded to return to idle when released. During acceleration, press trigger gradually for best operating technique.
12. **BLADE** - Circular blade for grass, weed or brush cutting applications. Harness, metal shield & U-handles required for blade operation.
13. **METAL BLADE SHIELD** - Required when unit is equipped with blades. Do not operate unit without shield.
14. **U-HANDLE** - Required for metal blade operation.
15. **HIP PAD** - Used to protect hip/leg and clothing when using U-handle equipped unit.
16. **SHOULDER HARNESS** - An adjustable strap that suspends the unit from the operator. Using the strap reduces operator fatigue.
17. **SPARK PLUG** - Provides spark to ignite fuel mixture.
18. **ARM REST** - Provides arm rest during operation and protects arm from the hot engine.
19. **SPARK ARRESTOR - CATALYTIC MUFFLER / MUFFLER** - The muffler or catalytic muffler controls exhaust noise and emission. The spark arrestor screen prevents hot, glowing particles of carbon from leaving the muffler. Keep exhaust area clear of flammable debris.
20. **FUEL TANK** - Contains fuel and fuel filter.
21. **RECOIL STARTER HANDLE** - Pull handle slowly until starter engages, then quickly and firmly. When engine starts, return handle slowly. DO NOT let handle snap back or damage to unit will occur.
22. **FUEL TANK CAP** - Covers and seals fuel tank opening.
23. **PRIMER BULB** - Pumping primer bulb before starting engine draws fresh fuel from the fuel tank priming the carburetor for starting. Pump primer bulb until fuel is visible and flows freely in the clear fuel tank return line. Pump bulb an additional 4 or 5 times.
24. **AIR CLEANER** - Contains replaceable filter element.
25. **CHOKE** - The choke control is located on the top of the air filter case. Move choke lever to "Cold Start" to close choke for cold start. Move choke lever to "Run" position to open choke.
26. **SAFETY VIDEO** - (Not included with unit) P/N 99922202540 English version only is available at a cost of \$5.00 from ECHO, INC. or any authorized ECHO dealer. The video overviews safety precautions and proper operating techniques and is supplemental to the Safety Manual. Read and understand the Safety Manual for complete information on safe operation.

## SPECIFICATIONS

MODEL	SRM-211	SRM-211U
Length	1770 mm (69.7 in.)	
Width	245 mm (9.65 in.)	680 mm (26.8 in.)
Height	225 mm (8.86 in.)	415 mm (16.3 in.)
Weight (dry) w/cutter head	5.3 kg (11.6 lb.)	5.75 kg (12.7 lb.)
Engine Type	Air cooled, two-stroke, single cylinder gasoline engine	
Bore	32.2 mm (1.268 in.)	
Stroke	26.0 mm (1.02 in.)	
Displacement	21.2 cc (1.29 cu. in.)	
Exhaust	Spark Arrestor Muffler w/catalyst	
Carburetor	Zama diaphragm model C1U w/primer	
Ignition System	Flywheel magneto, capacitor discharge ignition type	
Spark Plug	NGK BPM-7A Gap 0.65 mm (0.026 in.)	
Fuel	Mixed (Gasoline and Two-stroke Oil)	
Fuel/Oil Ratio	50:1 ECHO High Performance, two-stroke air cooled engine oil	
Gasoline	89 Octane unleaded. DO NOT use fuel containing methyl alcohol, more than 10% ethyl alcohol or 15% MTBE.	
Oil	50:1 ECHO High Performance, two-stroke air cooled engine oil	
Fuel Tank Capacity	0.45 lit. (15.8 US fl. oz.)	
Recoil Starter System	Automatic Recoil Starter	
Clutch	Centrifugal Type	
Drive Shaft	1/4" Flex Shaft	
Rotating Direction	Counter-Clockwise viewed from top	
Cutter Head	Nylon line head (2-line) with .095 Crossfire™ Line capacity 13m (40 ft.) Optional: U-Handle Kit, 8 cutter blade (8 in.); 22-tooth blade (8 in.); Circular saw (8 in.) MAXI-CUT, TRI-CUT, UNIVERSAL HEADS, Rapid Loader Head, Sprink Klean	
Handle*	Front - Loop and Right Rear Handle w/rubber grips	U-Handle
Shoulder Harness	Optional	Standard
Idle Speed RPM	2800 - 3200	
Wide Open Throttle Speed (W.O.T.) RPM	8000 - 9000	9500 - 11000

\* Install and use U-Handle when operating any model with blade.

## ASSEMBLY

### WARNING DANGER

Use only ECHO approved attachments for these models. Serious injury may result from the use of non approved attachment combinations. Read and comply with all safety instructions listed in this manual and attachment manual.

ECHO, INC. will not be responsible for the failure of cutting devices, attachments or accessories which have not been tested and approved by ECHO for use with these units.

## PLASTIC SHIELD INSTALLATION

(for Nylon Line Operation)

*Tools Required:* Screwdriver.

*Parts Required:* Plastic Shield, Shield Plate, three (3) 5mm x 15mm screws.

### NOTE

The plastic shield is for use with the Nylon Line Head only. Install Metal Shield when using plastic or metal blades.

1. (SRM-211U) Remove split pin, blade nut, lower and upper plate from PTO shaft.
1. (SRM-211) Remove plastic sleeve and upper plate (A) from PTO shaft.
2. Install the shield on the bottom of the bearing housing flange.
3. Place shield plate (B) on shield, align holes and install three (3) 5x15mm screws.
4. Install upper plate (A).

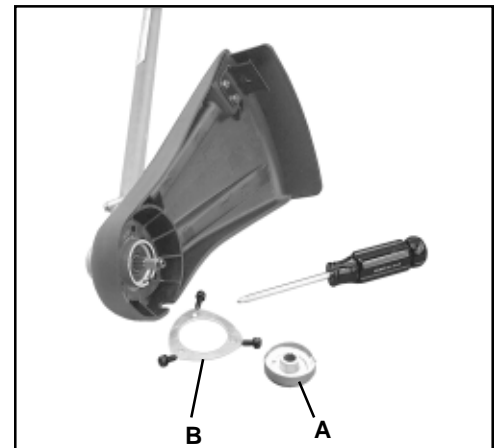

## NYLON LINE HEAD INSTALLATION

*Tools Required:* Head Locking Tool, 17x19mm Srench

*Parts Required:* Nylon Line Head.

1. (SRM-211) Align hole in upper plate with notch in edge of gear housing and insert head locking tool (C). Remove plastic sleeve from PTO shaft.
2. (SRM-211U) Remove split pin from hole in PTO shaft.
3. (SRM-211U) Remove 10mm nut by turning it clockwise (as viewed from underside of grass shield) with 17x19mm srench.
4. (SRM-211U) Remove lower plate. Retain lower plate, 10mm nut and split pin for future use.
5. Be sure upper plate (A) remains on PTO shaft.
6. Thread line head onto PTO shaft by turning it counter clockwise until head is tight against upper plate.
7. Remove locking tool (C).

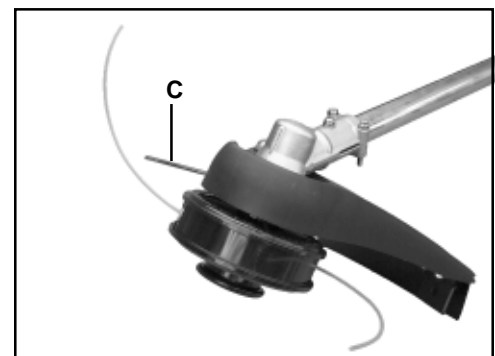

## BLADE INSTALLATION

All Models.

### IMPORTANT

If non-standard monofilament head, METAL/PLASTIC blade or cultivator etc. is used, THE CARBURETOR MUST BE RE-SET or serious engine damage may occur. See "Carburetor Adjustment" pages 32 - 33 and "Specifications" page 14 of this manual.

### WARNING DANGER

You must install a U-Handle Kit and Blade Conversion kit before operating this unit using metal blades, otherwise serious injury may result.

### Install Metal Shield

*Tools Required:* 8mm x 10mm Open End Wrench, Screwdriver, Srench.

*Parts Required:* Metal Shield, Bracket, 3- 5mm x 15mm screws w/ captivated flat and lockwasher (metal shield to gear housing), 2- 5mm x 8mm screws, 4- 5mm nuts, 4- 5mm lockwashers (bracket to shield and bracket to gear housing).

1. If necessary, remove nylon line head and plastic shield.
2. Loosely attach bracket (A) to shield (B) and attach to bottom of gear housing (C) with screws and nuts provided. Tighten all attaching hardware.

### Install Blade

*Tools Required:* Locking Tool, srench.

*Parts Required:* Upper Plate w/ 20mm pilot, Lower Plate, 10mm Nut w/ LH threads, 2mm x 25mm Split Pin (cotter pin).

3. Install upper plate (D) on splined PTO shaft. Blade installation requires use of Upper Plate (D) with 20mm pilot. Upper plate with 37mm pilot of the SRM-211 should be retained for use with nylon line head.
4. Place Blade (E) over upper plate pilot, install the Lower Plate (F) and 10mm LH nut (G). Tri-Cut Blade (H) is installed with Glide Cup (J).
5. Insert Locking Tool (K) through hole in upper plate and notch in gear housing to prevent splined PTO shaft from turning. Tighten nut and secure with Split Pin (L).

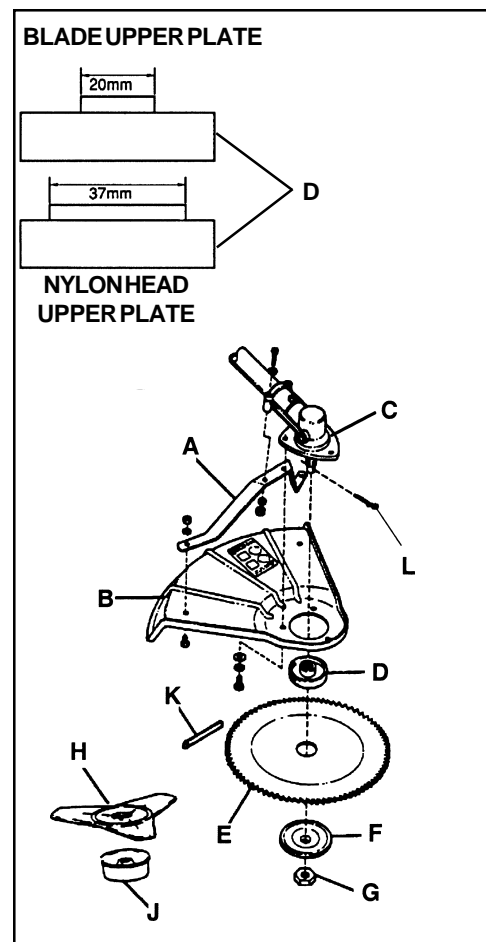



## Install Harness Clamp

### NOTE

Some models require installation of Harness Clamp. If your unit does not have a clamp, follow these directions.

*Tools Required:* Screwdriver, 8mm x 10mm Open End Wrench.

*Parts Required:* Clamp, 4mm x 18mm Hexagon Head, Bolt, Link.

6. Remove shield and gear housing as an assembly.
  - a. Loosen two (2) screws that clamp the gear housing to the drive shaft housing.
  - b. Remove locating screw found at the top of the gear housing. Pull shield and gear housing assembly from the drive shaft assembly.

### IMPORTANT

Prevent flexible drive cable from sliding from drive shaft housing. If cable does slide free, clean dirt from cable and lubricate with lithium based grease prior to re-assembly.

7. Remove front handle.
  - a. Remove four (4) screws and nuts and handle support from front handle.
  - b. Remove front handle.
8. Install clamp.
  - Slightly spread clamp and slide up shaft.
  - Install single link using spacer, DO NOT tighten at this time.
9. Install gearbox, shield and front handle.
10. Balance unit.
  - a. Put on harness and attach unit to harness.
  - b. Slide clamp up or down until unit balances with head approximately 2 - 3 in. from the ground.
  - c. Tighten clamp screw.



## FRONT HANDLE INSTALLATION (SRM-211)

*Tools Required:* Screwdriver.

1. Position front handle for comfortable operation and secure screws.



## U-HANDLE INSTALLATION

*Tools Required:* 8mm x 10mm Open End Wrench, Slotted Screwdriver, (3mm Hex Wrench SRM-211 only.)

*Parts Required:* U-Handle Kit. (SRM-211) P/N 35130454130

### NOTE

On model SRM-211U use Steps 9, 10, 12 - 15 only.

1. Disconnect ignition stop leads (E).
2. Remove inner throttle linkage from carburetor swivel (B).
3. Loosen nut (A) and remove throttle linkage from bracket.
4. Loosen two (2) bolts (G) and pull drive shaft assembly from clutch case.
5. Loosen two (2) rear handle screws (H) and pull rear handle (I) from the drive shaft assembly.
6. Loosen four (4) screws (J) and remove front handle.

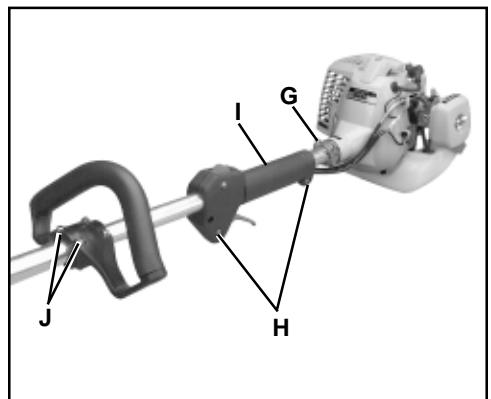
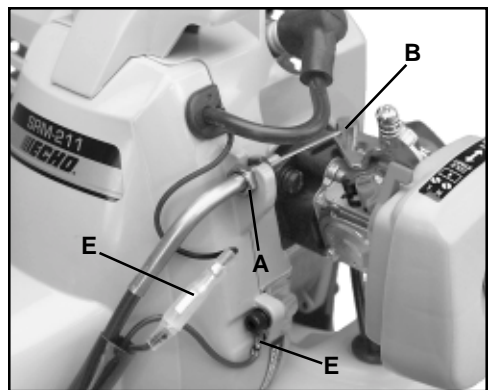

7. Position Lower U-Handle Bracket (K) 400mm (15-3/4 in.) from engine end of drive shaft. Secure with three (3) 5mm x 30mm bolts.
8. Install harness hook (included with Blade Conversion Kit) for blade use. Position 220 mm (8-5/8 in.) from engine end of drive shaft assembly. **DO NOT** tighten at this time.
9. Install upper U-Handle and bracket on lower bracket and secure with one (1) 8mm x 55mm bolt (L) and large circular washer.
10. Secure throttle linkage and leads to drive shaft with cable clips supplied.
11. Install power head and align gear box, power head and U-handles. Tighten all screws.
12. Place throttle linkage in slot in bracket with one nut (A) on each side of bracket. Finger tighten both nuts (A).
13. Attach inner throttle cable to swivel (B). Check throttle for freedom of movement and that wide open throttle / low idle extremes are adjusted properly. If adjustment cannot be achieved by adjusting nuts (A), consult with your Echo Dealer for correct adjustment procedure.
14. Attach ignition leads (E).
15. Balance unit.
  - a. Put on harness and attach unit to harness.
  - b. Slide clamp (M) up or down drive shaft housing until unit balances with cutting attachment approximately 2 - 3" from ground.
  - c. Tighten harness clamp screw.

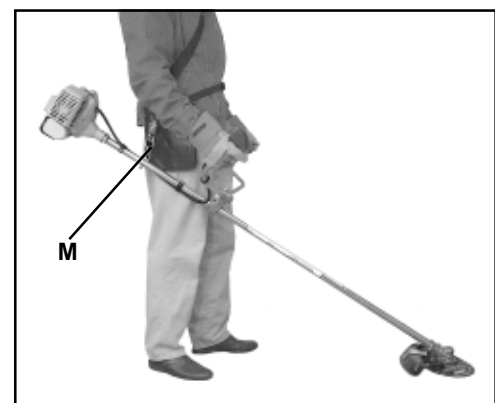
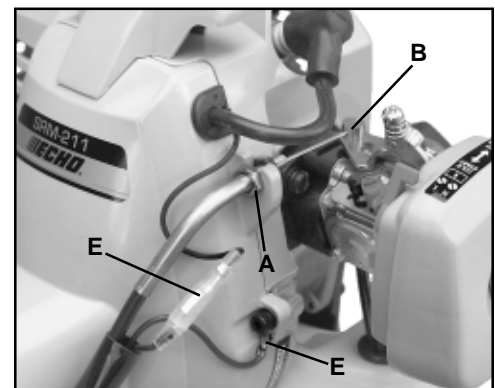
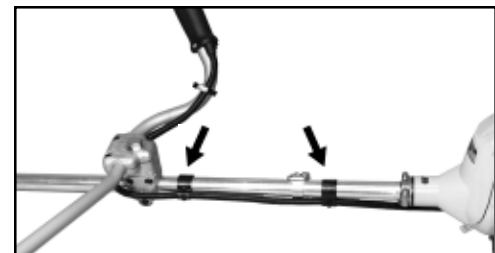
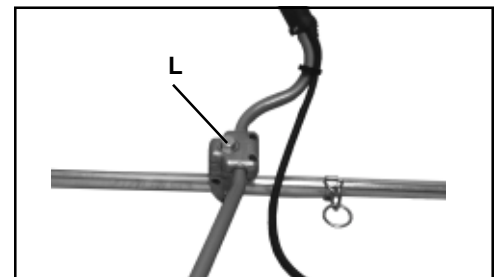
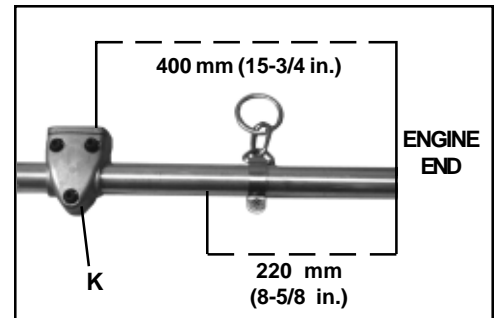

## PRE - OPERATION

### OPERATION WITH BLADES

#### Preparing the Trimmer/Brush Cutter for Blade Use

#### WARNING DANGER

Blade use **DEMANDS** specific Brush Cutter configuration. Operation without specified shield and harness can result in serious personal injury.

**Plastic and Nylon Blades Require** "Blade Conversion Kit," P/N 99944200415 (metal shield and shoulder harness).



**Steel/Metal Blades Require** "Blade Conversion Kit" **PLUS** a "U-Handle Kit." P/N 35130454130 or Combination Blade Kit and "U-Handle Kit" P/N 99944200451.



#### Choosing the Correct Blade

#### WARNING DANGER

The type of Blade used **MUST** be matched to the type and size of material cut. An improper or dull blade can cause serious personal injury. Blades **MUST** be sharp. Dull blades increase the chance of kick out and injury to yourself and bystanders.

**Plastic/Nylon Blades** may be used where ever the nylon line head is used. **DO NOT** use this blade for heavy weeds or brush!

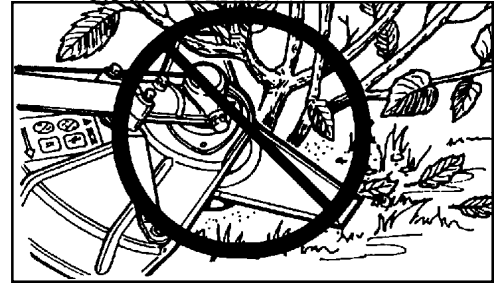

**8 Tooth Weed/Grass Blade P/N 69600120331** is designed for grass, garden debris and thick weeds. **DO NOT** use this blade for brush or heavy woody growth, 3/4" in. (19 mm) diameter or larger.

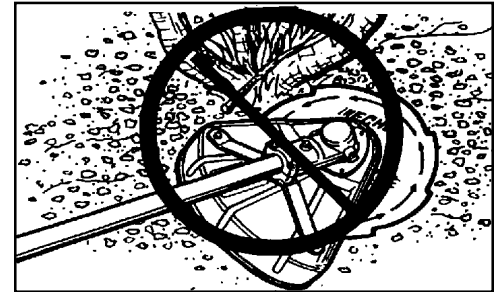

**Brush/Clearing Blade P/N 69500120331** is designed for cutting brush and woody growth up to 76 mm (3 in.) diameter.



**Use Shoulder/Waist Harness P/N 99944200200** Use of the Shoulder/Waist Harness is recommended for **ALL** Trimmer/Brush Cutter use, not just Blade operation. The Shoulder/Waist Harness when used in a trimming operation with nylon line head suspends the trimmer from the operator's shoulder and reduces operator fatigue.



During blade operation, the same fatigue reduction is achieved. Safety to the operator is also enhanced by preventing blade contact with the operators hands and feet by restricting trimmer movement.

#### NOTE

In case of Emergency, pull up on the Quick Release Collar to disconnect the trimmer from the harness.



## FUEL

### Fuel Requirements

**Gasoline** - Use 89 Octane  $\left[\frac{R+M}{2}\right]$  gasoline or gasohol known to be good quality. Gasohol may contain up to 10% Ethyl (grain) alcohol or 15% MTBE (methyl tertiary-butyl ether). Gasohol containing methyl (wood) alcohol is **NOT** approved.

**Two Stroke Oil** - A two-stroke engine oil meeting ISO-L-EGD (ISO/CD 13738) and J.A.S.O FC Standards, must be used. Echo brand Premium 50:1 oil meets these standards. Engine problems due to inadequate lubrication caused by failure to use an ISO-L-EGD and J.A.S.O FC certified oil, such as Echo Premium 50:1 Two-stroke Oil, will void the two-stroke engine warranty. (Emission related parts only are covered for two years, regardless of two-stroke oil used, per the statement listed in the California Emission Defect Warranty Explanation.)

**Mixing** - Follow directions on the oil container.

### Handling Fuel

#### WARNING DANGER

Fuel is **VERY** flammable. Use extreme care when mixing, storing or handling, or serious personal injury may result.

- Use an approved fuel container.
- DO NOT smoke near fuel.
- DO NOT allow flames or sparks near fuel.
- Fuel tanks/cans may be under pressure. Always loosen fuel caps slowly allowing pressure to equalize.
- NEVER refuel a unit when the engine is HOT!
- NEVER refuel a unit with the engine running.
- DO NOT fill fuel tanks indoors. ALWAYS fill fuel tanks outdoors over bare ground.
- Securely tighten fuel cap after refueling.
- Inspect for fuel leakage. If fuel leakage is found, do not start or operate unit until leakage is repaired.

#### IMPORTANT

Spilled fuel is a leading cause of hydrocarbon emissions. Some states may require the use of automatic fuel shut-off containers to reduce fuel spillage. Contact your ECHO dealer for ordering information.

### After refueling;

- Wipe any spilled fuel from the unit.
- Move at least 3 m (10 ft.) from refueling location before starting the engine.

### After use;

- DO NOT store a unit with fuel in its tank. Leaks can occur. Return unused fuel to an approved fuel storage container.

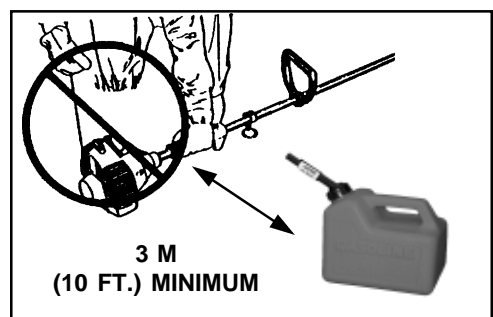
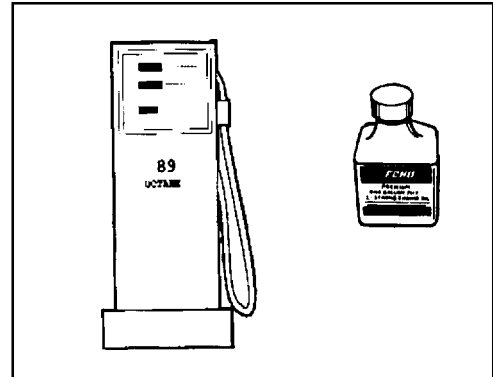

## Storage -

Fuel storage laws vary by locality. Contact your local government for the laws affecting your area. As a precaution, store fuel in an approved, air tight container. Store in a well ventilated, unoccupied building, away from sparks and flames. Do not store fuel longer than 30 days.

### IMPORTANT

Stored fuel ages. Do not mix more fuel than you expect to use in thirty (30) days, ninety (90) days when a fuel stabilizer is added.

### IMPORTANT

Stored two-stroke fuel may separate. ALWAYS shake fuel container thoroughly before each use.

S	M	T	W	T	F	S
1	2	3	4	5	6	7
8	9	10	11	12	13	14
15	16	17	18	19	20	21
22	23	24	25	26	27	28
29	30	31				

## EQUIPMENT CHECK

Before operation a complete check of the unit must be performed;

- Check unit for loose/missing nuts, bolts and screws. Tighten and/or replace as needed.
- Inspect fuel lines, tank and area around carburetor for fuel leaks. DO NOT operate unit if leaks are found.
- Inspect shield for damage and ensure that the cut-off knife is securely in place. Replace if either is damaged or missing.
- Check that the cutting attachment is firmly attached and in safe operating condition.
- Check that front handle and shoulder strap/ or shoulder/waist harness are adjusted for safe, comfortable operation. See Assembly section for proper adjustment.



## DETERMINE OPERATION AREA

- Review the area to be trimmed. Look for hazards that could contribute to unsafe conditions.
- Spectators and fellow workers must be warned, and children and animals prevented from coming nearer than 15 m (50 ft.) while the trimmer is in use.

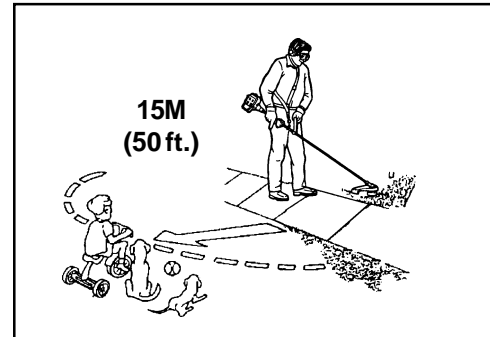

## OPERATION

- Provide all operators of this equipment with the Operator's Manual, and instructions for safe operation.
- Refer to the Safety Manual provided with the unit for proper trimming and brush cutting techniques.

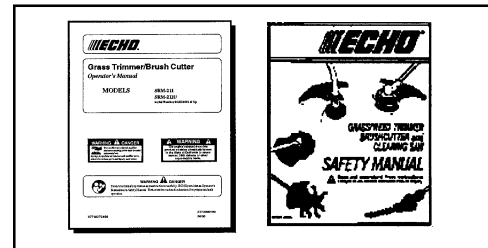

- During operation, the drive shaft housing and the bearing housing, and the muffler or catalytic muffler cover area may become very hot. Avoid contact during and immediately after operation. Always keep exhaust area clear of flammable debris.

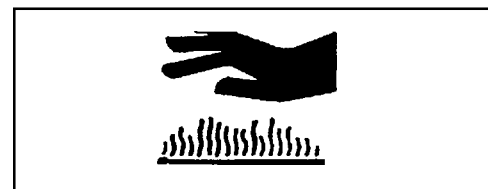



## STARTING COLD ENGINE

### WARNING DANGER

The cutting attachment should not rotate at idle. If attachment rotates, readjust carburetor according to "Carburetor Adjustment" instructions in this manual or see your ECHO Dealer, otherwise serious personal injury may result.

1. **Stop Switch - Start/Run.**  
Move stop switch button (A) forward away from the STOP position.
2. **Choke Lever - Cold Start.**  
Move choke (B) to "Cold Start" Position.
3. **Primer Bulb -Purge.**  
Pump primer bulb until fuel is visible and flows freely in the clear fuel tank return line. Pump bulb an additional 4 or 5 times.

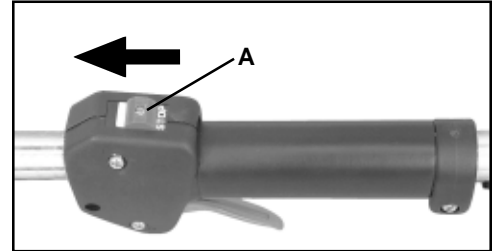

### WARNING DANGER

Inspect starting area for hazards such as rocks, glass, debris etc. which could be contacted by the cutting attachment when starting. Keep helpers and bystanders at least 15 M (50 ft.) from starting area, otherwise serious personal injury may result.

4. Lay the trimmer on a flat clear area. Firmly grasp throttle grip with left hand and fully depress throttle trigger to wide open position. Rapidly pull starter handle/rope (D) until engine fires (maximum five [5] pulls).
5. After engine fires or five (5) pulls, move choke lever (B) back to "Run" position. Hold throttle trigger fully depressed and pull starter handle/rope until engine starts and runs. Release throttle trigger and allow unit to warm up at idle for several minutes.

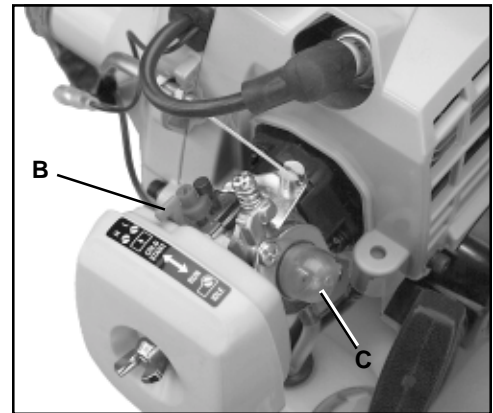

#### NOTE

If engine does not start with choke in "Run" position after 5 pulls, repeat instructions.

6. After engine warm up, gradually depress throttle trigger to increase engine RPM to operating speed.

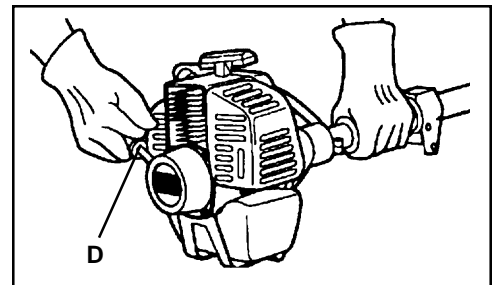

## STARTING WARM ENGINE

The starting procedure is the same as Cold Start except DO NOT close the choke.

### WARNING DANGER

The cutting attachment should not rotate at idle. If attachment rotates, readjust carburetor according to "Carburetor Adjustment" instructions in this manual or see your ECHO Dealer, otherwise serious personal injury may result.

1. Stop Switch - Start/Run. Move Stop Switch button (A) away from the STOP position.

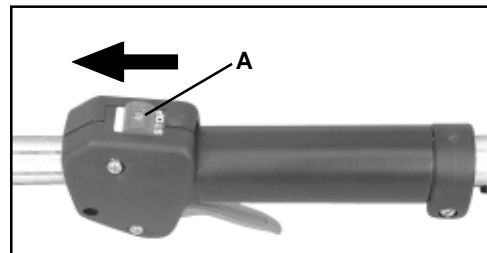

2. Primer - Pump Bulb. Pump primer bulb (C) until fuel is visible in the "Clear" fuel return line. Pump bulb an additional 4 or 5 times.

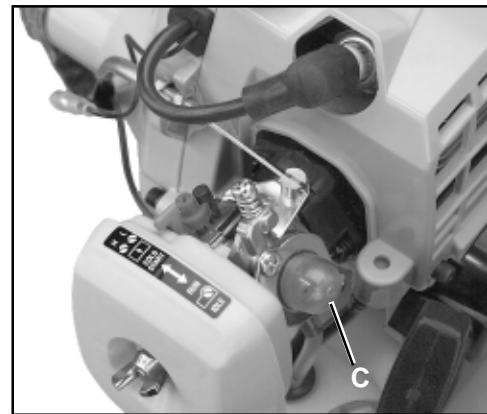

3. Start - Pull Rope. Lay the trimmer on a flat clear area and pull the recoil starter handle (D) until the engine fires.

#### NOTE

If engine does not start after 5 pulls, use Cold Start Procedure.

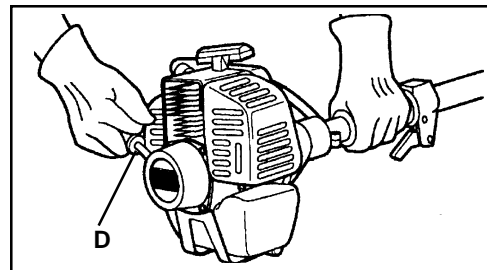

## STOPPING ENGINE

1. Release Throttle. Allow engine to idle for a minute.
2. Stop Switch - Stop. Move stop switch button (A) backward to STOP position.

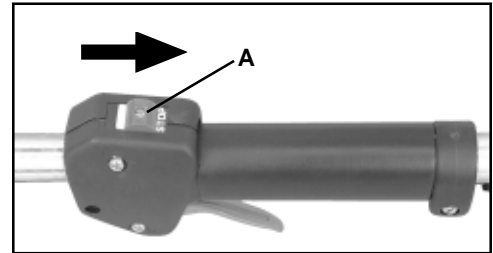

### WARNING DANGER

If engine does not stop when stop switch is moved to STOP position, close choke - COLD START position - to stall engine. Have your ECHO dealer repair stop switch before using trimmer again.

### NOTE

Refer to Grass Trimmer/Brush Cutter Safety Manual for proper and safe trimming techniques.

## MAINTENANCE

Your ECHO trimmer is designed to provide many hours of trouble free service. Regular scheduled maintenance will help your trimmer achieve that goal. If you are unsure or are not equipped with the necessary tools, you may want to take your unit to an ECHO Service Dealer for maintenance. To help you decide whether you want to DO-IT-YOURSELF or have the ECHO Dealer do it, each maintenance task has been graded. If the task is not listed, see your Echo Dealer for repairs.

### WARNING DANGER

Always stop engine and disconnect spark plug lead before performing maintenance procedures, otherwise serious personal injury may result.

## SKILL LEVELS

- Level 1**= Easy to do. Most required tools come with unit.
- Level 2**= Moderate difficulty. Some specialized tools may be required.
- Level 3**= Experience required. Specialized tools are required. ECHO recommends that the unit be returned to your ECHO dealer for servicing.

ECHO offers **REPOWER™** Maintenance Kits and Parts to make your maintenance job easier. Below each task heading are listed the various part numbers required for that task. See your ECHO dealer for these parts.

## MAINTENANCE INTERVALS

COMPONENT/ SYSTEM	MAINTENANCE PROCEDURE	REQ'D SKILL LEVEL	DAILY OR BEFORE USE	EVERY REFUEL	3 MONTHS OR 90 HOURS	6 MONTHS OR 270 HOURS	YEARLY 600 HOURS
<b>Recommended Echo Dealer Maintenance Procedures</b>							
Cylinder Exhaust Port	Inspect/Clean/Decarbon	<b>3</b>			<b>I / C</b>		
<b>Do-It-Yourself Maintenance Procedures</b>							
Air Filter	Inspect/Clean/Replace	<b>1</b>	<b>I / C</b>		<b>R*</b>		
Choke	Inspect/Clean	<b>2</b>	<b>I / C</b>				
Fuel Filter	Inspect/Replace	<b>1</b>			<b>I</b>		<b>I / R *</b>
Fuel System, leaks	Inspect/Replace	<b>1</b>	<b>I *</b>	<b>I</b>	<b>I</b>		
Cooling System	Inspect/Clean	<b>2</b>	<b>I / C</b>				
Muffler Spark Arrestor	Inspect/Replace	<b>2</b>			<b>I / R *</b>		
Drive Shaft (Flex Cable Models)	Grease	<b>2</b>			<b>I (1)</b>		
Gear Housing	Grease	<b>2</b>			<b>I (2)</b>		
Recoil Starter Rope	Inspect/Clean	<b>1</b>	<b>I / C *</b>				
Spark Plug	Inspect/Clean	<b>2</b>			<b>I / C</b>	<b>R *</b>	
Screws/Nuts/Bolts	Inspect/Tighten/Replace	<b>1</b>	<b>I / R *</b>				
<p><b>MAINTENANCE PROCEDURE LETTER CODES: I = INSPECT, R = REPLACE, C = CLEAN</b></p> <p><b>IMPORTANT NOTE</b> - Time intervals shown are maximum. Actual use and your experience will determine the frequency of required maintenance.</p> <p><b>MAINTENANCE PROCEDURE NOTES:</b></p> <p>(1) Apply ECHO® LUBE™ every 25 hours of use.</p> <p>(2) Apply ECHO® LUBE™ every 50 hours of use.</p> <p>* All recommendations to replace are based on the finding of damage or wear during inspection..</p>							

## AIR FILTER

### Level 1.

*Tools required:* 25 - 50 mm (1 - 2 in.) Cleaning Brush

*Parts required:* 90008 REPOWER™ AIR & FUEL FILTER KIT.

1. Close choke (Cold Start Position). This prevents dirt from entering the carburetor throat when the air filter is removed. Brush accumulated dirt from the air cleaner area.
2. Remove the air cleaner cover. Clean and inspect the element for damage. If element is fuel soaked and very dirty, replace.
3. If element can be cleaned and reused, be certain it:
  - still fits the cavity in the air cleaner cover.
  - is installed with the original side out.

#### NOTE

Carburetor adjustment may be needed after air filter cleaning/replacement.

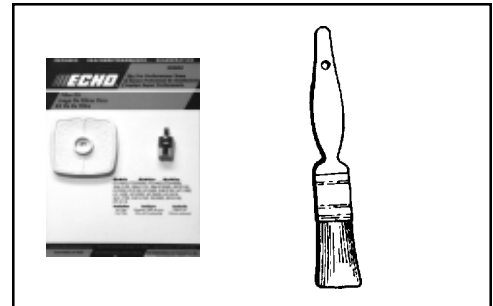

## FUEL FILTER

### Level 1.

*Tools required:* 203 - 254 mm (8 - 10 in.) length of wire with one end bent into a hook, Clean rag, funnel, and an approved fuel container

*Parts required:* 90008 REPOWER™ AIR & FUEL FILTER KIT.

### WARNING DANGER

Fuel is **VERY** flammable. Use extreme care when mixing, storing or handling, or serious personal injury may result.

1. Use a clean rag to remove loose dirt from around fuel cap and empty fuel tank.
2. Use the “fuel line hook” to pull the fuel line and filter from the tank.
3. Remove the filter from the line and install the new filter.

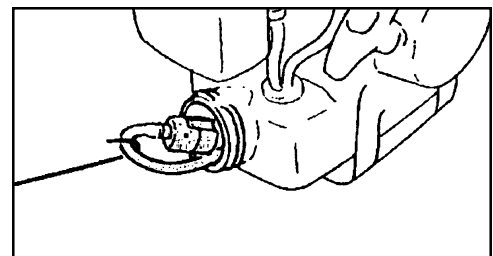
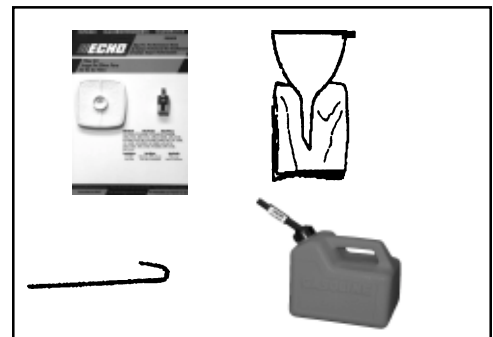

## WARNING DANGER

Catalytic mufflers operate at extremely high temperatures. Muffler area must be kept clean. Do not perform maintenance on the muffler until engine and muffler are completely cool, otherwise serious personal injury may occur.

## SPARK PLUG

### Level 2.

*Tools required:* Srench (combination socket wrench and screw driver supplied with unit), Feeler gauge (preferably a wire gauge), Soft metal brush

*Parts Required:* 90064 REPOWER™ TUNE-UP KIT

1. Remove spark plug and check for fouling, worn and rounded center electrode.
2. Clean the plug or replace with a new one. DO NOT sand blast to clean. Remaining sand will damage engine.
3. Adjust spark plug gap by bending outer electrode.
4. Tighten spark plug to 145 - 155 kg/cm (125 - 135 in. lb.).

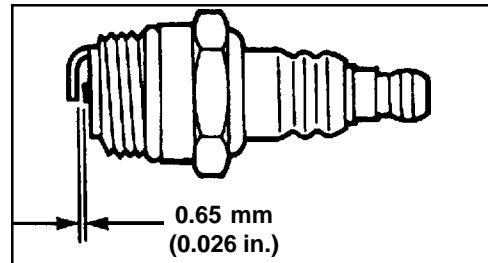
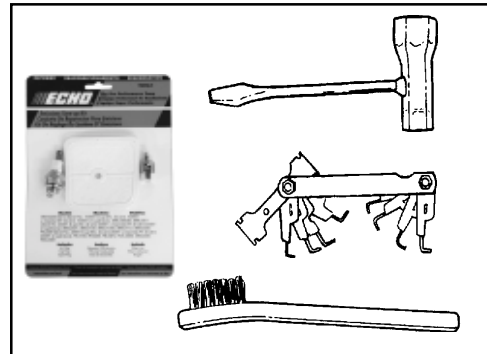

## COOLING SYSTEMS CLEANING

### Level 2.

*Tools required:* Cross-head screwdriver, 3 mm hex wrench, pointed wood stick, 25 - 50mm (1 - 2 in.) medium bristle paint brush.

*Parts Required:* None if you are careful.

### IMPORTANT

To maintain proper engine operating temperatures, cooling air must pass freely through the cylinder fin area. This flow of air carries combustion heat away from the engine.

Overheating and engine seizure can occur when:

- Air intakes are blocked, preventing cooling air from reaching the cylinder.
- Dust and grass build up on the outside of the cylinder. This build up insulates the engine and prevents the heat from leaving.

Removal of cooling passage blockages or cleaning of cooling fins is considered "Normal Maintenance". Any failure attributed to lack of maintenance is not warranted.

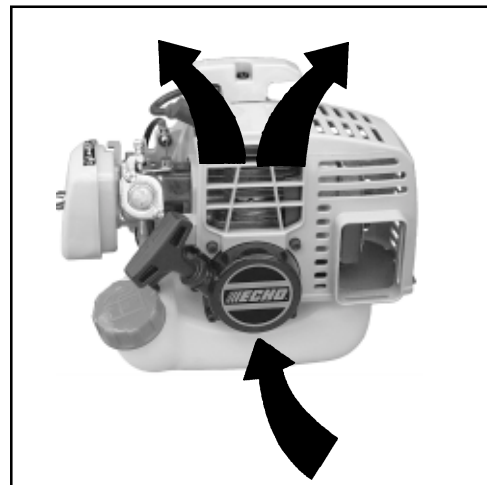
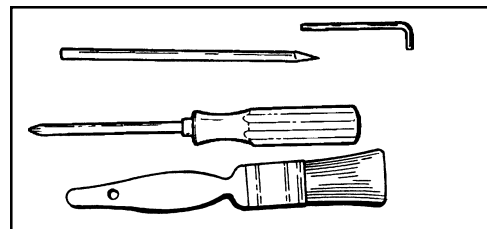

1. Remove spark plug lead
2. Loosen outer throttle cable nut (A) and remove cable from engine housing bracket slot.
3. Remove two (2) engine cover screws at top of starter.
4. Remove screw and arm rest (B). Lift cover (C) from engine.

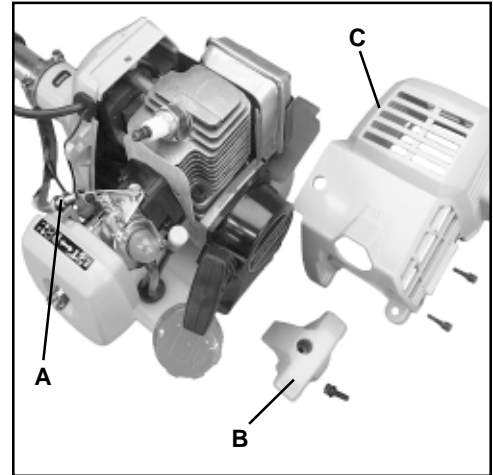

5. Use the wooden stick or brush to remove dirt from cylinder fins.
6. Remove grass and leaves from the grid between the recoil starter and fuel tank.
7. Assemble components in reverse order.

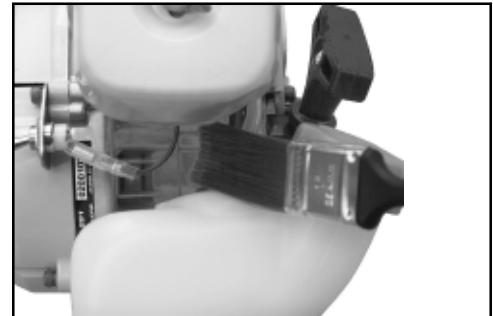

**NOTE**

When installing the cover, be certain the tab of the metal deflector shield is in the slot of the engine cover.

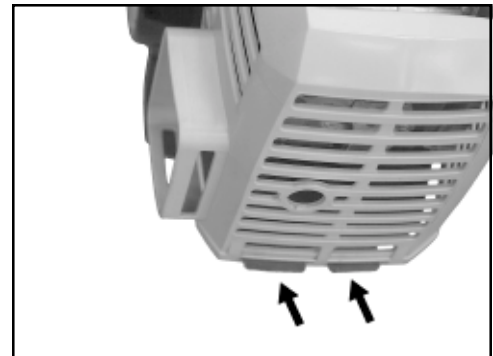

## EXHAUST SYSTEM

### Spark Arrestor Screen

#### Level 2.

*Tools required:* Cross-head screwdriver, soft metal brush.

*Parts Required:* Screen P/N 14586240630

1. Remove engine cover. See “Cleaning Cooling System” pages 30 & 31 for step by step instructions.
2. Remove spark arrestor screen cover (A), gasket (B), screen holder (C) and screen (D) from muffler body.
3. Clean carbon deposits from screen and muffler components.

#### NOTE

When cleaning carbon deposit, be careful not to damage the catalytic body.

4. Replace screen if it is cracked, plugged or has holes burned through.
5. Assemble components in reverse order.

#### NOTE

When installing the engine cover, be certain the tab of the metal deflector shield is in the slot of the engine cover.

#### IMPORTANT

The cylinder exhaust port must be inspected and cleaned of excess carbon every 3 months or 90 hours of operation in order to maintain this engine within the emissions durability period. ECHO strongly recommends that you return your unit to your ECHO dealer for this important maintenance service.

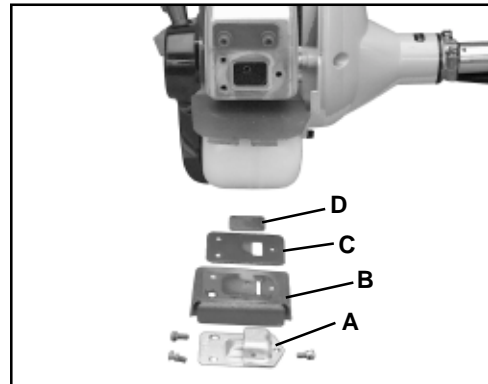
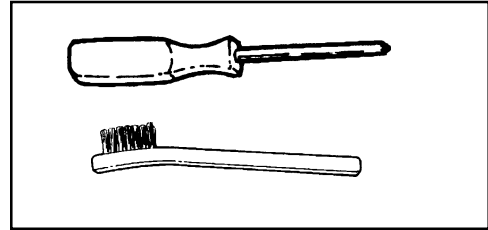

## CARBURETOR ADJUSTMENT

### Engine Break-In

New engines must be operated a minimum duration of two tanks of fuel break-in before carburetor adjustments can be made. During the break-in period your engine performance will increase and exhaust emissions will stabilize. Idle speed can be adjusted as required.

### High Altitude Adjustment

High altitude adjustment is not required for proper operation of this engine.

#### Level 2.

*Tools required:* Slotted Screwdriver w/2 mm blade width, Tachometer (ECHO P/N 99051130017)

*Parts required:* None.

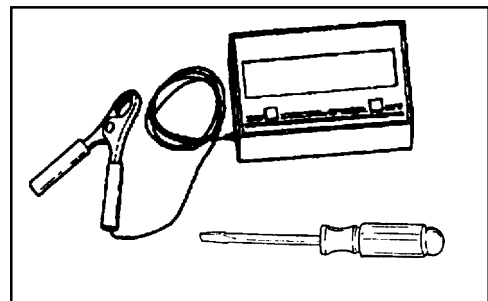



**NOTE**

Every unit is run at the factory and the carburetor is set in compliance and California Emission Regulations. In addition, the carburetor is equipped with a HI needle adjustment limiter that prevents settings outside acceptable limits.

1. Before adjusting the carburetor, clean or replace the air filter and spark arrester screen.
2. Trimmer line must be extended to the cut-off knife.
3. Start engine and run for several minutes to reach operating temperature.
4. Stop engine. Turn HI speed needle (A) CCW (counter clockwise) to stop.
5. Idle Speed Adjustment.
  - Start engine and turn "idle" speed adjustment screw (B) CW until the blades begin to turn, then turn the screw CCW until blades stop turning. Turn screw CCW an additional 1/4 turn.
6. Accelerate to full throttle for 2-3 seconds to clear excess fuel from engine then return to idle. Accelerate to full throttle to check for smooth transition from idle to full throttle. If engine stops or stalls after full warm up return the unit to your authorized ECHO dealer for repair.
7. Check HI speed RPM at W.O.T. (Wide Open Throttle). HI speed RPM should be set to specifications found on page 14 "Specifications" of this manual.
8. Check idle speed and reset if necessary. If a tachometer is available, idle speed should be set to the specification found on page 14 "Specifications" of this manual.

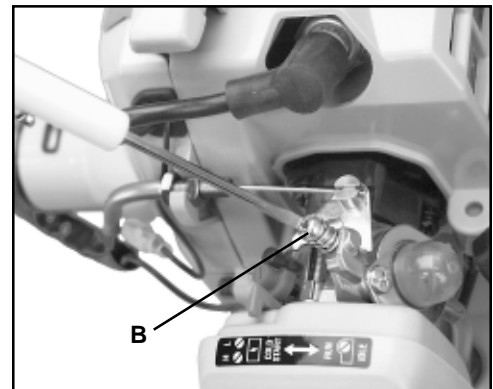
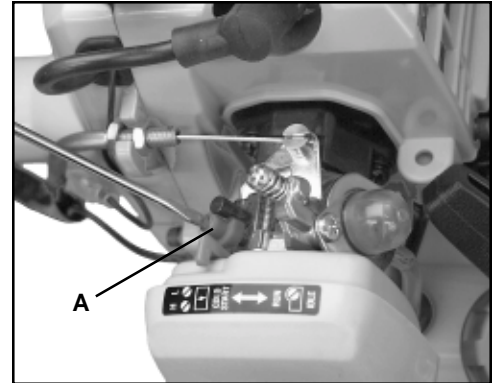

**WARNING**  **DANGER**

When carburetor adjustment is completed, the cutting attachment should not turn at idle, otherwise serious personal injury may result.

## LUBRICATION

### Level 1.

*Tools required:* 8 mm Open End Wrench, Cross Head Screwdriver, Clean rag

*Parts Required:* Echo Lube™ 8 oz. (P/N 91014) or Lithium Base Grease.

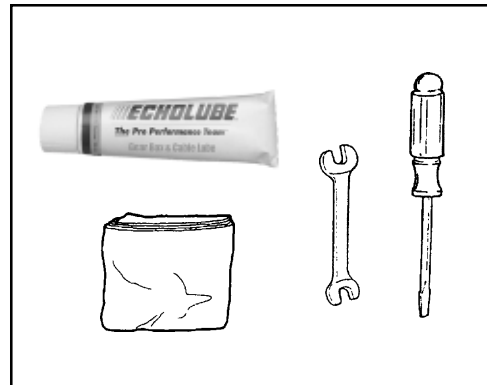

### *Gear Housing*

1. Clean all loose debris from gear box.
2. Remove plug (A) and check level of grease.
3. Add grease if necessary, DO NOT over fill.

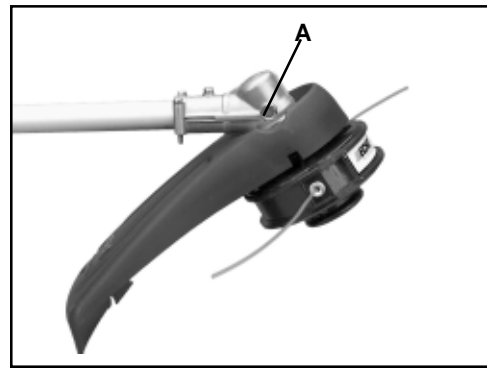

### *Drive Shaft*

1. Loosen two (2) screws (B) and remove center locating screw (C). Pull gear box and shield from drive shaft housing.
2. Pull flexible cable from the drive shaft housing, wipe clean and recoat with a thin coating of [15 ml (1/2 oz.)] of grease.
3. Slide the flexible cable back in the drive housing. DO NOT get dirt on the flex cable.
4. Install the gear housing and shield assembly.

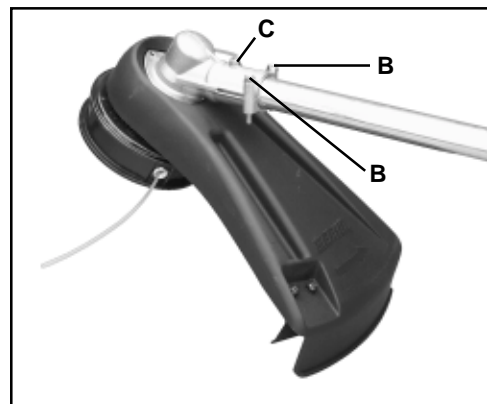

## NYLON LINE REPLACEMENT

### Level 1.

*Tools required:* Head locking tool (if head is to be removed)

*Parts Required:* ECHO 0.095" Nylon Trimmer Line 12m (40 ft.) long.

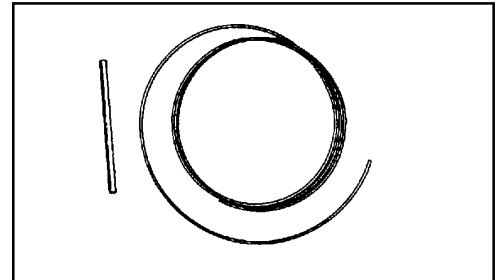

1. Hold drum (A) and turn spool (B) CW (clockwise) until it stops. Pull spool from drum. DO NOT push in on spool when turning.

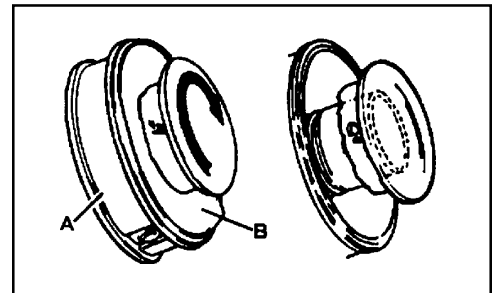

2. Use one piece of new nylon line (C) 12m (40 ft.) long and thread through the molded loop (D) on the spool. Pull line tight and adjust so one end is 15 cm (6 in.) longer than the other.

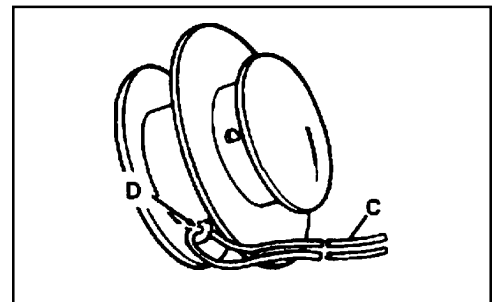

3. Hold the spool, opening toward you. Place index finger between the two strands and wind line, tightly and evenly, in direction of arrow marked "CC".
4. Stop when approximately 15-20 cm (6-8 in.) line (C) remains and place ends of line in notches (E) in spool (B).

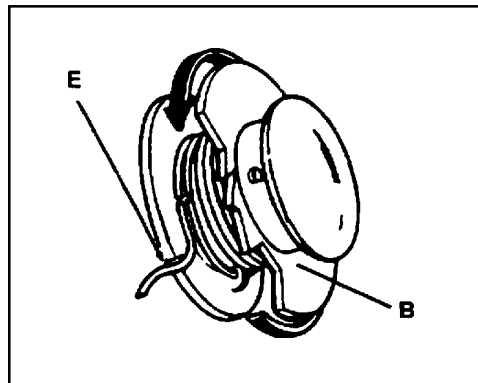

5. Feed ends of line through housing eyelets (F) and place spool (B) over drive (G). Align pegs (H) on drive with notches in spool and push spool into drum.
6. Pull on both lines until they come free from notches (E) in spool.

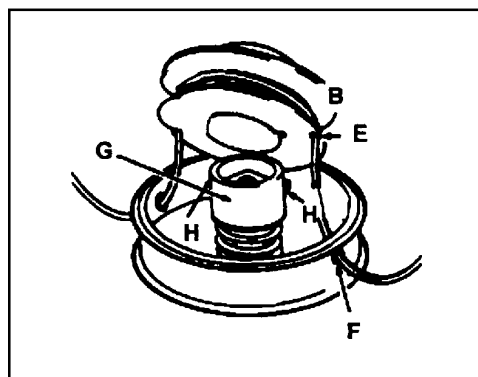

7. Hold drum (A) firmly and turn spool (B) CCW (counterclockwise) until it stops. DO NOT push in on spool when turning.
8. Pull both lines out and trim to cut-off knife length.

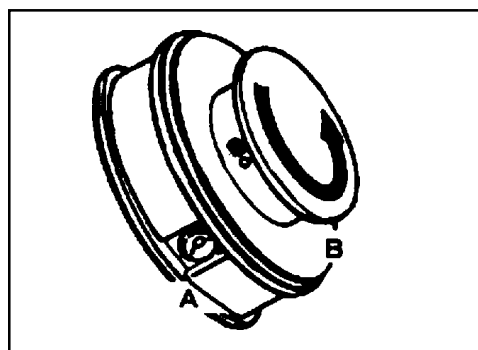

## SHARPENING METAL BLADES

Three styles of metal blades are approved for use on the ECHO Brush Cutter. The 8-tooth blade can be sharpened during normal maintenance. The clearing blade and 80 tooth blade require professional service.

Before sharpening, CLOSELY inspect blade for cracks (look at the bottom of each tooth and the center mounting hole closely), missing teeth and bending. If ANY of these problems are discovered, replace the blade.

When sharpening a blade, always remove the same amount of materials from each tooth to maintain balance. A blade that is not balanced will cause unsafe handling due to vibration and can result in blade failure.

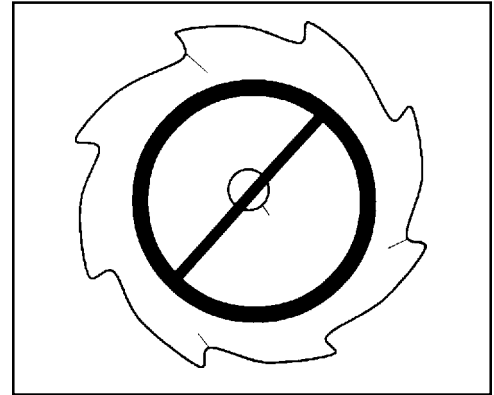

### ***8-tooth Blade***

*Tools required:* Flat file (preferred), Electric grinder if special care is used, Round (rat tail) file for gullet (radius).

1. File each tooth at a 30 degree angle a specific number of times, eg. 4 strokes per tooth. Work your way around the blade until all teeth are sharp.
2. DO NOT file the 'gullet' (radius) of the tooth with the flat file. The radius must remain. A sharp corner will lead to a crack and blade failure.

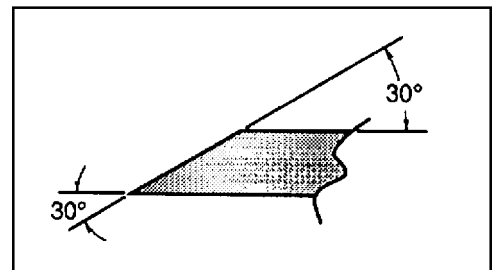

#### **IMPORTANT**

If an electric grinder is used, use care not to overheat teeth, do not allow tips/tooth to glow red or turn blue. DO NOT place blade in cooling water. This will change the temper of the blade and could result in blade failure.

3. After sharpening teeth, check each tooth radius for evidence of a square (sharp) corner. Use the round (rat tail) file to renew the radius.

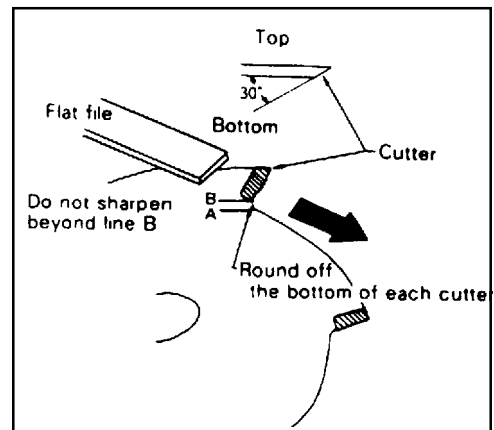

## TROUBLESHOOTING

Problem				
Engine -- starts hard				
Engine -- does not start			Cause	Remedy
Engine Cranks	Fuel at carburetor	No fuel at carburetor	Fuel strainer clogged Fuel line clogged Carburetor	Clean Clean See your ECHO dealer
	↓			
	Fuel at cylinder	No fuel at cylinder	Carburetor	See your ECHO dealer
	↓			
		Muffler wet with fuel	Fuel Mixture is too rich	Open choke Clean/replace air filter Adjust carburetor See your ECHO dealer
	↓			
	Spark at end of plug wire	No spark at end of plug wire	Stop switch off Electrical problem Interlock switch	Turn switch on See your ECHO dealer See your ECHO dealer
	↓			
	Spark at plug	No spark at plug	Spark gap incorrect Covered with carbon Fouled with fuel Spark plug defective	Adjust 0.65mm (0.026in.) Clean or replace Clean or replace Replace plug
	↓			
Engine does not crank			Internal engine problem	See your ECHO dealer
Engine runs	Dies or accelerates poorly		Air filter dirty Fuel filter dirty Fuel vent plugged Spark plug Carburetor Cooling system plugged Spark arrestor screen plugged	Clean or replace Replace Replace Clean and adjust/replace Adjust Clean Clean

### WARNING DANGER

Fuel vapors are **extremely** flammable and may cause fire and/or explosion. **Never** test for ignition spark near an open spark plug opening, otherwise serious personal injury may result.

## STORAGE

### *Long Term Storage (over 30 days)*

**WARNING**  **DANGER**

During operation the muffler or catalytic muffler and surrounding cover become hot. Always keep exhaust area clear of flammable debris during transportation or when storing, otherwise serious property damage or personal injury may result.

Do not store your unit for a prolonged period of time (30 days or longer) without performing protective storage maintenance which includes the following:

1. Store unit in a dry, dust free place, out of the reach of children.

**WARNING**  **DANGER**

Do not store in enclosure where fuel fumes may accumulate or reach an open flame or spark.

2. Place the stop switch (A) in the "OFF" position.
3. Remove accumulation of grease, oil, dirt and debris from exterior of unit.
4. Perform all periodic lubrication and services that are required.
5. Tighten all the screws and nuts.
6. **Drain** the fuel tank **completely** and pull the recoil starter handle several times to remove fuel from the carburetor.
7. Remove the spark plug and pour 7 cc (1/4 oz.) (1/2 tablespoon) of fresh, clean, two-stroke engine oil into the cylinder through the spark plug hole.
  - A. Place a clean cloth over the spark plug hole.
  - B. Pull the recoil starter handle 2-3 times to distribute the oil inside the engine.
  - C. Observe the piston location through the spark plug hole. Pull the recoil starter handle slowly until the piston reaches the top of its travel and leave it there.
8. Install the spark plug (do not connect ignition cable).

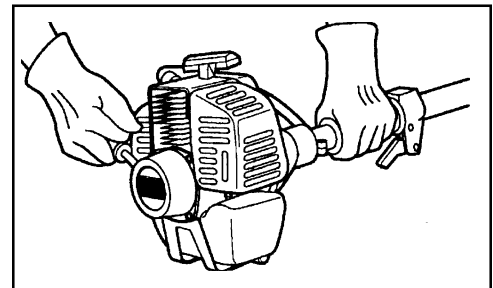
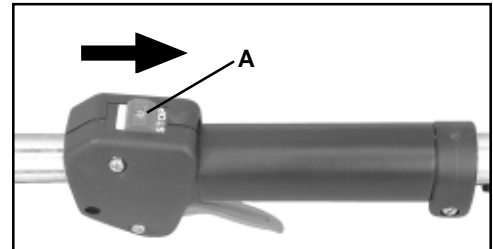

# SERVICING INFORMATION

## PARTS

Genuine ECHO Parts and ECHO REPOWER™ Parts and Assemblies for your ECHO products are available only from an Authorized ECHO Dealer. When you do need to buy parts **always** have the Model Number and Serial Number of the unit with you. You can find these numbers on the engine housing. For future reference, write them in the space provided below.

Model No. \_\_\_\_\_ SN. \_\_\_\_\_

## SERVICE

Service of this product during the warranty period must be performed by an Authorized ECHO Service Dealer. For the name and address of the Authorized ECHO Service Dealer nearest you, ask your retailer or call: 1-800-432-ECHO. When presenting your unit for Warranty service/repairs, proof of purchase is required.

## ECHO CONSUMER PRODUCT SUPPORT

If you require assistance or have questions concerning the application, operation or maintenance of this product you may call the ECHO Consumer Product Support Department at 1-800-673-1558 from 8:00 am to 5:00 pm (Central Standard Time) Monday through Friday. Before calling, please know the model and serial number of your unit to help your Consumer Product Support Representative.

## WARRANTY CARD

This card is our means of registering all original owners of ECHO equipment. The card plus proof of purchase provides you the assurance that authorized warranty work will be done. It also provides a direct link between you and ECHO if we find it necessary to contact you.

## ADDITIONAL OR REPLACEMENT MANUALS

**Safety Manuals** are available, free of charge, from your ECHO dealer or by contacting Echo Incorporated, 400 Oakwood Road, Lake Zurich, IL 60047

**Operator's and Parts Manuals** are available for purchase from your ECHO dealer or directly from ECHO. [See ordering instructions at the end of this manual.]

**Safety Video** is available from your dealer. A \$5.00 shipping charge will be required.

## ORDERING INSTRUCTIONS

To obtain a Parts Catalog or Operator's Manual send a check or money order for \$2.00 per Parts Catalog or \$1.50 per Operator's Manual made payable to ECHO, INCORPORATED. State on a sheet of paper model number and serial number of the ECHO unit you have, part number of the manual (if known), your name and address and mail to address above.

### Available Parts Lists

SRM-211/211U S/N 002001001 & J  
PART NUMBER 99922203252

**ECHO**  
ECHO, INCORPORATED  
400 OAKWOOD ROAD  
LAKE ZURICH, IL 60047

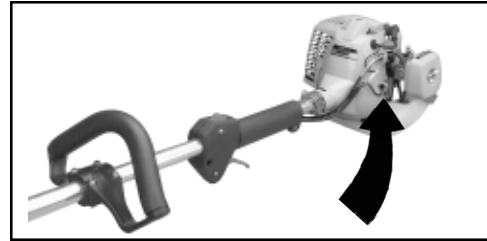

## DEALER?

Call

1-800-432-ECHO

1-800-432-3246

## CONSUMER PRODUCT SUPPORT

1-800-673-1558

8 - 5 Mon - Fri C.S.T.

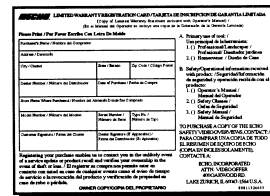

ECHO Incorporated  
400 Oakwood Road  
Lake Zurich, IL 60047  
Technical Publications Orders





## SUPPLEMENT TO OPERATOR'S MANUAL

\* Some Echo units may be factory pre-assembled. The nylon line head, plastic debris shield, and mounting hardware shown in the contents list are pre-assembled to the unit. No assembly tools are needed. The front handle may need to be re-positioned for comfortable operation.

### GT CONTENT LIST

- \* \_ - Rapid Loader™ 2-line Head
- \* \_ - Shield Assembly
- \* \_ - Line Head Mount Hardware
- \* \_ - 1, 3/8-24 Locknut
- \* \_ - 1, Small Washer
- \* \_ - 1, Large Washer
- \* \_ - 12, 8 in. x .080 Pre-cut Nylon Line
- \* \_ - 1, Locking Tools, P/N 89751801131

### SRM CONTENT LIST

- \* \_\_\_ - 1, Nylon Trimmer Head
- \* \_\_\_ - 1, wrench 17x19, P/N 89541008030
- \* \_\_\_ - 1, locking tool, P/N 89751801131
- \* \_\_\_ - --1, Plastic shield
- \* \_\_\_ - --1, shield plate
- \* \_\_\_ - --3, 5mm x 15mm screws (shield mtg.)

## SUPLEMENTO DEL MANUAL DEL OPERADOR

\* Algunas unidades pueden venir ya montadas de fábrica. La cabeza del hilo de nilón, proyector de plástico contra residuos y la tornillería de montaje, mostrados en la lista del contenido, vienen ya montados en la unidad. No se necesita ninguna herramienta de montaje. Tal vez sea necesario volver a ubicar solamente la empuñadura delantera para facilitar la operación.

### LISTA DE CONTENIDO DE GT

- \* \_ - Cabeza Rapid Loader™ de 1 hilo
- \* \_ - Conjunto de protector
- \* \_ - Tornillería de montaje de la cabeza de línea
- \* \_ - 1, tuerca de traba de 3/8-24
- \* \_ - 1, arandela pequeña
- \* \_ - 1, arandela grande
- \* \_ - 12, hilo de nilón precortado de 8 pulg. x 0,080
- \* \_ - 1, herramientas de traba, P/N 89751801131

### LISTA DE CONTENIDO DE SRM

- \* \_\_\_ - 1, cabeza recortadora de nilón
- \* \_\_\_ - 1, llave 17x19, N/P 89541008030
- \* \_\_\_ - 1, herramienta de traba, N/P 89751801131
- \* \_\_\_ - --1, protector de plástico
- \* \_\_\_ - --1, placa protectora
- \* \_\_\_ - --3, tornillos de 5 mm x 15 mm (de montaje del protector)

## SUPLÉMENT AU MANUEL DE L'OPÉRATEUR

\* Certains modèles sont assemblés en usine. La tête de coupe à ligne nylon, le pare-débris en plastique et la boulonnerie de montage illustrée dans la liste des pièces sont installés sur l'outil. Aucun outil d'assemblage n'est requis. Il peut toutefois être nécessaire d'ajuster la poignée avant pour assurer le confort d'utilisation.

### LISTE DU CONTENU - GT

- \* \_\_\_ - Tête 2 lignes Rapid Loader™
- \* \_\_\_ - Pare-débris
- \* \_\_\_ - Boulonnerie de montage de la tête à ligne
- \* \_\_\_ - Écrou de blocage de 3/8-24
- \* \_\_\_ - 1 petite rondelle
- \* \_\_\_ - 1 grosse rondelle
- \* \_\_\_ - 12 lignes nylon précoupées de 8 x 0,080 po
- \* \_\_\_ - 1, outils de blocage réf. 89751801131

### LISTE DU CONTENU - SRM

- \* \_\_\_ - 1 tête de coupe à ligne nylon
- \* \_\_\_ - (1) joints, réf. 89541008030
- \* \_\_\_ - 1 outil de blocage, réf. 89751801131
- \* \_\_\_ - --1 pare-débris en plastique
- \* \_\_\_ - --1 plaque de pare-débris
- \* \_\_\_ - --3 vis 5 mm x 15 mm (pare-débris)

SUP22203624

99922203624  
09/02



**SUPPLEMENT TO OPERATOR'S MANUAL  
PART NUMBER X7702272400 (X770000180)  
FOR MODELS: SRM-211/U S/N 02001101 & UP  
SUPLEMENTO DEL MANUAL DEL OPERADOR  
NUMERO DE PIEZA 7702272400 (X770000180)  
PARA LOS MODELO: SRM-211/U S/N 02001101&UP**

*The updated emissions information for your unit is:*

**EMISSION CONTROL**

**California Tier 2**

The emission control system for these engines are EM/TWC  
(Engine Modification with Catalyst).

**NOTE**

Every unit is run at the factory and the carburetor is set in compliance with current Emission Regulations.

**IMPORTANT ENGINE INFORMATION**

ENGINE FAMILY: 2EHXS.0214KA DISPLACEMENT: 21.2 cc  
EMISSION COMPLIANCE PERIOD : 300 HRS.  
THIS ENGINE MEETS U.S. EPA PH 2 AND 2000 AND LATER CALIFORNIA  
EMISSION REGULATIONS FOR S.O.R.E. REFER TO OWNER'S MANUAL FOR  
MAINTENANCE SPECIFICATIONS AND ADJUSTMENTS.



**KIORTZ CORP.**



(This is an EXAMPLE ONLY, information on label varies by engine family).

*La información correcta de las emisiones para su unidad es:*

**CONTROL DE EMISIONES**

**California Tier 2**

El sistema de control de emisiones para este motor es EM/TWC  
(modificación y catalizador del motor).

**NOTA**

Todas las unidades se hacen funcionar en fábrica y el carburador se ajusta en cumplimiento con las regulaciones de emisiones.

**INFORMACIÓN IMPORTANTE SOBRE EL MOTOR**

FAMILIA DE MOTORES: 2EHXS.0214KA CILINDRADA: 21.2 cc  
PERIODO DE LA CONFORMIDAD PARA LA EMISIONES : 300 HORAS.  
ESTE MOTOR CUMPLE CON LAS NORMAS DE LA FASE 2 DE LA  
EPA DE EE.UU. Y REGULACIONES DE EMISIONES DE CALIFORNIA POSTERIORES  
PARA S.O.R.E. CONSULTE EN EL MANUAL DEL  
PROPIETARIO LAS ESPECIFICACIONES Y AJUSTES DE  
MANTENIMIENTO.



**KIORTZ CORP.**



(Éste es un EJEMPLO SOLAMENTE, la información de la etiqueta varía por FAMILIA de motores).

## Free Manuals Download Website

<http://myh66.com>

<http://usermanuals.us>

<http://www.somanuals.com>

<http://www.4manuals.cc>

<http://www.manual-lib.com>

<http://www.404manual.com>

<http://www.luxmanual.com>

<http://aubethermostatmanual.com>

Golf course search by state

<http://golfingnear.com>

Email search by domain

<http://emailbydomain.com>

Auto manuals search

<http://auto.somanuals.com>

TV manuals search

<http://tv.somanuals.com>